



This is a digital copy of a book that was preserved for generations on library shelves before it was carefully scanned by Google as part of a project to make the world's books discoverable online.

It has survived long enough for the copyright to expire and the book to enter the public domain. A public domain book is one that was never subject to copyright or whose legal copyright term has expired. Whether a book is in the public domain may vary country to country. Public domain books are our gateways to the past, representing a wealth of history, culture and knowledge that's often difficult to discover.

Marks, notations and other marginalia present in the original volume will appear in this file - a reminder of this book's long journey from the publisher to a library and finally to you.

### **Usage guidelines**

Google is proud to partner with libraries to digitize public domain materials and make them widely accessible. Public domain books belong to the public and we are merely their custodians. Nevertheless, this work is expensive, so in order to keep providing this resource, we have taken steps to prevent abuse by commercial parties, including placing technical restrictions on automated querying.

We also ask that you:

- + *Make non-commercial use of the files* We designed Google Book Search for use by individuals, and we request that you use these files for personal, non-commercial purposes.
- + *Refrain from automated querying* Do not send automated queries of any sort to Google's system: If you are conducting research on machine translation, optical character recognition or other areas where access to a large amount of text is helpful, please contact us. We encourage the use of public domain materials for these purposes and may be able to help.
- + *Maintain attribution* The Google "watermark" you see on each file is essential for informing people about this project and helping them find additional materials through Google Book Search. Please do not remove it.
- + *Keep it legal* Whatever your use, remember that you are responsible for ensuring that what you are doing is legal. Do not assume that just because we believe a book is in the public domain for users in the United States, that the work is also in the public domain for users in other countries. Whether a book is still in copyright varies from country to country, and we can't offer guidance on whether any specific use of any specific book is allowed. Please do not assume that a book's appearance in Google Book Search means it can be used in any manner anywhere in the world. Copyright infringement liability can be quite severe.

### **About Google Book Search**

Google's mission is to organize the world's information and to make it universally accessible and useful. Google Book Search helps readers discover the world's books while helping authors and publishers reach new audiences. You can search through the full text of this book on the web at <http://books.google.com/>

NEDL TRANSFER



HN 52KW D

KH 80

**Harvard College Library**

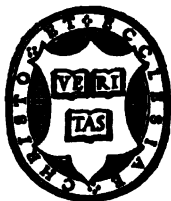

FROM THE LIBRARY OF

**JAMES HARDY ROPES**

*Class of 1889*

**HOLLIS PROFESSOR OF DIVINITY**

**1910-1933**

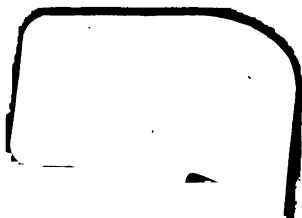







KH80

**Harvard College Library**



**FROM THE LIBRARY OF**

**JAMES HARDY ROPES**

*Class of 1889*

**HOLLIS PROFESSOR OF DIVINITY**

**1910-1988**

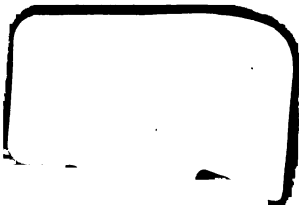





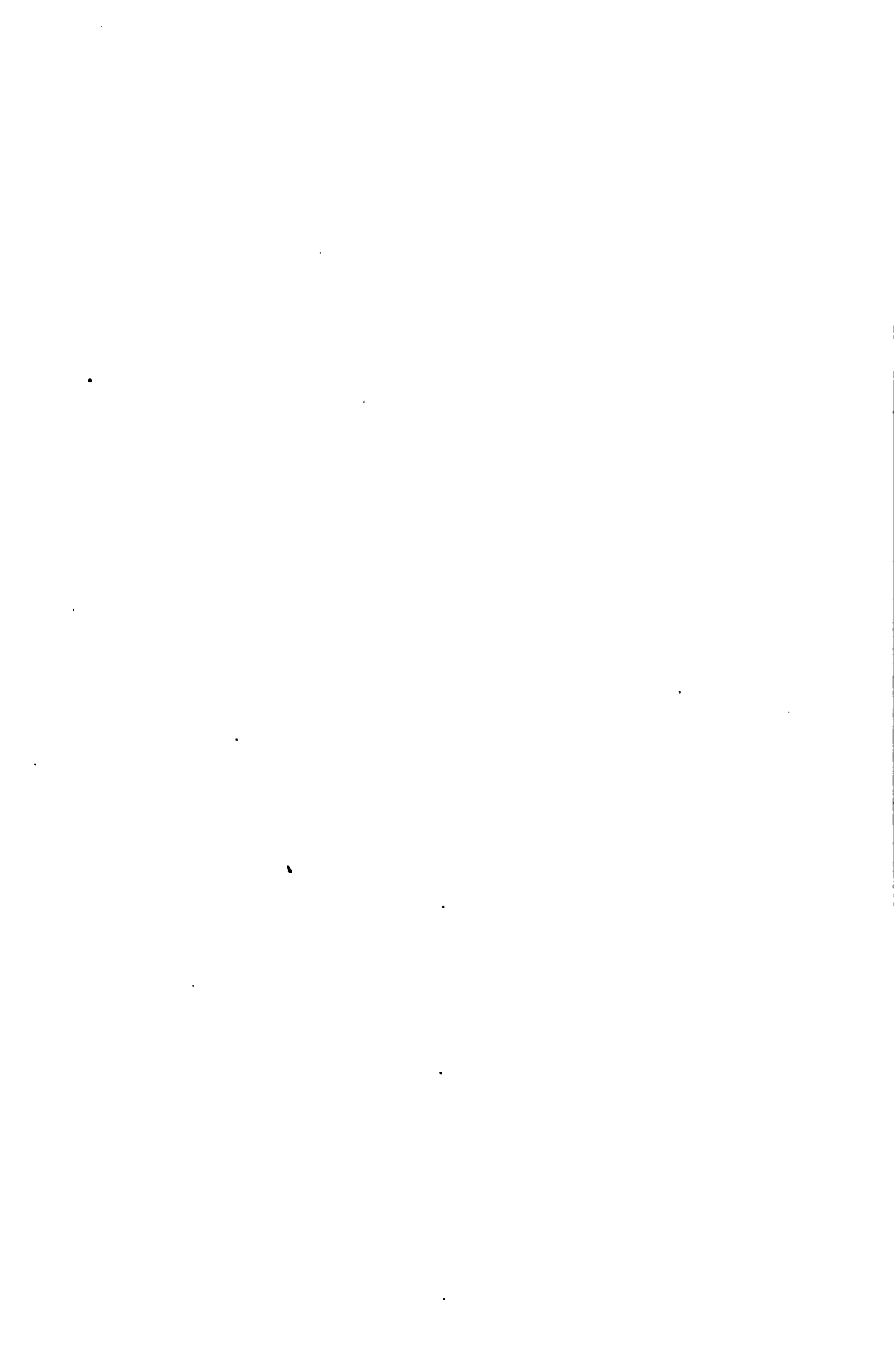





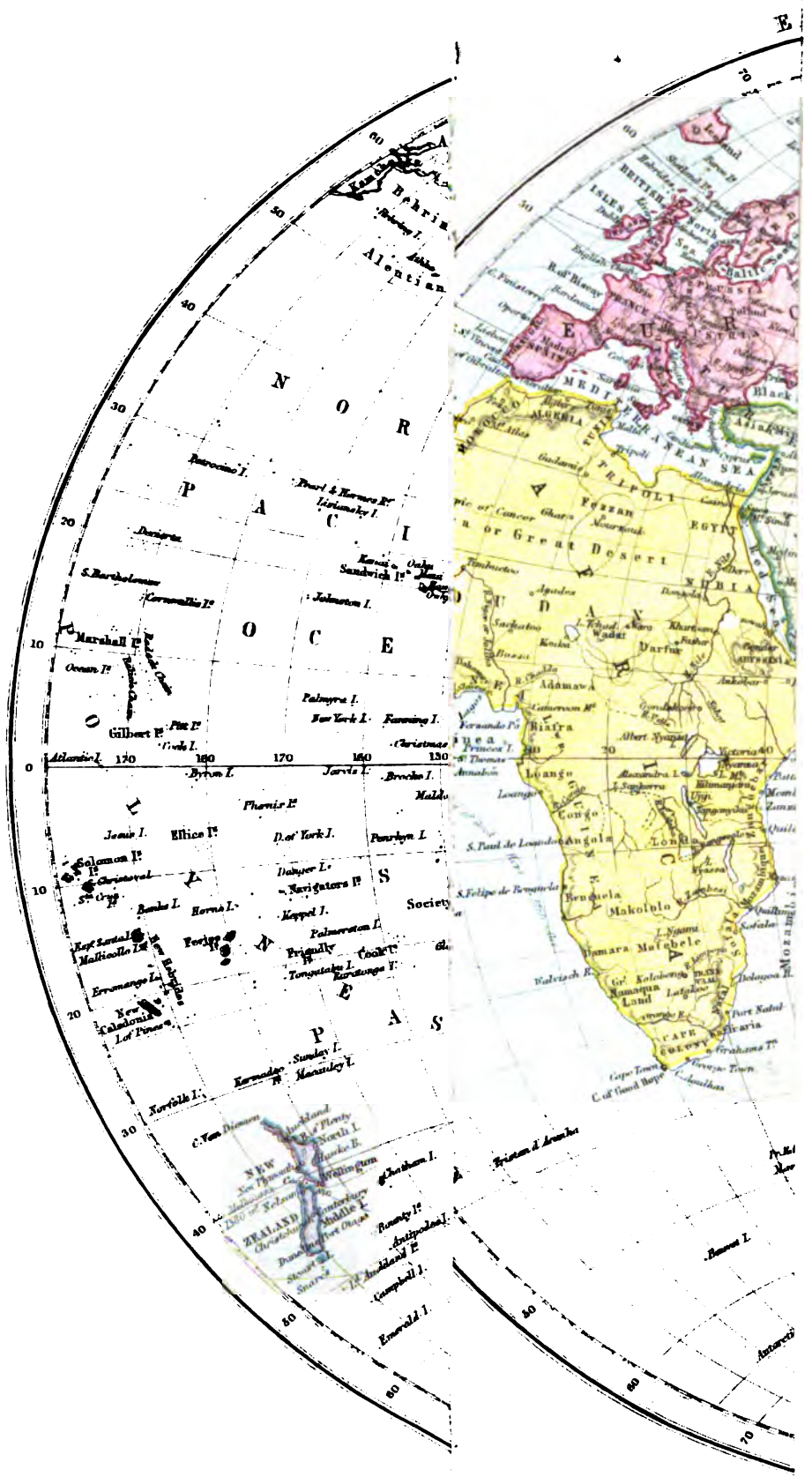

# EASTERN HEMISPHERE



CHAMBERS'S  
ENCYCLOPÆDIA

A DICTIONARY

OF UNIVERSAL KNOWLEDGE FOR THE PEOPLE

ILLUSTRATED

WITH MAPS AND NUMEROUS WOOD ENGRAVINGS

REVISED EDITION

VOL. X



LONDON

W. AND R. CHAMBERS 47 PATERNOSTER ROW  
AND HIGH STREET EDINBURGH

1878

*All Rights are reserved*

Cyc 350.6  
✓

HARVARD COLLEGE LIBRARY  
FROM THE LIBRARY OF  
PROF. JAMES HARDY ROPES  
MARCH 14, 1934

3

LIST OF MAPS FOR VOL. X

---

	PAGE
THE WORLD (FRONTISPIECE).	
WEST INDIA ISLANDS, . . . . .	145
ITALIA ANTIQUA, . . . . .	578

4v 243  
6-5-33

## CONCLUDING NOTICE.

THE design of this work, as explained in the Notice prefixed to the first volume, is that of a **DICTIONARY OF UNIVERSAL KNOWLEDGE FOR THE PEOPLE**—not a mere collection of elaborate treatises in alphabetic order, but a work to be readily consulted as a **DICTIONARY** on every subject on which people generally require some distinct information—no article being longer than was absolutely necessary. Commenced in 1859, the work is now brought to a close in 1868, and the Editors confidently point to the Ten volumes of which it is composed, as forming the most **COMPREHENSIVE**—as it certainly is the **CHEAPEST**—**ENCYCLOPÆDIA** ever issued in the United Kingdom.

The original plan, as exemplified in the first volume, has been strictly adhered to throughout; and if, as the work proceeded, there has been any change in the method or quality of the execution, it may at least be affirmed that the change has not been for the worse. After some experience, it became easier to find the person specially qualified to write a particular kind of article, and thus the circle of contributors became widened, and the distribution of the work more specialised. It was also seen to be desirable, in regard to certain classes of subjects, to admit a rather ampler selection of heads. This has been effected without increasing the scale of the work, not so much by less full treatment of the subjects, as by increased care in condensing the statements and omitting everything superfluous.

It will be observed that in the earlier volumes there are fewer notices of *places* than in the later. These and other deficiencies in the Geographical department, have, as far as possible, been remedied in the **SUPPLEMENT**; so that the **ENCYCLOPÆDIA** forms a complete Gazetteer. The minuteness of a special geographical dictionary is, of course, not to be expected: with regard to towns, for instance, it may be well to state, in order to prevent disappointment, that, as a rule, no place with a population under 3000 in the United Kingdom, or under 5000 in other parts of the world, need be looked for under its own name, unless it be historically or otherwise noteworthy. But towns, rivers, &c. of secondary importance mentioned anywhere in the work find a place in the Index, and thus a clue is given to some information regarding them, were it only their whereabouts on the map.

In like manner, in the department of Biography, the limited scale of the work made it necessary to exclude many names which would be deserving of record in an exhaustive biographical dictionary. The intention has been to include only the more prominent actors and thinkers, dead and living, especially such as have attained extensive celebrity. The difficulty of making such a selection is known only to those who have tried it; and the Editors were prepared to have the judiciousness of their choice frequently questioned. In settling relative claims to distinction, the judgment depends much on the special pursuits or sphere of thought of the judge. Of the omitted names to which attention has been kindly called by correspondents, several have, on reconsideration, been introduced into the **SUPPLEMENT**.



Natural History has been copiously treated. Without any attempt at embracing a complete exhibition of the three kingdoms of nature, the aim has been to give some account of every class of objects having a general interest, more especially such as are in any way of use in the economy of life.

The articles descriptive of the structure and functions of the human body have been selected and treated mainly with a view to illustrate the laws of health. The subject of Health and Disease has received more attention relatively than is usual in such works; and the articles of this class will form a pretty complete Dictionary of Domestic Medicine. How important it is that some knowledge on these matters should be widely diffused, is becoming more and more recognised. The directions given in regard to treatment are chiefly meant for those cases of sudden illness or injury where lay practice is necessitated by the absence of professional assistance. But prevention is better than cure; and the chief advantage of a generally diffused knowledge of the nature and causes of diseases is, that it teaches people how to avoid them. A review of what has been done in recent years for the preservation of the health of communities, is given at some length in the SUPPLEMENT, under the head of SANITARY SCIENCE.

Of the Sciences, the least adapted to encyclopædic treatment is Mathematics. All terms of common occurrence, however, have been introduced, and a brief exposition of the subjects given, so far as could be done in an elementary way.

Natural Philosophy has received ample attention, and all the leading doctrines and facts of general interest will be found under their appropriate heads, treated in a popular way and divested as far as possible of the technicalities of mathematics.

Chemistry, some knowledge of which is becoming daily more indispensable in all departments of life, receives a comparatively large space. Prominence has been given to those points of the subject that have either a direct practical bearing or a special scientific interest. During the progress of the work, several changes in the nomenclature and notation of the science have come into general use; but it was thought better to preserve uniformity in the use of terms and symbols to the end, and to give an account of the changes in the SUPPLEMENT.

A distinctive feature of this ENCYCLOPÆDIA, it is believed, will be found to lie in the number of articles devoted to religious beliefs and speculative opinions, and in the way in which these topics are handled. The principle followed has been, not to pronounce an opinion for or against a particular doctrine, but to give a true and unprejudiced account of it. To do this, however, in regard to matters of still living controversy, on which almost every one has more or less of a personal feeling, is next to impossible; and therefore the plan has been adopted of giving the opposing views, wherever it was practicable, as stated by their respective adherents. Thus, the articles on the doctrines and rites of the Roman Catholic Church are written by a Roman Catholic scholar; the Unitarian scheme of doctrine by a Unitarian; and the Secularists have been allowed to state their own case. In carrying out this principle, it has sometimes been necessary to employ two writers on one article. The account of the REFORMATION, for instance, is naturally written by a Protestant; but our conception of the movement is not complete until we know

how the same events are looked upon by intelligent adherents of the Church of Rome; and accordingly, a paragraph is added written from the Roman Catholic point of view. Similarly, in the article BISHOP, the Episcopal and Presbyterian theories of the origin and nature of that office are from different pens. The principle of getting an account of a system or doctrine from a believer in it has not been confined to religion; it has been acted on in regard to HOMŒOPATHY, HYDROPATHY, and many other subjects. The Editors feel confident that in thus securing the most favourable representation of both sides of a controversy, they were doing the best in their power for the ultimate prevalence of the truth. We are not in a position to judge rightly between two opinions until we know exactly what they are; and this we can do only by having both before us in the light in which they appear to those that hold them.

The great world of thought of the East, with its hundreds of millions of subtle intellects and prolific imaginations, has remained hitherto almost a sealed book in the West, except to a few oriental scholars. Yet the British public might be expected to feel some interest in inquiring what kind of thoughts and fancies actuate the vast multitudes of their fellow-subjects in Hindustan—what gods they worship, and with what rites; what things seem good to them, and what evil; how, in short, they interpret the riddle of this world, and the part they play in it. The means of gratifying this curiosity is now made more generally accessible than it has heretofore been, by the numerous articles, drawn from original sources, on the religious and philosophic systems of India. (See the articles INDIA, section on *Religion*; PURÂN'A, VEDA, VISHNU, VEDÂNTA, TRANSMIGRATION, BUDDHISM, LAMAISM, NIRVÂNA, &c.) Attention is also called to the original articles on Mohammedanism, and on its various schools, sects, and heresies (see MOHAMMEDANISM, KORAN, SUNNA, SHIITES, and others in the ENCYCLOPÆDIA proper, and particularly the articles MOHAMMEDAN SECTS, MOTAZALITES, ISMAILIS, SINCERE BROTHERS, &c. in the SUPPLEMENT). The reader who has been accustomed to think of the Old Testament Scriptures as the whole of Hebrew literature, will be able, from the articles on the TALMUD, HAGGADA, HALAOKA, ESSENES, and others, to form some notion of the rich treasures of Jewish thought and learning that lie buried in the Talmudic writings and have only recently begun to attract attention.

True to its projected plan as a DICTIONARY OF UNIVERSAL KNOWLEDGE FOR THE PEOPLE, CHAMBERS'S ENCYCLOPÆDIA will be found to be especially rich in notices of miscellaneous matters. Some of the subjects introduced might perhaps be considered beneath the dignity of a book aspiring to a more severely scientific character; but all of them are, if not instructive, at least curious or entertaining, and likely to occur in the course of reading or conversation. During the progress of the work, the Editors have received numerous assurances from parents how highly it was prized, even though only partly issued, in households with young people at school, as a repertory of the kind of things they are constantly in search of and often puzzling their elders about. This use of the ENCYCLOPÆDIA has been steadily kept in view; and it is gratifying to learn that it is found efficiently to serve the purpose intended. The numerous wood-cuts and maps will, it is hoped, enhance its value in this respect.

To meet the more important of the changes that have taken place since the publication of the ENCYCLOPÆDIA began, as well as to remedy some deficiencies, a SUPPLEMENT

of 409 pages has been added. It consists of: (1) Subjects that have only recently risen into importance, or that had been overlooked; (2) Subjects already noticed in the body of the work, but which have since undergone important changes, or, from other causes, seemed to require to be treated anew.

In the introductory Notice, it was stated that the plan of the work was contrived with a special view to render it *easy of consultation*. This end will be still further served by the INDEX of subordinate subjects at the end of this volume. Prefixed to the Index is a paragraph explaining its nature and use.

That in a work extending to 8320 pages, and consisting of upwards of 27,000 distinct articles, in the production of which more than a hundred writers have taken greater or less part—that in such a work, notwithstanding all vigilance to the contrary, there should be not a few oversights, errors, and inconsistencies, is a matter of course. Yet, in spite of such inevitable blemishes, the Editors feel confident that, in substantial accuracy and trustworthiness, this ENCYCLOPÆDIA will bear comparison with any book of the kind. To the numerous correspondents who have favoured them by pointing out faults, or making other suggestions, they beg leave, once for all, to return their best thanks for the uniform courtesy with which their criticisms have been offered. Some of the complaints of omission have been attended to in the SUPPLEMENT; others proceeded on mistaken ideas as to what the ENCYCLOPÆDIA was intended for.

A list of the chief Contributors is given on a subsequent page. To this able staff, to whose special knowledge of their subjects the ENCYCLOPÆDIA owes its chief value, the Editors have to express their acknowledgments, and to thank them for the patience with which they have submitted to the limits as to space and other trammels incident to the nature of the publication, which often rendered the satisfactory treatment of their subjects extremely difficult. The list does not include the numerous friends to whom the Editors are indebted for single contributions on local or other matters coming within their personal knowledge.

Finally, it is right that the public should recognise, in ANDREW FINDLATER, LL.D., the ACTING EDITOR, who has borne the great burden of the immediate superintendence of this work during its progress from beginning to end. Where a man of learning has given ten years of his life to a task which confessedly he has performed with skill, taste, and unflagging perseverance, it seems to the Editors that, in simple justice to him, his name should be made honourably and gratefully known.

EDINBURGH, April 1868.

W. & R. CHAMBERS.

*Postscript.*—Since the foregoing Notice was written in 1868, CHAMBERS'S ENCYCLOPÆDIA has undergone various revisions, to meet the more important changes that have taken place. In the present re-issue, so many have been the alterations, that it is virtually a *New Edition*—the whole effected under the immediate care of Dr FINDLATER, to whom the Editors have again to express their obligations.

EDINBURGH, November 1874.

W. & R. CHAMBERS.

### CONTINUED REVISION.

The process of revising CHAMBERS'S ENCYCLOPÆDIA is constantly carried on, thus keeping up the information to the latest possible date.

## LIST OF CONTRIBUTORS.

---

- PATRICK P. ALEXANDER, A.M.,** Edinburgh.  
**WM. ANDERSON** (the late), Edinburgh.  
**THOMAS C. ARCHER, F.R.S.E., F.B.S.E., F.R.S.S.A.,**  
 Director of the Edinburgh Museum of Science  
 and Art; Corresponding Member of the Scien-  
 tific Committee of Crown Domains of Russia;  
 &c. &c.  
**ALEXANDER BAIN, M.A.,** Professor of Logic in the  
 University of Aberdeen.  
**GEORGE BARCLAY, Barrister-at-Law,** London.  
**B. BAYLIS, C.E.,** Rotherham.  
**ALEXANDER MELVILLE BELL, F.E.L.S.,** Lecturer on  
 Elocution in University College, London.  
**JAMES G. BERTRAM,** Edinburgh.  
**J. ARTHUR BINNS,** Manningham, Bradford.  
**SAMUEL BIRCH, LL.D.,** Keeper of Egyptian and  
 Oriental Antiquities, British Museum; Corre-  
 sponding Member of the Institute of France,  
 &c.  
**JOHN STUART BLACKIE, F.R.S.E.,** Professor of  
 Greek in the University of Edinburgh.  
**W. A. F. BROWNE, Commissioner in Lunacy,**  
 Edinburgh.  
**A. H. BRYCE, LL.D., D.C.L., F.R.S.E.,** Rector of the  
 Edinburgh Collegiate School.  
**ALEXANDER BUCHAN, M.A.,** Secretary of the  
 Scottish Meteorological Society.  
**GEORGE BULLEN, Assistant-keeper of the Printed**  
**Books, and Superintendent of the Reading-**  
**room, British Museum.**  
**GEORGE BURNETT, Advocate,** Lyon King of Arms.  
**J. H. BURTON, LL.D.,** Historiographer Royal for  
 Scotland.  
**DAVID BUXTON, F.R.S.L.,** Principal of the School  
 for the Deaf and Dumb, Liverpool.  
**R. CAMPBELL, Barrister-at-Law,** London.  
**JAMES CARMICHAEL, Classical Master,** Edinburgh  
 Academy.  
**ROBERT CARRUTHERS, Inverness.**  
**WILLIAM CARRUTHERS, F.L.S., F.G.S.,** Botanical  
 Department, British Museum.  
**W. DYCE CAY, Assoc. Inst. C.E.,** Resident  
 Engineer, Aberdeen Harbour.  
**WM. CHAMBERS, F.R.S.E., &c.**  
**ROBT. CHAMBERS, LL.D., F.R.S.E., &c.**  
**ROBT. CHAMBERS, Jun.,** Edinburgh.  
**JAMES COWIE, Sundridge Hall,** Bromley, Kent.  
**The Rev. J. MASON COX, M.A.,** Vicar of Bishop's  
 Tawton, Devon, and Prebendary of Exeter.  
**ROBERT COX, F.S.A. Scot.,** Edinburgh.
- ALEXANDER CRUICKSHANK, A.M.,** Aberdeen.  
**GEORGE E. DAY, M.A., Cant., M.D., F.R.S.,** late  
 Professor of Medicine in the University of St  
 Andrews.  
**EMANUEL DEUTSCH, British Museum.**  
**GEORGE DODD, London.**  
**C. HOME DOUGLAS, Edinburgh.**  
**FINLAY DUN, Weston Park, Shipston-on-Stour.**  
**REV. W. J. EDLIN, M.A.,** Chaplain of Trinity  
 College, Cambridge.  
**A. M. EDWARDS, M.R.C.S. Eng., F.R.S.E., &c.,** late  
 Demonstrator of Anat., University, Edinburgh.  
**THOMAS ELLISON, Liverpool.**  
**ROBERT M. FERGUSON, Ph.D., F.R.S.E.,** Edinburgh.  
**FRANCIS FRANCIS, Twickenham.**  
**WILLIAM T. GAIRDNER, M.D.,** Professor of Practice  
 of Medicine, University of Glasgow.  
**ALEXANDER GALLETLY, Curator, Industrial Museum,**  
 Edinburgh.  
**PROFESSOR JOHN GAMGEE, Albert Veterinary**  
**College, London.**  
**THEODOR GOLDSTÜCKER, Ph.D.,** Professor of Sanscrit  
 in University College, London.  
**GEORGE GRUB, LL.D.,** Professor-substitute of Law  
 in the University of Aberdeen.  
**SAMUEL HALKETT, Keeper of the Advocates'**  
**Library, Edinburgh.**  
**HENRY HALL, F.R.G.S.,** War Dep. Surveyor,  
 Portsmouth.  
**DAVID HAMILTON** (the late), Edinburgh.  
**B. G. JOHNS, M.A.,** Chaplain of the Blind School, St  
 George's Fields, London.  
**A. KEITH JOHNSTON, LL.D., F.R.S.E.,** Geographer  
 to the Queen for Scotland.  
**W. B. JOHNSTONE, R.S.A.,** Principal Curator and  
 Keeper of the National Gallery of Scotland.  
**HENRY JONES, Jun. ('Cavendish'),** London.  
**J. KEMPE, M.A.,** Fellow of Exeter College, Oxford.  
**MRS J. KNOX.**  
**HENRY H. LANCASTER, Advocate, B.A., Balliol**  
**College, Oxford.**  
**SIMON S. LAURIE, A.M.,** Secretary to the Education  
 Committee of the Church of Scotland.  
**E. LEMMI, Advocate, LL.D. of the University of**  
**Pisa.**  
**JOHN H. VAN LENNEP, Zeyst, Netherlands.**  
**JAMES LESLIE, C.E.,** Edinburgh.  
**HERBERT C. LLOYD, London.**  
**JAMES LORIMER, A.M.,** Professor of Public Law in  
 the University of Edinburgh.

- STEVENSON MACADAM, Ph.D., F.R.S.E., F.C.S.,  
Lecturer on Chemistry, Surgeons' Hall, Edinburgh.
- DAVID MACGIBBON, Architect, Edinburgh.
- REV. DR MACGOWAN, Missionary, China.
- The REV. J. M'ILRAITH, Minister of the English  
Reformed Church, Amsterdam.
- D. M'LENNAN, M.A., Barrister-at-Law, Inner  
Temple, London.
- J. F. M'LENNAN, M.A., F.R.S.E., Advocate, Edinburgh.
- JAMES MARTIN, London.
- WILLIAM MENZIES, Deputy-surveyor of Windsor  
Parks and Forests, &c.
- REV. JOHN MONTGOMERY, A.M., Edinburgh.
- PROFESSOR J. MURRAY, Kingston, Canada.
- T. L. NICHOLS, M.D., American Journalist, London.
- SIR CHARLES NICHOLSON, Bart., D.C.L., LL.D., late  
Chancellor of the University of Sydney, New  
South Wales.
- JAMES NICOL, F.R.S.E., F.G.S., Professor of Natural  
History in the University of Aberdeen.
- ELISE C. OTTÉ.
- JAMES PATERSON, A.M., Barrister-at-Law, London.
- JAMES PAYN, London.
- ALEXANDER PEDDIE, M.D., F.R.C.P.E., F.R.S.E.,  
Edinburgh.
- WILLIAM PENKELLY, F.R.S., F.G.S., Torquay.
- G. CROOM ROBERTSON, A.M., Professor of Phi-  
losophy of Mind and Logic, University College,  
London.
- JOSEPH ROBERTSON, late Curator of the Historical  
Department, General Register House, Edinburgh.
- DENHAM ROBINSON, H.M. War Office.
- REV. T. P. ROSSETTI, Turin.
- ROBERT RUSSELL, F.R.S.E., Pilmuir, Fifeshire.
- EDWARD SANG, F.R.S.E., Edinburgh.
- WILLIAM THOMAS SHAW, London.
- W. W. SHORE, M.A., Oxon.
- ALEXANDER SMITH (the late), Edinburgh.
- H. AMBROSE SMITH, F.L.A., London.
- J. CAMPBELL SMITH, M.A., Advocate, Edinburgh.
- MRS L. C. SMITH, Keswick.
- JAMES P. STEELE, B.A., M.D., *Lancet* Office, London.
- THOMAS STEVENSON, F.R.S.E., M.I.C.E., Civil  
Engineer.
- ROBERT STUART, Barrister-at-Law, Q.C.
- P. G. TAIT, M.A., late Fellow of St Peter's College,  
Cambridge, Professor of Natural Philosophy in  
the University of Edinburgh.
- ADAM THOM, LL.D.
- R. W. THOMSON, C.E., F.R.S.E., Edinburgh.
- D. TIMIRIAZEF, St Petersburg.
- JOHN TULLOCH, D.D., Principal of St Mary's  
College in the University of St Andrews.
- N. VAN DER VLIET, St Petersburg.
- EDWARD WALFORD, M.A., late Scholar of Balliol  
College, Oxford.
- JOHN WAITS, Ph.D., Manchester.
- H. WEIR, M.A., Cantab., Classical Master, Edin-  
burgh Academy.
- WILLIAM WESTGARTH, London (late of Melbourne,  
Victoria).
- WALTER WHITE, Assistant-secretary Royal Society,  
London.
- W. MATTHEU WILLIAMS, F.C.S., Chemist to 'The  
Atlas Iron and Steel Works,' Sheffield.
- JOHN DOVE WILSON, Advocate, Sheriff-substitute  
of Kincardineshire.
- CHRISTOPHER TATCHELL WINTER, Cheltenham.
- T. STRETHILL WRIGHT, M.D., F.R.C.P.E.

ANDREW FINDLATER, A.M., LL.D., Edinburgh, *Acting Editor*.

JOHN M. ROSS, A.M., now of the High School, Edinburgh, *Assistant Editor*.

Other literary gentlemen connected for longer or shorter time with the  
regular staff of the *Encyclopædia*—

ALEX. NICOLSON, A.M., Advocate, Edinburgh.

J. U. HILLHOUSE, A.M., Mathematical Tutor, Edinburgh University.

J. ROSS.

DAVID M. SMITH.

JOHN S. KELTIE.

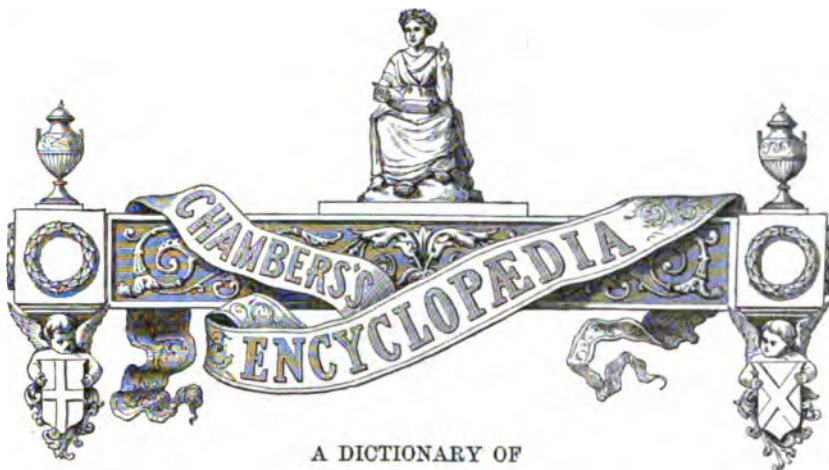

A DICTIONARY OF

## UNIVERSAL KNOWLEDGE FOR THE PEOPLE

### VITAL STATISTICS.

**VITAL STATISTICS.** The annual Reports of the Registrars-general for England and Scotland (see REGISTRATION) form a valuable storehouse of information on the various subjects connected with vital statistics. Besides detailed abstracts for each year of births, marriages, and deaths, tables of the fatal diseases, classified in combination with ages, are given, and comments upon the salient points of the year's registration accompany the whole. The number of births, marriages, and deaths varies with the state of trade, price of food, and the seasons, and thus furnishes a test of the condition of a nation. We shall notice separately each of these three divisions of vital statistics.

1. *Births.*—From the 34th Report of the Registrar-general for England, it appears that the number of children born alive and registered during the year 1871 was 797,428, the population for the middle of that year being estimated at 22,782,812; the birth-rate being thus 35 per 1000 to the population. The proportion of the sexes was 104 boys to 100 girls. It is found on an average of ten years (1861—1871) that Cornwall, North Wales, Northumberland, Cumberland, Rutland, and Northampton have the largest proportion of male births; Hereford and Huntingdon the smallest. The proportion of male children is greater in the illegitimate than in the legitimate births. The registered percentage of illegitimate to the total births in 1871 was 5.6. Twenty years ago, the illegitimate were nearly 7 per cent. of the total births; in the ten years 1851—1860, the average was 6.5 per cent.; in the following ten years, 6.1 per cent. 'I have no ground for supposing,' says the Registrar-general, 'that the general diminution in the illegitimate birth-rate is caused by any increase in the omissions to register; on the contrary, I think that, as in those elements of registration which we have the means of accurately observing, undoubted progress in the direction of greater completeness has taken place, it is fair to assume with respect to the registration of illegitimate births, that at any rate no more of them are lost sight of

now than in former years.' The birth-rate is usually highest in the first three months of the year; taking the mean of each of the quarterly rates during 34 years, the average annual births to 1000 persons living were 35.4 in the March, 35.1 in the June, 32.5 in the September, and 32.3 in the December quarters.

The direct cause of the increase of population in any country (apart from immigration) is, of course, the excess of births over deaths, and this will plainly depend on the following causes: (1.) on the prolificness of marriages; (2.) on the proportion born which lives to marry; and (3.) on the interval between the mean age of marriage and the mean age of death. All these conditions must be favourable to shew the full power of increase in action. They have never yet, on any large scale at least, been found operating with maximum force. In the United States, we find a combination of the first two; but from the 'expectation of life' (see LIFE, MEAN DURATION OF) not being favourable in that country, it follows that the third cause is not in favourable operation.

2. *Marriages.*—It would seem to be contrary to the principles of human nature that early marriages should be united to longevity. Youthful marriages arise where the chances of the acquisition of wealth in youth are favourable; and when these are favourable the fact seems to tell against longevity. One of the most interesting and useful points of view in which registers can be considered is the evidence which they give of the varying prevalence of the prudential check to marriage and population in different countries and places. The prudential check will shew itself in two ways—either by the proportion of marriageable persons who are not married, or by the lateness of the average age of marrying. On the supposition of the natural prolificness of women remaining at the same point, the birth-rate will indicate the extent of prudential check in whichever of the two ways it may manifest itself. Suppose that from any cause the prudential restraint on marriage were to become weaker among any

## VITAL STATISTICS.

people than it had hitherto been, while the means of maintenance remained the same, what would happen? A corresponding increase would immediately take place in the annual mortality, and the mean duration of life would be correspondingly reduced. And there can be no doubt that the premature mortality which prevails all over the world is mainly owing to imprudent marriages. The death of one half of the human race under the age of puberty does not take place in virtue of any law of man's constitution, but from a disregard of the

admonitions of its laws. Those who have the means of obedience under the conditions of civilised life generally greatly err; yet not so greatly, for the most part, as to be fatal to infant life. It is the want of means, in other words, imprudent marriages, which is the main cause. The following table is taken from an article 'On the Statistics of Marriages among the Families of the Peerage,' by Archibald Day, Esq. (*Assurance Magazine*, No. 48). The results as regards the peerage families are based on the data of a century to December 31, 1855:

PROPORTION PER CENT. OF MARRIAGES.

Age.	Peerage Families.	England (S. Brown.)		Belgium.	Massachusetts.	Poorer Classes (St George's-in-the-East.)	Peerage Families.	1027 Peers (Sadler.)
	First and Subsequent Marriages.	1846-1848.	1851-1853.	1841-1845.	25 Years, to January 1857.	Statistical Society's Journal.	First Marriages only.	First Marriages only.
Under 30, . . . . .	53.08	76.77	75.62	52.75	75.01	85.00	65.97	62.81
30 to 45, . . . . .	33.98	18.31	19.22	39.93	19.54	14.06	31.43	27.75
45 to 60, . . . . .	9.50	4.03	4.25	6.05	4.12	.94	2.40	7.88
60 and upwards, . . . . .	3.44	.89	.91	1.27	1.33	0.00	0.00	1.56
	100.00	100.00	100.00	100.00	100.00	100.00	100.00	100.00

In the above, column 1 shews the average rate of marriage at the given ages in the families of the peerage. Thus, of 100 persons married, it will, on an average, be found that 53.08 are under 30 years of age; and so on. Columns 2 and 3 give the same results for all England, as deduced by Mr S. Brown (see his paper in the *Assurance Magazine*, vol. vii.). Column 4 is from M. Quetelet's observations in Belgium. Column 6 from a Report of the committee of the Statistical Society upon the poorer inhabitants of St George's-in-the-East in 1845. Column 8 was compiled by Mr Sadler, and will be found in the second volume of his work on the Law of Population. From the 34th Report of the Registrar-general for England, it appears that in 1871, in England, the number of persons married was 380,224, being 16,914 more than in the previous year, and 26,284 more than in 1869. In the 34 years, 1838-1871, the mean annual ratio of persons married was 1.65 per cent; in 1871, the rate was 1.67 per cent. In the five years 1841-1845, nearly 92 per cent. of the marriages registered were solemnised according to the rites of the Established Church; in the five years 1866-1870, the proportion was 77 per cent.; and in 1871 it was 76 per cent. On the other hand, marriages in the Superintendent Registrars' office requiring no religious ceremony whatever, have steadily increased from 2.3 per cent. of the total in 1841-1845 to 8.9 per cent. in 1866-1870, and to 9.7 per cent. in 1871. The mean age at marriage or remarriage in 1871 was for the men 27.9 years, and for the women 25.7 years. Curious instances are found in the tables of widowers of 60 and 70 marrying maidens of 15 and 19, of a bachelor of 75 wedding a spinster of 21, and of a bachelor of 21 marrying a spinster of 70. At 70 and upwards, 238 men and 32 women entered or re-entered into the married state.

3. *Deaths.*—The number of deaths registered in England in 1871 was 514,879, of which 265,563, or 51.6 per cent, were males, and 249,316, or 48.4 per cent., were females. From the census returns of 1871, the male mortality rate in the first five years of life is shewn to have been 71.7 per 1000, the female 62.4; at ages five and under ten, these rates were respectively 8.3 and 7.5; at ten to fifteen, when the rates are at their lowest, the male is 4.4, the female 4.5 per 1000; at 15 to 25, the rates are nearly equal, being 7.7 and 7.4; from 25 years of

age, both male and female rates increase to the end of life, male being invariably the highest. With regard to cases of reputed centenarianism, the Registrar-general points out that while many are recorded, he has as a general rule 'no alternative but to tell the tale as it is told to him;' but he notices a case, that of Jacob William Luning, whose death in 1870, at the age of 103, was proved to his, the Registrar-general's satisfaction, by documentary evidence. He adds that it is noteworthy that the experience of life assurance societies in this country gives but one example of an insured life completing its hundredth year, and that is the one of Luning. Nearly 13 millions of the population of England live in what are called the town districts, and the death-rate among these in 1871 was 25 per 1000, somewhat above the annual average; among the remaining ten millions, inhabiting the villages and rural districts, the rate was 19.5, being somewhat below the average. 'For general purposes,' says the report, 'this comparison may be taken as giving a fair idea of the relative advantages, as regards the duration of life, which a residence in the country confers over one in town; bearing in mind, of course, that there are special causes of unhealthiness in some country-places, and that the towns themselves have a wide range of death-rate.'

When any year is especially healthful, the fact tells most in favour of female life. The highest mortality rate during the 25 years 1838-1862, both male and female, occurs in the cholera year 1849, the second highest in the famine year 1847, and the third highest in the cholera year 1854. For the three years 1854-1856, it will be found that the mean male mortality is almost exactly that of the 25 years given, while the female rate is actually slightly (.006 per cent.) less. With regard, then, to the cholera visitation of 1854 at least, it may be held that the victims must have been generally those of diseased or debilitated constitution, who, had there been no cholera, would in course of the next year or so have died from some other cause. It is a curious fact in the experience of assurance offices, that while female annuitants are longer lived than male, female assured lives are no better. This fact doubtless arises from the critical periods incident to female life, and to the selection exercised by the public against the offices.

In 1871, the Scotch marriage rate was 14.2 per

VITAL STATISTICS.

1000, the birth-rate 34.5, and the death-rate 22.2; the marriage-rate was nearly 2.5 per 1000 below that of England, the birth-rates were almost identical, and the death-rate was 4 per 1000 lower in Scotland. The registered rates of persons married, of birth, and of death in Ireland in 1871, were 10.7, 28.1, and 16.5 per 1000 respectively—'these rates,' says the report, 'differ so widely from those of England and Scotland as to shew either that registration in Ireland is extremely defective, or that the constitution or the circumstances of the population is altogether different from that of Great Britain.'

In vol. viii. (for 1860) of the *Assurance Magazine* will be found an interesting paper, by Mr Samuel Brown, F.S.S., 'On Mortality amongst American Assured Lives.' We extract the following table, showing the

AGE.	'EXPECTATION OF LIFE,' ACCORDING TO			
	Mutual Life of New York, Fifteen Years.	'Actuaries,' or Seventeen English Companies.	Massachusetts (1842) Tables. (Edwards.)	Farr's English, No. 1.
20	42.6	41.5	39.9	39.9
30	36	34.4	34	33.1
40	28.9	27.3	27.9	26.6
50	21.6	20.2	21.3	20
60	14.6	13.8	15	13.6
70	8.6	8.5	9.4	8.5

See also, on the subject of American mortality, the *Report of the Mutual Life Assurance Company of New York, for Fifteen Years ending February 1, 1855* (New York, November 1859).

*Influence of Occupation.*—The interesting question of the influence of different trades, occupations, and habits of life on health and mortality, will be found ably treated in Mr A. G. Finlaison's *Report on*

*Friendly Societies*, with accompanying tables and returns, printed by order of the House of Commons, August 16, 1853; in Mr Neison's work on *Vital Statistics* (Lond. 1853); and in Mr H. Ratcliffe's *Observation of Rate of Mortality and Sickness existing among Friendly Societies* (Manchester, 1850). From Mr Finlaison, we give the following table, showing the

AGE.	MORTALITY PER CENT. AMONG						
	Mariners.	Colliers.	Met. Miners.	Painters.	Feltes.	Railway Servants.	England and Wales.
20	.86	1.11	.65	..	1.09	..	.74
25	1.71	.77	1.76	1.55	.57	.58	.71
30	1.69	.84	.81	.88	1.25	1.18	.77
35	2.26	1.67	1.02	.87	1.77	1.00	.83
40	1.79	.96	.39	2.04	2.05	1.86	1.03
45	2.71	1.09	2.00	2.09	.68	1.63	1.21
50	2.48	1.70	1.84	2.87	6.35	1.74	1.50
60	2.79	2.96	2.61	6.06	..	3.50	2.61

Among the mariners, a strong contrast is found to prevail between the sickness and mortality rates, the former being low while the latter is high. The same fact is found among painters. 'The practical difference in the distribution of sickness,' says Mr Finlaison, 'seems to turn upon the amount of the expenditure of physical force. This is no new thing, for in all ages the enervation and decrepitude of the bodily frame has been observed to follow a prodigal waste of the mental or corporeal energies. But it has been nowhere previously established upon recorded experience that the quantum of sickness annually falling to the lot of man is in direct proportion to the demands upon his muscular power. So it would seem to be, however.'—*Report*, p. 211.

The following is from Mr Finlaison's *Digest of Returns*:

GENERAL AVERAGES.

	Number returned as sick out of each 100 persons liable to sickness.	Average Sickness per annum to each Person, expressed in Days.	Average Sickness per annum to each Person sick, expressed in Days.	Mortality per Cent.	Withdrawals and Exclusions per Cent.
Light labour without exposure to weather, . . . . .	21.58	9.5489	44.2483	1.42	2.97
Light labour with exposure to weather, . . . . .	20.80	8.5288	41.0063	1.37	2.82
Heavy labour without exposure to weather, . . . . .	26.54	10.8122	40.7349	1.38	3.08
Heavy labour with exposure to weather, . . . . .	23.04	10.6537	37.9960	1.07	3.02
England and Wales, . . . . .	24.99	10.1155	40.4809	1.26	3.00

In Mr Neison's work will be found a valuable chapter on the rates of mortality among persons of intemperate habits. The following shews the period of years which there is an equal chance of living among the

Age.	General Population of England and Wales.	Persons of Intemperate Habits.	
20	44.212	15.557, being 35 percent.	} of the duration of life in the general population.
30	36.432	13.800, " 38 "	
40	28.790	11.637, " 40 "	
50	21.255	10.860, " 51 "	
60	14.285	8.947, " 63 "	

The average duration of life, after the commencement of intemperate habits, Mr Neison finds to be—among beer-drinkers, 21.7 years; spirit-drinkers, 16.7 years; indiscriminate, 16.1 years. Hence it appears that distilled liquors are more hurtful than fermented, but that both combined are worse than either taken separately.

The following table, from Mr Ratcliffe's work, shews the 'expectation' at decennial periods of life, for England and Wales, Manchester Unity Order of Odd Fellows, and various trades:

England and Wales—Rural, Town, and City; and various Trades.	AGE.				
	20	30	40	50	60
England and Wales, . . . . .	39.88	33.13	26.56	20.02	13.59
Manchester Unity, . . . . .	40.92	33.70	26.41	19.40	13.29
Bakers, . . . . .	41.92	34.05	26.58	20.09	14.13
Blacksmiths, . . . . .	37.96	30.34	23.59	18.11	12.02
Bricklayers, . . . . .	37.70	29.66	22.23	14.78	8.44
Butchers, . . . . .	41.60	33.49	26.33	20.32	14.69
Carpenters, . . . . .	43.23	38.47	31.66	26.07	18.88
Clerks, . . . . .	34.99	27.77	20.61	14.18	12.11
Coopers, . . . . .	38.43	31.17	24.22	18.22	13.23
Dyers, . . . . .	39.89	32.60	24.73	18.20	13.40
Hatters, . . . . .	38.91	34.29	27.93	19.67	13.89
Labourers (Town and City), (Rural), . . . . .	40.67	33.65	26.27	19.07	13.23
Millwrights, . . . . .	45.32	37.71	29.91	22.18	16.82
Mill Operatives, . . . . .	40.32	32.38	27.37	19.60	13.49
Miners, . . . . .	38.09	30.45	22.61	15.55	10.61
Plumbers, . . . . .	38.22	31.56	24.26	17.62	12.27
Potters, . . . . .	36.59	31.59	24.67	18.24	12.67
Printers, . . . . .	36.59	30.51	23.60	18.74	12.71
Sawyers, . . . . .	36.66	28.51	20.52	14.67	13.04
Servants, Domestic, . . . . .	40.02	33.06	26.05	18.04	13.11
Shoemakers, . . . . .	43.03	34.30	27.33	20.77	14.61
Spinners, . . . . .	40.67	33.99	26.23	19.04	13.05
Stone-masons, . . . . .	39.04	32.42	24.83	16.62	12.21
Tailors, . . . . .	38.19	30.41	24.16	18.15	14.79
Weavers, . . . . .	39.40	32.51	25.24	18.21	10.22
Wheelwrights, . . . . .	41.92	33.55	25.53	22.01	15.61
Wool-combers, . . . . .	40.87	33.67	27.64	19.41	12.84
	38.56	33.73	26.26	17.64	12.22



## VITAL STATISTICS.

It thus appears that at the early period of life, age 20, the following trades, placed according to their expectation, shew an inferior expectation in comparison with the general results of rural, town, and city districts combined: Clerks, potters, letterpress printers, bricklayers, blacksmiths, mill operatives, plumbers, stone-masons, miners, wool-combers, coopers, hatters, spinners, tailors, dyers, sawyers, millwrights, town and city labourers, and shoemakers. The following trades shew a superior expectation: wheelwrights, butchers, bakers, weavers, domestic servants, carpenters, and rural labourers.

At the last period given in the table, bricklayers, tailors, mill operatives, printers, clerks, spinners, miners, plumbers, hatters, blacksmiths, shoemakers, wool-combers, coopers, and sawyers shew an inferior expectation; and dyers, town labourers, millwrights, potters, wheelwrights, bakers, stone-masons, domestic servants, butchers, weavers, rural labourers, and carpenters, shew a superior expectation, in comparison with the general results.

The comparative healthiness of various occupations among the lower ranks in London is given by Dr Letheby for the years 1855—1856; and another view of the healthiness or unhealthiness of industrial occupations as regards England generally, is given by Dr Farr from the mortality of males at and above the age of 20 following different industrial occupations, in 1851, as compared with the number of persons enumerated in them at the census of that year. While the general annual rate of mortality in England, in 1851, of 1000 males at and above the age of 20, was 20, that of farmers was 28; shoemakers, 18; weavers, 17; grocers, 11; blacksmiths, 18; carpenters, 19; tailors, 19; labourers, 21; miners, 15; bakers, 17; butchers, 21; innkeepers, 30. Taking into account the ages at death, the farmers were the longest lived. Labourers, who form nearly a fourth of the males of England, had a general mortality almost the same as that of the general population, but a very high mortality at great ages. At any one decade of life, the mortality of inn and beer-shop keepers exceeds that of all the other classes, except the butchers, at age 55—65. The mortality of butchers was much heavier than that of any other class, except that of innkeepers, under the age of 65; this fact is supposed to be owing to intemperance, slaughter-house effluvia, and the use of too much animal and too little vegetable food. All occupations have their peculiar dangers which counter-balance each other; thus the tailor is not exposed to the explosions so fatal to the miner, and the labourer has exercise denied to the tailor.

The mortality in the army and navy during peace and war shews many interesting points. Statistics tell us, that soldiers, though picked men, living in costly barracks in Britain during peace, are nearly as unhealthy as the people of our unhealthiest cities, and sometimes almost twice as unhealthy. The mortality at all ages in the army at home is almost double that of civilians, ages being alike. Lung diseases and cholera are twice as fatal to soldiers as to civilians. This excessive mortality in the army seems owing to overcrowded and ill-ventilated barracks and military hospitals, sameness of diet, and want of healthy exercise. In 1871, the strength of the entire British army abroad as well as at home was 192,665, of whom 105,757 were serving in the United Kingdom, and the remaining 86,908 were distributed in different parts of the world. The deaths occurring in the year out of the above numbers were, 1005 at home, and 1322 abroad, making altogether 2327. Proportionately

to each 1000, there were at home 11·9 deaths of officers, and 9·4 of non-commissioned officers and men; abroad, 11·4 deaths of officers, and 15·4 of non-commissioned officers and men. The mean annual mortality of officers in the six years 1866—1871, was at the rate of 10·5 deaths per 1000 at home, and 12·6 abroad; among non-commissioned officers and men, the corresponding rates were 11·2 at home, and 18·3 abroad. Of the army at home, the mortality rate was considerably less among the 1216 officers stationed in Ireland than it was among the 3664 officers stationed in Great Britain. Of non-commissioned officers and men, 26,437 were stationed in Ireland, and their mortality rate was 8·5 per 1000, while it was 9·7 among the 74,440 stationed in Great Britain. 'As the condition of the mercantile marine,' says the Registrar-general, 'is just now engaging a good deal of public attention, it may be worth while to see how that service compares in point of mortality with the naval service, and the general home population of corresponding age.' The mean age, it appears, of the men afloat in the merchant service is about 28 years, while that of the men in Her Majesty's navy is about 26, so that there is really little difference in age between the two. Now the mortality among the English male population at age 28 is by the 'English Life Table' 9·7 per 1000; in the navy, the average annual rate of mortality in the period 1856—1872, was 14 per 1000; in the merchant service, from 1852—1871, it was 21 per 1000. The following table gives a comparison of the death-rate in the Royal Navy, and in the merchant service from disease and from accident:

	Deaths per 1000.	
	Royal Navy, Annual Average, 1856—1872.	Merchant Service, 1871.
From disease,	10-	6·8
From injury or accident (in- cluding drowning), . . .	4-	14·9
All causes, . . .	14-	21·7

Thus it appears that in the navy about two-thirds of the deaths are the result of disease, while in the merchant service two-thirds of the deaths are the results of causes other than disease. Among the home population, at the sailors' ages, the mortality from all kinds of violence does not exceed 1 per 1000. The dangers of the sea are now in the navy four times, and in the merchant service fifteen times as great as the dangers on land.

Mortality varies with density of population, place, and climate. It is a popular notion that a mild winter is most fatal to life, but the truth is the reverse. Either extreme cold or extreme heat immediately raises the mortality rate of Great Britain; the injurious effect of cold is in a great measure, however, confined to those whose circumstances do not enable them to protect themselves against it.

Some years ago, ten of the principal life-assurance offices of Scotland, with several of the leading English offices, contributed their experience down to 31st December 1863, as a basis of investigation into the mortality of assured lives. In England, the scheme was under a committee of the Institute of Actuaries; in Scotland, it was in charge of Mr James Meikle, actuary of the Scottish Provident Life Assurance Society. It has now been completed, and a valuable and elaborate work illustrative of its scope was published by Mr Meikle in 1872.

**VITEBSK**, a government in the north of West Russia, bounded on the N.-W. by Courland and Livonia, and on the N.-E. by the government of Pakov. Area, 17,425 sq. m.; pop. (1870) 888,727. The surface is, as a rule, hilly, though wooded plains, marshes, and lakes abound. The Dwina flows for 466 miles in this government; and by means of this river and its affluents, large quantities of timber are floated down to the port of Riga. The soil is not fertile, the quantity of cereals grown being generally insufficient for local consumption. Flax is successfully grown; and this material, together with timber, constitutes the chief articles of export. Ship-building is carried on on the Dwina; the lake-fisheries are profitable; and tanning is the most important branch of industry.

**VITEBSK**, a city of West Russia, capital of the government of the same name, on both banks of the Western Dwina, 389 miles south of St Petersburg. It covers a very large area, and contains many monasteries, churches, and synagogues. Manufactures are not extensive; and the trade—the chief articles of which are corn, flax, hemp, tobacco-leaves, sugar, and timber—is carried on by Jews, who form the larger section of the population. V. is connected by railway with Dunaburg and Smolensk. Pop. (1867) 28,944.

**VITELLIN**. This name was, until recently, given by chemists to a supposed protein body occurring in the yolk of egg. It has been discovered by Lehman that this substance is merely an admixture of casein and albumen.

**VITELLIUS, AULUS**, Roman emperor, son of Lucius Vitellius the prince of the sycophants who surrounded Caligula, but who, according to Tacitus, 'in his provincial administration exhibited the virtues of a former age,' was born September 24, 15 A. D., and through his father's influence at court, became consul, 48 A. D., and afterwards proconsul of Africa, where his administration gave great satisfaction. He had been a companion of Tiberius at Capree, and was equally a favourite with Caligula, Claudius, Nero, and Galba, the last of whom appointed him commander of the legions in Lower Germany, thinking his intense devotion to gastronomic pleasures would effectually prevent his becoming a rival. However, V. had not been a month in his new post, till he had completely gained the affections of his soldiers by extreme familiarity and liberality (strongly contrasting with Galba's parsimony); and on January 3, 69, they took him from his tent, and proclaimed him emperor. This decision was adopted by the rest of the troops in Gaul; and two armies, under Valens and Cæcina, immediately set out to secure Rome, V. following leisurely. A notice of his contest with Otho in Northern Italy will be found under OTHO. The adherents of his predecessor were leniently treated, with the exception of the centurions of Otho's army, who were put to death, an act which greatly offended his own supporters. V.'s journey to Rome was a curious specimen of a triumphant advance, the nominal conqueror being invariably muddled with liquor, and the soldiers of his army straggling about, committing excesses of all sorts with perfect impunity. At last he reached Rome, and without loss of time, proceeded, by right of his office as Pontifex Maximus, to deify Nero. The administration was mostly in the hands of the freedman Asiaticus, though P. Sabinus (brother of Vespasian), and the two generals who had gained for him the imperial dignity, were high in authority; and the government was marked by great moderation, for V. was too far sunk in the vilest debauchery to be capable of tyranny. But he was not long allowed

to disgust the respectable part of the citizens of Rome; for the legions of Pannonia and Illyricum, having proclaimed Vespasian emperor, advanced into Italy under Antonius Primus. They were opposed by the Vitellian troops, commanded by Cæcina, but through the treachery of the latter general, gained a decisive victory near Bedriacum, and another, on the following evening, over another Vitellian army which had marched to the support of the first. V., at this critical period of his fortunes, nothing abated his swinish indulgences; but his brother, Lucius, in the south, displayed more energy, and defeated Vespasian's partisans in several battles. Meantime, the soldiers, enraged at the treachery of P. Sabinus, and his allies among the senators and knights, stormed the Capitol, and slew Sabinus. From this time, Rome was a scene of unintermitting violence and bloodshed, till the troops of Primus entered the city. V. was found wandering about his palace in a state of stupid terror, and after being ignominiously exposed in the streets, was killed by repeated blows, his head carried about Rome, and his body thrown into the Tiber, in December 69 A. D.—For a complete sketch of his private life, see Tacitus's *Historia*, ii., iii., and Dion Cassius, 65; see also Suetonius, *Vit. Duodec. Cæs.*

**VITELLUS OVI**, or the *yolk* of the egg of the domestic fowl, is employed in pharmacy for the purpose of administering substances insoluble in water (the oils and resins, for example) in the form of emulsions. The *white* is employed as an antidote, in cases of poisoning by corrosive sublimate or with salts of copper. As a dietetic article in the sick-room, eggs, either lightly boiled or poached, or as ingredients of puddings, are invaluable; the stomach, after an acute disease, being often able to digest an egg, when any more solid article of animal food would set up gastric irritation.

The article **EGG, CHEMISTRY OF**, requires a few supplementary remarks. The albumen, occurring in the *white*, is for the most part in combination with soda; in addition to this principal ingredient, the white contains fats (chiefly margaric), grape-sugar (averaging 5 per cent. of the dried residue), and soluble salts, in which the chlorides preponderate, with a little silica (for the formation of feathers) and fluorine. The yolk consists of casein (forming 14 per cent.), albumen (about 3 per cent.), fats, some of which contain phosphorus (about 30 per cent.), a little grape-sugar, and mineral constituents (about 1.5 per cent.), in which there is a great preponderance of potassium compounds and phosphates. Of the pigments of the yolk we only know that there is both a yellow and red pigment, and that one at least of them contains iron. It is difficult to conceive a more concentrated form of nourishment than a food thus composed of casein, albumen, fat, sugar, potassium salts, phosphates, and iron; and its resemblance in composition to milk is very remarkable.

The shell of the egg consists almost solely of carbonate of lime (about 97 per cent.), with a little phosphate of lime, and traces of magnesia and organic matter. The variety of colour in the eggs of different birds is supposed to be due to certain modifications of bile-pigment with which they come in contact in the cloaca.

**VITERBO**, a city of Central Italy, in the province of Rome, stands amid gardens and vineyards, at the foot of Monte Cincino, 42 miles north-north-west of Rome. Its well-built streets are paved with marble, and there are numerous elegant fountains. Its Gothic cathedral contains the tombs of several popes, and is memorable as the scene where Guy de Montfort

## VITEX—VITRIFIED FORTS.

assassinated Prince Henry, brother of Henry III. of England. Among other attractive buildings are the churches, mostly rich in works of art, the bishop's palace, and the city halls. There are many monuments of antiquity in and around the city. Alum, vitriol, and sulphur abound in the neighbourhood, and exquisite wines are produced. No important manufactures are carried on. Pop. (1871) 16,326.

**VITEX**, a genus of trees or shrubs of the natural order *Verbenaceæ*, the fruit a drupe, with a 4-celled stone. *V. Agnus castus*, the **CHASTE TREE**, a native of the countries around the Mediterranean, is downy, with digitate leaves white on the back, and has an acrid fruit, the seeds of which are used in



Chaste Tree (*Vitex Agnus castus*).

Smyrna as an external application in cases of colic. It derives its name from the practice of Grecian matrons to strew their couches with its leaves, especially during the sacred rites of Ceres, in order to banish impure thoughts; for which purpose a syrup, made of its fruit, was also, and perhaps still is, used in convents in the south of Europe, although, in reality, it possesses stimulating properties.—*V. Negundo*, an Indian species, has aromatic leaves, which are bruised and applied to the temples for relief of headache.—*V. trifolia* is another Indian species, whose leaves are a powerful discutient.

**VITILIGO** was the name given by Celsus to some kind of cutaneous eruption which cannot be clearly identified. The term has, in recent times, been used by different writers in different senses, but is now most commonly employed to designate cutaneous patches characterised by loss of pigment.

**VITIOUS INTROMISSION**, in the Law of Scotland, means the unwarrantable interference and management of the movable estate of a deceased person. The consequence is, to make the intruder liable for all the debts of the deceased person, though far exceeding the value of the assets. The mode of putting an end to this liability is to obtain confirmation as executor in the usual way.

**VITORIA**, a pleasant, gay, and thriving inland town in the north of Spain, capital of the province of Alava, stands on a gentle elevation, 70 miles west of Pamplona. The old town, the Villa Suso,

consists of dark and tortuous streets; the new town is regularly laid out. There are several charming *alamedas*, or public walks, especially La Florida and El Prado. The Plaza Nueva, a square of 220 feet, was built in 1791, and under its arcades is the favourite promenade in winter. Brass and iron wares, earthenware, candles, and linen goods, are manufactured, and a brisk general trade is carried on with towns further inland. The plain surrounding the town is extensive and fruitful. The climate is temperate and healthy. Pop. 18,700.

V. will be ever memorable for the decisive and important victory which Wellington gained here over the French under Joseph Bonaparte and Jourdan, June 21, 1813. The numbers in this encounter were nearly equal. The French lost 6000 killed and wounded, 150 cannon, together with baggage, eagles, and an amount of booty in pictures, &c., which amounted to 5,000,000 dollars. The direct result of the battle of Vitoria was, that the French had to retire from Spain. About this engagement, Southey says the French 'were beaten before the town, in the town, through the town, out of the town, behind the town, and all about the town.' The loss of the British, Portuguese, and Spaniards was 4900 men.

**VITRÉ**, an ancient town of Brittany, France, in the dep. of Ille-et-Vilaine, on the left bank of the Vilaine, 24 miles east of Rennes by railway. It is a curious specimen of the old towns of the middle ages, and is still surrounded with Gothic ramparts flanked with towers. At three miles' distance is the Château des Rochers, the celebrated residence of Madame de Sévigné. Manufactures of cloth and hats are carried on. Pop. (1872) 6901.

**VITRIFIED FORTS**, the name given to certain remarkable stone enclosures bearing traces of the action of fire, about fifty of which exist in various parts of Scotland. They are generally situated on a small hill, overlooking a considerable valley, and consist of a wall, which may have originally been about 12 feet in height, enclosing a level area on the summit of the hill. The most remarkable feature of these structures is, that the wall is always more or less consolidated by the action of fire—in some cases only to the extent of giving a glassy coating to its inner side, while in other instances the vitrification has been more complete, the ruins assuming the character of vast masses of coarse glass. Structures of this kind are to be found at Noth and Dunnideer, in Aberdeenshire; Craig Phadrick, Tordun, and Glenever, in Inverness-shire; Knockfarril, in Ross-shire; Creich, in Sutherlandshire; Dunakeig, in Argyleshire; Finhaven, in Forfarshire; and elsewhere, but principally in the northern counties. They were first noticed by Mr John Williams, in his *Account of some Remarkable Ancient Ruins lately discovered in the Highlands and Northern Parts of Scotland*, published in 1777. Mr Williams's observations led him to conclude that they were artificial structures intentionally vitrified by a partial melting of their materials. Mr Williams's views were combated by other writers, who contended that the supposed forts were of volcanic origin, a supposition quite irreconcilable with their obviously artificial character. In 1828, the subject engaged the attention of the Society of Antiquaries of Scotland, a series of careful observations being made by Dr Samuel Hibbert, one of the secretaries of that body; and the conclusion arrived at was, that while the structures were artificial, the vitrification was an accidental effect, which might have arisen from such causes as the frequent kindling of beacon fires as signals of war and invasion, or of bonfires forming a part of festive or religious rejoicings. The alkali

produced from the accumulation of the ashes of continually blazing wood-fires would be a powerful aid to the fusion of stone. The view originally taken by Mr Williams has since been supported by Dr John McCulloch, who argues that the character of the works shews them to have been designed for defensive military posts, and observes, that in some cases where the most accessible materials for a stone-fort are incapable of vitrification, stones more capable of being vitrified have been brought from a distance. Dr Petrie has noted one vitrified fort in the county of Cavan, and four in the county of Londonderry, and he conjectures that they belonged to the Irish Picts. A single instance, that of the 'Camp of Pérán' in Brittany, occurs in France. In this case, only the central portion, or core, of the wall is vitrified, and in it a Roman roofing-tile was found by M. Lukis firmly attached to the melted stone. A number of the hill-forts of Bohemia have also been found to be constructed with a core of vitrified stones occupying the centre of the walls. Dr Fodisch attributes them to the bronze age and to a Celtic race. More detailed descriptions of these Irish, Breton, and Bohemian examples, however, are necessary to enable us to pronounce definitely as to their identity with those of Scotland. But there seems to be little doubt that the vitrification in them all was the work of design, though produced, it may be, by different methods, and with structural intentions not quite the same.—See *Archæologia Scotica*, vol. iv.; McCulloch's *Highlands and Western Islands of Scotland*; Burton's *History of Scotland*, chap. 3; *Proceedings Soc. Antiq. Scot.*, vol. viii., p. 145.

VITRINGA, CAMPEGIUS, an eminent Dutch divine and commentator, was born at Leuwarden in Friesland, 16th May 1659. He studied at Franeker and Leyden, at which last place he was created D.D. in his 20th year. In 1681, he was appointed Professor of Oriental Languages; and two years later, received the chair of Theology in the university of Franeker, where he died, March 21, 1722. V. is regarded as one of the most learned and laborious divines of his age, and has left many excellent and erudite works, chiefly commentaries on portions of the Scriptures, nearly all of which are in Latin. Among others may be mentioned, *Commentarius in Jesaiam*; *Anacrisis Apocalypses Johannis Apostoli*; *Commentarius in Jeremiam*; *Commentarius in Zecharaiam*; *Vetus Synagoga*; *Dissertationes Sacre*; *Typus Theologica Prophecia*, &c.

VITRIOL (derived from the Latin *vitrum*, glass) is a term which the early chemists applied to glass-like salts, distinguishing them by their colours into blue vitriol, green vitriol, and white vitriol. *Blue Vitriol* is still the popular name for sulphate of copper, which may be obtained on a large scale in various ways, but most simply by boiling copper in an iron pot with dilute sulphuric acid, by which means we obtain a salt having the formula,  $\text{CuO}, \text{SO}_3 + 5\text{Aq}$ , and crystallising in oblique prisms of a clear blue colour, which are soluble in four parts of cold, and two of boiling water, and when moistened, reddens litmus paper. In large doses, it acts as a powerful irritant poison, unless, as is frequently the case, it is rejected by vomiting. In small but repeated doses (as from half a grain, gradually increased to two grains, made into pills with conserve of roses), it acts as a tonic and astringent, and will often check the discharges in cases of chronic diarrhoea and dysentery, when other medicines have failed; and according to Neligan, it has been found serviceable in croup by checking excessive bronchial secretion. It has been much employed in cases of epilepsy, and is a valuable remedy in chorea and

other spasmodic diseases, especially when they occur in weak constitutions about the period of puberty. Its use in doses of from 10 to 15 grains as an active emetic is mentioned in all works on materia medica; but sulphate of zinc in a dose of a scruple, is as efficacious, and safer. Externally, this salt in solution (varying from one to ten grains in an ounce of water) forms a good application to indolent ulcers, aphthæ, cancrum oris, and the sore throat in scarlatina; it is also used in chronic ophthalmia, and as an injection in cases of urethral or vaginal discharges. In the solid state, it is used as a caustic to repress excessive granulations (proud flesh), to destroy warts, and to excite indolent ulcers.

*Green Vitriol* is the popular name for sulphate of iron. Its characters, the method of obtaining it, and its therapeutic uses, are sufficiently noticed in the article IRON.

*White Vitriol* will be described in the article ZINC.

*Oil of Vitriol* is the old name given to commercial sulphuric acid, in consequence of its oily appearance, and of its being formerly obtained from green vitriol.

*Elixir of Vitriol* is the old name for the aromatic sulphuric acid of the Pharmacopœia. It is a mixture of three ounces of sulphuric acid and two pints of rectified spirit, in which powdered cinnamon and ginger have been digested. Its uses in doses of from ten to thirty minims, in a wine-glassful of water, are much the same as those of dilute sulphuric acid, but it is more agreeable to the taste, and sits more lightly on the stomach.

VITRO DI TRINA, the name given to a beautiful kind of glass which was made by the Venetians in the 15th century. Its distinguishing character is a series of wave-like marks in opaque colours, but usually white, arranged pretty regularly in the substance of transparent glass.

#### VITRUVIAN SCROLL,

a continuous scroll-work forming a kind of cresting, used in classical architecture.



Vitruvian Scroll.

VITRUVIUS, the name of two Roman architects, the most celebrated of whom is MARCUS VITRUVIUS POLLIO, about whom we have no direct information further than the mention of his name by Pliny and Frontinus, though, from the references to himself in his own work, we can gather that in all probability he was born about 76 or 80 B.C. He received a liberal education, pursued specially those studies which were calculated to fit him for the profession of an engineer and architect, and was engaged in the African war (46 B.C.) as superintendent of military engines. He does not seem to have become very popular as an architect, and never succeeded in acquiring wealth, though the constant patronage which the emperor (Augustus) was induced by his sister (probably *Octavia Minor*) to extend to him, insured him comfortable subsistence during his life. The only public work he executed was a basilica at Fanum. V., in his book, *De Architectura*, enters at some length into the reasons which induced him to write it, the chief of them being, the care bestowed by his patron (after settled peace had been secured to the empire) on buildings public and private, his intention to erect numerous edifices, and the danger that, owing to the depraved architectural taste of the time, the beauty and correctness of the pure Grecian models would be neglected. The *De Architectura* is arranged in ten books; the first of which contains a dedication to the emperor, a general view of architectural science, hints as to the proper subjects of study for young aspirants,

and directions for building cities; the *second* treats of the early history of architecture, and of the materials employed at various times, and contains a sketch of the physical theories of various philosophers; the *third* and *fourth* treat of the erection of temples, and in connection with this, of the four orders of architecture, Ionic, Corinthian, Doric, and Tuscan; the *fifth* treats of public buildings; the *sixth*, of private houses in town or country; the *seventh*, of the finishing and decoration of private buildings; the *eighth* of water, the mode of discovering it, whence it may be obtained, and the modes of conveying it in large quantities to a distance; the *ninth*, of the principles of gnomonics, the rules for dialling, and other subjects physical and astronomical; and the *tenth*, of machines used in building and in military warfare, of the mechanical powers, of mills, engines for raising water, odometers, &c. To each book there is a preface, more or less connected with the main subject of the book, and it is in these prefatory remarks that we discover what we know of V.'s personal history. There have been many editions of V.; the first was published along with Frontinus's *De Aqueductibus* at Rome about 1486, and afterwards at Florence (1496) and Venice (1497). Rude woodcuts were introduced into various subsequent editions; and the edition of Bode (Berl. 1800) has a volume of plates; but the best edition, that of J. G. Schneider (Leip., 3 vols. 1807—1808), is without illustrations.—See Smith's *Classical Dictionary of Biography and Mythology*.

**VITRY-LE-FRANCOIS**, a town of France, in the dep. of Marne, on the right bank of the river Marne, 128 miles east of Paris by railway. The first site of the town was at Vitry-en-Perthois; but it was taken and burned by Charles V. in 1544. François I. rebuilt V. on its present site, surrounded with fosses and ramparts, and erected a castle for its protection. There are manufactures of hats and cotton goods. Pop. (1872) 6792.

**VITTO'RIA**, a modern town of Sicily, in the province of Siracusa, 18 miles north-west of Modica, on the Camarana. It possesses little interest, and is made only a noonday resting-place for travellers. The soil of its vicinity, however, is fertile in fruits and wines, bee-culture is carried on, and the town maintains an active trade in silk and cattle. Pop. 17,600.

**VITUS, ST. DANOE**. See CHORRA.

**VIVANDIÈRE**, in continental armies, and especially that of France, a female attendant in a regiment, who sells spirits and other comforts, ministers to the sick, marches with the corps, and contrives to be a universal favourite. Although a familiar friend to all, these women contrive to maintain themselves respectable, and generally respected; and a corps is usually extremely jealous of the slightest discourtesy shewn to its vivandière. The woman wears the uniform of the regiment, short petticoats replacing the man's tunic.

**VIVERRIDÆ**, a family of *Carnivora*, having the body elongated, the claws partly retractile, the pupil of the eye circular during the day, and not contracted into a vertical line, as in the *Felidæ*, and, in general a strong musky odour, proceeding from a secretion in a pouch near the anus. To this family belong the civet, genet, ichneumon, &c.

**VIVIPAROUS FISH**. See SUPP., Vol. X.

**VIVISECTION**—a term which is employed to designate operations performed with the knife on living animals, with the view (1) of increasing our physiological knowledge; (2) of confirming previously known facts; and (3) of giving dexterity in operative surgery—is a course of procedure which may

be traced back to almost the earliest periods of medicine and surgery, and was largely practised in the Alexandrian School. It is, however, only comparatively lately—about half a century ago, when the barbarous experiments of Magendie, Brachet, and other distinguished French physiologists, became known in this country—that the subject has attracted much popular notice; and during the last ten years, attention has been so specially drawn to the atrocities systematically carried on in the great French veterinary colleges at Alfort and Lyon, that a deputation of 'The Royal Society for the Prevention of Cruelty to Animals' laid a statement of the facts before the Emperor Napoleon. When it is stated, that with the nominal object of teaching the veterinary students at Alfort to become skillful operators, six living horses were supplied to them twice a week—that sixty-four operations were performed on each horse, and that four or five horses generally died before half the operations were completed—that it takes nearly two days to go through the list—and that all the old exploded operations, as well as those now practised, were performed—and lastly, when it is borne in mind that most, if not all, these operations could just as instructively have been practised on the dead animal (as is done in this country), there cannot be a doubt that a vast amount of unwarrantable and gratuitous cruelty was carried on in these establishments. Although the subject was brought before the *Académie des Sciences*, and warmly discussed, the final conclusion was, 'that the complaints of the London Society are totally without foundation; and that there is no occasion to take any notice of them.' We believe that it is only by the veterinary colleges of France that the view is advocated that vivisection is necessary for the purpose of giving dexterity in surgical operations.\* But while all right-minded persons—except the majority of the members of the French Academy, whose votes were probably influenced by a feeling of nationality—must concur in the view, that the argument in favour of vivisection utterly breaks down, some go further, and doubt whether any experiments on living animals, performed with the object of advancing medical and surgical knowledge, and of thereby relieving, indirectly, human suffering, or prolonging human life, are, on moral grounds, to be regarded as justifiable. In opposition to this view, it is maintained that, under certain circumstances, and with due restrictions, such experiments are not only justifiable, but their performance becomes a positive duty. It may be observed that, though in stating this controversy the term vivisection is retained, the remarks apply to all kinds of experiments on living animals. It is universally admitted that man may destroy animals for his food, and to furnish him with many of the necessaries and luxuries of life; and most persons go a step further, and see no impropriety in the pursuit of field-sports. Now, as Dr Markham argues in his excellent prize essay on this subject, in all these cases of admittedly legitimate destruction of animal life, the infliction of pain is a necessary ingredient. In some modes of destruction, the death-blow is dealt at once, and the pain is but fleeting; whilst in others, the agony of the death-struggle is equivalent to a prolonged and painful torture. An ox may be at once stunned, while the animal bled to death suffers prolonged convulsive struggles. The humanitarian, if he be a sportsman, thinks little of the lingering pain which a wounded

\* *Vivisection: is it necessary or justifiable?* Being two prize essays, published by the Royal Society for the Prevention of Cruelty to Animals (Lond. 1866).

bird or broken-legged hare undergoes; nor, if he be engaged in the whale-fishery, does he lament over the prolonged suffering which the object of his pursuit must suffer before its capture. If, then, man can legitimately put animals to a painful death in order to supply himself with food and luxuries, why may he not also legitimately put animals to pain, and even to death, for the far higher and more noble object of relieving the sufferings of humanity, and of prolonging human life? To point out what gain has accrued to physiology (and hence, indirectly, to the healing art) by experiments on living animals, would occupy many pages of this work. It is sufficient to allude to the facts, that the doctrine of the circulation of the blood, and of the existence of, and circulation through, the lacteals, was thus established, and that nearly the whole of our present knowledge of the functions of the nervous system has been thus obtained, and could never have been afforded by the most minute anatomical research, and that in consequence of the knowledge thus obtained we no longer divide a motor nerve, and thus paralyse the face, in the hope of relieving tic douloureux; while, on the other hand, thanks to the researches of Brown-Sequard, Bernard, and others, we can now see our way to a more rational mode of treating epilepsy, various obscure forms of paralysis, &c. Without vivisection, we could never clearly have understood the causes of the sounds of the heart, without the knowledge of which the stethoscope would have been useless in the diagnosis of cardiac diseases; nor should we have known anything of the true nature of that mysterious disease, diabetes. The Hunterian treatment of aneurism by ligature, which has saved hundreds of human lives, was worked out by experiments on living animals. The study of anaesthetics, which, after prolonged investigation, led to the introduction of chloroform (soon, possibly, to be superseded by some even less dangerous agent), was unquestionably accompanied by the suffocation of many animals; but surely no one who can form any estimate of the vast amount of misery which has been spared to humanity by the general introduction of the use of chloroform into surgical and midwifery practice, can regret the sacrifice. Indeed, the advantage of the discovery is experienced in more ways than one upon the lower animals, since the domestic animals are subjected to its beneficent influence when surgical operations are necessary, and since, in most cases, animals subjected to physiological experiments are now usually rendered insensible by it. If such questions as—the best means of restoring to life persons apparently drowned—why chloroform sometimes kills, and how those who are suffering under apparently fatal effects can be best recovered—admit, as they doubtless must, of a solution, that solution must be sought for in experiments on living animals. These and a multitude of similar considerations which might be adduced, are sufficient, it is maintained, to lead any unbiased inquirer to the conclusion that experiments on living animals, performed with the object of advancing medical, surgical, or toxicological knowledge, and of thereby indirectly relieving human suffering, or of prolonging human life, are not only justifiable, but a matter of duty.

At the meeting of the British Association held at Liverpool in 1870, the general committee requested the committee of section D (Biology) to draw up a statement of their views on physiological experiments in their various bearings, and they further requested the committee to consider 'from time to time whether any steps can be taken by them, or by the association, which will tend to reduce to its minimum the suffering entailed by legitimate

physiological inquiries.' Accordingly, at the meeting of the association at Edinburgh in 1871, the biological committee gave in a report, in which the following resolutions were presented: 1. That no experiment which can be performed under the influence of an anaesthetic ought to be done without it; 2. That no painful experiment is justified for the mere purpose of illustrating a law or fact already demonstrated; 3. Whenever, for the investigation of new truth, it is necessary to make a painful experiment, every effort should be made to insure success, so that the suffering inflicted may not be wasted—that, therefore, no painful experiment ought to be performed by an unskilled person, or in an unsuitable place; 4. In the scientific preparation for veterinary practice, operations ought not to be performed on living animals for the purpose of obtaining manual dexterity. On the reception of this report, a standing committee was appointed for the purpose of carrying out, with all the influence of the British Association, the above humane suggestions.

A still more satisfactory result, however, was the interference (following upon the report of a Royal Commission) of Parliament, which, in the year 1876, gave its assent to a bill to amend the law relating to cruelty to animals, the purpose of which was the restriction, or better regulation, of vivisection. The provisions of this Act coincide to a great extent with the resolutions of the committee as given above, and require that every one performing a painful experiment upon a living animal (which must be with a view of advancing physiological knowledge, or knowledge which will be useful for saving or prolonging life, or alleviating suffering), must hold a license from one of Her Majesty's principal Secretaries of State. Persons holding a conditional license are allowed to perform such experiments only in a registered place, while the same rule applies to experiments performed for the sake of instruction (which, however, are permitted only under certain stringent limitations). Special protection is afforded to horses, asses, mules, dogs, and cats. The Act does not apply to invertebrate animals.

VIZIER, or VIZIR (pronounced *vis-ir*'), the title of various high functionaries in the Ottoman Empire, and other Mohammedan states. The word, which is of Arabic origin, and signifies 'he who bears or supports (a burden),' was first bestowed as a title of honour on the chief-minister of the first Abbaside calif, in 750 A. D. During the decline of this dynasty, the vizier had to 'bear the burden' of government almost entirely, and consequently, increased so much in power and authority, that the califs thought it prudent to counteract his influence by the creation of the new dignity of *Emir-al-Omrah* (q. v.), which, being generally bestowed upon one or other of the powerful alien princes who had made for themselves sovereignties in Persia, was found to be an efficacious counterpoise. The dignity of vizier was first introduced among the Ottoman Turks during the reign of their second sultan, Orkhan, and the title was exclusively confined to the sultan's prime-minister; but in 1386, it was conferred by Amurath I. on his victorious general, Timur-tash, and the prime-minister's title was then changed into *vizir-a-z'hem*, 'grand or illustrious vizier.' From this period, the number of viziers was gradually increased, but since the commencement of the 18th c., only seven of them are ministers, the 'grand vizier,' and the six 'viziers of the cupola,' who constitute the Divan (q. v.). The grand vizier is, after the sultan, the most important personage of the Turkish Empire; he unites in his own person the whole powers of the state, and is charged with a corresponding responsibility. The

other six viziers in the divan, who are generally men well versed in law, and practically acquainted with the details of administration, form a council of advice, to whom the grand vizier applies when he thinks proper, but who possess otherwise no real power. The grand vizier, on his nomination, receives a sheet of parchment, on which is engraved the name of the sultan, and this he is bound always to carry in his bosom.—The title of vizier is also given to all the Pashas (q. v.) of three tails.

**VIZZINI**, a town of Sicily, in the province of Catania, and 29 miles south-west of the city of that name, stands on a hill. It is well built, and besides containing a college and hospital, there are a number of handsome buildings and churches, containing many fine pictures. Fruits in abundance are produced, and agates are found. Pop. 14,950.

**VLAA'RDINGEN**, an unwall'd town in South Holland, lies about five miles west from Rotterdam, at a short distance from the New Maas. It has a good haven, and sends annually a large fleet of vessels to the herring-fishing, besides carrying on a considerable shipping-trade with the Mediterranean, Norway, North America, Portugal, and Spain. The pop., 1st Jan. 1875, was 9049. Besides the herring and cod fishing and shipping-trade, the industries are: shipbuilding, rope-spinning, distilling gin, sawing wood, grinding corn, boiling oil, tar, &c. V. is one of the oldest towns in South Holland, the church now called the Reformed Church having been consecrated by Willebrord in the 7th c., but nearly rebuilt in 1744. It was the birthplace of the poets Arnold Hoogvliet (1687—1763) and Jacob van Dijk (1745—1823).

**VLADIMIR**, the name of two celebrated Russian princes, the former of whom, **VLADIMIR SVIATOSLAVITCH**, was the first Christian sovereign of Russia. On the death of his father (972), V., though illegitimate, received Novgorod as his share of the heritage, but was driven out by Jaropolk, who had already murdered the third brother, Oleg. However, V., by the aid of a body of Varangians (from Scandinavia), returned and overcame Jaropolk, by whose assassination (980) he became sole ruler in Russia. Disembarrassing himself of his dangerous allies by persuading them to take service with the Byzantine emperor, he next recovered by force from the Poles the provinces of which they had deprived his brother, and subdued various tribes which had recently revolted. Russia at this time was an ill-compacted empire; the various Slavic tribes which dwelt within its boundaries acknowledged the sovereignty of the Russian princes solely by the payment of tribute, and that only when the princes were powerful enough to enforce it; hence it was the custom for the princes personally, or their delegates, to go their regular rounds after the fashion of tax-collectors, backed up by a large armed retinue. V. tried to increase the central authority, and one of the means he adopted was the erection at his capital, Kiev, of the idol Perun (Thunder), the supreme divinity of the Slaves, and of the images of other inferior deities, Slave and Finnish. But a few years more effected a remarkable change; many of V.'s subjects were Greek Christians; his mother, Olga, had become one; besides, he wished to be allied with the Byzantine imperial family; and moved by these and other reasons of personal or patriotic ambition, he resolved to turn Greek Christian. His mode of arriving at conversion and matrimony was as curious as effective; he first made an attack upon the Byzantine Empire, then sent an embassy to Constantinople, promising peace and his conversion, in exchange for the hand of Anna, the sister of Constantine IX.; threatening war in case of

refusal. His demands were gladly complied with; and after his marriage and baptism at Kherson in 988, he returned to Kiev, destroyed all the idols, and commanded his subjects to be baptised. They had not the slightest objection to be baptised, if their feared and admired prince wished it; and for days the Dnieper was crowded with applicants for the first testing ordinance of Christianity. It could hardly have been expected that a conversion managed in such a fashion would have affected the manners and conduct of such an arbitrary, violent, and daring prince as V.; yet, strange to say, from 988 he appeared to have undergone a thorough mental and moral transformation; churches were built, schools established, capital punishment was supplanted by a fine, and such excessive lenity shewn to all criminals, that in the interests of good government, it was found necessary to remonstrate with the thorough-going convert. Formerly, the wisdom and valour for which he was renowned were equalled by his licentiousness, so that the chronicles had more than one reason for saying that 'he was like unto Solomon;' but the strictest chastity characterised the latter part of his life; and his charity to the poor, and personal forbearance, were extreme. He died in 1014, three years after his wife Anna. The Russian Church has decreed him the epithets of 'saint,' and 'equal of the apostles.'—**VLADIMIR II. VSEVOLODOVITCH**, surnamed *Monomachus*, grand-prince of Kiev, the great-grandson of the preceding, was born in 1053. His father being a younger son, there seemed to be little chance of V.'s attaining power in the ordinary course of events, in his own country; and he accordingly led a band of auxiliaries to join Boleslas II. of Poland in his wars with Bohemia; gaining such renown, as on his return ranked him at the head of Russian warriors. V.'s father having, as the eldest of the Russian princes, succeeded to the grand principality of Kiev (1078), V. took advantage of the opportunity to wrest from their lawful possessors, Smolensk, Tchernigov, and Novgorod; though some years afterwards, his cousin Oleg, the dispossessed prince of Tchernigov, with the aid of the Polotzee or Cumans (a Turkish nation which was at that time the terror of the Russians), recovered his dominion. V. having subsequently routed the Polotzee in several engagements, became so extremely popular, that in 1112 he was chosen grand-prince of Kiev, and for 13 years displayed his eminent qualities as a ruler and a warrior. The maintenance of internal tranquillity, the improvement of old, and the building of new towns, and the encouragement of commerce, on the one hand; and the successful campaigns against the Tchudes, Poles, Polotzee, and Bulgars (a Mohammedan commercial people settled on the Volga), on the other, are the principal characteristics of his reign. Most of V.'s fame, however, rests on his writings, which present an interesting picture of the internal life of Russia in the 11th c., and indicate prominently the earnest practical influence of the newly introduced Christianity. V.'s mother was a daughter of Constantine Monomachus; and Alexis Comnenus, who wished to be on good terms with his powerful northern neighbour, is said to have sent him the crown, sceptre, and sword of his grandfather, which are still shewn as such, and which are employed in the coronation of the czar.

**VLADIMIR**, a government of Russia, bounded on the E. by the government of Nijni-Novgorod, and on the S.-W. by that of Moscow. Area, 18,796 sq. m.; pop. (1870) 1,259,923. The surface is level or undulating; the soil consists chiefly of clay or sand, and is fertile only in exceptional spots. The principal rivers are the Oka and its tributaries, of which the chief is the Kliasma, a navigable stream. Of the

lakes, which are numerous, but of inconsiderable size, that of Pereiaslav is remarkable for its productive fisheries, and is famous in history as being the cradle of the Russian fleet. After St Petersburg and Moscow, the government of V. is the most actively industrious in the Russian Empire. Of its manufactured goods, cotton-yarn and cloth are made to the value of 13,000,000 roubles annually; chintz and dyed goods, 12,000,000 roubles; linen, 2,000,000 roubles; glass, 1,000,000 roubles; iron and brass foundries produce goods to the value of 1,000,000 roubles; and the manufactures of chemicals and paper are very extensive. The inhabitants are also much employed in painting images and in knitting stockings, which are used in Russia and Siberia, and yield 1,000,000 roubles per annum. The grain-crops raised are insufficient for local consumption, and corn is imported from neighbouring governments. Hemp is successfully grown; and besides being used in considerable quantities in local manufactures, is exported to Archangel and St Petersburg. Forests, mostly of pine, form a border round the government, but do not occur in the interior. In the 9th c., the country was inhabited by Finns; and though it was subsequently conquered and settled by the Slavonians, traces of the original inhabitants are visible in the present population.

VLADIMIR, a town of Great Russia, capital of the government of the same name, stands on the left bank of the Kliasma which is high and wooded, 125 miles north-east of Moscow. It was founded in the 12th c., during the ascendancy of the Dukes of Vladimir, and was the capital of Russia till 1323. It contains many historical remains, as the Kremlin; the 'Golden Gate,' built in 1158; ruins of old fortifications, and many ancient churches. The ecclesiastical seminary is important. There are several manufactures, and a trade in corn. Cherries are a considerable local product. Pop. (1867) 15,478.

VODE'NA, a beautifully-situated town of European Turkey, in Rumili, on a mountain slope, 46 miles west-north-west of Saloniki. Water is here very abundant; torrents rush headlong down the middle of all the streets, and the sound of cascades is everywhere heard. The houses, from the archbishop's palace to the humblest cottage, are picturesque, but are not otherwise remarkable. The streets are wretchedly paved. V. occupies the site of the ancient Edessa, the early capital of Macedonia. Pop. estimated at 12,000.

VOGHERA, a city of Northern Italy, in the province of Pavia, stands on a fertile elevated plain, in a district rich in vineyards, orchards, and corn-fields, 24 miles east-north-east of Alessandria by railway. The Via Emilia passes through the town, and divides it into two parts. There are several handsome squares, of which that of the Duomo is the chief; the streets are adorned with porticoes; and there is an old castle, built by Galeazzo Visconti in 1372. The civic palace contains many valuable parchments and manuscripts of the 11th, 12th, and 13th centuries. Silks, linens, canvas, and leather are manufactured. Pop. 11,450.

VOICE (Lat. *vox*) may be defined as an audible sound produced by the larynx, and may be produced by any animal possessing that organ; while speech or articulate language may be regarded as voice modified in the cavity of the mouth. The Larynx (q. v.) is the organ by which the so-called *vocal sounds* (or primary elements of speech) are produced. In the article LARYNX, it is shewn that there are two groups of muscles, which respectively govern (1) the *pitch of the notes*, and (2) the *aperture of the larynx*. Those which affect the pitch of the notes are divisible

into two antagonistic sub-groups, viz., (a) those which depress the front of the thyroid cartilage on the cricoid, and *stretch* the vocal ligaments; and (b) those which elevate the front of the thyroid cartilage, and *relax* the vocal ligaments; while those which control the aperture of the glottis are divisible into (c) those which *open* it, and (d) those which *close* it. It is only the first of these groups, viz., the muscles which stretch or relax the vocal ligaments, that is concerned in the production of voice. In the ordinary condition of rest, there is a wide opening between the vocal ligaments, which are in a state of complete relaxation, and the air passes freely between them. For our knowledge of the appearances presented under varying conditions by the interior of the larynx, we are mainly indebted to Professor Czermak, the inventor of the Laryngoscope (q. v.); and the reader who wishes to enter fully into this subject is referred to his work on that instrument, of which a translation was published by the New Sydenham Society in 1861. The three



Fig. 1.—Condition of the Larynx during tranquil respiration:

*e*, epiglottis; *a*, fissure-like opening of oesophagus; *c*, fold of mucous membrane bounding the opening of the glottis posteriorly.

figures, 1, 2, 3, represent respectively the condition of the larynx as seen during tranquil respiration, its condition during the emission of the broad vocal

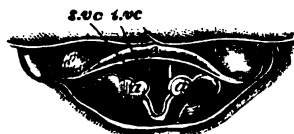

Fig. 2.—Condition of the Larynx during the emission of the broad vowel sound A:

*a, a*, cartilages of Santorini, surmounting the arytenoid cartilages; *e*, epiglottis; *iv*, inferior or true vocal cord; *sv*, superior or false vocal cord of left side.

sound A, and its condition during the emission of a high or acute sound. The movements of the arytenoid cartilages during the production of vocal sounds



Fig. 3.—Condition of the Larynx during the emission of a high or acute sound:

*e*, epiglottis; *cv*, cushion of epiglottis; *iv*, true vocal cord; *sv*, false vocal cord.

can be distinctly seen—the views that had been previously deduced, from theory and experiments on the dead subject, being thus confirmed by ocular proof. As soon as we wish to utter a sound, the two arytenoid cartilages raise themselves in the fold of mucous membrane which covers them, and approach one another with surprising mobility. This movement effects the approximation of the



vocal cords, and consequently the contraction of the glottis (fig. 2). It is impossible to study with the laryngoscope the mode of formation of the gravest chest-sounds, because the arytenoid cartilages become so raised that they almost come in contact with one another, while they bend under the border of the depressed epiglottis, and thus conceal the interior of the larynx. During the emission of the most acute sounds, the glottis contracts into a mere line, on each side of which the vocal cords may be recognised by their whitish-yellow colour; while further outward, and separated from the former by a narrow groove, are the false or superior vocal cords of either side. The arytenoid cartilages are raised, and come in contact in the median line, the epiglottis is drawn outwards, and a short stiff tube is then formed above the glottis; all these parts being, as we learn from our sensations during the experiment, in a state of very great tension. Independently, however, of such observations as those we have recorded from Czermak's interesting Memoir, any one may easily prove for himself that the aperture of the glottis is much contracted during the production of sounds, by comparing the time occupied by an ordinary expiration with that required for the passage of the same quantity of air during the maintenance of a vocal sound; moreover, the size of the aperture varies with the note that is being produced, as may be readily seen by any one who compares the time during which he can hold out a low and high note. When the distance between the vocal cords exceeds one-tenth of an inch, no sound can be produced.

How the vocal cords produce sounds, is a question which has long attracted the attention of physiologists and physicists. To answer it, they were compared with various musical instruments. More than a century ago, Ferrein (*De la Formation de la Voix de l'Homme*, 1741) compared them to vibrating strings; and at first sight, there is an apparent analogy; but on further investigation (for reasons which may be found in Carpenter's *Human Physiology*, 6th ed., p. 715), this view was found to be untenable. The analogues between the organ of voice and the *flute-pipe*, in which the sound is produced by the vibration of an elastic column of air contained in a tube, were then investigated, but found to fail. The third class of instruments with which the human organ of voice has been compared are vibratory reeds or tongues, which may either possess elasticity in themselves, or be made elastic by tension. From the experiments of Weber, it appears that the action of the larynx has more analogy to that of reed-instruments than to the instruments previously named, and though there would seem at first sight to be a marked difference between the vocal ligaments and the membranous tongue of any reed-instrument, this difference is not very great. Müller ascertained that membranous tongues made elastic by tension may have three different forms, of which the following, which alone concerns us, is one: 'Two elastic membranes may be extended across the mouth of a short tube, each covering a portion of the opening, and having a chink left open between them.' Here there is clearly an approximation to the human glottis, which may be increased by prolonging the membranes in a direction parallel to that of the current of air, so that not merely their edges but their whole planes shall be thrown into vibration. Professor Willis has, upon this principle, invented an *artificial glottis*, in which the vocal ligaments are imitated by leather, or preferably by sheet india-rubber. It is composed of a wooden pipe of the form of fig. 4, *a*, having a foot, *C*, like that of an organ-pipe, and an upper opening, long and narrow, as at *B*, with a

point, *A*, rising at one end of it. A piece of leather or sheet india-rubber doubled round this point, and secured by being bound at *D* with strong thread, will form an artificial glottis, *b*, while its upper edges, *G*, *H*, are capable of vibrating or not by inclining

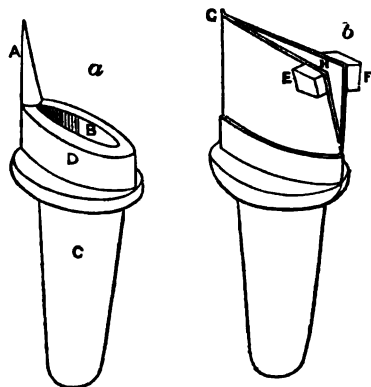

Fig. 4.

the planes of the edges. Two pieces of cork, *E* and *F*, are glued to the corners to make them more manageable. From this machine, various notes may be obtained by stretching the edges of the leather in the directions of their length, *G*, *H*; the scale of notes yielded by leather is much more limited than that yielded by india-rubber; and other observers have found that the middle coat of the arteries in a moist state (as being more elastic, and almost identical in structure with the vocal ligaments), yields more satisfactory results even than india-rubber. 'It is worthy of remark,' as Dr Carpenter observes, 'that in all such experiments it is found that the two membranes may be thrown into vibration, when inclined towards each other in various degrees, or even when they are in parallel planes, and their edges only approximate; but that the least inclination from each other (which is the position the vocal ligaments have during the ordinary state of the glottis) completely prevents any sonorous vibrations from being produced.'—*Op. cit.*, p. 718. The pitch of the notes produced by membranous tongues may be affected in various ways (as by increasing the strength of the blast, the addition of a pipe, &c.), and is mainly governed by their degree of tension, while the foregoing statements shew that the sound of the voice is the result of the vibrations of the vocal ligaments which take place according to the same laws with those of elastic tongues generally. Little is, however, known with certainty regarding the mode and degree in which the tones are modified by the shape of the air-passages generally, the force of the blast of air, and other circumstances.

The *falsetto* is a peculiar modification of voice, differing from the ordinary or *chest voice*, not only in the higher pitch of the notes, but also in their quality. The theory of its production is still an open point, into which we have not space to enter, further than to remark that, according to Professor Wheatstone, falsetto notes are to be explained by supposing that 'the column of air in the trachea may divide itself into harmonic lengths, and may produce a reciprocation of the tone given by the vocal ligaments.'

The pressure of the air within the trachea during the production of voice is very considerable. From observations made by Cagniard-Latour on a man with a fistulous opening in the trachea, it was found that when the patient called out

at the top of his voice, the pressure was equal to that of a column of water 38 inches in height; when he spoke at his usual pitch, to one of 5 inches; and when he sang in a high note, to one of about 8 inches. The glottis has been well chosen by Dr Carpenter to illustrate the minute precision with which the degree of muscular contraction can be adapted to the desired effect. The musical pitch of the tones produced by it is, as we have shewn, regulated by the degree of tension of the elastic vocal ligaments. Their average length, in a state of repose, is  $\frac{1}{10}$ ths of an inch; while in the state of greatest tension, it is about  $\frac{1}{100}$ ths—the difference being thus *one-fifth* of an inch; while in the female the respective lengths are  $\frac{1}{11}$ ths and  $\frac{1}{10}$ ths respectively—the difference being thus about *one-eighth* of an inch. Now, the natural compass of the voice, in persons who have cultivated the vocal organ, is about two octaves, or 24 semitones. Within each semitone, an ordinary singer could produce at least ten distinct intervals (the celebrated Madame Mara could sound 100 different intervals between each tone, the compass of her voice being 21 tones), so that 240 is a very moderate estimate of the number of different states of tension of the vocal cords, every one of which can be produced at will; and the *whole* variation in the length of the cord being not more than one-fifth of an inch, even in man, the variation required to pass from one interval to another will not be more than  $\frac{1}{100}$ th of an inch (while in such a case as that of Madame Mara the distance would be reduced to  $\frac{1}{17,000}$ th of an inch).

In the production of vocal sounds, the delicate adjustment of the muscles of the larynx, which is requisite to the evolution of determinate tones, is directed by the sense of hearing, being originally learned under the guidance of the sounds actually produced; but 'being subsequently effected voluntarily, in accordance with the mental conception of the tone to be uttered, which conception cannot be formed unless the sense of hearing has previously brought similar tones to the mind. Hence it is that persons who are born deaf are also *dumb*. They may have no malformation of the organs of speech, but they are incapable of uttering distinct vocal sounds, or musical tones, because they have not the guiding conception, or recalled sensation, of the nature of these. By long training, however, and by imitative efforts directed by muscular sensations in the larynx itself, some persons thus circumstanced have acquired the power of speech; but the want of a sufficiently definite control over the vocal muscles is always very evident in their use of the organ.'—*Op. cit.*, p. 556. A fund of interesting matter in connection with this subject may be found in Dr Kitto's *Lost Senses*. Although not born deaf, he became *completely* so in early childhood, in consequence of an accident. His voice became similar to that of a person born deaf and dumb, and taught to speak. It was observed that the words which he had been accustomed to use before his accident, were still pronounced as they had been in childhood, the muscular movements concerned in their production having been still guided by the original auditory conception, while all the words subsequently learned were pronounced according to the spelling.

The various muscular actions which are concerned in the production of vocal tones, are commonly regarded as being under the influence of the will. It is, however, easy to shew that this is not the case. We cannot, by simply *willing* to do so, raise or depress the larynx, or move one cartilage of it towards or from another, or extend or relax the vocal ligaments; although 'we can readily do any or all of these things by an act of the will, exerted

for a specific purpose. We conceive of a tone to be produced, and we *will* to produce it; a certain combination of the muscular actions of the larynx then takes place, in most exact accordance with one another, and the predetermined tone is the result. This anticipated or conceived sensation is the guide to the muscular movements, when as yet the utterance of the voice has not taken place; but while we are in the act of speaking or singing, the contractile actions are regulated by the present sensations, derived from the sounds as they are produced.' From these remarks, in which Dr Carpenter has placed a very difficult subject in as clear a light as the subject admits of, it follows that the muscular actions which are concerned in the production and regulation of the voice, are due to an *automatic* impulse, similar to what occurs in the movements of the eyeball, and in many other cases that might be adduced. There cannot be a doubt that the simple utterance of sounds is in itself an instinctive action; although the combination of these sounds into music or into articulate language, is a matter of acquirement.

Having explained the way in which the larynx produces those *tones* of which the voice fundamentally consists, and the sequence of which becomes *music*, we come to the subject of *speech*, which consists in the modification of the laryngeal tones by other organs superior and anterior to the larynx (as the tongue, the cavity of the fauces, the lips, teeth, and palate, with its velum and the uvula acting as a valve between the throat and nostrils), so as to produce those *articulate sounds* of which language is formed. The organ of voice is thus capable of forming a large number of simple sounds, which may be combined into groups, forming words. Vocal sounds are divided into vowels and consonants. When a vowel is pronounced, what happens? This question is thus answered by Professor Max Müller: 'Breath is emitted from the lungs, and some kind of tube is formed by the mouth, through which, as through a clarinet, the breath has to pass before it reaches the outer air. If, while the breath passes through the vocal cords, these elastic *laminae* are made to vibrate periodically, the number of their vibrations determines the pitch of our voice, but it has nothing to do with its *timbre*, or vowel. What we call vowels are neither more nor less than the qualities, or colours, or *timbres* of our voice, and these are determined by the form of the vibrations, which form, again, is determined by the form of the buccal tube.'—*Lectures on the Science of Language*, 2d series, p. 116. This writer enters very fully into the various configurations of the mouth requisite for the formation of the different vowels. (1.) In pronouncing *u* (the vowels are all understood to be pronounced as in Italian), we round the lips, and draw down the tongue, so that the cavity of the mouth assumes the shape of a bottle without a neck. (2.) If the lips are opened somewhat wider, and the tongue be somewhat raised, we hear the *o*. (3.) If the lips are less rounded, and the tongue somewhat depressed, we hear the *á* of the northern languages (as in *august*). (4.) If the lips are wide open, and the tongue in its natural flat position, we hear *a*. (5.) If the lips are fairly open, and the back of the tongue raised towards the palate, the larynx being raised at the same time, we hear the sound *e*. (6.) If we raise the tongue higher still, and narrow the lips, we hear *i*. The buccal tube here represents a bottle with a very narrow neck, of no more than six centimetres (or about two inches and a quarter) from palate to lips. Diphthongs arise when, instead of pronouncing one vowel directly after another with two efforts of the voice, we produce a sound

during the change from one position to the other, that would be required for each vowel. Though the tube of the mouth thus modified by the tongue and lips is the chief agent in the production of vowels, Czermak has proved that the *velum palati* is changed in position with each vowel, and that it is lowest for *a*, and rises successively with *e*, *o*, *u*, and *i*, when it reaches its highest point. He likewise found that the cavity of the nose is more or less opened during the pronunciation of certain vowels. Languages might have been formed entirely of vowels, but the existing words, consisting solely of vowels, shew how unpleasant such languages would have been. Something else was obviously wanted to supply what Max Müller happily terms *the bones of language*—namely, the consonants. These are commonly divided into (1) those which require a total stoppage of the breath at the moment previous to their being produced, and which cannot, therefore, be prolonged; and (2) those in pronouncing which the interruption is partial, and which, like the vowel sounds, can be prolonged at pleasure. The former are termed *explosive*, and the latter *continuous*, consonants. In pronouncing the *explosive* consonants, the posterior openings of the nostrils are completely closed, so as to prevent the passage of air through the nose, and the current may be checked in the mouth in three ways—viz. (a) by the approximation of the lips; (b) by the approximation of the point of the tongue to the front of the palate; and (c) by the approximation of the middle of the tongue to the arch of the palate. The letters *b* and *p* are pronounced by the first of these modes; *d* and *t* by the second; and *g* (hard) and *k*, sounded as *key*, by the third; the difference between *b*, *d*, and *g*, on the one hand, and *p*, *t*, and *k*, depends upon the approximating surfaces being larger, and the breath being sent through them more strongly at the moment of opening in the former than in the latter group. The *continuous* consonants may be subdivided into three classes, according to the degree of freedom with which the air is allowed to escape, and the compression which it consequently experiences. In the *first* class, no air passes through the nose, and the parts of the mouth that produce the sound are closely approximated, so that the compression is considerable. This is the case with *v* and *f*, *z* and *s*, *d* and *t*, *th*, *sh*, &c., the movement of the tongue being also concerned in the production of several of these sounds. In the *second* class, including *m*, *n*, *l*, *r*, the nostrils are not closed, and consequently, the air is scarcely at all compressed. In pronouncing *m* and *n*, the breath passes through the nose alone; *m* is a labial, like *b*, but the latter is formed with the nose closed. Hence the passage of *m* to *b* (as in *lamb*) is easy; so also is that from *n* to *t*, or from *n* to *g*, as is seen in the frequent combination of *nt* and *ng* in most languages. The sounds of *l* and *r* (letters which Max Müller places in a special group under the name of *Trills*) are produced, according to Helmholtz, as follows: 'In pronouncing *r*, the stream of air is periodically entirely interrupted by the trembling of the soft palate, or of the tip of the tongue, and we then get an intermittent noise, the peculiar jarring quality of which is produced by these very intermissions. In pronouncing *l*, the moving soft lateral edges of the tongue produce, not entire interruptions, but oscillations in the force of air.'—*Die Lehre von den Tonempfindungen*, 1863, p. 116. The *third* class contains sounds which scarcely deserve to be called consonants, since they are merely *aspirations*, either simple, or modified by an elevation of the tongue, causing a slight obstruction to the passage of air, and an increased resonance in the back of the mouth. The present *h* and the

Greek  $\chi$  are examples of these sounds. The method of pronouncing these sounds is very fully discussed in Max Müller's Lectures, 2d Series, pp. 127—136.

For further details, the reader is referred to the admirable chapter on 'Voice and Speech' in Carpenter's *Human Physiology*, and to Max Müller's *Lectures on the Science of Language* (from both of which we have borrowed largely in this article), to Mr Bishop's article 'Voice' in the *Cyclopædia of Anatomy and Physiology*; and the various works of Funke, Helmholtz, Brücke, Czermak, Du Bois Raymond, &c. mentioned by Max Müller in his chapter on 'the Physiological Alphabet.'

VOIDED, in Heraldry, a term applied to an ordinary when its central area is removed, so that the field is seen through it, and little but a mere outline remains, as in the example No. 1—Azure, a saltire voided argent. When the ordinary has its outer edge formed of any of the lines of partition



Voided.

other than dancetté, wavy, or nebuly, the voiding is nevertheless plain, as in No. 2—Azure, a chevron engrailed voided or. An ordinary voided and coupé differs from an ordinary coupé and voided in so far as the former is open at the extremities, and the latter enclosed. One ordinary may sometimes be voided in the form of another, as a cross voided per pale in the example No. 3.

VOIRE DIRE (*peritatem dicere*). In English Law, when a witness is supposed to be liable to objection for incompetency or otherwise, he is first sworn, not in the cause, but on the *voire dire*, that is, to answer questions relating to this incompetency; and if it is apparent that he is incompetent, he is discharged without further examination.

VOIRON, a town of France, in the dep. of Isère, beautifully situated on the Morge, 15 miles by railway north-west of Grenoble. Among the manufactures which are here carried on with great activity are to be mentioned blacksmiths' work, paper-making, nail-making, and tanning. Pop. (1872) 7500.

VO'LANT, in Heraldry, flying. A bird volant is represented flying bendways towards the dexter side of the shield; and its position may be distinguished from that of a bird rising by the legs being drawn up towards the body.

VOLCA'NOES are conical mountains which vomit flame and smoke, and occasionally throw out showers of ashes and stones, or eject melted rock on the surface of the earth. Volcanoes may have their origin on flat plains on the surface of the earth, or even at the bottom of the sea; but the gradual accumulation of the ejected material around the vent, through which it has been poured, forms in time a mountain, if it is allowed to remain. The waves swept away the cone of Grahame's Island (q. v.), which in 1831 appeared in the Mediterranean, scattering the lava and scorias of which it was composed at the bottom of the sea. When, however, the ejected materials are sufficiently compact to resist the action of the waves, a permanent island is produced, and sometimes increases in height with a rapidity that can scarcely be imagined. In 1796, a volume of smoke was seen to rise from the Pacific

## VOLCANOES.

Ocean about 30 miles to the north of Unalaska. The ejected materials having raised the crater above the level of the water, flames issued from the islet, which illuminated the country for 10 miles around. Six years afterwards, when a few hunters landed on the new island, they found the soil in some places so hot that they could not walk upon it. Repeated eruptions have increased the dimensions of the island, until now it is several thousand feet in height, and between two and three miles in circumference. In the same region is the volcanic island of Kliutschewak, which rises at once from the sea to the enormous height of 15,000 feet.

The lava, scoria, and ashes which are thrust out of the crater form highly inclined and more or less regular beds on the surface of the mountain, extending from the crater-mouth to varying distances down the sides of the volcano. This method of increase gives the uniform conical outline to volcanoes, without the terraces or breaks which are found in almost all other mountains. The sides are often furrowed longitudinally by straight narrow ravines, which increase in number towards the base. These are produced by the action of running water obtained from rain or from melting snows during an eruption. The rapidity with which floods rush down the steep sides of a volcano gives a prodigious force, which the loose scoria and ashes, and even the solid lava, cannot resist.

The grayish colour of volcanic mountains is produced by the ash and scoria, which, though in composition the same as the dark lava, have this lighter colour from the minute subdivision of their particles. When a particular series of rocks remain on the surface, and are not covered by the products of more recent eruptions, they weather and decompose, and produce a very fertile soil, which is speedily clothed with vegetation, and thus change the whole aspect of the formerly bare and uniformly-coloured mountain.

The vent through which the materials are vomited forth is called the crater. This is a more or less circular opening, communicating with the source from which the ejected materials are obtained. The crater has generally one side much lower than the other—that from which the prevailing wind blows, which carries with it the showers of ashes to the opposite side of the mountain. In many cases, the cone is truncated; a wide hollow of immense extent, and often of great depth, in the base of which the crater is situated, occupies the summit. The Spanish name *Caldera* is technically applied to these hollows. Their origin has been a subject of considerable controversy. Von Buch and others maintain that they are craters of elevation; that is, that the rocks were originally spread out in nearly horizontal deposits, and then upheaved into a dome-shaped mountain, with the hollow caldera in the centre of its summit. The more satisfactory explanation is that the original cone, formed by the alternate deposition of the lava and ashes ejected from the crater, has, from the great heat of the molten lava rising in the tube of the volcano, or from gaseous explosions, given way, and fallen in. The cones both of Etna and Vesuvius have frequently fallen in and been reproduced. In 1822, the summit of Vesuvius was reduced by 800 feet. The immense size of some calderas seems, however, opposed to this theory. That of the island of Palma, one of the Canaries, is from three to four geographical miles in diameter, and the precipices which surround the cavity are from 1500 to 2000 feet in vertical height. They form an unbroken wall, except at the south-western end, where a deep gorge permits the passage of the torrent which drains the caldera. The precipices are traversed by numerous vertical dikes, and exhibit all

the appearances which would be produced by the falling-in of the huge summit of this once enormous volcano.

The pressure of the incandescent lava often forces for itself a passage to the surface before it reaches the mouth of the crater, and this is more frequently the case when the volcanic eruption is accompanied with earthquakes. Immense vertical fissures are found radiating from the centre of the volcanic action, and reaching the surface of the ground, and even rising to the summit of the mountain; these being filled with the molten rock, which in course of time solidifies and forms often a large portion of the mountain mass, as is shewn in the *Val del Bové* on Etna (q. v.). The lava sometimes pours out of these fissures instead of rising to the crater. In 1783, during a terrible eruption of Hecla, a prodigious stream of lava flowed from a lateral crevice; moving slowly down the mountain-side, it reached a distance of 50 miles in 42 days; it then branched into two main streams, the one running 40 miles, and the other 50 miles further towards the sea. Its depth varied from 600 to 1000 feet, and its greatest width was 15 miles. The amount of lava poured out into this stream would almost equal *Mont Blanc* in bulk.

The power which exhausts itself in the eruption of a volcano often shews itself by changes which it produces in the level of the country around. About a hundred years ago, a volcano appeared in the centre of the great table-land of Mexico, and raised an area of nearly four square miles 550 feet higher than it was before, covering it at the same time with conical hills of various heights, the highest of which is *Jorulla*, which is 1600 feet high. But sometimes a subsidence takes place. In 1772, a great part of the *Papandayang*, a mountain in Java, was swallowed up; the inhabitants of its declivities were suddenly alarmed by tremendous noises in the earth, and before they had time to retire, the mountain began to subside, and soon disappeared. The area thus sunk was 15 miles long and 6 broad.

A volcanic eruption is generally preceded by rumbling noises and slight movements in the earth; then fitful puffs of gases and steam are given off. These contain much sulphur; and some volcanoes give out such quantities of carbonic acid and other mephitic gases as to destroy the animals in the neighbourhood. Sir William Hamilton picked up dead birds on Vesuvius during an eruption; in 1730, all the cattle in the island of *Lancrota*, one of the Canaries, were destroyed by these deleterious emanations. The *Upas Valley* in Java contains an extinct crater; and the certain death which overtakes every animal that penetrates the valley, is due to the noxious gases given out from it, and not to the *Antiaris*, which, though yielding a deadly poison, does not affect the atmosphere in which it grows. The eruption itself begins, perhaps, with the ejection of the finest dust, and that with such a force as to project it high into the atmosphere, where, taken up by air-currents, it is often carried to enormous distances. In 1845, the dust from Hecla was in ten hours thickly deposited on some of the Orkney and Shetland Islands: the ashes from *Consequina* fell, in 1835, on the streets of Kingston, Jamaica, at a distance of 700 miles; and during the same eruption, the fine dust covered the ground at a distance of nearly 30 miles to the south of the volcano, to a depth of more than 10 feet, destroying the woods and dwellings, and enveloping thousands of quadrupeds and birds.

The flames seen issuing from the crater are usually the reflection of the glowing lava emitted from the crater, and illuminating the clouds of vapour, scoria, and ashes.

Lava and scoræ are at last vomited forth. Sir William Hamilton says that, in 1779, the jets of liquid lava from Vesuvius, mixed with scoræ and stones, were thrown to a height of 10,000 feet, giving the appearance of a column of fire. The lava, however, generally issues from openings in the side of the mountain. It pours forth in a perfectly liquid state, bright and glowing with the splendour of the sun. At first, it flows rapidly; but as its surface becomes cooled and converted into slag, its velocity diminishes. It has to burst the indurated coating before it can continue its progress, and the liberated lava when it flows bears on its surface masses of scoræ, looking like the slag from an iron furnace.

The materials ejected from a volcano, though differing greatly in appearance, have the same mineral composition. The ash is merely the pumice in a very fine state of division, and the pumice also is only lava made vesicular from contact with air or water.

The theories propounded to account for volcanic action are either chemical or geological. Sir H. Davy suggested that if immense quantities of the metallic bases of the earths and alkalis were present in the interior of the earth, all the phenomena would be produced by their oxidation from contact with air or water. Although the distinguished author of this theory abandoned it, it has since been taken up and advocated by Daubeny and others. Bischof, assuming that the interior of the earth consists of a highly heated and fused mass, considers that the mechanical action of water, converted into steam by the great heat, would produce volcanic action. Both theorists seek support for their views from the fact, that the great majority of volcanoes are situated on or near the sea-coast. Geologists accepting also the doctrine of internal heat, and believing that at a depth variously estimated—by some as low as 10 miles, and by others as high as 25 miles—the rocks of the earth are in a state of fusion, explain volcanoes by considering them as connections established between the interior of the earth and the atmosphere; and Darwin, from observations made in all parts of the world, believes that volcanoes are chiefly, and, indeed, almost only found in those areas where subterranean motive-power has lately forced, or is now forcing upwards the crust of the earth, and are invariably absent in those where the surface has lately subsided, or is still subsiding.

Volcanic action is limited to particular regions of the earth. In these regions, the active vents are distributed at intervals, and are generally arranged in a linear direction. The Pacific Ocean is bounded by an almost unbroken line of active volcanoes. Beginning in the New South Shetlands, where there is an active volcano in lat. 62° 55' S., we pass to Tierra del Fuego, and then on to the Andes, which are throughout their whole course volcanic, although the great centres of present action are confined to Chili, Peru, the neighbourhood of Quito, Guatemala, and Mexico. The line is continued northwards by the burning mountains of North-western America, and the Aleutian Islands carry the chain across to Kamtchatka on the Asiatic side. Here turning southwards, the line may be traced through the Kurile Islands, Japan, Formosa, the Philippines, Moluccas, New Guinea, and the Salomon and New Hebrides groups, to New Zealand. From Celebes, a branch proceeds in a north-westerly direction through Java and Sumatra, to Barren Island in the Bay of Bengal; and even beyond this we find a region in Northern India subject to earthquakes, which may lead us, on the one hand, to the volcanic region in Tartary, or, on the other, through Asia Minor to the Greek Archipelago, Sicily, Naples, and

on to the Canaries and Cape de Verde. According to the geological theory, the lines thus traced over the globe would represent rising lands, where the crust is less strong, and so less liable to repress the expansive powers below. There are a number of isolated volcanoes also scattered over the surface of the earth; these are supposed to have opened a star-shaped communication with the interior. The most remarkable of these isolated volcanoes are Jan Meyen, in lat. 70° 49' N.; and those in Iceland in the north, and Mount Erebus in South Polarland, in lat. 77° 32' S.

VOLE (*Arvicola*), a genus of rodent quadrupeds, of a group which some naturalists constitute into a family (*Arvicolidae*), but which is more generally regarded as a tribe or sub-family of *Muridae* (q. v.). This group is characterised by a thicker and shorter form than that of the true rats and mice; an obtuse muzzle; ears of moderate size; a round and hairy tail, not so long as the body; the molar teeth with flat crowns, which present angular enamelled plates. These characters exhibit an approach to the Beaver family (*Castoridae*). The Lemmings (q. v.) belong to this group. The species are numerous, and widely distributed, being found in Europe, Asia, Africa, and North and South America. Some of them are completely terrestrial in their habits, others are aquatic. Many are popularly called rats and mice, as the species of the genus *Arvicola*, which are found in Britain. In this genus, the teeth are only ten in number; two incisors and three molars in each jaw. One of the most common British species is the FIELD V. (*A. agrestis*), also known as the MEADOW MOUSE and SHORT-TAILED FIELD MOUSE. The whole length of the head and body is scarcely more than four inches, that of the tail rather more than an inch and a quarter. The Field V. has a large head, a very obtuse muzzle, ears just appearing above the fur, the thumb of the fore-feet rudimentary, and without a claw. The upper parts are reddish brown, the under parts ash-colour, the feet and tail dusky. It burrows in the ground, or finds a retreat for itself in the excavations of some other animal, as of the mole. It chiefly inhabits low and damp situations, and dry seasons are very fatal to it. It produces from five to seven young at a birth. It is sometimes very injurious to plantations, by destroying the roots of trees and devouring their bark. Excessive numbers of this little animal were regarded in 1813 and 1814 as threatening the destruction of the Forest of Dean, and the New Forest in Hampshire; and many trees were killed; but a remedy was found in digging pits into which the voles fell, and from which they could not escape. The same method has been successfully employed in some of the forests of continental Europe. This species of V. is found in most parts of Europe, and in many parts of Asia. It is common in the Himalaya.—Another very common British species is the WATER V. (*A. amphibia*), popularly known as the WATER RAT, a much larger animal, the head and body being about 8½ inches in length, and the tail 4½ inches. The head is thick and short, the muzzle very obtuse, the eyes small, the ears scarcely seen beyond the fur; the last joint only of the thumb of the fore-feet conspicuous beyond the skin. The fur is thick and shining, of a rich reddish brown mixed with gray above, yellowish gray beneath. Although the feet are not webbed, the Water V. swims extremely well, and not only at the surface of the water, but often under it. It burrows in the banks of streams, ditches, and ponds. Its food appears to consist chiefly of aquatic plants, although it objects to no kind of vegetable food, and has been known to store up potatoes in its burrow for winter. It has been supposed also to feed on worms.

frogs, and small aquatic animals, and to be destructive to the spawn of fish; but this is very doubtful. This species is widely diffused over the continent of



Water Vole (*Arvicola amphibia*).

Europe. There is a black variety of it, common in some parts both of England and Scotland, which has been described as a distinct species (*A. atra*). Several species of *V.* are found in North America.

**VO' LGA**, the most important river of Russia, and the longest in Europe, has its origin in a marshy plain among the Valdai Hills, in the government of Tver; lat. 57° N., long. 33° 10' E. From its source, which is 550 feet above ordinary sea-level, and 633 feet above the level of the Caspian Sea, into which it falls, the river flows south-east to Zubzov, then north-east past Tver and Koliazin to Mologa, where it turns east-south-east, and flows in that direction past Jaroslav, Kostroma, Nijni-Novgorod, and Kazan, 50 miles below which, on receiving the Kama, it turns south, passing Simbirsk, Stavropol, and Samara. Here its course again changes to south-west, and in this direction the river flows until it reaches Tzaritzin, when it bends to the south-east, and reaches the Caspian Sea, which it enters by many mouths, and after a course of 2320 miles. The *V.* waters 9 governments—those of Tver, Jaroslav, Kostroma, Nijni-Novgorod, Kazan, Simbirsk, Saratov, Samara, and Astrakhan; but besides these, 12 other governments are watered by its tributaries. The course of the stream is generally divided into three parts—the upper part reaching from its source to its confluence with the Szeksna, and, though presenting many hindrances to navigation, yet capable of being traversed from Tver to Rybinsk by craft of 1½ and 2 feet draught; the middle part, from Rybinsk in Jaroslav to Nijni-Novgorod, navigable for larger craft; and the lower *V.* from Nijni-Novgorod to Astrakhan—where it is about 90 feet deep—navigable for the largest vessels. Below Astrakhan, the *V.* is very much shallower—in some places only 1½ feet deep. At Tver, the breadth of the river is 720 feet; at Mologa, 2060 feet; at Nijni-Novgorod, 2069 feet, but sometimes in the spring 2½ miles broad; at Simbirsk, about a mile broad; between Samara and Syran, from 1 to 3 miles broad. Below Tzaritzin, at the confluence of the Sarpa, the river affords few facilities for navigation, and is remarkable for the number of branches into which it divides itself before it enters the Caspian Sea. The banks of the *V.*, which are elevated in the upper and middle reaches, become much lower as the river approaches its embouchure. The chief ferries and commercial towns on the *V.* are: Rjev, Zubzov, Tver, Koliazin, Uglitch, Mologa, Rybinsk (the great centre of the corn-trade), Jaroslav, Kostroma, Nijni-Novgorod, Kazan, Simbirsk, Samara, Tzaritzin, and Astrakhan. The system of water-communication established by the *V.* and its tributaries, is of the greatest importance to the

commerce of Russia, connecting as it does the central districts of the country with the White Sea by means of the canal of the Prince of Würtemberg; with the Baltic by the three canal-systems of Tichvin, Vishni-Volotchek, and Mariinsk; with the Black Sea by the Upa Canal, which connects the Oka and the Don; with the Caspian Sea by the great stream of the *V.* itself; and with Siberia by the rivers Kama and Tchussovaia. The principal affluents on the right are the Oka (q. v.) and the Sura; on the left, the Tvertza, Mologa, Szeksna, and Kama (q. v.).

**VOLHYNIA**, a frontier government of West Russia, bounded on the S.-W. by Galicia, and on the W. by Poland, from which it is separated by the river Bug. Area, 27,348 sq. m.; pop. (1870) 1,704,018, mostly Russians, Poles, Lithuanians, Jews, Germans, and Tartars. The surface in the north of the government is low; and plains and morasses, covered with forests, abound; in the south, there are hills, branches of the Carpathian Mountains, but which do not rise higher than 1230 feet. Almost all the rivers flow north, and join the Pripet, an affluent of the Dnieper; a few streams, however, flow west, and join the Bug, by means of which river timber is floated down from this river to Prussia. The soil is sandy or clayey; agriculture flourishes in the south, and corn is exported to Odessa, Galicia, Poland, and partly to Great Russia. Cattle-breeding has always been a prosperous branch of industry in *V.* until recently, but a fine breed of sheep are still reared, and the government possesses the finest studs in the empire—those of the Princes Sangouako and Tzartoriaky. Of the woods, which form the principal riches of the north districts, fir is the chief. The forests abound in foxes, hares, and bears, and hunting is a favourite pastime. Many sugar-mills, cloth-factories, and distilleries are in operation, and the manufactures are increasing yearly. Corn, cattle, sheep, wool, cloth, linen, timber, honey, and wax are the principal articles of trade.

*V.* in early times belonged to the ancient Russians, but was conquered by the Lithuanians and Poles in 1320, and remained in their hands till its annexation to Russia in 1793.

**VOLITION.** See **WILL**.

**VO' LLEY**, the simultaneous discharge of a number of small-arms. The same operation from cannon is called a salvo.

**VOLNEY**, CONSTANTIN FRANÇOIS CHASSEBOEUF, COMTE DE, was born at Craon, in Anjou, on the 3d of February 1757. He was the son of an advocate of good reputation. His family name was Chassebœuf, but on arriving at manhood he assumed the additional surname of Volney. He got his preliminary education at the colleges of Ancenis and Angers, and afterwards went through a protracted course of study at the university of Paris. His father wishing him to join his own profession, he spent some time in preparing for the bar; but he renounced law for medicine, which, however, he never practised. He had inherited a competency from his mother, and, soon after completing his studies, in the year 1783, he set out for Egypt, with the intention of travelling in Egypt and Syria. This expedition occupied him about four years. On his return to France in 1787, he published his celebrated *Travels in Syria and Egypt*, which still contain the most trustworthy as well as one of the liveliest and most interesting accounts which have been published of the tribes with which he came in contact. This work at once procured him a great reputation. At first, there was a disposition to question the veracity of some of his descriptions; but their truthfulness was fully confirmed when the French became more familiar with the Egyptians and the Arabs through

the expedition of 1796. The sagacity of the chief political conclusions to which his residence among these peoples had brought him, which in 1788 he embodied in a pamphlet—*Considerations on the War between the Turks and the Russians*—has also been shewn by subsequent events. In 1790 he was elected to the *Etats Généraux*, as a member for his native district, and took a somewhat prominent part in the political discussions of the years which followed, shewing himself, as he has done in his works, a fast friend of the public liberties, a mocker at all systems of religion, and at the same time a fearless opponent of popular excesses. He was imprisoned for his outspokenness in 1793, and was not liberated till after the downfall of Robespierre, in July of the following year.

In September 1794, V. published his *Ruins; Reflections upon the Revolutions of Empires*, upon which, and upon his *Travels*, his reputation chiefly rests. V. believed that political, like all other organisations, are subject to decay and destruction. The discussions contained in the *Ruins* cover almost all the radical questions in politics. Its principles are those of 1789. It vindicates the doctrine of the rights of man, establishes the duty of toleration in matters of opinion, and maintains, with perhaps too much of sarcasm and mockery, the human origin and the essential falsity of all religious systems. In the previous year, V. had published his *Natural Law*, a catechism for a French 'citizen,' in which he treats morality as a physical and material science, to be studied upon the same methods as the other natural sciences, and having no object but the conservation and improvement of society. This work was afterwards republished under the title of the *Physical Principles of Morality*.

Towards the close of 1794, he was appointed Professor of History in the short-lived *Ecole Normale*; and the brilliant discourses, not untinged with paradox, which he delivered in this capacity, made a sensation in Paris even at that unsettled time. On the suppression of the *Ecole Normale* in 1795, he went to the United States, intending to spend the remainder of his days there; but circumstances made his residence there extremely disagreeable to him, and he returned to France in the spring of 1798. In his absence, he had been elected a member of the Institute; he was, soon after his return, admitted to the Academy; and henceforth his life, though not inactive, was prosperous and untroubled. He had early been acquainted with Bonaparte, and had been of service to him at the time when political circumstances had deprived him of employment; and Bonaparte, on becoming First Consul, desired to associate him with himself in the government as consul or as Minister of the Interior. V. refused both offices, but accepted a seat in the Senate. He protested against the establishment of the Empire, and resigned his seat in the Senate; but his resignation was declined; and during the existence of the Empire he formed one of the little band, sneered at by Napoleon as *idéologues*, who in the Senate attempted by their criticisms to restrain the arbitrary conduct of the emperor. Henceforth, however, his occupations were mostly literary. He published *Researches into Ancient History*, several of the papers contained in which were written in the earlier part of his career; and also several linguistic works, in which he attempted to popularise, and, by means of a universal alphabet, to simplify the study of the eastern languages. He had accepted from Napoleon the title of Count, and the commandership of the Legion of Honour; and upon Napoleon's downfall he was among those who were called to the House of Peers by Louis XVIII. His latest work, published in 1819, was *The History of Samuel*, the

*Inventor of the Sacredness of Kings*. V. died on the 25th April 1820, shortly after completing his 63d year.

**VOLOGDA**, an extensive government of Great Russia, bounded on the E. by the Ural Mountains, and on the N.-W. by the government of Archangel. Area, 151,500 sq. m.; pop. (1870) 1,003,039, chiefly Russians, but comprising also a few Finns, by which race this territory was inhabited in early times. The districts in the east, adjoining the Ural Mountains, are traversed by branches of that chain, which rise to the height of from 3000 to 4000 feet. But by far the greater part of the government is occupied by marshy plains, covered with impenetrable forests. The soil is not fertile, except in the south-west districts, which are the most densely peopled, and produce corn sufficient for local consumption and the supply of the distilleries. In the middle districts, there are comparatively few inhabitants; cultivated land is rarely seen, and hemp is the only crop produced liberally. The wooded morasses of the north are inhabited only by Finnish tribes, engaged in hunting. The banks of the rivers are, as a rule, the only inhabited places. The principal rivers, fifteen of which are navigable, are the Northern Dwina, with its great upper waters, the Suchona, Jug, and Withegoda; and the Petchora, with its affluents. Lakes are numerous. Salt-works, iron-works, and distilleries are in operation; and salt, iron, skins, tallow-candles, and cheeses are exported; and corn and manufactured goods imported.

**VOLOGDA**, a city of Great Russia, in the south-west angle of the government of the same name, of which it is capital, stands on both banks of the river Vologda, 467 miles east of St Petersburg. It is said to have been founded in the 13th c. by settlers from Novgorod, to which principality it belonged down to the 15th c., when it was annexed to Moscow. In 1553, when England opened up a trade with Russia, through the port of Archangel, V. was the great entrepôt for goods deported north by the Northern Dwina; and even yet it exports to St Petersburg and Archangel various products of its own and neighbouring governments, to a considerable amount. Nigello and filigree work are manufactured. Political offenders are sometimes banished to Vologda. Pop. (1867) 17,859.

**VOLSCI**, an ancient Italian people, closely related to the Umbrians. See **UMBRIA**. Their territory was bounded on the W. by that of the Latini, on the N. they marched with the Æqui and Hernici, on the E. with the Samnites, and on the S. they had the sea. Along nearly the whole of their coast lay the Pontine Marshes, while, inland, their territory was somewhat mountainous. The V. were a brave and warlike people, who, frequently in alliance with the Æqui, were incessantly at war with the Romans for upwards of 200 years previous to 338 B.C., about which time they appear to have been finally subdued, their territory incorporated into Latium, and they themselves created Roman citizens. See **LATINI**. These wars were very harassing to the Romans, as they were often carried on not so much by the V. as a whole, as by different cities, each frequently on its own account. Some of the chief towns, and those which took a principal part in the wars, were Antium, Velitræ, Satricum, Privernum, Ulubra, Suessa Pometia, Arxur, and Tarracina, and later Forum Appii and Tres Tabernæ. The legend of Coriolanus (q. v.) is connected with the Volscian wars. See **ROME**, **TARQUINIUS SUPERBUS**, **ANTIUM**. From the time of their final subjugation, their history belongs to that of Rome (q. v.).

**VOLSK**, or **VOLGSK**, a town of European Russia, in the government of Saratov, on the right

bank of the Volga, 80 miles north-east of Saratov. Fat and skins are prepared and exported to St Petersburg, and corn is exported in large quantities to Astrakhan and Rybinsk. The inhabitants are chiefly engaged in the culture of gardens and orchards, and the fruits grown are exported principally to Nijni-Novgorod. Pop. (1867) 26,853.

**VOLTA, ALESSANDRO**, a celebrated Italian physicist, was born at Como, of a noble family, in 1745, and received an excellent education. In 1774, he was appointed Professor of Natural Philosophy at Pavia, and continued to discharge the duties of this chair till 1804, when he retired to his native town, to spend the rest of his days. V., while but a youth, had exhibited considerable taste for letters, and had even written two poems, one in Italian, and the other in Latin; but as he grew older, he abandoned all such pursuits, and devoted himself exclusively to the sciences, especially those connected with electricity. At intervals between 1777 and 1782, he visited Switzerland, Tuscany, Germany, Holland, France, and England, making the acquaintance of the most eminent philosophers of these countries; and on his return is said to have introduced the culture of the potato into Lombardy. In 1796, he was one of a deputation sent to solicit the forbearance of Napoleon; and was received with distinction by the French general, who afterwards invited him to Paris, to exhibit to the members of the Institute, the action of the 'pile' (see GALVANISM), which he had invented, enrolled him in the Legion of Honour, and conferred on him the order of the Iron Crown, with the titles of Count and Senator of the Kingdom of Italy. He was also elected (1801) a Foreign Associate of the French Institute, ten years after he had been made a Fellow of the Royal Society of London. He died at Como, March 5, 1826. V.'s contributions to the science of electricity are of great importance, the chief of them being his theory, in opposition to the 'animal-electricity' doctrine of Galvani, that the electric power resides in the metals; although, in turn, he fell into the error of supposing that the chemical action of the different kinds of metal on each other was only incidental. He also invented an electric battery, consisting of a series of cups arranged in a circle, each cup containing a saline solution, in which were immersed, edgewise, two plates, one of zinc and the other of silver, the zinc plate in one cup being connected with the silver one in the next by means of a wire. This battery was, however, soon after superseded by his 'pile.' He also invented, in 1775, the *Electrophorus* (q. v.); in 1782, the electrical *Condenser* (q. v.), employing with it an electrometer (see ELECTRICITY), in which two straws were employed instead of the gold-leaf strips now in use; and also (1777) the hydrogen-lamp, and the electrical pistol. Most of his important discoveries were communicated by him directly to the Royal Society in the form of Memoirs, which were published in the *Philosophical Transactions* (1782, 1783, 1800); and the Copley Medal was awarded to him in 1794.—A collection of V.'s works was published in 1816 at Florence, under the title of *Collezione delle Opere, &c.*, in 5 vols. 8vo.

**VOLTAIRE (FRANÇOIS-MARIE AROUET, his true name)**—one of the most famous of French writers—was born, according to his own account, as given in later life, on 20th February 1694, at Chatenay, near Soaux. The register of his baptism, however, assigns Paris as the place of his birth, and dates it 21st November of that year. As to which of these statements may be really the correct one, his biographers are not yet fully agreed. His father was François Arouet, a notary of the Châtelet, ultimately

Treasurer of the Chamber of Accounts, his mother, Marguerite D'Aumar, of a noble family of Poitou. Of two sons born to them, François was the younger. He received his education at the College of Louis le Grand in Paris; and on its completion, he was set to study law by his father. But he found this pursuit too disgusting, and speedily quitted it for the career of a man of letters. By his godfather, the Abbé de Châteauneuf, who was very intimate with her, he was introduced to the celebrated Ninon de l'Enclos, and through her to the best French society of the period. In these wicked and witty circles, being himself deficient in neither wickedness nor wit, the young man prospered extremely; and so perfectly unexceptionable was the company in which he found himself, that one day he could exclaim, looking round the table with complacency: 'Are we all, then, either princes or poets?' His father, however, deeply disapproving of the life he led as immoral, and probably not inexpensive, had him sent to Holland with an embassy. Here he became involved in a love-affair of the more respectable kind, which ended, not in marriage, as he seems to have proposed, but in his being sent back to Paris, to resume his gay career. Shortly, it suffered another interruption: on suspicion (unfounded) of his being the author of some satirical verses, reflecting on the government of Louis XIV., then just dead, he was sent to the Bastille (May 17, 1717), where he remained upwards of a year. This time of imprisonment he improved by sketching his famous poem, afterwards published as the *Henriade*, and by finishing his tragedy, *Œdipe*, which was produced on the 18th November 1718, and had so great a success with the public, as not only to delight the author, but somewhat to mollify his old parent, who began to surmise that the despised 'poetry' of his offspring was not unlikely to come to something. The same success did not, however, attend his next ventures: his tragedy, *Artemise*, produced in 1720, was hissed off the stage; and his *Mariane*, which followed in 1724, fared but little better. Meantime, he had again visited Holland, making, on the way, the acquaintance of Jean Baptiste Rousseau, a poet of some importance, then living at Brussels. The two geniuses met as friends, only to part as irreconcilable enemies. Their quarrel is said to have originated in a characteristic *mot* of V., who, his critical opinion being asked of an *Ode à la Postérité*, which Rousseau read to him, had the candour to reply thus: 'Mon ami, voilà une lettre qui n'arrivera jamais à son adresse.' In the summer of 1725 occurred a misadventure, which, for V., had important consequences. At the dinner-table of the Duke de Sully, he resented with spirit an affront put upon him by the Chevalier de Rohan, who, worsted in the war of wit, as most men were likely to find themselves with V., avenged himself some days after by having his adversary thrashed in public by footmen. Subjected to so gross an outrage, V. retired for a time into private life, assiduously perfected himself in the small-sword exercise, and then courteously entreated the Chevalier to a meeting in the *duello*. The Chevalier, as it proved, had small stomach for the encounter; having immortalised himself sufficiently by his insult to the poet, he considered it unnecessary to aspire to the further immortality of being killed by him. Under superficial pretences of accepting the challenge, his practical answer to it came in the form of a *lettre de cachet*, which consigned V. once more to the Bastille. His imprisonment was not on this occasion a long one; but it was only under sentence of exile that he was permitted to issue from durance; and on doing so, he betook himself to England. Some little time previous, the young Arouet had assumed



the name of Voltaire, destined to become so famous. As to the origin of this name, considerable perplexity has existed; but there can scarce be a doubt of the correctness of the conjecture thrown out by Mr Carlyle, in the second volume of his *Frederick*, that it is simply an anagram of Arouet l. j. (*le jeune*).

Arriving in England in 1726, V. remained there upwards of two years. Of this episode of his life, we have only the most meagre account. It is certain, in a general way, that he had the *entrée* to the best English society; he knew Bolingbroke, Pope, and, we need not doubt, many others of the intellectually distinguished. Of his visit to the famous Mr Congreve, and the little skirmish of wit between them, we have express record. It was a whim of Congreve to affect dislike of his fame as an author, as to a certain extent a disparagement of his claims as a person of quality. On his signifying to V. that it was simply as this last he desired that his friends should regard him, he was answered to the effect, that had he been nothing more than the elegant gentleman he considered himself, M. de V. would scarce have thought it worth while to solicit the honour of his acquaintance. To V., his residence in England was fruitful of new knowledge and ideas; in the school of the English Deists, Bolingbroke, Collins, Tindal, Wollaston, &c., he found speculations much to his mind; the philosophies of Newton and Locke he studied diligently; and in his subsequent dramas there may be traced a distinct influence from Shakspeare, whom, however, he has expressly vilified, as a barbarous monster of a writer, intolerable to any reader with the least tincture of orthodox French *goût* in him. Not the less the distinction remains with V. of having been the first Frenchman to recognise in some decisive, if grudging and inadequate way, the essential superiority of our great national poet. The intellectual debt thus indicated was not the only one which V. owed to England. Whilst resident there, he published in a revised form his epic poem, the *Henriade*, a surreptitious edition of which had already appeared in France. The work was dedicated in English to Queen Caroline; the subscription for it was headed by her and other members of the royal family; the rank and fashion of the country could not but follow the illustrious example set them; and for result, V. could convey into his pocket a comfortable sum (stated so high as £8000), which became the basis of his future fortune. From the time of his return to Paris in 1728, he had always on hand some money speculation: investments in corn, bacon, or whatever a pretty penny could be turned by, with now and then a fat army-contract, which a friend might have interest to secure for him; and so shrewd in his finance was he, that, owing but little to his books, which, despite of their immense popularity, were never a source of great profit to him, his income at his death is ascertained to have netted some £7000 per annum, a revenue then to be styled princely. Of his literary labours, from this time forward unremitting, the sum of which remains in something like ninety volumes, no detailed account can here be attempted. His was truly a universal genius; he wrote literally everything—histories, dramas, poems, disquisitions, literary, philosophical, and scientific; novels, for the most part with some doctrinal purpose, of which his famous *Candide*, or the *Optimist*, may stand as the type; his literary correspondence was on an unexampled scale; and he was seldom without some fierce polemic on hand, in which his adversaries had to writhe for the amusement of the public, under the scourge of his envenomed wit.

In the gay society of Paris, he became acquainted

with a certain Madame du Châtelet, who was living apart from her husband, the Marquis, though still on polite terms with him. She was *assez spirituelle*; a most fascinating woman of the world, and in the matter of intellectual accomplishment, the bluest wonder of the period; most especially she was deep in mathematics, and had mastered the mysteries of Newton's *Principia*. As himself an admirer of Newton, V. could not but be charmed to meet him thus surprisingly put into petticoats; nor could a woman so intellectual as Madame fail, in her turn, to appreciate the tender attentions of such a genius as M. de Voltaire. Their intimacy became extreme; and finally, in 1733—the husband of the lady behaving like a philosopher and man of fashion of the time, and continuing now and then to visit them—they went off to prosecute it undisturbed at Cirey, an old château in Champagne, the property of M. du Châtelet. Here, for the most part, they diligently studied Newton together for the next fifteen years. The arrangement seems to have been on the whole a not unhappy one; but towards the close, it became complicated for M. de V. by the advent of another lover, in the person of a Monsieur de Saint-Lambert. It is not conjectured that this gentleman knew anything of Newton, or was at all such a genius as V.; but it is certain that, on some other ground unexplained, he found favour with Madame du Châtelet. The philosophy which the husband had been good enough to practise in favour of V., was now required of himself; and after a little unpleasantness he was able to reconcile himself to the inevitable. This curious triangular love-affair—or *square*, if we include the husband—was not, however, of very long duration. In 1748, Madame du Châtelet died in child-bed. V. was overcome with grief; and the touching reproach which, in the first agony of bereavement, he addressed to the culpable M. de Saint-Lambert, a fortunate chance has preserved for us: 'Eh! mon Dieu! Monsieur, de quoi vous aviez-vous de lui faire un enfant.' This, which is now so shocking, illustrates strikingly the morals of a period in which it seemed entirely *comme il faut*.

To dissipate the sense of loneliness which overpowered him in the loss of his 'divine Emilie,' as he was wont, in his more lyrical moments, to call her, V. once more betook himself to Paris, whence, in 1750, he proceeded to Berlin, on the invitation of the young king of Prussia, Frederick, since known as 'the Great.' Between him and V., much correspondence had already passed; and they seem to have entertained for each other a sincere admiration and regard. When they came together, however, it was found, as so often in such cases before and since, that it is not in the matter of mountains only that 'distance lends enchantment to the view.' They quarrelled bitterly, and parted; V., at his exit from the country, being subjected to indignities which he found it hard to forgive. Into the details of the quarrel we need not enter. When we say that the king was a poet at once most profuse and most execrable; and that the main function of V.—himself a poet—was to criticise and correct his verses, it should almost seem that we indicate, without going further, a sufficient *origo mali*. V. detested the king's verses; the king could hardly have been even the very bad poet he was, without heartily detesting V.'s criticism and corrections. Is it marvellous that in no long time they got heartily to detest each other? A reconciliation was afterwards effected, and their literary correspondence was resumed under the old forms of friendliness; but meantime V. had avenged himself in the amusing but most scandalous chronicle, entitled *Vie Privée du Roi de Prusse*, which was found at his

death among his papers, and published, as there is pretty good reason to suppose the wicked wit meant it should be.

After some years of a somewhat unsettled kind, V., in 1758, established himself along with his niece, Madame Denis, at Ferney in Switzerland, where, with little exception, the last 20 years of his life were passed. During this period, some generous traits of character are recorded of him. Thus, he rescued from extreme want a grand-niece of Corneille the great dramatist, had her carefully educated under his own eye at Ferney, and made over to her the proceeds of an annotated edition of her ancestor's works, which he issued for her express benefit. His noble exertions in behalf of the Calas family, the victims of a shameful persecution, are also well known. In 1778, he was induced by his niece to revisit Paris. By the Parisians, the poet, now in his 84th year, was received with a perfect tumult of enthusiasm, the excitement connected with which is thought to have hastened his death, which took place on 30th May of that year.

With the doubtful exception of Rousseau (Jean Jacques), who in his character of *vates* and enthusiast, was perhaps even more deeply influential, V. is by far the most memorable of the band of celebrated writers whose crusade against established opinions was preparing the grand *culbut* of the French Revolution. As every one knows, it was mainly in the field of religious polemic that his destructive energies were exerted. It is common to stigmatise him as an Atheist, but this is simply to exhibit ignorance. Discarding revelation, he steadily upheld the truths of natural religion, and was, in fact, a Deist pretty much of the English type. As such, he was not a little despised by the more 'advanced' minds of the period, Diderot and the like, who considered belief in a God clear evidence of intellectual infirmity. His favourite weapon was ridicule, and there was never, perhaps, a greater master of it. In a particular form of polished mockery, V. remains almost without a rival. His prose is the perfection of French style; it is admirable in grace, clearness, vivacity, and alive like a sparkling wine with the particular quality of *esprit* peculiar to the people and the language. As a dramatist, V. takes rank as a worthy third with his two great predecessors Corneille and Racine. His most famous poems are the *Henriade*, before mentioned, the one epic of the language, and *La Pucelle*, which is, perhaps, more properly to be styled infamous, such is the profanity and indecency with which the writer has willfully defiled the heroic story of the Maid of Orleans. In the historical works of V., with the utmost lucidity of method, there are traces of a more philosophical treatment than had previously been applied to such subjects. For its narrative charm, his little *historiette*, *Charles Douze*, familiar to every school-boy, is in its kind a perfect model. In English, no full or adequate biography of V. can be said to exist. Of his earlier life, a most racy and amusing sketch will be found in the second volume of Mr Carlyle's *Frederick the Great*; and his relations with Frederick are of course in that work treated of in full, with the writer's characteristic humour and insight. As a critical estimate at once of the man and of the writer, nothing better can anywhere be found than Mr Carlyle's earlier Essay.

In 1866, the first volume of a *Life and Times of François-Marie Arouet, calling himself Voltaire*, by Francis Espinasse, was published by Chapman and Hall; but this work, which promised to ably supply a desideratum, has been left unfinished. See also *Voltaire*, by David Friedrich Strauss (1870); *Voltaire*, by John Morley (London, 1872); and *Voltaire et la*

*Société du XVIII<sup>e</sup> Siècle*, by T. G. Deanoiresterres (8 vols. 1855—1876).

VOLTE'RA, a town of Central Italy, in the province of Pisa, stands on a table-land at the height of nearly 2000 feet above sea-level, 30 miles south-east of Leghorn. It is surrounded by cyclopean walls, which are in a better state of preservation than any structures of the same kind in Italy. The gate called *l'Arco*, and the remains of baths and of an amphitheatre, are interesting vestiges of antiquity; the cathedral, municipal palace, and *Pretorio*, are monuments of the middle ages; and the *Masio*, a prison, is a modern edifica. V. contains a college, numerous schools, and a library of 120,000 vols. Wine, oil, corn, and mulberry trees are grown in the lands belonging to the town, which also possesses considerable mineral wealth. Pop. 6000.

V., the ancient *Volaterræ*, was one of the most powerful and important of all the Etruscan cities, and came into the possession of Rome 474 B.C.; after the fall of the Empire, it suffered much from the invasion of barbarians.

VOLTIGEURS, picked companies of irregular riflemen in the French regiments. They are selected for courage, great activity, and small stature. It is their privilege to lead the attack.

VOLTI SUBITO (Ital. turn quickly), in Music, an indication placed at the foot of a page, to signify that the page ought to be turned without delay.

VOLTURI, a town of Northern Italy, in the province of Genoa, and  $9\frac{1}{2}$  miles west of the city of that name, on the Gulf of Genoa. Its churches are richly adorned; it contains many fine villas, and manufactures paper extensively. Near it are the sulphureous springs and baths of *Aqua Santa*, very efficacious in cases of cutaneous disease. Pop. 6000.

VOLUMETRIC ANALYSIS, in Chemistry, consists in submitting the substance to be estimated to certain characteristic reactions, the chemist employing for such reactions liquids of known strength, and from the quantity of liquid employed to induce the reaction, determining the weight of the substance to be estimated by means of the laws of equivalence. The idea of this method first suggested itself to Gay-Lussac in considering how most readily to determine the amount of silver in an alloy of that metal and copper; but the method itself did not come into general use till within the last twenty years. The liquid reagents of known strength are called *standard solutions*; and the amount employed may be estimated either by weight or by volume, but the latter being the easiest of application, is universally employed; and hence this method of analysis, based on the use of standard solutions, is called *volumetric analysis*. In order that a reaction may be applicable in volumetric analysis, it must satisfy the two following conditions: (1) It must not occupy much time; and (2) the termination of the reaction must be easily recognised and unmistakable to the eye. The necessity that these conditions should be fulfilled, very much limits the number of volumetric processes. In addition to the ordinary chemical apparatus, this kind of analysis requires graduated glass vessels of different kinds for the measurement of the standard solutions. Of these, the most essential are: (1) *Pipettes*, which are glass vessels of the form of figs. 1 and 2, intended for the delivery of the standard solution. Fig. 1 is provided with a single mark upon the neck, while fig. 2 is divided and graduated through its whole length, the division being always made into cubic centimètres (c. c.), according to French scale; (2) *Flasks* graduated for the contents in various sizes from one-tenth of a litre to five

litres, and used for the preparation of standard solutions; (3) *Burettes*, or graduated tubes for measuring the liquids used in an analysis. The burette was invented by Gay-Lussac; but since his time, various modifications have been proposed, the best of which, for general purposes, is that

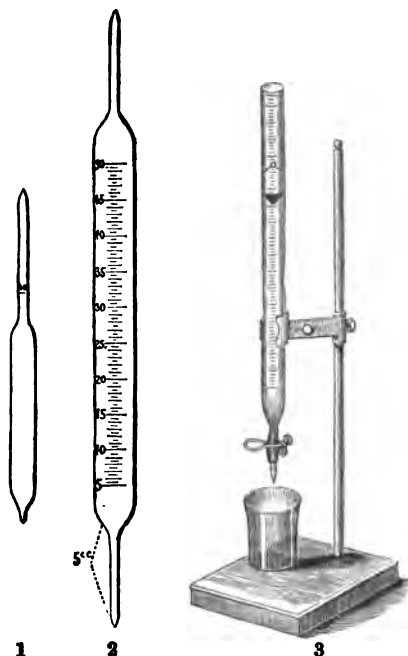

Fig. 1.—A Pipette, containing 10 c. c.  
 Fig. 2.—A Pipette, containing 50 c. c., divided through its whole length in c. c.; being thus graduated for measuring the delivery of fluids.  
 Fig. 3.—a, the india-rubber; b, the slips made of brass wire, by which the india-rubber tube can be closed at will.

which is known as Mohr's Burette. It is shewn in fig. 3; and its lower part is attached to an india-rubber tube and spring-clamp or clip (*Queletch-Hahn*). Its principal advantages over other forms of the instrument are, that its constant upright position enables the operator at once to read off the number of degrees of standard (or test) solution used for any analysis, while the quantity of fluid to be delivered can be most accurately regulated by the pressure of the thumb and finger on the clamp; moreover, as it is not held in the hand, no error is likely to arise in the measurement from the heat of the operator's hand. The greatest drawback to it is that it cannot be used for those test-solutions which decompose india-rubber.

The *standard solutions*, known also as *test* or *titrated solutions* (from the French word *titre*, which signifies the standard of a coin), may be divided into (1) such as are immediately prepared by weighing a substance of known composition, dissolving it, and diluting it to the required volume; and (2) such as are prepared by approximate mixture and subsequent exact analysis. The preparation of the first kind requires no description; for the preparation of the second kind, we must refer to the article 'Analysis, Volumetric,' in *Watts's Dictionary of Chemistry*, vol. i. p. 259, where the method is fully explained, and as an example, the preparation of a standard solution of sulphuric acid containing t

grammes of hydrated sulphuric acid in 1 litre is given. It is obviously essential that the greatest care must be taken both with respect to the graduation of the measuring instruments and the strength and purity of the standard solutions, which must be protected from evaporation and other hurtful influences by being kept in bottles of 1 or 2 litres' capacity, provided with well-ground stoppers.

Volumetric methods are usually classified as follows, according to the principles on which they are based—(1.) *Analysis by saturation*, when the quantity of a base or an acid is measured by the quantity of acid or base which is required for exact saturation—a point to be determined by test-papers, tincture of litmus, &c. (2.) *Analysis by oxidation and reduction*, when the quantity of the substance to be determined is found by the quantity of chlorine, bromine, iodine, or oxygen to which it is equivalent (regarded as oxidant), or by the quantity of chlorine, bromine, iodine, or oxygen which it requires to pass from a lower to a higher stage of oxidation. The chief oxidising agents are permanganate of potash and bichromate of potash; while the reducing agents chiefly used are protoxide of iron and hyposulphite of soda. (3.) *Analysis by precipitation*, when the determination of a substance is effected by precipitating it in some insoluble and definite combination. Our limited space does not admit of our giving an example of more than one of these forms of analysis, and from its historic interest we shall select the last, in its application to the determination of silver. We shall borrow Mr Sutton's account of this process. 'Suppose,' he observes, 'that it is desirable to know the quantity of pure silver contained in a shilling. The coin is first dissolved in nitric acid, by which means a bluish solution containing silver, copper, and probably other metals, is obtained. It is a known fact that chlorine combines with silver in the presence of other metals to form chloride of silver, which is insoluble in nitric acid. The proportions in which the combination takes place are 35.5 of chlorine to every 108 of silver; consequently, if a standard solution of pure chloride of sodium is prepared by dissolving 58.5 grains of the salt—i. e., 1 eq. sodium (= 23) plus 1 eq. chlorine (= 35.5) or 1 eq. chloride of sodium—in so much distilled water as will exactly make up 1000 grains by measure, every single grain of this solution will combine with 0.0108 of a grain of pure silver to form chloride of silver, which precipitates to the bottom of the vessel in which the mixture is made. In the process of adding the salt solution to the silver, drop by drop, a point is at last reached when the precipitate ceases to form. Here the process must stop. On looking carefully at the graduated vessel from which the standard solution has been used, the operator sees at once the number of grains that have been necessary to produce the complete decomposition. For example, suppose the quantity used was 520 grains; all that is necessary to be done is to multiply 0.0108 grains by 520, which shews the amount of pure silver present to be 56.16 grains.' By volumetric as compared with ordinary analysis, a large amount of time, labour, and therefore of expense, is saved; at the loss, however, often of due accuracy, unless the greatest care be taken that the standard solutions are of due strength, and the instruments accurately graduated. An analysis can thus be completed in a quarter of an hour, that would formerly have occupied a day or more. Independently of its application to pure chemistry, it facilitates to a great extent the chemical analysis of urine (on which subject see the English translation of Neubauer and Vogel *On the Urine*, published by the New Syd. Soc.), of waters (on which see Parkes *On Hygiene*), of manures, soils, &c.; and its processes

## VOLUNTARY CONVEYANCE—VOLUNTARIYISM.

have been freely introduced in the British Pharmacopœia. The standard book on this subject is that of Mohr, a German chemist; the English reader may consult the text-books of Scott of Dublin, and Sutton of Norwich, and various Memoirs in the *Chemical News*.

**VOLUNTARY CONVEYANCE** is, in Bankruptcy and other proceedings, a conveyance which is made without any legal consideration, either of money or of marriage; and in competition with creditors having deeds made for consideration, is often deemed fraudulent, and is generally postponed or set aside altogether.

**VOLUNTARIYISM**, the principles or system of polity distinctive of those who advocate the separation of church and state; the cessation of state endowments and state grants for religious purposes, and, in general, of all interference, patronage, or exercise of authority on the part of the civil power in the religious and ecclesiastical affairs of the subject. The terms *Voluntarism* and *Voluntary* have been in use since the date of the keen discussions regarding civil establishments of religion—commonly called the 'Voluntary Controversy'—which sprung up in the second decade of this century between churchmen and dissenters, in Scotland; and they serve to suggest, not inappositely, the fundamental conception which underlies the creed of religious dissent, that all true worship, or acceptable service in religion, must be the free expression of individual minds, and that, therefore, religion ought to be left by civil society to mould itself spontaneously according to its own institutions and spiritual nature, without violence to individual freedom from any interposition of secular authority or compulsory influence. *Voluntarism* seeks to define more accurately the limits of civil power by defining more adequately than preceding theories had done the latitude due to the movements of religion. Assigning the magistrate his proper sphere, it is equally careful to assign the church and the individual their appropriate spheres of responsibility and duty in reference to religion, within which they may work unchecked, in full harmony with all the claims of civil order. *Voluntarism* may be regarded as the formula of advanced Protestantism, the corrected doctrine of church and state, which the failure of the experiment of national churches has forced on public thought. It is a protest in modern language against the encroachment of the temporal power, whether under the name of magistrate, nation, or political majority, on the rights and liberties of individual conscience. *Voluntarism* has sometimes been erroneously considered the offspring of theological neutrality. On the contrary, its leading advocates base it on the expressed law of Christ respecting the constitution, administration, support, and extension of the church, as well as on the rights of conscience, the nature of civil government, and considerations of general equity and policy. In its most extensive sense, *Voluntarism* embraces the whole question of the province of the magistrate in reference to religion and the church. *Voluntaries* admit that magistrates as well as other men, being under law to God, ought so to execute the proper duties of their office that all shall be done in consistency with the paramount claims of morality and religion. At the same time, the nature and design of civil government excludes their authority from the domain of religion and conscience, and confines it to the secular concerns of individuals and of society. Magistrates, like other men, are under obligation to seek and to follow the highest available light and guidance in duty; but it is not

therefore allowed them to convert the rules of the Divine Word, which are addressed exclusively to the individual conscience, into laws for civil society. God alone being lord of the conscience, such laws only—though revealed in His Word—may be adopted and enforced in civil society as are requisite for its outward preservation, peace, and good order, and for the advancement of those secular interests which are the proper care of its rulers. While, therefore, magistrates, no less than other men—and for reasons common to all favoured with the Gospel—ought, as individuals, to embrace and profess the Christian religion, and to employ wisely and justly the influence arising from their circumstances and station, it is no part of their political or official duty, or of the homage required of them by Christ, to emit, adopt, prescribe, or enforce a confession of faith; neither is it within their province to aim at establishing or propagating Christianity by the civil arm, to provide for, endow, or subsidise its teachers either in churches or schools; but it is their duty impartially to protect all their subjects, of whatever creed, in the enjoyment of full religious liberty, so long as their manner of exercising this civil right does not infringe on the equal rights of others. On this ground, and with such qualification, it is their duty to abstain from all interference with the jurisdiction and economy of the church—not excepting the matter of its support—which being regulated, as *Voluntaries* believe, by special ordinances of Jesus Christ, its Head, it is an invasion of His prerogatives, and a frustration of His law for its support and extension, to place, or suffer to be placed, on the footing of a civil establishment. The doctrine regarding the support of religion has always been an important article in the *Voluntary* creed, and, in a restricted sense, *Voluntarism* has been popularly defined by this doctrine. Negatively, the duty of providing for the support of Christian institutions does not lie with the magistrate or nation. The giving of property for the support of the gospel has been elevated by *Voluntarism* from the position of an almost eleemosynary and political custom, to the rank of a systematic obligation and a financial law of the church. It is recognised as an act of religion, the duty and privilege of all Christians; and as each man is a steward of his silver or gold, responsible to none but its great Owner for his disposal of it in religious matters, the magistrate can possess no right to demand from him any portion for religious uses, or to apply to these uses the proceeds of taxation imposed for general ends. Civil society being promiscuous and variable in its constituents, a fixed arrangement for the endowment of religious bodies out of the public funds, is a fixed usurpation—as a system of occasional grants is an occasional usurpation—upon the liberty and property of all who dissent. The existence of an absolute unanimity among the subjects—even were it possible, as it would be otherwise, to ascertain and secure it from time to time—however it might remove for the moment from any minds the feeling of political grievance incident to such arrangements, could neither justify them as a policy, nor alter their character as an interference with religion in its economics. In its broad aspect, as an overstepping of the sphere of magistracy, all who restrict the magistrate, on whatever specific grounds, to secular affairs, must deem such interference objectionable; and *Christian Voluntaries* would reasonably ask, why legal machinery should be employed to gather the offerings which, in the state of public sentiment supposed, must be flowing unforced through their natural channels? and in particular, whether, if Christ has not appointed the magistrate to 'tithe and toll' for his church, society can presume to

assign him a work beyond his province? There is a manifest division of duties dictated alike by reason and revelation; and Voluntarism claims the results of experience as proof of the entire want of adaptation in the compulsory or magisterial power to deal with the support of a living religion. To burden the rent-roll, increase the assessments, distract the goods and chattels of citizens, or even to preserve the forms of legal exaction for such a purpose, are measures which it is hard to believe either politic, scriptural, or just. The pecuniary supplies required for religious objects are to be secured, according to Voluntarism, solely through the operation of moral influences and sacred motives. Truth, as well as error, must be left to provide for itself. The responsibility and privilege of providing for the support of Christianity having been attached by Christ to His church, it is further His law that its institutions shall be maintained and extended by the voluntary liberality of its friends. A primary obligation rests on those enjoying the services of a pastor to provide according to their ability for his maintenance, on the apostolic principle—'Let him that is taught in the word communicate to him that teacheth in all good things;' while, on the equally apostolic principles, that the labourer is worthy of his hire, and that the strong should aid the weak, a mutual and collective responsibility remains with the general membership, to supply each other's ecclesiastical necessities, and to unite in measures that may provide an adequate remuneration to the pastors or other ministers of the church. Civil establishments of religion, together with all forms of state endowments and grants for religious purposes, are thus condemned by Voluntaries as human expedients, adverse to Christian development and the working of the law of self-support, which alone draws forth the resources, and educates the consciences and habits of the people. Inadmissible, as introducing the compulsory element into the free and delicate movements of Christian society, and intruding magistracy into a sphere which the history of all struggles for the higher liberty teaches must be preserved to the individual and the church, these institutions tend to foster political dependence and class-feeling among the recipient bodies, and prevent those relations of honourable trust and responsibility which best unite pastors and people. These views express what may be called ecclesiastical Voluntarism. On the question of education, various shades of opinion exist among Voluntaries. All are agreed that the religious education of the young belongs to the parent and the church, and is not to be provided or superintended by the state. How to secure this principle in connection with a system of national schools or government grants for education, continues to be the problem of Voluntaries. Some seek the solution in a plan of local boards representing the parentage and community, who shall manage the schools, and decide the character of the teaching; and of these, some advocate separation of the hours for religious and secular lessons. Others, who think that while by these methods state superintendence may be avoided, state aid is yet directly or indirectly received for religious instruction, would accept a system which provided simply for schooling in secular or common branches. Those known as Voluntary educationists reject the idea of any national system, some on account of the religious difficulty, and others on grounds connected with the philosophy of education and the theory of government. Voluntary educationists would leave the education of the poor to be secured by the operation of those influences which originate and sustain other necessary and benevolent measures. The education of the children of classes not

necessitous they expect to flow from private enterprise and free association. Voluntaries consistently object to grants to denominational schools dependent on the condition of teaching religion, to grants to ragged schools and all semi-religious institutions, as well as to the appointment and payment by the state of chaplains for prisons, the army, &c. In reference to the Sabbath, holding the sacred character of the day, some Voluntaries appear to admit that the magistrate is both entitled and bound not only to make it a *dies non* in his own department, but also to prohibit labour and amusements throughout the nation. Others, equally holding the morality of the day, with more regard to strict theory, deny him the power of inflicting pains and penalties, however mild, in a matter radically religious, at the same time that they assert the obligation of the state to secure all its members due protection and facility in the practice of their worship, and to make such laws for this end as may be fit, in view of prevailing religious observances. Regarding national fasts and thanksgivings, most Voluntaries hold that the style of authority in which royal proclamations appointing these have usually been expressed is objectionable, as assuming a right to prescribe the topics and language of devotion, and to regulate its seasons, and insist that the language of invitation should be substituted for that of command. Some, while ready to comply with an invitation of the sovereign to join in an offering of prayer on occasions they judge suitable, do not allow that it forms any part of magisterial duty to issue such appeals, or that the royal act imparts a national character to the service. Ordinary political acts become national when done by the proper national organs; but no religious acts can acquire a national character except they are participated by the body of the people. When this is the case, the exercise is national, though not evoked by the call of the chief of the state, and it is not made more national by that call. The advantage of simultaneousness and unity is attainable on the widest scale by the natural concert of churches apart from royal initiative, which, if it may be followed when right, need not be waited for as indispensable to true national worship. On the question of marriage, Voluntarism, recognising its character as a civil transaction, demands that all religious parties stand on the same level in regard to it. Withholding legal sanction from all immoral connections, and punishing breaches of the lawful contract, magistrates are not warranted to visit with penalties any mere departure from the standard prescribed to Christian conscience, or embodied in ecclesiastical law. Political Voluntarism, as it is sometimes called, is simply Voluntarism expressed in the language of the politician—the doctrine of the entire religious equality of all citizens in the eye of law, stated and defended without reference to specific religious opinions, and in the way of appeal to principles generally received.

**VOLUNTEERS**—the great defensive citizen-force of Great Britain, in some degree corresponding to the National Guard of continental states. It is essentially self-supporting, and wholly unpaid; although government arms the men, and contributes a certain sum towards the corporate expenditure. The oldest volunteer corps is the 'Honourable Artillery Company' of the city of London, which dates from the reign of Henry VII.: although still called artillery, it comprises artillery, cavalry, and infantry, and is probably the oldest armed body in Europe. When the country was in dread of invasion by Bonaparte, almost the whole available male population flew to arms as volunteers, and in 1803 they mustered 463,134 effectives. About this time,

## VOLUNTEERS.

George III. reviewed 150,000 volunteers. The force gradually diminished, when the immediate danger ceased; and before the war closed, they were replaced by a new force, called the 'local militia,' which was supposed to be more thoroughly amenable to government control. As early as 1857, two small volunteer corps, the 1st Devon and the Victoria Rifles, had sprung into existence; but in 1859, the whole nation seemed to awake to a sense of insecurity, with a comparatively small army, half of which was abroad, amid the enormous armaments of neighbouring states. In a few months, 150,000 men had organised themselves into companies; and in the following year, government, which had at first shewn no favour to the movement, gave it a helping hand by combining the companies into battalions, by appointing paid adjutants and drill instructors, and by the establishment of a staff of inspectors under the control of an Inspector-general of Volunteers. The volunteers numbered, in 1876—1877, 168,750 efficient, in a high state of training, and capable of performing in a very satisfactory manner all the simpler military manœuvres. They are divided into a small number of Light Horse, Mounted Rifles, and Engineers, a force of 30,000 Artillery, and quite an army of about 128,000 Rifemen. Where 60 men can be got together, a company of volunteers may be formed, which is entitled to a captain and two lieutenants or sub-lieutenants for its officers. If a place is populous enough, and sufficiently zealous in the cause, to produce a corps of two companies, the senior officer becomes 'captain commandant.' Four companies make a major's command. Six are sufficient to constitute a battalion, for which government provides an adjutant, hitherto an old military officer, but in future an army captain, who receives 10s. a day besides his forage. When there are a number of detached companies in the different villages of a district, they are grouped into an administrative battalion (or brigade for detached batteries of artillery), with an adjutant, and with qualified field-officers. England and Scotland are further divided into military districts, each commanded by a general officer, who commands and inspects all forces of whatever kind within his district, his constant endeavour being to keep the corps in his district up to the standard of efficiency. Every company may have an honorary assistant-surgeon; but a corps of two companies is entitled to an assistant-surgeon; of four companies, to a surgeon, who may have one assistant when there are six companies, and two for eight or more companies. If a corps exceed a strength of twelve companies, it is customary to divide it into two battalions. The volunteer corps were originally raised under an act of 1804; but the circumstances of modern times having rendered various supplementary enactments necessary, the whole were embodied in a new act, the 26 and 27 Vict. cap. 65 (1863), under which, and the 'Regulation of the Forces Act, 1871,' and under Orders in Council issued from time to time, the volunteer force of Great Britain is now constituted.

All officers are appointed by the crown, except sub-lieutenants, who are nominated by the lord-lieutenant of counties; the non-commissioned officers are appointed by the officers commanding. Adjutants and sergeant instructors are at all times subject to the Mutiny Act—the other officers (and men) are subject to it only when their corps is embodied; but the Queen can at any time deprive them of their commissions. Offences within corps, in time of peace, are punishable by fines or otherwise, as laid down in the rules of the several corps, which must have the approval of the Secretary of State for War. Every volunteer on joining

must take the oath of allegiance, and must be of the age of 17.

The force may not be used in times of civil disturbance, but may be embodied for active service anywhere in Great Britain, whenever the country is invaded, or invasion is apprehended by the crown. The occasion must first be communicated to parliament, or, if parliament be not sitting, to the country, by an order in council, and then the crown may direct the general commanding in districts to call out any or all of the volunteer corps in their respective commands for active service. Corps so called out come under the Mutiny Act, and are bound to march whithersoever the general may command. While embodied, officers and men are entitled to the same pay as in the regular army. In point of precedence, volunteers rank with, but after, the same ranks in the army and militia. The yeomanry are reckoned as part of the volunteers. Among themselves, the volunteers rank in the following order: 1st, Light Horse; 2d, Artillery; 3d, Engineers; 4th, Engineers and Railway Transport Corps; 5th, Mounted Rifles; 6th, Rifles.

Members of a corps are honorary and enrolled. The first are merely subscribers of a certain amount; they are entitled to wear the uniform, but not to interfere in any manner in the corps. The enrolled members are the actual working-men; they are classed as 'efficient' and 'non-efficient'—the efficient being those who are certified by the commanding-officer and the adjutant to have a competent knowledge of the duties of the service, and to have attended the following number of drills:

ARM.	For Recruits during a period not exceeding Eighteen Months preceding the date of the Annual Return.	For others during each Twelve Months.
Light Horse, .	19 squad or troop drills.	9 troop drills, 3 of which have been drills of the whole corps.
Artillery Volunteers, Engineers, . .	30 drills, of which 24 are gun-drills. 12 engineering and 24 other drills.	12 gun-drills. 6 engineering and 9 other drills.
Mounted Rifles,	19 drills.	9 drills, of which 3 of the whole corps.
Rifle Corps, .	30 drills.	9 drills, of which 3 at least battalion drills.

The assistance afforded by the public to volunteer corps consists in the supply of adjutants; and of sergeant-instructors in the proportion of 1 to a corps of three companies or less, 2 from 4 to 7 companies, 3 up to 12 companies, &c. The money aid is a *capitation grant* of 30s. annually for each volunteer who is efficient, including officers, in addition to which there is a special grant of £2, 10s. for each officer and volunteer sergeant who holds a certificate of proficiency (for which a severe examination has to be passed). In scattered administrative battalions, a charge of 5s. for each efficient is allowed to cover the cost of attending battalion drills. These allowances are, however, none of them personal, but are granted to corps, to be expended by the adjutant, who is accountable to the War Office, within certain limits, according to the discretion of the commanding-officer. Government likewise provides all the arms, and a certain quantity of practice-ammunition. Corps are allowed to choose their own uniform, subject to the approval of the lord-lieutenant; but no gold lace or gold buttons may be introduced among these citizen soldiers. Volunteer corps do not bear colours. The system has not yet been extended to Ireland.

**VOLUTE**, in Architecture, the spiral ornaments of the Ionic and Corinthian capitals, probably derived from Assyrian architecture, in which it is also used.



Voluta.

ture notched in front, plaited; no operculum. The animal has a very large foot, and a recurved siphon. The species are numerous, and abound chiefly in tropical seas. Many of them have very beautiful shells, much prized by shell-collectors. Several small species are found on the shores of Britain, of which *Voluta tornatilis* is the only one that is not rare. This genus makes its appearance in the Cretaceous strata, and increases in numbers in Tertiary deposits, no less than 50 species being known in the Pleistocene beds.



Shell of *Voluta tornatilis*.

**VO'LVOX**, a genus of minute organisms, the type of a family called *Volvocineæ*, now regarded as vegetable, and ranked among *Protophytes*, but which were at first supposed to be animals, and were reckoned by Ehrenberg among *Infusoria*. They are globular, or nearly so, are found in stagnant water, and move slowly through the water, revolving round an axis, by the agency of numerous little filaments which project from green points on their surface. It was on account of their motions that they were formerly thought to be animalcules, and, partly on the same account, it has been suspected that they are not really protophytes, but *zoospores* of some kind of algae. This opinion, however, is rendered improbable by their apparently possessing the power of reproduction; green granules being formed within the parent globe, at first adhering to its wall, and afterwards becoming detached; the parent globe finally bursting, to allow them to escape. These frequently exhibit, even whilst within the parent globe, a rotatory motion similar to its own. The presence of starch in the interior of the *Volvocineæ* has been detected by means of iodine, and is regarded as a conclusive proof of their vegetable nature. The most common and best-known species is *Volvox globator*, which is just visible to the naked eye. It is a transparent sphere, having its surface studded with innumerable green spots, united by a beautiful net-work. From six to twenty young are often to be seen in its interior.

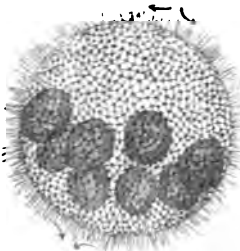

*Volvox globator*.

**VO'LVULUS** (Lat. *volvere*, to twist) is the term used in Medicine to signify a twisting of the intestine, producing obstruction to the passage of its contents. There are three distinct varieties of

rotatory movement capable of giving rise to volvulus—(1.) A portion of intestine may have become twisted on its own axis, and, in that case, even semi-rotation brings the intestinal walls into contact, so as to close the passage. This is a rare condition, and only occurs in the ascending colon. (2.) The Mesentery (q. v.), or a part of it, may be twisted into a cone, dragging the intestine with it; the mesentery being the axis, and the intestine being rolled up upon it. This form occurs in the small intestine. (3.) A single portion or a coil of intestine may afford the axis round which another portion, with its mesentery, is thrown, so as to compress it, and close the passage. A coil of small intestine, the sigmoid flexure or the cæcum (see DIGESTION, ORGANS or), may form the axis. All these varieties occur chiefly in advanced life, and their seat is commonly towards the posterior unyielding wall of the abdominal cavity, the smoothness and yielding nature of the parts anteriorly rendering such an event almost impossible. The symptoms of twisting of the intestines, especially of the sigmoid flexure, which is the most common seat of the affection, are usually very well marked from the beginning. Great pain is suddenly experienced in a small circumscribed spot of the abdomen, obstinate constipation usually setting in from that date. If the sigmoid flexure, which lies just above the rectum, is the seat of the twisting, the abdomen soon becomes distended, especially on the left side, the distention being much more marked than when the twist is in the small intestine, as might physiologically have been expected. Vomiting, often constant and copious, is usually present. These cases are so desperate in their nature, that it is needless to enlarge upon their treatment. Attempts to remove the displacement by injecting water or air into the intestine by means of a long tube, have often been made, but with very slight success. Mr Pollock, in his article on 'Disease of the Alimentary Canal,' in Holmes's *System of Surgery*, remarks, that 'relief in twist of the sigmoid flexure is just possible without opening the abdomen, provided the long tube be introduced into the distended gut, its contents drawn off, and the twist be reduced by the altered position of the bowel. But no operation for the ultimate relief of the patient will be successful unless the intestine be unloaded first, and the twist then reduced.'—Vol. ii. p. 158. The operations that have been proposed for the relief of this and other intestinal obstructions are so often fatal, and, even when successful, leave the patient in so wretched a state, with an artificial outlet for the discharge of the contents of the bowels, that it is doubtful whether they should be recommended. It is simply a choice between almost certain death in a few days, and a possible chance of a prolonged (but usually a miserable) existence. There are, however, a few rules that should be universally known and attended to—viz., wherever symptoms such as we have described occur, aperients should only be given by the rectum, while opium should be freely given by the mouth. Leeches and hot fomentations should be applied to the seat of pain; and all solid food should be prohibited, the nourishment being given solely in the fluid form.

**VOMER**, a bone which, in the human skeleton, forms part of the middle partition of the nose, and the lower edge of which fits into grooves between the apposed surfaces of the palatine processes of the upper jaw and palate-bones. It exhibits many modifications in the different classes of *Vertebrata*. Its position is indicated in the figure of *Archetype Vertebrate Skeleton*, in the article SKELERON. It is specially noticed here because of the frequent occurrence of the term vomer in articles on fishes—a very important character being often found in the

## VOMITING—VONDEL.

presence or absence of teeth on the vomer, that is, along the middle line of the roof of the mouth.

VOMITING consists in the stomach emptying itself through the gullet and mouth. It is preceded by a feeling of nausea, a flow of saliva in the mouth, and the breaking out of perspiration; the countenance grows pale, a feeling of weakness spreads over the whole body, and the pulse becomes slow. At last the muscles of the abdomen and the diaphragm strongly contract, and the whole contents of the stomach are ejected with greater or less violence. The first matters to be ejected are the food and drink present, then mucus from the stomach and œsophagus, and lastly, bile from the duodenum. In cases of disease, abnormal substances are sometimes vomited, such as blood, fragments of the intestines, and even excrementitious matters. When the vomiting is over, it is followed by languor and drowsiness, or, if the excitement was inconsiderable, the usual state immediately returns.

The causes of vomiting are various. In the first stages of infancy, it is almost normal, and occasions no disturbance of the system. In many animals, too, it is a normal function of life, as when birds of prey reject the hair and feathers of their victims. The infant gets rid of the superabundant milk it swallows by throwing it up with no trouble. Some persons can excite themselves to vomit by swallowing air.

The immediate causes of vomiting may be reduced, according to Dr Carpenter, to the three following categories: (1.) The contact of irritating substances with the mucous membrane of the stomach itself; these, however, cannot act by direct stimulation upon more than its own muscular coat; and their operations upon the associated muscles must take place by reflexion through the nervous circle furnished by the pneumogastric and the motor nerves of expiration. (2.) Irritations applied to other parts of the body, likewise operating by simply-reflex transmission; as in the vomiting which is consequent upon the strangulation of a hernia, or the passage of a renal calculus; or in that which is excited by the injection of tartar emetic or emetin into the circulating current, when these substances probably produce their characteristic effect by their operation on the nervous centres. (3.) Impressions received through the sensorial centres, which may be either sensational or emotional, but which do not operate unless they are felt. In this mode seems to be excited the vomiting that is induced by tickling the fauces, which first gives rise to the sensation of nausea; as well as the vomiting consequent upon disgusting sights, odours, or tastes, and upon those peculiar internal sensations which are preliminary to sea-sickness. The recollection of these sensations, conjoined with the emotional state which they originally excited, may itself become an efficient cause of the action, at least in individuals of peculiarly irritable stomachs, or of highly sensitive nervous systems.—*Principles of Human Physiology*, 6th ed., p. 77.

According to the oldest doctrine respecting vomiting, it was held to arise solely from convulsive movements of the stomach, which was thought to take on a motion contrary to the usual peristaltic motion. Bayle advanced the opinion, that the stomach is quite passive in the operation, and that its contents are emptied entirely by its being compressed through the contractions of the abdominal muscles and the diaphragm. An apparently conclusive experiment of Magendie's, in which the stomach was removed, and a bladder substituted for it, had more recently (in 1813) satisfied most physiologists as to the passiveness of the stomach in vomiting, until Bécord and Budge shewed the

insufficiency of his experiment. It is found, in fact, that in vomiting there are two sets of actions, viz., (1) contractions of the abdominal walls, while the diaphragm remains fixed, and forms a support to the stomach, and (2) the stomach itself performs jerking movements, the pylorus, or inferior orifice, at the same time closing, while the cardiac sphincter relaxes, without which last-named action vomiting is impossible; and that either of the two kinds of movement—the abdominal or the stomachal—may eject the contents of the stomach into the gullet.

In the treatment of vomiting, we must consider it as a symptom rather than as a malady. Where the stomach is irritated, relief is afforded, according to circumstances, by drinking cold water, aerated or soda water, or, if necessary, by opium or nuxvomica. Cold applications outwardly also do good. In other cases, infusions containing ethereal oils—camomile, coffee, &c.—astringents, or correctives for acidity—magnesia, soda, &c.—are the fitting remedies. When the irritation is in the brain, the best remedy is a horizontal position, with composure and darkness. If a person in sound health is suddenly seized with vomiting, poisoning may be suspected.

VONDEL, JOOST VAN DEN (pr. *Yves*), the greatest Dutch poet, was born at Cologne, November 17, 1587, his parents, who were Anabaptists, having fled from Antwerp to avoid persecution. His maternal grandfather, Peter Kranen, ranked among the poets of Brabant. When freedom began to raise the head in Holland, the elder Vondel removed with his family to Utrecht, and afterwards to Amsterdam, where he prospered in trade. The poet's education in boyhood was limited to reading and writing, but his perseverance and love of study enabled him in after-life to become intimately acquainted both with ancient and modern literature.

At the early age of 13, his poetical efforts were praised by Hooff. In his 23d year, he married Maria de Wolf, to whose clever management V. chiefly left his business as a hosier, while he devoted himself to study and poetry. The tragedies of V. are very numerous, and the grandest specimens of Dutch literature. His satirical writings and epigrams are full of fire, energy, and spirit. One of his most remarkable pieces is *Lucifer*, published in 1654, strikingly resembling Milton's *Paradise Lost*, which appeared thirteen years later. V. took an earnest and active part in favour of the Remonstrants, Grotius and Oldenbarnevelt, drawing down on himself the anger both of the clergy and court, whom he attacked with the keenest satire.

*Gysbrecht van Aemstel*, *Adam in Banishment*, *Palamedes*, *The Batavian Brothers*, *Solomon*, *Samson*, *Adonijah*, *Noah*, or *the Destruction of the Old World*, *Mary Stuart*, &c., are splendid efforts of genius. *The Harpoon*, *The Horse-comb*, and the *Decretum Horribile* are stinging satires on the ruling powers both in church and state. V.'s translations from the Greek and Roman writers are numerous, the *Metamorphoses* of Ovid having been rendered into Dutch verse when he was 84 years old. V. left no subject untouched, no measure untried. His works (9 vols. quarto) contain many sea-songs, and more than 100 odes. Many of the later poems were written with a strong Roman Catholic spirit, he having joined that church about 1640. Through the imprudences of his son, to whom he had given his business, V. fell into straitened circumstances, and in 1658 accepted a situation in the City Pawn-broking Office. In 1668, the magistrates allowed him to retire with his salary of 650 guilders yearly, which kept him above want. He was of moderate stature, well made, and had an eagle eye. After his powers of body and memory had begun to fail, he could still read without glasses. He died calmly



on the 5th of February 1679, at the age of 91, and was carried to his resting-place in the new church, Amsterdam, by fourteen poets, himself Princeps Poetarum.

VOPADEVĀ is a celebrated grammarian of India. He wrote a grammar entitled *Mugdhābodha*, which is held in high repute, especially in Bengal, and was commented upon by *Durgadāsa*. (Both text and commentary have been edited at Calcutta in 1861; previous editions contain merely the text of V.'s grammar.) It differs from the great work of Pānini (q. v.) in its arrangement as well as in its terminology; and without the commentary of *Durgadāsa*, would not yield by far the information that may be derived from Pānini's grammar. It is valuable, however, on account of many later Sanscrit formations, that could not be contained in the older work. V. composed also a catalogue of Sanscrit *dhātus*, or so-called radicals, in verse, called *Kavikalpadrūma* (published at Calcutta, 1848), and a commentary on it, the *Kāvya-kāmadhenu*. Another grammatical work, the *Rāmāyān-karān'a* is likewise attributed to his authorship. According to a general tradition prevalent in India, V. would also be the author of one of the most renowned Purān's (q. v.), the *Bhāgavata-Purān'a*; and in a little treatise, the *Durjanamukha-chapet'ikā*, or 'a slap on the face of the wicked,' which is averse to this tradition, and maintains that Vyāsa (q. v.) was the author of this Purān'a, three other works of a religious character are assigned to V.—viz., the *Paramahansapriya*, *Muktāphala*, and *Haritūlā*. A little medical work, the *S'atas'lokachandrikā*, though written by a Vopadeva (see Professor Aufrecht's *Catalogue of the Sanscrit MSS. of the Bodleian Library*), does not seem to belong to the author of the works just mentioned. The date of V., given by some as the 12th, by others as the 13th c. after Christ, is, according to Burnouf's investigation, the second half of the 13th century.—See E. Burnouf's Preface to his edition, and French translation, of the first nine books of *Le Bhāgavata Purān'a*, vol. i. (Paris, 1840).

VORANT, in Heraldry, a term applied to an animal represented as swallowing another; as, sable, a dolphin naissant, vorant a fish proper.

VORONEJE, or VORONETZ (pronounced *Voronezh*), a government in the south of Great Russia, bounded on the S. by Little Russia and South Russia. Area, 25,712 sq. m.; pop. (1870) 2,152,696, consisting of Russians and German colonists. It is watered by the Don, its two navigable tributaries, the Voroneje and Koper, and other streams. The soil, mostly a black mould, is generally fertile, and great crops of grain—wheat, rye, barley, oats, and millet (which supply the inhabitants and local distilleries, and are exported)—are produced. Cattle and horses of a good breed are reared—the best studs belong to the crown. The principal manufactured articles are brandy, beer, cloth, beet-root, sugar, skins, wax-candles, soap, tobacco, and potass; and corn, tallow, hemp-seed, cattle, and horses are exported to Moscow, St Petersburg, &c.

VORONEJE, a town of Great Russia, capital of the government of the same name, stands on the right bank of the Voroneje, 150 miles south-west of Tambov. It was founded in 1586 as a bulwark against Tartar invasion. Peter the Great, who had previously visited the town, built a fortress and a dockyard here in 1694. Besides two cathedrals, the town has many important civil, ecclesiastical, and educational institutions. The commerce of V. is extensive—the chief articles of trade being corn, hemp-seed, and tallow. Pop. (1867) 41,592.

VORTEX (Lat. a whirlpool). Till lately, it was

a reproach to Hydrodynamics that the theory of vortices or eddies in fluids had not been properly brought under the domain of mathematical analysis. Even now, the problem has only been partially solved by the labours chiefly of Stokes (q. v.) and Helmholtz (q. v.), as their beautiful investigations apply only to *perfect fluids*, that is, fluids which oppose no frictional resistance to change of shape. In ordinary motions of perfect fluids, such as currents and waves, the instantaneous change of shape of a small spherical portion makes it an ellipsoid by simple extensions and compressions *without rotation*. The essential characteristic of vortex-motion is, that it involves rotation of some parts of the fluid. Helmholtz has shewn that this rotational or vortex-motion remains with the parts of the fluid which first have it, and cannot be transferred. We can conceive no process by which vortex-motion could be given to, or taken from, a perfect fluid; for to our reason fluid friction (which does not exist in a perfect fluid) would seem to be indispensable. On such abstruse subjects we cannot of course enter here; but one result of Helmholtz's investigations is so curious that we must mention it. We are all familiar with those singular smoke-rings which are produced when a mortar is fired; or when, on a smaller scale, a bubble of phosphuretted hydrogen takes fire in air, or a smoker skilfully emits a puff of tobacco-smoke. A very simple mode of producing them, on even a large scale, is to bore a hole in one side of a box, remove the opposite side, and substitute a cloth or sheet of india-rubber for it. A slight blow on this membrane ejects a vortex-ring from the hole. To make this vortex visible, we may burn phosphorus or moistened gunpowder in the box; or still better, sprinkle its interior with ammonia, and introduce a vessel containing common salt and sulphuric acid. The sal-ammoniac cloud which fills

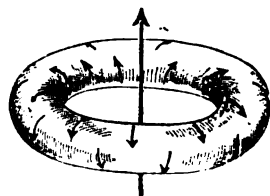

Fig. 1.

The general character of these rings, or vortex-tubes, is shewn in the diagram (fig. 1); which indicates that, besides a progressive motion as a whole, the ring revolves about its own central or medial line. Suppose two such rings to follow each other, with their planes parallel, and their centres moving in the same line, Helmholtz shews that (at least in a perfect fluid) the foremost will relax its speed, and spread out into a larger ring, while its follower will contract, and quicken its pace, till it passes through the other, which in turn becomes the pursuer, and so on. This very curious result may be realised in a tea-cup, by drawing the half-immersed bowl of a tea-spoon along the surface of the tea for a short way, and withdrawing it. Two little whirlpools, or vortices, are then seen moving side by side. They are sections of the half vortex-ring which has been formed in the liquid by the spoon. A second half-ring may be at once sent after them by another stroke of the spoon, and the phenomenon above described will be obtained. When, on the contrary, two such vortex-rings meet, their centres moving in one line, they both spread out, and relax their speed indefinitely. This is obtained in a liquid by letting the half vortex-ring impinge directly on the side of the vessel, when it spreads out, and relaxes its speed; just as if there were no boundary of the fluid, but a second

## VORTICELLIDÆ—VOSGES MOUNTAINS.

vortex-ring occupying the place of the image of the first which would be formed by a plane mirror substituted for the side of the vessel. When one vortex-ring impinges obliquely on another, it rebounds from it, and both are thrown into vibration, their form of equilibrium being circular. They act in fact in this respect like solid india-rubber rings. By forming them from an elliptic aperture, they are produced in a state of vibration. A square aperture gives them in a different state of vibration.

The impossibility of producing or destroying vortex-rings in a perfect fluid—save by creative power—has led Sir W. Thomson (q. v.) to regard

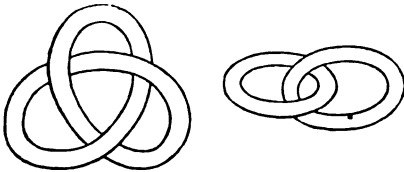
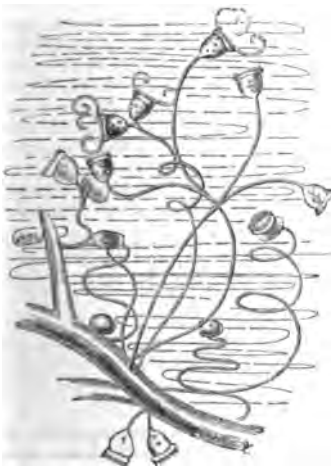

Fig. 2.

the ultimate parts of matter as vortices of various kinds in a perfect fluid. Two such indestructible vortex-atoms are here sketched (fig. 2).

The word vortex has also come into use in connection with Descartes's once celebrated theory of the universe, given in his *Principia Philosophiæ*. In this the rotation of the planets about the sun, the satellites about the planets, &c. were explained (!) by the hypothesis of vortices for ever whirling about the central body. Descartes was a good mathematician, but in *Natural Philosophy* he preferred metaphysics to experiment, and of course erred enormously. But he is not to be laughed at: mistakes more ridiculous than his are gravely propounded at the present day.

**VORTICELLIDÆ**, a family of *Infusoria*, remarkable for beauty, and containing a great number of species, to which, from their form, the name of *Bell* or *Bell-flower Animalcules* is often given. The genus *Vorticella* consists of minute cup-shaped or



Group of Bell-flower Animalcules (*Vorticella nebulifera*):  
Very highly magnified.

bell-shaped creatures, each placed at the top of a long flexible stalk, the other end of which is attached to some object, as the stem or leaf of an

aquatic plant. Around the edge of the bell or cup is a fringe of rather long cilia, the motion of which brings food to the mouth. The stem is flexible, and is sometimes stretched out to its full length, sometimes contracted in a spiral form. The contraction takes place instantaneously upon any alarm, the cilia at the same time vanishing; and it is very interesting to watch a group of *Vorticella*, which may often be easily done with a Coddington lens, when they adhere to the inside of the glass of an aquarium. The stem is often beautifully branched, the *Vorticella* becoming a compound animal, like many zoophytes, and the whole contracts or is extended at once. The stem, slender as it is, is a tube, through the whole length of which runs a minute muscular thread. A cup or bell of a *Vorticella* sometimes develops a new fringe of cilia at its point of junction with the stem, becomes detached from the stem, and begins to move freely through the water, till it finds a new place on which to fix itself, reproduction thus taking place by gemmation. Reproduction also takes place by encapsulation. See INFUSORIA. To the family V. belongs the genus *Stentor*, having a trumpet-shaped body, and therefore receiving the popular name of Trumpet Animalcules. They swim freely through the water, at the same time rotating on an axis, and attach themselves to objects by a sucker at the lower or narrow end. They have a fringe of cilia round the mouth, and the body of some species is covered with cilia. They are very voracious. They may often be found adhering to a twig or the stem of an aquatic plant, collapsed into minute masses of green jelly.

**VOSGES**, a dep. in the north-east of France, formed out of the south part of the old province of Lorraine, is bounded on the N. by the departments of Meuse and Meurthe, and on the E. by Alsace-Lorraine. Area, 2266 sq. m.; pop. (1872) 392,988. The surface is mountainous, the territory being traversed not only by the Vosges Mountains, which run along its east border, but also by the Faucilles Mountains, which cross the dep. from east to west. The chief rivers are the Moselle, and its tributaries the Meurthe, Madon, and Mortagne, all of which flow in a north or north-west course through this department. The mountains in the east are covered with vast forests of beech and fir, and at the base of the mountains are tracts of pasture or rolling infertile plains. The west part of the dep., called the *Plaine*, is very fertile in cereals, vegetables, and fruits. Among the hills, the climate is cold; on the *Plaine*, it is humid. About 4,400,000 gallons of wine are produced annually. Mineral riches abound, there being iron, lead, copper, cobalt, and antimony mines. Of the kind of cheese called *Géromé*, 23,600 cwts. are made annually. The dep. is divided into the five arrondissements, Épinal, Mirecourt, Neufchâteau, Remiremont, Saint-Die. The capital is Épinal.

**VOSGES MOUNTAINS** (Lat. *Vogesus*, Ger. *Vogesen* or *Wargau*), a range of mountains in the north-east of France and the west of Germany, run from south to north, on the left bank of the Rhine, from the borders of the departments Haute-Saone and Doubs, north to Mainz, and separates Alsace from the French departments of Vosges and Meurthe and the German Lorraine. The range runs parallel with the Schwarzwald or Black Forest in Baden and Württemberg, on the right bank of the Rhine, and forms the western border of this part of the Rhine basin. The summits are rounded and regular in outline, and are called *ballons*. The chief of them are the Ballon de Guebwiller, 4690 feet; le Hobeneck, 4429 feet; and the Ballon d'Alsace, 4101 feet. They

are covered with forests, and abound in rock-salt, silver, copper, lead, and coal.

VOSS, JOHANN HEINRICH, one of the foremost classical writers of Germany, was born in 1751 at Sommersdorf in Mecklenburg, of poor parents. In 1772, he went to the university of Göttingen, and there joined the 'Hainbund,' an association of young poets, at the head of whom stood Bürger and Boje. V. first intended to devote himself to theology, but soon exclusively turned to Greek and Roman antiquities, under Heyne's auspices. In 1778, he went from Wandsbeck, whither he had gone for the purpose of editing the *Musenalmnach*, to Otterndorf, in Hadeln, where he prepared his translation of the *Odyssey*. This appeared in 1781, and was received with universal applause. In the next year he became rector of Eutin, whence, in 1789, he issued his German translation of Virgil's *Georgica*. This was followed, in 1793, by a new and revised edition of the German *Odyssey* and *Iliad*, which, however, did not meet with as favourable a reception as the first. His contests with Heyne (q. v.) gave also rise chiefly to his *Mythological Letters*, which appeared in 1794. Among his purely German poetical works, *Luise*, an Idyll (1783, revised 1795), takes a foremost place. In 1799, he issued the whole of Virgil in a German translation. In 1802, he went to Jana, where he wrote the celebrated review of Heyne's *Iliad*. In 1805, he was called to Heidelberg, where he wrote annotated German translations of Horace, Hesiod, Theocritus, Bion, Moschus, Tibullus, and Lygdamus. In 1821, he published a translation of Aristophanes, and a new edition of Horace and Virgil. Among other literary labours must also be mentioned his translation (with the aid of his two sons) of Shakspeare's works, which, however, is very inferior to Schlegel's. In opposition to Creuzer's *Symbolik*, he wrote an *Antisymbolik* (1824), in which he lifted up his voice against exaggerated praises of heathen mysticism; and one of his last papers was a violent denunciation of his former friend Stolberg, who had turned Roman Catholic. He died at Heidelberg in 1826. Among his translations from modern languages may be mentioned that from Galland's *Arabian Nights*, and that of Shaftesbury's works. A brief mention may also be made of his two sons: (1) HEINRICH, born 1779, a philologist of merit, who assisted his father in his Shakspeare translation, and who was a great friend of Jean Paul's. He had intended to edit the latter's works, but died before him, in 1822. (2) ABRAHAM, born at Eutin, Professor of the Gymnasium at Kreuznach, who completed the Shakspeare translation. He died in 1847.—See Paulus, *Lebens- und Todeskunden von J. H. Voss* (Heidel. 1826).

VOSSIUS, GERARD, one of the most distinguished scholars of the first half of the 17th c., was born of Dutch parents near Heidelberg, where his father was a Protestant minister. His father's name was John Voss, but he, after the fashion of the time, had Latinised it into Johannes Vossius, and hence his son called himself Gerardus Johannis V., that is, Gerard, the son of John. In 1678, the family returned to Holland, and settled at Dordrecht, where V. went to school. He afterwards distinguished himself at the university of Leyden; and when 22, he returned to Dordrecht, to become the principal of the school, of which he was the most distinguished pupil. He married shortly afterwards, but his wife died in 1607, leaving a family of three children. In the same year, he again married, and by his second wife he had two sons and five daughters. In the earlier part of his life, V. does not appear to have published much, but he became known to his countrymen as a scholar and theologian; and his assiduity

in study may be inferred from the fact that he would never allow a friend to stay with him more than a quarter of an hour. In 1614, he became principal of the theological college of Leyden, and while holding this appointment, published a work on Pelagianism (*Historia Pelagiana*). In it he spoke of the Arminians in an apologetic tone, and thereby brought down upon himself the wrath of a large section of the Dutch clergy; which caused him to be deprived of his office in the theological college, and of the income derived from it. His work had attracted attention in England, and it was some compensation to him that he received from Archbishop Laud an office which brought him £100 a year without its being necessary he should live out of Holland. Chiefly, it appears, to secure the means of supporting his family, he retracted the opinions he had expressed, in his book *De Historicis Latinis*, published in 1627, and he became reconciled to the church. In 1633, he was appointed Professor of History in a new university at Amsterdam, where he seems to have devoted himself to the completion of the great works on which his fame rests. Among the most important of these not mentioned above were: *Aristarchus sive de Arte Grammatica, Libri VII.*; *De Historicis Græcis, Libri IV.*; *Comen-tariorum Rhetoricorum sive Oratoriarum Institutionum, Libri VI.*; *De Veterum Poetarum Temporibus, Libri II.* In 1649, V. was climbing the ladder of his library when it broke; he fell under the shelves and books, and died of the injuries he received.

The children of V. were remarkable for beauty, accomplishments, and learning. Grotius said of V. in epigrammatic Latin, that it was doubtful whether by his books or his children he had contributed most to adorn the age. Five of his sons, Denis, Francis, Gerard, Mathew, and Isaac, are known as authors.

VOSSIUS, ISAAC, a scholar and theologian, was the only son of Gerard Vossius who survived him. He was born at Leyden in 1618. When 21, he published an edition of the *Periplus* of Scylax, the Greek geographer, with a Latin translation and notes. He afterwards travelled in Italy, collecting valuable manuscripts. In 1648, he took up his abode at the court of Queen Christina of Sweden; but in 1658, in consequence of a quarrel with Salmasius, he returned to Holland. In 1670, he came to England, and here, although he openly scoffed at religion, he was appointed by Charles II. a canon of Windsor, and had apartments assigned him in the Castle. He died there in 1688, and it is recorded that on his deathbed he refused to take the sacrament, until one of his colleagues argued that he ought to do so for the honour of the chapter. His works are numerous, but not so important as those of his father.

VOTERS, ABDUCTION or, is an offence punishable by fine or imprisonment, and by a penalty of £50 besides, which may be sued for by an informer. The offence is included under the head of undue influence, and by the 17 and 18 Vict. 102, s. 5, is defined to be, the directly or indirectly making use of, or threatening to make use of, any force, violence, or restraint, in order to induce or compel such voter to refrain from voting at any election.

VOTIVE (Lat. *votivus*, given in virtue of a vow; Fr. *votum*, a vow), in ecclesiastical use, signifies the class of actions, offerings, or memorial records or observances, which are intended either as the fulfilment of a vow, or as a commemoration of the accomplishment of the prayer which accompanied the vow. Of such votive engagements there are numerous examples in the Old Testament (Levit. xxii. 18, Deut. xii. 6), as well as in the ancient

religions of the Gentile world; and the ecclesiastical historian Theodoret (*De Osr. Græc. Affect.*, i. 8) alludes to the practice in his own day of hanging up, in the churches dedicated to the saints, little models of hands, feet, eyes, &c., in votive commemoration of the cure of lameness, blindness, and other maladies supposed to have been obtained through their intercession. The same practice continued throughout the succeeding centuries and throughout the medieval period, and still prevails in Roman Catholic countries, especially in Italy and Southern Germany. Votive offerings, often of very considerable value, may be seen in the churches of most of the great Sanctuaries (q. v.), and in other churches in special repute as places of devotion. The offering very frequently takes the form of a votive tablet, with an inscription detailing the event on which it is founded. Sometimes the offering is simply marked with the words *ex voto*, 'in fulfilment of vow'; sometimes it is accompanied by a model in wax, in wood-carving, or even in precious metals, similar to those alluded to by Theodoret; and occasionally by a model of some object, which is meant to recall the memory of the favour received, as of a ship, in case of escape from shipwreck, &c. Many of the great churches, hospitals, monasteries, and other religious monuments of the middle ages and of later times, were built *ex voto*; and the treasures of most of the rich cathedrals and other churches abroad contain objects of great value, the result of votive engagements on the part of the donors. The name *votive* is also applied in the Roman Catholic Church to the mass or other service, when it is celebrated—as is permitted on certain days and in certain seasons—not according to the rite prescribed for the day itself, but according to a rite selected by the celebrant himself from a number of such 'votive masses' and 'votive offices,' as 'of the Passion,' 'of the Holy Trinity,' 'of the Blessed Virgin Mary,' &c., which are contained in the Missal and Breviary.

**VOUSSOIRS**, the individual stones forming an arch, and of which the central one is the keystone. They are always of a truncated wedge-form.

**VOW** (Fr. *vow*, from Lat. *votum*), a promise made to God of a certain thing or action good in itself, and within the dominion and right of the person promising. The practice of vows appears to have formed part of the religious observances of almost all races in any degree civilised; and it largely pervaded the whole ceremonial system of the Mosaic dispensation (Gen. xxviii. 20, Lev. xvii. 2, 1 Chron. [I Paralip. Vulg.] xxix. 9, 2 Chron. xxxi. 6, Judges xi. 30, Num. xxx. 2, Judith xvi. 19, Jon. i. 16). The stringency of the obligation of fulfilling a vow when once made, is distinctly laid down (Deut. xxiii. 21; Eccles. v. 4, 5); but it is equally clearly stated, that it is by no means a matter of obligation to make a vow (Deut. xxiii. 22). The practice of making vows continued among the Jews in the time of our Lord; and St Paul, after his conversion to Christianity, continued to conform to this usage (Acts xviii. 18). It would be out of place to enter here into the question, whether this observance was meant by our Lord to form part of his new dispensation, or to discuss how far the practice of vows, especially of chastity, can be traced as in use among the Christians of the first and second century; but it appears quite clear that in the end of the third, and all through the fourth, the monastic life became general in the East, and soon afterwards spread all over the church. See ANTONY, PAUL, MONACHISM. It is unnecessary to add, that vows, while discarded as a religious observance by the Reformers, enter largely into the system of the Roman Catholic

Church. The objects of these engagements among Catholics are very various; but they are drawn, for the most part, from what are called the evangelical 'counsels,' in contradistinction to 'precepts' or 'commands'—the most ordinary subject of vows being the so-called 'evangelical' virtues of poverty, chastity, and obedience. Pilgrimages, however, acts of abstinence, or other self-mortifications, whether of the body or of the will, special prayers or religious exercises, are frequently made the object of vows; and there is another large class of more material objects, as the building of churches, monasteries, hospitals, and other works of public interest or utility, to which medieval Europe was indebted for many of its most magnificent memorials of piety and of art. Vows in the Roman Church law are either 'simple' or 'solemn.' The principal difference between them consists in the legal effects of the 'solemn' vow, which, where the subject of such vow is chastity, renders not merely unlawful, but null and void, a marriage subsequently contracted. A 'simple' vow of chastity makes it unlawful to marry, but, except in the Jesuit Society, does not invalidate a marriage, if subsequently contracted. Catholics acknowledge in the church a power of dispensing in vows; but this is held to be rather declaratory than remissory, and it is not acknowledged in the case of vows which involve any right of a third party. Bishops are held to possess the power of dispensing in simple vows generally; but the power of dispensing in solemn vows and in certain simple vows, as, for example, that of absolute and perpetual chastity, and of the greater pilgrimages, is reserved to the pope. The practical operation of the canon law regarding vows has evidently been much modified, even in Catholic countries, since the French Revolution, and the subsequent political changes; but this must be understood to regard chiefly their external and purely juridical effects. So far as concerns their spiritual obligation, the modern Roman theology recognises little if any change.—See Ferraris, *Bibliotheca Canonica*; André, *Cours de Droit Canon*; Welter and Wetse's *Kirchen-Lexicon*.

**VOWEL**. See LETTERS.

**VR'IHASPATI**, or, as the word is written in Vedic works, **BR'IHASPATI** (from *br'ih*, probably hymn, prayer, and *pati*, protector, lord), is, in Vedic Mythology, the guardian of the hymns or prayers addressed by the pious to the gods, and he is therefore considered as mainly instrumental in insuring the efficacy of the sacrifice. In consequence, he is 'the first-born in the highest heaven of supreme light,' because the prayers reach him first; he is 'seven-faced,' because his faces are the seven Vedic metres; and he is 'attended by all the companies of gods,' or 'represents all gods,' when the sacrifice is performed. Being thus the 'first sharer of the offering,' he is sometimes also identified with *Agni*. His function of guardian of the hymns being similar to that of a priest and spiritual teacher, he is further represented as a priest of the gods, who himself 'celebrates worship;' as 'the observer of truth,' and as imparting 'virtuous instruction. In the epic and Puranic mythology, V. figures especially as preceptor of the gods and R'ishis, and as such he also causes them to perform sacrifices. A new character, however, in which he appears at that period is that of regent of the planet Jupiter; and in the ceremonies performed in honour of the planets and described in several Puran'as, a special worship is paid him in this capacity.

**VR'ITRA**. See **INDRA**.

**VU'LCAN** (the name is probably connected with *fulgere* and *fulgur*, and may be translated the 'bright

or shining one') was the old Italian god of fire. The various myths in connection with V. prove the great antiquity of his worship. Latterly, the character, attributes, and history of the Greek Hephaestus were transferred to V., and the two thus became identified. According to Homer Hephaestus was the son of Zeus and Hera; later accounts, however, asserting that the latter gave birth to him without any co-operation on the part of her husband. He appears to have been twice violently expelled from Olympus—the first occasion was shortly after his birth, when he was dropped upon the earth by his mother, who was disgusted with his sickly deformity; he was received by the marine divinities, Thetis and Euronyme, with whom he dwelt for nine years. He afterwards returned to Heaven, and on interfering in a quarrel between his mother and Zeus, the latter seized him by the leg, and flung him from Olympus. After falling for a whole day, he alighted on Lemnos, where he was kindly received by the Sintians. He afterwards returned to Olympus. Homer makes him lame from his birth, while later writers attribute this



Vulcan.

defect to his second fall on Lemnos. The popular notion of V. or Hephaestus appears to have been that of a burly, lame, good-natured, awkward god, often made the butt and laughing-stock of his fellows. He had a magnificent palace of his own in Olympus, 'immortal, brazen, shining like stars,' in which was his workshop, containing an anvil and 20 bellows, which worked at his command. Later accounts locate his workshop in the interior of some volcanic isle, such as Lemnos, Lipara, Sicily, &c., and give him as workmen the Cyclopes, Brontes, Steropes, &c. Many wonderful works of art are ascribed to V. by the ancient poets, and as an artist or artificer, he appears to have been regarded as corresponding in some respects to Athene: both instructed men in the useful and ornamental arts, had the power of healing, &c., and at Athens, had temples and festivals in common. In the *Iliad*, the wife of Hephaestus is Charis; while in the *Odyssey*, and in later writers, he is represented as being much tormented by the amours of his frail and charming spouse Aphrodite, with her favourite Ares (Mars). In the earlier statues, his lameness appears to have been indicated; but latterly, he was represented as a full-grown, vigorous man, with a beard.

**VULCANISM**, a term proposed by Humboldt to include all the evidences of internal heat, such as volcanoes, hot springs, &c.

**VULCANITE AND VULCANISED INDIA-RUBBER**. See CAOUTCHOUC.

**VULGATE** is the name of the Latin translation of the Bible, which is the received version in the

Roman Catholic Church. It must not be confounded with the older Latin translation known as the Itala (see ITALIC VERSION). While Jerome was engaged in correcting the Itala, he conceived the plan of producing a completely new version of the Old Testament, done from the Hebrew text itself. He commenced this labour about 385 A.D., and completed it in 405. He also made an improved version of the Italic New Testament, and the two together received the name V. The discrepancies between the V. and the Itala, which had been made from the LXX., were so numerous and important, that the charge of heresy and falsification of Scripture was openly preferred against the translator by Rufinus, and even St Augustine was doubtful for some time whether this charge might not be true. But gradually it made its way in the church, first in Gaul, then in Rome—chiefly through Gregory the Great—and finally throughout the West. About two hundred years after Jerome's death, it became the universally received version of the church. Not long, however, did it exist in its pure and unadulterated form. Partly through the influence of the emendated Itala, partly through the manifold general causes of neglect, hastiness, and the rest, which have gone so far to spoil almost every ancient MS., the text of the V. had become so corrupted, that in 802, Charlemagne commissioned Alcuin to revise it by old MSS., and to compare it with the original texts. This revision, however, to which afterwards came other 'emendations,' in the 11th and 12th c. (by Lanfranc, Archbishop of Canterbury, and Cardinal Nicolaus respectively), completely changed the original character of the work. Nor did the 'Correctoria Biblica' (i. e., certain collections of commented and revised texts, issued at the period), do much for the improvement of the corrupted MSS. The confusion between the different codices was chiefly remarked, when the Tridentine Council, in 1546, first declared the V. the authorised version of the Roman Church, and decreed the preparation of an authenticated edition. In 1564, the Papal Chair undertook the task; but not before 1590 did Sixtus V. produce the work. This, however, turned out to be so utterly incorrect and faulty throughout, that the copies were speedily suppressed; and another edition, which appeared in 1592, was prepared under Clement VIII., to which in the next year (1593) that other edition succeeded, which has since remained the normal edition of the Church of Rome, and has been reprinted unchanged ever since. We may add, that the Anglo-Saxon translation of the Pentateuch and Joshua, by Aelfric (10th c.), has been made from the V., and not, as has been erroneously supposed, from the Septuagint; and that the V. has also been repeatedly translated into Arabic (the Psalms even into Persian) for the use of the Roman Catholics in the East.

**VULNERED**, a heraldic term, applied to an animal, or part of an animal—as, for example, a human heart, wounded, and with the blood dropping from it. A pelican in her piety (see PELICAN) is sometimes described as vulning herself.

**VULTURE** (*Vultur*), a Linnsean genus of rapacious birds, now forming the family *Vulturidae*, to almost all the species of which the name V. is popularly given. The *Vulturidae* have a longer beak than the *Falconidae*, and it is straight at the base, slightly or not at all toothed, the upper mandible longer than the lower, and hooked at the tip, the head generally bare, or covered only with a short down, which in most of the species is the case also with the neck—a ruff or collar of soft feathers surrounding the lower part of the neck, into which

the upper part, and even most of the head, can be withdrawn. The legs and feet are large, but the claws are not nearly so large and strong as in the *Falconidae*, and are but slightly hooked. The middle toe is very long. The wings are long, and their expanse consequently great. Vultures have great powers of flight, and many of them soar to a very great height in the air. Their plumage is not the neat and regular appearance of that of the *Falconidae*, but it is dense, and not easily penetrated by shot. Vultures are mostly found in warm climates, and many of them are inhabitants of



King Vulture (*Vultur papa*).

mountainous regions. They feed on carrion, which it seems to be their office in nature to remove from the face of the earth, that the evil consequences of its corruption may be prevented. They seldom attack a living animal, but they have been seen to sit and watch the approach of death, waiting for their feast. They are not in general courageous birds, and are often put to flight by birds much smaller than themselves; yet, if unmolested, they readily become familiar with the presence of man, and some of them seek their food even in the streets of towns, in which they are useful as scavengers. They gorge themselves excessively when food is abundant, till their crop forms a great projection, and sit long in a sleepy or half-torpid state to digest their food. They do not carry food to their young in their claws, but disgorge it for them from the crop. The bareness of their head and neck adapts them for feeding on putrid flesh, by which feathers would be defiled; and they are very careful to wash and cleanse their plumage. The question has been much discussed, whether vultures discern dead animals by the eye, or are attracted to them by the smell. It is certain that they possess great powers both of smell and of vision, and the reasonable conclusion appears to be that both are of service in directing them to their prey. The rapidity with which they congregate to a carcass has been remarked with admiration, and vast numbers have often been seen assembled on a battle-field to devour the dead.

The *Vulturidae* are divided into several genera, of which one, *Gypaëtus*, approaches to the *Falconidae* in its characters and habits, having the head feathered, and not always feeding on carrion, but often attacking living animals. The *Lämmergeier* (q. v.) is one of this group. The feet are feathered to the toes, whilst the other vultures have the tarsi bare.

Some of the most notable species of *V.* have already been described, as the Condor and the

Egyptian Vulture. The generic name *Vultur* is now restricted to those which have the head and neck without feathers and without caruncles, and a ruff of long feathers or of down at the lower part of the neck. To this genus belongs the TAWNY *V.*, or GRIFTON (*V. fulvus*), found in the south of Europe, the north of Africa, and the west of Asia. It makes its nest on the most inaccessible rocks of high mountains, as in the Alps and Pyrenees, and sometimes in tall forest trees. It is a very large bird, more than four feet in length. Its plumage is yellowish brown, the quills and tail-feathers blackish brown, the down of the head and neck white, the ruff white. When it has found a carcass on which to feed, it remains on the spot, gorging and torpidly resting by turns, till no morsel remains. This *V.* has been seen in England, but only as an accidental visitor. The mountains and forests of the south of Europe, as well as of the north of Africa, and great part of Asia, are also inhabited by the CINEREOUS *V.* (*Vultur* or *Gyps cinereus*), another large species, which departs from the typical character of the vultures in having the greater part of the neck feathered, and compactively large and powerful claws. It does not, however, attack living animals. India, Africa, and almost all warm countries, abound in vultures of different species, which it is unnecessary to describe. In the southern states of North America is found the BLACK *V.* (*Cathartes atratus*), there generally known as the CARRION CROW, a comparatively small species, not quite two feet in entire length, of a deep black colour, the head and neck covered with warty excrescences, and a few hair-like feathers. This bird is also very abundant in many parts of South America, where it is called the GALLINAZO. Very nearly allied to it, and found in the same regions, is the TURKEY BUZZARD, or RED-HEADED *V.* (*Cathartes aura*). These vultures are more or less gregarious,



Turkey Buzzard (*Cathartes aura*).

not only assembling where food is to be found, but flying in flocks. They make their nests in hollow trees, and sometimes in the chimneys of deserted houses, or on the roofs of houses. In some of the towns of tropical America, they may be seen in great numbers, perched during the heat of the day on the tops of houses or on walls, asleep, with their heads under their wings. The CALIFORNIAN *V.* (*Cathartes Californianus*) is the largest rapacious bird of North America, being fully four feet long, and about ten feet in extent of wings. It is black, with a white band on the wings. It is found only on the western side of the Rocky Mountains. It much resembles the condor in its habits.

VYĀSA is the reputed arranger of the Vedas (q. v.), and the reputed author of the Mahābhārata (q. v.), the Purānas (q. v.), the Brahmasūtras (see VEDĀNTA), and a Dharmasāstra. According to tradition, he was a son of the sage Parāśara and Satyawatī, 'the truthful,' who was a daughter of King Vasu, and a heavenly nymph, Adrikā. Another tradition makes him also the father of Dhṛītarāshṭra, Pānḍu, and Vidura. On account of his dark complexion, he was called Kṛishṇa (black); and because he was born in an island (*dvīpa*) of the Yamunā (Jumna) river, his second name was *Dvāpāyana*. That the immense bulk of literature comprised by the above-named works, and relating to different periods, cannot belong to the authorship of one and the same personage, is no matter of doubt. But the name itself of the individual to whom it is attributed conveys the meaning which must be sought for in some of the legends connected with his history. *Vyāsa* (from the Sanscrit *vi* and *as*, literally, 'throw in different directions,' hence 'distribute') means the person who arranges a subject-matter in a diffuse manner, or the act itself of such a diffuse arrangement, and is often contrasted with *samāsa* (from *sam* and *as*, contract), the act of making a concise arrangement, or of abridging (compare the Greek *omēro*, from *om* = *sam* = *sum*, and *ar* = *as*). *Vyāsa* is, therefore, a symbolical

representation of the work of generations, as embodied in the Vedas, the Mahābhārata, and the Purānas, and of the order which gradually was brought into this literary mass. When, therefore, the Vāishṇava-Purāna speaks of 23 Vyāsas who in the reign of the present Manu arranged the Vedas, it is not impossible that some historical truth may underlie this statement, implying, as it does, a different arrangement of the Hindu scriptures at various times: and that the Mahābhārata, and the Purānas too, may have undergone various arrangements and recensions, until they settled down in their present form, sufficiently results from their contents. Regarding the Brahmasūtras, tradition itself seems only loosely to connect their author with the Vyāsa of the foregoing works, for it says that he was in a former life a Brāhman, *Apāntarātan*, who, after having attained final beatitude, 'by special command of the deity, resumed a corporeal frame and the human shape, at the period intervening between the third and fourth ages of the present world, and was the compiler of the Vedas.' (See Colebrooke's *Miscellaneous Essays*, vol. i. p. 327, Lond. 1837.) As the author of the Dharmasāstra, V. is possibly a personage distinct from the legendary individual bearing this name, as is the case with other Vyāsas who occur as authors of other works.

# W



THE twenty-third letter of the English alphabet, 'is a letter which performs the double office of a consonant and a vowel.' According to the decisive experiments of Professor Willis (*Cambridge Phil. Trans.*, iii. 231), the natural order of the vowels is *i, e, a, o, u*, or the reverse;

in which the sounds must be understood to be those which prevail on the continent.

The sounds, then, of *i* (that is, *ee*) and *u* (that is, *oo*) are the most remote, and the attempt to pass with rapidity from either of these to the others, more particularly to the other extreme, gives an initial breathing which has the character of a consonant, viz., in the one case, *ee-oo*, or *yoo*; in the other, *oo-ee*, or *we*.' See Key's *Alphabet*. This acute analysis of the articulations denoted by the characters *w* and *y*, throws a clear light on the double function they perform as consonants and as vowels. The letter *w*, which originated in the middle ages, is merely one *v* joined to another, as its English name imports. It is peculiar to the English, German, and Dutch alphabets. It would appear from a variety of phenomena in Latin and Greek, that the Lat. *v* or *u*, used as a consonant, as well as the old Greek digamma (Ϝ), were more of the nature of the modern *w*, than of the decidedly consonantal *v* (see U and V). The French, having, like the other Romanic nations, no character *w*, express the sound by prefixing *ou* to the vowel; as *ous* (pron. *wee*), *Edouard* = Edward. In the beginning of proper names they substitute *gu*; e. g., *Guillaume* = William. The Spaniards also use *gu*, as in the many names compounded of the Arabic *wadi*; e. g., *Guadalquivir*; but more frequently *su*, as in *Chihuahua* (pron. *Chiwawoa*). In High-German, which has become classical German, *w* is confounded with *v*, and *v* with *f*; thus, *Wellington* is pronounced *Vellington*. In London, *w* is substituted for *v*, and *v* for *w*, with 'a most amusing perversity.'

**WAAL**, **THE** (Lat. *Valis* or *Vahalis*), an arm of the Rhine, thrown off near the village of Panterden, in the Netherlands, flows thence to Nijmegen, Tiel, Nieuw-St-Andries, between the Boemmel- and Tiel-ward, and unites with the Maas below Fort Lovestein (Luvestein). The united rivers then take the name of the Merwede, which, flowing past Gorinchem and Dordrecht, becomes the Oude, or Old Maas. See **MAAS**.

**WA'BASH**, a river of the U. S. of America, rises in Western Ohio, runs west and south-west through Indiana, forming the southerly half of its western boundary, on the borders of Illinois, to the Ohio River, 146 miles from its mouth, is 550 miles long, and navigable by steamers at high-water 300, and has for its principal branches the Tippecanoe, Big Vermilion, Embarras, and White River—the last 200 miles long. The Wabash and Erie Canal connects the lakes with the Mississippi.

**WACE, ROBERT**, an Anglo-Norman poet of the 12th century. Many different versions of his name are given in his own books, as well as in the other books which mention him. He is styled *Vace*, *Wace*, *Waece*, *Waice*, *Waicoe*, *Waze*; *Gasse*, *Gaice*, *Guace*, *Guazi*, *Guaze*, *Guascoe*, *Gazoe*; and again, *Wistace*, *Huistace*, *Huaca*. It has been supposed that there were really two poets, the one named *Wace* or *Guace*, the other named *Wuistace*; the one the author of *Le Roman du Rou*, the other of *Le Roman du Brut*. But variety in writing names was very common in the middle ages, and it does not seem necessary to resort to this supposition. About his Christian name there is even more doubt than about his surname. It is never mentioned in his poems, from which the little that is known about him is mostly derived. An old writer speaks of him as *Matthew*; and it seems that he was first called *Robert* in the *Origines de Caen* by *Huet*, whom subsequent authors have followed.

*W.* was born in Jersey, in the reign of Henry I., and it is probable that the date of his birth lay between the years 1112 and 1124. He was taken to Caen as a child, and there he received the early part of his education. He was afterwards sent into the neighbouring kingdom of France; but he returned to Caen, and having entered into holy orders, became a reading-clerk in the Royal Chapel there. At Caen it was that he composed his works. Henry II., to whom he dedicated *Le Roman du Rou*, gave him a canonry at Bayeux, apparently about the year 1160. He died in England about the year 1180, certainly before the year 1184.

Five separate works are attributed to *W.*; but three are slight, short performances, and it is only necessary to notice the two principal—*Le Roman du Brut d'Angleterre*, and *Le Roman du Rou*. The former premises that a certain Brutus, a son of Ascanius, and grandson of *Aeneas*, settled in Britain, and became its first king. The book continues the history of the British kings from Brutus to Cadwallader, who died at Rome shortly before the year 700. It is little more, however, than a literal translation into the French from the Latin of Geoffrey of Monmouth (q. v.). This poem seems to have been completed in the year 1155. *Le Roman du Rou* (*Rolle*) is a sort of history of the Dukes of Normandy and of the Norman monarchy in England. Neither of these works has the slightest poetical merit. They are both interesting only as shewing the state of the French language in the 12th c., and as supplying occasional facts and social traits to the historian.

**WA'CKE**, a German miners' term, introduced by *Werner*, to designate a soft variety of trap, that has an argillaceous aspect, and a greenish-gray colour. It resembles indurated clay, but has been formed of volcanic ashes or mud. It is often vesicular, and when the cavities are filled, it becomes an amygdaloid. It is associated with trappean rocks, and, indeed, often passes into basalt or greenstone.



**WAD**, the popular name given in some parts of England, as in Derbyshire, to an ore of manganese, which is a hydrated peroxide, united with nearly its own weight of oxide of iron. Wad is also the provincial name of black lead or plumbago in Cumberland.

**WAD**, in Gunnery, a compressible disc forced home in the barrel after the powder, to confine the latter to the least possible space before its explosion. For great guns, the wad is commonly made of rope; for small-arms, of pasteboard.

**WADERS**, or **WADING-BIRDS**, a designation often applied to the whole order of birds *Grallae*

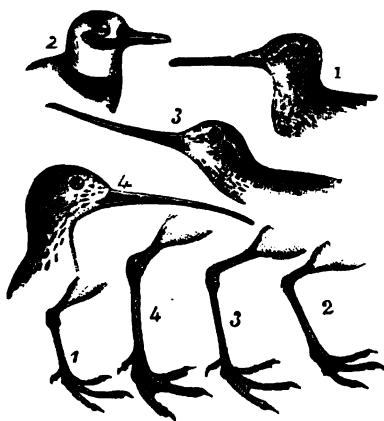

Characteristic Features of Wading-birds :

- 1, Head and foot of Common Snipe; 2, Head and foot of Ringed Dotterel; 3, Head and foot of Common Godwit; 4, Head and foot of Curlew.

(q. v.), or *Grallatores*, but really appropriate only to some of them, the more aquatic in their habits, as Herons, Snipes, and Rails.

**WADHAM COLLEGE**, Oxford. In the year 1610, James I. issued a licence to Dorothy Wadham, acting as executrix of the will of her deceased husband, Nicholas Wadham, Esq., to found a 'College of Divinity, Civil and Canon Law, Physic, good Arts and Sciences, and the Tongues.' Dorothy Wadham purchased the site and ruins of the priory of the Austin Friars, in the suburbs of Oxford, and built the present college for a warden, 15 fellows, 15 scholars, and 2 chaplains. The fellows were formerly elected from the scholars, and the tenure of the fellowships was limited to 22 years; nine of the scholarships were limited to certain counties, and to the founder's kin. By the Commissioners under 17 and 18 Vict. c. 81, the fellowships and scholarships were thrown open—the former to all persons who had passed the examinations for a B.A. degree; the latter to all persons under 20 years of age. The Commissioners also abolished the limitations on the tenure of the fellowships. At present, the number of fellowships is fourteen, one of them having been appropriated to the professor of experimental philosophy. The scholarships are worth £80 a year, besides rooms, and are tenable for five years. There are several good exhibitions, especially those founded by Dr Hody—four for Hebrew, and six for Greek, value £45 a year, and tenable for four years; also a law exhibition for a fellow, value £90 a year; and a medical exhibition for a fellow, of the same value. There are thirteen benefices in the gift of this college.

**WADI**, an Arabic word signifying a river, a river-course, a ravine, or valley. It is supposed that the

Greek *oasis* is a corruption of *wadi*. It is of frequent occurrence in the names of places; e. g., Wadi-Musa (i. e., the Valley of Moses) in Arabia. In Spain, where most of the rivers bear names given them by the Arabs, *wad* has been transformed into *guad*; e. g., Wadi-l-abyadh (the white river) has become Guadalquivir.

**WADSET**, in Scotch Law, is the old name for a Mortgage (q. v.). The modern name is Bond and Disposition in Security. See **HERITABLE SECURITIES**.

**WAFER**, in relation to the Roman Catholic usage of the Eucharistic communion, is the name given (chiefly by non-Catholics) to the thin circular portions of unleavened bread which are used in the Roman Church in the celebration and administration of the Eucharist. In ancient times, the bread and wine for the Eucharist were contributed by the faithful; and a place is found in the Eucharistic service of every known liturgy for this offering, still known by the name of Offertory (q. v.). But in the Latin Church, for many centuries, the bread (which, as being unleavened, and different from that in common use, needed special preparation) has been provided by the clergy; and the practice has been followed of preparing it in the form of thin cakes, commonly, although not necessarily circular, and frequently impressed with sacred representations or emblems, as the Crucifixion, the Lamb, the Christian monogram, the Cross, and other sacred symbols. The circular form itself is by some ritualistic writers regarded as symbolical, the circle being a figure of perfection. The wafers used in the Roman Catholic Church are made of different sizes, the smallest about an inch in diameter for the communion of the people, a second considerably larger for the celebration of the mass, and a third still larger to be placed in the Monstrance (q. v.) for the service of benediction or exposition. See **LORD'S SUPPER**.

**WAFERS**, thin discs of dried paste, mostly coloured, used for sealing letters, or for attaching papers together. They are made by mixing fine wheaten flour with water and any non-poisonous colouring materials, so as to form a mixture not thicker than thin cream. A small quantity of this is poured on the lower limb of a pair of wafer-irons, which are formed like a pair of pincers, but with flat blades about 12 inches long by 9 in breadth, the inner surface of which is kept well polished. Before being used, they are heated over a charcoal or coke fire; and the liquid paste being poured on the lower blade, the pressure of the two blades distributes it equally in a thin sheet between them, the superfluous material being squeezed out at the sides, from which it is shaved off by means of a knife. In a few seconds of time, if the blades are hot enough, the sheet of paste becomes dry and half baked. The sheets so formed are then stamped out into discs of the sizes required. Formerly, wafers were very extensively used, and their manufacture was one of considerable importance; but the introduction of gummed envelopes has almost driven them out of use.

**WAGENINGEN**, an old but well-built town in the Netherlands, province of Gelderland, is situated near the Rhine, to which access is had from it by a canal. Pop. (1875) 6005. W. has good schools and other useful institutions. The environs are beautiful, and the Wageningsche Berg, now formed into a burying-place, is especially picturesque.

Ship-building, brick and tile making, tanning leather, rope-spinning, &c., with agriculture, are the chief sources of wealth. W. received the rights of a town in 1263. It is a neat, purely Dutch town,

selected as a residence by many who wish to live quietly, comfortably, and economically.

**WAGER OF LAW**, in the Law of England, was an old form of giving sureties that at some future time the party would wage his law—that is, put it to the oath of the defendant, who swore in presence of eleven compurgators as to the debt claimed. The action was used in causes where there was some secrecy as to the origin of the debt, or where the defendant bore a fair character. That form of action had long been in disuse, but was not formally abolished till the statute of 3 and 4 Will. IV. c. 42.

**WAGERS**, in the Common Law of England, were held good, if they were not against the principles of morality, public decency, or sound policy; and a wager or bet was defined to be, a contract entered into without colour or fraud between two or more persons for a good consideration, and upon mutual promises to pay a stipulated sum of money, or to deliver some other thing to each other, according to the result of some contingency. A wager has been held void which was made on the life of Napoleon I., on the result of an election of a member to serve in parliament, &c. Before the statute of 8 and 9 Vict. c. 109, wagers above a certain amount were declared to be illegal, but now wagers on a race are not illegal. That statute provides that all contracts or agreements, whether by parol or in writing, by way of gaming or wagering, shall be null and void, and the money due thereon cannot be recovered in any court of law; but that enactment does not apply to any subscription or contribution or agreement to subscribe or contribute for any plate, prize, or sum of money to be awarded to the winner or winners of any lawful game, sport, pastime, or exercise. If a sum of money has been deposited with a stakeholder, not as a stake, but by way of wager, it may be recovered back if notice is given to the stakeholder before the event comes off. As no wager can be recovered in a court of law, it is merely a debt of honour, and if paid, it is in the eye of the law the same thing as giving a gratuity. If a promissory-note or bill of exchange be taken as security for money either won by betting or knowingly lent for betting, the consideration is illegal, and the money cannot be recovered. A recent act was passed for the suppression of betting-houses, and imposes penalties on persons keeping or using houses for betting purposes (17 and 18 Vict. c. 119); and justices may authorise constables to break into such houses, and arrest all persons found therein. Whoever by a cheating wager wins money from another, is liable to be indicted for obtaining the money by false pretences.—In the Law of Scotland, wagers are treated as *pacta illicita*, which it is beneath the dignity of any court to entertain questions about, and so they are not recoverable by action. The act 8 and 9 Vict. c. 109 does not apply to Scotland, but there are older statutes of a somewhat similar effect.

**WAGES** means the money given for personal services, as distinct from the price of anything sold, whether made by the seller or not. When a man makes a basket, and sells it, the price is not wages, though it may be the same thing to him. The term has by general usage been limited to the remuneration of hand-working. A manager of a bank or railway—even an overseer or a clerk in a manufactory, is said to draw a salary. It is generally a feature of wages, too, that they are paid at short intervals, as being necessary for immediate support. This division is connected with social distinctions which have exercised a baneful moral influence in the direction of improvidence. The

clerk at a hundred a year is supposed to be a gentleman who dresses decently, and so adjusts his expenditure that he can draw it quarterly. The puddler or shingler who can make a guinea a day is, by traditional usage, a member of the needy classes, who requires to draw his wages weekly, and is expected to spend them at once. Wages are more absolutely ruled by their value in the market than other services. A writer of poems or a painter of pictures does work which is exceptional—if people are willing to pay him any price he may ask for his work, there is probably no one who can compete with him and undersell him. A lawyer or a physician may also have special qualities to a great extent excluding competition; and in appointments to offices requiring trust, judgment, and skill, a great many things have to be considered besides the question, who will do the duty cheapest? But in the staple hand-works—the making of clothes, the baking of bread, and the like—there are uniform functions of the hand which a certain number of persons will always be found ready to give for a price. Strong efforts are made from time to time—by combinations, strikes, &c.—to make wages fictitiously high. These efforts are of course often successful for a time, bringing profit to some members of the working-classes, though injury to others, and a general loss of the wealth of the community. But the great law of political economy, that labour as well as all other things, will bring what it is worth, ever prevails in the end in a country where trade and labour are free. See **CAPITAL, COMBINATION, LABOUR, TRUCK-SYSTEM.**

**WAGNER, RICHARD**, a contemporary German operatic composer. He was born at Leipzig in 1813, and was educated at Dresden and Leipzig. In 1836, he was *Kapellmeister* at Magdeburg, and after spending some time in Königsberg, Dresden, and Riga successively, he came to Paris in 1841, where he composed his two earliest operas, *Rienzi* and *Der fliegende Holländer*. *Rienzi* obtained for him the post of *Kapellmeister* at Dresden. His next opera, *Tannhäuser*, appeared in 1845. Being involved in the political schemes of 1848, W. had to quit Saxony, and resided for a time in Switzerland, where he composed *Lohengrin*. He spent the season of 1855 in London, where he undertook the direction of the Philharmonic Society's concerts. In 1865, he was invited to Munich, and greatly befriended by the young king of Bavaria, who appointed him Director of the Opera-house; and he there produced his opera of *Tristan und Isolde* the same year; and, in 1868, *Die Meistersinger von Nürnberg*, at the first performance of which W. sat beside the king in the royal box. Since that time, his energies have been mainly devoted to the securing of such representations of his works as he and his admirers regard as proportionate to their merits. W. has kept himself constantly before the public by pamphlets and the republication of favourable newspaper articles. W. unions have been formed in all the principal towns of Germany; and Baireuth, in the north of Bavaria, has been selected as the most suitable centre for a grand W. theatre, of which the foundation stone was laid with great ceremony, in May 1872, by the great composer himself, in the presence of a host of his admirers, and for the opening of which (1876) he prepared a great operatic tetralogy, *Der Ring des Nibelungen*. In all his operas, the words of the libretto, W.'s own composition, are adapted to a declamatory style of recitative, relieved by harmonies and instrumentation in accordance with the spirit of the situation. They are often magnificent in spectacle, but are purposely deficient in what is commonly understood as melody. W.'s position amounts to this, that the highest

mission and true end and object of music is only realised when it is the exponent of poetry; and that instrumental music is practically dead.

**WAGON**, a vehicle for the conveyance of goods or passengers, is mounted on four wheels, but varies considerably in the construction of its other parts, according to the species of traffic in which it is to be employed. Since the wagon has four wheels, it is quite unnecessary that any part of the weight should be sustained on the shafts, and accordingly these latter are hinged to the fore-part of the frame, so as to be raised or let down at pleasure. Wagons being generally drawn by two horses abreast, two pair of shafts are employed; and when three horses are yoked abreast, the centre one is the shaft horse, the right and left 'wheelers' are yoked by traces to the wagon-frame; and each of the latter is attached by a chain from its collar to a shaft, so as to preserve the parallelism of its action. Most wagons are set on springs, on account of the weight of the vehicle, and the absence of the steadying weight of the horse, owing to the shafts not being immovably attached to the frame. For facility in turning, the fore-wheels are occasionally smaller than the hind ones; and in addition, the fore-axle of the lighter kinds of wagon is attached to the body of the wagon by a swivel-joint, the shafts or pole being in this case attached to the fore-axle; but the diminution of the size of the wheels is open to grave objection, on account of the greater friction. It being almost impossible for the beasts of draught to control and subdue the momentum of a heavily-loaded wagon descending a slope, it is necessary to employ a drag of some sort; the rudest forms of which are a thick cylinder of tough wood inserted between two spokes of the wheel, which, being carried upwards in the wheel's revolution, is 'jammed' against the under side of the wagon-frame, and stops the wheel's rotation; and the *chain-drag*, which was merely a chain firmly fastened at one end to the wagon-frame between a fore and hind wheel, and furnished at the other end with a large hook, to hold the tire of the hind-wheel; the method of chaining the fore and hind wheels together was also employed. But in the better class of wagons, the *shoe* and *break* (see *DRAG*) are now employed. The various forms of wagon in common use are the brewer's *dray*, the railway *lorry*, the agricultural *wain* (in common use in England and on the continent), and the *bullock-cart* of South Africa. The comparative merits of a vehicle in which the horse has merely to draw, and one, as the cart, in which he has to carry as well as draw, have often been discussed, though never sufficiently tested; but it seems to be generally believed that, despite the distress arising from his confined position in the comparatively immovable shafts of a cart, a horse can transport a greater weight to a moderate distance by the same exertion of muscular force in a cart than in a wagon.

**WAGON-TRAIN**, an indispensable companion of an army under this or some other title. It serves to convey the ammunition, provisions, sick, wounded, camp-equipment, &c. At the present time, in the British army, the Army Service Corps performs this function, although in China (1860) and New Zealand (1862—1865) the commissariat provided and organised its own wagon-service.

**WAGRAM**, or **DEUTSCH-WAGRAM**, a village of Lower Austria, on the left bank of the Russbach, ten miles north-east-by-east from Vienna, is of little importance, except as the site of the great battle between the French and Austrians in the campaign of 1809, which forced Austria to bow before Napoleon, and submit to the onerous conditions of

the fourth treaty of Vienna (q.v.). After the capture of Vienna, Napoleon resolved to pass the Danube, and complete the prostration of Austria's military strength by the destruction of her last army—that under the Archduke Charles; and with this view, he called in the Italian army, under Eugene Beauharnois, and all his outlying corps, concentrating them in and about the island of Lobau; and after a few feints, calculated to mislead the Archduke, who, stationed on the north bank, was vigilantly guarding the various crossings, succeeded in effecting a most extraordinary passage, on the morning of July 5, 1809, from the island of Lobau to the north bank, opposite Enzersdorf, landing 150,000 infantry, 30,000 cavalry, and 600 pieces of cannon before six in the morning. When the morning light shewed the Austrians how they had been out-manceuvred, they retreated across the plain of the March-field to its northern extremity, and took up a formidable position at W., and being closely followed up, were, on the evening of July 5, attacked by a part of the French army. By the vigorous exertions of the Archduke in person, the assailants—after a temporary success—were completely repulsed, and the Austrians, exulting in their second victory over Napoleon, waited in sanguine expectation of the events of the next day. In the morning, the Archduke resolved to assume the offensive, and succeeded at first in defeating the French centre under Massena, and in forcing their left into inextricable confusion, followed by total rout; but at the same time his own left was turned by Davoust, and this success followed up by a successful attack of Macdonald on their centre, forced the Austrians to retreat, which they did in the most orderly manner, carrying with them 5000 prisoners, and leaving 25,000 dead or wounded on the field of battle—the French loss being about equal. This drawn battle (the Archduke having, as Savary says, 'in reality no reason for retiring') had all the moral effects of a victory for the French; and was followed on July 11 by the armistice of Znaim, which resulted in the fourth treaty of Vienna.

**WAGTAIL** (*Motacilla*), a genus of birds of the family *Motacillidae*, which is now very generally regarded as a sub-family (*Motacillinae*) of *Sylviidae*, distinguished by a lengthened and slender bill, long and pointed wings, rather long and slightly curved claws, and a long narrow tail, which the bird incessantly wags up and down, with a jerking motion. The genus *Motacilla* of Linnaeus included many of the *Sylviidae* not belonging to this group, as the Red-breast, Nightingale, Black-cap, and Blue-bird. The genus *Motacilla*, as now restricted, has a slender awl-shaped, straight bill; the nostrils oval, on the sides of the bill near the base, partly covered by a naked membrane; the wings of moderate size, the first quill-feather the longest, the second and third nearly as long as the first, the tertials very long; the tarsus much longer than the middle toe; the tail of twelve feathers, long, and nearly equal at the end.—The wagtails run with great celerity, and seek their food on the ground. Their food consists chiefly of insects and small seeds. They frequent the margins of rivers and lakes, inundated fields, and other moist grounds. 'While the cows are feeding, in moist low pastures,' says White (*Nat. Hist. of Selborne*), 'broods of wagtails, white and gray, run round them, close up to their noses, and under their very bellies, availing themselves of the flies that settle on their legs, and probably finding worms and larvae that are roused by the trampling of their feet.' Wagtails make their nests on the ground, among moist herbage, or in stony places. Their flight is rapid and undulatory. They are natives of the temperate regions of the Old World. No species is found in America.

A common British species is the **PIED W.** (*M. Yarrellii*), which is from seven to eight inches in length, the long tail included, and has prettily varied white and black plumage. It is abundant over the whole south of Europe, and is found there at all seasons of the year, which is the case also in the south of England; but in more northern regions it is only a summer visitant, as in the Orkney Islands, where it is the first of the migratory birds to depart southward, the migration taking place almost as soon as the young are able for flight. The Pied W. is incessantly in motion, jerking its tail, running



1, Yellow Wagtail (*Motacilla flava*); 2, Pied Wagtail (*M. Yarrellii*).

quickly along the ground in quest of insects, and making short flights from place to place, chirping as it flies. It is often to be seen wading in shallow water, in pursuit of aquatic insects, and catching also small minnows when they approach the surface of the water. This species was long confounded with the **WHITE W.** (*M. alba*), of the continent of Europe, common from Sweden to the Mediterranean, as also in many parts of Asia, and in elevated situations in India and the north of Africa, but not a native of Britain. The two species are, however, very similar.—The **GRAY W.** (*M. boarula*) is bluish gray above, with the rump and lower parts yellow; a black patch on the throat in summer. It is abundant on the continent of Europe, as well as in Britain, and is commonly seen on pastures, often in close attendance on cattle or sheep, whence the French name, *bergeronette*, given to this and other species of W. of similar habits.—The **YELLOW W.** (*M. flava*) and the **GREEN-HEADED W.** (*M. Rasi*), also British species, of which the latter is the more common, belong to a sub-genus, by some regarded as a distinct genus, *Budytes*, having the hind-claw very long and sharp, and thus approaching in character to the Pipits (q. v.) or Titlarks.

**WAHA'BIS**, or **WAHA BITES**, a recent Mohammedan sect, now dominant throughout the greater part of Arabia. The movement may be considered a puritanic reform, which seeks to purge away the innovations and corruptions introduced in the course of ages, and to bring back the doctrines and observances of Islam to the literal precepts of the Koran and of the Sunna (q. v.), or oral instructions of Mohammed himself. This purified faith the W. consider it their duty to impose at the point of the sword—in this, too, following strictly the precepts and practice of Mohammed and the first califa.

The founder of the sect, Ibn-abd-ul-Wahab, was the son of an Arab sheik, or chief, and was born in Nejed or Nejd (the Central Highlands of Arabia), about the end of the 17th century. He is said to have visited various schools in the principal cities of the East, and to have lived some years in Damascus; and here he is represented as forming the resolution to restore in its primitive shape the ruined structure of Islam. Nor was the task an easy one. Throughout the Mohammedan world, the precepts of the Koran had fallen into abeyance, more especially among the Turks; and religion was little else than a round of external ceremonies—prayers, ablutions, fastings, the worshipping of the holy sheiks or saints at their tombs, and other superstitious innovations. In Central and Eastern Arabia, where the faith of Mohammed had never taken deep root, matters were even worse. According to Palgrave, 'almost every trace of Islam had long since vanished from Nejed, where the worship of the Djann (genii), under the spreading foliage of large trees, or in the cavernous recesses of Djebel Toweyk, along with the invocation of the dead and sacrifices at their tombs, was blended with remnants of old Sabæan superstition, not without positive traces of the doctrines of Moseylemah and Kermet. The Koran was unread, the five daily prayers forgotten, and no one cared where Mecca lay, east or west, north or south; tithes, ablutions, and pilgrimages were things unheard of.' Central Arabia was at that time divided among a multitude of virtually independent chiefs. One of these chiefs, named Sa'ud (or Saoo'd), a young man of ardent and capacious mind, who ruled over the small territory around the stronghold of Deraijeh, or Dureeyeh\* (in Nejed), was the first important convert made by Ibn-abd-ul-Wahab after his return home; and the example of the prince was followed by his kindred and retinue. The Wahabi is said to have promised Sa'ud that if he would draw the sword in the cause of pure Islam, he would make him sole ruler of Nejed, and the first potentate in Arabia. The prophecy was fulfilled, partly in Sa'ud's reign, and fully in that of his son; and the Sa'ud dynasty is at this day the chief power in the peninsula; while the descendants of Ibn-abd-ul-Wahab (who lived till 1787) continue to act as spiritual directors, though without any acknowledged authority. It was about 1746 that Sa'ud began to act as apostle militant of the new, or rather revived Islam. One after another, he subdued his heretical neighbours, offering them the alternative of conversion or extermination. Dying in 1765, he was succeeded by his son, Abd-ul-Aziz, who carried on the same policy with vigour and success. Extending his way to Hasa (Al-Ahsa, as Colonel Pelly spells it, and anciently Hajr), and other places on the Persian Gulf, he was brought in hostile contact with the Turkish authorities of Bagdad, and from that place an expedition was sent in 1797 against the W. by way of Hasa; but it failed to penetrate into Nejed, and proved fruitless. The W. now grew bolder in their plundering excursions towards the Euphrates, and in 1801, Sa'ud, the son of Abd-ul-Aziz, led an army against the holy city of Meahed Hussein, or Kerbela, took it, massacred the greater part of the inhabitants, destroyed the tomb of Hussein, the grandson of Mohammed, and carried off the treasures. On this, a second Turkish army was sent from Bagdad against Nejed, but was routed, and the greater part slain. The conquest of Hejaz was next undertaken by the Wahabis. For two or three

\* Nothing is more perplexing than the orthography of Arabic proper names; every traveller spells them in a way of his own. In comparing Burckhardt, Palgrave, and Colonel Pelly, it is often difficult to identify the places and persons spoken about.

years, Ghaleb, the ruler of Mecca, had been more and more hemmed in by neighbouring chiefs who had joined the W., and now, in 1803, Sa'ud collected a large army, and defeating Ghaleb in several battles, laid siege to Mecca, which, after a resistance of two or three months, surrendered at discretion. Not the slightest excess was committed, but the people had to become W.—that is, they were obliged to pray more punctually than usual, to lay aside and conceal their fine silk dresses, and to desist from smoking in public. Heaps of Persian pipes, collected from all the houses, were burned before Sa'ud's head-quarters, and the sale of tobacco forbidden.—Burckhardt.

Failing to take Jiddah, into which Ghaleb had thrown himself, the Wahabi forces went northwards, and, in 1804, took Medina, where they stripped the tomb of Mohammed of its accumulated treasures, and prohibited the approach to it of all but W., as they considered the reverence paid to it by the Turks and others as idolatrous. At Medina, 'the Wahabis enforced with great strictness the regular observance of prayers. The names of all the adult male inhabitants were called over in the mosque after morning, mid-day, and evening prayers, and those who did not obey the call were punished. A respectable woman, accused of having smoked the Persian pipe, was placed upon a jackass, with the pipe suspended from her neck, round which was twisted the long flexible tube or snake: in this state she was paraded through the town.'—Burckhardt.

During these events, Abd-ul-Aziz had been assassinated, in the end of 1803, by a fanatical Persian, whose family had been murdered by the W. at Meshed Hussein. He was succeeded by his son, Sa'ud II., who had for some time conducted the wars, and was perhaps the ablest ruler and warrior of the dynasty. For several years after the conquest of Hejaz, he continued to extend and consolidate his power. Plundering incursions were made to the very vicinity of Bagdad, Aleppo, and Damascus; while the Wahabi sheik of Asir (lying south of Hejaz) imposed the new faith on a great part of Yemen. On the east, Sa'ud took the islands of Bahrein, annexed a part of the Persian coast on the east side of the Gulf, and exacted tribute from the sultan of Oman. This brought him into conflict with Great Britain, which sent (1808) a force, and severely chastised the Wahabi pirates that infested the commerce of the Persian Gulf.

While these external struggles were going on, several of the southern provinces of Nejed broke out in revolt, instigated mainly, perhaps, by the local chiefs, whose power, formerly independent, was now circumscribed, or altogether taken away by the central government; but the rising was speedily suppressed, and a terrible example was made of the province of Harik and the town of Huthah, which last was completely demolished, and its inhabitants (the male inhabitants were reckoned at 10,000) butchered almost to a man.

From 1802, the W. had prevented the great pilgrim caravans from reaching Mecca, both because they held the observances of the Turk and Persian hajjis to be idolatrous, and also because they were scandalised at the gross immorality and indecency which were openly practised by these pilgrims. It may easily be conceived what horror spread through the Mohammedan world when it was told that the tomb of the Prophet had been despoiled by heretics, who prevented the faithful from performing the most sacred duty of their religion. Accordingly, the sultan of Constantinople, the acknowledged protector of Mohammedanism, as early as 1804, imposed on Mehemet Ali, the newly appointed pasha of Egypt, the task of recovering the holy

cities. With the dilatoriness, however, characteristic of the East, nothing was done till 1811, when an expedition was sent against them, under the command of the pasha's son, Tásün-Bey. Medina was taken by the Egyptian forces in 1812, and Mecca in the following year; and a protracted and desultory warfare, with varying success, was kept up with the W. in Hejaz and around its confines. At last, in 1815, Ibrahim Pasha (q. v.) undertook to penetrate into Central Arabia, and crush the hornets in their nest. The enterprise was facilitated by the death of Sa'ud in 1814. He was succeeded by his son Abdallah, who, though an able warrior, was less adroit in securing unity of action among the numerous tribes under his sway. It was not, however, till 1818, and after repeated conflicts, that Ibrahim succeeded in decisively breaking the Wahabi force, and capturing their capital, Deraijeh, which was laid in ruins. Abdallah-ibn-Sa'ud was sent to Constantinople, where he and some of his ministers were beheaded (1818). Ibrahim continued some months in Arabia, consolidating his conquests throughout Nejed and the adjoining provinces. His policy was one of gentleness and conciliation towards the chiefs and common people, and of stern repression towards the fanatical religious teachers; and except among these, his name is said to be yet popular throughout Central Arabia. But the folly and tyranny of the vice-governors whom he left soon caused a general insurrection; the Egyptians had to retire to Kasim; and Turki, a son of Abdallah, was proclaimed sultan of Nejed, Riad being now chosen as the capital. Renewed expeditions were undertaken by the Egyptian commanders, driving, first, Turki from his capital for a time, and then his son and successor, Feysul; instead of whom, a chieftain favourable to Egyptian rule was appointed. But soon after the death of Mehemet Ali (1849), the Egyptians gave up the struggle; Feysul was recalled from exile; and under him and his son and vicegerent, Abdallah II., the Wahabi sway had become more powerful and extensive than ever. In 1870 Feysul was assassinated, and the dissensions between his two sons Abdallah and Sa'ud led to a civil war. This gave occasion to the Ottoman government to send a military force into the Persian Gulf, which occupied Hofhufi, the capital of Hasa, but was unable to penetrate further into Nejed.

According to Burckhardt, there is not a single new precept in the Wahabi code. The only difference between the sect and the orthodox Turks (improperly so termed) is, 'that the Wahabis rigidly follow the same laws which the others neglect, or have ceased altogether to observe. To describe, therefore, the Wahabi religion, would be to recapitulate the Mussulman faith; and to shew in what points their sect differs from the Turks, would be to give a list of all the abuses of which the latter are guilty.' One peculiarity of the W. is their zeal against gaudy dress—silk and gold ornaments—and tobacco. In their wars of conversion, 'No Smoking' has been a kind of battle-cry. The recent traveller, Palgrave, who came into more intimate contact with the W. than Burckhardt, has a much less favourable opinion both of their doctrines and their practice. He describes their empire as 'a compact and well-organised government, where centralisation is fully understood, and effectually carried out, and whose mainsprings and connecting links are force and fanaticism. It is capable of frontier extension, and hence is dangerous to its neighbours, some of whom it is even now swallowing up. Incapable of true internal progress, hostile to commerce, unfavourable to arts and even to agriculture, and in the highest degree intolerant and aggressive, it can neither better itself nor benefit others; while the order and

## WAHABIS.

calm which it sometimes spreads over the lands of its conquest are described in the oft-cited *Ubi eolitudinem faciunt, pacem appellant* of the Roman annalist. We may add, that its weakest point lies in family rivalries and feuds of succession, which, joined to the anti-Wahabian reaction existing far and wide throughout Arabia, may one day disintegrate and shatter the Nejdean Empire, yet not destroy it altogether. But so long as Wahabism shall prevail in the centre and uplands of Arabia, small, indeed, are the hopes of civilisation, advancement, and national prosperity for the Arab race.' Colonel Pelly characterises the W. as 'warlike Mohammedan Quakers.'

Of late years, the tenets of these puritans have taken root among the Mussulman population of India, and caused very considerable uneasiness.

The following statistical table of the W. Empire

was drawn up by Palgrave, mostly from the official registers at Riad :

Provinces.	Towns or Villages.	Population.	Military Muster.
1. Aered, . . . . .	15	110,000	6,000
2. Yemamah, . . . . .	32	140,000	4,500
3. Harik, . . . . .	16	45,000	3,000
4. Afiaj, . . . . .	12	14,000	1,200
5. Wadi Dowair, . . . . .	50	100,000	4,000
6. Seley'el, . . . . .	14	30,000	1,400
7. Woshem, . . . . .	20	80,000	4,000
8. Sedeyr, . . . . .	25	14,000	5,200
9. Kasim, . . . . .	60	300,000	11,000
10. Hassa, . . . . .	50	160,000	7,000
11. Katif, . . . . .	22	100,000	
	316	1,219,000	47,300

The Bedouin populations within the territories number upwards of 70,000. A good many of the

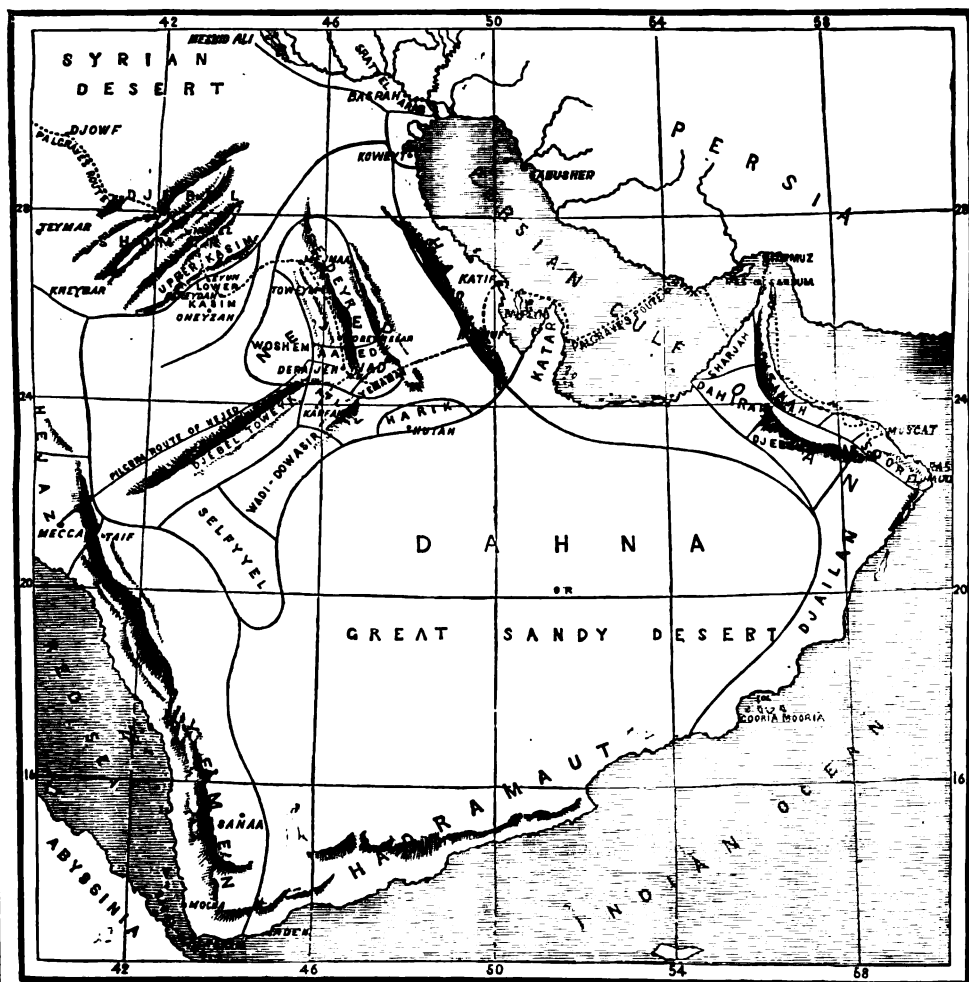

Arabia, shewing the Territory of the Wahabis.

(From the map in Palgrave's work on Arabia; by permission of the publishers, Messrs Macmillan.)

towns are large, and populous to a degree that the current notions of Central Arabia would hardly lead us to look for. The following are among those of which Palgrave estimates the population : Eyun,

10,000; Bereydah, 25,000; Oneyzah, 30,000; Toweym, 12,000—15,000; Horeymelah, 10,000; Mejma'a, 10,000—12,000; Riad, the capital (which Colonel Pelly has ascertained to be in lat. 24° 38' 34", long.

46° 41' 48"), has probably about 40,000; Kharfah, 8000; Hofhuf (Al-Hufhuf), 24,000. Katif (Khutif) is the most direct port of the W. dominions; and the province of Hassa in which it is situated is the richest.

To the north of Nejed and its dependencies, lies a kingdom formerly ruled over by a half-hearted ally of Feysul's, Telal, the chief of Djebel Shomer, and consisting of five provinces—Djebel Shomer, Djowf, Kheybar, Upper Kasim, Teymar—with a settled pop. of 274,000, and 166,000 Bedouins. Hayel, the capital, has a pop. of 22,000. This part of Arabia was overrun and converted during the first outbreak of Wahabi propagandism; but the conversion was only seeming, and during the interference of Egypt in Arabian matters, the country regained a kind of independency. Since the death of Telal, Ottoman interference has been attempted. The great majority of the people are averse to Wahabism. Still, the W. have numerous partisans and missionaries and spies in all the towns, and their influence is hated and feared by prince and people. Even Oman, where the new Islam is said to be still more distasteful, has been brought in some degree under the political sway of the Wahabis, and pays a small yearly tribute.

Karsten Niebuhr (q. v.) is the first European writer who mentions the W.; Burekhardt, *Notes on the Bedouins and Wahabis* (1830), gives a sketch of the Wahabi doctrines and of their history down to 1815; Sir Harford Jones Brydges, for many years resident at Bagdad, to his *Account of the Transactions of His Majesty's Mission to the Court of Persia*, appends a 'Brief History of the Wahaby'; Mengin, *Histoire de l'Egypt sous le Gouvernement de Mohamed Ali*; Coranoez, *Histoire des Wahabis*, with Maps. The most recent authorities on the subject are W. G. Palgrave's *Narrative of a Year's Journey through Central and Eastern Arabia*, 1862—1863 (Macmillan & Co., 1865); and 'A Visit to the Wahabee Capital,' by Lieut.-Col. L. Pelly, H.M. Political Resident, Persian Gulf, in *Geog. Soc. Journal*, 1865.

WAHOO. See ELM.

WAIBLINGEN, a town of Württemberg, on the Rems, in the circle of the Neckar; pop. (1871) 3530. It usually gets the credit of having given to the family of the Hohenstaufen the title which became Italianised into Ghibellines (see GUELFES AND Ghibellines); but Raumer (q. v.), the historian of the Hohenstaufen dynasty, upholds the claim of another Waiblingen in Württemberg, on the Kocher, in the circle of Jaxt.

WAIFS, in English Law, are goods stolen, and waived or abandoned by the felon on being pursued. The goods belong to the crown, but the owner, on doing diligence to prosecute and convict the thief, can have them again.

WAINSCOT (Sax. *wag*, a wall, and *scot* or *schot*, corresponding to Ger. *Scheit*, a split or cut piece of timber—from *scheiden*, to divide; the word would thus mean wall-timber or boards), the name given to boards lining the interior walls of apartments. Such lining, usually in panels, is very common in Elizabethan architecture. The name is frequently applied to the best kinds of oak-boards, from oak having been so much used for panelling.

WAIST, in a Ship, is that portion of the upper deck lying between the fore and main masts. In it the larger boats are stowed, and along its gunwale the crew pile their hammocks during the day. In a steamer, the waist is much broken into by the engine-room.

WAITS (anciently spelled *Waightes*) is a name which has at successive periods of our history been given to different classes of musical watchmen. The word is one, in slightly varied forms, common in the sense of guard or watchman to all the Germanic languages. It is the German *Wacht* or *Wache*, Dutch *wagt*, Danish *vagt*, Swedish *wakt*, Scotch *waite*, and the English *watch*. How the word in the form of waits came to be exclusively applied to musical watchmen in England and Scotland, it is impossible to say. In the time of Edward IV. the waits appear to have formed a distinct class from both the watch and the minstrels. It was their duty, we learn from Rymer's *Fœdera*, to pipe the watch nightly in the king's court from Michaelmas to Shrove-Thurs-day four times, in the summer nights three times, and to make 'the bon gayte' at every chamber-door and office, for fear of *pyckeres* and pillars. The waits were not confined to the court; there were musical watchmen at an early period in many provincial towns. In Exeter, a regular company existed in 1400. Beaumont and Fletcher (*Knight of the Burning Pestle*) speak of the 'waits of Southwark as rare fellows as any in England.' The word in the provinces was afterwards sometimes applied to the town musicians, who may have represented the old waits, but who had no duties to perform as watchmen. The name was also given to the town-band or to private musicians when employed as serenaders. In this sense it is used in the *Tailler* (No. 222). The writer says that it had become so much the custom for lovers to employ the waits to help them through their courtship in Nottingham, that the ladies of that place could get no sleep, by reason of riotous lovers who infested the streets with violins and bass-violins between 12 o'clock and 4 in the morning. Till recently, the waits were officially recognised in London and Westminster. In London, the post of leader of the waits was purchased; in Westminster, the appointment was in the gift of the High Constable and Court of Burgesses. In 1820, a Mr Munro obtained the post of official leader of the waits for Westminster, with the exclusive right to serenade the inhabitants, and make application for Christmas-boxes. His prerogatives were invaded by other musicians, and he prosecuted several persons before the police courts. At present, in the metropolis, the waits are musicians who play during the night or early in the morning for two or three weeks before Christmas. They call afterwards at the houses of the inhabitants to ask for a Christmas-box. In Glasgow, there were waits at an early period. The magistrates still grant a certificate to a few musicians, generally blind men, who play in the streets during the night and morning for about three weeks previous to New-Year's Day. Like the London waits, they call at the houses of the inhabitants, shew their credentials, and ask a small subscription.—See Chambers's *Book of Days*, vol. ii. p. 742.

WAITZEN, a town of Hungary, charmingly situated among vineyards, on the left bank of the Danube, 21 miles north of Pesth, on the Vienna and Pesth Railway. It is a bishop's see, contains a noble cathedral with conspicuous dome, built in 1777, and a handsome episcopal palace. Considerable wine-culture is carried on, and there are important cattle-markets. Pop. (1869) 12,894.

WAKE (from the Anglo-Saxon *wacian*, to watch) is the English equivalent of the ecclesiastical Vigil (q. v.). In early times, the day was considered as beginning and ending at sunset; Sundays and holidays, in consequence, began not on the morning, but on the previous evening (the *eve* of the

holiday), and worshippers then repaired to the churches for worship. The following day was spent in amusement. Each church when consecrated was dedicated to a saint, and on the anniversary of that day was kept the parish wake. In many places, there was a second wake on the birthday of the saint. On these occasions, the floor of the church was strewed with rushes and flowers, and the altar and pulpit were decked with boughs and leaves. In the churchyard, tents were erected to supply cakes and ale for the use of the crowd on the morrow, which was kept as a holiday. The second part of the festival seems to have made most impression on the popular mind, and the word wake came to be applied to it. Crowds resorted to the wakes from neighbouring parishes, hawkers or merchants were attracted by the crowds, and ultimately they became mere fairs or markets, little under the influence of the church, and disgraced by scenes of indulgence and riot. In 1235, Edward I. passed a statute which forbade fairs and markets to be held in country churchyards; but it does not appear to have put an end to the evil. In 1448, Henry VI. ordained that all showing of goods and merchandise, except necessary victuals, should be discontinued on the great festivals of the church. These regulations do not seem to have been strictly enforced. An act of convocation passed in 1536, during the reign of Henry VIII., seems to have effected a more important change. It ordered the day of the dedication of the church to be kept in all parishes on the first Sunday in October, and gradually that festival ceased to be observed. The saint's-day festivals were not, however, affected, and they are still kept in many English parishes under the name of 'country wakes.' A *lyche-wake* or *liche-wake* is a watching of a dead body (A.-S. *lic*) all night by the friends and neighbours of the deceased. The custom no doubt originated in superstitious fear either of passing the night alone with a dead body, or of its being interfered with by evil spirits. It must at all times have led to scenes ill suited to the occasion, and it now survives only among the lower classes in Ireland.—See Brand's *Popular Antiquities*, by Ellis.

**WAKEFIELD**, an important and handsome town in the West Riding of Yorkshire, overlooking the Calder, 9 miles south of Leeds, on the Lancashire and Yorkshire Railway. The town consists of three principal and many minor streets, and among the chief buildings are the parish church, conspicuous from its lofty and elegant spire; the grammar-school, a wealthy institution, attached to which there are six exhibitions to the universities; the library and news-rooms, corn exchange, &c. Its benevolent and scientific institutions are numerous and important. The town has long been famous for its manufactures of woollen yarn and cloths. The district around W. is agricultural, and the town is noted for its corn and cattle markets. Coal-mines are worked in the vicinity. W. returns one member to the House of Commons. Pop. (1871) 28,069.

**WALA'CHIA**. See **MOLDAVIA**.

**WALCHEREN**, an island in the Netherlands province of Zeeland, at the mouth of the Scheldt, contains 52,000 acres; pop. (1875) 42,503. The chief places are Middelburg, Flushing, and Vere or Campvere (q. v.). One half is meadow, the other rich arable land, well wooded to the north. Where it is not protected by natural downs, strong dykes have been formed, that at West Kappelle being a magnificent work. The drainage-water is carried off by large sea-slucies at Middelburg and Vere. Agriculture

is the principal employment. Ship-building, beer-brewing, rope-spinning, weaving, sawing wood, grinding corn, tanning leather, &c. are carried on, especially at Middelburg and Flushing. From the latter town, a railway has been constructed through West and South Beveland to Bergen-op-Zoom, joining the other continental lines. Flushing has a considerable shipping trade. The people are chiefly Protestants. In many parts are large artificial mounds, supposed to have been erected by the early inhabitants as places of refuge from high tides.

**WALCHEREN EXPEDITION**, one of the most disastrous military failures in the history of modern warfare, was undertaken, like that of Sir John Moore to Spain, with the view of helping the continental allies of Britain, by creating such a diversion as would prevent the concentration of Napoleon's strength, in overwhelming amount, against any one of his opponents. The expedition was planned in 1807, when Prussia, Russia, and Austria were all in arms against France; but it was not till early in the summer of 1809 (when Napoleon, who had meantime overwhelmed Prussia, and reduced Russia to neutrality, was gradually forcing Austria to succumb) that the British ministry resolved to carry it out. The plan was to send a fleet and army up the Scheldt, and attack Antwerp (the principal naval station and arsenal in the north of France), whose fortifications, though formidable, were much in need of repair, and whose garrison at the time only numbered about 2000 invalids and coast-guards; while there were not more than 10,000 French soldiers in Holland. The expedition, after numberless needless delays, at last sailed on July 28; and, to the number of 37 men-of-war, 23 frigates, 115 sloops and gunboats, accompanied by transports, carrying about 41,000 soldiers, reached the Dutch coast on the following day. But, instead of obeying the orders of the minister of war, Lord Castlereagh, to *advance at once in force against Antwerp*, the commander-in-chief, Lord Chatham (the elder brother of Pitt), frittered away his time in the reduction of Vlissingen (Flushing), which was not effected till August 16, by which time the garrison of Antwerp had been reinforced by King Louis Bonaparte with the troops at his command (about 6000), and by detachments sent from France, which swelled the garrison, by August 20, to 15,000 men. About the end of August, Chatham, who, as a general, was a methodical incapable, 'found himself prepared' to march upon Antwerp, but by this time 30,000 men, under Bernadotte, were gathered to its defence, and the English army was decimated by marsh-fever, so that success was not to be hoped for. However, it was judged right to hold possession of Walcheren, in order to compel the French to keep a strong force on the watch in Belgium, and, accordingly, 15,000 men remained to garrison the island, the rest returning to England; but the malaria proved too fatal in its ravages, and as peace had been concluded between Austria and France, this force was also recalled. Thus an excellently devised scheme, through the utter stupidity of the agent chosen by royalty to carry it out, failed in every point of consequence, and ended in a loss of 7000 men dead, and the permanent disablement of half the remainder. The failure of the Walcheren Expedition was made the occasion of furious onslaughts on the ministry in the House of Commons and in the public journals.

**WALDECK-PYRMONT**, formerly a sovereign principality in the north-west of Germany, consisting of the old county of Waldeck, enclosed between Westphalia, Hesse-Cassel, and Prussia, and



## WALDECK-PYRMONT—WALDENSES.

the small county of Pyrmont, about 30 miles north of Waldeck. The form of government was a constitutional and hereditary monarchy; but since 1868, the administration has been under the control of Prussia, by which power a lieutenant-governor (Landes director) is appointed. The entire area was 432 sq. m. Pop. (1871) 56,218. The elevation of the country is greater than that of most districts of Northern Germany; and the scenery, continually alternating between mountain and valley, forest and plain, comprises scenes of much natural beauty. The two largest rivers are the Eder and Diemel, affluents of the Weser. Among the minerals found are gold, copper, iron, and lead; and mineral springs occur. Agriculture and cattle-breeding are by far the most common pursuits of the people, and with the exception of leather, no articles are manufactured to any extent. An important article of export, and one from which the prince derives a considerable portion of his revenue, is the mineral water of the Pyrmont spa.

The noble House of W., one of the oldest in Germany, formerly owned, besides their present possessions, the counties of Swalenburg and Sternberg, but lost the former in 1356, and the latter in 1399. Chief town, Arolsen, with (1871) 2381 inhabitants.

WALDENSES (VALDENSES, VALDESI, VALESI, VAUDOIS) are a Christian community who inhabit a mountain tract on the Italian side of the Cottian Alps, south-west from Turin. The district is bounded on the N. by the Dora Ripaia, on the S. by the Po. It is enclosed on all sides by spurs of the Alps, which divide it into three valleys—that of Perosa, drained by the Clusone; that of San Martino, drained by the Germanasca; and that of Lucerna, drained by the Pelice, all tributaries of the Po. These valleys lie between France and Italy, and immediately south of the great western route into Italy by the passes of Mont Cenis and Genevre. The inhabitants are thus brought into communication with both countries; indeed, they speak a dialect more closely allied to those of Dauphiné than to those of Piedmont; and they have used French as well as Italian as the language of their liturgy. The religious doctrines of the W. are now similar to those of the Reformed churches. There is a minister in each parish, called a *barbe*, and the synod is presided over by an elected *moderator*. The W. had at one time bishops, but that was when the sect was more widely spread than it now is. Much has been said of the origin of the Waldenses. Their own historians assert that the community has remained from apostolic times independent of the church of Rome, and boast that they can shew a regular apostolic succession of bishops from the earliest period of Christianity till that of the Reformation. This statement has been very generally admitted by uncritical writers, but in the light of recent investigations, would seem to be no longer tenable. Dieckhoff (*Die Waldenser im Mittelalter*, Güt. 1851) and Herzog (*Die romanischen Waldenser*, Halle, 1853) have submitted the early history of the W. to a critical examination; and the result to which they have come, after an examination of the manuscript records, is, that the W. had not the early origin claimed for them, and were not Protestant before the Reformation, although they entertained some opinions which, so far, were in anticipation of those held by the Reformers. They are also of the opinion that the W. do not take their name from *val*, *vallis*, a valley, as has been assumed, but from Peter Waldo of Lyon, a merchant of the 12th c., who was less the founder of a sect than the representative and leader of a wide-spread struggle against the corruptions of the clergy. The church would have

tolerated Peter Waldo, as it had tolerated St Francis of Assisi, the founder of the Franciscans, and perhaps have allowed him to form a new order, had he not trenched upon ground dangerous to the hierarchy. But he had the four gospels translated, and maintained that laymen had a right to read them to the people. He exposed in this way the prevalent ignorance and immorality of the clergy, and brought down their wrath upon himself. His opinions were condemned by a general council in 1179, and he retired to the valleys of the Cottian Alps. A long series of persecutions followed, but Waldo's followers could not be forced to abandon their opinions. They continued to be known as the *Leonisti*, from the place of their origin—the Poor People of Lyon, from their voluntary penury—*Sabotati*, from the wooden shoes they wore—and *Humilitati*, on account of their humility. It was natural that a body cruelly persecuted should stand aloof from the church, and even offer armed resistance; yet we have no evidence of the manner in which the W. first became a separate community. They are now shewn to have been identical with the followers of Waldo, but they must not be confounded with the Albigenses, who were persecuted at the same period. The protest of the W. against the church of Rome only related to practical questions, that of the Albigenses related to matters of doctrine.

The W. at first seem to have spread in the upper valleys of Dauphiné and Piedmont, to which Waldo retired. They were subjected to persecutions in 1332, 1400, and 1478, and driven into many parts of Europe, where their industry and integrity were universally remarked. So widely had the sect been scattered, that it was said a traveller from Antwerp to Rome could sleep every night at the house of one of the brethren. In Bohemia, many of them had settled, and they, without forsaking their own community, joined the Hussites, Taborites, and Bohemian Brethren—a connection which led to a change in the principles of the Waldenses. They adopted the doctrines of the Reformers, and this led to more serious persecutions than any they had previously undergone. Francis I of France, in possession of Piedmont in 1541, ordered them to be extirpated. They were massacred at various places in Dauphiné and in the valleys they still occupy, more especially at Merindol and Cabrière. Several persons who refused to abandon their faith, were burned alive, yet the sect continued to exist. In 1560, the Duke of Savoy, who had recovered possession of Piedmont, urged by Pope Paul IV., forbade the W. to exercise their faith, under the penalty of being sent to the galleys for life. The W. sent him a petition and apology for their creed, which appeared to him so plausible, that he suggested that a conference should take place between the Waldensian and Romanist divines. He was, of course, told that the proposition was monstrous, and bullied by the pope and the courts of Spain and France so effectually, that he despatched 7000 men into the valleys, who were joined by two French regiments. The W. offered a gallant resistance, but were overwhelmed by superior force. Many prisoners were burned alive, and women and children were ruthlessly slaughtered. The duke was disgusted with these atrocities, and although denounced as no better than a heretic at Rome, granted the W. an amnesty on condition that their service should only be performed at certain places in the valleys of Lucerna and San Martino. The W. in the other districts, and especially the Marquisate of Saluzzo, were then persecuted by the Jesuits. Charles I. of England sent two embassies to the Duke of Savoy to intercede in their behalf, but without avail.

Victor Amadeus I., not long after, ordered the W. of Saluzzo, under penalty of confiscation of property and death, to become Catholics; and the edict was so rigorously carried out that, in a few years, none of the sect remained in the district. Charles Emmanuel II., in 1655, directed a fresh persecution against the Waldenses. Some time before, the people of Lucerna, inflamed it is said by the discourses of Jean Leger, a popular preacher, set fire to a convent of Capuchins, and committed other excesses. An inquiry was made, and it was found that the W. had purchased property and built churches and schools in districts where no concessions had been granted them. They were ordered within 20 days to sell their property, or profess Catholicism. They resisted, under leaders named Jayer and Janavel, but they could not oppose the forces sent against them. No quarter was shewn to women and children, and atrocities were committed—more especially by the French and Irish mercenaries in the service of the duke—which, recorded by Jean Leger, were heard of with indignation in all Protestant countries. Subscriptions were made in England for those who had survived the massacre. The Swiss cantons, and the states of Holland, sent envoys to the duke. Cromwell addressed Latin letters to him, written by Milton, and also sent Sir Samuel Morland, who collected numerous manuscripts connected with the history of the W., and brought them to England with him. A convention was concluded, by which the W. were allowed again to exercise their worship. In 1685, Louis XIV. revoked the Edict of Nantes, and ordered the Duke of Savoy to compel the W. to adopt Catholicism. They were accordingly commanded to emigrate or abjure their tenets within 15 days. They resisted, and were attacked by the troops of the duke on one side, and those of Louis XIV. on the other. They were overpowered, and the survivors could make no conditions. A large number were imprisoned at Turin, where many died; others were allowed to emigrate. Their whole property was confiscated, and handed over to Roman Catholic colonists. When the Prince of Orange became king of England, the W. who had settled in Switzerland resolved to return to their valleys under the guidance of Henry Arnaud, one of their pastors. In 1689, they gathered from all quarters to the rendezvous in the great forest of the Pays de Vaud. On the night of the 16th of August, they embarked on the Lake of Geneva, landed on the opposite shore, and after encountering the most determined opposition, reached the valley of San Martino, after a perilous march of thirty-one days. During the winter, a French army of 22,000 men entered their territories, and in the following summer attacked their fortifications, but were repulsed with great slaughter. Fortunately, the French and Piedmontese at this juncture quarrelled, and the latter, to secure the services of the mountaineers, granted them an amnesty. They are said to have fought not less than eighteen battles against the French, and to have lost only thirty men. This was the last persecution against the Vaudois; but it was not until the reign of the present king of Italy that they were admitted to the same privileges as Roman Catholics.—See *Botta, Storia d'Italia*; *Bender, Geschichte der Waldenser* (Ulm, 1850); *Morland's Churches of Piedmont*; *Gelly's Waldensian Researches*; *Muston, Israel of the Alps* (translated, Blackie, 1857).

**WALES.** See the articles ENGLAND, GREAT BRITAIN, PRINCE OF WALES, and the names of the various counties, towns, &c., of the principality; also WELSH LANGUAGE AND LITERATURE.

**WALES, NEW SOUTH.** See NEW SOUTH WALES.

**WALHALLA** (the Hall of the Fallen, i. e., heroes. See WALKYRIES) is, in Northern Mythology, the name of the place of residence for the fallen in battle. This brilliant hall stood in Gladshheim (the house of joy); in front of it was the beautiful grove Glasur, the trees of which bore golden leaves. Before the hall, which was so high that its summit could scarcely be seen, a wolf was hung, as a symbol of war, over which sat an eagle; the saloon itself, ornamented with shields, and wainscoted with spears, had 540 doors, through each of which 800 of the inmates (Einherjer) could walk abreast. For these Einherjer (i. e., the brave), who came after death to Odin, was it destined. Renowned chiefs, especially if they had desolated many countries, and wielded the blood-dripping sword far and wide, were met and welcomed by Bragi and Hermode as messengers from Odin. The hall was decorated to honour them; all the divine heroes stood up at their reception; the Walkyries tasted wine for them, which otherwise only Odin drank. All kings came to Walhalla, even when they did not die on the battle-field; in general, these joys seem to have been prepared only for those of high rank and the rich. As it was honourable to come to Walhalla with a great retinue, and to possess many treasures, the comrades of a leader who had fallen in battle killed themselves of their own free will, and in his grave were laid along with his horse and arms the treasures won in fight. Every morning, the inmates marched out at the crowing of the cock, and fought furiously with one another; but at mid-day all wounds healed, and the heroes assembled to the feast under Odin's presidency. Odin himself partook of nothing but wine; he gave the edibles to the wolves Geri and Freki, who sat beside him. The guests ate of the bacon of the boar Sahrimmer, and refreshed themselves with beer and mead, which flowed in abundance from the udder of the goat Heidrun; the attendant Walkyries handed them the drinking-horns, under Freyja's direction. Occasionally, the hero rode by night to his grave, where the beloved Walkyrie received him; he reposed in her embrace till, night disappearing, he exclaimed: 'It is time to make the horse tread on the white stair of the sky; I must travel towards the west to the bridge of heaven before the cock awakes the warriors in Walhalla.' The half of the fallen belonged to Freyja. The boar Sahrimmer, of which the heroes ate, was prepared by the cook Andhrimmer in the kettle Eldhrimmer. *Sa* is explained as signifying water; *and*, breath or soul; *elð*, fire; *hrim*, i. e., frost, was the primitive matter of which the world was made; from the branches of the deer Eikthyrnir, standing over Walhalla, drops fell into the well Hvergelmer, from which all rivers flowed. According to this, the heroes appear to be conceived as stars or spirits of the constellations, which draw their nourishment from the elements; and Walhalla stands for heaven.

The name WALHALLA is also given to a magnificent structure erected by Ludwig I. of Bavaria (1830—1841) as a temple of fame for all Germany. He conceived the project in 1806, when the Fatherland was at its lowest point of degradation, and while he was yet crown-prince. The design of the building was by Klenze, and the chief sculptors of Germany have contributed to the execution of the plan. It stands on an eminence 250 feet above the Danube at Donaustauf, near Regensburg. The temple is of nearly the same dimensions and proportions as the Parthenon, and is built of marble. By means of statues, busts, reliefs, and tablets, the mythology and history of Germany are illustrated, and her greatest names commemorated. The undertaking is said to have cost 2,330,000

florins. The chief blemish in this splendid structure is, that a monument in honour of the German people, instead of being built in the old German style, has been made a copy of a Grecian temple.

**WALKER, REV. GEORGE**, an Irish clergyman, distinguished for the part he took in the heroic defence of Londonderry against the army of James II., was born in the county of Tyrone, of English parents, in the early part of the 17th century. He was educated at the university of Glasgow, and entering the church, became rector of Donoughmore. The early life of W. was not remarkable. When the Irish army of James II. entered Ulster, and took possession of Kilmore and Coleraine, W. sought refuge in Londonderry, the head-quarters of 'the Englishry' since the times of James I., when the confiscated lands of the county had been bestowed on the corporation of the city of London, and a Saxon colony, English and Scotch, had been planted there, who had converted a waste into the richest district of Ireland. The town was fortified sufficiently to protect it from the pike-armed Celtic peasantry, and it had resisted more than one attack. But it was not so defended as to oppose regular troops. Lundy, the governor, was in secret communication with the enemy, and prepared to hand over the town to them; but some of his own officers protested against this course, and the citizens, remarkable at the time for that high spirit which characterises a dominant race, and the possession of those qualities which made the soldiers of Cromwell famous, determined not to yield. The bishop, Ezekiel Hopkins, in vain inculcated the doctrine of passive obedience at a conference; he was interrupted by a lad, one of a daring band known as the 'thirteen Scotch apprentices,' who called out: 'A good sermon, my lord—a very good sermon; but we have no time to hear it now.' A Scotch fanatic named Hewson urged the Presbyterians not to ally themselves with the enemies of the Covenant; but he was laughed at by his countrymen. The thirteen apprentices closed the city-gates, and defied the enemy. It was then that W., described as an aged clergyman who had taken refuge in the city, encouraged the townspeople to fight to the last. W. saved Lundy from the rage of the populace, and enabled him to quit the city in safety. Major Baker, who soon after died, and W. became joint-governors, aided by Captain Adam Campbell. The siege is the most memorable in British history. It began in April, and lasted till the end of July 1689. The inhabitants were reduced to the greatest extremities by hunger, but they were sustained to the last by the rousing sermons preached to them by W. in the cathedral, and the example he and Captain Campbell set in heading sallying-parties. When the siege was raised by the English fleet entering the harbour, W. went to London. He was warmly received at court, thanked by the House of Commons, created D.D. by Oxford, and Bishop of Derry by the king. Portraits of him were in every house in England, and his triumph would have been complete had the Presbyterians not thought that their share in the defence of the city was overlooked, and provoked useless controversy. W. could not be induced to take quiet possession of his bishopric; he would head a troop at the battle of the Boyne, and he was there killed. A lofty pillar has been erected to his memory at Londonderry, and the Walker Club and the Campbell Club have kept alive to our times the recollection of the siege. W. published in 1689 *A True Account of the Siege of Londonderry*.

**WALKING-LEAF.** See LEAF-INSECT.

**WALKING-STICK**, the popular name of many insects of the family *Phasmida* (q. v.), destitute of wings, and having a long, slender, cylindrical body, like a small stick with the bark on, the delicate legs resembling little twigs. Their habits are very similar to those of the leaf-insects or walking-leaves,



Walking-stick (*Phasma gigas*).

and their peculiar appearance is, in like manner, their protection. Most of them are natives of warm climates, and they are widely distributed. Some of them attain a large size. *Phasma gigas*, an East Indian species, is seven or eight inches long. A species, between three and four inches long, *P. femoratum*, is found even in the northern and north-western parts of the United States.

**WALKING-STICKS.** The habit of using a stick, either for support or merely as a fashion, is of great antiquity; and in modern times, the supply of such articles constitutes a large branch of trade in European countries, especially in Britain, France, and Germany. The imports into London and other English ports of sticks in the raw state, to be afterwards dressed and mounted, is enormous, exceeding four and a half millions annually, and reaching a value of about £25,000. They chiefly consist of the small stems or canes of certain palms, as the Malacca cane; and others called Whangee and Penang Lawyers; the woody stems of some small species of bamboo are also used, besides straight shoots of orange, cinnamon, myrtle, and other shrubs. The preparation and sale of walking-sticks are extensively carried on in Hamburg, and the finer sorts are richly and tastefully mounted in Paris. London is, however, the greatest mart for all kinds of walking-sticks. Of British trees and shrubs, the oak, crab, hazel, and sloe are used to some extent for the manufacture of walking-sticks.

**WALKY'RIES**, beings of the Scandinavian Mythology (q. v.), the legend of whom is the most terribly beautiful in the whole system. The name is derived from the old Norse *val*, which signifies a heap of slaughtered men, and *ljora*, to choose. *Val* itself contains the notion of chosen, elect, being allied to Ger. *wahlen*, Scotch *wale*, to choose. The Walkyries, also called battle-maidens, shield-maidens, wish-maidens, are charming young women who, adorned with golden ornaments, ride through the

sir in brilliant armour, order battles, and distribute the death-lots according to Odin's commands. Fertilising dew drops on the ground from the manes of their horses; light streams from the points of their lances, and a flickering brightness announces their arrival in the battle. With their charming glance, they rejoice the glazing eye of the hero, and lead him to Walhalla, where they act as his cup-bearers. Two Walkyries Hrist and Mist, are cup-bearers to Odin himself.

They differ in regard to their origin; some of them spring from Elves and other superhuman beings; some also are the daughters of princes, who in their lifetime are numbered among the Walkyries, shewing all their qualities, and when they die, their spirits become Walkyries. They ride generally in companies of three, or of three times three, or four times three, and have the gift of changing themselves into swans. They often choose noble heroes for lovers. Thus, Swawa was the beloved of Helgi, was twice, as Sigurn and Kara, re-born along with him, and accompanied him in his battles as a singing swan, flying over his head. Brynhild is also in the Norse heroic poem a Walkyrie. As a punishment for having distributed victory and death in battle contrary to Odin's will, he had taken the office of Walkyrie from her, and doomed her to marriage. Touched by Odin's magic rod, she lay in a trance till Sigurd, borne on his noble horse through the fire that flamed around her castle, undid her armour, and broke the spell. Whoever deprives a Walkyrie of her swan-robe, gets her into his power. Thus, three bold heroes took possession of the three princesses, Walkyries—Hladgudr Swanhwit, Heröd Alvit, and Alrun—as they sat spinning fine flax by the seaside. They stayed seven years with them, and then went away to attend on battles again as Walkyries. Here they resemble the swan-maidens of the German Sagas. But amiable as they here appear, the song of the Walkyries in the Njals Saga sounds terrible, as sitting on a hill, they weave the battle-web during the battle of Sigtryg with the silken beard and King Brian of Ireland. The Walkyries were frequently confounded with the Norns or Destinies. They were also conceived under the figure of the clouds. Thus, Hrist signifies dark sky, and Mist signifies quaking. Most of the names of the Walkyries, however, relate to war and battle.

**WALLABA TREE** (*Eperva foliata*), a tree of the natural order *Leguminosae*, sub-order *Cesalpinoee*, a native of Guiana. The wood is deep red, often variegated with whitish streaks, hard, heavy, shining, resinous, and very durable. The leaves are pinnate, without a terminal leaflet; the flowers in panicles of numerous distinct racemes, on a long pendulous flower-stalk. The calyx consists of four sepals, connected into a tube at the base; the corolla of one roundish petal.

**WALLACE, WILLIAM**, the famous Scottish patriot, was the younger son of a knight of good family in the south-west of Scotland. Neither the date nor the place of his birth has been ascertained; but there is no doubt that the former may be assigned to the middle of the reign of Alexander III. Nothing certain is known of his education or his early years. Blind Harry's half-fabulous poem has indeed inseparably associated his birth with Eilerslie, his boyhood with Dundee, and his youthful manhood with Ayrshire; but his true history, even in the next generation, was so obscure, that it is now impossible to separate truth from falsehood or exaggeration. He first appears, in the light of authentic history, as the chief of a band of insurgents against Edward, king of England. Taking

advantage of his superior power, of his influence over the barons of Norman race, who then were the foremost persons among the nobility of Scotland, and of the position of umpire to which he had been chosen by the various claimants to the Scottish crown, Edward had established his supremacy over the northern kingdom, and afterwards deposed John Baliol, and attempted to govern in his own absolute right. See *SCOTLAND, History*. The injustice of the claim, and the cruelty with which it was enforced, roused the opposition of all classes in Scotland except the higher nobles. The gentry and the middle and lower classes of the Lowlands, had for many years identified themselves with the country in which they dwelt, rather than with the great English race from which most of them drew their descent; and what has been called the War of Independence began, which resulted in the deliverance of Scotland from foreign rule, at the cost of the comparative civilisation and tranquillity which the country had enjoyed under the descendants of Malcolm Canmore. In this struggle, W. was the most successful leader; and in the course of the year 1297, the insurrection became general. Edward himself was at that time in Flanders; but his general in Scotland, the Earl of Surrey, led his army to Stirling. On the 11th of September, they encountered the Scots under W., and were completely defeated. The whole kingdom submitted to W.; who, passing the Border, ravaged Cumberland and Northumberland without opposition. On his return from this expedition, he was elected by his countrymen Governor of Scotland, in name of King John, whose title was still recognised. In the following year, Edward in person entered Scotland at the head of a numerous army. He was met at Falkirk (q. v.) by W. on 22d July; but the Scots were defeated. It is generally assumed that the jealousy of some Scottish nobles, who envied the position of the governor, had aided in bringing about the disaster, and W., in consequence, resigned his high office. With this event, his brilliant public career may be said to have terminated. All that is certainly known is, that he continued to struggle for his country's independence, and never made his submission to Edward, or took those oaths of fealty to him which were so lightly made by the Scottish nobles, and as recklessly broken. The events of this period related by modern writers under the name of 'Lives of Wallace,' are either transactions in which there is no evidence that he took any part, or the doubtful legends which, as years went on, gathered round the name of the Scottish hero. Some documents of undoubted authenticity make it probable that he was for some time in France. The close of his life forms an exception to this obscurity. When Edward offered pardon to the other Scottish leaders on certain terms, W. was excepted by name. If he chose to surrender, he might do so, but it was to be without conditions, and his life was to be at the king's mercy. Efforts were also made to discover his retreat and secure his person, and these were finally successful. In the year 1305, he was seized by some of his own countrymen, and delivered to Edward. He was carried to London, and with a mockery of the forms of justice, tried for treason. He denied the charge, asserting, with truth, that he had never been the vassal or subject of Edward; but his plea was disregarded. He was condemned and executed on the 23d of August; and his death was accompanied by acts of barbarity uncommon even in that age, and marking the merciless character which distinguished the later years of the English king. Contradictory as are the accounts of the English and Scottish chroniclers, it is not difficult to discover

the true character of Wallace. He was the true leader of a national insurrection against a foreign yoke. The cruelties inflicted in his invasion of England are undeniable, but he did what he could to mitigate them; and he should not be severely blamed if, under far greater provocation, he tolerated what the good King David, in his War of the Standard, was unable to prevent. His memory lives, and will ever live in the hearts of his countrymen, who know that they owe to him and to those who followed in the same course, that their history has not been as unhappy as the history of Ireland. The chief authority for the Life of Wallace, as told by popular Scotch writers, is the poem of Henry the Minstrel, who lived, however, nearly two centuries after his hero, and whose narrative is an almost unbroken series of picturesque impossibilities. The fullest modern account is that given by Mr Tytler in the first volume of his *History of Scotland*, and in his Life of Wallace in the first volume of his *Scottish Worthies*; but Tytler is to a large extent *Blind Harry* over again, with judicious excisions. All that is really known of W. will be found in Mr Burton's *History of Scotland*, and it is satisfactory to know that the result of a careful examination of the real facts by a writer so impartial, and so little apt to be carried away by enthusiasm, corroborates the most favourable estimate of W.'s character.

WALLACE, WILLIAM VINCENT, a British musician and composer of operas, was born at Waterford, of Scotch parents, June 1, 1814. He early attained proficiency as a performer on the pianoforte and violin—his performances on the latter instrument bringing him under the notice of Paganini. After being for some years leader of the orchestra of a Dublin theatre, he emigrated to Australia, where he lived for a considerable time in the bush, and then suddenly appeared in Sydney as a musician, and gave concerts in Australia, New Zealand, India, and America. In 1845, he came to England, and wrote his first opera, *Maritana*, which was an immediate success both in London and Vienna, and still holds the stage as one of the most popular of English operas. *Matilda of Hungary* followed it in 1847. During a sojourn of some years in Germany, Wallace added further to his musical culture; and after again visiting America, composed *Lurline*, which was brought out in London in 1860, with even greater success than *Maritana*. In 1861, he produced *The Amber Witch*; in 1862, *Love's Triumph*; and in 1863, *The Desert Flower*. W. died at the Château de Bagen, in the south of France, 12th October 1865, leaving another opera, *Estrella*, nearly completed. Without possessing genius of the very first order, W. was a highly-cultivated musician; the freshness of the motives, and the brilliancy of the orchestration of his operas, particularly *Maritana* and *Lurline*, have stamped their author as one of the chief English composers of this century.

WALLENSTEIN (or, more correctly, WALD-STEIN), ALBERT-WENCESLAS-EUSEBIUS VON, Duke of Friedland, Sagan, and Mecklenburg, the most remarkable of the long series of eminent men who owe their prominence on history's page to the Thirty Years' War, was the third son of a noble though not wealthy Bohemian family, and was born at the château of Hermance, in Bohemia, 15th September 1583. His parents, who were Protestants, intrusted the care of his education to the Moravian brotherhood of Koschumberg, who, however, made little of their stubborn and passionate pupil. On his parents' death, his uncle, Albert Slavata, a zealous Catholic, took charge of the wayward youth,

and having won him over to his own creed, sent him to the Jesuit *convictorium* at Olmütz, and to the universities of Altorf, Bologna, and Padua, where his education, such as it was, was completed. W.'s course of training had not eradicated, or even moderated the prominent faults in his natural disposition; on the contrary, his wilfulness and independent spirit had gathered stability and strength from ineffective opposition; and his first prominent appearance on the stage of events shewed a man of extreme individuality, gifted with great and versatile ability, but equally remarkable for obstinacy, passion, and pride. He afterwards visited Germany, France, and Holland, took service in the imperial army, then engaged with the Turks in Hungary, and, returning home at the close of the war (1606), married an aged widow of noble rank, who, at her death (1614), left him the whole of her great wealth. This, along with the fourteen domains bequeathed to him by his uncle, made him one of the richest and most influential lords of Bohemia, a position recognised by the imperial court by the bestowal on him of the title of count and the military grade of colonel. A second marriage in 1617 with the daughter of Count Harrach, the emperor's favourite, and W.'s firm adherence to the imperial side during the Bohemian insurrection; his maintenance, at his own expense, of a large body of troops; and his brilliant and well-directed gallantry at the battle of Prague, and in various contests with Mansfeld and Bethlem Gabor, added a powerful influence at court to his hitherto only local eminence. The latter, however, was now much increased by his purchase, at much less than their value, of sixty confiscated lordships in Bohemia; and Ferdinand II. felt himself impelled to recompense the valuable services of his faithful subject by (1623) raising him to the dignity of a prince of the empire, with the title of *Duke of Friedland*. (Friedland is a town situated close to the Prussian frontier, about 60 miles north-north-east of Prague.) Two years after, when the impossibility of maintaining an army sufficient to restrain the Protestant League from uniting with the Danes against him, threw the emperor almost into despair, W., seizing such a favourable opportunity of gratifying his ambition, offered to raise, equip, and maintain 50,000 men free of charge, provided he were intrusted with the absolute command, and allowed to appoint his own officers: a proposal greedily accepted by the emperor. W. raised 30,000 in Bohemia; adventurers from all quarters flocked to his standard; and in a short time his army far exceeded the promised number. With this motley but not ill-disciplined array, he then marched into North Germany, and acting in concert with Tilly (q. v.), routed Mansfeld at Dessau, hunted him through Silesia and Moravia, and on his junction with the army of Bethlem Gabor in Hungary, compelled, by skilful strategy, the combined forces to remain on the defensive. Released by a truce with the Transylvanian prince and the death of Mansfeld, he returned by Silesia, recovered the fortresses which Thurn had captured, forced the Elector of Brandenburg to submit to the emperor, and joined Tilly in annihilating the military power of Denmark. The value of these services to the emperor's cause was inestimable, as Ferdinand well knew, and he accordingly turned a deaf ear to the loud complaints of the North Germans, who had suffered grievously from the rapacity, oppression, and licence which W.'s soldiers were allowed to exercise without the slightest opposition; and rewarded their leader by the gift of the Mecklenburg duchies, the rank of generalissimo on land, and admiral of the Baltic. W. speedily made himself master of his new

territory; fitted out a fleet of 15 sail, by the aid of which he captured Usedom and Rugen, with various Baltic ports, and laid siege to Stralsund. But the Danes annihilated his navy; and the Swedes succoured Stralsund, the siege of which he abandoned in despair. But as under cover of the dread inspired by W.'s arms, Ferdinand had resumed his tyrannical and aggressive schemes (see THIRTY YEARS' WAR) in Germany, the Catholic League, headed by the Duke of Bavaria, became bitter adversaries of W., and backed by the intrigues of France (which was represented at Vienna by Father Joseph, a master of subtle and unscrupulous diplomacy), partly forced and partly cajoled the emperor to dismiss W., an act for the probable consequences of which even Ferdinand, with his extraordinary fortitude, trembled. W., however, disappointed his sovereign's fears and his enemies' hopes by obeying with apparent cheerfulness, being somewhat moved thereto by the predictions of his favourite astrologer,\* who declared his star to be only temporarily eclipsed, and that it would soon shine forth again with far greater lustre; and retired to Prague, where he lived in his magnificent palace in sovereign state, surrounded by a court composed of barons, knights, and the principal officers of his army. But the insult and injury he had received were eating into his soul; the frankness and affability to his subordinates, which had hitherto distinguished him, were changed for a gloomy taciturnity; and much of his time was spent in solitude, brooding over his wrongs, and scheming for revenge on the Duke of Bavaria, whom he justly accused of being the cause of his disgrace; though all the while he kept a calm but eager watch over the changes of opinion in the court of Vienna, where several of the ministers and numerous secret agents were either in his pay, or devoted to his interests. His eminent services, his immense popularity, and his great talents, pointed him out as the only hope of the empire after Tilly's death, and Ferdinand saw himself forced almost to kneel to his haughty subject, and beseech him again to gird on his sword; but W. for a long time affected the utmost indifference to re-engaging in active service, and at last consented only on such conditions as made him the independent ruler of the empire in military affairs. With the Swedes on the Danube, the Saxons in Bohemia, and the army of the League almost annihilated, the emperor had no choice; and W., three months afterwards, was at the head of 40,000 men, well armed and disciplined. But commands and entreaties were in vain employed to induce him to save Bavaria from the Swedes; and he lay idle at Leitmeritz, gloating over the pangs of his enemy, till, on Austria being threatened, he advanced to Eger, and by menacing at once Saxony and Nuremberg, brought Gustavus to a standstill. The two armies lay opposite each other for ten weeks, each suffering the extremities of famine, hardship, and sickness, in the hope of wearying out the other. At last, when half their numbers had succumbed, Gustavus, who had made a fruitless attempt to storm W.'s camp, retreated to the Danube, whence his skillful opponent soon drew him by marching on Saxony. The two again confronted each other at Lutzen (q. v.), and though W. was completely defeated, it was chiefly owing to the superior discipline and morale of his opponents. His army was recruited and reorganised in Bohemia; and, unable to make head against Saxons and

Swedes combined, he found it advisable to gain time by amusing his antagonists with illusory negotiations, after repeated vain endeavours to persuade the emperor to come to terms with the Protestant princes. Meantime his old enemies of the League were in full activity at Vienna; and the emperor, chagrined at the humiliations to which he had subjected himself to gain W.'s aid, was not slow to give credit, real or feigned, to their misrepresentations; his ill-concealed dislike was developed into hatred by the stubborn pertinacity with which W. insisted on the full observance of the terms of their agreement; and on W., who was kept well informed of the state of matters at court, attempting to attach his officers permanently to himself by obtaining their signatures (January 12) to an agreement to that effect, the emperor (January 24, 1634) declared him a rebel, and ordered two of his old officers, Piccolomini and Gallas, who had for some time been acting as spies on his actions, to take him dead or alive. W., with some devoted adherents, including a guard of 200 dragoons, took refuge in Eger, but was there assassinated, February 25, 1634. W. was tall, thin, and wiry, with lively brilliant eyes, tawny-reddish hair, and an unhealthy-looking, yellow complexion. 'He was far superior to his sovereign in true policy, liberality of sentiment, and religious toleration; but these qualities only rendered him more obnoxious to the bigoted emperor and his ministers.' As a general, he holds the foremost rank, vigilance and presence of mind, great judgment and unflinching perseverance, being his prominent characteristics; and of him alone can it be said that he checked the progress and foiled the designs of the great hero of Sweden. After his death, it was seen that the treacherous murder of one who had twice saved the empire from destruction called for some justification; and accordingly a paper was published by imperial authority, in which an attempt was made, by misrepresenting every overture he had made to his opponents, and every scheme he had employed to divide his numerous enemies at court, to prove that he had constantly meditated treason from the time of his first disgrace. This view and its opposite have found numerous and enthusiastic supporters; but without going further into detail, we may observe that the overtures made by him to the Swedes and Saxons while in command were undoubtedly *ruses de guerre*, and were invariably found to be such by his opponents; that when the Saxons invaded Bohemia, and took Prague, where he was residing in disgrace at the time, he took no part on either side, except such measures as an influential citizen would adopt for the safety of the inhabitants from insult and spoliation; and lastly, that when, after he had been declared a rebel, he *did* make 'treasonable' overtures to Bernhard of Weimar, the latter, though W.'s defection would at that time have been of the utmost importance, could not convince himself that this was not another artifice; a proof that the former overtures were as above stated.—See Coxe's *House of Austria*; Harte's *History of the Life of Gustavus Adolphus* (1759), in which many particulars of W.'s career are supplied from the Itinerary of Carve, the chaplain to the assassin, Devereux; Gualdo-Priorato's *Historia della Vita d'Alberto Valstain, duca di Friiland*; and Pelzel's *Geschichte der Böhmen* (Prague, 1774, 1779, and 1782).

WALLER, EDMUND, celebrated as one of the refiners of English poetry, was born at Colehill, Herts, on March 3, 1605—1606. He was of an ancient and opulent family, and having passed through Eton and King's College, Cambridge, was returned to parliament, at the early age of 18, as member for

\* W., during his attendance at the Italian universities, had deeply studied astrology; and although far too much has been made of this fact by his biographers, there is no doubt that the mystic doctrines of this pseudo-science had a strong hold on his mind, and at times much influenced his conduct.

Amersham, Bucks. In 1631, he married a London heiress, who died shortly afterwards; and the rich widower made suit to Lady Dorothy Sidney, eldest daughter of the Earl of Leicester, whom he poetically and perseveringly commemorated under the name of Saccharissa. Lady Dorothy, however, was inexorable: 'she was not to be subdued,' as Johnson says, 'by the powers of verse.' Meeting him in her old age, she asked the poet when he would again write verses upon her, and he ungallantly replied: 'When you are as young, madam, and as handsome as you were then.' In the Long Parliament, W. joined the party of Hampden (who was his cousin), and he was one of the commissioners appointed to negotiate with King Charles I. at Oxford in 1643. He was soon gained over by the royalists, and entered into a conspiracy against the dominant party in the House of Commons, for which he was fined £10,000, and banished the kingdom. His conduct on this occasion was mean and disgraceful. He not only confessed all he knew, but all that he suspected; attempted to criminate innocent persons, and humbled himself before the House of Commons in language inexpressibly abject and humiliating. After eight years' exile, spent in France and Italy, he was suffered to return to England; and he then became a supporter of the Commonwealth, and a panegyrist of Cromwell, to whom he was distantly related. When Charles II. was restored, W. was equally ready with a poetical congratulation; but his loyal strains were much inferior to those with which he had hailed the Protector; and it is said that when Charles reminded him of this fact, the poet wittily replied: 'Poets, sir, succeed better in fiction than in truth.' Up to his 80th year, W. continued a member of the House of Commons, delighting all parties by his wit and vivacity. He died at Beaconsfield, October 21, 1687. W. began early to write verses, and published two collections of his poems—one in 1645, and another in 1664. An edition appeared in 1711, edited by Atterbury; and one in 1729, with copious 'Observations' by Fenton. Pope has eulogised the *sweetness* of W.'s verse. Some of his smaller pieces are characterised by infinite grace and harmony; he has also occasional dignity and striking imagery, as in the lines on Cromwell; and he is never involved or obscure; yet his rank among our poets is but a subordinate one, as he is deficient in passion, energy, and creative power.

WALLFLOWER (*Cheiranthus*), a genus of plants of the natural order *Cruciferae*, having the silicles quadrangular from the prominence of the nerves on the back of the valves, the seeds in a single row in each cell, the stigma deeply 2-lobed, the lobes bent back. The flowers are in racemes. The species are annual, biennial, or perennial herbaceous plants, some of them almost shrubs. The COMMON W. (*C. cheiri*) is found in rocky places and on old walls in the south of Europe, and also, but less abundantly, in the middle of Europe and in Britain. In its wild state, its flowers are always yellow; but in cultivation, they exhibit a considerable diversity of colours, chiefly brown, purple, and variegated; and they attain a larger size. It is a universal favourite, on account of the delicious odour of its flowers. The varieties in cultivation are very numerous; but there are among them no marked distinctions. Double and semi-double flowers are not uncommon. The plant is perennial, but in gardens is generally treated as a biennial, although fine kinds are propagated by cuttings, which soon strike root under a hand-glass. The ordinary mode of cultivation is to sow the seed of an approved kind, and to plant out the seedlings. The flowers of W. have a bitter and

cross-like taste, and were formerly used as a medicine.

WALLINGFORD, a small, but ancient and interesting, parliamentary and municipal borough of England, mostly in the county of Berks, and on the right bank of the Thames, 13 miles north-north-west of Reading. Of its three churches, that of St Leonard's—rebuilt in 1849—has a Norman doorway. The earthworks with which the Romans encompassed the town, are still distinctly traceable. The diversion of the London and Oxford Road from W. much injured the old town, and it is now a place of little consequence. The borough returns one member to the House of Commons. Pop. (1871) of municipal borough, 2972.

WALLIS, REV. JOHN, D.D., a very eminent English mathematician, was the eldest son of the Rev. John Wallis, incumbent of Ashford in Kent, and was born there, November 23, 1616. He was brought up with a view to the church, and was educated for his profession, to the strict exclusion of all other branches of knowledge, in accordance with the prevailing practice of the time, which was in his case carried to such an extent that even ordinary arithmetic was wholly neglected. W. never saw a book of arithmetic till he was 15 years old, and then only by accident. At the age of 16, he was entered at Emmanuel College, Cambridge, where at that time mathematics found no place in the course of study, being esteemed merely mechanical. After a brilliant career, he took his degree, was chosen a Fellow of Queen's, and took orders in 1640. On the outbreak of the civil war, he sided with the parliament, and was of great use to his party in deciphering intercepted correspondence, an art in which like Vieta (q. v.) and Battista la Porta, he was eminent. In 1644, he was one of the secretaries of the Assembly of Divines at Westminster, holding at that time the living of St Gabriel, Fenchurch Street; and, in the following year, he joined with other eminent men in the establishment of the meetings for mutual instruction, which, 17 years afterwards, developed into the Royal Society. It was not till 1647 that he commenced the study of mathematics; and, in 1649, he was chosen Savilian Professor of Geometry at Oxford. The rapid progress he had made in his mathematical studies was evidenced by the publication of his greatest work, the *Arithmetica Infinitorum*, with a treatise on Conic Sections prefixed, in 1655. In the same year commenced his well-known controversy with Hobbes—regarding a quadrature of the circle, which the latter believed he had effected—which was continued at intervals till 1663, and was marked by the usual quaint caustic satire of the time. W. had, of course, the right side of the dispute; but unfortunately for posterity, his manly feeling of forbearance towards a deceased antagonist (Hobbes died in 1679) prevented him from admitting his polemical treatises into the collection of his works, which was published 1693—1699. Numerous other mathematical works, as the *Mathesis Universalis* (1657), *Commercium Epistolicum* (1658), *Cuno-Cunco* (1663), *De Proportionibus* (1663), *De Aëtu Maris* (1668), a treatise on Mechanics (1669, 1670, 1671), editions of the works of Horrocks (1673), of the Arenarius and Quadrature of Archimedes (1676), and of Ptolemy's Harmonics (1680), a treatise on Algebra (1685), an edition of Aristarchus and of Pappus (1688), &c., were the products of his originality and industry. We have besides numerous minor theological works, polemical and expository, from his pen, none of which, however, are important enough to call for mention. Of his other works, the treatise on *Logic*

(1687) is of the highest excellence, and even at the present day is well worthy of perusal; and his English Grammar (1653), written in Latin for the use of foreigners, has only of recent years, when the true principles of grammar are becoming better understood, received the attention it merits. About 1658, W. joined the party who were in favour of a reiteration of kingly government, and his talent for deciphering was now put in practice against his former friends, an act for which he has been abused with virulent injustice. At the Restoration, he was confirmed in his professorship, was appointed keeper of the archives at Oxford, and royal chaplain. In 1692, he was consulted as to the adoption of the Gregorian Calendar, and his strong disapproval decided the government to retain the old style. He died 28th October 1703.

It is exclusively as a mathematician that W.'s name has obtained permanently a niche in the temple of fame; though as an expositor of the cardinal doctrines of Christianity he was fully on a par with South and Sherlock; but his eminence in the former character has thrown into shade even his services as a scholar, and few at the present time remember that it was he who first edited the musical works of Ptolemy, Porphyrius, Aristarchus of Samos, and the later work of Briennius, though the manner in which these labours were effected indicates unquestionably an immense expenditure of labour, and a high degree of scholarship. His *Arithmetica Infinitorum* is a successful attempt to solve, by means of the summation of series to infinity, a number of the more simple problems of the calculus, such as the evaluation of all cases of  $\int x^n dx$ ; and, in extension, to discover the limit of  $\int (a^2 - x^2)^n dx$ , of which the quadrature of the circle is a particular case. There are numerous other results, which are, at the present time, considered to belong to the more advanced stages of the calculus; and, in fact, W. is another example of the strange blindness which, in full possession of a principle, neglects to suit it with a generalised form of expression. The best known of W.'s results is his formula for  $\pi$ , which gives

$$\frac{\pi}{4} = \frac{2.4.4.6.6.8 \dots}{3.3.5.5.7.7 \dots} \text{ ad infinitum.}$$

**WALLOONS**, the name given to a population belonging to the great Romanic family, more especially to the French stock, and occupying the tract along the frontiers of the German-speaking territory in the South Netherlands, from Dunkirk to Malmédy. They are located more particularly in the Ardennes, in parts of the departments of Pas-de-Calais, Nord, Aisne, and Ardennes in France, but chiefly in South Brabant, as well as in the provinces of Hainault, Namur, Liège in Belgium, and in the greater part of Luxemburg, and finally in some towns and villages in the neighbourhood of Malmédy in Rhenish Prussia. The W., whose numbers in Belgium, where they are principally established, are stated at 1½ millions, are the descendants of the old Gallic Belgæ, who held their ground among the Ardennes Mountains when the rest of Gaul was overrun by the German conquerors, but became eventually Romanised, especially in their language, which appears now as a patois or popular dialect of French; of all the French dialects, however, the greatest number of Gallic words have been preserved in it. See the unfinished work by Grandgagnage, *Dictionnaire Etymologique de la Langue Wallonne* (Liège, 1845). The name W., in Dutch, *Walen*, sufficiently shows their Gallo-Romantic origin and their relationship, partly by race and partly by language, with the Galli, Gæls, Walesæ, Welsh, Walachians, &c. The Walloons of the

present day resemble their French more than they do their German neighbours. They are squat and middle-sized, with powerful limbs, dark hair, deep sunk, fiery, dark-brown or blue eyes. They surpass their Flemish neighbours in adroitness, activity, and skill; and their French in earnestness, perseverance, and diligence. In impulsiveness, they resemble the latter more than the former, but their anger sooner cools than that of the more deeply feeling Fleming. It is worthy of notice that the Belgian revolution was pre-eminently the work of the Walloon districts, and the most eminent statesmen of modern Belgium are of Walloon descent. It was against the Walloon spirit and tendencies that the Flemish movement (see FLEMISH LANGUAGE AND LITERATURE) was chiefly directed.

**WALL-PIECE**, a small cannon (or, in ancient times, an arquebuss) mounted on a swivel, on the wall of a fortress, for the purpose of being fired at short-range on assailants in the ditch or on the covert-way. There are distinct evidences that the great wall of China was originally constructed for the reception of wall-pieces.

**WALL-PLATE**, a piece of wood laid along the top of the wall of a building to receive the feet of the rafters of the Roof (q. v.).

**WALL-TREES**, in Horticulture, are fruit-trees trained on walls for better exposure of the fruit to sunshine, and for the sake of the heat radiated from the wall. Brick walls are generally preferred, and have a great advantage in the regularity with which the nailing can be accomplished, but trees are often also trained on stone walls, and the walls of houses are sometimes used for this purpose. Trees are trained on walls in hothouses as well as in the open air. Flued walls are often used, the fruit being thus partially forced by artificial heat; and screens of various kinds, as of reeds, canvas, and oiled paper, are sometimes employed to protect blossoms in spring. Woollen nets are also much used for this purpose, and a net even with wide meshes affords much protection from spring frosts. Wall-trees, intended permanently to occupy the wall, are generally trained in the nursery with a dwarf stem only five or six inches in length, so that the branches may cover the whole wall, and no available part of it may be lost. It is usual, however, in planting to introduce *riders* alternately with the permanent wall-trees, which are grafted or budded on tall stocks, and occupy part of the wall till the other

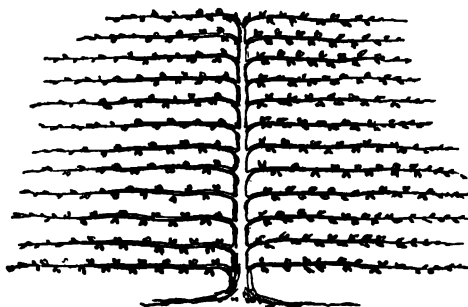

Horizontal Form.

trees have become large enough to require it all for themselves. Garden-walls are generally 12 or 14 feet in height. Different modes of training wall-trees are practised, of which the principal are known as *fan training* and *horizontal training*. In the former, the branches are arranged like the spokes of



WALL-TREES—WALNUT.

a fan; in the latter, a main stem is led up, from which they are spread out horizontally on both sides. Different modes are preferred for different

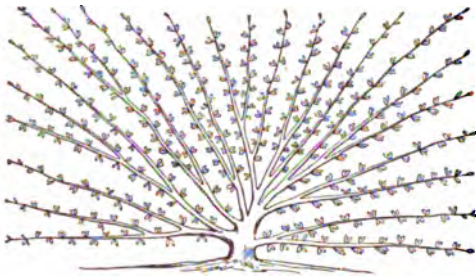

Fan Form.

kinds of trees, and the art of the gardener is displayed in keeping to his plan of training, and *laying* in branches so as completely to fill up the space, and make every part of the wall productive. There is a Dutch mode of training, which consists in leading two chief branches horizontally to right and left, and training shoots from them straight up to the top of the wall. It is seldom employed in Britain,

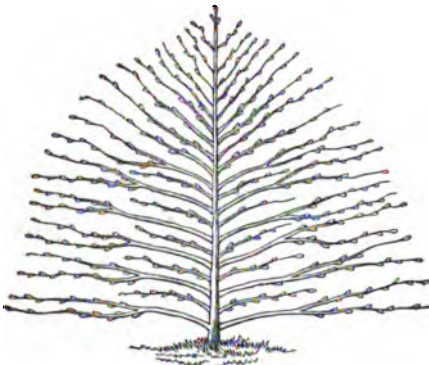

Half-fan.

except for white currants. Riders are not unfrequently trained in a star-like form, some branches being led downwards, in order to fill the wall as quickly as possible. It is necessary for the gardener, in training wall-trees, to consider the habit of each kind, particularly whether fruit is chiefly to be expected on young branches or on the *spurs* of older branches. Superfluous branches must in all cases be carefully removed, and amongst these are to be reckoned all *fore-right shoots*, or branches which project straight from the wall. The use of small strands of cloth, along with nails, to fasten branches to walls, is familiar to every one. These strands are renewed from year to year, so that they may not cause disease by interfering with the growth of the branches.

WALNUT (*Juglans*), a genus of beautiful trees of the natural order *Juglandaceæ*. This order is nearly allied to *Amentaceæ* (q. v.), and particularly to the sub-order *Cupuliferæ* (q. v.), or *Corylaceæ*, but differs in having the ovary one-celled, with a solitary erect ovule. The flowers are unisexual, the male flowers in catkins, the female in terminal clusters. The species, of which not quite thirty are known, are mostly natives of North America; a few

are found in Asia. All are trees with alternate pinnated leaves. The genus *Juglans* is distinguished by monoecious flowers, with 18—24 stamens; and a drupe with a deciduous fleshy husk, which bursts irregularly, and a deeply wrinkled shell (*putamen*) of two valves, within which is the seed, curiously lobed and wrinkled, with a membranaceous *testa* and partial dissepiments. The species of Hickory (q. v.) were formerly included in this genus.—The Common W. (*J. regia*) is a native of Persia and the Himalaya, but has long been cultivated in all parts of the south of Europe. The date of its introduction is unknown, but it was certainly cultivated by the



Walnut (*Juglans regia*).

Romans in the reign of Tiberius. It is a lofty tree of 60—90 feet; with large spreading branches. Its foliage resembles that of the ash. The leaves have 2—4 pair of leaflets, and a terminal one. They have a fine balsamic odour when bruised; this quality, however, being much more marked in some trees than in others. An infusion of them has been found useful in scrofula; and when bruised and rubbed on the skin, they are efficacious in curing itch. Placed in wardrobes, they prevent the ravages of moths. The sap is limpid like water, but contains much sugar, so that the tree is sometimes tapped for it, like the sugar-maple, and the sugar is procured by evaporation. A pleasant kind of wine is also made from it. An excellent pickle and a kind of ketchup are made of the unripe fruit. The ripe fruit is one of the best of nuts, and is an important article of export from many parts of the south of Europe. Walnuts are also exported in large quantities from Cashmere and other Himalayan regions to supply the markets of India. The outer husk is removed before the nuts are brought to market. In the south of Europe, walnuts are a very considerable article of food, and when perfectly fresh, they are wholesome and nutritious, although in the state in which they are imported into Britain they are not easily digestible. Just before they are ripe they are much used in France with vinegar, salt pepper, and shallots. Among the varieties of W. in cultivation is one with a very thin shell, which is much esteemed. Walnuts yield by expression a bland fixed oil, which, under the names of *Walnut Oil* and *Nut Oil*, is much used by painters, and in the countries in which it is produced is a common article of food. The *cake* left after the expression of the oil is sometimes used as an article of food, and is also used for feeding cattle and poultry. The timber of the W. is of great value, and is much

used by cabinetmakers. Gun-stocks are made of it. It is light, although hard and fine-grained. The wood of young trees is white and little esteemed; that of old trees is brown, veined and shaded with darker brown and black. The wood of the roots is beautifully veined. Both the root and the husks of the W. yield a dye, which is used for staining light-coloured woods brown. The W., when meant to become a timber-tree, is best sown where it is to remain, as the roots are much injured by transplanting. The best kinds of W. for fruit are generally grafted.—The W. succeeds well in Britain as an ornamental tree, even in the north of Scotland, although it seldom quite ripens its fruit except in the warmest parts of England. It was probably brought to England by the Romans. It takes its name from being foreign (A.-S. *wealh* or *walh*).—Very similar to the Common W. is the BLACK W. (*J. nigra*) of North America, found in most parts of the United States, except the most northern. It is a very large and beautiful tree, the trunk sometimes six or seven feet in diameter. The leaves have more numerous leaflets than those of the Common Walnut. The timber is even more valuable than that of the Common W., and is used for the same purposes. The fruit, however, is very inferior, although it is sold in the markets of American cities. The partial dissections of the kernel are thick and woody.—The BUTTER NUT (*J. cinerea*) is abundant in the northern and north-western states of North America, and in Canada. It is a tree only about 50 feet high, with trunk about a foot in diameter; leaves with 15—17 leaflets; the fruit elongated, and externally covered with a viscid substance. The nut is hard and rough, with prominent ridges, of good quality, and sometimes brought to market in America. The wood is not apt to split or warp, and is useful for many purposes. Sugar is obtained from the esp, as from that of the maple, but is of inferior quality. The inner bark is a mild cathartic, resembling rhubarb in its properties. The leaves, reduced to powder, are used for blistering, like cantharides.—To the natural order *Juglandaceæ* belongs the genus *Engelhardtia*, found in the Malayan Archipelago and the Himalaya. The wood of *E. Roxburghiana*, a Himalayan species, is much valued by turners.

WALPOLE, SIR ROBERT, third son of Robert Walpole, M.P., by Mary, daughter of Sir Jeffrey Burwell, was born August 26, 1676, at Houghton, in Norfolk. He received his education at Eton and at King's College, Cambridge. On July 30, 1700, he married Catharine, daughter of Sir John Shorter, Lord Mayor of London. On 28th November following, he succeeded to the family estates on the death of his father. In 1702, he was elected member of parliament for King's Lynn; and in 1705, he was nominated one of the council to Prince George of Denmark. In this latter capacity, he appears to have won the esteem of Godolphin, Marlborough, and other Whig leaders. In 1707, he was appointed Secretary at War; and in 1709, Treasurer of the Navy. Shortly after this, however, his fortunes suffered a temporary eclipse. He was found guilty by the House of Commons of 'a high breach of trust and notorious corruption,' and accordingly, on January 17, 1712, he was expelled the House, and sent to the Tower. There can be little doubt that he had all his life a profound faith in bribery, and never scrupled to exercise it; but his punishment on this occasion seems rather to have been the result of party animosity than of virtuous indignation on the part of the House. He had all along been a strong Hanoverian, and on the accession of George I., he was restored to fortune. He was made a privy-councillor, and had various other

high offices conferred upon him. On the impeachment of Bolingbroke and others by his means, he became, in 1715, Chancellor of the Exchequer, and First Lord of the Treasury. A disunion of the cabinet having arisen in 1717, he resigned office, bringing in a Sinking-fund Bill on the day of his resignation. In opposition, he was the determined enemy of the South Sea Scheme. He was recalled to office on the retirement of the Earl of Sunderland in 1721; and from this time to his final retirement in 1742, the life of W. may be said to be the history of England. In 1723, his son was created Baron Walpole. In 1737, his power was a good deal shaken by the disputes which had arisen between the king and the Prince of Wales; the latter siding with the Opposition, which began to grow very formidable in the questions which arose about this time between England and Spain. W. was opposed to war; the grand principle of his action being, according to Archdeacon Coxe, 'the love of peace;' according to Macaulay, however, his aim was not the peace of his country, but of his own administration. In 1740, a motion was made in the House to petition the king to remove Sir Robert W. 'from his Majesty's presence and counsels for ever.' This motion was negatived by a large majority; but the power of the great minister was evidently shaken. He resigned on 2d February 1742, when he was created Earl of Orford, with a pension of £4000 a year. Charges of bribery were now brought against him, and a committee of investigation was ultimately appointed by the House of Commons. It consisted of 21 members, of whom only two were of his own party. The Report was against him, but it was unsupported by evidence, and proceedings were ultimately dropped. The rest of W.'s life was spent in tranquillity and retirement. He died in 1745, aged 68. In private life, he was amiable and good-tempered. Love of power appears to have been his ruling motive of action. He had strong common sense, with clearness of political vision, and next to his own interest he had at heart the interest of his country. Doubtless, he bribed largely, but as Macaulay says: 'We might as well accuse the poor Lowland farmers who paid black-mail to Rob Roy, of corrupting the virtue of the Highlanders, as accuse Sir Robert Walpole of corrupting the virtue of parliament.'—See Coxe, *Memoir of Life and Administration of Sir Robert Walpole* (Lond. 1798); and Lord Macaulay's *Essay on Walpole's Letters to Sir Horace Mann*.

WALPOLE, HORACE, third son of Sir Robert Walpole, first Earl of Orford, was born in 1717. He was educated at Eton and Cambridge. After finishing his education, he travelled abroad for some years, principally in Italy, where he seems to have acquired those tastes for which he afterwards became so well known. In 1741, he returned to England, and took his seat in parliament. But he had no taste for politics, and never took any active part in public life. In 1747, he purchased a piece of ground near Twickenham. Here he built his famous mansion—Strawberry Hill. Its erection and decoration may almost be said to have formed the principal occupation of his long life. In 1758, he published his *Catalogue of Royal and Noble Authors*. This was followed by *The Castle of Otranto*, *The Mysterious Mother*, and the *Historic Doubts on the Life and Reign of Richard III.* The works, however, to which he owes the preservation of his name are his *Letters*. These will always be interesting as pictures and records of the society and fashionable gossip of his day. Their interest is, however, considerably marred by their palpable want of truthfulness. On the death of his nephew in 1791, he became fourth Earl of Orford. He died in his 80th

year on March 2, 1797. 'The faults of Horace Walpole's head and heart,' says Macaulay, 'are indeed sufficiently glaring. His writings, it is true, rank as high among the delicacies of intellectual epicures as the Strasbourg pie among the dishes described in the *Almanach des Gourmands*. But as the *piûs de joie gras* owes its excellence to the diseases of the wretched animal which furnishes it, and would be good for nothing if it were not made of livers preternaturally swollen, so none but an unhealthy and disorganised mind could have produced such literary luxuries as the works of Walpole. . . . The conformation of his mind was such that whatever was little seemed to him great, and whatever was great seemed to him little. Serious business was a trifle to him, and trifles were his serious business.'—See *Letters*, edited by Mr Peter Cunningham (8 vols., 1857); also Macaulay's *Essay on Letters of Horace Walpole*.

WALPURGA, or WALPURGIS, Sr (otherwise *Walburga*), followed her brothers St Wilibald and St Wunnibald (sons of a king of the West Saxons), in the time of St Boniface, from her native country, England, to Germany, to help them in extending Christianity. Wilibald established the bishopric of Eichstadt about 741; and Wunnibald, the neighbouring convent of Heidenheim about 745, the direction of which last W. undertook, after his death (about 763), as the first abbess, and continued till the end of her own life (778). Her bones, from which, according to the oldest biography, a miraculous healing oil flowed, were transferred to Eichstadt, where a convent was erected in her honour. That old biography was written towards the end of the 9th c. by a monk, Wolfhart, in the monastery of Hasenried, and contained, like all the later legends, which are based solely upon it, only a multitude of marvellous stories of the usual stamp. A somewhat more special significance lies in the trait that W. was not molested by biting dogs, and was in consequence invoked for protection against them and other ferocious animals. The veneration of W. became widespread. Throughout all Germany, and even in France, the Netherlands, and England, churches and chapels were dedicated to her, relics of her were shewn, and festivals celebrated in her honour. The feast of Walpurga falls properly on the 25th of February; but as in some German calendars it is assigned to the 1st of May, the name of W. has become associated, in a quite accidental way, with some of the most noted popular superstitions. The 1st of May had been one of the most sacred days of all paganism; it was the time of a great sacrificial festival, and of the old May assembly of the people. For centuries on the 1st of May, informal courts of justice continued to be held, the joyful May procession took place, and the kindling of the sacred May-fire. See BELTEIN. When afterwards the old heathen gods had been completely degraded into devils by the Christian missionaries, and when the belief in witchcraft had come in vogue, the Walpurgis-night obtained naturally a notorious significance, inasmuch as, during the night between the 30th of April and the 1st of May, the witches were held to ride on broom-sticks and he-goats to the old places of judgment and sacrifice, in order to enjoy themselves there with their master the devil. Such witch-hills were tolerably numerous in Germany and the neighbouring countries. The best known, however, was the highest point of the Harz, the Brocken, Brocks or Blocksberg, which has obtained a wide celebrity as the scene of the witches' Sabbath in Goethe's *Faust*.

WALRUS. See MORSE.

WALSALL, a municipal and parliamentary borough, Staffordshire, stands amid pleasing scenery on a small stream, an affluent of the Tame, eight miles north-north-west of Birmingham. Its public buildings are accounted more than usually handsome, and embrace a number of churches, a free grammar and other schools, and a number of charitable institutions. The iron manufacture, for which the situation of the town on the edge of the South Staffordshire mineral field affords facilities, is the staple branch of industry. Tanning, currying, the manufacture of harness and harness furniture, and of every description of leather goods, are extensively carried on. Coal and lime works are in operation in the vicinity, and there is an extensive trade in malt. W. returns one member to the House of Commons. Pop. (1871) 49,018.

WALSINGHAM, SIR FRANCIS, English statesman, of an ancient Kentish family, third and youngest son of William Walsingham of Scadbury, was born at Chislehurst, Kent, in 1536. He studied at King's College, Cambridge, and afterwards travelled on the continent, where he remained until the accession of Queen Elizabeth. Burleigh, with his usual discernment in selecting men of talent, discovered his abilities, brought him into office, and sent him on an embassy to France in August 1570. He remained in Paris until April 1573, and discharged diplomatic duties with such consummate skill that he was, on the recommendation of his great patron, appointed one of the principal secretaries of state to Elizabeth. He was also sworn of the privy council, and knighted. In 1578, he was sent on an important embassy to the Netherlands; in 1581, to France; and in 1583, to Scotland. He was, with some reason, regarded by the adherents of Mary, Queen of Scots, as the most insidious of her enemies in the English council. He contrived to intercept most of her letters, and after having deciphered them, sent them to their destination, in order to obtain fresh intelligence from their answers. Some of these deciphered letters are preserved in the British Museum. W. soon held Mary secure in the toils. Some time previous to September 1583, he had bribed to his service Cherelles, the secretary to the French ambassador Castellan, in whom Mary placed implicit confidence. W. also won over Gray, the envoy of the Duke of Guise and other friends of Mary to James VI. (James I. of England), who employed him to manage his correspondence with his mother and his friends in France. The most secret letters of Mary and of James thus came into the hands of Walsingham. Up to Babington's conspiracy, or, as some have called it, W.'s conspiracy, there was no evidence for charging Mary with being accessory to any of the plots formed against the life of Elizabeth. The real fountain-head of this conspiracy, and the chief confederates, were spies in the pay of W., and all the correspondence of Mary and her friends passed into the hands of Elizabeth's dexterous minister. After the discovery and execution of Babington, &c., W. went to Fotheringay as one of the commission to try Queen Mary. She charged him with having forged the correspondence produced against her, when W. rose in his place and solemnly called God to witness that he had not done anything unworthy of an honest man, and that he was wholly free from malice. Elizabeth signed her death-warrant with a jest on W.'s hatred of the Queen of Scots. She had ordered Davison to bring her the warrant, and when she had signed it she said: 'Go; tell all this to Walsingham, who is now sick; though I fear he will die for sorrow when he hears it.' W. was distinguished even among the ministers of Elizabeth for acuteness of penetration, extensive knowledge of public affairs, and profound acquaint-

ance with human nature. His administration of foreign affairs was founded on the system of bribery, espionage, and deception. He is said to have had in his pay 53 agents and 18 spies, in various countries; and no minister was better informed of the intrigues of foreign courts. Notwithstanding this diplomatic duplicity, which was then universal among public men, W.'s personal integrity and disinterested patriotism are undoubted. He was of strict morals, favoured the Puritan party, and in his later days gave himself up to religious meditation. He retired from public affairs some time before his death, and resided at his house in Barn Elms, where he died, April 6, 1690. Elizabeth was ready enough to acknowledge his diligence, genius, and important services, yet she kept him poor. There remain in the British Museum (Harleian MSS.) various letters from W. complaining of his being wholly unable, on his scanty appointments, to support his establishment, though very inadequate to his dignity of ambassador in France. Camden says he died so far in debt that he was buried privately by night in St Paul's Church, without any funeral solemnity. The queen was chary even in conferring honours upon him, for he received nothing but his knighthood, and held no offices when he resigned the charge of foreign affairs. He was married, and his daughter Frances became successively the wife of Sir Philip Sidney, of the brilliant and unfortunate Earl of Essex, and of the brave soldier, Richard de Burgh, 4th Earl of Clanricarde.

**WALTHAM**, a village of Massachusetts, U. S., on Charles River and the Fitchburg Railway, ten miles north-by-west from Boston, has a broad street of handsome residences, and manufactories of bleached cotton goods, hollow iron-ware, machinery, chemicals, boots and shoes, and machine-made watches, of which 10,000 are made a year. Pop. (1870) 9065.

**WALTHAM ABBEY**, a market-town in the county of Essex, on the banks of the Lea, 13 miles north of the east part of London, on the Great Eastern Railway. It contains a spacious Norman church, originally belonging to an abbey. The river Lea here divides into several branches, which are made to turn a number of gunpowder and flour mills belonging to government. Enfield Lock, at which is situated the celebrated government factory for rifles, &c. (see **SMALL-ARMS FACTORIES, ROYAL**), is about a mile distant; and many of the hands there employed live in and around Waltham Abbey. A weekly newspaper is published. Pop. (1871) 5197.

**WALTHER VON DER VOGELWEIDE**, the greatest and most famous Minnesinger (q. v.) of the middle ages, was born 1165—1170, in Franconia or in Austria. Although his family was noble, he had no possessions, and became a minstrel as much, perhaps, from necessity as from impulse. His master and early model was the elder Reinmar. It is thought that his first public performances in 'singing and saying' date from about 1187; soon after which, he found a warm patron in Friedrich the Catholic, Duke of Austria. But this prince having died in 1198, W. began the life of a wandering minstrel, in the course of which he visited the courts of most of the German sovereigns. A few details of his career are known. He twice (1199 and 1205) spent some time at the court of the Emperor Philip; and then lived six years at Eisenach with a generous patron, Hermann, Landgraf of Thuringia. During 1214—1215, he repeatedly visited the Emperor Otho, by whom, as well as by Philip, he seems to have been treated with unkingly parsimony. From 1217 to 1219, he lived with Duke

Bernhard in Carinthia, then returned to Austria, and in 1220 received from Friedrich II. a small estate at Würzburg. He died about the beginning of 1228. His grave has long been pointed out in the Laurence Garden of the cathedral of Würzburg; but a new monument was erected to him in 1843. W. far excelled his master Reinmar, whom he survived about 20 years, both in matter and style; while in richness and versatility of mind all the other Minnesingers must stand far behind him; for, to his wide sympathies and matured art, all themes were alike: tenderness and depth, no less than cheerfulness and gaiety, deep earnestness, as well as playful raillery. He did not confine himself, like Reinmar, to minnelays, but wrote also hymns, eulogies of his patrons, and didactic pieces. He sang of the duties and dignities of the emperor; of the obligations of princes and vassals; of the rights and wrongs of the question between the pope and the emperor; of the glory of the true church; and often his song conveyed earnest and cutting censure. But it was only on conviction that he gave praise or blame, never influenced by favour or prejudice; and his censures of the church were those of a candid but pious believer. From a decided patriotic feeling, he stood firmly by the empire and the emperor in opposing the pretensions and usurpations of the pope. His writings on this subject had a widespread and powerful effect; they alienated, according to the testimony of a contemporary, Thomasin, thousands from the pope, and determined the politics, so to speak, of the German poets for the whole century. W. was soon recognised by his contemporaries as the master of lyric poetry; and the traditions of the later Minnesinger schools place him among the twelve who, in the Emperor Otho the Great's time, originated and established the noble art of minstrelsy. Lechmann brought out a masterly critical edition of W.'s writings (Berl. 1827, 3d. ed. 1853); and Simrock an excellent translation (with explanations by Simrock and Wackernagel, 2 vols. Berl. 1833; 2d. ed. Leip. 1853); Uhland wrote a beautiful account of his life and writings (*W. von der Vogelweide, ein alideutscher Dichter*, Stuttgart, and Tüb. 1822); and Hornig, a complete *Glossarium* to his poems (Quedlinb. 1844).—See Reuss, *W. von der Vogelweide* (Würzb. 1843); Menzel, *Das Leben W.'s von der Vogelweide* (Leip. 1865).

**WALTON, ISAAC**, author of the *Complete Angler*, was the son of one Jervis Walton, a yeoman, and was born at Stafford on 9th of August 1593. Of his earlier life, not much is certainly known. In the year 1624, we find him settled in Fleet Street, London, and carrying on business there as a hosier. In the end of 1626, he married Rachel Floud, a descendant of Archbishop Cranmer. From George Craemer, her uncle, who had been a pupil and friend of Hooker, it is thought likely that W. derived much of the material for his *Life* of that eminent man. In August 1640, she died in giving birth to a daughter, having before had two sons, neither of whom survived her. In 1643, W. retired from business with such a modest competence as sufficed for the simple way of life he affected; and in 1647 he married a second time. The lady was Anne Kenn, half-sister of the well-known bishop of that name. She bore to him a daughter and two sons, only one of whom lived, and died in 1662, to the great grief of her husband, who survived her many years. He died on the 15th December 1683, at the great age of ninety, in the house of Dr Hawkins, his son-in-law, prebendary of Winchester Cathedral, and was buried in the vault of that sanctuary.

With the celebrated Dr John Donne, who died in 1631, W., who attended his ministry, had been on

terms of affectionate intimacy; and on the publication of his sermons in 1640, he was induced to preface them with a Life of the author. This, his first publication, was followed by Lives of Hooker, Sir Henry Wotton, and George Herbert, in succession; the whole four being reissued in a collected edition in 1670. In 1678, the life of his friend, Bishop Sanderson, was added. *The Complete Angler, or Contemplative Man's Recreation*, was published in 1655. A fac-simile of the original edition was published in 1875, and, from first to last, more than fifty editions have appeared. To the edition of 1676, a little treatise on Fly-fishing was added by Walton's friend, Charles Cotton, in a fishing-house built by whom, on the banks of the river Dove, many of the later days of his happy and blameless life lapsed peacefully in the pursuit of his favourite recreation. *The Complete Angler*, as a treatise on the art of angling, may be regarded as in good part obsolete, but it continues and will continue to be read for its charming simplicity of manner, its pastoral freshness and poetry, and the pure, peaceful, and pious spirit which is breathed from its quaint old pages. The Lives, though somewhat less widely known, are in their kind not less exquisite and unique. Wordsworth has dedicated to them a beautiful sonnet, in which he speaks of the five saintly names of the subjects of them as

Satellites burning in a lucid ring  
Around meek Walton's heavenly memory.

**WALTZ** (Ger. *Wälzer*, literally, roller), a national German dance, said to have originally come from Bohemia. It first became a fashionable dance in the other countries in the early part of the 19th century. It is danced to music of  $\frac{3}{4}$  time by any number of couples, who, with the gentleman's right arm round his partner's waist, wheel rapidly round on an axis of their own, advancing at the same time round the room. Some time ago the *Valse à Deux Temps* was generally adopted—a form of the waltz not so graceful as the older one, because not so correspondent to the rhythm of the music—but this has now given place to the *Valse à Trois Temps*.

**WAMPUM**, a name given to shells and shell-beads, used as money, and worn for ornaments in strings and belts by the North American Indians.

**WANDERING JEW**. See **JEW**, THE WANDERING.

**WANDEROO'**, a name which has been given to several species of monkey. The species commonly described under the name is *Macacus silenus* or *Silenus veter*, a native of the coast of Malabar, a monkey of rather large size, deep black throughout, except a ruff of long gray or white hair, from the midst of which the face looks forth, and which descends over the chest, giving the animal a very peculiar aspect. This monkey exhibits considerable intelligence and docility, and performs its tricks with an absurd air of gravity.—The name *W.*, however, more properly belongs to monkeys of the genus *Presbytes*, natives of Ceylon, to which it is given by the Singhalese, and appears to have been transferred by mistake to the species just described, which is not found in Ceylon. The wanderoos of Ceylon are all small monkeys. The best known species is *Presbytes cephalopterus*, found in the low parts of the island. It feeds chiefly on the berries and buds of trees, and is seldom seen on the ground. Twenty or thirty are generally found together in a troop. When alarmed, they display marvellous agility in leaping, or rather swinging from branch to branch, using their powerful arms alternately, often flinging themselves obliquely so as to catch the lower bough of an opposite tree, and taking advantage of its

rebound to carry them up again till they can reach a higher branch; the females, all the while, being often encumbered by their young, which cling to them. This monkey is far from being so mischievous as monkeys in general. 'In captivity, it is remarkable for the gravity of its demeanour, and for an



Wanderoo Monkey (*Macacus silenus*).

air of melancholy in its expression and movements, which is completely in character with its snowy beard and venerable aspect.'—Tennent's *Ceylon*. Its disposition is extremely gentle and affectionate, it is intelligent and docile, and very cleanly in its habits.—Several other species of *W.* or *Presbytes* are found in Ceylon, some of them in the more elevated parts of the island.

**WANTAGE**, a market-town in Berkshire, in the Vale of the White Horse, 26 miles west of Reading, and 60 west of London. It manufactures agricultural implements, and has an extensive trade in corn. Pop. (1871) 3295.

**WAPENSHAW** (Sax. *wæpen*, weapon, and *scawan*, to shew), a periodical gathering of the people, instituted by various Scots statutes, for the purpose of exhibiting their arms, these statutes directing each individual to be armed on a scale proportioned to his property. There are numerous Scots acts of the 15th and 16th centuries regulating the subject of wapenshaws. In the time of war or rebellion, proclamations were issued charging all sheriffs and magistrates of burghs to direct the attendants of the respective wapenshawings to join the king's host. During the reign of the later Stuarts, attendance on the wapenshaws was enforced with considerable strictness; and in addition to military exercises, sports and pastimes were carried on by authority at these gatherings. The Covenanters, in consequence of these sports being of a kind disapproved of by them, did what they could to discourage attendance on the wapenshaws.

**WAPENTAKE** (Sax. *wæpen*, arms, and *tae*, touch), a name given in Yorkshire to the territorial divisions of the county, similar to what, in most of the other counties of England are called *hundreds*, and in the more northern counties, *wards*. The term has come down from Anglo-Saxon times, where it, in the first instance, signified the assemblies of each district held for the administration of justice and like purposes, at which each vassal attended armed, and 'touched' the spear of his overlord, in token of homage. From the assembly, the word

was transferred to signify the district within which it was convened.

WA'PITI (*Cervus Canadensis*), a species of deer, nearly allied to the stag, but considerably exceeding it in size, being  $4\frac{1}{2}$  feet in height at the shoulder. It is a native of North America, found as far south as Carolina, and as far north as  $56^{\circ}$  or  $57^{\circ}$  N. lat. It is yellowish brown on the upper parts; the sides gray; a pale yellowish patch on each buttock, bounded by a black line on the thigh; the neck, a mixture of red and black, with long, coarse, black



Wapiti (*Cervus Canadensis*).

hair falling down from it in front like a dewlap; a black mark at each angle of the mouth. The hair is crisp and hard, but there is a soft down beneath it. The antlers are large, much like those of the stag, but the first branch bends down almost over the face. The W. is called *Elk* and *Gray Moose* in some parts of America, although very different from the true elk, or moose deer. It is found chiefly in low grounds, or in parts of the forest adjacent to savannahs and marshes. Its flesh is coarse and dry. The hide makes excellent leather.

WAR between states or nations, or between parties in the same state (*civil war*), is analogous to club-law (Ger. *faustrecht*), or the law of the strongest, among the individuals of a community, which is the normal state of things where no legal or fixed rights are established, or where there is no authority to enforce them. The prevalence of war among nations is thus an indication of the imperfection, or the total want, of international law. If the sentiment of brotherhood were universally diffused, and a system of international morality established and generally accepted together with an organisation for putting it in force, we can conceive the necessity for war to cease. And although the full realisation of this state of things may never be attained, it is nevertheless the ideal goal to which all real progress tends. But it by no means follows that in the present condition of the world, while the sentiment of international justice is yet in embryo, peace at any price is to be preferred to war. When a community is in a state of anarchy, the individual man must take the law into his own hands, and defend his life and his rights with violence if need be; and nations in similar circumstances must do the same. The Balance of Power (q. v.), the shape in which the sentiment of political morality in Europe seemed at

one time trying to crystallise itself, has gone again apparently into chaos.

Wars are various in their occasions and objects, sometimes breaking out in consequence of disputes about territorial possessions or material interests; at other times, having reference to the establishment of some important point of civil or religious liberty. In all cases, the aim of each contending party is to weaken and overthrow the opposing party. At one time, the art of war was supposed to consist very much in wearing out the enemy by a slow process of exhaustion, and thus wars were much protracted; but more recently the greatest generals have adopted the method of rather endeavouring to strike sudden and terrible blows, by which the war is sooner brought to a termination; and this method, although it may often have been adopted without regard to considerations of humanity, is, in all probability, less productive of suffering to mankind than the other.

Amongst rude nations, wars are conducted by tumultuary hosts, suddenly congregated, and in general, either after defeat or victory, soon dispersed. But the wars of the more civilised and powerful nations have long been conducted by armies carefully trained and disciplined; and in the case of maritime powers, by means of fleets at sea as well as of armies on land. Preparation for war amongst such nations requires not only the forming and training of the army, but vast provision in many various ways of the means and *matériel* of war. Much science and skill are also applied to the conduct of military operations, and the principles upon which they ought to be conducted have been carefully investigated, and theories tested by an examination of the history of the most important campaigns. See STRATEGY, TACTICS.

In the progress of society, certain *usages of war* have come to be generally recognised. These, of course, have varied at different times, and in different parts of the world, according to the state of civilisation and the prevalent feelings of the time: they are also subject to modification from causes less general. But the changes which have taken place in them during the lapse of ages have been in general favourable to the interests of humanity. Prisoners of war are no longer put to death, nor are they reduced to slavery, as was once very frequently the case, but their treatment has become generally more and more mild and kind. It is a well-understood rule, however, that a prisoner of war obtaining his liberty by exchange or otherwise, with the condition of not serving again during a fixed period against the same power, forfeits his life if he is found so serving and is again taken prisoner. Amongst all civilised nations, quarter is granted in battle whenever it is sought; and there are certain usages universally prevalent with regard to the capitulation of fortified places, and of bodies of troops hopelessly hemmed in by superior forces, &c.

*War-cries* for mutual recognition and encouragement in battle have always been common, each rude nation or tribe having its own. The ancient war-cry of the English was *Saint George!* that of the Spaniards, *San Jago!* and that of the French, *Montjoie Saint Denis!* In the feuds of the middle ages, each party, or the retainers of each noble family, had a distinctive war-cry. Sometimes the war-cry was the name of the family. Thus, in Scotland, the retainers of the noble Houses of Douglas and of Home rushed into battle with the cry of *A Douglas!* or *A Home!* or *A Home!* The French armies under Napoleon were accustomed to charge with shouts of *Vive l'Empereur!*

The invention of gunpowder has effected great changes in the whole art of war; but the introduction of firearms has rendered battles less sanguinary

and ferocious than they previously were. Whilst firearms were yet unknown, warlike engines of various kinds were employed; but close combat was more general, and often more protracted, and the passions of the combatants had thus in ordinary battle more of that exasperation which fearfully characterises the storming of a town.

WARASDIN, capital of a county in the Austrian kingdom of Croatia, upon the right bank of the Drave, and 28 miles north-north-east of Agram. It is to some extent fortified, is surrounded by straggling suburbs, and contains nine churches, a few convents, and a gymnasium. Silk-spinning is carried on; and stoneware, wine, and tobacco are manufactured. Pop. (1869) 10,623.

WARBLER, a popular name often applied to all the birds of the family *Sylviadae* (q. v.), many of which, however, commonly receive other popular names, as the Blackcap, Nightingale, Hedge-sparrow, Red-breast, Redstart, Stonechat, Wheatear, Whitethroat, &c. (q. v.), while many receive the name Warbler with some adjunct. Several British species, commonly thus designated, belong to the genus *Salicaria*, others to the genus *Sylvia*. The species of the former genus have the tail rounded; in the latter, it is almost square or a little forked. The *Salicarias* are also inhabitants of moist situations, whence they are known as *Sedge Warblers* and *Reed Warblers*; the *Sylvias* are inhabitants of woods. Of the former genus is the GRASSHOPPER W. (*Salicaria locustella*), not unfrequent in many parts of England, and found also in the south of Scotland and in Ireland. It is found in most parts of the centre and south of Europe, at least during summer, being partially a bird of passage. It is of a greenish brown colour, the centres of the feathers dark brown, producing a spotted appearance; the lower parts pale brown. It is a shy bird, hiding itself in hedges and bushes, but very active often darting out like a mouse from

chin and throat white; the under parts buff colour.—The REED W. (*Salicaria arundinacea*) is found in summer in marshy situations in the south of England; it abounds in Holland and in many parts of Europe, and its range extends to the north of India. It is of a uniform pale brown, with a tinge of chestnut; the chin and throat white; the under parts pale buff colour. Its nest is remarkable; it is attached to the stems of three or four reeds, and



Nest of Reed Warbler.

formed by winding the branches of their panicles together with a little wool; and is conical and deep, so that the eggs or young may not be shaken out when the reeds are shaken by the wind.—The WOOD W., also known as WOOD WREN (*Sylvia sylvicola*), is common in the wooded districts of England, in summer, particularly in old plantations of oak and beech. It is olive green, tinged with yellow, the wings brown, the primaries and secondaries edged with bright yellow, the tertials with a broader edge of yellowish white; the lower parts yellow and white.—The WILLOW W. (*Sylvia trochilus*) is very common in the south of England in summer, but more rare in northern parts of Britain. It frequents woods, shrubberies, thick hedgerows, and bushes; but builds its nest on the ground. It is of a dull olive-green colour, the wing and tail feathers dark brown, the wing-feathers edged with green; the under parts whitish, slightly tinged with yellow. The tail is slightly notched. There are other British species of more rare occurrence.—Numerous species of W. are found in North America, migratory birds, which spend the winter in more southern regions. Not a few of the same species are therefore reckoned among the birds of the West Indies. Some of the European species are in like manner found in Africa; and Asia has many species of W., among which some of the European species are included. Australia has many species of W., some of which are of very beautiful plumage.

WARBURTON, WILLIAM, a distinguished English divine, commonly known as Bishop Warburton, was born at Newark, in the county of Nottingham, on the 24th December 1698. He was the eldest son of George Warburton, an attorney of that place, who claimed descent from an old Cheshire family. Young W. received his education at the school of his native town, and afterwards at Oakham in Rutlandshire, which he left in the year 1714.



1, Sedge Warbler (*Salicaria phragmitis*); 2, Willow Warbler (*Sylvia trochilus*).

the bottom of the hedge, and receives its name from its chirping, grasshopper-like note.—The SEDGE W. (*Salicaria phragmitis*) is the most common British species of *Salicaria*, and is generally found in thick patches of reeds or willows in marshes, or in other situations close to water, and where the aquatic herbage is thick and strong. It abounds on the marshy banks of the Thames. It is of a brown colour, exhibiting various shades, finely intermixed; the

returning home to pursue the profession of his father, who had died some years before. Having served the necessary apprenticeship, he practised as an attorney at Newark for some years, but with no distinguished success. His natural bent was towards literature; and he had all along expressed a desire to take orders in the Church of England. Finally, he quitted the legal profession with this object in view; and having gone through the necessary course of study, he was presented, by Sir Robert Sutton, in 1728, to the rectory of Brand-Broughton, in the diocese of Lincoln, where he remained for many years. After publishing some comparatively unimportant pieces, he issued, in 1736, a treatise, entitled *The Alliance between Church and State; or the Necessity and Equity of an Established Religion and a Test Law*. This work, which is still recognised as one of the most masterly statements of the subject from the point of view of the writer, drew great and immediate attention; and in January 1737—1738, it was followed by the first volume of the *opus magnum*, on which his fame as a theologian must mainly continue to rest. This celebrated work, *The Divine Legation of Moses, demonstrated on the Principles of a Religious Deist, from the Omission of the Doctrine of a Future State of Rewards and Punishments in the Jewish Dispensation*, though it encountered a storm of adverse criticism, to which the writer thought it necessary to reply in *A Vindication, &c.*, at once established the position of W. as one of the most potent intellects of the period; and though its main argument has since been extensively discredited as more or less 'precarious,' not the less the book, in virtue of its vast learning, its vigour, and originality, will always maintain its reputation, as one of the master-pieces of the great period of our English theology. In 1739, a new and revised edition of the first part of the work appeared. This was followed, in 1741, by the publication of the second part; and the third and concluding section, rather supplementary to the argument than essential to it, was only given to the world after the death of the writer.

Becoming involved in the controversy which followed the appearance of Pope's *Essay on Man*, W. undertook the defence of the poet, and, in 1739—1740, issued a series of seven letters, entitled *A Vindication of Mr Pope's Essay on Man, by the Author of the Divine Legation*. The poet was much gratified; and between him and his vindicator a warm friendship was the result, which only terminated with the death of Pope, in 1744. He died, bequeathing to W. one-half of his library, and such profit as might accrue from any edition of his works published after his death. To Pope, W. was indebted for opportunities of cultivating the friendship of some of the most distinguished men of the time—among others, of the well-known Ralph Allen, of Prior Park, near Bath, to whose niece, Miss Gertrude Tucker, he was married in 1745.

Though W.'s important services to literature and religion were admitted, they did not for a long time bring him any very great recognition in the way of substantial preferment. On the appearance of *The Divine Legation*, indeed, he had been appointed Chaplain to the Prince of Wales; and in 1746, nearly ten years later, the Society of Lincoln's Inn unanimously elected him to be their preacher. In 1757, he was promoted to the deanery of Bristol; and finally, in 1760, Mr Pitt, afterwards Earl of Chatham, bestowed on him the bishopric of Gloucester, declaring that 'nothing of a private nature, since he had been in office, had given him so much pleasure' as this exercise of his patronage. In the later years of his life, his mind became seriously impaired; and he was utterly prostrated

by the loss of his only son, whom he did not long survive. He died on 7th June 1779.

W. was a keen polemic, and deeply engaged in all the intellectual warfare of his time. In nearly everything he wrote, there is the impress of a vigorous and fertile mind, with an arrogance of tone, which tends, in his treatment of adversaries, to degenerate into truculence and scurrility. In addition to those already mentioned, it seems sufficient to give the titles of a few of his more notable performances. In 1750, appeared his *Julian, or a Discourse concerning the Earthquake and Fiery Eruption which defeated that Emperor's Attempt to rebuild the Temple at Jerusalem, apropos of Dr Middleton's Inquiry concerning the Miraculous Powers of the Christian Church*. Shortly after came two volumes entitled *The Principles of Natural and Revealed Religion occasionally Opened and Explained*; and in 1755, *A View of Bolingbroke's Philosophy, in a Series of Letters to a Friend*, which was held to be much the ablest of all the answers to Bolingbroke which appeared. In 1757, he attacked Hume, in a publication entitled *Remarks on Mr David Hume's Natural History of Religion, by a Gentleman of Cambridge, in a Letter to the Rev. Dr Warburton*. The blind deceived no one; and if we may estimate the success of the attack by the annoyance it gave the philosopher, his allusions to 'that low fellow Warburton' may be held to indicate success. In 1747, he went somewhat out of his way to issue an edition of Shakspeare, with notes critical and emendatory, which last, though ingenious, and occasionally happy, did not greatly add to his reputation. A complete and splendid edition of his works was published in 1788, at the expense of his widow, by his friend, Bishop Hurd, who preface'd it with a biography.

WARD, EDWARD MATTHEW, R.A., an eminent painter of the present day, was born in the year 1816, in London. He early displayed a taste for art, and was educated in a way to develop it. In 1834, he was sent to study at the Royal Academy; and two years after, he went to Rome, where he remained for some time, gaining, in 1838, a silver medal, given by the Academy of St Luke. He returned to England in 1839, making on the way a short visit to Munich, where he had lessons in fresco-painting from the celebrated Cornelius. After his return, he annually exhibited pictures at the Royal Academy, though for some years without any very decisive recognition. In 1843, he competed unsuccessfully for the decoration of Westminster Hall and the Houses of Parliament, his large cartoon specimen, 'Boadicea,' being generally adjudged a failure. In the same year, however, he made a very 'palpable hit' by his picture, familiar to every one as engraved, 'Dr Johnson perusing the Manuscript of the Vicar of Wakefield.' His steady progress thenceforward, in the estimation of connoisseurs and the public, is sufficiently marked by the fact, that in 1853, having previously, as we noted above, failed in the public competition for the work at Westminster, he was solicited by the Fine Arts Commissioners to aid in this national undertaking. Of the eight cartoons which he engaged himself to furnish, all have now been completed. The merit of these is unquestioned; and one of them in particular, 'The Last Sleep of Argyll,' is ranked by competent judges as one of the most masterly works in this kind which our country has as yet produced. In further recognition of his merits, Mr W. was, in 1847, elected an Associate of the Royal Academy; and in 1855, he attained the full honour of Academician. Of the works of an artist so well known, it would be idle to attempt a catalogue. A few of the more notable are: 'The Fall of Clarendon,' 'Interview between Charles II. and Nell



## WARDEN—WARDÖEHUUS.

Gwyn,' 'The Royal Family of France in the Prison of the Temple,' 'Charlotte Corday led to Execution,' 'Jeannie Deans,' 'The Earl of Leicester and Amy Robsart,' 'Juliet and the Friar,' 'Luther's First Study of the Bible,' 'Baxter and Jeffreys,' and 'Doctor Goldsmith.' In technical execution, Mr W. must be admitted a master; if he fails a little commonly, on the side of penetrative power and genuine imaginative realisation, it would be unfair to say that his failure is conspicuous.—His wife, HENRIETTA WARD, is also favourably known as a painter, and is the grand-daughter of James Ward, R.A.

**WARDEN**, an officer appointed for the naval or military protection of some particular district of country. In order to keep the districts of England adjoining to Scotland and Wales in an attitude of defence, great officers, called Lords Wardens of the marches, were appointed, to whom the duty of protecting the frontier was committed. From this source originated the name *ward*, applied to the subdivisions of the counties of Cumberland, Westmoreland, and Durham—a term afterwards extended to divisions of a city, town, or burgh adopted for municipal purposes. The custodian of Dover Castle was created by William the Conqueror warden of the Cinque Ports (q. v.), and guardian of the adjacent coast; an office comprising extensive jurisdiction, civil, naval, and military, the greater part of which was taken away by 18 and 19 Vict. c. 48.—As to the Lord Warden of the Stannaries, see **STANNARIES**.

**WAR DEPARTMENT**, the entire administration of the military affairs of the nation. It includes the purely military command under the **COMMANDER-IN-CHIEF**, and the civil administration under the Surveyor-General of the Ordnance, and the Financial Secretary. This latter includes the manufacture of warlike stores, and their custody; the formation of defensive works; the paying, feeding, punishing, curing, arming, carrying, &c. of the army. The National Surveys form also a part of this department. The whole department is controlled by the Secretary of State for War. See **WAR OFFICE**.

**WARDHOLDING**, the military tenure of land in Scotland under the feudal system, by which the vassal was bound to serve the superior in war whenever called on to do so. As the military duties of the vassal could not be performed when he was under age, the superior had a right both to the guardianship of his person and to the possession of his fee during his minority. An arrangement, however, was frequently made by which this right was commuted into an annual payment, in which case the fee was said to be held in *Taxed Ward*. When an unmarried vassal succeeded, the superior was entitled to a sum proportionate to the value of the estate, called the *Avail of Marriage*; and a larger sum, called the *Double Avail of Marriage*, was due when the superior named a wife for his vassal, and the vassal, rejecting her, married another woman. If a vassal alienated his lands or the larger portion of them without consent of his superior, the fee fell to the superior by what was called the casualty of *Recognition*, which was a check on vassals impoverishing themselves to such an extent as would render them unfit to perform feudal services. Wardholding was abolished by 20 Geo. II. c. 50, as a system hazardous to the public tranquillity, such fees as were held ward of the crown being converted into *Blanch* (q. v.) holdings, and those held of subjects becoming feu-holdings, a yearly sum being made payable to the superior, as a recompense for the casualties which were done away with.

**WARDIAN CASES**, close glass cases placed upon a trough containing soil, and accurately fitted to it, intended for the growth of plants in the

windows of apartments. Remarkable success has attended the use of them even in the smoky atmosphere of the largest towns. Ferns and other plants may now be seen in great beauty and luxuriance in



Wardian Case.

these cases in the windows of houses in London and in all the cities of Britain. They are especially adapted to those plants which require an atmosphere more moist than that of an inhabited apartment can ordinarily be. They derive their name from the inventor, Mr W. B. Ward of London. To the success attending them, the invention and frequent use of *vivaria* for marine animals is with great probability attributed.

**WARDLAW**, RALPH, D.D., the most celebrated preacher and theologian in the roll of Scotch Independents, was a Seceder by extraction, and studied in connection with the Associate Secession Church. Before he had completed his curriculum, however, he had convinced himself that congregational independency was the scriptural system of church government. In 1800, he began to preach, and after some time settled in Glasgow as pastor of an Independent church. In 1811, he was appointed Professor of Theology to the Congregational body in Scotland, in conjunction with the Rev. Greville Ewing; an office he retained, along with his pastorate, to the period of his death, which happened on the 17th December 1853. W.'s life was a very laborious and earnest one. Besides discharging faithfully and ably the duties of the pulpit and the professor's chair, he was a voluminous author, often involved in theological controversy, and a prominent actor in the public religious and philanthropical movements of the day. His intellect was acute, his understanding sound, and his style remarkable for its perspicacity, vigour, and grace. The most important of W.'s works are: *Discourses on the Socinian Controversy* (1813); *Lectures on Ecclesiastes* (2 vols. 1821); *Essays on Assurance of Faith, and on the Extent of the Atonement and Universal Pardon* (1830); *Discourses on the Sabbath* (1832); *Christian Ethics* (1833); *Discourses on the Nature and Extent of the Atonement of Christ* (1843); *The Life of Joseph and the Last Years of Jacob* (1845); *Congregational Independency* (1848); *On Miracles* (1852).—See *Life and Correspondence of Ralph Wardlaw*, by Dr Alexander (1856).

**WARDÖEHUUS**, a seaport in Norway, at the east extremity of Finmark, stands on the island Wardøe or Vardøe, and is protected by a fort, the most northerly fortification on the globe, being in lat. 70° 22'. The inhabitants, inclusive of the garrison of 24 men, number only 120. Not even potatoes or barley comes to maturity; and the few

cows that are kept have sometimes to be fed on herrings.

**WARDSHIP**, in English Feudal Law, was the guardianship which the feudal lord had of the land of his vassal while the latter was an infant or minor. Until the majority of the infant, the lord, out of the profits, provided a fit person to render the services incumbent on the vassal. See **TENURE**, **WARDHOLDING**.

**WARE**, a small market-town in Herts, 2½ miles north-east of Hertford. Malting, for which there are several establishments, most of them engaged in supplying the London breweries, is the principal employment. There is a silk-mill here, employing 200 hands, and two large paper-mills. In one of the inns of the town, is still to be seen the famous Bed of Ware, for a notice of which, see **BED**. Pop. (1871) 4917.

**WA'REHAM**, an exceedingly ancient though small town of Dorsetshire, stands between the rivers Piddle and Frome, 14 miles nearly due east from Dorchester. It was a British town, and afterwards a Roman station, and is surrounded by a British vallum or rampart of earth, which, although extremely ancient, is still about 30 feet high, and is perfect on three sides. The chief trade is the export of potter's clay; there are also breweries, malt-houses, and brick-fields. The borough, comprising the parishes of Holy Trinity, Lady Saint Mary, Saint Martin Arne, Bere Regis, Corfe Castle, and parts of the parishes of East Stoke and Morden, sends a member to parliament. Pop. (1871) 6532.

**WAREHOUSING SYSTEM** is a plan for lessening the pressure of excise or customs duties by postponing payment of them until the goods they are laid on pass to the consumer, or, at all events, to the retail dealer. A merchant who might import a thousand pounds worth of wine or tobacco, if he only paid duty on it by instalments as it went out to the dealer, would be quite unable to import so much if he had to pay somewhere from one to five thousand pounds of duty on its arrival. The system of bonded warehouses was hence adopted. The taxable commodity thus came to be locked up in a government warehouse, and the duty to be paid on its removal, along with a proportional fee or rent for the custody of the article, or its accommodation in government premises. Bonding in this manner was part of the scheme of Sir Robert Walpole in 1733, generally known as the Excise Scheme; which was defeated from its unpopularity. The system was first authorised by an act of George III. in 1802. When the customs laws were from time to time consolidated, the Warehousing Act formed a portion of the consolidation. In the consolidation of 1846, there was a separate 'Act for the Warehousing of Goods.' In the latest consolidation of 1853, the warehousing system is embodied in clauses 41 to 113 inclusive of the general 'Customs Consolidation Act' (16 and 17 Vict. c. 107). This process, by which the crown holds in custody the goods of private persons, has produced some curious effects on mercantile law and trading practices. When transactions have taken place about bonded goods, should they be injured or destroyed, it may come to be a question of nice adjustment who is to bear the loss, seeing there is not possession to shew ownership; and still nicer questions sometimes arise as to whether such goods are or are not part of a bankrupt estate. There is a difficulty in securing money upon goods without transferring their absolute possession, as in the case of pledging or pawning. The warehousing system, however, by retaining the goods for the owner, whoever he may be, has created a complete system of paper-money in the

transference of the title-deeds, as they may be called, of such goods—the dock-warrants or other documents—the possession of which is equivalent to possession of the goods.

**WARM-BLOODED ANIMALS**. Under this title are included those vertebrates which possess a four-chambered heart and spongy lungs; the heart and lungs being so arranged that the whole of the venous or impure blood is propelled over the large but closely-packed capillary area of the lungs, by successive contractions of a special ventricle, receiving it from a distinct auricle (these being called the right or pulmonary ventricle and auricle), while the blood thus purified by the action of the air in the lungs is conveyed to another auricle, and propelled over the whole system by a second distinct ventricle (these being known as the left or somatic auricle and ventricle). The only animals which exhibit these structural peculiarities are mammals and birds. In man and in the ox, the mean temperature of the interior of the body is 100°; in the mouse, it is 99°; while in the whale it is 103°. In birds, it ranges, in different species, from 106° to 112°. The warm-blooded animals present, however, gradations of their heat-making power. In the hibernating animals, there is commonly a loss of heat, of from 10° to 20°, during their winter-sleep; and in the bat, the temperature falls to 40°. In the cold-blooded animals, the fishes, amphibians, and reptiles, the temperature of the blood rarely exceeds that of the surrounding medium. For the general characters of the warm-blooded animals, the reader is referred to the articles **BIRDS** and **MAMMALIA**.

**WARMING AND VENTILATION**. **WARMING**.—A certain temperature, constant within narrow limits, is essential for the life of warm-blooded animals, and the heat by which this temperature is maintained is produced by the vital actions of the body itself. See **ANIMAL HEAT**, **TEMPERATURE OF THE BODY**. In the case of man, however, at least in ordinary climates, and in the civilised condition, the heat of the body, if allowed freely to escape, would be dissipated faster than it is produced; and hence arises the necessity of clothing, houses, and other means of retarding its escape. To allow the body to continue depressed in temperature beyond the natural state, instead of hardening, infallibly weakens its vitality, and sows the seeds of disease; and that this error is committed on a vast scale, in Britain more especially, is apparent enough. The Reports of the Registrar-general shew that, exactly as the thermometer sinks, the rate of mortality rises and certain diseases of the most fatal kind become more prevalent; the vitality, in short, of the community decreases as the warmth of the atmosphere decreases. Could this be, if the means taken to arrest the waste of heat from our bodies, or to supplement it, were not, for the majority of men and women, insufficient, or injudiciously managed? This is a matter of literally 'vital' moment to one and all. The economy of heat is a primary element in the art of living in health and comfort; and 'no knowledge of common things' that we can think of can surpass in importance a right understanding of the principles and facts on which that art rests.

Where fuel is scarce the resource against the cold of winter is thick clothing indoors as well as out. This is said to be the regular practice in China; and even in the south of Europe, fires are dispensed with in weather when we should think them absolutely necessary, and additional wrappings are considered as appropriate while sitting in the house, as in the open air. But wherever fuel can be had, it is always preferred to wear

within doors much the same clothing in winter as in summer, and to keep the apartments nearly at summer temperature by artificial heat. It is this special branch of the subject, viz., the artificial warming of apartments, that we are at present to consider; and in doing so, we presume the reader to be acquainted with the more general facts regarding the generation of heat by combustion, and its diffusion, as stated in the articles COMBUSTION, FLAME, FUEL, HEAT.

The great aim, it may be premised, in all plans of warming is, as it is expressed by Dr Arnott, 'to obtain everywhere on earth at will, the temperature most congenial to the human constitution, and air as pure as blows on a hill-top.' The obtaining of the desired temperature would be comparatively easy by itself; the difficulty lies in combining warmth with pure air. Warming and ventilation are thus in some degree antagonistic operations, and are therefore best treated in one article. The various plans of warming hitherto tried may be classed under the four heads of—The Open Fire, Stoves, Gas, Steam and Hot Water.

*The Open Fire.*—The first application of artificial warmth consisted, most likely, in lighting a fire of dried sticks and leaves in a grove, a cave, or other natural shelter. When tents or wigwags came to be erected, the fire would be lighted on the middle of the floor, with perhaps a hole in the roof for the smoke to escape by. This primitive arrangement may still be seen in some of the cabins of Ireland and the Scottish Highlands. The Romans warmed their apartments chiefly by portable stoves or chafing-dishes, without any regular exit for the smoke and fumes; and a brasier of charcoal is still the chief means of heating sitting-rooms in Spain and Italy, which are in general without chimneys. The Chimney (q. v.) is a modern invention.

The open coal-fire glowing in a grate, which is the prevalent mode of warming dwelling-houses in Britain, has an air of cheerfulness and comfort, and a power of concentrating the whole family in one social circle, that make it almost an object of worship; but it is not without serious drawbacks, the most serious of which is the waste of fuel it occasions. About one-half of the heat produced by a common fire ascends with the smoke—the black part of the smoke itself being an unconsumed part of the fuel—while about a fourth of the heat which is radiated into the apartment is, in ordinary circumstances, carried into the chimney between the fire and the mantel-piece, and thus lost. It was calculated by Dr Arnott, that only about one-eighth part of the heat-producing power of the fuel used in common fires is realised, all the rest being dissipated into the surrounding atmosphere. A common fire gives also a partial kind of warmth, heating the side of the body next to it, but leaving the rest cold; and it produces draughts into our rooms which are anything but safe or agreeable. Notwithstanding these and other acknowledged evils, the open fire continues to hold its place, partly perhaps from prejudice, partly from real points of superiority over other methods as yet practised; and the object of late has been, not so much to do it away, as to improve it.

*Grates.*—One improvement consists in diminishing the quantity of metal in immediate contact with the fuel, and forming the back and sides of the grate of fire-bricks. The bricks act like clothing, and keep in the heat of the coals, thus rendering the combustion more complete, and the fire far hotter; while iron, being a good conductor, runs away with the heat as fast as it is generated, and passes it into the wall, making the coals that touch it dull and black. The same quantity of fuel,

therefore, burned in a brick-lined grate, not only produces more heat, but throws a greater proportion of that heat out into the room, and less up the flue and through the wall, than when it is surrounded by a mass of iron; for radiation depends more upon the intensity of heat than upon its quantity.

Another point deserving attention is the shape given to the chimney-mouth, or recess above the grate. When the sides are square with the back, none of the heat falling on them is given out again into the room. With a view, therefore, to throw out the heat better, the sides, or *coverings*, as they are called, are inclined to the back at an angle of about 130°; and sometimes they are made curved and of polished metal, in order that they may reflect the heat without absorbing it. It is questionable if simple brick slabs, placed at the proper angle, do not throw out more heat than the most splendid polished metal plates; for though the bricks do not reflect the rays of the fire, they become heated themselves, and then radiate their heat into the room. Plates of rough metal absorb the heat that falls upon them as the brick does; but being good conductors, the heat passes through them into the wall, and thus they never become hot enough to radiate sensibly.

Much also depends upon the shape of the fire-box, or grate itself. To see the importance of this, it is necessary to attend carefully to the exact way in which an open fire heats a room. It does so almost entirely by the rays of heat that it throws out; and these rays do not warm the air directly; they pass through it like light through glass, just as the hottest rays of the sun pass through the upper atmosphere, leaving it cold enough to freeze mercury. It is only when the rays of the fire fall on the floor, furniture, and walls of the room, that they give out their heat; and it is by coming in contact with these solid heated bodies that the air is gradually warmed. We may thus see the necessity of having a fire lighted and burning brightly for a considerable time before the hour when the apartment is expected to be comfortable.

The law that radiant heat neither affects nor is affected by the surrounding air, also explains the fact that an apartment may feel very cold, though the air in it be at high summer heat. A church or other massive stone building in frosty weather may be filled with artificially-heated air and yet retain its chilling effect for many hours. The warmth of the living body is lost in two ways: the film of colder air that touches it receives part of its heat by conduction, and rising up makes room for another film to do the same; a moderately heated body in cooling, is robbed of about half its heat in this way. The other half is given off in rays, which pass through the air, and impinge upon the objects around. These objects are radiating back heat in return; but their temperature being low, the return is small, and the warmer body is colder by the difference. Hence we are chilled by a cold wall or a cold window without touching it, and though the air between us and it may be at 70°.—To return to the shape of the grate.

The chief object is to present as large a surface as possible of glowing fire to the front. With this view, the grate is made long and deep, in proportion to its width from front to back. This principle, however, is carried too far in many grates. The stratum of fuel is too thin to burn perfectly, especially in the narrow angles at the sides, where the coals seldom get to a red heat, and are only warm enough to distil away in smoke. Such fires are constantly going out, and are further from being economical than a square box.

The practice recently come into vogue of placing

grates almost on a level with the floor, is also a mistake. The floor and the lower part of the person receive no share of the radiant heat.

The chimney-throat, instead of a gulf drawing in a constant wide current of the warm air of the room, and causing draughts from windows and doors towards the fireplace, should just be sufficient to admit the burned gases and smoke that come directly from the fire, and no more. See CHIMNEY. This is the object of the movable plate in what are called *register-grates*.

It would be endless to attempt to enumerate the various forms of grate constructed, with more or less success, on the above principles. We shall content ourselves with a notice of the recent invention of the late Dr Arnott, to whom the subject of warming apartments is more indebted than to any individual since the days of Count Rumford. It comes nearer to the idea of perfection in an open fireplace than any previous contrivance. Its peculiar advantages will be understood from the following description:

*Arnott's Smokeless Grate*.—*ab*, *ef* (fig. 1), represent the front bars of a grate in a chimney of the usual construction, *rsuv*. The grate has no bottom, and

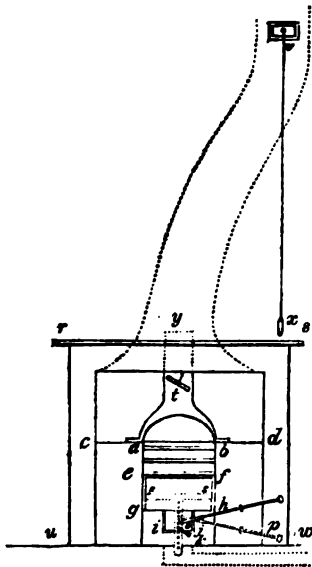

Fig. 1.

below it is an iron box, open only at top, into which the charge of coal for the day—from twenty to thirty pounds—is put. Any kind of coke or coal may be used. To light the fire, the usual quantity of wood is laid on the surface of the fresh coal at *ef*, and a thickness of three or four inches of cinders or coked coal, left from the fire of the preceding day, is laid over all. The wood being then lighted, very rapidly ignites the cinder above, and at the same time the pitchy vapour from the fresh coal below, rises through the wood-flame and cinders, and becomes heated sufficiently itself to become flame, and so to augment the blaze. When the cinder is once fairly ignited, all the bitumen rising through it afterwards burns, and the fire remains smokeless.

As there is no supply of air but through the bars in front, the box being close underneath, the fire must be gradually raised up as the combustion goes on; and this is effected by having a false bottom, *as*, in the box, which can be moved like a piston by means of a rod. The rod has notches in it, and, by

means of the poker used as a lever, can be raised up and then retained at any height by a ratchet-catch. When the piston comes level with the bottom bar of the grate, the coals may be replenished while the fire is burning, by pushing in a flat shovel over the piston, so as to form a temporary bottom to the grate, and support the fire, while the piston is allowed to descend to the bottom. The shovel is then raised up a little in front, or a part of the upper edge of the box is made to fold down, and fresh coals are shot into the box; on which the shovel is withdrawn, and the combustion goes on as before.

'A remarkable and very valuable quality of this fire is, its tenacity of life, so to speak, or its little tendency to be extinguished.' Even after it sinks below the level of the box, it does not go out, but continues to smoulder slowly for a whole day or night, and is ready to burn up actively when the piston is raised.

Another peculiarity of the Arnott grate is the means taken to diminish the proportion of the heat usually carried up the chimney. Of the thick column of smoke that issues from a common chimney-can, only a small fraction is true smoke or burned air; the rest consists of the warmest air of the room, which becomes mixed with the true smoke in the large space usually left between the top of the fire and the throat of the chimney. 'The whole of the air so contaminated, and which may be in volume twenty, fifty, or even a hundred times greater than that of the true smoke, or burned air, is then all called smoke, and must all be allowed to ascend away from the room, that none of the true smoke may remain. It is evident, then, that if a cover or hood of metal be placed over a fire, as represented by the letters *ysb* in the diagram—or if, which is better, the space over the fire be equally contracted by brickwork, so as to prevent the diffusion of the true smoke, or the entrance of pure air from around to mix with it, except just what is necessary to burn the inflammable gases which rise with the true smoke—there will be a great economy. This is done in the new fireplace, with a saving of from one-third to one-half of the fuel required to maintain a desired temperature. In a room, the three dimensions of which are fifteen feet, thirteen feet and a half, and twelve feet, with two large windows, the coal burned to maintain a temperature of 65° in cold winter days has been eighteen pounds for nineteen hours, or less than a pound per hour.'—*Arnott's Warming and Ventilation*.

The hood is furnished with a throttle-valve or damper, *t*, having an external index, shewing its position, so as to give complete control over the current. The provision made for ventilation in this fireplace is considered further on.

Even in this, perhaps the most economical form of open fire yet contrived, there is still great waste of the heat actually produced by the combustion. To say nothing of what passes by conduction from the fire itself into the wall, and is mostly lost; the quantity carried off in combination with the hot gases, though no more air is allowed to enter than is necessary for complete combustion, is still great. It deserves being noticed, that the proportion thus carried off is greatest in the case of fuel that burns with flame. Experiment shews that a fire of wood radiates one-quarter of its heat, the rest flying up; while the radiation from wood-charcoal is one-half of the whole heat produced. Every one has felt that a *blazing* fire has far less warming effect than a glowing one. Not that flame has not intense heat in it—more intense even than a glowing fire; but it gives it out only by contact, and not by radiation. It thus appears that any mode of heating that

depends upon direct radiation, as the open fireplace chiefly does, necessarily involves great waste of fuel. This can be avoided only by applying the heat on a different principle, which consists in first making the fire heat certain apparatus with considerable surface, which then, by radiation and contact with the air of the apartment, diffuses its heat throughout it. This is the principle of the other methods of warming, which we now proceed to describe. The consideration of methods that combine the two principles, will come most conveniently last.

*Warming by Stoves.*—A close stove is simply an enclosure of metal, brick, or earthenware, which is heated by burning a fire within it, and then gives out its heat to the air by contact, and to surrounding objects by radiation. The simplest, and, so far as mere temperature is concerned, the most effective and economical of all warming arrangements, is what is called the Dutch stove; which is simply a hollow cylinder or other form of iron standing on the floor, close at top, and having bars near the bottom on which the fire rests. The door by which the coals are put in being kept shut, the air for combustion enters below the grate; and a pipe, issuing from near the top, carries the smoke into a flue in the wall. If this pipe is made long enough, by giving it, if necessary, one or more bends, the heated gases from the fire may be made to give out nearly all their heat into the metal before they enter the wall; and thus the whole heat of the combustion remains in the room.

The great objection to this form of stove is, that the metal is apt to become overheated, which not only gives rise to accidents, but has a hurtful effect upon the air. The exact nature of the change that highly heated metal produces upon air is not very well understood. It cannot be said to burn it, in the proper sense of the word, for none of its oxygen is abstracted, but it gives it a peculiar odour, which is both unpleasant and unwholesome. This is thought to arise in some measure at least from the hot iron burning the particles of dust that light on it, which particles consist of organic matter, such as wool, wood, &c.

Part at least of the unwholesomeness of air so heated arises from its excessive dryness; it parches and withers everything it touches, like the African simoom. It must not, however, be supposed that this is peculiar to air heated by contact with metal; *air suddenly heated is always unwholesomely dry.* This is an important point in regard to the subject of warming, and requires consideration. A cubic foot of air, say at 32°, can contain a certain quantity of moisture and no more; but if heated to 80°, it is capable of containing *five* times as much, and has thus become *thirsty*, and drinks up moisture from everything that contains any. The heating of air, therefore, does not dry it, in the sense of taking moisture from it, it only renders it greedier of more; and this is equally true whether it is heated by a stove or an open fire. The chief difference is, that in the latter case the warming is more gradual, and no part of the air becomes very highly heated; while the air that touches a metal plate near redness is all at once rendered intensely thirsty, and before its fierceness is tempered by thoroughly mixing with the rest of the atmosphere of the room, must be highly pernicious. But whenever the temperature within doors is much higher than without, the air is in a too thirsty state, and parches the skin and lungs, unless means be taken to supply the necessary moisture. *An evaporating pan or other contrivance is an essential part of warming apparatus;* it is specially necessary to attend to this during east

winds, which are generally too dry even at their natural temperature.

All improvements on this simple and rude form of stove aim at avoiding a high heat in the warming surface, and this chiefly by lining the fire-box with brick, and enclosing it in several casings, so as to enlarge the heated surface. A general notion of these contrivances may be got from the annexed cut (fig. 2), representing the kind of stove called a *cockle*.

The fire is burned in a small furnace within the inner case, and the air is warmed by circulating between the inner and outer cases. When placed in the apartment or hall to be warmed, the outer casing has perforations about the top for the issue of the warm air. For heating churches and similar buildings, the stove is placed in a separate furnace-room, and the warm air is conveyed to the different parts of the building in pipes or flues, while fresh air is drawn to the stove through a channel or culvert leading from outside the building to the openings in the outer casing, where the arrows are seen entering.

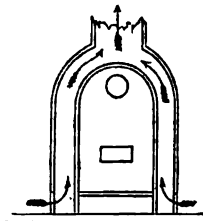

Fig. 2.

The stove invented by Dr Arnott is upon the same principle of an extensive and moderately warm heating surface. Under a sense of professional honour, Dr Arnott did not take out a patent for his stove; it was therefore made by many furnishing ironmongers in the metropolis and elsewhere, some of whom took out patents for what they considered as improvements upon it. No fewer than twelve patents were taken out in one year for modifications of this stove, *all of which Dr Arnott considered to be upon false principles.* The consequence has been, that many Arnott stoves, which had been introduced into houses, have been given up on account of the inconvenience felt from the species of heat which they generated. It is also, however, to be observed that the stove, made even upon the most approved principles, requires certain adjuncts and conditions in order to operate healthfully and agreeably.

The accompanying figure represents the Arnott stove in the most improved form given to it by the

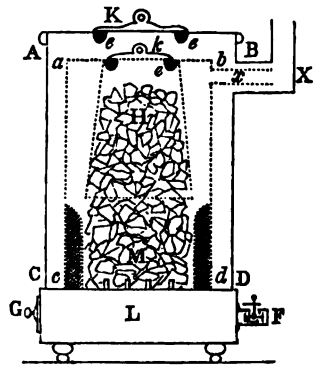

Fig. 3.

inventor. We give the description in his own words. 'The complete self-regulating stove may indeed be considered as a close stove, with an external case, and certain additions and modifications now to be described. The dotted lines and

small letters mark the internal stove, and the entire lines, the external case or covering. The letters ABCD mark the external case, which prevents the intense heat of the inner stove, *abcd*, from damaging the air of the room. F is the regulating-valve, for admitting the air to feed the fire. It may be placed near the ashpit door, or wherever more convenient. The letters *ff* mark the fire-brick lining of the fire-box or grate, which prevents such cooling of the ignited mass as might interfere with the steady combustion. H is a hopper, or receptacle with open mouth below, suspended above the fire like a bell, to hold a sufficient charge of coal for 24 hours or more, which coal always falls down of itself, as that below it in the fire-box is consumed. The hopper may at any time be refilled with coal from above, through the lid, *k*, of the hopper, and the other lid, *K*, of the outer case. These lids are rendered nearly air-tight by sand-joints; that is, by their outer edges or circumference being turned down, and made to dip into grooves filled with sand, as at *e, e*. The burned air or smoke from the fire, *M*, rises up in the space between the hopper and the inner stove-case, to pass away by the internal flue, *x*, into the other flue, *X*, of the outer case. *I* is the ashpit under the fire-bars. *G* is the ashpit door, which must be carefully fitted to shut in an air-tight manner, by grinding its face or otherwise. *M* is the coal intensely ignited below where the fresh air maintains combustion, but colder gradually as it is further up. Only the coal in the fire-grate below, where the fresh air has access to it through the fire-bars, can be in a state of active combustion. The self-regulating valve above mentioned is an ingenious contrivance by which the passage for the air is rendered narrower according to the force of the draught. Dr Arnott describes various other plans of effecting the self-regulation of the combustion.

A drawer inserted into the heated chamber of the stove would serve for cooking meat, and a pot for boiling might be placed upon the fire-box; it is therefore, as the inventor remarks, peculiarly the *poor man's stove*. Or, by making the space between the two casings water-tight, a *water-stove* is produced, which, besides securing a regulated heat, offers many other conveniences.

In Russia, many parts of Germany, and other northern countries of Europe, the stoves are usually built of brick, covered with porcelain. They are of the size of a large and very high chest of drawers, and usually stand in a corner of the room. The fire is burned in a furnace near the bottom, and the heated smoke is made repeatedly to traverse the structure from side to side, along a winding passage, before it reaches the top, where a pipe conveys it, now comparatively cold, into a flue in the wall. The heated mass of brick continues to warm the room long after the fuel is burned. It is generally sufficient to warm the stove once a day. The same quantity of wood burned in an open grate would be consumed in an hour, and would hardly be felt.

*Open-fire Stoves.*—As a specimen of the numerous plans for combining the advantages of the stove and the open fire, we may take Sylvester's stove or grate, which is thus described in Ronalds and Richardson's *Technology*: 'The fuel is placed upon a grate, the bars of which are even with the floor of the room. The sides and top of these stoves are constructed of double casings of iron, and in the sides a series of vertical plates, parallel with the front facing, are included in the interior, which collect, by conduction, a great portion of the heat generated from the fire—the mass of metal of which these are composed being so proportioned to the fuel consumed, that the whole can never rise above

the temperature of 212° F. under any circumstances. The sides and top of the stove are thus converted into a hot chamber, offering an extensive surface of heated metal; at the bottom, by an opening in the ornamental part, the air is allowed to enter, and rises as it becomes warmed, traversing in its ascent the different compartments formed by the hot parallel plates, and is allowed to escape at the top by some similar opening into the room.' The Sylvester stove can either be placed in an ordinary chimney recess, or be made to stand ornamentally forward into the room. The feeding-draught may be either taken directly from the apartment, or brought by flues from the outside of the building.

The idea of having an air-chamber behind and around the fireplace, from which warm air would issue into the room, thus saving part at least of the vast amount of heat that is lost by passing through the wall, is not new, having been put in practice by the Cardinal Polignac in the beginning of last century. But the way to carry the principle out to the full would be to have the open fireplace in a pier of masonry standing isolated from the wall, like a German porcelain stove. A very small fire would keep the whole mass mildly heated. The pier could receive any shape, so as to give it architectural effect; and it might either terminate in the room—the smoke, after parting with most of its heat, being conducted by a pipe into the wall—or it might be continued into the story above, where its heat would still be sufficient to warm a bedroom. An Arnott smokeless grate, set in the pedestal of an ornamental column, which might either stand in front of the wall or in a niche in its depth, might be made the *beau-ideal* of comfort, economy, and elegance.

*Warming by Gas.*—A prejudice arose against gas as a medium of heat, from the first attempts to employ it being made in an unskilful way. But when care is taken to carry off the products of combustion by a pipe, and to prevent overheating, gas-stoves will be found economical and pleasant, and capable of being used in situations where a common stove is inadmissible.

In stoves, gas should always be burned with the Bunsen burner, which is generally employed by chemists when they make use of gas for heating purposes. It consists of a small brass cylinder, or chimney, set over the gas-jet, like the glass of an argand lamp, with openings near the bottom to allow air to enter. The gas being admitted into this before lighting, mixes with the air, and when lighted at the top, which is usually covered with wire-gauze or perforated metal, burns with a pale-blue flame. The most complete combustion and the greatest heat are obtained in this way. Smoke, properly so called, there is none. Still, it must not be forgot that there is burned air—a cubic foot of carbonic acid, besides a quantity of watery vapour, for every cubic foot of gas used; and therefore, even with the Bunsen burner, these gaseous products should, wherever it is possible, be conducted away.

A pleasant and very serviceable gas-stove might be constructed by making the casing double, to contain water. It has been ascertained that a gallon of water may be brought to the boiling-point in 20 minutes by burning 4 cubic feet of gas, which, at 4s. 6d. per 1000 feet, costs less than a farthing. The cost of doing the same by a newly-lighted coal-fire is more than threefold.

*Steam and Hot Water.*—The immediate warming agent in these two methods is the same as in Arnott's and other low-temperature stoves—viz., an extensive metallic surface moderately heated; but instead of heating these surfaces by direct contact with the fire, the heat is first communicated to

## WARMING AND VENTILATION.

water or steam, and thence to the metal of a system of pipes. This affords great facility in distributing the heat at will over all parts of a building; and these methods are peculiarly adapted to factories, workshops, and other large establishments. Other advantages are—freedom from dust, and from all risk of overheating and ignition.

**Steam.**—Steam-warming is generally adopted in establishments where steam-power is used, as the same boiler and furnace serve both purposes. When steam enters a cold vessel, it is condensed into water, and at the same time gives out its latent heat till the vessel is raised to 212°, when the condensation ceases. The condensing vessel is usually a cast-iron pipe placed round the wall of the apartment near the floor. In admitting fresh air into the room it may be made to pass over this pipe, and thus be warmed. The steam is conducted from the boiler by a smaller tube, which may be covered with list or other material, to prevent all condensation by the way; and the admission of the steam is regulated by a cock within the apartment, means being provided for allowing the air to escape. Where a pipe cannot be laid round the room, a coil of pipe may be formed, or the steam may be admitted into a large vessel or into a hollow statue, forming a steam-stove. Allowance must be made for the expansion of the tubes by heat; and they are so arranged that the condensed water is conveyed back to the boiler. One round of iron pipe, of four inches diameter, is quite sufficient to warm each of the large apartments or stories of the printing-office from which the present work issues.

There can be no proper comparison between this plan of heating and that of common fireplaces. Coal-fires cannot warm the air in large workshops; the heat is confined to their own immediate neighbourhood; hence the workmen are often obliged to draw near the grate to warm themselves. According to the plan here adopted, every part of the house is equally heated, and the whole of the workmen are as comfortable during the hardest frosts as if they were working in a pleasant summer day. It is difficult to estimate the expense of supplying the heat, seeing that the steam happens to be drawn from a boiler which is always in operation for other purposes. Excellent, however, as the process is, it is for many reasons unsuited to private dwelling-houses.

In calculating how much surface of steam-pipe will be sufficient to warm a room, it is customary to allow about 1 foot square for every 6 feet of single glass window, of usual thickness; as much for every 120 feet of wall, roof, and ceiling, of ordinary material and thickness; and as much for every 6 cubic feet of hot air escaping per minute as ventilation, and replaced by cold air.

**Hot Water.**—Hot-water apparatus was applied as early as 1777 by M. Bonne-main, in Paris, to warm the hot-houses at the Jardin des Plantes, as well as for the artificial hatching of chickens. It was first introduced into England by the Marquis de Chabannes in 1816, and is now used in many large buildings. It is more economical than steam, except where a steam-boiler is required for machinery; and from this and other advantages, it is generally preferred to steam-apparatus. One of these advantages is, that the heat begins to be distributed, in some degree, as soon as the fire is lighted, while with steam-apparatus the whole of the water must be at boiling-heat before any steam enters the pipes.

There are two kinds of hot-water apparatus—high-pressure and low-pressure. In the first, the water is confined, and can be heated to any degree; in the other, it is open to the air, and cannot be

heated above 212°. Fig. 4 will explain the way in which water is made to carry the heat of a furnace to any part of a building by the low-pressure method. *a* is a boiler, from the top of which a tube issues, and after circulating through the building, re-enters near the bottom. At the top of the circuit, there is a funnel, or a small cistern, *c*, by which the tubes and boiler may be kept full. When the fire is lighted at the bottom of the boiler, the heated portion of water, being lighter than the rest, rises towards the top through the tube, *bb*, while the colder water from *dd* flows in to take its place. The tube is made to traverse the apartments to be warmed, where it gives out its heat to the air; the returning portion of the pipe is thus always colder, and therefore heavier than the other, so that the circulation is constantly kept up. The warming surface is increased, wherever it is necessary, by coiling the pipe, or by making expansions upon it of various forms, so as to constitute water-stoves.

To avoid the necessity of so large a surface, and such a mass of water as is required at the low temperature the water attains in the pipes of this kind of apparatus, Mr Perkins introduced the high-pressure system. In this, the pipe is made comparatively small, but very strong, and is formed into an endless circuit cut off from the atmosphere. The water is heated by making a number of coils of the pipe itself pass through the furnace; and as the whole circuit forms a shut vessel, as it were, the temperature may be raised to 300° and upwards, according to the strength of the pipes. This high temperature causes a rapid circulation. A compendious and readily understood specimen of the apparatus, calculated for a house of three stories, is presented in the accompanying engraving. In filling the tube with water, which enters at *b*, care is taken to expel all the air; and at *a* there is an expansion of the tube, equal to 15 or 20 per cent. of the capacity of the whole, which is left empty both of water and air, to allow for the expansion of the water when heated. The arrangement of the pipe may be various: the plan generally followed is to place a considerable coil of it within a pedestal or bunker, with open trellis-work in front, in a convenient part of the room. It may also be made to wind round the room, behind the skirting-board, which, being perforated with holes, will allow of the entrance of the warmed air.

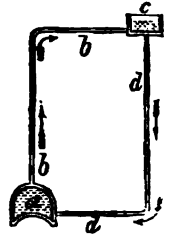

Fig. 4.

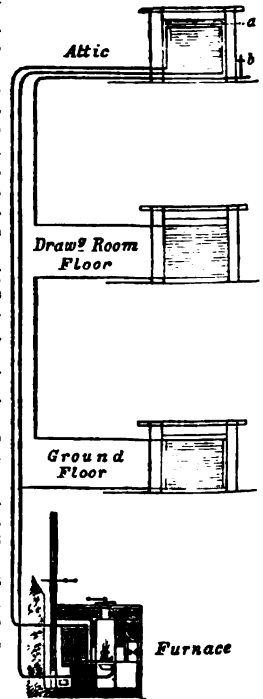

Fig. 5.

heated. The arrangement of the pipe may be various: the plan generally followed is to place a considerable coil of it within a pedestal or bunker, with open trellis-work in front, in a convenient part of the room. It may also be made to wind round the room, behind the skirting-board, which, being perforated with holes, will allow of the entrance of the warmed air.

## WARMING AND VENTILATION.

The hot-water apparatus has been fitted up by Messrs Perkins and Heath in various public buildings, warehouses, and gentlemen's houses; and, while sufficiently effective for the desired end, it has been proved to be attended with as few drawbacks as any regulated mode of heating whatever. But there is a great obstacle to its general adoption in its expensiveness. The temperature also becomes at times so high as to cause a disagreeable odour. Another objection is its liability to burst; though, from the tubes being of malleable iron, such an accident causes more inconvenience than serious danger.

**Conservation of Warmth.**—The art of warming embraces not only the production and distribution of heat, but the construction of apartments with a view to prevent its escape. The way to effect this—setting aside in the meantime the necessity of renewing the air—is, in the first place, to make the walls, floor, windows, doors, &c. as impervious to air as possible, to prevent the heat from being carried off by currents; and in the next place, to make them bad conductors of heat. For this last purpose, the walls ought to be sufficiently thick, and, if possible, built of non-conducting materials. Solid iron would make a cold wall; wood, a warm one; and in this respect brick or porous stone is preferable to hard stone. But the chief element in a warm wall is that it be *double*, which every wall in effect is, when it is lined by a coating of plaster, kept apart from the wall itself by the laths. The plate of confined air between the two is the most effectual barrier to the passage of the heat outwards that could be contrived. By making iron walls double or cellular, with a lining of plaster, they might be rendered as warm as wadded. Windows are a great source of cold, not merely by admitting cold air, but by allowing the heat to pass by conduction through the thin glass. The air of the room that touches the window is robbed of its warmth, and is constantly descending in a cold stream towards the floor. There is thus a cold influence felt from a window, however close it is. This is partly arrested by window-blinds, shutters, and curtains, which check the flow of the air, and retard its carrying power. But a far more effectual plan is to have double windows: either two frames, or double panes in the same frame. The loss of heat by a double window is said to be only one-fourth of that by a single. Double windows are considered essential in countries where the winters are rigorous.

By carrying these principles far enough, we might succeed in well-nigh imprisoning the heat, and thus produce a house of ideal perfection, so far as mere temperature is concerned. But for the habitation of living beings, another condition, seemingly antagonistic to the former, is no less requisite—'air as free as that on a mountain-top.' In general practice, the two hostile conditions are not so much sought to be reconciled as compromised; and then, as usual, neither object is well attained. Circulation of air is got accidentally, through the imperfections of structure in our rooms—through the chinks and bad fittings of the windows, doors, floors, and the uneconomical fashion of our fireplaces. Were houses much better constructed than they are, the inmates would in many cases be suffocated outright, as they often partially are with the degree of perfection we have already attained. Neither the airing of our houses, nor the art of building them solid and warm, can advance to perfection, until the former be no longer left to chance, but be in every case secured by special apparatus capable of direct control. We now proceed to consider how this is sought to be attained; confining ourselves still to the leading

principles, and only noticing a few of the specific plans that have been put in practice.

**VENTILATION.**—The necessity of constantly renewing the air wherever living beings are breathing, arises chiefly from the effects produced upon air in the lungs (see RESPIRATION). The average quantity of carbonic acid in expired air or breath is found to be 4.3 per cent. by measure. Now this gas, when taken into the lungs, is a poison, and tends to arrest the vital processes. Like other poisons, however, it can be rendered harmless by *dilution*. The small proportion naturally existing in the atmosphere is perfectly innocuous, and may be considerably increased without sensible effect. But it is decidedly prejudicial to breathe for a long time air containing 1 measure in 100 of carbonic acid; and it is considered desirable that the proportion should never exceed 1 in 500. We may assume, then, what is near the truth, that 20 cubic feet of air pass through the lungs of a man in an hour. To reduce the poison of this to 1 per cent., at which point it is barely respirable, it requires to mingle with as much fresh air as will make a mixture of nearly 100 cubic feet; and to make the dilution at all safe, it must be carried five times as far. In other words, the respiration of one human being vitiates hourly about 500 cubic feet of air.

In addition to carbonic acid, expired air contains an undue amount of watery vapour. Minute quantities of animal matters are also exhaled with the breath, which in close ill-ventilated apartments form a clammy deposit on the furniture and walls, and, by putrefying, become organic poisons.

A further necessity for the constant renewal of fresh air arises wherever lights are burned. The deteriorated air of a fire goes off by the flue, but lights are generally burned where the products must mingle with the atmosphere of the apartment. Now, a pound of oil in burning consumes the oxygen of 13 feet of air, and produces a large amount of water in vapour, and also of carbonic acid. Every cubic foot of gas consumes the oxygen of 10 feet of air, and forms at least 1 foot of carbonic acid, besides watery vapour, sometimes mixed with sulphurous fumes.

To counteract these various sources of pollution, and keep the air sufficiently fresh and wholesome, in rooms where many persons are breathing, it is found in practice that on an average about 20 cubic feet of fresh air per minute for each individual must be supplied.

Ventilation consists of two operations—the removal of the foul air, and the introduction of fresh. Though neither operation can go on without the other going on at the same time, it is convenient to consider the two separately.

The agents employed in removing the air from apartments are chiefly two: that by which nature effects the ventilation of the earth on a grand scale, viz., the draught of ascending currents produced by difference of temperature; and mechanical force, such as pumping. The former is the more common, and is the only one applicable to private houses.

The column of air in the chimney of a lighted fireplace being expanded and comparatively light, exerts less than the prevailing pressure on the air immediately under and about its base. The air, therefore, below and around it pushes it up, and flows in to take its place; the velocity of the movement being in proportion to the height of the chimney and the degree of heat. Thus, although it is often convenient to speak of the air being *drawn* or *sucked* into the chimney, the force does not lie in the chimney, but in the greater pressure of the air behind.

Wherever, then, there is a heated chimney, there



is a means of removing the foul air. And in rooms moderately lofty and spacious, with windows and other fittings not closer than usual, and a chimney-mouth of the usual width, there is little risk, when there are only a few inmates, of any serious vitiation of the air. The heated breath that ascends to the ceiling has time to diffuse itself gradually, and be drawn in a diluted state into the currents that are setting from all quarters towards the chimney. These currents, however, are one great objection to this mode of ventilation, as they consist in great part of cold air that has just entered by the doors and windows, and are strongest where the inmates sit to enjoy the fire.

The ascent of foul air to the top of the room dictates its exit in that direction, rather than low down at the mouth of the chimney. It is conceived by some that the carbonic acid of the breath, from its greater weight, must be chiefly at the bottom of the room; but this is a mistake. The heated breath ascends instantly, because it is, as a whole, lighter than the air around it; and the carbonic acid in it does not tend to separate from it and fall down by its superior weight, but, by the law of the diffusion of gases, seeks to spread itself equally all over the room, and would do so though it were lying at first on the floor. It is on the principle of the foul air ascending at first to the top of a room, that Dr Arnott's ventilating-valve is contrived. The valve may be used to supplement the open-fire draught in small and crowded apartments, and is essential where the fire is burned in a close stove or in the smokeless grate. The valve is represented at *v*, fig. 1. An aperture is cut in the wall over the chimney, as near to the ceiling of the apartment as may be convenient. In this is suspended a valve, capable of opening inward to the chimney, but not in the other direction, by which means a return of smoke is prevented. The valve is so balanced on its centre of motion, that it settles in the closed position, but is easily opened. A flap of 36 square inches is sufficient, where there is good chimney-draught, for a full-sized room with company. This simple apparatus may be painted or otherwise made ornamental. It operates by virtue of the draught in the chimney. Whenever that is active from the presence of a fire, the valve is seen to open inwards, and a stream of air from the top of the apartment passes through into the chimney, and is carried off. The operation is precisely equivalent to the stream of air always passing into a chimney between the fire and the mantel-piece, but has the great superiority of draining off the most impure air in the room. A wire descends to a screw or peg fixed in the wall, by which the opening of the valve may be limited or altogether prevented. This is a far more efficient plan of ventilation than an open window, or an opening in the wall near the roof, leading merely to the outer air; where there is an open fire in the room, such openings rather admit a rush of cold air than let out the foul.

There is generally more or less draught in a chimney even without a fire, from the air within being slightly warmer than that without; and this action might be strengthened by burning a jet of gas within the ventilating aperture at *v*. Where a house is to be built new, some recommend having special ventilating-flues in the walls, separate from, but close to the fire-flues, so that the air may be heated, and an ascending current produced. In weather when fires are not required, the draught can be maintained by gas-jets at the entrances to the vents. This plan of causing a draught by gas is applicable to churches and apartments without fire-places.

Where a fire is burned for the express purpose of

producing a current of air, it is called ventilation by *fire-draught*. The plan has been exemplified with success in mines, where a fire being lighted at the bottom of a shaft, air is drawn off in all directions around, and sent up the shaft; to replace which, fresh air is constantly pouring down other shafts.

Many of our large buildings are ventilated by fire-draught. Fig. 6 shows an arrangement by

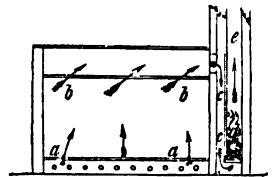

Fig. 6.

which a school or church may be ventilated: *aa*, the flooring perforated with holes, through which air, warmed by hot-water pipes, passes to the interior. The ceiling, *bb*, is perforated, leading to a chamber which communicates with a vertical flue, *cc*; which leads to the fireplace of the warming-apparatus, situated at the foot of a flue, *ed*. As the only air which reaches this must pass from *cc*, a constant current is maintained therein, and also through the apertures in the ceiling. Dr Reid exemplified this method, first in his own class-room in Edinburgh, and afterwards in various public buildings, among others, in the temporary House of Commons, erected after the burning of the old house in 1834. The plan was attended with some inconveniences—in fact, no plan can meet every contingency—but, notwithstanding the storm of hostile criticism that was raised at the time, Professor Tomlinson (*Treatise on Warming and Ventilation*, 1864) gives it as his opinion that, 'in the case of the temporary House of Commons, where all the arrangements were left in his own hands, he succeeded in the proposed object of removing the vitiated air, and keeping up a constant supply of warm or of cool air to fill its place.' The arrangements for warming and ventilating the present House of Commons are a modification of Dr Reid's plan.

In other cases, as at the prison in Millbank, warm air is admitted at the ceiling, and carried off by the draught of a chimney in connection with the sides or lower part of the rooms.

In these last-mentioned instances, the apparatus provides as well for the admission as for the removal of air. In ordinary dwellings, no special provision is in general made as to admission. It is, in fact, not absolutely necessary; for the removal of a portion of the air of a room never fails to secure the entrance of a fresh supply somewhere. Whenever the chimney-draught or other means removes a little of the pressure inside the room, the pressure without forces air through every opening and chink; and even, were there no actual openings, would force it through the porous substance of the structure—such as mortar, and even wood itself. But this irregular source of supply has various inconveniences. It often requires more force to strain the air in this manner than the draught is possessed of, and then the chimney smokes; it is smoke produced by this cause that is curable by opening the door or window. Another objection is, that impure air is often thus drawn into rooms from the lower parts of the building and from drains about the foundation. For these and other reasons, there ought, in all cases, to be a free and legitimate entrance provided for fresh air, so as to give a control over it; and this entrance should be independent of the windows. It is a much disputed point whereabouts in a room the air should be made to enter—some advocating openings for it near the floor, others near the ceiling; and it must be confessed that neither method has yet been

## WARMING AND VENTILATION.

rendered unobjectionable. One essential thing is, to prevent the air from rushing in with a strong current, by passing it through minute holes spread over a large space. A tube, for instance, leads from the outer air to a channel behind the skirting, or behind the cornice, and the air is allowed to issue into the room through minute holes, or through a long, narrow, and concealed opening covered with perforated zinc or wire-gauze. The passage or tube leading from outside the wall can be more or less closed by a valve regulated from the inside.

But the great difficulty lies in the coldness of the air directly introduced from the outside, whether by the doors and windows, or through channels in the walls; and all such plans of ventilation must be considered as imperfect make-shifts. The fresh air ought in every case to be warmed before being admitted, or, at least, before being allowed to circulate in a sitting-room. In the smokeless grate (fig. 1), the air is led directly from the outer atmosphere into a channel (1, 2) underneath the hearth, and escaping below the fender and about the fire, is warmed before spreading through the apartment. With stoves and heated pipes, the air should enter about the heated surface; in stoves on the cockle principle, the fresh air, as it enters, is made to pass between the casings of the stove. With an open fire, a very feasible plan is to make the fresh-air channel pass behind the fireplace, and allow the warmed air to escape from concealed openings about the chimney-piece and jambs, or from behind the skirting. In Condy's Ventilating-grate, the fire-box is constructed of hollow pieces of fire-brick communicating with the external atmosphere and with the room.

For a house with fireplaces of the usual construction, perhaps the simplest and most effective expedient is to admit the fresh air into the entrance-hall, and there warm it by means of a low-temperature stove or by hot-water pipes: its passage into the several rooms can then be provided for by regular channels, behind the skirting or otherwise. In America, perforations are frequently made in certain parts of the doors, before which silk curtains are disposed, so as to temper the currents. It is almost unaccountable that in this country the plan of warming the lobby and staircase is so seldom resorted to. To say nothing of the comfort thus diffused through the whole house, and the benefit in point of health, especially to weakly constitutions, the economy of the arrangement is beyond dispute. In the sitting-rooms, not more than one-half the usual quantity of fuel requires to be burned in the open fires; and in the bedrooms, as a rule, fires are rendered altogether unnecessary in the coldest weather. It ought to be observed that when air is admitted by a regular and free channel, comparatively little is strained in by the windows and other byways.

**Ventilation by Fans and Pumps.**—The fan-wheel has been for many years used in factories, to which it is particularly applicable, from the readiness with which it can be kept in motion by the engine. It is essentially the same as the barn-fanners; the air is drawn in at the centre of the wheel, and flies off at the circumference by centrifugal force. The fan is placed at the top of a flue, into which branches from all parts of the establishment proceed; and when it is set in motion, it draws off the air from every apartment communicating with it. Dr Arnott observed, that in the fan-wheel as well as in the air-pump or bellows invented by Dr Hales, a great deal of power was wasted by 'wire-drawing' the air—that is, making it squirt through small valves or other narrow openings. To obviate this, he invented a ventilating-pump, which supplied a hospital with fresh air, requiring no other motive-power

than the descent of the water used in the establishment from a high reservoir to the lower parts of the building. It is described in his work on *Warming and Ventilation*.

**Transference of heat from the used air to the fresh.**—This is the kind of economy which is put in practice in the Respirator (q. v.) and in the Caloric Engine (q. v.). Whatever difficulties—or impossibilities, as some maintain—there may be in the way of turning this transferred heat into a fresh source of power, nothing seems simpler, in theory at least, than to economise heat in this manner for the warming of dwellings and similar purposes. The idea originated with Dr Arnott, many years ago, who thus illus-

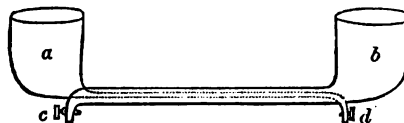

Fig. 7.

trates it in the case of water: Suppose *a* a vessel of boiling water, with a thin metallic tube issuing from the bottom, and having a stop-cock at *d*; and *b* a similar vessel of water at freezing, the tube of which is larger, and envelops the other. When both are flowing simultaneously, the hot water, if the tube is long enough, will have lost all its excess of heat before getting to *d*, while the counter-current will have gained all that the other lost. In an experiment with tubes six feet long, the boiling water from *a* issued from *d* at 34°, and the freezing water from *b* issued from *c* at 210°. It is clear that if *a* were a bath, the warm water in it, after being used, might in flowing out be made to heat the cold water from a reservoir, *b*, flowing into another bath below *c*. We are not aware that the principle has ever been acted upon; but the possible economy of heat is obvious, and it only requires mechanical ingenuity to realise it.

It will at once strike the reader how desirable it would be to do the same with the impure heated air which we are obliged to eject from our dwellings. Where the ventilation depends upon the draught of a common chimney, it would seem impossible to bring the entering air in contact with that which is escaping; but where the mechanical force of a pump or a fan is employed, nothing seems simpler than to make the two currents run counter to one another for a certain distance in close contact through a system of tubes. The smoke even, which, with the most economical arrangements, still issues from the flues at a temperature considerably above that of the building, might be drawn into the current along with the foul air of the apartments, and the whole reduced nearly to the temperature of the atmosphere before being allowed to escape. Of course, there must be loss in the transference; but a large percentage would be saved, and the consumption of fuel would be reduced by that amount. Were this 'double-current ventilation' applied to churches, ball-rooms, theatres, &c., where thousands of persons are assembled, Dr Arnott believed that 'no other heating apparatus would be required but the lungs of the company.'

Notwithstanding all the improvements recently effected, it is beyond doubt that this important branch of the art of living is still in a very rude and imperfect condition. A writer in the *Quarterly Review* for April 1866, in a very suggestive article on *Coal and Smoke*, points to the radical error of the existing system, when he remarks that 'in a

household fire heat is, as it were, manufactured on a very small scale; and experience has proved that the cost of production of an article has always been inversely proportionate to the scale of its manufacture.' He accordingly suggests that 'it seems practicable, in a great measure, to supersede domestic fires, and to lay on heat (heated air), or the means of generating heat (low-priced gaseous fuel), to our houses pretty much as we now lay on gas.' The abatement of the smoke-nuisance, and systematic and thorough ventilation, ought to be effected on a similar joint-plan, 'by connecting the chimneys of all the houses with underground culverts, provided at intervals with high shafts, in which, if necessary, the draught upwards might be increased by furnaces. We have long been familiar with extensive manufactories, covering large areas, in which are very numerous fires, all in communication with a single lofty chimney. With such an arrangement, no visible smoke should be produced, and with due attention, a smoky chimney should be impossible.' In the case of existing houses, the amount of reconstruction necessary might be a serious obstacle; but in building a new street, it might easily be made to empty its entire smoke through the medium of a single tall tower resembling those medieval campanili which are to be seen in Bologna and other Italian cities.' It is further proposed to make the ordinary sewers serve the purpose of culverts for the passage of the smoke to the common chimney. The sulphurous acid of the smoke would destroy the noxious qualities of the sewage gases, and improve the sewage for agricultural purposes; and instead of foul gases escaping through every opening or leak in the sewers, as at present, the powerful suction of the ventilating shafts would draw in fresh air, thus establishing a thorough system of atmospheric sewage. Another effect of the common chimney system would be to make the transference of heat, or double-current ventilation, spoken of above, easily practicable in domestic houses. The pipe through which the heated air and smoke were being drawn away might be made to give up its heat to the counter-current of fresh air which was being drawn in.

Even though such painstaking plans of economising heat might not pay at the present cost of fuel in this country, it is pleasing to think that there is such a resource in reserve. It is not with all countries as with us; and even our stores of coal are not inexhaustible. It is an unworthy, and, in the real sense of the word, an inhuman maxim, that bids us 'let posterity look to itself.' If the absorbing passion for present gain will not let us begin practising economy now, we may at least seek to devise and perfect plans to be in readiness when the necessity comes. It is not uncommon to hear the argument, that before the coals are done, something else will be discovered as a substitute. We are at a loss to imagine what the something is to be, unless it be the ingenuity to make the fuel that is now wasted in a year last a hundred; and this we believe to be quite possible.

**WARMINSTER**, a small ancient town of Wiltshire, on the west border of Salisbury Plain, and 19 miles north-west of Salisbury. The parish church dates from the reign of Henry III.; and the interesting edifices in the town and neighbourhood are numerous. An important corn-market is held every week. Pop. (1871) 5786.

**WARNING**, in Scotch Law, means a notice given to terminate the relation of master and servant, or landlord and tenant; corresponding in England to notice to leave and notice to quit respectively.

**WAR OFFICE**, the immediate office of the Secretary of State for War, and the centre on which pivots the entire administration of the army. It is divided by the 'War Office Act' of 1869 into three great departments—the Military, the Ordnance, and the Finance—under respectively the Officer Commanding in Chief, the Surveyor-general of the Ordnance, and the Financial Secretary. All are ultimately responsible to the Secretary of State for War, who has, for his immediate assistance, one parliamentary and one permanent Under-secretary of State.

**WAR-OFFICE REGULATIONS** consist of the royal warrants regulating the pay, retirement, and allowances of officers and men of the army, together with the instructions to paymasters and others considered necessary for the proper carrying out of the warrant.

**WARP**, in Weaving, signifies the yarn or thread which runs lengthwise in the cloth. See **WEAVING**.

**WARPING**, a mode of improving land, practised where rivers bring down large quantities of mud, or where mud is brought up from estuaries by the tides. It is practised in some of the valleys of the Alps; and the rich soil brought down from the mountains is thus arrested, and made to increase the fertility of fields. It is practised also in England, on the tidal waters of the Ouse, Trent, and other rivers falling into the Humber. There are not many places in Britain where the process of warping is capable of profitable application. The term warping belongs to the banks of the Humber. The name *warp* is there given to the large quantity of earthy particles held in suspension by the tidal waters. About a century ago, warping began to be practised, by means of small tunnels made through embankments, the water being allowed to remain, and deposit its sediment of earthy particles, before the sluices were opened for it to flow off. Warping has now long been carried on, upon a larger scale, with large canals, embankments, and flood-gates. Many acts of parliament have been obtained for large warping canals, to lead tide-water over great tracts of land. Land previously sterile and worthless has been covered with good soil, and has become very productive. The 'compartment' which is embanked around, in order to warping, is generally only fifty acres, or less; the farmer warping only one field in a season, because in the meantime it is unproductive. In some cases, however, 500 or 600 acres have been warped in one piece. In the rivers which flow into the Humber, the water coming down the river in floods is unsuitable for warping, and contains no such quantity of sediment as the tidal waters.

**WARRANTICE**, in the Law of Scotland, is the obligation to indemnify the grantee, or purchaser of land if, by defect of title, there should be an evictive or paramount claim established against the lands. Warrantice is personal or real; and personal warrantice is subdivided into general and special. Special warrantice is either (1) simple—i. e., that the grantor shall do nothing inconsistent with his grant; or (2) warrantice from fact and deed—i. e., that the grantor has not done, and will not do any contrary deed; or (3) absolute warrantice, or warrantice against all deadly—*contra omnes mortales*—i. e., that the grantor shall be liable for every defect in the right which he has granted. Real warrantice is where the grantor or vendor conveys another estate or lands, called warrantice lands, to be held by the grantee in security of the lands originally granted.

**WARRANT OF APPREHENSION** is an authority given by a justice of the peace to apprehend a person who is charged with a mis-

demeanour, felony, or treason. It is in the form of a command in her Majesty's name, issued by the justice to a constable, and to all other peace-officers of the county, reciting that an offence has been committed, and that oath has been made as to the offender, and commanding the constable to bring the offender before him (the justice), or some other of her Majesty's justices, to answer the said charge, and be dealt with according to law. The warrant must be signed and sealed by the justice. It may be issued and executed on a Sunday as well as any other day. In Scotland, the sheriff or justice of the peace who issues a warrant to arrest does not seal the document. In both countries, the warrant must name the individual arrested. In England, the party must either be taken or seized, or hands must be laid on him, accompanied with the words: 'I arrest you.' If the party arrested demand to see the warrant, the constable, if a known officer, is not in strictness bound to shew it to him; but if the officer is not a known officer, and not acting within his precinct, then he must shew the warrant. It is enough for the constable to say simply that he arrests in the Queen's name. If the party to be arrested be in a house, and the doors be fastened, the constable may, after first demanding admittance, and being refused, break open the doors. If, however, the house be a stranger's house, the constable who breaks open the door is not justified in doing so unless the accused be actually within. A general warrant, i. e., a warrant to apprehend all persons suspected, without naming or particularly describing any individual, is illegal and void for uncertainty, for mere vague suspicion is not enough to deprive any man of his liberty. A practice had obtained in the Secretary of State's office ever since the Restoration, grounded on some clauses in the acts for regulating the press, of issuing general warrants to take up (without naming any person in particular), the authors, printers, or publishers of such obscene or seditious libels as were particularly specified in the warrant. When these acts expired in 1694, the same practice was inadvertently continued in every reign, except the last four years of Queen Anne, till the question was raised and decided as to the validity of such warrants, and they were declared by the Court of Queen's Bench illegal. The House of Commons in 1766 also passed a resolution making the issuing of general warrants illegal.

**WARRANT OF ATTORNEY**, in English Law, is an authority given by a debtor to some attorney to enter up judgment against him in any action that may be brought to recover a particular debt. It is generally given by a debtor when he finds he has no defence, and wishes to gain time; and if he do not carry out his promise, the effect is that the attorney can immediately sign judgment, and issue execution against him, without the delay and expense of an ordinary action. But to prevent the malpractices of attorneys, and any imposition upon ignorant men, no such warrant is legal unless the debtor had his own attorney present, expressly named by him, and attending at his request, to inform him of the nature and effect of such warrant; and such attorney must subscribe his name as a witness. It is also provided that all warrants of attorney shall be void unless they are filed, within 21 days after execution, with the clerk of the judgments in the Queen's Bench.

**WARRANT-OFFICERS**, on Shipboard, are the highest grade to which seamen ordinarily attain. They are the gunner, boatwain, and carpenter. Their widows receive pensions.

**WARRANTY**, in English Law, is a promise or covenant to warrant or secure, against all men, a certain person the enjoying of the thing granted or

sold to him. As applied to ordinary sales of things personal, it is used to secure the truth of certain representations which the purchaser has no means, or has imperfect means, of ascertaining for himself, and yet the knowledge of which is material to the contract. The law does not imply on the part of the seller of an article in its natural state, who has no better means of information than the purchaser, and who does not affirm that the article is fit for any particular purpose, any warranty or undertaking beyond the ordinary promise that he makes no false representation calculated to deceive the purchaser, and practises no deceit or fraudulent concealment, and that he is not cognizant of any latent defect materially affecting the marketable value of the goods. In the ordinary sale of a horse, the seller only warrants it to be an animal of the description it appears to be, and nothing more; and if the purchaser makes no inquiries as to its soundness or qualities, and it turns out to be unsound and restive, or unfit for use, he cannot recover as against the seller, as it must be assumed that he purchased the animal at a cheaper rate. And on the sale or transfer of wares and merchandises, if nothing is said as to the character or quality of the thing sold, the buyer takes the risk of all latent defects unknown to the seller at the time of the execution of the contract of sale; all that the seller answers for being that the article is, as far as he knows, what it appears to be. Whenever a man sells goods as owner, he impliedly undertakes and promises that the goods are his own goods, and that he has a right to make the sale and transfer which he professes to make; and if he was not the owner, he is responsible in damages if the real owner claims them from the purchaser. If the purchaser does not himself inspect and select the subject-matter of sale, the seller impliedly warrants the article he sells to be the very article the purchaser has agreed to buy, and is responsible in damages if he furnishes a different article. If the vendor is told the article is wanted for a specific purpose, then he is taken to warrant impliedly that the article he furnishes is sufficient for that purpose. Every victualler or dealer in provisions impliedly warrants them to be wholesome and fit for food. But a private person who does not trade in provisions is not responsible for selling an unwholesome article of food without fraud and in ignorance that it is unfit to eat. Where buyer and seller have equal means of knowledge, then the vendor is not liable for any representation which he makes without fraud; but if, from the nature of the case, the vendor has the exclusive means of knowledge, then he impliedly warrants that what he says is true. Warranty is also to be distinguished from mere matter of opinion or belief. When a servant sells a horse, he has no right to give a warranty, unless his master expressly authorised him to do so. In the law of Scotland, the doctrine of Warranty of Goods does not substantially differ from the above.

**WARREN, HENRY.** See SUPP., Vol. X.

**WARREN** is a place kept for the purpose of breeding game or rabbits. In its strict legal sense, a right of free warren can only be derived by grant from the crown, and gives certain privileges to the warrener as to recovering game and destroying dogs which infest it (see Paterson's *Game Laws*, 20); but in the popular sense, a warren merely means a preserve for keeping game and also rabbits.

**WARRINGTON**, a parliamentary and municipal borough and manufacturing town of Lancashire, on the right bank of the Mersey, 16 miles east of Liverpool by railway. After the parish church, which is of Saxon origin, the chief buildings to be mentioned are the cotton and other factories and the

cloth-halls. In the older streets, ancient wooden houses are even yet to be seen. The manufactures of W. comprise cotton goods, as fustians, twills, corduroys; sailcloths and sacking; files, pins, wire and wire-woven work; glass; leather and soap; and a famous ale is brewed. Vessels of 100 tons can ascend the Mersey as far as the bridge of this town. Pop. of parliamentary borough, which returns one member to parliament, (1871) 33,053.

WARSAW, formerly the capital of Poland (q. v.), now capital of the Russian, or rather Russianised, government of W., stands on the left bank of the Vistula, about 300 miles east of Berlin by railway. Lat. of observatory, 52° 13' N., long. 21° 2' E. It stands partly on a plain, partly on rising ground sloping upwards from the left bank of the river, extends over a wide area, and consists of the city proper, and of a number of suburbs, several of which are beautifully built. A bridge of boats 1626 feet long connects W. with the suburb of Praga, on the right bank of the Vistula. The streets are mostly narrow, though in several instances they are broad and handsome. The Vistula at W. is broad, shallow, and ever-changing in its sandy course, and is navigable for large vessels only when, after thaw, rivers of melted snow pour down into it from the Carpathians, or when it is swelled by the autumn rains. But the only craft seen here on the Vistula are rude rafts, usually laden with wheat, which they convey to Danzig by river, and (within the last few years) steamers at intervals. Seen from Praga, on the right bank, the Castle, standing on a steep ascent, has a most imposing effect. Attached to the Saxon Palace are a spacious court and gardens, which are considered the finest promenade in the city. Among the other buildings there are nearly 30 palaces; the cathedral of St John (dating from 1250), a Gothic building of great beauty, containing statuettes and many interesting monuments, among which is one by Thorwaldsen; the Lutheran church, the loftiest building in W., and numerous other places of worship, including synagogues. There are several large and memorable squares, as the Sigismund Square, containing the monument, erected by Ladislas IV., in honour of his father, Sigismund III. In this square, in April 8, 1861, 40 unarmed and unresisting Poles were massacred. The citadel, erected by the Emperor Nicholas, for the express purpose of intimidating, and, if necessary, destroying the city, commands, from its situation, every part of Warsaw. The university, broken up by the Emperor Nicholas after the insurrection of 1830, was re-established by decree, 1864, through the influence of the Grand Duke Constantine; and besides this institution, there are several minor colleges, gymnasiums, &c. Woollen and linen fabrics are manufactured. Pop. (1873) 79,502. The value of exports and imports by the Vistula in 1873 was £1,597,467. For the history of W., see POLAND, JOHN III. (SOBIESKI), PONIA-TOWSKI, &c.

WARTBURG, WAR OF THE, the name given both to a grave poetic contest, which is represented to have taken place on the Wartburg, and also to a poem in the Middle High-German dialect, which commemorates the event. At the time when the aforesaid dialect had attained its highest literary development, and its poets enjoyed a brilliant reputation, Hermann, the munificent Landgraf of Thuringia, had made his court a sort of refuge or home for the irritable race, as well as for many other people. It could hardly fail, under the circumstances, that quarrels and jealousies should abound; and, in fact, allusions to these are sufficiently distinct in several of the most distinguished writers who lived

at the Thuringian court—e.g., in Wolfram von Eschenbach and Walther von der Vogelweide. But soon after, the conception of these things underwent a sort of mythical transformation, and the occasional temporary and natural rivalries of the poets were changed into a particular and premeditated contest for superiority in poetic skill; and to the list of those poets who actually had intercourse with each other at Eisenach were now added others partly historical, and in part purely fictitious characters—e.g., the virtuous Schreiber, Bitterolf, Reinmar (subsequently confounded with Reinmar von Zweter), the almost mythical Heinrich von Ofterdingen, and the wholly mythical Master Klingsor, the Transylvanian magician and astrologer. On the basis of this historico-mythical tradition, and under the formal influences of the then much admired songs of emulation, riddle-contests, and ecclesiastical plays, there was composed, about the year 1300, a strange, obscure, unharmonious poem in two parts, called *Kriec von Wartburg*. In the first of these, executed in a long and artistically managed measure, and entitled *Tone des Fürsten von Thuringia*, Heinrich von Ofterdingen challenges the other poets to a contest in verse—the fate of the vanquished to be death—and asserts the excellence of Leopold, Duke of Austria, over all the other princes. Victory, however, inclining to the Eisenachers, Heinrich calls in Klingsor to his aid, who, on his part, fights his verse-battle against Wolfram by the assistance of evil spirits, with riddles and dark science. With distinct reference to Klingsor's 'black art,' the simpler and shorter measure of this second part is called *Schwarze Ton*. Throughout the whole poem, which may be regarded as the first attempt at a secular drama, but which is rather an intermediate link between the Lyric contest and the Drama, one may trace an unmistakable imitation of Wolfram's style of poetry. The author is unknown. From the inequality of the style, one is disposed to conclude that several hands were employed in its composition. The poem, which has been much overrated in modern times, does not seem to have exercised any particular influence on literature. In a prose form, the story of the Wartburg Contest first appears—in the Thuringian Chronicles—after the beginning of the 14th c., and probably owes its origin to the poem. The poem was printed in a separate edition by Ebtmüller (Ilmenau, 1830), and is also to be found in Bodmer's and Von der Hagen's collection of the *Münnesinger*.—See Von Plotz, *Über den Sängerkrieg auf Wartburg* (Weimar, 1851).

WARTHÉ, the longest and most extensively navigable affluent of the Oder, rises on the south-west frontier of Poland, 35 miles north-west of Cracow. In Poland, it flows north and west, and the length of its course in this country is 300 miles. It then flows west-north-west through Prussia for 180 miles, passes Posen, and joins the Oder at Knustrin, where it is 620 feet broad. Total length, 483 miles, for 220 miles of which it is navigable.

WART-HOG (*Phacochoerus*), a genus of *Suidæ*, closely resembling the true hogs in most of their characters, and particularly in their feet, but remarkably differing from them in their dentition; the molar teeth being much like those of the elephant, and replacing one another in the same manner. There are two triangular incisors in the upper jaw, and six small ones in the under; the tusks are lateral, very large, project far from the mouth, and are bent upwards; there are six or eight molars in each jaw. The head is very large, and the muzzle very broad; the cheeks furnished with large wart-like excrescences, so that the appearance is altogether very remarkable and uncouth. The species are all

natives of Africa. They feed very much on the roots of plants, which they dig up by means of their enormous tusks. The AFRICAN W., or HARUJA (*P. Eliani*), a native of Abyssinia and of the central regions of Africa, from the coast of Guinea to that of Mozambique, is nearly four feet long, with a naked slender tail of one foot, is scantily covered with long bristles of a light brown colour, and has a mane sometimes ten inches long, extending from between the ears along the neck and back. Another species is found in the south of Africa (*P. Æthiopicus* or *Pallasii*), the *Valke Vark* of the Dutch colonists



Wart-hog (*Phacochoerus Æthiopicus*).

at the Cape of Good Hope. The incisors of the latter fall out at an early age, those of the former are persistent.—A closely allied genus is *Potamochoerus*, of which there are several species, as the *Bosch Vark* of Cape Colony (*P. Africanus*), which is nearly black, with whitish cheeks having a central black spot; and the PAINTED FIG of West Africa (*P. penicillatus*), which is reddish, with black face, forehead, and ears. The species of *Potamochoerus* frequent swampy grounds, and sometimes receive the name of WATER-HOG. They have longer ears than the true wart-hogs, tapering and ending in a pencil of hairs; the face is elongated, and has a huge protuberance on each side. The flesh of all the wart-hogs and water-hogs is in high esteem. They are hunted by dogs, which are often killed in the encounter with them. They are much addicted to fighting among themselves.

WARTON, JOSEPH, D.D., was born at Dunsfold, Surrey, in 1722. His earlier education he received from his father, the Rev. Thomas Warton, sometime Professor of Poetry at Oxford. At the age of 14, he was sent to the great school at Winchester, whence, in 1740, he was transferred to Oriel College, Oxford, where, four years afterwards, he took his degree of B.A. After passing the intermediate years as a curate at Chelsea and elsewhere, in 1748 he was presented by the Duke of Bolton to the rectory of Winsdale, near Basingstoke, a living of no great value, yet sufficient to determine his marriage with a Miss Damon, to whom he had been engaged. Previous to this, he had become known as a writer of verse in the *Gentleman's Magazine*, *Doddsley's Museum*, &c., and as the author of a volume of *Odes and other Poems*. In 1751, he went abroad with the Duke of Bolton; and after his return, he issued, in 1753, an edition of Virgil, with a translation of the *Eclogues and Georgics*. This, with the critical notes and dissertations appended to the work, met with great approval, and subsequently procured him from the university of Oxford the degree of M.A. In 1756, appeared the first volume of his chief literary performance, the *Essay on the Writings and Genius of Pope*, the second and concluding volume of which was not given to the world till 1782. Venturing, as

he did, to question the positive supremacy which it was then fashionable to attribute to Pope, W. did not by this work attain any very instant increase of popularity; but the value in relation to the literature of the time, of the critical principles announced in it, as also in his other more casual Essays, has since been sufficiently recognised. In 1755, W. was appointed second Master of Winchester School, of which he became head in 1766. Soon after, he revisited Oxford, and had conferred on him the degrees of Bachelor and Doctor of Divinity. Of preferment in the church, he had subsequently his full share. By the good offices of Dr Lowth, Bishop of London, he was made, in 1782, a Prebendary of St Paul's; and the living of Thorley, in Hertfordshire, was conferred on him. He obtained besides, in 1788, a prebend in Winchester Cathedral, and the rectory of Easton, which he soon after exchanged for that of Upham. The Mastership of Winchester he resigned in 1793, and devoted himself to the preparation of an annotated edition of Pope, which was completed in 9 vols. 8vo in 1797. At his death, 23d February 1800, he was engaged on a similar edition of Dryden, of which he had published two volumes. Though W.'s reputation has not survived as a poet, yet it certainly has as a critic, along with that of his more distinguished brother.—See *Biographical Memoirs of Rev. Joseph Warton, D.D.*, by Rev. John Wooll, A.M. (1806).

WARTON, THOMAS, the younger brother of the preceding, was born in 1728, at Basingstoke, in Hampshire, of which place his father had then become vicar. His earlier education he received chiefly at home from his father; and in 1743, he was entered at Trinity College, Oxford, where, in 1750, he took his degree of M.A. The year after, he obtained a fellowship. He remained at the university, employed as a tutor; and in 1757, he was made Professor of Poetry, in which capacity he was much esteemed as a lecturer. In 1767, he took his degree as Bachelor of Divinity, and was soon after presented to the living of Kiddington by the Earl of Lichfield. In 1782, that of Hill Farrance, in Somersetshire, fell to him by favour of his college; and these two unimportant pieces of ecclesiastical preferment were the only ones he ever enjoyed. Very early, he became known as a poet, and in 1754, he published a volume entitled, *Observations on the Fairie Queene of Spenser*, which established his reputation as one of the first critics of the day. In a second edition of the work, issued in 1762, it was expanded into two volumes. Of W.'s miscellaneous literary activity, no account need be given in detail. The work by which he is now chiefly remembered is his *History of English Poetry*, the first volume of which was published in 1774. Two other volumes followed in 1778 and 1781, but at his death the work remained unfinished. In its wealth of information regarding the earlier portion of our literature, the book remains to this day unrivalled. As a poet, also, W. takes distinct, if not very high rank. In 1777, he published a collection of such of his scattered pieces as he deemed most worthy of being reprinted, and the acceptance it met with is shewn in the successive editions of 1778, 1779, and 1789, as also in the fact, that on the death of Whitehead, the poet-laureate, W. had the honour, such as it might be, of being selected to succeed him in the office. The last work on which he was engaged was an elaborately annotated edition of the *Minor Poems of Milton*. Of this, published in 1785, a carefully prepared re-impression was issued the year after his death, which took place suddenly on the 21st May 1790. In 1802, a new edition of his poems was published, with a Life of the author by Mr Mant.

WARTS (sometimes known in Surgery by their Latin name *Verruca*) are collections of lengthened Papillæ of the Skin (q. v.), closely adherent and ensheathed by a thick covering of hard dry cuticle. From friction and exposure to the air, their surface presents a horny texture, and is rounded off into a small button-like shape. Such is the description of the simple wart, which is so commonly seen on the hands and fingers (and rarely on the face or elsewhere) of persons of all ages, but especially of children. Amongst other varieties of warts are: (1) One to which the term *Verruca digitata* has been applied. It is more elongated in shape, and less protected by cuticle than the preceding. It is said to occur nowhere but on the scalp of women of adult age, and sometimes to occasion great annoyance in brushing and combing the hair. (2) *Subungual warts*, growing, as their specific name implies, beneath or at the side of the finger or toe nails. They originate beneath the nail, and as they increase, they crop out either at the free extremity or the side of the nail, and are usually troublesome, and often very painful. They are generally of syphilitic origin. (3) *Veneral warts*, caused by the direct irritation of the discharges of gonorrhœa or syphilis, and occurring about the parts which are liable to be polluted with such discharges. They attain a larger size, and are more fleshy and vascular than other warts.

Nothing is known of the causes of warts further than the third variety is induced by an irritating discharge, that the malignant form of wart which is the beginning of chimney-sweepers' cancer is caused by the irritation of soot, and that persons engaged in dissection and *post-mortem* researches are especially liable to them; hence we may infer they are always due to some local irritation. Venereal warts are certainly contagious; with regard to others, we cannot speak positively. In some cases, but not invariably, blood from a wart is capable of producing similar warts when applied to the skin. In consequence of the capricious way in which warts often spontaneously disappear, there are numerous popular charms for their removal, several of which may be found recorded in the pages of *Notes and Queries*. Common warts are so apt to disappear, that they may be often left to themselves. If it is desired to remove them, glacial acetic acid is perhaps the best remedy: it must be applied with a camel-hair pencil till the wart is pretty well swollen, care being taken not to blister the neighbouring skin. One or at most two applications are usually sufficient. Nitrate of silver and tincture of iron are popular and general applications. Small warts hanging by a neck, may often be very simply removed by the moderately tight application of an elastic ligament (for example, a small broken elastic ring) to the base. The wart usually shrivels up, and falls off within a week. The other varieties of warts must be left to the surgeon.

WARWICKSHIRE, one of the midland counties of England, bounded on the W. by Worcestershire, on the N. by Stafford and Leicester shires, and on the S. mainly by that of Oxford. Area, 610,587 acres; pop. (1871) 630,472. The surface, though presenting no lofty hills, is marked by gentle eminences and vales. The north districts of the county were formerly occupied by the forest of Arden, of which there are still remains; and the scenery, in general remarkably rich and charming, is varied by moor and heath. The principal rivers are the Avon, flowing from north-east to south-west; and the Tame in the north. The soil varies much in quality, being cold and heavy on the higher and more exposed positions; while in more favourable districts, it is as a rule good. Of the whole area, 485,346

acres were (1875) under all kinds of crops, bare fallow, and grass; under corn crops, 151,365; under green crops, 34,284; clover, sanfoin, and grasses under rotation, 40,479; and 244,392 were under permanent pasture. Of minerals, coal, stone, lime, and marl are found. The county returns four members to the House of Commons.

WARWICK, a municipal and parliamentary borough, chief town of the county of the same name, stands in the middle of the county, on the Avon, 20 miles south-east of Birmingham. It is a very ancient town, and contains many ancient and interesting buildings and institutions. Of these the most notable is Warwick Castle, the principal residence of the Earls of Warwick, beautifully situated on a rocky elevation, 40 feet high, on the banks of the Avon. Of this edifice, Guy's Tower, 128 feet high, was built in 1394; and Caesar's Tower, still more ancient, is 147 feet high. The interior, before the castle was partly burned, Dec. 3, 1871, was remarkable for its splendour and elegance, and is being restored in similar style. The Earl of Leicester's Hospital for aged brethren has an annual income of £2016. There are numerous other charities, with schools, libraries, &c. Agriculture and general trade afford employment to a large number of the inhabitants. W. returns two members to the House of Commons. Pop. (1871) 10,986.

WARWICK, a township of Rhode Island, U. S. America, 10 miles south-west of Providence, on Narragansett Bay, and the Stonington and Providence Railway, containing the villages of Natick, Phoenix, Centreville, Arctic, Crampton, and Apponaug. It has 22 cotton mills with 160,000 spindles and 4000 looms, 2 woollen mills, 2 bleacheries, 2 print-works, 15 churches. Drum Rock, a balanced rock of great size, can be moved by a child, and makes a sound which can be heard for miles. Pop. (1870) 10,453; (1875) 11,614.

WARWICK, RICHARD NEVILLE, EARL OF, K.G., popularly named the King-maker, was eldest son of Richard, Earl of Salisbury, and Alice, daughter and heiress of Thomas Montacute. He was born about 1420, shortly before the accession of Henry VI. Lord R. Neville, as he was then styled, early manifested his distinguished bravery and brilliant personal qualities in a hostile incursion across the Scottish marches, in which he accompanied his father, the Earl of Salisbury. He became the most powerful nobleman in the kingdom, by his marriage with Anne, daughter and heiress of Richard de Beauchamp, Earl of Warwick. He not only acquired by this alliance the broad lands of the Warwick family, but was created Earl of Warwick, with succession to the heirs of his wife. He is the most prominent figure in the civil War of the Roses, one of the darkest periods of our history. The Duke of York gained his support by his marriage with Lady Cecille Neville; and when the barons declared the incapacity of Henry VI., and chose the duke to be protector of the kingdom, W. led into the field his well-tried borderers of Wales. The Yorkists and the Lancastrians first met at St Albans in 1455, when W., rushing suddenly into the town at the head of his men, mainly won the battle by his impetuous onset. He was rewarded with the government of Calais—'then,' says Comines, 'considered as the most advantageous appointment at the disposal of any Christian prince, and that which placed the most considerable force at the disposal of the governor.' He also obtained command of the fleet for five years. In 1458, he sailed from Calais with five large and seven small vessels, and attacked a fleet of 28 ships, belonging to the free town of Lübeck. After a battle of six hours, he took six of

the enemy's vessels. In 1460, he landed in Kent at the head of his troops, and entered London amidst the acclamations of the people. He defeated the queen's army, near Northampton, with great slaughter, and obtained possession of the person of the king. Richard, Duke of York, now advanced his claim to the throne. Queen Margaret raised an army to rescue the king; and the duke committed the idiotic monarch to the custody of the Duke of Norfolk and W., while he advanced to Wakefield to attack the Lancastrians. The duke was taken, and put to death; and W.'s father, the Earl of Salisbury, with twelve other Yorkist chiefs, was beheaded at Pontefract. Another battle at St Albans was won by the Lancastrians; but Edward, Earl of March, now Duke of York, accompanied by W., marched boldly upon London, which was throughout Yorkist, and Edward was proclaimed king by the style of Edward IV. The next battle was that of Towton, near York. The Lancastrians had retaken the pass of Ferrybridge, on the river Aire, and W. in despair at the loss of so good a position, rode up to Edward, and dismounting, shot his own horse through the head, as a signal for an attack from which there could be no retreat, exclaiming: 'Sir! let him flee who will flee; but by this cross' (kissing the hilt of his sword) 'I will stand by him who will stand by me!' The Lancastrians were defeated with immense loss; and Edward, returning to London in triumph, was crowned June 22, 1461. The battle of Hexham was followed by the capture of Henry; and W., who had been left in command in London, placed the deposed king on a horse, under whose belly his feet were fastened, and thus led him through Cheapside to the Tower. W. having been authorised to negotiate with Louis XI. of France for the marriage of his sister-in-law, the Princess Bonne of Savoy, to King Edward, could not brook the king's sudden marriage with Elizabeth Woodville, and seemed inclined to shew that he could pull down as well as set up kings. He was now at the height of his power. To the earldoms of Warwick and Salisbury, with the estates of the Spencers, he added the offices of High-admiral and Great-chamberlain, together with the lord-licutenancy of Ireland and the government of Calais. Comines states the income of his offices at 80,000 crowns a year, besides the immense revenues accruing from his patrimony; yet he had the meanness to accept a secret pension and gratuities from Louis XI. After being sent into honourable banishment by means of embassies to France, Burgundy, and Brittany, he gave his daughter in marriage to George, Duke of Clarence, without asking Edward's permission. He soon afterwards broke out into revolt against Edward, and concluded a treaty with Queen Margaret, by which it was agreed that her son, Prince Edward, should espouse Anne Neville, W.'s daughter, and that in failure of issue, the crown should devolve on Clarence. King Edward escaped to Holland; and Henry VI. resumed the sovereignty. Edward, however, raised a body of Flemings and Dutchmen, and, landing near Hull, advanced towards London. He gave battle to King Henry's army, commanded by W., at Barnet, April 14, 1471. The battle was memorable and important. W. and his brother, Montague, were left dead on the field, and with them fell the greatness of the House of Neville. This fatal battle, followed by the decisive engagement of Tewkesbury, completed the defeat of the Lancastrians, and concluded the sanguinary War of the Roses. It appears (Fenn's Letters) that every individual of two generations of the great families of Warwick and Somerset fell on the field or on the scaffold, a victim of these sanguinary contests. W. is the most conspicuous personage of these disturbed times. He kept

open house wherever he resided, and daily fed at his various mansions 30,000. He loved turbulence for its own sake, and was ready to make or unmake any king, according to the caprice of the moment, and in order to shew his power.

WASH, a wide estuary on the east coast of England, between the counties of Lincoln on the north-west and Norfolk on the south-east, is about 22 miles in length, and 15 miles in average breadth. It is surrounded by low and marshy shores, and receives the rivers Witham, Welland, Ouse, Nen, and Nar. The estuary for the most part is occupied by sandbanks, dry at low water, and between these sandbanks are the channels through which the rivers mentioned flow into the North Sea. On both sides of the channel by which the Ouse falls into the sea, considerable tracts of land have been reclaimed. Anchorage is afforded to vessels by two wide spaces or pools of water, called respectively Lynn Deep, opposite the coast of Norfolk, and Boston Deep, opposite the Lincolnshire coast.

WASHING AND WASHING-MACHINES. Although domestic washing is a simple enough process, yet it may be useful to give a brief description of the most efficient way of conducting it, in so far as experience and correct principles can guide such an operation. The first essential is suitable water, in other words, soft water. See WATER-SUPPLY. Yellow Soap (q. v.) being the kind chiefly used in washing linen, it is well to bear in mind that it is not desirable to purchase it very pale in colour, or very low in price. In order to gratify the desire for a light colour, soap-makers are obliged to reduce the strength of good dark soaps with adulterants; and it will give some idea of how easily the demand for cheapness may be met, to state, that hard soap, which should not contain so much as 25 per cent. of water, can be made with as much as 75 per cent. Soap, as is well known, improves by keeping. Soft or potash soap is sometimes used to wash coarse things, on account of its being stronger than hard soap, but its smell is objectionable. Soda is easily procured good; and with respect to washing-powders, as their merit depends on the amount of alkali which they contain, suffice it to say that to buy them is only a dear way of buying soda.

In arranging clothes for washing, it is desirable to sort them into kinds most suitable for washing together; such as lace, nets, and fine muslin into one heap; white body-linen into another; coloured things of the nature of prints and gingham into another; and so on. It is also desirable to wash clothes as soon as possible after they are soiled. Previous to washing, all white articles should be soaked for a night in cold water, in which a little soda has been dissolved, as the steeping in alkaline water greatly aids in removing all dirt of a greasy nature. The clothes should then be washed twice in clean tepid water with a sufficient supply of soap. If the water is quite cold, the dirt is taken off with difficulty; and if too hot, it is apt to fix it into the fibre of the cloth. The clothes should next be examined for spots or stains, so as to remove them, if possible, by an additional rubbing; after which they are boiled for at least 15 minutes in soap and water. Ink-stains or iron-moulds require to be taken out with oxalic acid, or the essential salts of lemon (oxalate of potash); and fruit-stains by boiling the stained parts with pearl-ash. After being boiled, the clothes are rinsed twice in cold water; and in the second rinsing, a little stone blue is added, to neutralise any yellowness occasioned by the washing. When this is done, they are wrung, and hung out to dry.



## WASHING AND WASHING-MACHINES.

For the washing of flannels, it is even more desirable that the water should be soft than for linen or cotton; and it should contain no soda or potash in any form, as although a little alkali would more effectually remove dirt, yet it always turns woollens yellow, and at the same time thickens them. It is well to remember also that all rubbing, wringing, or squeezing tends to make woollen goods shrink, by facilitating their tendency to felt or mat into a thicker fabric. With respect to ladies' coloured dresses made of fine wool, such as merino, it is considered best to wash them in warm soft water with ox-gall, say a pint in a tubful of water. Ox-gall is a soap in its chemical nature, and it clears and brightens the colours.

The washing of printed cotton fabrics, especially muslins, has of late years become a difficult operation, on account of the fugitive nature of some of the dye-stuffs employed. The beautiful hues produced by the aniline or coal-tar colours, and by the archil lakes in imitation of them, have led to their being extensively used in calico-printing, as well as in the dyeing of silk and wool. These dyes can scarcely be said to be permanent on any fabric; but on cotton they require to be fixed by mordants, such as albumen (white of egg), which will scarcely stand washing at all, and to which hot water is utter destruction. The same thing is true of some other dyes, such as the light blue produced by artificial ultramarine. If economy is to be studied, it is far better to have printed dresses done in fast colours—the reds and purples, from madder, for example—as they, although less attractive at first, can be washed without injuring their appearance. All such articles should be washed in soft warm water; that which has been used for flannels, if not too dirty, will do. When thoroughly cleaned, rinse them well in clean cold water, and do not allow them to remain long in contact before they are hung up to dry.

White silk articles, as stockings and gloves, should be washed with soap, first in milk-warm, and afterwards in nearly boiling water. They will be improved if hung up for a short time in the fumes of burning sulphur (sulphurous acid) while still damp.

We have now to notice the domestic washing-machines which have, of late years, come into rather extensive use. A machine of this kind, when in motion, ought to produce at least as much agitation as will keep up a constant change in the deterging solution in contact with the linen, and at the same time cause the clothes to slide over each other in a somewhat analogous manner to hand-washing. There is an old form of washing-machine called the *dolly-tub*, which has been in use in Yorkshire for upwards of eighty years. It consists essentially of a presser or dolly, which is simply a round piece of wood, say ten inches in diameter, with from three to five legs rounded at the ends; the whole exactly resembling a footstool, but with the addition of an upright rod or spindle from its centre, with a cross piece at the top for working it. Any vessel, such as a tub, barrel, or box, may be used to hold the clothes, which are washed by moving the dolly first one way and then the other, at the same time a certain pressure being exerted on them against the sides and bottom of the vessel.

Of recent washing-machines, a certain class of them are modifications of the dolly-machine, with spring-ribbed boards, on which the linen is rubbed by a swinging motion. Another class consist of boxes which also oscillate upon an axis, but operate by jerking the clothes and water from side to side. A third, and perhaps the most efficient class are made upon the principle of the dash-wheel, so much

used in large bleach-works. In this machine, the materials to be washed are lifted by internal ribs on the rim of a large wheel, and allowed to fall with some force from fully half its height into the cleansing liquid—this being of course repeated as the wheel rotates.

The annexed figure shews a dash-wheel washing-machine for domestic purposes, by Messrs Summer-sales & Sons, Keighley, Yorkshire. The names of its separate parts are given in the references to the

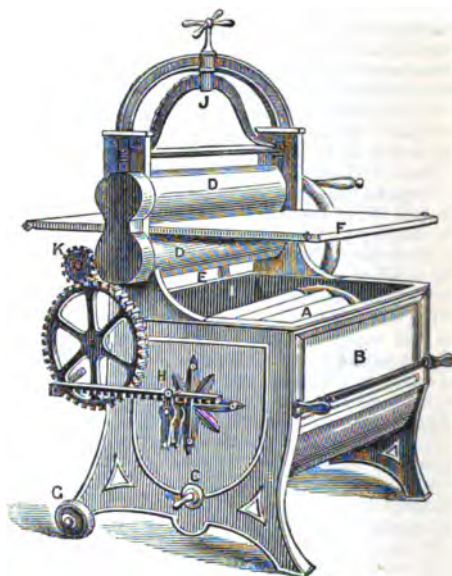

Dash-wheel Washing-machine :

A, Drum inside of tub; B, Tub with cover removed; C, Tap to draw off water; D, Wooden rollers; E, Drip-board; F, Mangling-boards; G, Wheels to remove the machine; H, Oscillating motion for dash-wheel; I, Brushes for dry clothes; K, Wheel thrown out of gear when mangling, in gear when washing.

letters, but we may explain that the linen is put inside the drum or dash-wheel, A (a spoked cylinder), which has a reciprocating action, so that, after making a complete revolution, it is reversed. The clothes are thus driven both ways through the water, and the quick reversing action of the machine gives them a jerk or dash at each change of motion—the equivalent of the fall from a large dash-wheel. There are brushes on the inside of the drum, which are brought into play if the clothes are coarse and dirty, but are turned out of action if they are of a fine description. A machine of this kind, 26 inches wide, will take in two pair of sheets or a dozen of shirts at a time, and by turning the handle with a brisk motion, they will be washed in eight or ten minutes. The lather for linen is made up with one pound of soap, half a pound of soda, and three quarts of water—the last being poured in boiling. Only about half as much soap is required as for washing by hand.

The wringing is performed by passing the wet clothes through the wooden rollers D, D, the upper one being temporarily covered with flannel to protect buttons, hooks and eyes, &c. from damage. The necessary pressure is obtained by means of the spring at J, and before turning the rollers, the washing-cylinder is thrown out of gear. With the aid of the mangling-boards, F, the clothes are mangled by these same rollers.

*Washing by Steam*, though little known in England, is practised to a considerable extent in France. The French chemist, Chaptal, first brought the process to perfection. Besides a saving of fuel, soap, and manual labour to the extent of at least one half, the wear and tear of the linen attending rubbing and beating is avoided. The efficacy of steam in washing depends upon its penetrating and dissolving property. The clothes are first steeped in a ley of soda or potash, or in a mixture of alkali and soap, and then hung in a wooden vessel kept full of steam by a pipe communicating with a boiler. On a small scale, a large cask, made air-tight, will answer, and a common tea-kettle will produce steam enough. There must be an aperture to allow the air to escape when the steam first enters; the air being expelled, the aperture is shut. In half an hour, the dirt is sufficiently loosened to wash out with ease, and the linen is found to be extremely white.

**WASHING OF FEET** (called in Latin *Pedilavium*, and sometimes *Mandatum*, from the first word of the 'little chapter' in the service), one of the ceremonial observances of the Holy Week (q. v.) in the Roman Catholic Church. It forms part of the service of Holy Thursday, which day, from the word *mandatum*, is also called Maundy Thursday. The origin of this observance is extremely ancient. It is founded on the example and exhortation or precept of our Lord in John xiii. 5—14; and is traceable in the writings of Justin, Tertullian, Ambrose, and Augustine, as well as in many of the early councils. In some churches, however, or at least at some particular periods, the day fixed for the ceremonial was Good Friday, although for many centuries it has uniformly been assigned to Holy Thursday. It is necessary, however, to distinguish from the ceremonial of the Holy Week, another washing of the feet (also called *pedilavium*), which, in the case of catechumens, preceded baptism, and which, in many churches, was accompanied by a washing of the head, *captilavium*, and took place on Palm Sunday (q. v.), thence called 'Dominica Captilavii.' To this usage Sts Ambrose and Augustine distinctly refer. In the medieval and modern church, the washing of feet has generally followed the solemn mass of the day. In those churches where the ceremony is still retained, the officiating bishop or priest, wearing a cope, and girt with a towel, and attended by a deacon and subdeacon, washes, dries, and kisses the right foot of a certain number of pilgrims, generally twelve, in memory of the twelve apostles; after which all the pilgrims are hospitably entertained, and served in person by the bishop, who distributes to each a dole in money or provisions. An appropriate service, consisting of a gospel (John xiii. 1—14) sung by the deacon, a chapter ('Mandatum novum') chanted by the choir, and a prayer by the bishop, accompanies the ceremonial. The washing of the pilgrims' feet on Holy Thursday forms a very striking part in the Holy Week ceremonial as carried out not only by the pope, but also by the bishops in most of the great cathedrals abroad. It was also practised by kings and other royal and noble personages, even down to a very recent date.

**WASHINGTON, GEORGE**, Commander-in-chief of the Continental forces in the war of the American revolution, and first President of the United States, was born in Westmoreland county, Virginia, February 22, 1732; son of Augustine Washington and his second wife, Mary Ball; a descendant of John Washington, who emigrated to Virginia from England about 1657, who was a grandson of John Washington, mayor of Northampton, and first

lay-proprietor of the Manor of Sulgrave, in Northamptonshire, who married a daughter of Shirly, Earl Ferrers. Lawrence, an elder brother of John, studied at Oxford; John resided at one time at South Cave, Yorkshire. Being royalists in the time of Cromwell, both emigrated, and became landed proprietors and planters in Virginia, in the district between the Potomac and Rappahannock rivers. Augustine Washington died when his second son George was 12 years old, leaving a large property to his widow and five children. His education in the indifferent local schools extended only to reading, writing, arithmetic, book-keeping, and land-surveying, then an important acquisition. He grew tall, had great physical strength, and was fond of military and athletic exercises. At the age of 13, he wrote out, for his own use, 110 maxims of civility and good behaviour. In 1740, his elder brother, Captain Lawrence Washington, served under Admiral Vernon in the expedition against Carthage, and named his residence on the Potomac Mount Vernon, in honour of his commander, who offered George a commission as midshipman on his ship, which, but for the opposition of his mother, he would have gladly accepted. He then spent his time chiefly with his brother at Mount Vernon, and with Lord Fairfax, who owned great estates in the Virginia valley; and in 1748, he engaged to survey these wild territories for a double moon a day, camping out for months in the forest, in peril from Indians and squatters. At the age of 19, at the beginning of the Seven Years' War, he was appointed adjutant of the provincial troops, with the rank of major; in 1751, he made his only sea voyage—a trip to Barbadoes—with his brother Lawrence, who died soon after, and left George heir to his estates at Mount Vernon. At 22 (1754), he commanded a regiment against the French, who had established themselves at Fort Duquesne (now Pittsburg), and held Fort Necessity against superior numbers, until compelled to capitulate. The year following, when two regiments of regulars were led against Fort Duquesne by General Braddock, W. volunteered; and at the disastrous ambush of July 9, 1755, he was the only aide not killed or wounded. He had four bullets through his coat, and two horses were shot under him. The Indians believed that he bore a charmed life, and his countrymen were proud of his courage and conduct. Two thousand men were raised, and he was selected to command them. In 1759, he married Mrs Martha Custis, a wealthy widow, resigned his military appointments, and engaged in the improvement of his estates, raising wheat and tobacco, and carrying on brick-yards and fisheries. He was, like nearly all Americans of property at that period, a slaveholder, and possessed at his death 124 slaves, whom he directed, in his will, to be emancipated at the death of his wife (who survived him but three years), so that the negroes of the two estates, who had intermarried, might not be separated. He was for some years a member of the Virginia Assembly; and in 1774, though opposed to the idea of independence, and in favour of the union with Great Britain so ardently desired by all British Americans, he was ready to fight, if necessary, for the constitutional rights of the colonists. He spoke seldom and briefly; but Patrick Henry declared him to be, 'for solid information and sound judgment, unquestionably the greatest man in the assembly.' The news of the battle of Lexington (April 19, 1775) called the country to arms; and W., then a member of the Continental Congress, was elected Commander-in-chief by that body. He hastened to the camp at Cambridge; compelled the evacuation of Boston;

## WASHINGTON.

was driven from New York; compelled to retreat across New Jersey; often defeated, and reduced to the most desperate straits, by disaffection, lack of men and supplies, and even cabals against his authority; but by his calm courage, prudence, firmness, and perseverance, he brought the war, with the aid of powerful allies, to a successful termination; and (Dec. 23, 1783), the independence of the thirteen colonies achieved, he retired from the army to Mount Vernon, which he had, during the eight years of the war, but once visited. He refused pay, but kept a minute account of his personal expenses, which were reimbursed by Congress. In 1784, he crossed the Alleghenies to see his lands in Western Virginia, and planned the James River and Potomac Canals. The shares voted him by the state he gave to endow Washington College, at Lexington, Va., and for a university. The Federation of States having failed to give an efficient government, W. proposed conventions for commercial purposes, which led to the Convention of 1787, of which he was a member, which formed the present federal constitution, considered by him as the only alternative to anarchy and civil war. Under this constitution he was chosen president, and inaugurated at New York, April 30, 1789. With 'Lady Washington,' so termed by the courtesy of the period, he presided over a federal court, far more formal and elegant than exists at this day, and made triumphal progresses in the north and south. During his second term of office, he was disgusted by the opposition of the Republican party, under the leadership of Jefferson and Randolph, and refusing a third election, he issued, in 1796, his farewell address, and retired to Mount Vernon. In 1797, when there arose a difficulty with France, threatening hostilities, he was appointed lieutenant-general and commander-in-chief. On the 12th of December 1799, he was exposed in the saddle, for several hours, to cold and snow, and attacked with acute laryngitis, for which he was repeatedly and largely bled, but sunk rapidly, and died, December 14. His last words were characteristic. He said: 'I die hard; but I am not afraid to go. I believed from my first attack that I should not survive it. My breath cannot last long.' A little later he said: 'I feel myself going. I thank you for your attentions; but I pray you to take no more trouble about me. Let me go off quietly. I cannot last long.' After some instructions to his secretary about his burial, he became easier, felt his own pulse, and died without a struggle. He was mourned even by his enemies, and deserved the record: 'First in peace, first in war, and first in the hearts of his countrymen.' W. was 6 feet 2 inches high, with brown hair, blue eyes, large head, and strong arms; a bold and graceful rider and hunter; attentive to his personal appearance and dignity; gracious and gentle, though at times cold and reserved; childless, but very happy in his domestic relations and his adopted children—nephews and nieces. His best portraits are those by Stuart, and the statue by Houdin at Richmond. He was an exemplary member of the Church of England.—See art. UNITED STATES; also Sparks's *Life and Writings of Washington*, 12 vols. 8vo (Boston, 1834—1837); *Life of Washington*, by Chief-justice Marshall, 5 vols. 8vo (Philad. 1805); *Life of Washington*, by Washington Irving, 5 vols. 8vo (New York, 1855—1859); &c.

WASHINGTON, a territory of the U. S., in lat. 45° 30'—49° N.; long. 117°—125° W.; bounded N. by British Columbia, E. by the territory of Idaho, S. by the Columbia River, which separates it from Oregon, W. by the Pacific Ocean. Estimated area, 69,994 square miles. Its capital is Olympia. Port

Townsend is a flourishing site on Puget's Sound; and other new towns, with a multitude of mining villages and camps, are scattered over the territory. The chief rivers are the Columbia or Oregon, on the southern border, which also drains the whole territory east of the Cascade Mountains; the Okonagan, its great northern branch, flowing from the lake of the same name in British Columbia; Lewis or Snake River; and numerous streams emptying into Puget's Sound and the Pacific. W. is rich in sounds and harbours. Puget's Sound, from 1 to 4 miles wide, and 8 fathoms or more in depth, opens out of the Strait of Juan de Fuca, penetrating 100 miles into the heart of the country, and with its bays and islands forming one of the finest collections of harbours in the world. Hood's Canal, a narrower channel on the west, extends 60 miles. Bellingham, on the eastern shore of the Gulf of Georgia, has a tide of 20 feet. There are also large and deep harbours, suitable for naval stations, on the Strait of Juan de Fuca. The great range of Cascade Mountains, a continuation of the Sierra Nevada, passes through the centre of the territory from north to south, about 100 miles from the coast. Its chief summits are Mount Baker, lat. 48° 44', 11,900 feet, an active volcano; Mount Rainier, lat. 46° 40', 12,330 feet, an extinct volcano; Mount St Helen, 9550 feet, nearly extinct; Mount Adams, 9000 feet, entirely extinct. East of the Cascade Mountains, the soil is thin, rocky, dry, and sterile, but with fertile valleys; on the west, and especially around Puget's Sound, the soil is rich, and the country covered with a dense evergreen forest. West of the Cascades, the formation is of tertiary sandstone; near the Sound, the alluvium has a depth of 100 feet. Lignite, or tertiary coal, is found in many places. The mountains are granitic, and near Mount Adams is a large field of lava. East of the Cascade Mountains, the formations are igneous and metamorphic, with trap and volcanic scoriae. There are rich gold-diggings in the north-eastern portion. The climate in the western district is almost precisely that of England, with a rainfall of 53 inches; east of the mountains, there is but a quarter of the rainfall, and extremes of heat and cold. The timber in the western district is of great richness and abundance; the red fir and yellow fir (*Abies Douglasii* and *A. grandis*), growing 300 feet high, and 6 to 8 feet in diameter. The vegetable and animal productions are the same as in Oregon. Fish are very abundant, a dozen species of salmon filling all the streams, with halibut, cod, herrings, and sardines in great quantities. The water and mountain scenery is among the finest on the continent. The chief product is timber, of which 250,000,000 feet were produced in 1875. Steam saw-mills on Puget's Sound and Hood's Canal saw 150,000 feet a day. Wheat, barley, oats, potatoes, and the hardier fruits, are produced in abundance. This territory was discovered by Juan de Fuca, a Greek, in 1592; visited by a Spanish navigator in 1775, and three years after by Captain Cook. In 1787, Berkeley, an Englishman, re-discovered the Strait of Fuca, which had been missed by others. Captain Gray, an American, visited the coast in 1791; and the English Captain Vancouver in 1792; Captains Lewis and Clark explored the interior during the presidency of Jefferson, and settlements were made by the Hudson's Bay Company in 1828; in 1845, American settlers entered the territory, then a part of Oregon. It was constituted a separate territory in 1853. Wars with the Indians in 1855 and 1858 retarded immigration, but in the latter year 15,000 persons were attracted by the discoveries of gold-diggings at Fraser's River, many of

## WASHINGTON CITY—WASP.

whom became permanent settlers. White pop. (1870), 22,195; Indian population (1869), 15,808.\*

WASHINGTON CITY, the seat of the government of the U. S. of America, is in the district of Columbia, on the left bank of the Potomac River, between Anacostia River and Rock Creek, which separates it from Georgetown, lat. 38° 51' 20" N., long. 77° 0' 15" W., 35 miles south-west of Baltimore, 136 from Philadelphia, 205 from New York, 120 north-east of Richmond, 1203 from New Orleans, 2000 from San Francisco, 160 above the mouth of the Potomac, and 300 from the Capes of the Chesapeake. The Potomac at W. is one mile wide, and of sufficient depth for the largest vessels. The city was laid out under the direction of General Washington, on a handsome scale for the national capital, on a plateau 40 feet above the river, with several elevations, with streets from 90 to 120 feet wide, and 20

avenues, 130 to 160 feet. The principal edifices are the Capitol; the White House, residence of the president; Patent Office; General Post-office; Treasury, War, and Navy Departments; Smithsonian Institute (q. v.), &c. The Capitol, on the summit of a gentle elevation, in a pleasure-ground of 35 acres, was commenced in 1793, burnt by British troops in 1814, completed in 1825, and extended by the addition of two spacious wings in 1851; the centre is 352 feet by 101, with a lofty dome; the wings, 142 by 238 feet; the entire building being 751 feet long, 324 deep, covering 3¼ acres—the centre of white sandstone, the wings white marble. The Rotunda, under the dome, contains several national pictures by Trumbull, Weir, Vanderlyn, Powell, Chapman, &c. The Senate Chamber is a noble hall, 112 by 82 feet, with galleries for 1000 spectators; the Hall of Representatives is 139 by 93 feet, with

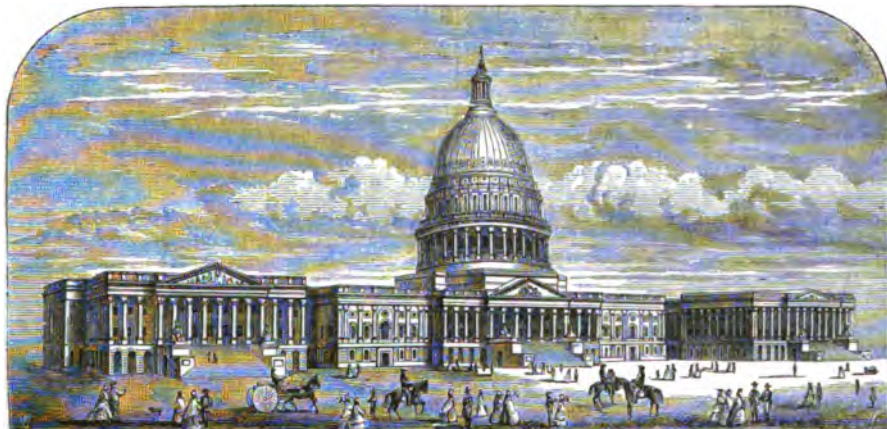

The Capitol at Washington.

galleries for 1200. The old Senate and Representative Chambers, used before the enlargement, are beautiful rooms. The Congressional Library, 91 by 34 feet, contained in 1876, upwards of 300,000 volumes. The Capitol, containing also numerous committee-rooms and offices, is highly ornamented with rich marbles, frescoes, and groups of statuary. The buildings of the Treasury and State Department, Post-office, &c., are massive and spacious. The saloons of the Patent Office, filled with models, are 1300 feet in length. A monument to Washington, intended to be 600 feet high, is one-third built. The city also contains numerous large hotels, 50 churches, a Roman Catholic and a Baptist college, three daily and several weekly newspapers, academies, schools, &c. The public buildings alone, however, are spacious and costly, the city in general having a scattered and mean appearance. During the War of Secession, from its exposed position, it was threatened with capture, and was surrounded by fortifications, and converted into an entrenched camp. Pop. in 1870, 109,199.

WA'SHITA, a river of the U. S. of America, rises on the western borders of Arkansas, and runs east and south-east through Louisiana, emptying into the Red River, 30 miles from its mouth; it is 500 miles long, and navigable to Camden, 300. Its chief branches are the Saline River, La Fourche, Tensas, and Little Missouri.

\* In 1860, before the abstraction of the eastern and larger portion of its area, which is now included in the separate territories of Idaho and Montana, W. Territory contained 193,071 square miles.

WASHOE SILVER MINES, a rich deposit of siliceous argentiferous galena, discovered in 1859 in a range of hills on the east side of the Sierra Nevada, on the borders of California and Nevada Territory, near the sources of Carson's River, 160 miles east by north of Sacramento. The ore produces as much as 2000 dollars to the ton, and is largely exported to England. The discovery of these mines caused a great excitement in California, and a large emigration.

WASP (*Vespa*), a Linnsean genus of insects, now forming the family *Vespidae*, a very numerous and widely distributed family, of the order *Hymenoptera* and section *Aculeata*. They are distinguished from all the other *Hymenoptera*, by their wings, when at rest, being folded throughout their entire length. The wings of all the wasps exhibit a similar pattern of nervation, with one marginal and three submarginal cells, and an incomplete terminal submarginal cell. Their antennæ are usually angled, and somewhat club-shaped at the extremity. The maxillæ are long and compressed; there are glands at the extremity of the labrum; the tongue is trifid, its tips lacinated. The body is naked, or but slightly hairy. The general appearance resembles that of bees; the colour is usually black, with yellow markings. The division between the thorax and abdomen is very deep, the abdomen often stalked. The legs are not fitted for collecting pollen, like those of bees. The females and neuters have stings, generally more formidable than those of bees. The larvæ have tubercles instead of feet. The wasps differ very widely in their habits, some being solitary, the

family *Eumenidae* of some entomologists; others social, to which the name *Vespidae* is sometimes restricted. Neuters are only found among the social wasps. Some of the solitary wasps make curious burrows in sand, or construct tubes of earthy paste on the sides of walls, in which they form cells for their eggs, at the same time placing there a store of food for the larvæ, some of them using for this purpose perfect insects, others caterpillars, which are stung so as to be rendered incapable of motion without being killed. Others make little earthen cells on the stems of plants, and store in them a little honey for their young. The social wasps have various modes of constructing their nests, which are sometimes formed in excavations in the ground, sometimes attached to walls, boughs of trees, &c., and formed of a paper-like, or sometimes a paste-board-like substance, produced by mixing into a pulp, with their saliva, small particles of woody fibre, torn by their broad and powerful mandibles from gate-posts, palings, the bark of trees, &c. Great diversities are to be seen in the arrangement of the combs within the nest. The combs are made of a substance similar to the outer covering of the nest, but generally thicker and firmer. As the nest is enlarged, new paper is made for the purpose, the whole nest being enclosed in the last-made envelope, and the inner ones, which sufficed for its former size, are removed to give place to combs. Several inner envelopes are generally found in a W.'s nest, so that paper-making must be a great part of the industry of these insects. The nests of the wasps of tropical countries are often very large, sometimes six feet long, and the communities very numerous. In colder regions, the increase of the community and of the nest is arrested by the approach of winter, when the males and the neuters die; but a few of the females survive, passing the winter in a torpid state in some retreat, and found new communities in spring. In a community of wasps there are many perfect females—not a single queen, as in the case of hive bees. Wasps in their perfect state feed very



Nests of Various Species of Wasps :  
1, *Vespa crabro*; 2, *V. holstetica*; 3, *V. vulgaris*.

indiscriminately on a great variety of animal and vegetable substances, as insects, flesh, fruit, sugar, &c. Grapes or gooseberries, especially if over-ripe, are often found to contain a W. in the interior. Wasps often invade bee-hives and steal honey. There is a Brazilian species (*Myropetra scutellaris*) which stores up honey like bees. Wasps may be killed by

pouring hot water on their nests; but more easily by the vapour of burning sulphur, when the nests are not in the ground; or ether or chloroform may be used to stupefy the wasps, so that the nest may be safely destroyed. The largest British species of W. is the Hornet (q. v.), found only in the south of England. The most abundant species, diffused over all parts of the country, are *Vespa vulgaris* and *V. media*. The former is about eight lines long. The front of the head is yellow, with a black centre; there are many yellow spots on the thorax, and a yellow band with black points at the posterior margin of each ring of the abdomen; the rest is black. *V. media* is very similar, but rather larger. *V. vulgaris* makes its nest in the ground; *V. media* suspends it generally to the branches of trees, but sometimes to the projections of walls.

WASTE, in English Law, has several meanings. (1.) It means a common belonging to a manor, and by analogy is often applied to pieces of land of no great value, lying at the sides of highways or the seashore. The presumption is that a strip of land adjoining a highway belongs to the owner of the land next to it. (2.) Waste also means the spoil or destruction to houses, gardens, trees, or other corporeal hereditaments, committed by tenants for life or for years, to the injury of the remainderman or reversioner. Thus, he who has a life estate, or an estate for years, in a house or land, cannot change the nature of things, as by turning meadow into arable, nor wood into pasture, though he may better a thing of the same kind, as by draining the meadow, &c. The alteration caused by thus diminishing an inheritance is called waste, and its characteristics are to diminish the value of the inheritance, or to increase the burden upon it, or to impair the evidence of title. Waste is either voluntary or permissive. The former consists in the commission of acts which the tenant has no authority to do—such as pulling down buildings, felling timber, or opening mines. Permissive waste arises from the omission of acts which it is the tenant's duty to do—as, for example, suffering buildings to go to decay by wrongfully neglecting to repair them. There is, however, incident to every estate for life or years, the right to take estovers—that is, so much wood, stone, &c., as is required for use on the tenement, for repairs, husbandry, and the like purposes. It is a common practice, in family settlements, to provide that, in addition to this privilege, the estates of the tenants for lives shall be without impeachment for waste. The effect of this clause is to enable the tenant to take timber, minerals, &c., severed by himself or others during the continuance of his estate. But even where the tenant holds without impeachment of waste, he is not entitled to cut down ornamental timber; and if he do so, a court of equity will restrain him by injunction. Wherever the tenant is committing acts of a character especially destructive to the inheritance, or still more, acts of wanton or malicious mischief, the Court of Chancery holds that his legal power to commit waste is being used unconscientiously, and will restrain him.

WASTE LANDS, according to the general use of the term, are uncultivated and unprofitable tracts in populous and cultivated countries. The term waste lands is not employed with reference to land not reduced to cultivation in countries only partially settled. There is a large extent of waste lands even in the British Islands. Of the 77,800,000 acres which they contain, only about 47,000,000 are arable land and improved pasture; 2,000,000 acres are occupied with woods and plantations; 7,000,000 acres in Scotland consist of sheep-pasture, generally at a considerable elevation, and little improved by art;

8,000,000 acres in Ireland are unenclosed pasture, generally quite unimproved; 3,000,000 acres are mountain and bog; and the remainder consists of unimproved and very unproductive land of other kinds.

The improvement of waste lands is very much a question of expense. It is often more profitable to improve lands already cultivated, and to bring them into a higher state of cultivation and productiveness, than to reclaim waste lands; in attempting which, much money has often been lost. Much of the cultivated land of Britain is far from having been brought to the highest state of cultivation of which it is evidently capable, or to a state equal to that of the best cultivated lands of similar soil and situation. In many instances, however, waste lands have recently been improved with great advantage, and it seems probable that no small part of the waste lands of the country are capable of profitable improvement. The process must often be slow and gradual, especially where the soil is naturally very poor, as even the addition of large quantities of manure to very poor soils will not render them fertile, but on the contrary will be followed by a sterility greater than before. The quantity of guano which a rich soil would gratefully receive, will destroy every vestige of vegetation on a very poor soil.

The waste lands of Britain are of very various character. Some of them are bogs, already sufficiently noticed in the article BOG. Others are marshes and fens, generally very near the level of the sea, and often within the reach of its tides, chiefly in the eastern counties of England. See BEDFORD LEVEL. Of these, a great extent has been reclaimed, and has become very productive; much still remaining, however, to be done. There are also extensive moors both in England and in Scotland, often of very poor soil, and often also at such an elevation above the level of the sea, as to render profitable agriculture hopeless. This is not the case with all the moors, and it is sometimes possible to effect great improvement by drainage; so that land, formerly almost worthless, may be converted into good pasture. In many places, the heath has been extirpated, and the moorland changed into good pasture, and even into good arable land. It is sometimes found very profitable to break up such land, even at very considerable elevations, and afterwards to lay it down in pasture, the produce being much greater than it was before. Even in the most elevated tracts, drainage is beneficial; although it must always be considered whether or not drainage will pay. The highest sheep-pastures of the south of Scotland have been greatly improved by a kind of superficial drainage (*sheep-drains*), consisting of mere open channels for water; but in the greater altitudes of the Highlands, and amidst their more rugged steeps, even this is out of the question. In some cases, chiefly of the more level moorlands, much improvement is effected by *paring and burning*, the surface being pared off by the *breast-plough* or *paring-spade*, and burned, generally in heaps, of which the ashes are spread upon the soil. The application of lime is of great benefit in many cases, as is also that of chalk and of marl, but the expense must always be considered, and many tracts of waste lands are so situated that the application of such manures is impossible. Railways have rendered the reclamation of waste lands profitable in many districts, in which formerly it would not have been so.—The chalk downs of the South of England may, in great part, almost be considered as waste lands, although used for sheep pasture; but they have been found capable of great improvement, although in a slow and gradual manner, by tillage,

and the application of manures.—Sands near the sea-shore are fixed by sowing certain grasses (see AMMOPHILA), and are capable of further improvement by cultivation and the application of manures; particularly where the sand is in considerable part calcareous. The most barren and hopeless sands are those which are almost entirely siliceous. An experiment, on a very large scale, is now in process of being made, on a sand of this kind, on the coast of Essex, by applying to it the sewage of London. Very different opinions have been expressed by scientific men, as to the probable result of the experiment. Liebig deemed the siliceous sand incapable of profiting by the rich manure poured upon it. The experiment is one of importance, not only as to the reclamation of waste lands, but as to the great question of the disposal of the sewage of towns.

WASTING PALSY is one of the terms applied to the disease described in this work under its old name of TABES DORSALIS.

WATCH, a small portable machine for measuring time, the construction of which is essentially the same as that of a clock (see HOROLOGY), except that the moving power is obtained from the elastic force of a coiled spring instead of from a weight, and the movement regulated, so as to be isochronous, by a Balance and Balance-spring (q. v.) instead of a pendulum. The going part of a watch consists of a train of wheels and pinions, kept in motion by a spring, called the main-spring; the last and fastest wheel of the train, the scape-wheel or balance-wheel, acting so as to keep in vibratory motion a balance whose movement, again—which is made isochronous by the action of another spring called the balance-spring—regulates to a uniform rate the revolution of the scape-wheel, and consequently the motion of the rest of the train, and the uncoiling of the main-spring.

The main-spring is a thin ribbon of steel coiled in a barrel. The inner end of it is fixed to a strong spindle, the axis or *arbor* of the barrel, around which it is coiled, and the outer end is fixed to the inside of the barrel. By its tendency to uncoil itself, the spring sets the barrel in motion, and it produces as many revolutions of the barrel as it makes turns itself in unwinding (fig. 1). As its elastic force is greater when it is tightly coiled than when it has to some extent unwound itself, the spring, if its force were applied without modification to the watch-train, would act upon it unequally, the power exerted diminishing as the spring uncoiled; so much so, that the watch could not go uniformly throughout the day, though it might keep time from one day to another. A piece of machinery, called a fusee, is employed to correct the variations in the force of the spring, and equalise the power exerted upon the train. The fusee is a cone with a spiral groove, connected with the barrel which contains the main-spring by a chain, one end of which is fixed at the broadest part of the cone, and the other end to the barrel (fig. 2). The barrel moves the fusee by means of the chain, which, as it runs off the sides of the fusee, is coiled upon the outside of the barrel. In winding a watch the key is placed on the axis of the fusee, and by the same movement the main-spring is coiled around its spindle, and the chain wound off the barrel, to cover the cone of the fusee. So when the spring is all coiled up, and its force upon the barrel is greatest, the chain is acting at the small end of

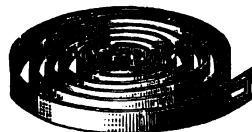

Fig. 1.

81

the fusee, and its leverage upon the fusee is least; as the force of the spring diminishes, the chain having got to a broader part of the fusee, the leverage is increased; and the grooving of the fusee being,

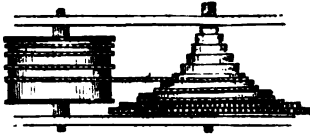

Fig. 2.

when perfect, arranged so that a section of the fusee along its axis would present two hyperbolas placed back to back, secures that the force of the spring, modified by the leverage of the chain, shall produce a uniform motion of the fusee. From the fusee this motion is communicated to the watch-train, the first wheel of the train—called the fusee-wheel or the great wheel—being set upon the fusee. The fusee is introduced in almost all English watches; but a great proportion of foreign watches, and most French spring clocks, have no fusee, and have the great wheel fixed on to the barrel. Accurate time-keeping is not to be looked for from such clocks or watches; but it is said that many of the main-springs made upon the continent are so skilfully contrived, that the force is pretty constant during the whole time of unwinding.

Between the train of wheels and pinions in a watch and that of a clock, until we come to the escapement, there is no difference, except that there is one more wheel and pinion in the watch-train than in the clock-train; the reason of which is, that the scape-wheel of a watch revolves, not like that of a clock, in a minute, but usually in about six seconds, making necessary an additional wheel to revolve in a minute and carry the seconds hand. A great variety of watch escapements are in use. The oldest, which is now going out of use, is the vertical escapement. It exactly corresponds to the crown-wheel escapement in clocks (see HOROLOGY). The accompanying figure shews a watch-train with this escapement. It may be useful also as indicating, in a general way, the arrangement of the wheel-work in a watch (fig. 3). The main-spring contained in the barrel B, sets in motion

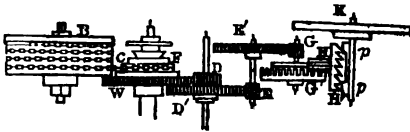

Fig. 3.

the barrel, which, by means of the chain *c*, moves at a uniform rate the fusee *F*, along with which turns the fusee-wheel *W*, the first or great wheel of the watch-train. It will be easily seen how, from the great wheel, motion is communicated successively to the centre-pinion *D*, and the centre-wheel *D'* (which turn in an hour); to the third-wheel pinion, *E*, and the third wheel, which is upon the same arbor, *E'*; and to the fourth or contrate-wheel pinion *G*, and the contrate-wheel *G'*. The upright teeth of the last-named wheel move the balance-wheel *H*, and with it the balance-wheel or scape-wheel *H'*, which is fixed upon its arbor. The scape-wheel (and in this escapement the contrate-wheel also) is what is called, from its shape, a crown-wheel. Upon the arbor or verge of the balance *K*, are two pallets, *p, p*, at a distance from each other, equal to the diameter of the scape-wheel, and so

placed that, as the scape-wheel revolves, its teeth give them alternately an impulse in different directions, which keeps up the vibratory motion of the balance. The balance is made to vibrate isochronously by the action of the Balance-spring (*q. v.*); and its vibration regulates the escape of the teeth of the scape-wheel, and so the motion of the whole train, exactly as that of the pendulum does in an ordinary clock. The vertical escapement is liable, though in a less degree, to the same objection as the old crown-wheel and the crutch or anchor escapements in clocks. There is a recoil of the scape-wheel after one of its teeth has been stopped by a pallet, which interferes more or less with the accuracy and uniformity of the motion of the train. See HOROLOGY.

Almost immediately after the invention of the balance-spring, attempts began to be made to introduce an escapement which would produce greater accuracy than the vertical escapement. Hooke, Huygens, Hautefeuille, and Tompion introduced new principles, each of which has since been successfully applied, though they all, from imperfect execution, failed at the time. The first real improvement was made by George

Graham, the inventor of the dead escapement in clocks (fig. 4). This is called the horizontal escapement; it was introduced in the beginning of the last century, and it is still the escapement used in most foreign watches.

The impulse is given to a hollow cut in the cylindrical axis of the balance, by teeth of a peculiar form projecting from a horizontal crown-wheel. Other forms of escapement in high estimation are the lever escapement, originally invented by Berthoud, improved by Mudge; the duplex escapement, the principle invented by Hooke, the construction perfected by Tyrer; and the detached escapement of Berthoud, improved by Arnold and Earnshaw. The last-mentioned is that which is employed in marine chronometers and in pocket-chronometers, as watches made in all respects like chronometers are called. The lever escapement is that which is used in most English watches. In it the scape-wheel and pallets are exactly the same as in the dead escapement in clocks. See HOROLOGY. The pallets, *p, p* (fig. 5)

are set on a lever which turns on their arbor, *A*; and there is a pin, *B*, in a small disc on the verge or arbor of the balance, which works into a notch at the end of the lever. The pin and notch are so

adjusted, that when a tooth of the scape-wheel has got free, the pin slips out of the notch, and the balance is detached from the lever during the remainder of its swing; whence the name *detached* lever escapement, originally applied to this arrangement. On the balance returning, the pin again enters the notch, moving the lever just enough to send the tooth next in order to escape from the dead face of the pallet on to the impulse face; then the scape-wheel acts upon the lever and balance; the tooth escapes, and another drops upon the dead face

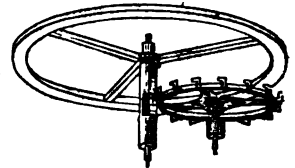

Fig. 4.

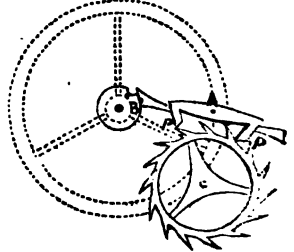

Fig. 5.

## WATCH.

of the pallet, the pin at the same time passing out of the notch in the other direction, leaving the balance again free. This arrangement is found to give great accuracy and steadiness of performance. To prevent the teeth from slipping away while the balance is free, the faces of the pallets are slightly undercut, and this makes them secure while at rest; moreover, there is a pin on the lever which moves through a notch on the balance disc, while the pin, B, moves through the notch in the lever, which is so adjusted as to guard against the lever moving and the teeth escaping, while the balance is free.

In watches, even more than in clocks, variations of temperature, unless provided for, produce variations in the rate of going, the increase or diminution of the temperature affecting to some extent the moment of inertia of the balance, and to a great extent the elastic force of the balance-spring. A rise in the temperature makes the balance expand, and therefore augments its moment of inertia; it adds to the length of the spring, and thereby diminishes its elasticity, the elastic force of a spring varying inversely as the length; and the time of vibration of the balance, which depends upon the moment of inertia directly, and upon the elastic force of the spring inversely, is increased—the watch, that is, goes more slowly—in consequence both of the increase of the inertia and of the diminution of the elastic force of the spring. A fall in the temperature is attended by opposite results, the watch going more rapidly than before. A watch without a compensated balance would vary very much more than a clock without a compensation pendulum, but that being usually carried in the waistcoat pocket, it is kept at a pretty uniform temperature. To invent a satisfactory compensation was at one time the great problem for watchmakers. The compensation can obviously be made in either of two ways—by an expedient for shortening the effective length of the balance-spring as the temperature rises, so as to increase the elastic force of the spring; or by an expedient for diminishing the moment of inertia of the balance as the temperature rises, so as to correspond to the diminution of the force of the spring. The first method was that made use of by John Harrison (q. v.), who first succeeded in making a chronometer capable of measuring time accurately in different temperatures; but an adaptation of the other method,

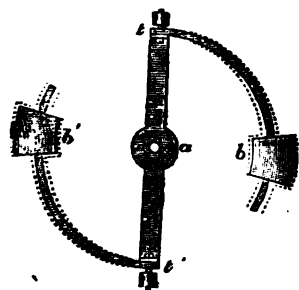

Fig. 6.

invented about eighty years ago by Earnshaw, is that which is always employed now (fig. 6): *t a e* is the main bar of the balance; and *t b, e b* are two compound bars, of which the outer part is of brass and the inner part of steel, carrying weights, *b, b'*, which may be screwed on at different places. The brass bar expands more with heat, and contracts more with cold than the steel bar; therefore, as the temperature rises, the bars, with their weights, bend inwards, and so the moment of inertia of the balance is diminished; as it falls, they bend outwards, and the moment of inertia is increased; and of course the diminution or the increase must be made exactly to correspond to the diminution or increase in the force of the spring.

The chronometer is just a large watch fitted with

all the contrivances which experience has shewn to be conducive to accurate time-keeping—a g., the cylindrical balance-spring, the detached escapement, and the compensation-balance. As a watch which will keep time in one position will often not do so equally well in another, marine chronometers are always set horizontally in a box in *Gimbals* (q. v.), an arrangement which keeps the chronometer horizontal, whatever the motion of the vessel.

The great importance of an accurate portable time-keeper at sea is for determining the Longitude (q. v.). This use was first distinctly pointed out by Sir Isaac Newton. A committee of the House of Commons, of whom this philosopher formed one, having been appointed on the 11th June 1714, to consider the question of encouragement for the invention of means for finding the longitude, the result of their meetings was a memorial containing an explanation of the different means proper for ascertaining the longitude, and recommending encouragement for the construction of chronometers as the best means of ascertaining it. An act of parliament was then passed, offering a reward for this purpose.

The first chronometer used at sea was invented by John Harrison. After many years of study it was completed in 1736. After several further trials and improvements, and two trial voyages to America, undertaken for the satisfaction of the commissioners, the last of which was completed on the 18th September 1764, the reward of £20,000 was finally awarded to Harrison.

Somewhat later than this, several excellent chronometers were produced in France by Berthoud and Le Roy, to the latter of whom was awarded the prize by the Académie Royale des Sciences. Progress was still made in England by Arnold, Earnshaw (the inventor of the compensation still in use), and Mudge, to whom prizes were awarded by the Board of Longitude, and under whom a perfection nearly equal to that of the present day was obtained. The subsequent progress of watch-making has been chiefly directed to the construction of pocket-watches on the principle of marine chronometers, or to the combination of accuracy with convenient portability. The adjusted lever watch is now made in Clerkenwell with a degree of accuracy which enables the performance to be warranted within an error of one second a day.

While the compensation of a chronometer can never be made perfectly accurate for all degrees of temperature, there are always two temperatures at which a well-constructed chronometer will go with perfect accuracy. The explanation of this lies in the fact that while the variations of elastic force in the spring go on uniformly in proportion to the rise or fall of the temperature, the inertia of the balance cannot be made to vary as it should do, in exact correspondence to them inversely. The variation of the elastic force may be represented by a straight line inclined at some angle to a straight line divided into degrees of temperature; the corresponding changes of the moment of inertia will be represented by a curve, and this curve can coincide with the straight line representing the variations of elastic force only at two points, corresponding to two different temperatures. The particular points in the case of any chronometer are matter of adjustment. For instance, one chronometer may be made to go accurately in a temperature of 40°, and also in a temperature of 80°, at other temperatures being not so accurate; another chronometer to go accurately at a temperature of 20° and of 60°. It is manifest that the former would be adapted to voyages in a warmer, the latter to voyages in a colder climate. Apparatus for testing chronometers have been long in use in the observatories at Greenwich



and Liverpool. In the latter, there is now an extensive apparatus for this purpose, devised by the ingenious astronomer, Mr Hartnup. In a room which is isolated from noise and changes of temperature, the chronometers are arranged on a frame under a glass case, so contrived that they may be subjected in turn to any given degree of temperature. The rate of each under the different temperatures is observed and noted, and the chronometers registered accordingly. These observations are of the greatest importance both to ship-captains and instrument-makers, who can have their instruments subjected to the observations on payment of a fee.

It may be stated that the main-spring had been employed as the moving force of time-keepers for about a century before the invention of the balance-spring; but very little is known about the action of these forerunners of the watch. A watch without a balance-spring must have been a very rude and untrustworthy contrivance. The honour of first proposing the balance-spring is undoubtedly due to Dr Hooke, though Huygens and De Hautefeuille also invented it independently much about the same time.—See Denison's *Rudimentary Treatise on Clocks and Watches*; Wood's *Curiousities of Clocks and Watches*; Benson's *Time and Time-tellers* (1875).

**WATCH**, on Shipboard, a division of the crew into two, or if it be a large crew, into three, sections; that one set of men may have charge of the vessel while the others rest. The day and night are divided into watches of four hours each, except the period from 4 to 8 P.M., which is divided into two *dog-watches* of two hours' duration each. The object of the dog-watches is to prevent the same men being always on duty at the same hours.

**WATCHING AND WARDING**, in Scotch Law, mean the services rendered by one who holds lands under burgage tenure. These services are merely nominal.

**WATCH-RATES**, in England, are the rates authorised to be levied in a parish or borough under the Watching and Lighting Act, 3 and 4 Will. IV. c. 90, for the purpose of watching and lighting the parish.

**WATER** (symb. HO,\* equiv. 9, spec. grav. 1), in a state of purity, at the ordinary temperature of the air, is a clear, colourless,† transparent liquid, perfectly neutral in its reaction, and devoid of taste or smell. At a temperature below 32° it freezes, crystallising in various forms derived from the rhombohedron and six-sided prism. See ICE; SNOW; FUSING AND FREEZING POINTS; HEAT. It appears from the researches of Arago and Fresnel, that notwithstanding the gradual dilatation of water below 39°, its refractive power on light con-

\* During recent years Gerhardt's views as to the necessity of doubling the atomic weights of oxygen, carbon, sulphur, and a few other of the elements have been gradually gaining ground. Thus, the combining numbers of oxygen, carbon, and sulphur, instead of being 8, 6, and 16, are now fixed at 16, 12, and 32, and the corresponding symbols are indicated by a horizontal bar, which doubles the value of the symbol;  $\bar{O}$ ,  $\bar{C}$ , and  $\bar{S}$  being written in place of O, C, and S. According to these views, the symbol for an equivalent of water is  $H_2\bar{O}$ , or  $H_2O_2$ , in place of HO, and the combining number is 18 in place of 9 (see CHEMISTRY, in SUPP., Vol. X.)

† Although water is colourless in small bulk, it is blue like the atmosphere when viewed in mass. This is seen in the deep ultramarine tint of the lakes of Switzerland and other Alpine countries, and in the rivers issuing from them; and in the water in the fissures and caverns found in the ice of the glaciers, which, except on the surface, is extremely pure and transparent; and the deep blue tint of the ocean is doubtless due to the water itself, rather than to the salts dissolved in it.

tinues to increase regularly, as though it contracted. Its density at 60°, and at the level of the sea, is taken at 1.000, and forms the standard of comparison for all solids and liquids, hydrogen being similarly taken as the standard of comparison for gases and vapours. Distilled water is 815 times heavier than air; a cubic inch weighs, in air at 62°, with the barometer at 30 inches, 252.458 grains, and *in vacuo*, 252.722 grains, the grain being  $\frac{1}{7000}$  of the avoirdupois pound. See AVOIRDUPOIS, GALLON. For all practical purposes, water may be considered as incompressible; but very accurate experiments have shewn that it does yield to a slight extent when the pressure employed is very great; the diminution of volume for each atmosphere of pressure being about 51-millionths of the whole.—See Miller's *Chemical Physics*, 3d ed. p. 41. Water evaporates at all temperatures, and under the ordinary pressure of the atmosphere, boils at 212°, passing off in the form of steam, which, in its state of greatest density at 212°, compared with air at the same temperature, and with an equal elastic force, has a spec. grav. of 0.625. In this condition it may be represented as containing, in every two volumes, two volumes of hydrogen and one volume of oxygen. See BOILING, STEAM, VAPOUR.

Water is the most universal solvent with which the chemist is acquainted, and its operations in this respect are equally apparent, although on very different scales, on the surface of the globe and in the laboratory. This solvent action is usually much increased by heat, so that a hot aqueous saturated solution deposits a portion of the dissolved matter on cooling. Some substances are so soluble in water, that they extract its vapour from the atmosphere, and dissolve themselves in it. Moreover, when water is heated in a strong closed vessel to a temperature above that of the ordinary boiling-point, 212°, its solvent powers are much increased. Pieces of plate and crown glass, acted upon for four months by water at 300° (in a steam-boiler), were found by the late Professor Turner to be reduced to a white mass of silica, destitute of alkali; while stalactites of siliceous matter, more than an inch in length, hung from the little wire cage which enclosed the glass—an experiment illustrating the action which goes on in the Geyser springs of Iceland, which deposit siliceous sinter. All gases are soluble in water, but water dissolves very unequal quantities of different gases, and very unequal quantities of the same gas at different temperatures. Some gases are so extremely soluble in this fluid, that it is necessary to collect them over mercury. For example, at 32°, 1 volume of water dissolves somewhat less than  $\frac{1}{4}$ th of its volume of hydrogen, and exactly  $\frac{1}{4}$ th of its volume of nitrogen, while it dissolves 506 and 1050 volumes of hydrochloric acid and ammonia gases: and while at 32° water dissolves 1.8 times its volume of carbonic acid, it dissolves only half that volume of the gas at 60°.

Water enters into combination with acids, bases, and salts. When an acid has once been allowed to combine with water, the latter can seldom be entirely removed unless by the intervention of a powerful base, which displaces the water, and allows of its removal by heat. For example, if sulphuric acid be largely diluted with water, and exposed to heat, watery vapour alone at first passes off; but as the temperature is raised to about 600°, a point is reached at which acid and water distil over together. The liquid at this stage of concentration is found to be composed of one equivalent of acid and one of water ( $HO,SO_2$ ). The further separation of the water can only be effected by the addition of a base, as potash, oxide of lead, &c. Water which, as in this case, supplies the place of a

## WATER.

base, is called *basic water*, and the compound is called a *hydrate*, or is said to be *hydrated*. Similarly, water combines with strong bases, such as potash and soda, and heat can only succeed in reducing a mixture of potash and water to a condition represented by one equivalent of each (HO, KO); and this last equivalent of water can only be removed by the addition of an acid. In this case, the water in combination with the base acts the part of an *acid*. These compounds also are *hydrates*. In these cases of acids and bases, the one equivalent of water cannot be removed without completely altering the chemical character of the body. (See, for instance, in the article SULPHURIC ACID, the difference between the properties of hydrated sulphuric acid and sulphuric anhydride.) In the case of many salts, however, a certain quantity of the water entering, so to speak, loosely into their composition may be expelled by heat without altering the properties of the salt. The water capable of being thus got rid of is called *water of crystallisation*, and is taken up by the salt in the act of crystallising. The form of the salt depends upon this water of crystallisation. In chemical formulae, this variety of water is represented by Aq instead of by HO. For example, in the formula for rhombic phosphate of soda— $2\text{NaO}, \text{HO}, \text{PO}_5 + 24\text{Aq}$ —the HO represents an equivalent of basic water, while 24Aq represents 24 equivalents of water of crystallisation.

It is less than a century since the ancient view, that water was one of the four elements, has ceased to be believed in. It is now known that it is a compound of oxygen with hydrogen in the proportion of one equivalent of each. Hence its symbol is HO, and its combining number 9. When converted into vapour, 9 grains of steam occupy the bulk of 8 grains of oxygen at the same temperature; hence the combining volume of aqueous vapour is equal to 2, if the combining volume of oxygen be taken as 1. That water is such a compound as has been just stated may be proved either analytically or synthetically; and the subject is one of so great importance in the history of chemistry, that we shall enter rather more fully than usual into the consideration of these two modes of proof. The following simple mode of separating water by voltaic electricity into its constituent elements is borrowed from Fownes's *Manual of Chemistry*: 'When water is acidulated so as to render it a conductor, and a portion interposed between a pair of platinum-plates connected with the extremities of a voltaic apparatus of moderate power, decomposition of the liquid takes place in a very interesting manner; oxygen in a state of perfect purity is evolved from the water in contact with the plate belonging to the copper end of the battery, and hydrogen, equally pure, is disengaged at the plate connected with

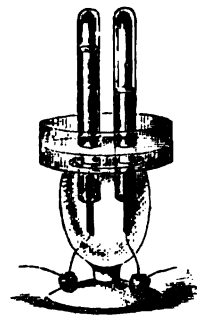

the zinc extremity, the middle portions of the liquid remaining apparently unaltered. By placing small graduated jars over the platinum-plates, the gases can be collected, and their quantities determined. The accompanying figure will shew at a glance the whole arrangement; the conducting-wires pass through the bottom of the glass cup and away to the battery.

When this experiment has been continued a sufficient time, it will be found that the volume of the hydrogen is a *very* little above twice that of the oxygen; were it not for the circumstance of oxygen being sensibly more

soluble in water than hydrogen, the proportion of two to one by measure would come out exactly.' In lecture-rooms, an ingenious but more complicated apparatus, devised by Kopp, is commonly used to illustrate the electrolysis of water. It has been shewn by Mr Grove that an extreme heat may, like electricity, be employed to decompose water into its constituents; and it is well known that if, in the form of steam, it be passed over red-hot iron, it parts with its oxygen to the metal, while the hydrogen is given off as gas. The synthetical proof of the composition of water is afforded by passing pure hydrogen and oxygen, in the ratio of two volumes of the former to one volume of the latter, into a strong glass tube filled with mercury, and exploding the mixture by an electric spark, when the gases are replaced by a corresponding quantity of moisture, and the mercury is forced into the tube so as to fill it. The most satisfactory form of this synthetical proof is, however, afforded by reducing pure oxide of copper at a red heat by hydrogen, and collecting and weighing the water that is thus formed. The apparatus required for this experiment, and the method of employing it, are given in Fownes's *Manual of Chemistry*, 9th ed., p. 131, and in Miller's *Inorganic Chemistry*, 3d ed., p. 52.

Owing to its extremely solvent powers, the *pure water* which we have been hitherto considering is never found in nature. The nearest approach to a natural pure water is *rain-water*, after a continuance of wet weather; but even this water always contains in 100 volumes about 2.5 volumes of atmospheric air, with a trace of ammonia; and in point of fact, it seems impossible to obtain water which does not contain this ingredient, for, after two distillations, Professor Miller found from 1.85 to 2.38 volumes of air in 100 volumes of water. In addition to rain-water, the other *natural waters* may be included under the heads of *Spring-water*, *Mineral Waters* (already considered in a special article), *River-water* (see WATER-SUPPLY), and *Sea-water* (see below).

This article would be incomplete without a brief notice of the prolonged and acrimonious controversy that was for many years carried on, and is probably now hardly to be regarded as settled, regarding the respective claims of different philosophers to be the true discoverer of the nature and composition of water. In the year 1781, Cavendish made a long and careful series of experiments, which, unfortunately, were not published till January 1784, when his celebrated Memoir entitled *Experiments on Air*, was read to the Royal Society. In the interval (June 1783), his friend, Dr Blagden, visited Paris, and on the authority of Cavendish, gave an account of the experiments proving the composition of water to Lavoisier; and this delay between the discovery and the date of publication caused his claims to one of the most marvellous discoveries the world ever saw, to be contested by an English and a French rival, James Watt and Lavoisier. It may be briefly stated, that Cavendish's experiments consisted in exploding, in various proportions, mixtures of hydrogen and atmospheric air, and of hydrogen and oxygen, and finding as the result a liquid which proved to be pure water. (Priestley and his friend, Mr Warltire, had made similar experiments, and had noticed the deposition of moisture that followed the explosion, but failed to recognise in it anything but the condensation of aqueous vapours in the gases.) The general conclusion to which Cavendish came was, in his own words, 'that water consists of dephlogisticated air united with phlogiston,' and as dephlogisticated air was his term for oxygen, and phlogiston his term for hydrogen, this statement corresponds to the modern view of the

nature of water introduced by Lavoisier. As Lavoisier was from the first accused by the English chemists of having acted unfairly towards them, and as indeed his own claim only dates back to June 25, 1783, he may be dismissed from further consideration; and during the lives of the English claimants there were no public complaints on either side, although Watt, in private letters to his friends, hinted at Cavendish's incapacity and unfairness. Hence, then—at all events, in this country—scientific men were startled when Arago, then Secretary of the French Academy, published in 1838 the Eloge of Watt, which he had read as far back as December 1834, in which he charged Cavendish with deceit and plagiarism, inasmuch as he was said to have learned the composition of water, not by experiments of his own, but by obtaining sight of a letter from Watt to Priestley. The battle now fairly began; the first blow being struck in August 1839, when the President of the British Association, the Rev. Vernon Harcourt, in his opening address, vindicated Cavendish, and pointed out Arago's misstatement. At a subsequent meeting of the Academy, Arago, with Dumas to back him, defended his statements. Sir David Brewster (*Edin. Rev.*, January 1840) then sought to act as mediator; and the controversy, as might have been expected, went on with increased acrimony; and in the summer of the same year, when the President of the British Association published the Report he had delivered the preceding year, he added a postscript, replying to Arago, Dumas, and Lord Brougham (who had appended 'An Historical Note on the Discovery of the Theory of Water,' to Arago's Eloge). In 1841, Berzelius published what Dr George Wilson terms 'a conditional judgment' in favour of Watt; and in 1845, in his *Lives of Men of Letters* (see *Life of Watt*, p. 400), Lord Brougham followed on the same side. Dr Peacock (*Quart. Rev.*, 1845, p. 105), in reviewing his book, assailed his conclusions, and asserted the claims of Cavendish. In 1846, Mr Harcourt (*Lond. and Edin. Phil. Mag.*, Feb. 1846) also replied to Lord Brougham; and in 1847, in the second edition of his *History of the Inductive Sciences*, Dr Whewell maintained his old conviction of the claims of Cavendish. In 1846, the publication of the *Correspondence of the late James Watt on his Discovery of the Theory of the Composition of Water*, with an introduction by his kinsman, Mr Muirhead, who was editor, and a letter from his son, formed a most important addition to the literature of this controversy. Finally, the question was discussed, in 1847, by Sir David Brewster in the *North British Review*, and in 1848, by Lord Jeffrey in the *Edinburgh Review*, both of whom advocated the claims of Watt. As we have no space to discuss Watt's real claims, we may here state that Dr George Wilson, whose *Life of Cavendish* is in reality a strictly impartial history of the water-controversy, maintains on very sound grounds that in reality Watt was informed of Cavendish's discovery through Priestley, as Lavoisier was through Blagden.

SEA-WATER.—For an accurate knowledge of the composition of sea-water, we are mainly indebted to the investigations of Professor Forchhammer of Copenhagen. Not very many years ago, the only elements known to exist in sea-water, in addition to those constituting water itself, were chlorine, iodine, bromine, sulphur, carbon, sodium, magnesium, potassium, calcium, and iron. To these twelve must now be added, (13) fluorine, discovered by Dr George Wilson; (14) phosphorus, as phosphate of lime; (15) nitrogen, as ammonia; (16) silicon, as silica, in which form it is largely collected by sponges from sea-water; (17) boron, as boracic acid; (18) silver; (19)

copper; (20) lead; (21) zinc; (22) cobalt; (23) nickel; (24) manganese; (25) aluminium, as alumina; (26) strontium, as strontia; (27) barium, as baryta. Several of these elements, however, exist in such small quantities that they can only be discovered indirectly, that is to say, in sea-weeds, marine animals, or in the stony matter deposited at the bottom of the boilers of oceanic steamers. The substances which, in respect of quantity, play the principal part in the composition of sea-water are chlorine, sulphuric acid, soda, potash, lime, and magnesia; those which occur in less but still determinable quantity, are silica, phosphoric acid, carbonic acid, and oxide of iron. In the elaborate tables which are annexed to his paper, Forchhammer has always calculated the single substances (chlorine, sulphuric acid, magnesia, lime, and potash) and the whole quantity of salt for 1000 parts of sea-water; but besides this, he has calculated the proportion between the different substances determined, referred to chlorine = 100, and of all the salts likewise referred to chlorine. This last number is found if we divide the sum of all the salts found in 1000 parts of any sea-water by the quantity of chlorine found in it; and he terms it the *co-efficient* of that sample of sea-water.\* This chemist divides the sea into seventeen regions, his reasons for doing so being that he could thus avoid the prevailing influence which those parts of the ocean which are best known, and from which he has taken most observations, would exert upon the calculations of the mean number for the whole ocean. In reference to the *salinity* of the surface of the ocean, he has made the following observations. (1.) The mean salinity of the Atlantic between 0° and 30° N. lat. is 36.169 (i.e., this is the quantity of salts in 1000 parts of water); the maximum, which is also the maximum of the surface-water of the whole Atlantic, being 37.908, and occurring in 24° 13' N. lat., and about 5° W. from the coast of Africa, where no rivers of any size carry water from the land, and where the influence of the dry and hot winds of the Sahara is prevailing. This maximum is equal to the mean salinity of the Mediterranean, and is only exceeded by the maximum of that sea off the Libyan Desert, and that of the Red Sea. The minimum is 34.233 in 4° 10' S. lat., and 5° 36' W. long., close to the coast of Africa, where the large masses of fresh water which the great rivers of that region pour into the ocean exercise their influence. (2.) In the Atlantic, between 30° N. lat. and a line drawn from the north point of Scotland to the north point of Newfoundland, the mean salinity is 35.946, the diminution being due to the fresh water poured into it by the southern mouth of the St. Lawrence. (3.) In the Baffin's Bay and Davis' Strait region, the mean salinity is 33.281, and the salinity increases from latitude 64° towards the north, being in 64°, 32.926, and in 69°, 33.598. This peculiarity is owing (says Forchhammer) to the powerful current from the Parry Islands, which through different sounds passes into Baffin's Bay, where it is mixed with the great quantity of fresh water that comes into the sea from the West Greenland glaciers. Had this fact been known before the sounds that connect the Parry Archipelago with Baffin's Bay were discovered, it might have proved the existence of these sounds, because bays and inlets shew quite the reverse: the further we get into them, the less saline the water becomes. (4.) From eleven observations on the Mediterranean between the Straits of Gibraltar and the Greek Archipelago, he confirms the old view of

\* We give these details because the term *co-efficient* will now doubtless be permanently retained by writers on the chemistry of sea-water.

its great salinity; its mean salinity being 37.936, while that of the whole ocean is 34.388. Its maximum (39.257) falls between the island of Candia and the African shore; and its minimum (36.301) is at the Straits of Gibraltar. These results are due to the influence of Africa and its hot and dry winds. In salinity, the Mediterranean is only exceeded by the Red Sea, whose mean salinity is 43.067. (5.) The Black Sea, like the Baltic, is a mixture of salt and fresh waters. In three different experiments, the salinity varied from 18.146 to 11.880. At a distance of 50 miles from the Bosphorus, the proportions between chlorine, sulphuric acid, lime, and magnesia, were 100 : 11.71 : 4.22 : 12.64, while the normal oceanic proportions are 100 : 11.89 : 2.96 : 11.07; thus shewing a relative increase in the lime and magnesia. (6.) As the Caspian Sea is considered by many geologists to have been formerly in connection with the Black Sea, the results of Mahner's analysis of its waters are given. The salinity varied between 56.814 and 6.236, and the proportion between the chlorine, sulphuric acid, lime, and magnesia, is 100 : 44.91 : 9.34 : 21.43, which differs extremely from the normal proportion. Thus the Caspian Sea, if it ever had any connection with the Black Sea, must have entirely changed its character since that time—a change which might be occasioned by the different salts which the rivers brought into it, and which accumulated there by evaporation of the water; or which might be caused by the deposition of different salts in the basin of the Caspian Sea itself. (7.) The Atlantic between 30° S. lat. and a line from Cape Horn to the Cape of Good Hope, is less saline than the corresponding region north of the equator;

and all the samples from the western part of this region have less, while the samples from the eastern part, nearer to the African coast, have considerably more sulphuric acid than the normal quantity. Does this, asks Forchhammer, depend upon the more volcanic nature of the west coast of Africa than the east American coast? (8.) In the sea between Africa and the East India Islands, the mean salinity is 33.868. The minimum (25.879) is from a place high up in the Bay of Bengal, and of course much influenced by the Ganges. It lies, however, about 300 miles from the mouth of that river; and another specimen taken 60 miles nearer the mouth has a salinity of 32.365, so that it would seem as if some other cause (possibly fresh-water springs at the bottom) had been in operation to weaken the seawater at the minimum spot. (9.) In the Patagonian cold-water current, the mean salinity was 33.966; while three samples brought from the South Polar Sea, by the late Sir James Ross, had different salinities of 28.565, 15.598, and 37.513. Forchhammer cannot account for these discrepancies. All the specimens shewed a great excess of sulphuric acid (12.47 in place of 11.88, as compared with 100 of chlorine), a result probably due to the volcanic nature of the antarctic continent. Forchhammer's analyses of waters from other of his 17 districts call for no remark; and the following are the general results of his investigations. 'If we except the North Sea, the Kattegat, Sound, and Baltic, the Mediterranean and Black Sea, the Caribbean Sea and the Red Sea, which have all the characters of bays of the great ocean, the mean numbers are the following:

Sea-water.	Chlorine.	Sulphuric Acid.	Lime.	Magnesia.	All Salts.	Coefficient.
1000	18.999	2.268	0.556	2.096	84.404	1.812
	100	11.88	2.93	11.03		
Equivalents,	480	45	16	82		

Thus it is evident that the sea-water, in its totality, is as little a chemical compound as the atmospheric air; that it is composed of solutions of different chemical compounds; that it is neutral, because it everywhere in the atmosphere finds carbonic acid to neutralise its bases, and everywhere on its bottom and shores finds carbonate of lime to neutralise any prevailing strong acid; that lastly, the great stability of its composition depends upon its enormous mass, and its constant motion, which occasions that any local variation is evanescent compared to the whole quantity of salt.' It will be seen that the Atlantic is that part of the ocean which contains the greatest proportion of salt, while some of the bays in the tropical or subtropical zone (the Mediterranean and Red Sea, for example) have a greater mean than the Atlantic; that on approaching the shores, the sea-water, as might have been expected, becomes more diluted, and consequently less saline; that the polar currents contain less salt than the equatorial; that the polar current of West Greenland contains more sulphuric acid than the water in any other region except the East Greenland and south polar currents (while in the ocean at large, the chlorine is to the sulphuric acid as 100 : 11.89; in the south polar current it is as 100 : 12.55). As in the case of the West Greenland current, there is no neighbouring volcanic region to account for this excess, Forchhammer suggests that the absence of fucoidal plants, which have a great attraction for sulphuric acid, may have an influence in bringing about this result; that

most lime occurs in the ocean in the second region, the middle part of the Northern Atlantic; and the least in the West Greenland polar current (the quantities being 3.07 and 2.77 respectively). Wherever, in other regions, the influence of land prevails, the lime also is in excess; thus, in the Black Sea, it was 4.221.

From these remarks on the *surface-water*, we pass on briefly to notice the difference of sea-water in *different depths*. On this subject, the result obtained from the analyses of specimens of sea-water taken from different regions, is so contradictory, that we shall simply quote the sentence with which Forchhammer commences this department of his subject: 'It would be natural to suppose that the quantity of salts in sea-water would increase with the depth, as it seems quite reasonable that the specific gravity of sea-water would cause such an arrangement. But this difference in specific gravity, relative to the increase in the quantity of salts, is counteracted by the decreasing temperature from the surface to the bottom. We have parts of the sea where the quantity of solid salts increases with the depth; in other parts, it decreases with the increasing depth; in other places, hardly any differences can be found between surface and depth; and lastly, I have found one instance where water of a certain depth contained more salt than both above and below.

sulphides and to sulphuretted hydrogen, which, with the oxide of the iron of the plant, which is partly dissolved and partly suspended, will form sulphide of iron. Thus, the sulphur will disappear from the water. He suggests that the diminution of sulphuric acid which he found in the Atlantic, between the equator and 30° N. lat. (11.75 in place of 11.89), may be due to the action of the Sargasso Sea.

\* In a paper read before the British Association in 1844, Forchhammer shewed that the fucus tribe has a great attraction for sulphuric acid, and that the acid, when the plant undergoes putrefaction, is reduced to soluble

These differences are, to a great extent, dependent upon currents both on the surface and in different depths.—*Op. cit.*, p. 229. Sometimes, salinity of the surface-water is the same as that of the deep: or one or more ingredients may vary in its proportions: for example, in the Mediterranean, while the deep water, generally, is richer than the surface-water in sulphuric acid, in some parts, as between Sardinia and Naples, the surface-water is the richer in that ingredient. There are few observations on the specific gravity of the sea-water at different depths. For the following observations, we are indebted to Sir James Ross. 'At 39° 16' S. lat., 177° 2' W. long., the specific gravity of the surface-water was 1.0274; at 150 fathoms, 1.0272; and at 450 fathoms, 1.0268: all tried at the temperature of 60° F., and shewing that the water beneath was specifically lighter than that of the surface, when brought to the same temperature: our almost daily experience confirmed these results.'—*Voyage, &c.* vol. ii. p. 133.

The important questions—How did the salts which now occur in the sea come into it? Is it the land that forms the sea, or is it the sea that makes the land? Are the salts that are now found in sea-water washed out of the land by the atmospheric water? Has the sea existed from the beginning of the earth? And has it slowly but continually given its elements to form the land? and their answers, constitute the last part of Forchhammer's most philosophical and laborious Memoir. The following is, in a condensed form, his reply to these questions. Suppose a river had its outlet in a valley, with no communication with the sea; the valley would be filled with water till its surface was so great that the annual evaporation was equal to the annual supply. There would then be a physical, but not a chemical equilibrium, because the annual loss would consist of pure water, while the received water would contain various mineral or saline matters, which would go on increasing till chemical changes would occasion precipitation of different salts. Now, in the water of the assumed river, we should find the bases prevailing in the following order—lime, magnesia, soda, iron, manganese, and potash; while the acids, similarly arranged, were carbonic, sulphuric, muriatic (chlorine), and silicic. Now, all these substances are found in sea-water, although in very different proportions. The ocean is, in point of fact, such a lake as we have here supposed, with all the rivers carrying their dissolved matters into it. 'Why, then,' our author asks, 'do we not observe a greater influence of the rivers? Why does not lime, the prevailing base of river-water, occur in a greater proportion in the water of the ocean? In all river-water, the number of equivalents of sulphuric acid is much smaller than that of lime, and yet we find in sea-water about three equivalents of sulphuric acid to one of lime. There must thus be in sea-water a constantly acting cause that deprives it again of the lime which the rivers furnish, and we find it in the shell-fishes, the corals, the bryozoa, and all the other animals which deposit carbonate of lime.' These animals not only deprive the water of its carbonate of lime, but they likewise decompose the sulphate of lime—a decomposition probably depending upon the carbonate of ammonia formed by the vital processes of these animals. The silica, which is always present in river-water, is appropriated by the varied sponges, diatoms, &c., and hence its scantiness in sea-water. With regard to the sulphuric acid conveyed into the sea, a small part enters into the composition of shells, corals, &c., and a greater part is attracted by sea-weeds, in which it undergoes reduction, as already described, while the balance remains in the sea-water. The

magnesia of the river-water enters in small quantity into marine shells and corals, but only a small quantity is thus abstracted from sea-water, while the soda and muriatic acid, or chlorine, form, as far as we know, by the pure chemical, or organo-chemical action that takes place in the sea, no insoluble compound. 'Thus,' he concludes, 'the quantity of the different elements in sea-water is not proportional to the quantity of elements which river-water pours into the sea, but inversely to the facility with which the elements in sea-water are made insoluble by general chemical or organo-chemical actions in the sea; and we may infer that the chemical composition of the water of the ocean in a great part is owing to the influence general and organo-chemical decomposition has upon it, whatever may have been the composition of the primitive ocean.'

**WATER-BED**, called also the **HYDROSTATIC BED**, or **FLOATING MATTRESS**. It is well known that the life and health of every part of the animal body depend on the sufficient circulation through them of refreshed blood. See **CIRCULATION**. Now, when a person in health is sitting or lying, the parts of the flesh compressed by the weight of the body do not receive the blood so copiously as at other times; and if from any cause the action of the heart has become weak, the interruption will follow both more quickly and be more complete. A peculiar uneasiness soon arises where the circulation is thus obstructed, impelling to change of position; and the change is made as regularly and with as little reflection as the winking of the eyes to wipe and moisten the eyeballs. A person weakened by disease, however, while generally feeling the uneasiness sooner, as explained above, and becoming restless, makes the changes with increasing fatigue; and should the sensations become indistinct, as in the delirium of fever, in palsy, &c., or should the patient have become too weak to obey the sensation, the compressed parts are kept so long without their natural supply of blood, that they lose their vitality, and become what are called *aloungs* or *mortified parts*. These, if the patient survives, have afterwards to be thrown off by the process of ulceration, leaving deep hollows to be filled up by new flesh during a tedious convalescence. Many a fever or other disease, after a favourable crisis, has terminated fatally from this occurrence of sloughing on the back or sacrum. The same termination is common in lingering consumptions, palsies, spine diseases, &c., and generally in diseases that confine the patient long to bed.

It was to mitigate all, and entirely to prevent most of the evils attendant on the necessity of remaining long in a recumbent posture, that the hydrostatic bed was devised by Dr Neil Arnott, late one of the Queen's physicians. The bed may be shortly described as a mattress floating on water, with a loose sheet of caoutchouc cloth properly secured between it and the water, to prevent its being wetted. A person rests on it as a waterfowl does on its bulky feathers, with as little inequality of local pressure as if in a bath. A trough of the dimensions of a wide sofa or a bed, having six or seven inches depth of water in it, with the required caoutchouc covering, is the foundation, on which clothes and pillows are laid as in a common bed. A full description is given in Dr Arnott's book, the *Elements of Physics* (6th edition, Longman & Co.). The bed not only prevents the occurrence of bed-sores, but by lessening antecedent distress, lessens also the danger of the illness.

On a sudden emergency, or when the need of the fluid support is not very urgent, local relief may be given by forming in any way a partial hollow or

## WATERBRASH—WATER-DROPWORT.

depression in a bed, and placing in it a water-sack or bag half-filled, so as to remain loose or slack. This approaches in effect the slack-sided cushion, which is another modification of the invention.

**WATERBRASH.** See PYROSIS.

**WATER-BUDGET**, a heraldic bearing in the form of a yoke with two pouches of leather appended to it, originally intended to represent the bags used by the Crusaders to convey water across the desert, which were slung on a pole, and carried across the shoulders. The Trusbuts, Barons of Wartre in Holderness, bore *Trois bouts d'eau*, three water-budgets, symbolising at once their family name and baronial estate; and by the marriage of the heiress, similar arms came to be assumed by the family of De Ros, who bear gules, three water-budgets argent.

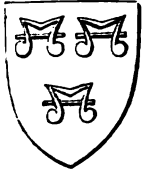

Water-budgets.

the heiress, similar arms came to be assumed by the family of De Ros, who bear gules, three water-budgets argent.

**WATER-BUG**, the popular name of a tribe or section of Heteropterous insects, *Hydrocorisæ*, which live almost entirely in water, and feed upon other aquatic insects. The anterior portion of the first pair of wings is horny; the antennæ are very small, and concealed beneath the eyes. The *Hydrocorisæ* are divided into two families, *Notonectidæ*, and *Nepidæ*. Of the former, the Boat-fly (q. v.) is an example. The *Nepidæ* are popularly known as **WATER SCORPIONS**, from the form of their fore-legs, which are efficient instruments for seizing their prey. Some of the *Nepidæ* are powerful insects, two or three inches long.



Water Scorpion.

of their fore-legs, which are efficient instruments for seizing their prey. Some of the *Nepidæ* are powerful insects, two or three inches long.

**WATERBURY**, a township and city of New Haven county, Connecticut, U. S., 33 miles south-west of Hartford, on the left bank of the Naugatuck River, at its confluence with Great Brook and Mad River, whose falls furnish abundant water-power. It is a well-built town, with a fine park and ornamental cemetery, 7 churches, 2 banks, and 30 large manufactories of rolled copper, brass, German-silver, plated ware, pins, hooks and eyes, buttons, lamps, clocks, percussion-caps, &c. It has been built up by small mechanics, and is the head-quarters of the brass business in the United States. Pop. in 1870, 10,826.

**WATER CALTROP.** See TRAPA.

**WATER CHESTNUT** (*Marron d'Eau*), the name given in France to the edible seeds of the *Trapa natans* (see TRAPA).—The name Water Chestnut is also given to the edible tubers of the *Scirpus tuberosus*, a plant of the natural order *Cyperaceæ* (see BULRUSH and CYPERACEÆ), which is cultivated by the Chinese in tanks very abundantly supplied with manure. It is destitute of leaves, except a slender short sheath or two at the base of each culm. It is stoloniferous, and the tubers are produced on the stolons. They are in high estimation among the Chinese, both for food and as a medicine, and are eaten either raw or boiled. They are called *Pi-tai* or *Maa-tai*.

**WATER-COLOURS** are painters' colours mixed with water and some adhesive material, as gum or size instead of oil. Those intended for drawings on paper are prepared with great care, and are usually formed into dry cakes with gum. Those for colouring walls and scene-painting are roughly prepared

with glue or size. These are often called Distemper Colours, from the Italian term *tempera*, applied to them to express their application to temporary purposes.

**WATER-CRESS.** See CRESS.

**WATER-DOG**, a kind of dog, of which the Poodle (q. v.) is regarded as a sub-variety. The head is rather large and round, the ears long, the legs rather short, the general form compact, the hair everywhere long and curly. The Water-dog of England, common before the poodle had been introduced from the continent, is still much esteemed



Water Spaniel.

by professional wild-fowl shooters, and by the fishermen of the north-eastern counties. It is about 18 or 20 inches high at the shoulder. The hair is coarser and crisper than that of the poodle. This dog was formerly sometimes used in London for the brutal sport of hunting and worrying domestic ducks, placed in a pond for the purpose. It is an intelligent and affectionate kind of dog, although not of much beauty.

**WATER-DROPWORT** (*Enanthe*), a genus of plants of the natural order *Umbelliferae*; having ovato-cylindrical fruit, not prickly nor beaked, each carpel



Water-dropwort (*Enanthe crocata*).

with five blunt convex ribs, and single vittæ in the interstices; the calyx teeth lanceolate; the petals obcordate and radiant, with an inflected point; the

partial involucre of many rays; the flowers of the circumference on long stalks and sterile, those of the centre subsessile and fertile. A number of species are natives of Britain, large perennial plants, with a strong and generally disagreeable aromatic smell, and compound or decomposed leaves. The COMMON W. (*C. fistulosa*) and the HEMLOCK W., or WATER HEMLOCK (*C. crocata*), are both common in wet places in Britain and throughout Europe, and both are narcotic acrid poisons. The roots of the latter have some resemblance to small parsnips, and hence fatal accidents have frequently occurred.—The FINE-LEAVED W., called Water Fennel by the Germans (*C. phellandrium*, formerly known as *Phellandrium aquaticum*), is also common in ditches and ponds both in Britain and on the continent. It has a jointed root-stalk (*rhizome*), with tufted whorled fibres, and a strong zigzag stem dilated at the base. The leaves are decomposed. The fruit has a peculiar aromatic but disagreeable smell. It is not so poisonous as the other species just named. It was at one time erroneously regarded as a specific against pulmonary consumption; but it has been advantageously employed in pulmonary complaints.

**WATERKEE**, a river of the U. S., formed by the junction of the Catawba and Fishing Creek in North Carolina, runs south-east into South Carolina, where it unites with the Congaru to form the Santee. Steamboats ascend the W. to Camden, 200 miles from the sea.

**WATERFALL** is a break in the continuity of slope of the channel of a river or stream, so abrupt that the body of water falls from the higher to the lower level. Waterfalls occur most frequently in mountainous countries, where the streams from the mountain sides enter the valleys. It is only when the side of the valley is composed of hard rock that there can be a waterfall; in friable strata the stream wears out a ravine or side-valley. These mountain waterfalls, however, are generally rather curious and picturesque than grand, the volume of water being in most cases comparatively insignificant, though the height of fall is occasionally very great. All mountain waterfalls necessarily change their aspect from season to season—in winter, a roaring torrent plunging headlong into the abyss; in summer, often a mere film of water trickling down the face of the precipice. Waterfalls in comparatively level districts are not nearly so common, and their height of fall is insignificant compared with that of mountain cataracts; but the much greater volume of water, its steady and even flow to the head of the precipice over which, in solid column, it descends with a thundering plunge, place such waterfalls among the grandest of nature's phenomena. It is where the course of a large river passes from a higher to a lower plateau, and where the upper plateau is edged with rock, that the grander cataracts are formed. If the rocks are of the same hardness from top to bottom, the edge of the escarpment, supposing it to be perpendicular at first, becomes worn off, and a slope or *rapid* is formed. But when the upper edge is hard and the under strata soft and friable, the reverberation of the spray wears away the softer parts below, leaving a projecting ledge at the top, which breaks off, piece by piece, as it becomes too much undermined, so that the fall is constantly receding. The question of the rate of regression of waterfalls has not hitherto occupied much attention, and has only been estimated in the case of Niagara, Bakewell giving its annual value at 1 yard, while Lyell limits it to about a third of this. Some of the most remarkable waterfalls of the world are the Yosemite, California, in a valley (see SUPP., Vol. X.) of the

same name; a fall 2550 feet in entire height, but broken into three leaps; the Orco Falls at Monte Rosa, 2400 feet; Gavarnie (Pyrenees), 1400 feet; Staubbach (Switzerland), 1000 feet; Maanalvan (Norway), 940 feet; Niagara (q. v.); Zambesi (q. v.); Missouri. The cataracts of the Velino and Anio, in Italy, are beautiful artificial imitations of this most striking of natural phenomena.

**WATER FLEA** (*Daphnia*), a genus of *Entomostraca*, of the order *Cladocera*, and family *Daphniadae*. One species, *D. monoculus*, is abundant in pools and ditches in Britain. It comes to the surface in the mornings and evenings, but keeps near the bottom during the heat of the day. It swims by taking short springs, whence its popular name. It feeds on minute particles both of animal and vegetable substances. It is a beautiful object for the microscope; the whole interior organisation being visible through the transparent carapace. The male is much smaller than the female, and comparatively rare. The eggs, after leaving the ovary, are retained in a cavity between the body and the carapace, until the young have attained almost their perfect form.

**WATERFORD**, a maritime county of the province of Munster, Ireland, is bounded on the N. by the counties of Tipperary and Kilkenny, on the E. by Wexford, on the S. by the Atlantic, and on the W. by the county of Cork. Its greatest length from east to west is 52 miles, and its breadth, north to south, 28; the total area being 721 sq. m., or 461,663 acres, of which 325,345 are arable, 105,496 waste, 23,468 in plantations, 526 in towns, and 5779 under water. The pop. in 1851 was 164,051; in 1861, 184,252; and in 1871, 123,310; of whom 116,839 were Roman Catholics, 5090 Protestant Episcopalians, and the rest Protestants of other denominations. The number of acres under crops of all kinds, in 1875, was 91,360, of which 12,995 were under wheat, 26,930 under oats, 16,219 under potatoes, 7823 under turnips, and 21,669 in meadow and clover. The live stock in 1875 consisted of 13,418 horses, 95,656 cattle, 60,720 sheep, and 49,215 pigs. The coast-line extends from the estuary of the Suir, Waterford Harbour, to that of the Blackwater at Youghal, and is partly flat, partly rocky, but in general very dangerous for shipping. The rocky district contains some remarkable caverns. The surface is in general mountainous; the principal ranges being Knockmeledun, the Cumeragh, Monevolagh, and Drum. The Cumeragh Mountains are the loftiest, and abound in wild and picturesque scenery. The Suir (q. v.) and the Blackwater (q. v.) are the chief rivers. There are no lakes worthy of note. The climate is moist, and the soil, over a considerable part of the county, is marshy; but the upland districts are well suited for tillage, and the lower pasture-lands, although inferior in fattening properties to those of the great central plain, produce excellent butter, which is exported in large quantities. In geological structure, the mountains present the old and new slate, separated by red and gray quartz rock and quartzose slate. Of quarry slate, there are two principal varieties, which are raised extensively for local use. The valleys belong to the limestone series, being an outlying prolongation of the great bed of the central plain. Lead, iron, and copper are found. The former two have proved unprofitable, but the copper-works at Bonmahon and Knockmahon have for many years been very productive. Marble of several colours and of considerable beauty is quarried near Cappoquin and Whitechurch, and potter's clay of good quality is found at Kildrum, near Dungarvan. The chief occupations of the population are pasturage and

## WATERFORD—WATER-LILY.

dairy-farming; but a considerable manufacture both of cotton and linen has been recently introduced at Portlaw, and the shipping-trade has of late years become active and profitable.

W. is divided into eight baronies. The most considerable towns besides Waterford City (q. v.) are Dungarvan, Carrick-beg—properly a suburb of Carrick-on-Suir, which is in Tipperary—Lismore, Cappoquin, Tallow, and Tramore. Clonmel, although chiefly in Tipperary, lies partly within this county. W. returns five members to parliament—two for the county, two for Waterford City, and one for the borough of Dungarvan. The county constituency in 1873—4 was 3464. The net annual value of property in W., under the Tenement Valuation Act, is £263,047. This district, in common with the adjoining county of Wexford, is believed to have been anciently peopled by a Belgic colony. The Danes also formed a settlement at the mouth of the Suir. From the date of the invasion, W. became a stronghold of the English, large grants having been made by Henry II. to the family of Le Poer; and in all the alternations of the subsequent struggle with the Irish population, it continued for the most part a firm centre of English influence. The county abounds with antiquities ecclesiastical and military, and of the Celtic and Danish, as well as the Anglo-Norman period.

WATERFORD, a city, capital of the county of the same name, but itself a county of a city, and a parliamentary borough, is situated in N. lat. 52° 16', W. long. 7° 8', on the river Suir, 12 miles from the sea, and 97 south-south-west from Dublin, with which city it is connected by the Great Southern and Western, and Waterford and Limerick Junction Railways, as also by the Waterford and Kilkenny Railway. The pop. in 1861 was 23,293, of whom 20,429 were Roman Catholics, and 1969 Episcopalians of the Protestant Church; and in 1871, 23,349, of whom 20,604 were Roman Catholics, 1861 Protestant Episcopalians, and the rest Protestants of other denominations. The city, with the exception of an inconsiderable suburb, with which it is connected by a bridge of 39 arches, 852 feet long, opening for the passage of ships, lies on the right bank of the Suir, along which a handsome and spacious quay extends for a distance of nearly a mile, and from which the city ascends gradually in well-built streets. Vessels of 2000 tons are now enabled to discharge their cargoes at the quay; but there is an anchorage for still larger ships about six miles lower down the river, at Passage. The chief public buildings are the Protestant and Roman Catholic cathedrals, the Protestant episcopal palace, the (Catholic) college of St John, the Model National School, and the city and county court-houses. In addition to the union workhouse, there is an infirmary, a dispensary, a fever hospital, a district lunatic asylum, and a penitentiary. The affairs of the municipality are administered by a mayor and corporation consisting of ten aldermen and thirty councillors; those of the port, by a body of commissioners, twenty-four in number, elected by the corporation and the Chamber of Commerce. The chief trade is with England, in the export of butter, pork, bacon, corn, flour, eggs, and live-stock. The annual value of property under the Valuation Act is £38,401. Steam-navigation has received a great impulse, and there is now a ship-building yard, with patent slip, graving-bank, and dock, on the Kilkenny bank of the river.

W. is originally of Danish foundation; but at the invasion, the city was taken by assault by Strongbow, by whom it was enlarged, and made a place of strength. It received a charter from John, which was forfeited under James I., but restored by

Charles I. in 1626. But few remains of its ancient buildings are now to be seen.

WATER-GLASS, the soluble silicates of potash or soda, or a mixture of both. It is usually prepared by boiling silica with caustic alkali under pressure, about 60 lbs. to the square inch, in a digester. When pure and solid, it has the appearance of common glass, and is slowly soluble in boiling-water. A solution of water-glass is used, mixed with sand, &c., to form artificial stone. It is also spread on the surface of stone to protect it from decay, as it sinks in and cements the particles together; and it enters into the composition of some kinds of cement. In the art of Stereochromy, or Fresco-painting (q. v.), water-glass is now much used. It has also become useful in certain dyeing processes, having in some cases been found to answer the purpose of danging.

WATER-HEN. See GALLINULE.

WATERLAND, DANIEL, D.D., a clergyman of the English Church, prominent in the theological controversies of the first half of the 18th century. He was born on the 17th February 1683, at Waseley in Lincolnshire, of which parish his father was the rector. After going through the usual course of study at Magdalen College, Cambridge, he was admitted into orders; and in 1713 he became rector of Ellingham, on the nomination of the Earl of Suffolk. It was shortly after this that he published his first book, *Advice to a Young Student, with a Method of Study for the first Four Years*—an unpretentious but useful work, which soon became very popular, and brought its author into notice. King George I. appointed him one of his chaplains in 1717. About this period he began to be engaged in theological controversy, one of his earliest works being a criticism of a book by Dr Whitby, in which a severe attack was made upon Bishop Bull's *Defence of the Nicene Creed*. Whitby answered him; W. rejoined; and in 1719 the latter expanded his writings upon this subject into his *Defence of Christ's Divinity*. This work was sharply criticised by Dr Clarke and other Arians; to whom W. replied in a work published in 1724. Upon the same subject he, in 1720, preached and published a series of sermons at the request of the Bishop of London. Within a few years after this he passed through a rapid course of promotion in the Church. In 1721 he was appointed rector of the parish of St Augustine in the City of London; in 1724 he got the Chancellorship of the Cathedral of York. He was appointed a canon of Windsor in 1727, and Archdeacon of Middlesex in 1728. He held along with the latter appointments the valuable living of Twickenham. During these years he was indefatigable in controversy; not only keeping up a paper war against the Arians, but entering the lists against free-thinkers, such as Middleton and Tindal, and against those of the Anglican body who did not share his doctrines upon the subject of the Trinity and the Eucharist. *A Critical History of the Athanasian Creed* (1724); *A Review of the Doctrine of the Eucharist* (1737); and *Scripture Vindicated* (1734), are considered among the most noteworthy of his productions. In 1738 were published two volumes of his sermons, edited by one of his friends—the one upon Justification, the other upon the Communion of Infants. W. died on the 23d December 1740. A complete edition of his works, accompanied by a pretty full Memoir of his life from the pen of Bishop Van Mildert, was published at Oxford in 1823, in ten volumes 8vo; an eleventh volume, containing a general index, was added in 1828.

WATER-LILY, a name commonly enough given to the different species of *Nymphaea* and *Nuphar*,



and also of *Nelumbium*, all genera of the natural order *Nymphaeaceae* (q. v.), and indeed often extended to all the plants of that order. Britain produces three species—*Nymphaea alba*, the White Water-lily; and *Nuphar luteum* and *Nuphar*



White Water-lily (*Nymphaea alba*).

*pumilum*, called Yellow Water-lilies. The two former are frequent in still waters in most parts of the island; *Nuphar pumilum* is more rare, and chiefly found in Scotland. All have heart-shaped leaves, floating on the water. The beautiful and fragrant white flowers of *Nymphaea alba* float upon the water; the flowers of the yellow water-lily, which are of comparatively little beauty, are raised by their stalks a little above it. The seeds of these, as well as of the Water-lily of the Nile (*Nymphaea lotus*—see LOTUS), are farinaceous, and are sometimes used for food. The Turks prepare a cooling drink from the stems of *Nuphar luteum*.—The SWEET-SCENTED WATER-LILY of North America, *Nymphaea odorata*, has a large white flower of great beauty, and of very sweet smell. Not only *Nymphaea lotus*, but also *N. rubra* and *N. pubescens*, are regarded as sacred plants by the Hindus. *N. caerulea* was also held sacred by the ancient Egyptians.

**WATERLOO', BATTLE OF**, the decisive conflict which annihilated the power of Napoleon I., was fought, 18th June 1815, in a plain about 2 miles from the village of W., and 12 miles south from Brussels. Agreeably to the unanimous resolve of the Allies to attack Napoleon on all sides, and crush him as they had done in 1814, British and Prussian troops were stationed in the Netherlands, under the command of Wellington and Blücher respectively, in order to attack France on the north. Napoleon, on his side, well aware that for a considerable time no weighty attack could be made on France except by these forces, and fully recognising the immense advantage to be gained by destroying one enemy before the others could come up, rapidly concentrated the bulk of his troops; and with a suddenness and secrecy which defied all effective counter-preparations, crossed the Belgian frontier, and fell with one part of his forces on the Prussians at Ligny (q. v.), and with the other part, under Ney's immediate command, on the army of the Prince of Orange at Quatre-Bras (q. v.). The Prussians—as Wellington, after learning Blücher's dispositions for the battle, had foretold—were, after a contest of the most obstinate description, completely defeated; but the Prince of Orange, by the aid of the reinforcements promptly forwarded to him by the English commander, succeeded in withstanding Ney's

attack. In the plan preconceived by the Allied generals such a result was not unforeseen, and in accordance with their scheme of firm resistance and retreat if necessary (to allow time for the Russians and Austrians to assemble on the eastern frontier of France), Blücher retreated northwards (instead of eastwards, as Napoleon expected) nearer the place of rendezvous with Wellington at Mont St Jean; while early on the morning of the 17th, the Anglo-Netherlanders retired along an almost parallel route till they reached the forest of Soignies, in front of which they were formed in battle-array, facing southwards. Napoleon, imagining that the Prussians were in total rout, and that their complete dissipation would easily be accomplished by Grouchy's division (33,000 men), which he had sent in pursuit, crossed to Quatre-Bras with the rest of his troops, and uniting with Ney, marched in pursuit of Wellington, arriving on the plain of W. in the evening.

The two armies which then confronted each other, though nearly equal in strength, were composed of very different materials. The French army, numbering from 69,909 to 72,247 men (according to French authorities, English historians varying in their estimate from 74,000 to 90,000, though its exact strength cannot be ascertained, owing to the loss of the official returns), was composed of veteran troops, who had enthusiastically ranked themselves once more under the standard of the chief who had so often led them to victory. The Anglo-Netherlanders army, which numbered 69,894, of whom only 25,389 were British, 6793 of the king's German legion, 10,995 Hanoverians, 6303 Brunswickers, 2926 Nassauers, and 17,488 Netherlanders, consisted, with the exception of a small number of Peninsular veterans, wholly of young soldiers, a large proportion of whom had never been under fire; the Hanoverians were only militia, some of them being fit but for garrison-duty; while the behaviour of many of the Belgian troops during the battle shewed plainly enough that they mainly increased the numerical strength of the army, as they left it to the Dutch soldiers to vindicate the wrongs of the Netherlands. The French had 240, while their opponents had only about 156 guns. With such an army, to maintain even a defensive conflict with an army of veterans, commanded by the greatest general of the time, was a task which (labouring under a mistake as to the exact superiority in number of his opponents) it required all Wellington's rare tenacity of purpose to undertake; yet undertake it he did, depending on Blücher's promise to join him an hour after mid-day.

On the morning of the 18th, the two armies found themselves ranged in battle-array opposite each other: the Allies, posted on a line of eminences, had their left wing resting on Frischermont, the farm-house of La Haye Sainte in front of their centre, while their right wing curved convexly round behind Hougomont, and rested on Braine Merbes. The French were ranged on a parallel row of eminences, having La Belle Alliance in their centre, with some divisions of cavalry and infantry in reserve behind the right wing; Kellermann's dragoons behind the left wing; and the Guard, stationed with the 6th corps, in the rear. Skirmishing had continued all the morning; but the first serious attack was not made till between eleven and twelve, when a part of the 1st corps advanced against Hougomont, with the view of masking the more important attack to be made against the allied left. This preliminary assault, however, though unsuccessful, was maintained with great vigour for a considerable time; till Napoleon, dreading a further loss of time, prepared to make

## WATERLOO.

his grand attack on the left centre. At this time (half-past one P.M.), he learned that the advanced guard of the 4th Prussian corps (Bulow's) was appearing in front of St Lambert, 2-3 miles to his right; and being forced to detach his 6th corps (Lobau's) with the reserves of cavalry behind his right wing, to keep them in check, he had to modify his grand plan of attack on the Anglo-Netherlanders, and accordingly ordered Ney to break through their centre. At two P.M., after a furious preliminary cannonade, from which Wellington sheltered his men (as at various other times during the battle), by retiring them to the reverse of the slope, Ney advanced against the left centre with 20,000 men, but had only succeeded in putting to flight a Belgian brigade, when he was attacked and driven back by Picton's division, his retreating columns charged and broken by the English cavalry, and 2000 prisoners taken. Nevertheless, after a brief space, Ney returned to the charge, and carried La Haye Sainte, though his repeated attacks on the infantry in position were constantly repulsed, and his retreating columns severely handled by the British cavalry, who, disordered by success, were as often overthrown by the French cuirassiers. By this time (half-past four P.M.), Bulow had succeeded in deploying from the woods, and, advancing against Planchenoit, in the rear of the French right, carried it after a vigorous conflict. Lobau's corps, however, aided by a reinforcement from the Guard, speedily retook the post, and driving the Prussians back into the wood, secured the French right flank for a time; Napoleon, though now learning that another Prussian corps (the 1st, under Ziethen) was coming up by Ohain to join the Allied left, being still confident that he could destroy the Anglo-Netherlanders before the Prussians could render effective aid. During the conflict with Bulow, Ney had been warmly engaged with the centre and right of the enemy, who had made various attempts to regain the wood of Hougomont and La Haye Sainte, and had supported his repeated attacks 'with not only his own cavalry, but (by, at any rate, the 'tacit consent' of the emperor) with the cuirassiers, lancers, and chasseurs of the Guard, and the whole of the mounted reserve, without, however, producing any result other than a great slaughter on both sides, and the useless sacrifice of 18,000 of the finest cavalry ever seen. Napoleon now resolved on another vehement assault on the immovable British centre, and directed against it in succession two columns, one composed of four battalions of the Middle Guard, and the other of four battalions of the Middle and two of the Old Guard, supporting them with flank attacks of other infantry divisions, of cavalry, and with a dreadful fire of artillery. The advancing French were met with a well-sustained fire from every piece which could be brought to bear upon them; the first attacking column was fairly driven down the slope by the English Guards, and the second was totally routed by a bayonet-charge of Adam's brigade, the British cavalry following up the fugitives. Ziethen had now (7 P.M.) joined the left of the English line; Bulow, further reinforced, had carried Planchenoit, and was driving the French right wing before him; and the combined attack on the retiring masses of the French by the whole effective force of the Anglo-Netherlanders on the one side, and of the Prussian cavalry on the other, converted an ordinary, though severe defeat into a rout unparalleled in history. The magnificent cavalry, wantonly destroyed by Ney in fruitless attacks upon an 'impracticable' infantry, would then have been of incalculable service, but they were no longer to be had. The last square of the Guard still stood

its ground, to protect the flight of the Emperor; but it was speedily surrounded, and on the soldier-like refusal of Cambronne to surrender, was in a moment pierced through, and broken to pieces. From this time all resistance was over; the roads southwards, especially that to Genappes, were crowded with fugitives fleeing for their lives from the pursuing cavalry; and though the English light cavalry, exhausted with their severe work during the battle, soon ceased the pursuit, it was kept up with great energy throughout the whole night by the Prussian troopers, who seemed bent upon at once avenging the defeats of Jena, Auerstadt, and Ligny, and glutted their fierce animosity by an indiscriminate slaughter. The total loss in this battle was, from the obstinacy and determination with which it was contested, necessarily large; the figures are: British and Hanoverians, 11,678; Brunswickers, 687; Nassauers, 643; Netherlanders, 3178; a total of 16,186; which, added to 6999 Prussians, gives the aggregate allied loss, 23,185. The French had 18,500 killed and wounded; 7800 prisoners (some French accounts raise the total list of *hors de combat* to 32,000), and 227 cannon captured.

This great battle has given rise to numerous controversies among the British, French, and German historians of the great struggle between Europe and Napoleon—the points in dispute being, (1) as usual, the numbers engaged on each side, (2) the ability shewn by each general in his dispositions for the conflict, and (3) the relative share of the British and Prussians in producing the final result. These questions can be briefly and satisfactorily answered. The strength of the English army is known from official estimates; the French army, as shewn by its manoeuvres throughout the day, was more numerous, and though its amount cannot, with perfect accuracy, be ascertained, it was certainly over 70,000, and under 80,000; but the fact that many Belgians in the Duke's army took to their heels as soon as the French marched towards them, and fled direct to Brussels, increased the disproportion, already sufficiently great, between the two armies; the Prussians had only 35,000 men under fire at W., and half of these only for about half an hour. Fault has been found with Wellington for giving battle in front of a wood, but the accusation is foolish, as several good roads traversed the wood, thus affording means of retreat, if necessary, and the wood could have been held by skirmishers to protect the retreating infantry. Napoleon's faults were chiefly—the late hour at which he (not calculating on the arrival of the Prussians at all, and certainly not without Grouchy) commenced the conflict, and the reckless manner in which his cavalry reserves were wasted; and his neglecting to take into account the steadiness—a steadiness new to one of even his experience—with which, as he was warned by Soult, who knew it only too well, the British infantry were wont to maintain their ground. As to the third point, there is no doubt that Bulow's attack on Planchenoit distracted Napoleon's attention, and drew off 10,000 of his forces; but though the Prussians had not come up, the battle could not have been otherwise than a drawn battle; however, the effect of their successful attack on the French right, by taking in flank also the squadrons which recoiled before the invincible steadiness of the British, was the conversion of an otherwise drawn battle into a glorious victory. Each of the three nations claims its right to give name to this famous conflict—the French calling it after Mont St Jean, a chateau in rear of the British line; the Prussians after La Belle Alliance; while the true victors on the bloody field assert their

rightful claim, and will hand it down to all future ages as the *Battle of Waterloo*.

**WATER-MARK**, the manufacturer's mark on various kinds of paper. See **PAPER**.

**WATER MELON**. See **MELON**.

**WATER OUSEL**. See **DIFFER**.

**WATER-POWER**. The value of water-power depends much on the nature of the source of supply, whether steady or otherwise. Where streams supplying water-power are liable to fall off much in dry weather, large impounding reservoirs are necessary to keep the mills from being stopped during summer. These, however, being generally expensive concerns, are seldom made for one mill, but rather by some association of mill-owners; and often by a water-company or commission for supplying a town with water, to afford compensation to the mills by storing up flood-water, for what is abstracted for the use of the town. On small streams, there is generally a pond provided fit to hold a night's water, or, perhaps, even a Sunday's, in addition; but in the case of large rivers, there is, in general, only a weir or dam across the river to direct the water into the intake lade. When the inclination in the bed of the stream is small, the lades require to be proportionally long, to give sufficient fall, and are often above a mile long or more from the intake to the lower end of the tail or discharge lade, where the water is returned to the stream. The rise and fall of the tide has been frequently used for driving water-wheels.

The most usual, and generally the most eligible, mode of applying water to the driving of machinery is by means of a vertical wheel; and the wheel is put in motion either by the water acting on blades or floats by impulse derived from its velocity acquired in falling, or by the weight of water being applied to one side of the wheel. The former mode of applying the water is generally adopted in low falls, say under six feet or thereabout, and to what is called an undershot wheel—i. e., a wheel where the effective head of water is below the level of the centre; and to make the application efficient, that portion of the periphery of the wheel measuring from the point of impact of the water to a point directly below the centre, requires to be surrounded by a casing generally of stone, but sometimes of cast-iron, called the arc, closely fitted to the extremity of the floats, so as to prevent any considerable escape of water.

The wheel, which may be either of timber or of

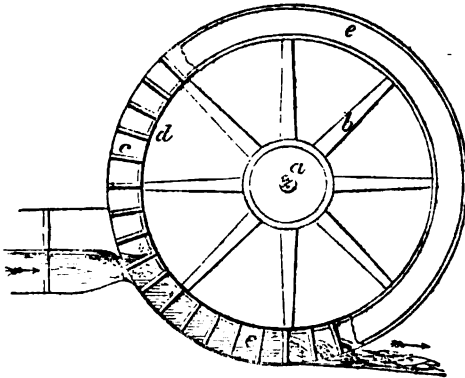

Fig. 1.

cast-iron, or partly of both, consists (fig. 1) of axle, a; arms, b; floats, which are generally radii of the

circle, but are sometimes set a little obliquely to the radius, pointing up stream, c; and generally there are also a sole, d, being a lining round the circumference at the lower edge of the floats, having openings for the escape of air; and a shrouding or circular plate, e, at each side of the wheel, and of the same depth as the floats.

Sometimes, when there is very little fall beyond the mere current of the stream, the floats simply dip into the water like the paddles of a steamer, in which case, no sole or shrouding is required; and to make allowance for the rise of the water in the tail-lade during floods, which is generally called *back-water*, and seriously impedes and sometimes stops the motion of the wheel, occasionally the wheel and its arc are so constructed as to be capable of being raised or depressed together, without throwing the machinery out of gear. This is done in the case of the Inverness water-works, where the wheel is liable to be much affected by the rising and falling of the river Ness.

Sometimes, in this country, and often on the continent, the machinery is all on board a vessel moored in a river, so as to rise and fall with the level of the water, and thereby keep its water-wheel always immersed to the proper depth. At the old London Bridge water-works, the wheels which rose and fell with the tide were worked by the current of both the flood and ebb.

The other mode of applying the water to a vertical wheel by making it act by its gravity, is the more perfect and economical mode, where circumstances will admit of it, and is generally adopted in falls of any considerable height, say of six feet and upwards, and where the water can be let on above the level of the centre. The wheels are called respectively *breast* and *overshot wheels*, according as the water is let on more near to the level of the centre or to the crown of the wheel; and they have, instead of straight floats, curved or kneed buckets, according as they may be made of iron-plate or of wood, and of such a shape as to retain the water down to the lowest possible point. There are generally in good wheels

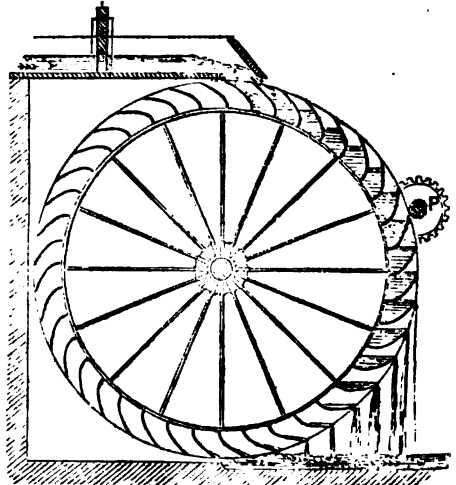

Fig. 2.

ventilating openings in the sole for the escape of air. The overshot wheel has this disadvantage that, as the water has little or no power until considerably past the top centre, the wheel is burdened with a useless weight of water.

The direct overshot wheel has the water run,

without changing its direction, right over the top, as in fig. 2; which arrangement has this advantage that, as the top of the wheel moves in the same direction as the stream, it gets the benefit of the whole initial velocity and impulse of the water; but, on the other hand, the bottom of the wheel, if at all immersed in water, which it generally is to some extent, meets with obstruction by moving against the current.

The *pitch-back overshot* is a modification of the last, making the water to pass alongside the wheel, and then to return and be let on to the top of the wheel in a contrary direction, as in fig. 3. This requires longer and more complicated troughs, and by the change in direction, part of the impulse from the water is lost, but the bottom of the wheel moves in the direction of the tail-water, and is not liable to be impeded by being immersed in it.

On the whole, it is generally thought better to apply the water at about 30 degrees from the top of the wheel. In such high-breast or nearly overshot wheels, the water is let on to the buckets over the top of the sluice, which is made to open by lowering, and shut by lifting, as in fig. 4. In this way, however small may be the quantity of water, it is always applied at the highest possible level, which is of importance when it is its weight multiplied by the height of descent, and not its impulse, that yields the effective power.

The structure of the overshot and breast wheel is nearly the same as that of the undershot, excepting in the substitution of curved buckets, as in figs. 2 and 4, or angular buckets, as in fig. 3, for straight

power is applied to a pinion P, working into segments either external, as in fig. 2, or internal, as in fig. 4, attached to the shrouding. In this arrange-

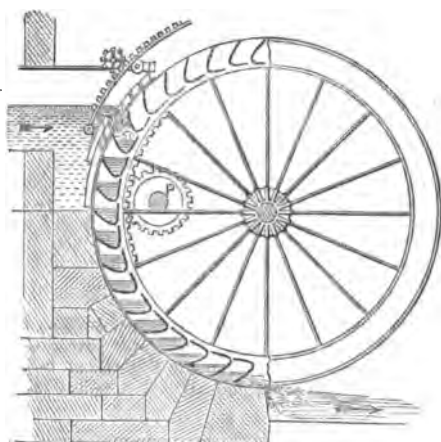

Fig. 4.

ment, there is no torsion of the axle, or transverse strain on the arms, and therefore the latter are more often made of round wrought-iron rods, with a slight axle. This wheel is much lighter than with the massive axle and the strong wooden or cast-iron arms, and is called a *suspension* or *spider wheel*.

In reckoning the power of water, its weight being 62½ lbs. to a cubic foot; theoretically, 528 feet, falling vertically 1 foot a minute, would be equal to 1 Boulton and Watt horse-power of 33,000 lbs. lifted 1 foot a minute; but the effective power is far short of that, and 60 per cent of it, requiring 880 cubic feet, falling 1 foot a minute, is generally reckoned a fair allowance for an effective horse-power. Seventy-five per cent., requiring 704 feet, falling 1 foot a minute, is about the highest that has ever been spoken of, and it is doubtful whether even more than 70 per cent. has ever been attained; while with low falls and imperfectly constructed wheels, it is often reckoned that a horse-power requires nearly 1000 cubic feet a minute.

The velocity of the periphery of an undershot wheel is usually from 500 to 600 feet a minute, and that of a bucket-wheel, overshot or breast, from 300 to 450 feet. It is seldom that the whole height of a fall can be advantageously made use of; for if the wheel be placed so low as to get the benefit of the whole height of the fall in low states of the water, very often it is liable in floods, to have the lower rim immersed, and to be obstructed or stopped by back-water.

The most extensive application of water-power to one work in Scotland, or probably in Britain, is that of Deanston Cotton Mills, on the river Teith, 6 miles above Stirling, where there are in one house four wheels, 36 feet in diameter, and 12 feet in breadth, and having a volume of water of 8½ millions of cubic feet in 10½ hours a day—falling 33 feet a minute. The most systematic application of water-power, however, is probably that of the Shaws Water-works, now the property of the corporation of Greenock. There the yield of nearly 7000 acres of hill-ground is stored up in reservoirs of a capacity of 320,000,000 of cubic feet, and conveyed by an aqueduct of about 6 miles in length to the outskirts of Greenock, which it reaches at the level of 512 feet above the level of the sea, and is then divided into two lines of falls, one having

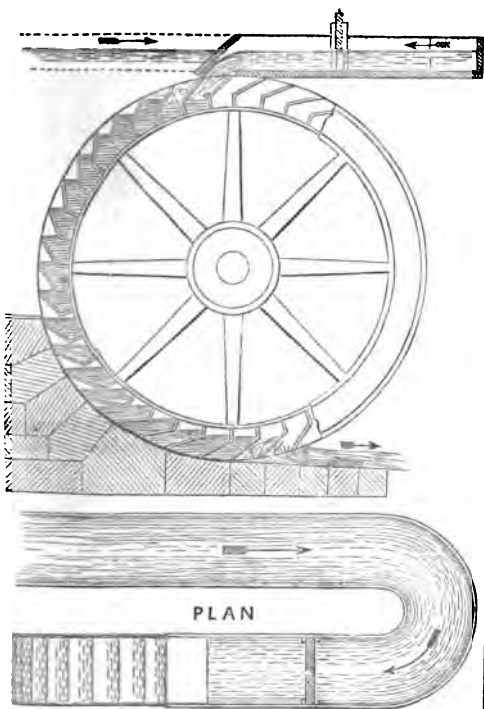

Fig. 3.

floats; but even in the undershot wheel the floats are sometimes made with a slight curvature.

In any description of wheel, the motion may be taken off the axle by torsion, which necessarily requires rigidity in the arms, as in figs. 1 and 3; or it may be taken directly off the periphery, when the

1200 cubic feet a minute for 12 hours a day, and the other the equivalent quantity of 1066 feet for 13½ hours a day, divided each into 19 falls, for which those already appropriated pay per annum from £1, 15s. to £4, 5s. per horse-power, according to their distance from the centre of the town, and their height above its level. One foot of fall for each line is reckoned 1·8 horse-power, which is a very high computation, being 79·2 per cent. of the theoretical horse-power. At the 'Cotton Mill,' where both lines of falls are combined, there is the largest, or nearly the largest water-wheel in existence. It is 70 feet 2 inches in diameter, 13 feet wide, with 166 buckets, having a depth of 17 inches. It has 2266 cubic feet of water per minute, with a fall of 64 feet 4 inches, and is therefore nearly 200 horse-power. By the Shaws computation, it would be 218 horse-power. It is a spider wheel, taking the power off the circumference.

Of horizontal wheels: In the proper turbine (from Ital. *turbino*, a whirlwind), the water passes either, first, vertically down through the wheel between fixed screw-blades, which give it a spiral motion,

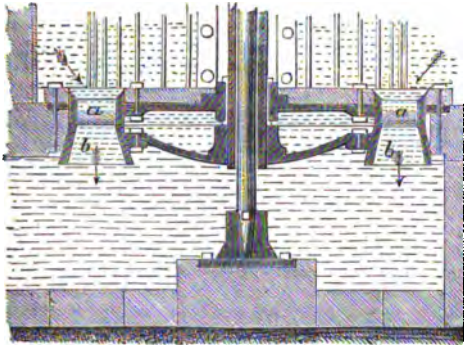

Fig. 5.

and then strikes similar blades attached to a movable spindle, but placed in the opposite direction, so that the impact of the water communicates a

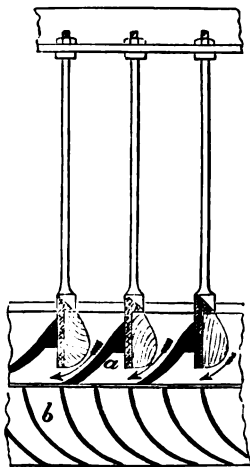

Fig. 6.

rotatory motion to the blades and spindle, as shewn in fig. 5, and in fig. 6 an enlargement of the parts, the fixed blades being marked *a, a*, and the movable

portion of the machine *bb*; or, second, a modification of the foregoing is to pass the water from the

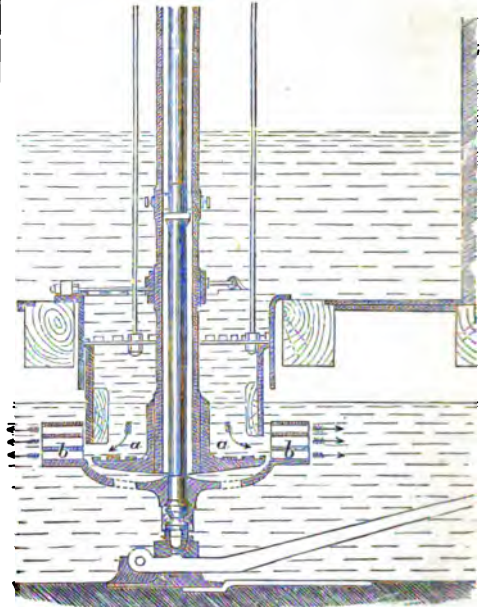

Fig. 7.

centre horizontally outwards through fixed curved blades, *a, a*, figs. 7 and 8, so as to give it a rotatory



Fig. 8.

or tangential motion, and thereby cause it to act on the blades of the wheel, *bb*, which revolves outside.

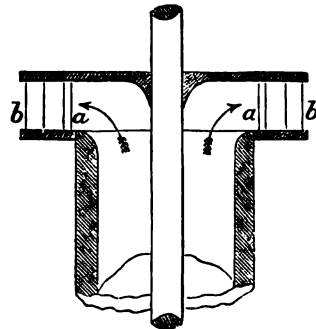

Fig. 9.

In the reactionary wheel, which is in principle almost identical with Whitelaw and Stirret's wheel,

## WATER-POWER.

previously described under the article **BARKER'S MILL**, the water is admitted at the centre of the wheel from below, passes to the circumference between curved blades of the wheel, and escapes by tangential orifices at the circumference, there being

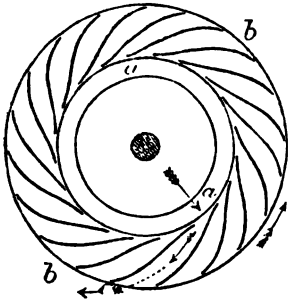

Fig. 10.

valves made to open more or less, according to the quantity of water and to the power required. This form of turbine is shewn in figs. 9 and 10, where the water enters at *aa*, and escapes by *bb*.

The vortex wheel of Professor Thomson (figs. 11

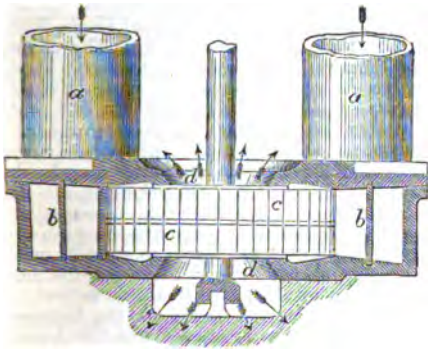

Fig. 11.

and 12) takes in the water after descending through the tubes, *a*, *a*, at the circumference, where, by means of fixed blades, *b*, *b*, it acquires a tangential

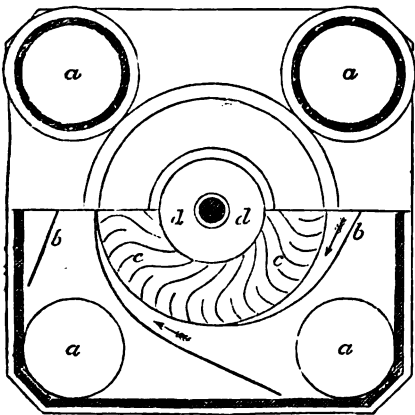

Fig. 12.

motion, and then passes through between the curved arm, *cc*, of the wheel, and escapes at the centre,

*dd*. As the two last described wheels work always under water, they are not liable to be obstructed by back-water, or to have their power lessened thereby more than what is due to the diminished fall, and they are understood to yield a good percentage of power, sometimes stated at 75 per cent.; but all turbines are somewhat delicate, and liable to be choked by leaves or twigs, unless the water be carefully strained. Although only a few horizontal wheels have been described, their name is legion, and it would take a book to mention them all, or to describe their respective merits.

The reciprocatory hydraulic engine, as shewn in fig. 13, works exactly on the same principle as the ordinary non-condensing steam-engine. The water,

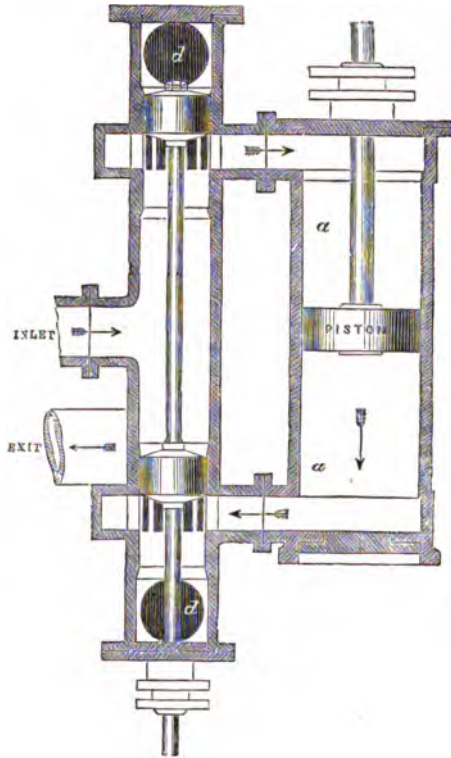

Fig. 13.

under considerable pressure, is admitted at one end of a cylinder, *a*, the exit valve, *d*, at that end being simultaneously closed, while it is shut off from the other end, and the exit valve, *d*, there opened; and so the alternating action of the valves and of the piston goes on continuously. To work smoothly and effectively, the piston ought to be of large diameter, in proportion to the length of stroke, and to go slowly; otherwise the quick jerking is apt to shake and to injure the engine; and generally it is better to have two cylinders and pistons working together, as that enables them to work more equally, and to turn the crank without the use of a fly-wheel.

Both the turbine and the reciprocatory engine have been made use of as water-meters.

The turbine and the reciprocatory engine have the advantage of being able to take the use of a fall much greater in height than the diameter of the largest wheel that can be made; but for all ordinary falls, a good breast or overshot wheel,

or even an undershot, is, on the whole, generally considered better.

**WATER-PROOFING.** See CAOUTCHOUC. Besides the application of caoutchouc, peculiar methods have been employed to render cloth impervious to water, at the same time allowing the passage of air, the absence of this property in the impermeable caoutchouc manufactures having been found disadvantageous. Two plans are adopted for water-proofing woollen cloths, without rendering them quite impervious to air—the first is to dip the cloth into a solution of soap, and thoroughly rub it into the texture, after which it is dipped into a solution of alum; a decomposition of the soap and alum is effected, and the minute openings between the fibres are in some way partly filled so as to exclude water. In the second plan, the cloth is dipped into a solution of gelatine or isinglass, and afterwards in a solution of galls. A kind of tanning process is the result, the gelatine which has pervaded the cloth being rendered as insoluble as leather by its union with the tannin of the galls.

**WATER-SPOUT.** See WHIRLWIND.

**WATER-SUPPLY.** Water is one of the primary wants of human life, no less essential than air and food; hence the strong and religious interest that has always been attached to the means of its supply. In the earliest records of civilisation, we read of the digging of wells, and of quarrels about the possession of them. The 'Pools of Solomon,' near Bethlehem, which remain now almost as perfect as when they were built, were connected with a scheme for supplying Jerusalem with water. In Assyria and Persia, from the earliest times, water has been conveyed to towns from astonishing distances in open channels or canals, and in subterranean tunnels, or *kanats*. In Egypt also, and in China, gigantic works for conveying water, both for domestic use and for irrigation, have been in existence from remote antiquity. Nor were these undertakings confined to the eastern hemisphere; we have evidence of the existence of kindred works in pre-Christian America. The ancient city of Mexico, which was built on several islands near the shore of the lake, was connected with the mainland by four great causeways or dikes, the remains of which still exist. One of these supported the wooden aqueduct of Chapultepec, which was constructed by Montezuma, and destroyed by the Spaniards when they besieged the city. Hydraulic works on a great scale had also been executed by the Incas of Peru. Of all the ancient nations, the Romans paid the greatest attention to the supply of water, and carried the construction of *aqueducts* to the greatest perfection and magnificence. If we except the supply of New York from the Croton river (see *AQUEDUCT*), and that of Glasgow from Loch Katrine, the efforts to supply modern cities are as yet insignificant compared with those of the Romans. The last-named works, finished in 1858, convey 19 million gallons a day a distance of 26 miles. It is only since the beginning of the sanitary movement, occasioned by the repeated visitations of cholera beginning with 1832, that the subject of water-supply, and more especially the *quality* of water-supply, has seriously occupied public attention. The result of every inquiry and every day's experience has been to bring out more strongly the decided effects on the health of a community arising from the quantity and quality of the water at their command; and as the river and surface sources of supply near the chief seats of population are becoming every year more contaminated by Sewage (q. v.), the drainage from manured land, the droppings of animals, and the refuse of manufactures, enterprise and engineering skill must

be directed either to procuring a supply of pure subterranean spring water from the chalk or other absorbent strata, or to bringing pure water from greater distances than hitherto. In 1867, a royal commission was appointed to inquire into the condition of the water-supply of London; and numerous schemes were laid before them. Mr Bateman proposed to utilise the high drainage-grounds of North Wales, from which the river Severn is supplied, having an area of 204 square miles. The water was to be conveyed for the most part in an open aqueduct, 173 miles long, and capable of carrying 230 millions of gallons a day, to service-reservoirs on the high land near Stanmore, about ten miles from London, from which it was to be delivered, at high pressure, by means of pipes, to the whole city. The total cost was estimated at £11,400,023. On the ground of the distance, the committee reported against the proposal; as, on like grounds, they also did against a rival scheme for taking the supply from the Lake districts of Cumberland and Westmoreland. Owing to the exceptionally great rainfall in these regions (140 inches on an average), it is calculated that the two lakes of Ullswater and Haweswater, with a drainage of 100 sq. m., receive together an average daily discharge of 550 million gallons. From this water, which is very free from mineral matter, there have been proposals to supply not only the metropolis, but the principal towns of the north-west of England—Liverpool, Leeds, Bolton, Bury, Blackburn, Huddersfield, &c. The commissioners came to the conclusion that the Thames water has many good qualities, which give it in some respects a superiority over the soft waters usually obtained from high gathering-grounds. It is well aerated, and keeps well. Recently, a covered conduit, 80 miles long, has been constructed, which conveys 8 million gallons of pure chalk spring-water from the sources of the Dhuis, in Champagne, to Paris; and operations are going on to bring the chalk springs of the Vanne, calculated to yield 22 million gallons a day, also to Paris, a distance of 104 miles.

The chief points of interest on this subject may be arranged under the heads of the Sources of Supply, the Qualities of Water, and the Arrangements for its Conveyance and Distribution.

#### *Sources of Water.*

The ultimate source of all *fresh* water is Rain (q. v.). When it has fallen on the earth, it presents itself chiefly in the forms of surface-water, rivers, and springs.

*Surface-collection.*—Rain-water, as it is formed in the upper regions of the atmosphere, is the purest that nature supplies; but in descending, it brings with it whatever impurities are floating near the surface, which, in the neighbourhood of towns, are numerous, consisting of various gases, together with soot and other floating particles, organic and inorganic. Rain-water has a strong affinity for organic impurities—that is, the corrupting ingredients derived from vegetable and animal bodies, and which are diffused over every surface in the vicinity of living beings; hence, when collected from the roofs of houses, it has a tendency to rapid putrefaction. Being free from saline ingredients, it is excellent for washing, but is not generally pleasant to drink.

But if we resort to a barren district of rock or sand, destitute of vegetation, and remote from the pollution of towns, we may obtain water with comparatively little organic impurity. Notwithstanding several defects, it happens in various places that a surface-supply is the best that can be had.

*Rivers.*—The water obtained from running streams is in part what has flowed immediately from the

## WATER-SUPPLY.

surface, and in part the water of springs, shallow or deep. In any case, a considerable amount of contact with the ground has taken place, and in consequence saline and organic matter is liable to be dissolved in a greater or less degree. The extent of the impregnation, as well as the kind of material dissolved, will depend on the rocks and strata of the river-basin.

River-waters, besides the qualities they derive from their primitive sources, are apt to contain mud, decayed leaves, the exuvise of fish, and other matters in suspension, and are thus deficient in the clearness and transparency so essential to the satisfaction of the eye in a drinking-water. Moreover, the water partakes of the extremes of summer and winter temperature. But the great objection to water from rivers is their general pollution from the manure used upon the land, sewage, and manufactures, so that there are now few rivers left from whose lower course a supply could be taken for domestic purposes. On the other hand, the supply from one of our large rivers is boundless and unfailing; and it conveys the surface-drainage and spring effusions of a large tract of country, without incurring any trouble or expense as to the original sources. Rivers that issue from lakes are generally the purest, as the suspended matter has time to be precipitated.

**Springs.**—The qualities that recommend water to the eye and to the palate belong in a pre-eminent degree to spring-water (see SPRING): it is clear, sparkling, and of an agreeable and uniform temperature at all seasons of the year (about 50° Fahr.); it is well aërated, and is totally free from the offensive taint so common in all other waters, as well as devoid of the animalcules generated by organic impurity; and where a sufficient number of springs can be collected to suffice for a town, it is the most desirable of all sources of supply. Three-fourths of the water brought to Edinburgh is spring-water collected on the slopes of the Pentlands.

### Quality of Water.

Perfectly pure water is hardly to be found; rain-water, and even artificially distilled water, are only approximates. The chief impurities may be considered under the heads of Mineral Matter in Suspension, Mineral Matter in Solution, and Organic Matter.

**Mineral Matter in Suspension.**—When running water comes upon a loose bottom, it carries the finer particles of sand and earth along with it. If the water comes into a position of perfect stillness, the matters thus floated gradually sink to the bottom again, with the exception of particles of clay, which, owing either to their excessive fineness or to their adhesive attraction for water, are incapable of being satisfactorily separated either by subsidence or filtration. Besides earthy matter, compounds of iron and lead are also in some circumstances present in a solid state, and may be got rid of by filtering. To separate clay-powder from water, the practice has long been resorted to in India and China of putting in a piece of alum, which seems to produce a kind of coagulation.

**Dissolved Mineral Matter.**—Spring-water, which is generally clear and sparkling, holding no solid matter in suspension, is seldom without a large amount of dissolved mineral matter, sometimes as much as 2 parts in 1000, commonly from 1 in 1000 to 1 in 20,000. River and surface water also contains more or less dissolved minerals (see MINERAL WATERS). The great bulk of the solid matter held in solution in ordinary waters consists of the salts of soda, potash, lime, and magnesia. The most material are the salts of lime and magnesia, as they are the

causes of what is called 'hardness' in water, which we shall speak of more particularly afterwards. The most important salt of lime is the *bicarbonate*, which is derived from chalk or limestone. Chalk or limestone is a *carbonate* of lime—that is, a compound of lime with one equivalent of carbonic acid—and is almost insoluble in water; but when water containing an excess of carbonic acid—as is the case with spring-water especially—passes over limestone, it gives the carbonate a double dose of carbonic acid, and converts it into bicarbonate, which is soluble. The waters having bicarbonate of lime for their chief impurity, are familiarly spoken of as the chalk-waters. The other salt of lime often present in water is the *sulphate* or *gypsum*. The important distinction between the bicarbonate and the sulphate lies in the fact, that the first, the bicarbonate, may be in great part precipitated, or thrown down in a solid form, by boiling, which drives off the solvent carbonic acid; whereas the second, the sulphate, cannot be so precipitated. The chief effect of the boiling takes place in the first five minutes; but it may be increased by continuing it for fifteen minutes or even an hour.

Apart from its hardness, it has been made a question whether water containing salts of lime is injurious or not to the human constitution. Dr Lankester holds that there is evidence to prove that carbonate of lime in large quantity is positively injurious; and most physiologists are agreed that pure water is the best for securing the health of animals and man.

With regard to magnesia, its salts are well known to act as powerful medicines when taken in large doses, and it may be presumed are not altogether without effect in the small quantities existing in ordinary magnesian waters. A foreign physician has lately made the observation, that magnesia is the characteristic ingredient of waters in the districts where the diseases called *cretinism* and *goitre* abound.—Of salts of *soda* and *potash*, the principal is common salt, or the muriate of soda. Sulphate of soda (Glauber's salt) occurs along with the muriate in the salt-springs of watering-places as well as in the sea-waters. None of all these salts have any effect on the hardness. In the case of sea-water, which is very hard, the effect is not due to common salt, but to the lime and magnesian salts dissolved in it; were it not for these, sea-water would be perfectly suitable for washing, although not for drinking.—Salts of iron in considerable quantity make what are technically named *chalybeate* waters, which belong to the medicinal class. When the iron exists in the spring as carbonate, which is the most usual case, on exposure to the air, it is changed into the peroxide, and falls down in the form of an ochery precipitate. Salts of iron give an inky taste to the water, and a yellowish tint to linen washed in it.

**Hardness in Water.**—The quality of hardness in water is commonly recognised by the difficulty experienced in washing, and by the amount of soap necessary to form a lather. This quality is injurious also in the preparation of food; but its action is most universally felt in washing operations. It occasions the chapping of the skin, an enormous waste of soap, an extra labour, and a corresponding tear and wear of clothes. Every grain of chalk contained in water decomposes 10 grains of soap; and thus the hardening matter contained in 100 gallons of water, such as is supplied to London, will destroy 35 ounces of soap—that is, the first 35 ounces of soap added to this quantity of the water will disappear without forming any lather, or having any cleansing effect. Soap is a compound, formed of an alkali (soda or potash) joined to an oily acid. When a salt of lime,



then, is present in the water, the lime decomposes the soap, and combines with the oily acid to form a lime-soap, which is insoluble, and has no detergent properties.

The most usual hardening ingredients are the salts of lime. Salts of magnesia and of iron are also hardening salts. Salts of soda and potash have no hardening effect. Dr Clark, formerly Professor of Chemistry in Marischal College, Aberdeen, has devised a scale of hardness which is now universally employed in the chemical description of waters. The hardening effect that would be produced by one grain of chalk dissolved in a gallon of water is one degree of hardness; in like manner, four grains per gallon would produce four degrees of hardness; ten grains, ten degrees; and so on. The degrees are expressed in numbers—thus, 1°, 4°, 10°, 15°, are one, four, ten, fifteen degrees respectively. The degree of hardness of any particular water can be readily and exactly determined by Dr Clark's Soap Test (q. v.).

Next to washing, the deleterious consequences of hardness are felt in various culinary operations, especially in the furring of boilers and cooking utensils, and in the infusion of tea. It is a fact of universal experience that hard water requires more tea than soft water to make an infusion of the same strength, and also renders the infusion muddy. Sub-carbonate of soda in crystals, by decomposing the earthy salts, improves the water; but if more is added than what will exactly decompose the earthy salts present, it injures the fine flavour of the tea. It may be stated generally, that for the purposes of washing and cooking, a water of less than 6° is soft, but above this point the hardness becomes objectionable. At 8°, the water is moderately hard; at 12°, it is very hard; at 16°, the hardness is excessive; and much above this, it is intolerable.

To make these observations more intelligible, we may mention a few instances of known waters, with their place in the scale. In Keswick, the water is under half a degree of hardness; in Lancaster, it is 1½°; and in Manchester, 2°. The water of the Dee at Aberdeen, which is used for the supply of the town, is 1½° of hardness. The water of Loch Katrine is of remarkable purity, having only two grains of solid matter of all kinds in the gallon, and 1° of hardness. The waters of the Welsh mountains, from which it is proposed to supply London, have on an average less than 2°. The river Clyde, which formerly supplied Glasgow, is 4½°, and may also be reckoned a soft water. The Thames at London, as well as the New River, is about 14°, while many of the tributaries of the Thames rise as high as 16°; but being all chalk-waters, they may be materially softened by boiling. Springs from the chalk commonly range from 16° to 18°; but particular springs are to be met with in some parts of the world four or five times as hard, from the presence of bicarbonate of lime. The water of the Treasury pump in London has from 50° to 60° of hardness. In many parts of the continent, hard waters abound; but the testing of waters has not been so much attended to there as in this country.

The evidence led before the Royal Commission above referred to went to prove that there is no reason whatever to suppose that the hardness of the Thames water, which averages about 15°, would be in the least degree prejudicial to health. It appears that the hardness of springs is generally considerable; and that surface-waters may be collected in a state that is to be considered soft (4°-94).

**Lead in Water.**—Injurious effects have frequently arisen from the contamination of water with lead, derived from leaden pipes and cisterns. Some kinds of water are known to act powerfully on a leaden

surface, and others scarcely at all; but the qualities and circumstances on which the action depends have never been satisfactorily determined. Distilled water, and soft lake and river waters in general, act most decidedly, but by no means in proportion to their softness. The presence of air in the water seems one essential condition; light also increases the action, as does the presence of vegetable matter; it has been observed that when leaves drop by chance into a lead cistern, the spots where they lie become visibly corroded. The water of Loch Katrine, according to extensive sets of experiments by distinguished chemists, is allowed to have an intense action\* on lead under certain circumstances—viz., 1st, If the lead be bright and highly polished; and 2d, If the lead and water be freely exposed to the access of air. But it 'does not exert any noxious action on lead when the metal is in its ordinarily dull state.' The coating formed on the surface of the metal is held to protect it from further chemical action. Still there are opposing facts to shew that this protective action is not always to be relied on; and that water that has passed through any considerable length of lead pipe, or stood for some time in a short one, or in a cistern, should never be used without care; a ninth part of a grain of lead per gallon has been known to derange the health of a whole community. Dr Clark made the unexpected discovery that sand-filters completely separate the lead.

**Organic Impurities.**—The contamination of water by vegetable and animal substances takes place in various ways. The most obvious and abundant source of this class of ingredients is the sewage and refuse of towns; and next in order may be ranked the contact with soils rich in organic matter. Among organic impurities may be classed offensive gases, such as carburetted, sulphuretted, and phosphuretted hydrogen; vegetable fibres in a state of rotteness; putrefying products of the vegetable or animal kingdoms; starch, muscular fibre, &c.; urea and ammoniacal products; vegetable forms—algæ, confervæ, fungi, &c.; animalcules—infusoria, entomozoa, annelidæ or worms, &c. Water falling on a growing soil, and running off the surface to lie in stagnant ponds, is in very favourable circumstances for being tainted with vegetable and animal life. Water-plants will spring up and feed numerous tribes of animalcules, and each pool will be a constant scene of vitality. In such a state, the water is usually unfit for drinking; the palate instantly discerns a disagreeable taint, and no one will use it who can do better. The surface-water of a district overgrown with peat-moss has usually a peaty flavour, as well as a dark and dirty colour. The infusion of peat does not breed animalcules, being a strong antiseptic; but it is an objectionable ingredient nevertheless. Very slow filtration has been found to remove the colour of the infusion in some degree, but not entirely. Lime removes the peat most effectually, but there is both expense and risk in applying it. It is perhaps doubtful whether any specific unwholesomeness can be justly attributed to peat-water; but it is unpalatable, and the use of it is shunned by the inhabitants of peaty districts, and even by cattle. The presence of peat in the lands used as collecting-grounds for surface-water—and it is generally such worthless tracts that are so employed—is a disadvantage attending that mode of supply.

\* The water of Loch Katrine is remarkably well aerated, having 7½ cubic inches of air per gallon, of which 2½ inches are oxygen. Dr Clark has a suspicion that the oxygen may turn out to be in some different state or modification from common oxygen.

## WATER-SUPPLY.

Chalk-water, which, as it issues from a spring, is perfectly free from organic matter, has a source of contamination within itself. When exposed to light and air, the duplicate dose of carbonic acid that keeps the chalk dissolved, becomes decomposed; and the carbon of the decomposed acid gives rise to a green vegetation, which soon acquires an offensive marshy smell.

Organic matter in a putrefying state forms the worst kind of contamination that water can have. Though we may not know the precise effects of these impurities on the animal system, the single fact of their rendering the water repulsive to the taste and nauseous to the stomach would be sufficient to condemn their use. What is disagreeable to the senses, must be presumed to be unwholesome in addition, until the contrary is proved. Though no one has ever yet gone the length of maintaining, as a general truth, the wholesomeness of water abounding in vegetation, insects, and decaying matter, yet the water of the Thames, even within the influence of the tides, where it is contaminated by the whole sewage of the metropolis, found defenders until lately, on the plea that the amount of impurity was too small to do harm. This ground is at length given up; but Thames water above Teddington Lock is still sanctioned as safe water for the companies to supply to the inhabitants of London, notwithstanding the sewage of the numerous populous towns that the river receives above that point. As to this plea of smallness of amount, the highest medical authorities hold that it is impossible to say how small a quantity of organic matter in a state of fermentation may not do harm. We are not, however, left merely to presume that organic impurity in water is prejudicial to health. During the cholera visitation of 1853—1854, a gigantic experiment was undesignedly made on half a million of human beings. It so happened that a certain district of London was supplied by two rival water-companies, the two mains running often side by side, and some houses taking water from the one, and some from the other. The whole inhabitants were living alike in all respects save one—viz, that one company drew its water from high up the Thames, where it was of comparative excellence, while the other drew its water from low down the river, where it was profusely contaminated with town-drainage. Among this population, there were more than 4000 deaths from cholera; and when the epidemic had subsided, an inquiry was made, house by house, as to those deaths, and as to the water-supply of the several houses where they had occurred. The inquiry was conducted with every precaution, to avoid sources of fallacy; and the result was this: in the one set of houses, the mortality per 10,000 of the population was 37; in the other set of houses it was 130—that is to say, the cholera death-rate was  $3\frac{1}{2}$  times as great in the one set as in the other.

It is a common notion that *every drop of water teems with life*; but this is a mistake. Deep wells, and spring-water in general, contain little or no living organic matter. Consequently, it is quite possible to obtain a liquid perfectly free from animalcules and vegetation. The presence of living creatures, vegetable or animal, discernible either by the naked eye or by the microscope, is a proof of organic taint in the water, and is one of the tests of this kind of impurity. With respect to rain-water, Dr Hassall states, in his evidence before the General Board of Health: 'I have made several examinations of rain-water immediately after its descent to the earth, obtained in both town and country, and can confidently assert that it does not, in general, contain any form of living vegetable or animal

matter.' The conditions necessary for the development of vegetation and animalcules over and above the presence of matter for them to feed on, are *air, light, and stillness*. With regard to the probable effects on health of living creatures contained in water, Dr Hassall's observations are worthy of attention: 'All living matter contained in water used for drink, since it is in no way necessary to it, and is not present in the purest waters, is to be regarded as so much contamination and impurity—is therefore more or less injurious, and is consequently to be avoided. There is yet another view to be taken of the presence of these creatures in water—viz, that where not injurious themselves, they are yet to be regarded as tests of the impurity of the water in which they are found.'

### *Means of purifying Water.*

The mechanical impurities of water, or the solid particles rendering it muddy or milky, may in most cases be removed by mechanical means. The two processes for this purpose are *subsidence* and *filtration*. The effects of subsidence are strikingly seen in the case of rivers that pass through lakes. See GENEVA, LAKE OF. The subsidence of solid particles depends on their own weight, as compared with the weight of an equal bulk of water. To favour the process, the most perfect stillness should be allowed. It is expedient to have partitions placed in the subsiding reservoirs at short intervals, more effectually to prevent the agitation of the water. The water should be run off from the top, and not from the bottom. By making the bottom of the subsiding reservoir form a declivity from opposite sides, and providing means to let off the water occasionally from its lowest depth, it is possible to get quit of the subsided mud. It is always found of advantage in clearing water from solid particles, whether by subsidence or by filtration, to mix together streams of different qualities.

In constructing an artificial filter on a large scale, a basin is formed, having the floor nearly level, but slightly inclining towards a centre line, and made water-tight by puddling the bottom and sides with clay. On the floor is laid a series of layers of gravel, coarse at first, and getting gradually finer upwards; next, a layer of slate-chips or sea-shells, then one of coarse sand, on which is placed the actual filtering layer of fine sand. The depth of this layer is from twelve to thirty inches, that of the entire mass from four to six feet. The water being admitted gently on the top of the sand, sinks down and is conducted by a series of channels, generally of tile-pipes, into the main drain. A filter in a clean state will pass from twelve to eighteen vertical feet of water in twenty-four hours. The solid matter intercepted does not penetrate more than three-fourths of an inch into the sand, so that, by removing a very thin film from the surface, the filter is again clean. What is scraped off the top, is capable of being washed and put again to use. 'This process of filtration,' says Professor Clark, 'is efficacious in removing mechanical impurities to an extent that could scarcely be believed without seeing the process.'

The cleansing power of sand can hardly be accounted for on the theory of mere mechanical interception. Though there is no chemical action, strictly speaking, there is no doubt that the attraction of adhesion is at work—a power that plays a greater part in natural processes than has generally been assigned to it. Some substances manifest this adhesive attraction more strongly than sand, and have therefore still greater efficacy as filters; though practically, and on the large scale, sand is the most eligible. Powdered charcoal has long

## WATER-SUPPLY.

been known as a powerful filtering medium, attracting and detaining especially organic matter. Animal charcoal, or that derived from burning bones, is still more efficacious than wood charcoal. A filter of animal charcoal will render London porter almost colourless.

According to recent researches, it would seem that loam and clay have similar properties, and may be made available as filters. Professor Way states that 'they have powers of chemical action for the removal of organic and inorganic matters from water to an extent never before suspected.' The filthiest liquids, such as putrid urine and sewer-water, when passed through clay, dropped from the filter colourless and inoffensive. The clay used was that known as pipe-clay.

For filters for domestic use, see FILTER.

*Softening of Water rendered Hard by Chalk—Clark's Process.*—This is one of the most beautiful applications of science to the arts of life that could perhaps be named. We extract the inventor's own account of it, as given in a paper read before the meeting of the Society of Arts:

'In order to explain how the invention operates, it will be necessary to glance at the chemical composition and some of the chemical properties of chalk; for while chalk makes up the great bulk of the matter to be separated, chalk also contains the ingredient that brings about the separation. The invention is a chemical one for expelling chalk by chalk. Chalk, then, consists, for every 1 lb. of 16 oz., of lime, 9 oz.; carbonic acid, 7 oz.

'The 9 oz. of lime may be obtained apart, by burning the chalk, as in a lime-kiln. The 9 oz. of burnt lime may be dissolved in any quantity of water not less than 40 gallons. The solution would be called lime-water. During the burning of the chalk to convert it into lime, the 7 oz. of carbonic acid are driven off. This acid when uncombined, is naturally volatile and mild; it is the same substance that forms what has been called soda-water, when dissolved in water under pressure.

'Now, so very sparingly soluble in water is chalk by itself, that probably upwards of 5000 gallons would be necessary to dissolve 1 lb. of 16 oz.; but by combining 1 lb. of chalk in water with 7 oz. additional of carbonic acid—that is to say, with as much more carbonic acid as the chalk itself contains—the chalk becomes readily soluble in water, and when so dissolved, is called bicarbonate of lime. If the quantity of water containing the 1 lb. of chalk with 7 oz. additional of carbonic acid, were 400 gallons, the solution would be a water of the same hardness as well-water from the chalk-strata, and not sensibly different in other respects.

'Thus it appears that 1 lb. of chalk, scarcely soluble at all in water, may be rendered soluble in it by either of two distinct chemical changes—soluble by being deprived entirely of its carbonic acid, when it forms lime-water, and soluble by combining with a second dose of carbonic acid, making up bicarbonate of lime.

'Now, if a solution of the 9 oz. of burnt lime, forming lime-water, and another solution of the 1 lb. of chalk and the 7 oz. of carbonic acid, forming bicarbonate of lime, be mixed together, they will so act upon each other as to restore the 2 lbs. of chalk, which will, after the mixture, subside, leaving a bright water above. This water will be free from bicarbonate of lime, free from burnt lime, and free from chalk, except a very little, which we keep out of account at present for the sake of simplicity in this explanation. The following table will shew what occurs when this mutual action takes place:

103

### AGENTS.

### PRODUCTS.

Bicarbonate of lime in 400 gallons.	{	Chalk . . . 16 oz. = 16 oz. of chalk with Carbonic acid 7 oz.	}	= 16 oz. of chalk
Burnt lime in 40 gallons of lime-water . . .	{	. . . 9 oz.	}	= 16 oz. of chalk

A small residuum of the chalk always remains not separated by the process. Of 17½ grains, for instance, contained in a gallon of water, only 16 grains would be deposited, and 1½ grains would remain. In other words, water with 17½° of hardness, arising from chalk, can be reduced to 1½°, but not lower.

'These explanations will make it easy to comprehend the successive parts of the softening process.

'Supposing it was a moderate quantity of well-water from the chalk-strata around the metropolis that we had to soften, say 400 gallons. This quantity, as has already been explained, would contain 1 lb. of chalk, and would fill a vessel 4 feet square by 4 feet deep.

'We would take 9 oz. of burnt lime, made from soft upper chalk; we first slack it into a hydrate, by adding a little water. When this is done, we would put the slacked lime into the vessel where we intend to soften; then gradually add some of the water in order to form lime-water. For this purpose, at least 40 gallons are necessary, but we may add water gradually till we have added thrice as much as this; afterwards, we may add the water more freely, taking care to mix intimately the water and the lime-water, or lime. Or we might previously form saturated lime-water, which is very easy to form, and then make use of this lime-water instead of lime, putting in the lime-water first, and adding the water to be softened. The proportion in this case would be one bulk of lime-water to ten bulks of the hard water.'

It is of importance that the lime-water—that is, the softening ingredient—be put into the vessel first, and the hard water gradually added, because there is thus an excess of lime present up to the very close of the process. Instead of lime-water, the lime itself may be put at once into the vessel, and some of the water to be softened gradually added to dissolve it. The softened water thus obtained has no action on lead-pipes or cisterns, as many soft waters have. One ton of burned lime, used for softening, will produce three and a half tons of precipitate. The present water-supply of the metropolis, if subjected to Clark's process, would deposit about fifty tons of chalk daily.

The process was in operation on a large scale for several years (1854—1861) at Plumstead, near Woolwich, where 600,000 gallons daily were operated upon with the most satisfactory result. These works are now given up, though for reasons quite apart from any failure in the process. But several water-works have since been erected, or are in course of erection, by Mr Homersham, C.E., London, for supplying water from the chalk springs softened by Clark's method; e.g. at Castle Howard, seat of the Earl of Carlisle (1858); at Caterham, Surrey, for the supply of Caterham, Warglingham, and several neighbouring towns (1861); at Shooter's Hill, Kent, for the War Office, for softening the water of the Kent Company for the supply of the Herbert Hospital, &c. (1865); at all of which works the process is in successful operation. Mr Homersham has also completed works near Tring, Herts, for the supply of Tring, Aylesbury, and other towns, with softened spring-water. Mr Homersham finds that spring-water from the chalk can readily, on

the large scale, be softened down to from 2½ to 4½ degrees of hardness.

Clark's process is not confined in its effects to softening; it has a decided influence as regards organic impurities; for it not only removes the active source of corruption which exists in all chalk-water, as above explained, but the precipitated chalk carries down with it a large proportion of such organic matters as may be already present. Several calico-printers in Lancashire have had Clark's process in use for several years, for the improvement of the quality of the water employed in their processes.

*Natural Process of Purification from Organic Matter.*—Although, by means of sand and other filters, or of the liming process, organic contamination of water may be much reduced, there still remains enough to render the water unsafe for use. Is water, then, once corrupted with organic matter, hopelessly and permanently so? This question can be answered in the negative. Filthy water has a tendency to purify itself, and this in two ways. In the first place, in any shallow stream of polluted water, such as the kennels of a street, there may be observed long brushes of a sort of alimy vegetation adhering to every projection of the bottom. All this matter has been disengaged from the water, which thus flows away so much the purer. The second and most effective part of the natural purification consists in the actual decomposition of the impurities. The nitrogen of the decaying matter, then, goes to form nitric acid, which, uniting with bases, forms salts of the class called *nitrates*, of which saltpetre is one. Thus, what was in a state of putrefactive change, offensive to the senses, breeding loathsome insects, and causing dangerous disorders, is changed in course of time into a stable and harmless product. This process is constantly going on in rivers and other waters containing organic matter. In the case of streams passing through populous districts, the contamination goes on at a rate far beyond the power of natural purification; but we can easily conceive how a river, very much contaminated with organic impurities at one part of its course, may, after flowing a long way through an uninhabited tract, be almost restored to its natural state. The process is one of oxidation, and takes place at the expense of the free oxygen, of which, in healthy normal water, there ought to be 29 per cent. of the entire volume of gases held in solution.

The oxidation is much favoured and hastened when the water percolates or filters very slowly through porous beds of earth. If the filtration has been sufficiently prolonged to convert all the decaying matter into carbonic acid or nitrates, the water will be pure, as far as the organic taint and the presence of animalcules are concerned, and will, in fact, be neither disagreeable nor unwholesome, the amount of the dissolved carbonates or nitrates being unimportant.

Dr Smith has proved by direct experiment that decomposing organic matter passed through a filtering-bed is changed into nitric acid. 'A jar, open at both ends, such as is used with an air-pump, was filled with sand, and some putrid yeast, which contained no nitric acid, was mixed with pure water, and poured on the sand, and allowed to filter through. The production of nitric acid was abundant.' It is not improbable that other earthy matters, such as loam and clay, may have a still more decided influence in hastening the formation of the nitrates; and perhaps by imitating more closely the slow mode of filtration by which nature converts surface-water into spring-water, it may yet be practicable to make the most contaminated waters fit for use.

*Conveyance, Storage, and Distribution.*

Into the engineering operations connected with the conveyance of water from its source to the town to be supplied, we need not enter, beyond noticing, that when the source is below the level of the houses, steam or other power is necessary to lift or propel the water to the necessary height; while in the more general and more desirable case of the source being higher than the place where the supply is to be delivered, the water is made to flow by its own gravitation, either in a channel or culvert with a continuous descent, as in the ancient Aqueduct (q. v.), or in the simpler and more economical modern plan of a line of cast-iron pipes following the inequalities of the surface. The annexed diagram represents an outline of this mode of conveyance; where *a* is a lake



Fig. 1.

or reservoir situated in a mountainous district, and *b* a town separated by several miles of irregular country; the course of the pipes is indicated by the dotted line, and the pressure of the water at *a* suffices to make the water rise at *b* to a height nearly equal to that of the head. In many cases, both principles are employed, the water flowing for the most part in a gently sloping conduit, tunnelled through hills where necessary, and being carried through valleys in tubes descending and ascending—an inverted siphon, as it is called. The Croton Aqueduct, which supplies New York, is carried across the Manhattan Valley, upwards of 100 feet deep, in this way. The Glasgow supply from Loch Katrine flows mainly in a sloping channel carried through tunnels and over bridges; but there are four miles of iron pipings across valleys.

The extent of the storage in reservoirs depends on the nature of the supply. If water is derived from perennial springs, whose minimum flow equals the maximum demand, the storage may be the least possible. If a river is the source, the reservoirs should be large enough to hold such a stock as will carry the consumers over the periods when the river is polluted by rains; they should also be large, on the principle of allowing time for purification by subsidence, especially if artificial filtration be not employed. In places where the supply is obtained from surface-drainage, or from a small stream, the practice is to build reservoirs capable of containing a five or six months' supply, it being necessary to provide against the greatest droughts that ever happen in any season.

The reservoirs should be deep, so as to prevent vegetation; and the distributing or service reservoirs should be roofed.

In distributing water over a town, two different methods have been adopted, known respectively as the *intermittent* and the *constant* systems of supply. On the intermittent system, water is laid on once a day, or once in two or three days, as the case may be, and fills a tank attached to every separate house, and from this tank the water is drawn off as required. The feeding-pipe of such a tank or cistern is provided with a ball-cock (see fig. 2), which ingeniously shuts off or admits the supply, as the cistern may be full or empty. On the constant system, no tank is absolutely needed, but the house-pipes are kept constantly charged through their unbroken connection with the distributing reservoir, which must

therefore be higher than the highest house to be served. The intermittent supply was until lately employed everywhere in the metropolis; but it is universally admitted that the other system is

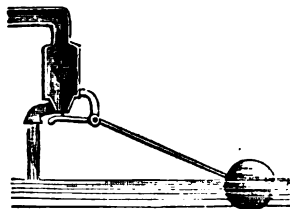

Fig. 2.

vastly superior in every respect. The disadvantages of the intermittent practice have been strongly set forth in all the recent official Reports on sanitary improvement: the expense of the erection and repair of cisterns, the trouble requisite to keep them clean, the contamination of the water by the neighbourhood of sources of pollution, the frequent waste of water that occurs, the difficulties imposed on the poorer class of tenements where cisterns are not provided—are a few of the objections urged against this mode of supply. In a letter in the *Times*, 3d January 1866, Dr H. Jeaffreson thus describes the condition, in regard to water-supply, of the centres of typhus infection in Lambeth, Southwark, Bethnal-green, &c. 'Those houses the best supplied have each a butt, holding about 80 gallons, into which water flows from a stand-pipe for from ten minutes to half an hour each day, and is supposed to supply the wants of 20 persons for cooking, the washing of their persons, house, and linen, and for the rinsing down of the w.-c. at such times as it may suit the caprice of any one of the inmates. At other places, a larger butt, but in relation to the number of persons proportionally smaller, supplies a whole court of ten or more three-roomed houses, which have no back-yards, and a population of 150 people—members of 30 different families. On Sundays, even this supply is absent, the water of the day before is gone, and in many houses, that for the Sunday cooking has to be begged from neighbours who may have provided themselves with a larger butt, who are more provident or more dirty. More than nine-tenths of these water-butts have no covers; and fully half are so placed as to catch the drippings from the foul eaves of the houses, and are lined internally with scum and slimy vegetation.'

One important advantage, arising from the constant system, is the ease with which water can be had in time of fires. The water being supplied at high-pressure, all that is necessary is to affix a hose to the water-plug in the street, when a jet corresponding in height to the pressure is obtained, which can be immediately directed against the fire.

The ratio of the supply to the population varies in different towns. In Edinburgh, it is 34 gallons for each individual; in Glasgow, it is 50 gallons. This includes the water furnished to works of various kinds. The eight companies that supply London pour into the city and suburbs not much less than 100,000,000 gallons daily, which gives 206 gallons per house (including manufactories), or 26 gallons to each person. Notwithstanding this, owing to the neglect of the proprietors, 'thousands of the poor get but little of it directly any day, and none at all on Sundays.'

*Cisterns, Pipes.*—Owing to the action of water on lead, already described, it is desirable to avoid the use of that metal in connection with very soft lake or river water. With regard to lead pipes, if the precaution is taken when the water has stood for any time in them, of allowing the first portions to run off before any is taken for use, little danger can arise; but either lead cisterns should be wholly avoided, or

means taken to ascertain whether they contaminate the water; and if so, a remedy should be applied. There are various substitutes for lead as a lining for cisterns. Slate slabs are highly recommended. Gutta-percha is also found to be an easily fitted, cheap, and durable lining. For a few days, the water tastes of the naphtha used in applying the lining; but afterwards, no kind of water, not even acids, have any action on the gutta-percha. Pipes of gutta-percha may also be used; they are cheap, and easily fitted up.

*Common Wells.*—The simplest of all water-supplies is that of a cottage or farmhouse in the country, with a good spring rising to the surface close by; and yet what a poor use is usually made of such a precious boon! The country well is generally a simple cavity to receive the spring, rudely lined, it may be, with stones, but with open mouth, into which dust and dead leaves are blown by every wind, and foul surface-water is trickling from all sides. Being exposed to the light, there is generally a profuse vegetation on the bottom and sides, and, in addition to these impurities, it is further muddied by the dipping in of buckets, often dirty on the outside. Who has not been disgusted, when asking a drink at a cottage, to get water thick with dust and visible impurities, knowing, at the same time, that it might be so easily remedied? A surface-spring should always be covered, and made to issue by a pipe; half a day's labour to create a fall, and a clay drain-tube, will generally convert a filthy puddle into a crystal fount. It is singular to see this blindness to the impurity of water in people otherwise cleanly enough. This is a subject worth the attention of country physicians and clergymen. The evil effects of drinking impure water are not confined to towns. May not the putrid sore throat and malignant fevers that often sweep away whole households in the country, especially in autumn, be partly owing to the cause now pointed at?

Deep wells should invariably be covered, and carefully protected from the infiltration of superficial ooze. The situation of pump-wells is often singularly ill chosen in this respect. See ARTESIAN WELLS.

**WATER-TABLE**, a set-off in a wall sloped on top to throw off the rain.

**WATERTOWN**, capital of Jefferson County, New York, U. S., on the Black River, 86 miles north-west from Utica, and 182 from Albany; has manufactories of cotton, woollen, flour, paper, iron castings, machinery, &c. An ice-cave extends partly under the village. Pop. in 1870, 9336.

**WATERTOWN**, a city of Wisconsin, U. S., on Rock River, and the Fond du Lac and Rock River Railway, 40 miles east-by-north from Madison. The city is built on both sides of the Great Bend, where rapids with a fall of 24 feet afford water-power for flouring and saw mills, foundries, and manufactories of agricultural implements, furniture, woollen mills, and potteries. Settled in 1836. Pop. in 1870, 7550.

**WATERVILLE**, a village of Maine, U. S., on the right bank of the Kennebec River, at Ticonic Falls, 82 miles north-north-east from Portland. Around the falls are clustered saw-mills, plough, axe, hoe, and scythe factories, machine-shops, tanneries, &c. W. has a Baptist College, with 120 students, and library of 15,500 volumes, an academy, &c. Pop. in 1870, 4852.

**WATER VIOLET.** See HOTTONIA.

**WATERY GRIPES** is the popular name for a form of serous diarrhoea occurring in infants, in which there are copious discharges of thin watery motions, often limpid, or almost colourless, and

occasionally intermixed with flakes or shreds. This form of diarrhoea may be induced in weakly children by sudden impressions of cold on the surface, so as to check perspiration; or it may be brought on by cold drinks taken when the body is heated. The exhaustion brought about by the copious excretions from the bowels is sometimes so great that the case might be mistaken for one of cholera. On the occurrence of such an attack, the child should at once be wrapped up in warm flannel, placed in bed, with a bag of hot dry bran over the belly; and some arrowroot, with a little brandy, given frequently in teaspoonfuls or larger doses according to age; and the medical attendant should be at once sent for. If medical aid cannot be readily procured, opium must be carefully used to check the profuse evacuations. One of the best preparations is Aromatic Powder of Chalk and Opium, every 40 grains of which contain 1 grain of opium. From 3 to 5 grains of this powder, with a quarter of a grain of ipecacuanha, may be given, and repeated every three or four hours for two or three times, unless any head-symptoms (due to the opium) are perceived.

WATFORD, a market-town in the county of Hertford, on the banks of the Colne, 18 miles north-west of London. Straw-plait is manufactured, and silk-spinning and malting are carried on; and there are two large paper-mills. Pop. 7461.

WATLING ISLAND, one of the Bahamas (q. v.).

WATLING STREET. See SUPP., Vol. X.

WATT, JAMES, mechanic, engineer, and man of science, famous as the improver, and almost the inventor of the steam-engine, was born at Greenock in Scotland on the 19th of January 1736. His father was a blockmaker and general merchant at Greenock, was long a member of the council of that burgh, and for a time a magistrate. Two members of James W.'s family—his grandfather and his uncle—had had some local reputation for scientific or engineering ability. The former was a teacher of mathematics, surveying, and navigation at Crawfordsdyke, near Greenock; the latter practised as a land-surveyor and engineer with great success at Ayr. The grandfather, Thomas Watt, had been brought early in life to Lanarkshire from the neighbourhood of Aberdeen, where his family had previously lived. The father of Thomas Watt, the great-grandfather of James, is said to have farmed a little property of his own in Aberdeenshire, and to have been killed while fighting on the side of the Covenanters against the Marquis of Montrose.

James W. was very weakly as a child, and being unable to go to school with regularity, he became, to a great extent, his own instructor. What schooling he did get, he got in the schools of his native town. He early manifested a turn for mathematics and calculations, and a great interest in machines, and accordingly—his father's business, for which he had been destined, having greatly declined—he was, at the age of 18, sent to London, to learn the trade of a mathematical instrument maker. Ill-health compelled him to return home about a year after; but he had made good use of his opportunities in London; and on his health improving, he resolved to set up as a mathematical instrument maker in Glasgow. The incorporation of hammermen of that city put difficulties in his way; but the authorities of the university took him by the hand, appointed him mathematical instrument maker to the university, and gave him the use of premises within their precincts. He occupied these premises from 1757 to 1763. They seem to have been badly situated for his business, for which, moreover, at that time there was but little room in Glasgow;

and W. during those years was scarcely able to make a living. In 1763, he got a place of business in the town, and after that, he did somewhat better; still, he had to eke out his income by making or mending fiddles (which he was able to do, though he had no ear for music), or doing any mechanical job which came in his way; and no work requiring ingenuity or the application of scientific knowledge seems to have come amiss to him. At length, in 1767, he fell upon a new and a more lucrative occupation. In that year, he was employed to make the surveys and prepare the estimates for a canal projected to unite the Forth and the Clyde. This work could not be carried out at the time, because it failed to obtain the sanction of parliament; but W. had now made a beginning as a civil engineer, and henceforth he got a good deal of employment in this capacity. He made surveys for various canals, for the improvement of the harbours of Ayr, Port-Glasgow, and Greenock, and for the deepening of the Forth, the Clyde, and other rivers. One of the tasks committed to him was to decide whether a projected canal between the Firth of Clyde and the Western Ocean should be made by way of Crinan or of Tarbert; and the last—also the greatest—undertaking of this kind on which he was employed was a survey for a canal between Fort-William and Inverness; a work which has since been executed on a greater scale by Telford. In his surveys, he made use of a new micrometer, and of a machine, also of his own invention, for drawing in perspective—the latter of which appears to have been for several years about this time one of his sources of income. The Reports which he drew up in the capacity of engineer are said to have been remarkable for perspicuity and accuracy.

Living in the college at Glasgow, in constant intercourse with the professors of the university, with access to books, and with much unemployed time on his hands—having, too, a great love of knowledge, and a lively interest in mechanical novelties, W. had been a diligent student of science, and experimenter in the application of science to the arts. As early as 1759, his attention had been directed to the capabilities of steam as a motive-force by Mr Robison (q. v.), afterwards Professor of Natural Philosophy in the university of Edinburgh, who was then a student in Glasgow. It had occurred to Mr Robison that steam-pressure might be used to propel wheeled-carriages; but it does not appear that either W. or he attempted to carry out this idea. In 1761 or 1762, however, W. made a series of experiments on the force of steam, using a Papin's Digester. These do not seem to have led to any results; and it was not till the winter of 1763—1764, that he began the investigations which ended in his improvement of the steam-engine. During that winter, a working model of the Newcomen engine, kept for the use of the natural philosophy class in the college, was sent to him to be put in repair. W. quickly found out what was wrong with the model, and easily put it into order. But in doing this, he became greatly impressed with the defects of the machine, and with the importance of getting rid of them. The Newcomen engine (see STEAM-ENGINE), was still but little used, and only for pumping water out of mines. It was a cumbersome machine, and it required so much fuel that the expense of working it had restricted, and must always have restricted its use. It was not a steam-engine at all. It was worked by means of the atmospheric pressure; steam being only used in producing, by its condensation, a vacuum in a cylinder, into which—the vacuum made—a piston was depressed by the pressure of the air. The steam issuing from a boiler was admitted into the

cylinder until it filled it, when the supply was cut off by a self-acting cock; and then the steam was condensed in the cylinder by means of a jet of water. The water so greatly cooled the cylinder that the greater part of the steam at each stroke of the piston was wasted in heating its walls; and on the other hand, much of the injected water was heated to the boiling-point, and gave off steam, which resisted the descent of the piston. W. found that about four-fifths of the steam, and consequently of the fuel, was wasted; and he saw that to make the machine work economically, two apparently incompatible conditions must be obtained—first, that the walls of the cylinder must constantly be of the same temperature as the steam which came in contact with them; and second, that the injected water must never be heated up to 100°, the boiling-point *in vacuo*. He now experimented upon the conducting power of various substances, and made trial of a cylinder made of wood steeped in oil; but with this cylinder, though it cooled less rapidly than a metallic one, there was still far too much waste of steam. Constantly, from the end of 1763, occupied with the subject of steam, he at length, early in 1765, hit upon the expedient which solved all his difficulties—the separate condenser, an air-exhausted vessel, into which the steam should be admitted from the cylinder and there condensed. The separate condenser at once prevented the loss of steam in the cylinder which had arisen in the process of condensation; and there was no difficulty in keeping it cool, so as to prevent the undue heating of the injection-water. He had now got a perfectly economical engine on Newcomen's principle, but he did not rest content with this—he resolved to make steam his motive-power. Closing the cylinder at both top and bottom, and connecting the piston with the beam, to which it was to communicate motion, by a piston-rod passing through a stuffing-box, he admitted the steam by suitable valves alternately above and below the piston, to push it downwards and upwards in turn; and this done, his invention was substantially complete. He had at last made a real steam-engine, capable of being worked with a comparatively small expenditure of fuel, and of yielding any desired amount of power. Comparing his invention with the atmospheric engine of Newcomen, it must be admitted that it is not without justice that the popular voice has awarded him the name of inventor of the steam-engine.

W., soon after perfecting his model, formed a partnership with Dr Roebuck, then of the Carron Iron Works, for the construction of engines on a scale adapted to practical uses; and a model was erected at Kinneil, near Borrowstounness, where Dr Roebuck then lived. But Roebuck got into difficulties; and nothing further was done until, in 1773, W. entered into a partnership with Matthew Boulton of Soho, near Birmingham, when, Roebuck's interest having been repurchased, the manufacture of the new engine was commenced at the Soho Iron Works. A patent for his invention had been taken by W. in 1769. He got from parliament a prolongation of his patent for 25 years in 1775.

The advantages of the new engine were in no long time found out by the proprietors of mines; and it soon superseded Newcomen's machine as a pumping-engine. W. afterwards made numerous improvements in its construction (for the most important of which see STEAM-ENGINE); and in conjunction with his partner Boulton, he immensely improved the quality of the workmanship employed in building engines and other machines. In the years 1781, 1782, 1784, 1785, he obtained patents for a series of inventions—among them, the sun and planet motion, the expansive principle, the double engine,

the parallel motion, and the smokeless furnace, of most of which the chief purpose was to make steam-pressure available for turning machinery in mills. The accomplishment of this—extending the application of the new power to the arts—was of scarcely inferior importance to the invention of the steam-engine itself. The first contrivance invented by W. for this purpose, was lost to him through the treachery of a mechanic, who had been employed in making the model, who sold it to a manufacturer named Prickards, who got a patent for it for himself. The application to the steam-engine of the governor (see STEAM-ENGINE) was W.'s crowning improvement. He made numerous inventions unconnected with the steam-engine, several of which he patented, but they are all of minor importance.

He retired from business in the year 1800, giving up to his two sons his interest in the extensive and prosperous business which Boulton had created at Soho. He died at Heathfield in Staffordshire, on the 25th August 1819, in his 84th year. W. was twice married: first in 1763, to his cousin, Miss Miller; and a second time shortly after his removal to Birmingham, to a Miss M'Gregor of Glasgow. He had a most extensive and accurate knowledge of the physical sciences, to several of which he made important contributions—and an almost unsurpassed fund of general information. (His claims to be considered the discoverer of the composition of water are considered in the article WATER.) He was elected a Fellow of the Royal Society of Edinburgh in 1784; a Fellow of the Royal Society of London in 1785; a corresponding member of the Batavian Society in 1787; and in 1808, a corresponding member, and afterwards a foreign member, of the Institute of France. The university of Glasgow conferred on him the degree of LL.D. in 1806. His statue, the funds for which had been raised by a public and almost a national subscription, was erected in Birmingham in 1824; and his statue is now to be seen in the streets of many of our larger towns. The honours paid to his memory and to himself in his later years appear to have been deserved by his personal qualities, no less than by the immeasurable benefits which his inventive talents have conferred upon the human race.

WATTEAU, ANTOINE, was born at Valenciennes, in the year 1684. In 1702, he betook himself to Paris, where for some time he worked as assistant to a scene-painter. When this employment failed him, by the retirement of his master from Paris, he employed himself in copying pictures. The talent which he shewed in this humble walk of the art drew the attention of Gillot, a popular painter of the day, who engaged him to assist in his studio. In no long time, it was found that the pupil excelled his master, who speedily relinquished the field in his favour, and became an engraver. The success of W. was now assured; he was made a member of the French Academy, and became by special favour *Peintre de Elles Galantes du Roi*. In 1718, he visited England, it is believed chiefly on account of his health, and to consult a certain Dr Meade, then famous, for whom, during his stay, he painted one or two pictures. He remained about a year, without, as it should seem, much benefit. After his return home, his health gradually declined; and in 1721, he died at Nogent, near Paris.

In virtue of their charming colour and graceful design, the pictures of W. continue to please, though his reputation as an artist is now but a faint echo of that which, in his lifetime, he enjoyed. He employed himself chiefly in painting small landscapes, with something of the nature of the *Fête Galante* going on in them—idylls in court-dress,

which, as preserving for us the fopperies of the time, are not without a certain value distinct from their properly artistic one.

**WATTLE.** See **ACACIA.**

**WATTLE-BIRD** (*Anthochaera carunculata*), an Australian bird, of the family of Honey-eaters (*Meliphagidae*). It is about the size of a magpie, grayish brown above, each feather striped, and bordered with white; the tail brown, long, wide, and graduated. It derives its name from a pendulous reddish wattle on each side of the throat. It feeds chiefly on honey and insects extracted from the flowers of *Banksias*, these trees continuing in flower most of the year. It is a bold and active bird, and drives away all other birds from the part of the tree which it occupies.

**WATTS, ISAAC**, was born on July 17, 1674, at Southampton, where his father had a boarding-school. He was educated at the grammar-school of his native place, and afterwards sent, at the age of 16, to an academy in London, kept by Mr Thomas Rowe, an Independent minister. Here his devotion to his studies was so excessive as to permanently injure his constitution. In 1696, he became tutor in the family of Sir John Hartopp, at Stoke-Newington, with whom he remained six years. During the latter part of this time, he officiated as assistant to Dr Chauncey, minister of the Independent Church in Mark Lane, to whose post he succeeded in 1702. His health was throughout infirm; and in 1712, he was prostrated by an illness so violent that he never thoroughly recovered from its effects, though he lived for many years afterwards. A visit which he paid to Sir Thomas Abney, at Theobalds, for change of air, resulted in his domestication in the establishment till his death, 36 years afterwards, on November 25, 1748. As his health permitted, he continued to discharge his clerical duties, and to occupy himself with literary pursuits. His theological works were numerous, but are now quite forgotten. His treatise on *Logic*, though long since superseded, had in its day a considerable reputation, and was adopted as a text-book by the university of Oxford. By his well-known Hymns for children, his reputation has been chiefly perpetuated. So lately as 1837, his *Hora Lyrica* were republished, with a Memoir by Southey. In Johnson's *Lives of the Poets*, a notice of him is likewise to be found.

**WATTS, THOMAS.** See **SUPP.**, Vol. X.

**WAUKEGAN**, a city and port of Illinois, on the west shore of Lake Michigan, 35 miles north-by-west from Chicago, and 50 miles south of Milwaukee, connected with both by railway. The town is handsomely built on a bluff, 50 feet above the lake, and has 6 churches, 2 academies, steam flour-mills, and considerable commerce. Pop. (1870) 4507.

**WAVE**, the name given to a *state of disturbance* propagated from one set of particles of a medium to the adjoining set, and so on; sometimes with, sometimes without, a small permanent displacement of these particles. But the essential characteristic is, that energy (see **FORCE**), not Matter (q. v.), is on the whole transferred. The theory of wave-motion is of the utmost importance in physical science; since, besides the tide-wave, waves in the sea, in ponds, or in canals, undulations in a stretched cord (such as a pianoforte wire), or in a solid (as sound-waves or earthquake-waves), we know that sounds in air are propagated as waves (see **SOUND**), and that even light (see **UNDULATORY THEORY**) is a form of wave-motion.

The general investigation of the form and rate of propagation of waves demands the application of

the highest resources of mathematics; and the theory of even such comparatively simple cases as the wind-waves in deep water (the Atlantic roll, for instance), though easily enough treated to a first, and even to a second and third approximation, has not yet been thoroughly worked out, as fluid friction has not been taken account of. In this article, therefore, we will merely state some of the more important conclusions which mathematical analysis has established in the more difficult of these inquiries, comparing them with the observations of Scott Russell and others; while we give at full length the very simple investigations of the motion of a wave along a stretched cord, and of the propagation of a particular kind of sound-wave.

To find the rate at which an undulation runs along a stretched cord, as, for instance, when a harp-string is sharply struck or plucked near one end, a very simple investigation suffices. Suppose a uniform cord to be stretched with a given tension in a smooth tube of any form whatever, we may easily shew that there is a certain velocity with which the cord must be drawn through the tube in order to cease to press on it at any point, that is, to move independently of the tube altogether. For the pressure on the tube is due to the tension of the cord; and is relieved by the so-called Centrifugal Force (see **CENTRAL FORCES**) when the cord is in motion.

If  $T$  be the tension of the cord,  $r$  the radius of curvature of the tube at any point, the pressure on the tube per unit of length is

$$\frac{T}{r}$$

If  $m$  be the mass of unit length of the cord,  $v$  its velocity, the centrifugal force is

$$\frac{mv^2}{r}$$

These are equal in magnitude, and so destroy each other, if

$$T = mv^2.$$

Hence, if the cord be pulled through the tube with the velocity thus determined, there will be no pressure on the tube, and it may therefore be dispensed with. If we suppose the tube to have a form such as that in the figure, where the extreme portions



Fig. 1.

are in one straight line, the cord will appear to be drawn with velocity  $v$ , along this, the curved part being occupied by each portion of the cord in succession: presenting something like the appearance of a row of sheep, in Indian file, jumping over a hedge.

To a spectator moving in the direction of the cord with velocity  $v$ , the straight parts of the cord will appear to be at rest, while an undulation of any definite form and size whatever runs along it with velocity  $v$ , in the opposite direction. This is a very singular case, and illustrates in a very clear manner the possibility of the propagation of a solitary wave.

Thus we have proved that the velocity with which an undulation runs along such a cord is

$$\sqrt{\frac{T}{m}}$$

If  $l$  be the length of the cord in feet,  $w$  its whole



weight,  $W$  the appended weight by which it is stretched,  $g = 32.2$  feet, the measure of the earth's gravity, this becomes

$$\sqrt{\frac{W}{w}} \cdot g.$$

This formula is found to agree almost exactly with the results of experiment. We can easily see why it should be to some small extent incorrect, because we have supposed the cord to be inextensible, and perfectly flexible, which it cannot be; and we have neglected the effects of extraneous forces, such as gravity, the resistance of the air, &c.

Let us next consider the motion of air in a cylindrical tube, in the particular case in which the leg of a vibrating tuning-fork is applied at one end. This is a simple case of the propagation of sound-waves. We shall treat it by a synthetical process, somewhat like that given by Newton.

As we have already seen (see PENDULUM), a simple vibration such as that of a pendulum or tuning-fork is the resolved part, in a definite line, of the uniform motion of a point in the circumference of a circle. What we have now to shew is, that such a motion of all the particles of air in the pipe, the *phase* of the vibration (or the position of the particle in its path at any instant) depending on its distance from the end of the tube, is consistent with mechanical principles. When this is done, it will be easy for us to trace, in this particular example, the process by which the wave is propagated from one layer of the fluid to the next. We must now consider (a little more closely than in PENDULUM or SOUND) the nature of the simple vibration of each particle of the air.

Suppose  $P$  to move, with uniform velocity  $V$ , in the circle  $APB$ , and let  $PQ$  be drawn perpendicular to the fixed diameter,  $OA$ . Then the acceleration of  $P$ 's motion is  $\frac{V^2}{OA}$  in the direction  $PO$ . Hence in the motion of  $Q$ , which is a simple vibration, we have, by the rule for resolving velocities and accelerations (see VELOCITY),

$$\text{Velocity of } Q = \frac{PQ}{OA} V \text{ in the direction } QO;$$

$$\text{Acceleration of } Q = \frac{OQ}{OA} \frac{V^2}{OA} \text{ in the direction } QO.$$

Next consider two particles of air near one another in the axis of the tube, or the masses of air in two contiguous cross-sections of the tube. If the phase of vibration were the same for both, they would be *equally* displaced from their original positions, and the air between them would be neither compressed nor dilated. Hence, that a wave may pass, the phases must be different. Let, then,  $Q$  represent the position of the one particle, or layer, in its line of vibration at any instant;  $Q'$ , the simultaneous position of the other.

The first will be displaced through a space  $OQ$  from its position of rest; the second, through a space  $OQ'$ ; and their distance will therefore be altered by the amount  $QQ'$ , which may be taken to represent the compression or dilatation. But it is easy to see that, as  $P$  and  $P'$  move round,  $QQ'$  is always proportional to  $PQ$ . Hence the compression or dilatation of the air in any cross-section of the tube is proportional to the

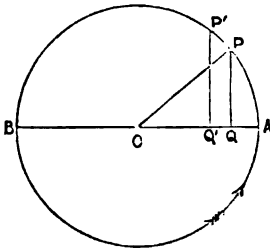

Fig. 2.

velocity with which it is moving. Hence the difference of pressures before and behind any such section is proportional to the difference of velocities—i. e., to the acceleration of the motion while the section passes over a space equal to its own thickness. And this is consistent with mechanical principles, for the *mass* of air in the section is constant, while the difference of pressures before and behind produces the acceleration, and should therefore be proportional to it. The particles of air in cross-sections of the tube therefore vibrate, each in the same period as does the tuning-fork, but the phase is *later* for each section in proportion to its distance from the fork. Where the phase is one or more whole vibrations later than that of the fork, the motion is exactly the same as that of the fork, and *simultaneous* with it. At all other points, it is the same as that of the fork, but not simultaneous. Thus, the greatest displacement of the fork is immediately shared by the layer next it, later by the next layer, and so on. Thus, a *wave* of displacement travels along the tube from one section to the next, while each particle merely oscillates backward and forward through (in general) a very small space about its position of rest.

The reader who has followed the little geometrical investigation above will have no difficulty in proving for himself that the velocity with which the wave travels is proportional to

$$\sqrt{\frac{p}{\rho}},$$

where  $p$  is the pressure, and  $\rho$  the density of the air. The easiest mode of doing this is to express, in terms of these and other quantities, the equation given us by the laws of motion,

$$\text{Mass} \times \text{Acceleration} = \text{Difference of pressures,}$$

and to assume that Hooke's (q. v.) Law holds, even during the *sudden* compression of air. This, we know, is not the case; so that a correction has to be applied to the above expression, depending on the heat developed by sudden compression or lost in sudden rarefaction, by each of which the elastic force of the air is *increased*. But this has been already discussed in SOUND.

The above formula shews us, however, that the velocity of sound is not affected by the pressure of the air—i. e., the height of the barometer—since, in still air,  $p$  is *proportional* to  $\rho$ . The velocity does depend on the temperature, being, in fact, proportional (*ceteris paribus*) to the square root of the temperature measured from absolute zero. See HEAT.

We see also from the formula that the velocity is inversely as the square root of the density of the gas—the pressure being the same. Thus, a sound-wave travels about four times faster in hydrogen than in air.

Also we see that, within the limits of approximation we have used, the velocity does not depend upon the intensity, pitch, or quality of the Sound (q. v.). The investigations which seem to lead to slight modifications of this conclusion are too recondite to be introduced here. We can only mention, also, the beautiful investigations of Stokes (q. v.) connected with the extinction of a sound-wave as it proceeds, partly by fluid friction, partly by radiation. And we may conclude by stating that the result of a completely general investigation of the velocity of a sound-wave gives, to a first approximation, the result we have deduced from the study of a simple particular case.

We now come to the consideration of waves in water. Of these, there are several species. One, however, we may merely mention, as its theory is

the same as that just briefly discussed. This is a sound-wave, or *wave of compression*, in water. Its velocity is considerably greater than that of sound in air (see SOUND). The others, which are commonly observed on the surface of water, depend on mere changes of level, and their effects; and in studying them, we may consider water as incompressible.

The first of these is what is called a *long or solitary wave*. Its essential characteristic is, that its length is great compared with the depth of the liquid in which it moves. To this class belong the tide-wave (see TIDES), and the long wave which accompanies a canal-boat, and which we see slowly traversing the canal when the boat is stopped. Scott Russell has made many interesting observations on this wave, all of which accord well with the results of the mathematical theory of its propagation. The velocity of this wave depends solely on the depth, not on the density of the liquid in which it moves—and in a uniform canal the velocity is that which would be acquired by a stone falling freely through a space equal to half the depth of the water. Another characteristic of this wave is that, after it has passed, it leaves the water bodily transferred through a small space along the bed of the canal—forwards or backwards, according as it consists of an elevation or a depression of the water-surface. Scott Russell has shewn that the most favourable rate at which a canal-boat can be drawn is when its velocity is such that it rides on the crest of the solitary wave. If drawn at any other speed, it leaves the solitary wave behind, or is left by it; and in either case, part of the horse's work is expended in producing fresh solitary waves. An excellent mode of observing these waves is to tilt slightly a rectangular box containing some water, and restore it to its original position. A long wave is thus formed, which is reflected repeatedly at the ends of the box, and whose rate of motion may be accurately observed by watching the image of a candle reflected at the surface of the water. If the sides of the box be made of glass, and some light particles be dispersed through the water, their motions enable us to discover all the circumstances of the propagation of this wave.

We next come to what are called *oscillatory waves* in water or other liquids. To this class belong all waves whose length from crest to crest is small compared with the depth of the liquid; from ripples on a pool to the long roll of the Atlantic. They are never observed as solitary waves, their general characteristic being their periodical recurrence. And, by watching a piece of cork floating on the surface, we see that it moves forwards when at the crest of the wave, and backwards through an equal amount when in the trough. Also it rises while passing from trough to crest, and sinks from crest to trough. Mathematical investigation, confirmed by experiments with floats at sea, and with short waves in the glazed box before described, shews that each particle of the water describes a *circle* about its position of rest in the vertical plane in which the wave is advancing. Particles at greater and greater depths describe smaller and smaller circles. The diameters of these circles diminish with extreme rapidity. At a depth equal to the distance from crest to crest (i. e., the length of the wave), the displacement of the water is already only  $\frac{1}{11}$ th of that at the surface. At the depth of two wave-lengths, it is about  $\frac{1}{150}$ th of that at the surface. Thus we may see to how small a depth the ocean is agitated even by the most tremendous wind-waves; for, according to Scoresby, 43 feet is about the utmost difference of level between crest and trough in ocean-waves. If

the wave-length be 300 feet (which is a large estimate), then at a depth of 300 feet the water-particles describe circles whose radii are only the  $\frac{1}{11}$ th of a foot, or about four-tenths of an inch; and at 600 feet this is reduced to  $\frac{1}{150}$ th of an inch; while the depth of the Atlantic is in many parts more than three or four miles. In this case, the velocity of propagation of the wave has been shewn to be

$$\sqrt{\frac{gl}{2\pi}}$$

where  $g$  is, as before, 32.2 feet;  $l$  is the wave-length in feet; and  $\pi$  is the ratio of the circumference of a circle to its diameter (see QUADRATURE OF THE CIRCLE). Thus, the velocity of an oscillatory wave in deep water is proportional to the square root of its length. This fact has been of use as an analogy in helping us to account for the *Dispersion* (see REFRACTION) of Light, where, by experiment, we know that the waves of red light are longer than those of blue light, and also that they travel faster in refracting media.

When the depth is not infinitely great compared with the length of a wave, theory and experiment agree in shewing that the motion of each particle takes place in an ellipse whose major axis is horizontal. These ellipses diminish rapidly in length as we descend in the liquid, but still more rapidly in breadth; so that, as was to be expected, the particles at the bottom oscillate in horizontal straight lines. The expression for the velocity of propagation is now by no means so simple as in the previous cases—but is easily shewn to include the values already given.

So far, the first approximation. A section of the surface made by a vertical plane in the direction of the wave's motion, is shewn to be bounded by the *Harmonic Curve*, or *Curve of Sines*, the form assumed by a vibrating string (see SOUND); from which it follows that the crests are similar to the troughs. The second approximation makes the troughs flatter, and the crests steeper, and also shews that the particles are, on the whole, carried *forward* by each successive wave. The amount of this progression diminishes rapidly with the depth below the surface. A third approximation shews that the velocity is, *ceteris paribus*, greater the greater is the height of the waves.

When waves advance towards the shore, their circumstances change, in general gradually, from those of oscillatory waves to those of waves of translation, as the depth of the water becomes less and less considerable in comparison with the length of the wave; and it is found by experiment that they 'break,' as it is called, when the depth of the water is about equal to the height of the crest above the undisturbed level. All the curious phenomena of breakers are thus easily explained by the results we have already given, when they are considered with reference to the gradual alteration of the depth of the water.

Finally, we must notice a singular phenomenon often observed, viz., that of a series of waves breaking on the coast, every eighth, or ninth, or tenth, &c. is seen to be higher than its predecessors or successors. The explanation is simple enough, and points to the simultaneous existence of two or more sets of oscillatory waves of different lengths, due in general to quite distinct causes, which reach the shore together.—For further information on this subject the reader is referred to papers by Stokes in the *Cambridge and Dublin Math. Journal*, vol. iv., and the *Cambridge Phil. Trans.*, vol. viii., and to Airy's 'Tides and Waves' in the *Encyclopædia Metrop.*

This might lead us to consider the very interesting

case of 'Co-existence of Small Motions' presented by the Interference (q. v.) of such waves; but we have already in various articles (see POLARIZATION, SOUND, UNDULATORY THEORY) given sufficient examples to illustrate the great principle.

There remains the consideration of the propagation of waves in elastic solids, among which, at least so far as luminiferous vibrations are concerned, it appears that the Ether (q. v.) must be ranked. This is a subject of a higher order of difficulty than any of those before mentioned, and, in the case of light at least, has not yet been treated in a thoroughly satisfactory manner, though such men as Cauchy, Neumann, Macculagh, Green, and Stokes have written profound memoirs upon it.

WAVRE, a town in the province of South Brabant, Belgium, 15 miles south-east of Brussels, has a pop. of 5900, who are mostly engaged in the manufacture of hats, leather, and cotton-yarn. W. is better known as the scene of a desperate and protracted conflict between the French and Prussians, on the 18—19th June 1815. The former, under Grouchy, Gerard, and Vandamme, advanced against the Prussians at the same time as Napoleon directed the troops under his immediate orders against Wellington at Waterloo (q. v.), and being much superior in number (32,000 to 15,200), drove the Prussians, under Thielman, into W., where they defended themselves with desperate firmness, repulsing thirteen different assaults in the course of the 18th. On the following morning, Thielman, who, had heard of the victory at Waterloo, attacked Grouchy, but was repulsed with vigour, though the urgent orders of Napoleon forced the latter to retreat to Laon, instead of following up his success.

WAX. Under this term, chemists include various matters of a well-known (so-called waxy) appearance, derived both from the animal and the vegetable kingdoms. While in their general relations they approximate to the Fats, they differ materially from the latter in their chemical composition; those of them which have been carefully examined, being found to consist partly of mixtures of alcohols and compound ethers, and partly of free fatty acids. Their general properties may be thus laid down: They are solid or semi-solid matters; are easily broken when cold, but at a moderate warmth are soft and pliable, and fuse at a temperature below 212°. They have a peculiar glistening appearance, are lighter than water, are insoluble in that fluid and in cold alcohol, but dissolve readily in ether; they are combustible, and burn with an illuminating flame, are non-volatile, and when heated in a free atmosphere, undergo decomposition. In this category are included spermaceti (which has been already considered), bees' wax, Chinese wax, and other less known kinds, as palm or vegetable wax (obtained from the bark of *Cerocylon andicola*, by the action of hot water and pressure), Carnahuba wax (an exudation from the leaves of a Brazilian palm), sugar-cane wax, &c.

Bees' wax is an animal secretion formed by the bees from sugar, and constitutes the material of which the cells of the honey-comb are composed. It is obtained by expressing the honey, and fusing the residue in boiling-water. In this state it is of a yellow colour (*Cera flava*). It may be bleached, so as to form white wax (*Cera alba*), by being exposed in thin slices to the action of solar light, or by the action of nitric acid. (Chlorine readily destroys the colour, but renders the wax unfit for candle-making, as a portion of the hydrogen of the wax is replaced by chlorine, and the candles, when burning, evolve irritating vapours of hydrochloric acid gas.) From the researches of Sir B. Brodie (*Phil. Trans.*, 1848, 1849),

it appears that wax consists of three different substances, *myricin*, *cerin*, and *cerolein*, which are separable from one another by means of alcohol. *Myricin*, which is insoluble in boiling alcohol, constitutes more than two-thirds of the bulk of ordinary wax. *Cerin*, or *cerotic acid*, which dissolves in boiling alcohol, but separates on cooling, varies in quantity in different specimens. In one sample of genuine bees' wax, Brodie found that it constituted 22 per cent, and it was always present in European samples, while in Ceylon wax it was entirely absent. This curious variation in the nature of an animal secretion, under different conditions of life, resembles the variations sometimes noticed in the acids of butter, in which the butyric and caproic acids of one season are replaced in another by vaccinic acid, differing from the former acids in the amount of oxygen alone. *Cerolein*, the substance soluble in cold alcohol, is a greasy body, constituting 4 or 5 per cent. of ordinary wax. Without entering into chemical details, we may observe that bees' wax yields the following derivatives: Cerotic acid or cerin,  $\text{HO}, \text{C}_{26}, \text{H}_{52}, \text{O}_2$ ; cerylic alcohol or cerolin,  $\text{HO}, \text{C}_{26}, \text{H}_{50}, \text{O}$ ; melissylic alcohol or melissin,  $\text{HO}, \text{C}_{26}, \text{H}_{50}, \text{O}$ ; melissic acid,  $\text{HO}, \text{C}_{26}, \text{H}_{48}, \text{O}_2$ ; palmitic acid,  $\text{HO}, \text{C}_{16}, \text{H}_{32}, \text{O}_2$ ; myricin,  $\text{C}_{20}, \text{H}_{40}, \text{O}_4$ ; and melene,  $\text{C}_{10}, \text{H}_{20}, \text{O}_2$ .

*Chinese Wax* ( $\text{C}_{100}, \text{H}_{190}, \text{O}$ ) is supposed to be the produce of a species of insect of the Coccus family, and consists principally of cerotic acid, in combination with oxide of ceretyl.

Both yellow and white bees' wax occur in the Pharmacopoeia. The characters and tests, as given in that work, are—*Of yellow wax*: 'Firm, breaking with a granular fracture, yellow, having an agreeable honey-like odour; not unctuous to the touch, does not melt under 140°, yields nothing to cold rectified spirit, but is entirely soluble in oil of turpentine; boiling-water in which it has been agitated, when cooled is not rendered blue by iodine.' *Of white wax*: 'Hard, nearly white, translucent; not unctuous to the touch, does not melt under 150°.' The iodine test is used because wax is often adulterated with starch. Wax was formerly much employed internally as an emollient medicine, in cases of suspected ulceration of the intestines. At present, it is only used as an external agent, being an ingredient of many ointments and plasters.

The commercial value of bees' wax is very great; and if it were possible to ascertain the total of the quantity produced, it would cause great surprise at the amount of valuable material derived from a source apparently so insignificant. Its chief uses are for candles, modelling, medicinal cerates or ointments, besides many minor purposes. Nearly 500 tons are annually imported into Great Britain, the value of which is about £80,000; but so large is the quantity consumed in the ceremonies of the Greek and Roman churches, that Russia alone consumes more than four times that amount, and the various Catholic countries probably ten times as much. The *INSECT WAX* of China, or *Pe-la*, has lately been imported in small quantities, and used in the manufacture of candles by Messrs Price & Co.; but it is far too costly for general use (see *WAX INSECT*). In China, this wax is very highly valued, and is so costly as to be used only by the highest classes; it is white, and breaks with a crystalline fracture and pearly lustre. *Of Vegetable Wax*, there are four distinct kinds known in commerce. The first in importance is the *JAPAN WAX*, which is almost as white and compact as refined bees' wax, which it closely resembles; it was first brought to Great Britain in 1859, and since then, some very considerable importations have taken place. It is said to be obtained by boiling the seeds of a species of *RHUS* (*R. succedanea*). It

has only been used in making candles. **BRAZILIAN VEGETABLE WAX** is also an article of regular importation, but only in small quantities; it is obtained from the leaves of *Corypha cerifera*, the Carnahuba Palm of the Brazilians. It forms a glossy varnish-like covering; and when the leaves are gathered, and begin to shrink from withering, it cracks and peels off, and is collected and melted into masses. It is hard and brittle, and of a dull yellow colour. The candlemakers have used it for mixing and improving other materials. In Brazil, candles are wholly made of it, or half the quantity of stearine is added. The **VEGETABLE WAX** of the Andes is also yielded by a palm (see **WAX PALM**). Although much used in Mexico, it has not yet become of commercial importance to Europe. It is chiefly used for candles in the churches. **MYRTLE WAX**, though rarely seen in Europe, is much used in the British colonies of North America, and the United States, and at the Cape of Good Hope; it is also in use in Brazil. It is procured by boiling the berries of *Myrica cerifera* in North America, and probably from other species in Brazil, and at the Cape of Good Hope. It resembles bees' wax very much, except that it has a greenish-yellow instead of a yellow colour. It is only used for candle-making. See **CANDLEBERRY**.

Of the manufactured compounds called wax, the following are the chief—viz., **SEALING-WAX** (q. v.). **MODELLERS' WAX**, used by artists for modelling small works. It consists of equal parts of bees' wax, druggists' lead-plaster—olive oil and yellow resin, and just sufficient whitening added to produce the consistency of putty. **GILDERS' WAX** consists of four parts of bees' wax, well mixed by melting with one part each of verdigris and sulphate of copper.

The bees' wax of commerce is of a dirty yellow colour, and mixed with many impurities. It has, consequently, to undergo a process of bleaching, by which it is rendered quite white and pure. The usual process is to melt the wax with boiling-water, and stir them together for a short time, so as to separate the impurities from the wax. It is then allowed to rest for a short time, and the pure wax floats on the top; and when cold, is taken off in a cake, the lower part of which is often discoloured with the dirty water. This is scraped off, and mixed with the next lot to be operated upon. The purified portion is next remelted, and is then allowed to trickle from the melting-pan on to a wooden cylinder, revolving rapidly, and partly immersed in pure cold water, in a large cistern. This throws it into the water in the form of fine thin feather-like flakes, which cool and harden instantly in the water. When all is run off, the wax is removed from the water, and laid on linen cloths, placed on tables in a field for the air to bleach. From time to time, the flakes are turned over and examined; and when the bleaching effect of the air seems to have stopped, the wax is remelted, and converted into flakes in the cistern, and replaced in the bleaching-ground until it is quite white.

**WAX, MINERAL**, is a natural product known under the name of Ozokerit. It used only to be found in small quantities oozing from rocks of coal formation, though near Edinburgh, candles, as curiosities, were made of it by the miners. Lately, however, immense deposits of the hydrocarbon have been found in several parts of Europe, chiefly in Galicia and Moldavia, and it has now become a commercial article for the manufacture of candles. When found, it has a dark, rich-brown colour, slightly greenish and translucent in thin films; but when refined, it resembles well-bleached beeswax. Its melting-point is about 60°.

**WAX-CLOTH**, a name sometimes given, but very erroneously, to **FLOOR-CLOTH** (q. v.).

**WAX-FLOWERS**. An elegant use is found for bees' wax in the manufacture of wax-flowers. The wax for this purpose is bleached and prepared in thin sheets of various colours, which are cut out into the shapes for petals and leaves, according to the kind of flower to be imitated. They are easily made to adhere, either by a slight amount of heat, or a little melted wax.

**WAX INSECT** (*Coccus sinensis*; see **Coccus**), a very small white insect, a native of China, of the same genus with the Cochineal and Kermes insects, and with the Scale insects, which are the pest of our greenhouses, valuable on account of the wax which it produces. It is found about the beginning of June on the branches of certain trees, on the juices of which it feeds, particularly on those of a kind of Sumach (*Rhus succedaneum*). The wax is deposited on the branches as a coating which resembles hoar-frost. This is scraped off towards the end of August, melted in boiling-water, and strained through a cloth. See **WAX**. The Chinese W. I. has been introduced by the French into Algeria.—Another W. I. is found in South America, but is not yet well known, nor has its wax become an article of commerce.

**WAX MYRTLE**. See **CANDLEBERRY**.

**WAX-PAINTING** is an art of great importance, better known, however, under the name of **Encaustic Painting** (q. v.).

**WAX PALM** (*Ceroxylon*—or *Iriartea*—*andicola*), a lofty palm, found in the Andes, on the eastern borders of Peru, at an elevation of 3000 feet and



Wax Palm (*Ceroxylon andicola*).

upwards above the level of the sea. It grows to the height of 160 feet, and on the cicatrices of the fallen leaves, a resinous secretion is produced in great abundance, composed of about two parts of yellow resin, and one of a kind of wax, more brittle than bees' wax. This wax exudes also from the leaves, and is whitish, almost inodorous, except when heated, when it gives out a resinous odour. It is used by the inhabitants of the country in which it is produced for making candles, but is usually mixed with wax or tallow. It is probable that the W. P. would succeed well in the south of Europe, as its native climate is not dissimilar. The usual method of obtaining the wax is by falling the tree. Each tree yields about 25 lbs. The

wax is scraped off, melted, and run into calabashes. The timber of this palm is very hard and durable; the leaves are used for thatching, and the fibres for cordage. The tree is a beautiful one, with a stately stem, and a head of large pinnate leaves.—In some of the northern provinces of Brazil, wax is obtained from the Carnahuba Palm (q. v.).

**WAX-SCULPTURE.** The use of wax for sculpture is believed to be of very ancient origin; and not only have the tombs of Southern Italy yielded many specimens of the portraits of the deceased modelled in wax, but many fine bronzes in antiquarian collections bear evident marks of having been modelled in wax by the process called *cire-perdue*. This consists in producing a model in wax, and then coating it with clay or other material in a soft state; this is allowed to harden; and the wax is then melted out by heat, and the molten metal poured in. A very fine cast of the wax-figure is thus obtained; but, of course, the wax-model of the artist is lost, after the first copy is taken; hence, such specimens are very highly prized by connoisseurs. During the 14th and 15th centuries, the art of modelling in wax, or ceroplastics, was much practised, especially in Italy and in Germany, by many of the first artists, even Michael Angelo not excepted; and many of their original works in wax are still preserved. They were chiefly, however, in low relief, although very fine statuettes were also produced by men of great eminence.

**WAX-TREE** (*Vismia*), a genus of plants of the natural order *Hypericaceae*, having a 5-parted calyx, and 5 petals, generally covered with soft hairs on the inside. All the species yield a yellow viscid juice when wounded, which, when dried, becomes somewhat similar to gamboge. The species are natives of the tropical parts of America.

**WAXWING** (*Bombycilla*), a genus of birds of the family *Ampelidæ*, or Chatterers (q. v.), having a short, straight, elevated bill, with a very wide gape, as in the Fly-catchers, but without bristles; both mandibles notched at the tip; the wings rather long, broad, and pointed; the legs short; the toes



Bohemian Chatterer (*Bombycilla garrula*).

long, with sharp and curved claws. The name *W.* is derived from a very peculiar character, which the wings exhibit; some of the secondaries and tertiaries terminating in horny expansions of the shaft, resembling small pieces of red sealing-wax. The species are few, but widely diffused over the colder parts of the northern hemisphere. The only European species is the EUROPEAN *W.*, or BOHEMIAN CHATTERER (*B. garrula*), which is found in summer in the arctic regions of Europe, Asia, and America, migrating southwards in winter,

sometimes as far as the shores of the Mediterranean; most abundant in America, during winter, about the great lakes and the northern part of the Valley of the Mississippi. It is found also in Japan. It is only an occasional winter-visitant of Britain. In some winters, numerous flocks are seen; in other winters, and more generally, none at all. It is in severe winters that this bird is most frequently seen in Britain, and in the more southern parts of Europe. It is gregarious in winter, and the flocks are often large. It feeds on insects and worms, seeds, berries, and other fruits. It is a handsome bird, nearly as large as the Song Thrush; reddish gray, with a black patch on the throat, and a black band on the forehead; the tail-coverts brownish orange; the primaries, secondaries, and tail-feathers tipped with yellow, two white bands on the wings; the lower parts silvery gray. The head is surmounted by an erectile crest of brownish orange feathers. The song of the *W.* is a weak whistling, bearing a little resemblance to that of the thrush. It is easily tamed. The flesh is said to be delicate food.—The AMERICAN *W.*, or Cedar Bird (*B. cedrorum*, or *Carolinensis*), is a very similar, but smaller species, found only in North America, from Canada to Central America, less migratory, and never visiting arctic regions. The general colour is reddish olive, passing into purplish cinnamon in front, and into ash-colour behind; the chin black; no white on the wings; the lower parts yellow. It is crested like the European Waxwing. Great flocks of cedar birds collect in the end of summer. They feed on berries, and are particularly fond of those of the Red Cedar. The Cedar Bird is extremely voracious, and when food abounds, sometimes gorges itself so much, that it may be taken by the hand. It is in much esteem for the table.—Another species is found in Japan, having no waxy drops on the wings.

**WAXY DEGENERATION** is a morbid process in which the healthy tissue of various organs is transformed into a peculiar substance, allied in some respects to amyloid compounds, and in others to albuminous substances. Organs affected by this degeneration have a certain resemblance in consistency and physical character to wax. They may be cut into portions of the most regular shape, with sharp angles and smooth surfaces; and the thinnest possible slices may be removed by a sharp knife for microscopical examination. Such organs are abnormally translucent, increased in volume, solidity, and weight. Usually, the first parts affected by this degeneration are the small blood-vessels, the middle or muscular coat being first changed. Subsequently, the secreting cells become similarly affected. When a solution of iodine is brought in contact with such tissues, a very deep violet red colour is produced; and this deep red colour is alone a sufficiently characteristic test. Although amyloid degeneration is common to many tissues and organs, the parts most frequently affected are the spleen, liver, and kidneys. This morbid condition in one or more organs is the expression of a general pathological state, the conditions and relations of which are as yet but little known.

**WAYLAND**, the Smith (Ang.-Sax. *VELAND*; old Norse, *VÖLUNDR*; Ger. *WIELAND*), was, according to the old German Saga (the principal traits of which are already contained in the older Edda, but which is related in the most detailed form in the *Viltinasaga*), a son of the sea-giant Wate, a nephew of King Wilkinus, and of the sea-nymph Wac-hilt. His father had bound him, at first, apprentice to the celebrated smith Mimi, then took him across the sea to the most skilful dwarfs, from

whom he not only soon learned all their science, but far surpassed them.\* He afterwards dwelt a long time in Ulfdalet (the Wolf's Valley, which, by comparison with other Sagas, appears to correspond to the Greek Labyrinth) along with his two brothers—Egil, the best archer, to whom the oldest form of the Tell legend attaches; and Slagfidr, whom the saga has not further characterised. The brothers here met three swan-nymphs, and lived with them for seven years, when they flew away to follow battles as Walkyries (q. v.). Afterwards, W. came to King Nidung, who made him lame, by cutting the sinews of his feet, and put him in prison, for which W. revenged himself by putting the king's two sons to death, and violating his daughter Beadohild, who afterwards gave birth to Wittich, a powerful champion of the German hero-legends. W. then flew away in a feather-robe, which he himself manufactured, and which his brother Egil had tried first, but was precipitated to the ground. Skilfully putting together and supplementing the various old legends, Simrock has produced the Saga of W., as a whole, in his poem *Wieland der Schmied* (Bonn, 1835), and in the 4th part of his *Heldenbuch* (Stuttgart, 1843). The legend was a favourite one among all the Germanic nations, as is shewn by the frequent allusions to it in Scandinavian, Anglo-Saxon, English, and German poems, as well as by the numerous fragments yet extant in oral tradition throughout all Teutonic countries. The German poems to which the Völsunga saga alludes, which were in existence up to the 13th c., have been utterly lost. Even beyond the bounds of Germany, old French poems and traditions tell of Gallans the smith. See Depping and Michel, *Veland le Forgeron* (Paris, 1833). The legend of W. is in fact one of those myths common to the Indo-Germanic family. Besides the German tradition, it is found most distinctly among the Greeks, in the different stories of Dædalus, Hephaestus, Erichthonius, and so forth. Next to Jacob Grimm's profound discussion in the *German Mythology*, Kuhn has pointed out in the best manner the signification and ramifications of the myth in his treatise, *Die Sprachvergleichung und die Urgeschichte der Germ. Völker*, in the *Zeitschrift für vergleichende Sprachforschung* (vol. iv., Berl. 1854).

WAYNE, ANTHONY, an American general of the war of the Revolution, was born at Waynesborough, Pennsylvania, January 1, 1745. His grandfather, a native of Yorkshire, commanded a squadron of dragoons at the battle of the Boyne, and emigrated to Pennsylvania. Anthony was educated at Philadelphia; at the age of 18, he was employed as a land-surveyor, and was selected by Benjamin Franklin to form a projected settlement in Nova Scotia. At the beginning of the American revolution (1775), he was married and settled on a farm in Pennsylvania, taking an active interest in politics, and became a member of a Committee of Safety, and studied military drill and tactics. At the outbreak of hostilities, he raised a regiment of volunteers, of which he was appointed colonel, and sent to Canada, where he covered the retreat of the provincial forces at Three Rivers. He commanded at Ticonderoga until 1777, when he was made Brigadier-general, and joined Washington in New Jersey; commanded the rearguard in the retreat at Brandywine; led the attack at Germantown; captured supplies for the distressed army at Valley Forge; distinguished himself at Monmouth; was defeated at Paoli; but achieved the most brilliant

victory of the war in the storming of Stony Point (q. v.), July 15, 1779. His courage and skill saved Lafayette in Virginia in 1780; and he aided in the siege of Yorktown, and commanded in Georgia. At the close of the war, rewarded by popular enthusiasm, and having, by his dash and audacity, acquired the sobriquet of 'Mad Anthony,' he retired to his farm at Waynesborough, and engaged in promoting the construction of roads and canals. In 1792, he commanded a successful expedition against the Indians of the north-western territories; where he remained, until 1796, as United States' Commissioner. He died at the garrison at Presque Isle (now Erie), December 14, 1796.

WAYS AND MEANS, COMMITTEE OF, a committee of the House of Commons appointed to determine the modes of raising the money which the House—after resolutions reported from the Committee of Supply, and agreed to—has granted to the crown. Like the Committee of Supply, it is always a committee of the whole House. A chairman, elected by the Committee of Supply, but known as the Chairman of the Committee of Ways and Means, presides over both committees. One of the most important occasions for which the Committee sits is to receive the Budget, or annual financial statement of the year from the Chancellor of the Exchequer. The propositions of the government regarding loans, duties, taxes, tolls, and any other means for raising revenue, are submitted to the consideration of the Committee of Ways and Means in the shape of resolutions. The amount proposed to be raised must not exceed the sum granted in the Committee of Supply; and the Chancellor of the Exchequer is bound to satisfy the House, by a detail of the sums granted for the several services, that the amount of these sums will be a sufficient justification, in point of quantity, to the Committee of Ways and Means to adopt such measures and impose such taxes as shall then be recommended. Such resolutions as are agreed to are adopted and embodied in bills, and in due time become law. See SUPPLY, COMMITTEE OF; PARLIAMENT.

WEALDEN FORMATION, a series of freshwater strata belonging to the lower Cretaceous epoch. Having been originally studied in the parts of Kent, Surrey, and Sussex called the Weald, this local name was given to the formation. It has been divided into two series, which do not differ very materially from each other, viz., Weald Clay, 560 feet; Hastings Sand, 740: total, 1300. The Weald Clay consists of blue and brown clay and shale with thin beds of sandstone and shelly limestone. These strata were probably lake or estuary deposits, and contain the remains of the land flora and fauna, often in great abundance. The beds of limestone, called Sussex Marble, are almost entirely composed of a species of *Palaudina*, not very different from the common *P. vivipara* of English rivers. The clays are often laminated by thin layers, consisting of immense numbers of the shells of minute *Cyprides*. But the most remarkable animal remains are those of the huge reptiles which lived on the land, tenanted the air, or abounded in the sea, such as the Iguanodon (q. v.), Hylæosaurus (q. v.), Pterodactyl (q. v.), and the numerous species of turtles which have been described from these strata. The vegetable fossils belong chiefly to ferns, and to the gymnospermous orders of Conifers and Cycads; the fruits of several species of both orders have been found; and in some places, the rolled trunks of *Endogenites* and *Clathraria*, belonging to Cycads, and of different species of coniferous wood, occur in enormous quantities, as at Brook Point, in the Isle

\* The name Wayland is from a root signifying art, cunning; from which come Eng. *wile* and (through old Fr.) *guile*. Ang.-Sax. *velan* means to fabricate.

of Wight, where the shore at low-water is strewn with them.

The Hastings beds contain more sandstone and less clay than those of the upper Weald Clays. The picturesque scenery of the High Rocks and other places in the neighbourhood of Tunbridge, is weathered out of the beds of white sandstone belonging to this period. The remains of the huge Wealden reptiles abound in the sandstones of this division. The Tilgate forest-beds, where Dr Mantell first found the Iguanodon, and the rocks in the neighbourhood of Hastings, are the best known repositories of those remarkable fossils.

The deposition of the Wealden beds was followed by a gradual depression of the land, when these fresh-water deposits were covered by the estuary beds of the newer Greensand. The depression continued until the fresh-water and estuary strata formed the bottom of a deep sea, on which were deposited the immense beds of chalk and allied strata which form the bulk of the Cretaceous series. In the process of elevation, these beds have suffered denudation, so that districts which were covered with Cretaceous beds have been cleared of them, and immense valleys have been furrowed through the Chalk, Greensand, and Wealden.

**WEALTH.** See CAPITAL.

#### WEANING, AND FEEDING IN INFANCY.

The propriety of mothers nursing their own children is now so universally acknowledged, that it is the duty of the physician less frequently to urge maternal nursing than to indicate those cases in which it becomes necessary to substitute another mode of rearing the infant. 'Women,' says Dr Maunsell, 'who labour under any mortal or weakening disease—as phthisis, hæmorrhages, epilepsy—are obviously disqualified from the office of nurse. Some who are in other respects healthy, have breasts incapable of secreting a sufficient supply of milk. In other instances, the breast may perform its functions well, but the nipple may be naturally so small, or may be so completely obliterated by the pressure of tight stays, as not to admit of its being laid hold of by the child. These are actual physical hindrances to nursing. Again, women may, and, in the higher classes, frequently do, possess such extremely sensitive and excitable temperaments, as will render it imprudent for them to suckle their own children. Frightened and excited by every accidental change in the infant's countenance, and inordinately moved by the common agitations of life, such persons are kept in a state of continual fever, which materially interferes with the formation of milk both as to quantity and quality. Women, also, who become mothers for the first time at a late period of life, have seldom the flexibility of disposition or the physical aptitude for the secretion of milk, required to constitute a good nurse.'—*A Treatise on the Management and Diseases of Children*, 4th ed., 1842, pp. 39, 40. In ordinary cases, the child should be put to the breast as soon as the latter begins to contain anything; and when the secretion of milk has fairly commenced, it will require no other food until the seventh or eighth month, provided the mother be a good nurse. During the first five or six months, the infant should be put to the breast at regular intervals of about four hours; afterwards, when the teeth are beginning to appear, the child need not suck more than four times in the twenty-four hours, some artificial food being given to it twice during the same period. This at first may consist of soft bread steeped in hot water, with the addition of sugar and cow's milk; and subsequently a little broth, free from salt and vegetables, may be given once a day. The spoon is now

the best medium of feeding, as the food should be more solid than could be drawn through the sucking-bottle. The time of weaning should be that indicated by nature, when, by providing the child with teeth, she furnishes it with the means of obtaining its nourishment from substances more solid than milk. If the infant has been gradually accustomed to a diminished supply of maternal and an increase of artificial food, weaning will be a comparatively easy process; and much of that suffering both to parent and child will be spared, which commonly ensues when a sudden change is made. In ordinary cases, the period of weaning varies from the seventh to the twelfth month; sometimes the child is kept at the breast for a much longer period, from the popular idea that lactation prevents pregnancy, but such unnaturally prolonged lactation is usually injurious to both mother and child.

In those cases in which it is inexpedient or impossible for a mother to suckle her own child, the choice of a wet-nurse becomes a subject of much importance. Upon this subject, Dr Maunsell lays down the following important practical rules: 'The great thing we have to look to is to ascertain that both the woman and her child are in good health; and of this we must endeavour to judge by the following signs: The woman's general appearance and form should be observed, and they ought to be such as betoken a sound constitution. Her skin should be free from eruptions; her tongue clean, and indicating a healthy digestion; her gums and teeth sound and perfect; the breasts should be firm and well formed—not too large or flabby—and with perfect, well-developed nipples. We should see that the milk flows freely, upon slight pressure; and we should allow a little of it to remain in a glass in order that we may judge of its quality. It should be thin, and of a bluish-white colour; sweet to the taste; and when allowed to stand, should throw up a considerable quantity of cream. A nurse should not be old, but it is better that she should have had one or two children before, as she will then be likely to have more milk, and may be supposed to have acquired experience in the management of infants. Having examined the mother, we must next turn to the child, which should be well nourished, clean, and free from eruptions, especially on the head and buttocks. We should also carefully examine its mouth, to ascertain that it is free from sores or aphthæ. If both woman and child bear such an examination, we may with tolerable security pronounce the former to be likely to prove a good nurse.'—*Op. cit.*, pp. 44, 45. In one respect, we differ from this eminent physician. He holds that 'the more recently the nurse's own confinement has taken place, provided she has recovered from its effects, the better.' Supposing a nurse is required for a new-born infant, this rule holds good; but provided a nurse is required for an infant of three or four months old (for example), it is preferable to obtain a nurse whose milk is of that age. We believe it to be a general physiological law that the age of the milk should correspond to the age of the infant; that is to say, that an infant taken at any given age from its mother, before the normal period of weaning, should be provided with a nurse who was confined about the same time as its own mother.

A wet-nurse should be very much preferred to any kind of artificial feeding; but peculiar cases may occur in which it is impossible to procure a nurse; or an infant whose mother is incapable of nourishing it may be the subject of a disease that may be transmitted through the infant to the nurse. In these cases, a food must be provided as nearly as possible resembling the natural food; and this is naturally

## WEANING—WEASEL.

sought for among the food of animals. The milk of the cow is most commonly used, in consequence of its being the most easily obtained; but ass's milk more nearly resembles human milk, as is shewn from the following comparative analyses by Professor Playfair:

	Woman.	Cow.	Ass.
Casein, . . . . .	1.5	4.0	1.9
Butter, . . . . .	4.4	4.6	1.3
Sugar, . . . . .	5.7	3.8	6.3
Ashes, . . . . .	0.5	0.6	...
Water, . . . . .	88.0	89.0	90.5

The most important difference between cow's milk and woman's milk is the great excess of casein in the former. The former fluid may, however, be made to resemble the latter in composition in either of the following ways: (1) On gently heating cow's milk, a membrane of casein forms on the surface; by removing two or three of these membranes as they form, we can reduce the quantity of casein to the desired extent; or (2) we may dilute cow's milk with twice its bulk of pure water, and add a little sugar. This food should be administered at a natural temperature (of about 98°) through a sucking-bottle; and as the child grows older, it will soon be able to take natural cow's milk without inconvenience. The nature and importance of the mixture of milk and farinaceous food known as Liebig's Soup for Children, are described under SOUP.

The rules regarding the times, &c. of feeding are similar to those laid down for suckling. Assuming that the infant, whether brought up at the breast or artificially reared, has been safely weaned, we have to consider what rules should be laid down regarding its food subsequently. For some months after weaning, the food should consist principally of semi-fluid substances, such as milk thickened with baked flour, or pap, to which a little sugar should be added. Light broths may also be administered, especially in the occasional cases in which milk seems to disagree; and bread and butter may be tried in small quantity. We shall conclude this article with the following 'model of a suitable diet for children,' which cannot be too strongly impressed upon the minds of all young mothers. 'A healthy child, of two or three years old, commonly awakes hungry and thirsty at five or six o'clock in the morning, sometimes even earlier. Immediately after awaking, a little bread and sweet milk should be given to it, or (when the child is too young to eat bread) a little bread-pap. The latter should be warm; but in the former case, the bread may be eaten from the hand, and the milk allowed to be drunk cold, as it is well at this meal to furnish no inducement for eating beyond that of hunger. After eating, the child will generally sleep again for an hour or two; and about nine o'clock it should get its second meal, of bread softened in hot water, which latter is to be drained off, and fresh milk and a little sugar added to the bread. Between one and two, the child may have dinner, consisting, at the younger ages, of beef, mutton, or chicken broth (deprived of all fat), and bread. When a sufficient number of teeth are developed to admit of chewing being performed, a little animal food, as chicken, roast, or boiled mutton, or beef, not too much dressed, should be allowed, with a potato or bread, and some fresh, well-dressed vegetable, as turnips or cauliflower. After dinner, some drink will be requisite; and a healthy child requires, and indeed wishes for nothing but water. Light, fresh table-beer would not be injurious to a child of four or five years old, but it is unnecessary. Between six and seven o'clock, the child may have its last meal of bread steeped in water, &c., as at nine o'clock in the morning. A healthy child which has been in

the open air during the greater part of the day, will be ready for bed shortly after this last supply, and will require nothing more till next morning. Similar regimen and hours may be adopted throughout the whole period of childhood; only as the fourth or fifth year approaches, giving, for breakfast and supper, bread and milk without water, and either warm or cold, according to the weather or the child's inclination. The supply of food upon first awaking in the morning may also be gradually discontinued, and breakfast be given somewhat earlier.'—*Op. cit.*, pp. 80, 81.

**WEA'SEL** (*Mustela*), a genus of quadrupeds of the family *Mustelidae* (q. v.), having a very elongated body; short feet, with toes quite separate, and sharp claws; four molar teeth on each side above, and five below. The COMMON W. (*M. vulgaris*) is a native of almost all the temperate and cold parts of the northern hemisphere, except the most arctic regions. Its range does not extend quite so far north as that



Weasel (*Mustela vulgaris*).

of the ermine. It is the smallest of the *Mustelidae* of the Old World, not exceeding two inches and a half in height, and seven inches and a half in length, from nose to tail; the tail about two inches and a half long, and terminating in a point, not so bushy as that of the stoat or ermine. The female is smaller than the male. The head is large; the ears short, broad, and rounded, the whiskers long. The colour is reddish brown on the upper parts, sides, legs, and tail; the throat and belly white. The eyes are small, round, and black, with a very keen expression, to which the whole habits of the animal correspond. It is nimble and active, bold, and yet wary. It may often be seen peeping curiously from a hole in a wall, but vainly does the schoolboy attempt to strike it with a stone. Catching it is out of the question for him, and so far well, for it is ready to bite severely. It is a most persevering hunter, its scent as keen as its sight, quarters the ground like a dog, and wears out animals larger and apparently much stronger than itself. It preys on mice, rats, voles, small birds, and other small animals, sometimes even on hares and rabbits, robs birds' nests, devouring the young birds or sucking the eggs, and is occasionally troublesome in poultry-yards, killing young chickens. It climbs walls and trees with great agility, and does not hesitate to plunge into water in pursuit of the water-rat. It sometimes begins by abstracting the blood of the animal which it has killed, and generally devours the brain; but when food is abundant, it carries the body to its retreat, where a considerable quantity of prey is often found, the W. preferring to eat it in a half-putrefied state. The W. generally sleeps during the day, and is most active at night. It has a disagreeable smell, which is strongest in hot weather, or when it has been pursued or irritated. It is capable of being tamed when taken young, and becomes docile and gentle. The female W. makes a nest of straw-leaves and moss for her young, which are produced in spring, four or five in a litter; often in a crevice of a bank, or in a hollow



tree. The fur of the W. is an article of commerce in some northern countries, and W.-skins are exported in considerable quantity from Siberia to China. The W. sometimes, but rarely, becomes white in winter, like the ermine.—The Ermine (q. v.), or Stoat, is another species of weasel.—America has several species of W., of which one (*M. pusilla*) is rather smaller than the Common W. of Europe, and has a shorter tail. It is abundant in the northern parts of the United States, and its range extends far to the north. In the United States, it remains brown all winter; but in the fur-countries it becomes white.

WEA'THER is the condition of the atmosphere at any time in respect of heat, moisture, wind, rain, cloud, and electricity; and a change of weather implies a change in one or more of these elements. From the direct bearing weather-changes have on human interests, they have from the earliest times been closely watched, so that the causes by which they are brought about being discovered, their approach might be predicted with some degree of confidence. The craving in the popular mind for this knowledge is strongly attested by the prognostics of the weather current in every language, which, amid much that is shrewd and of considerable practical value, embrace more that is vague, and not a little that is positively absurd.

It is not necessary here to refer to Moore, Zadkiel, and other almanac-makers of that class, except as proving by their mere existence a widespread ignorance of even the most palpable elements of physical law, which is a disgrace to the educational system of the country. Prognosticators of higher pretensions repeatedly appear before the public, and it is curious to note how their predictions are eagerly laid hold of by the newspapers, and scattered broadcast over the country. Among the latest of this class was Mathieu de la Drome, whose predictions of storms and rains made so much noise, that the Emperor Napoleon requested the celebrated Leverrier to examine the grounds on which the predictions were founded. The exposure was complete. One of his principal predictions was based entirely on a high average of the rainfall at a particular season. On examining the rainfall of the particular years of which the average had been taken, it was found that the excess was entirely due to an unprecedentedly heavy rain which occurred in one of the years at that season. His fame was founded on a few happy hits, and on his death occurring a short time after he began to issue predictions of the weather. One of the most remarkable predictions of recent times was that made by an Irish nobleman in reference to the weather of September 1865, which turned out to be in accordance with the prediction—dry, warm, and fine, beyond precedent. The celebrity of this prediction has, however, been greatly reduced by other predictions made since, which the events unfortunately have not verified.

The changes of the moon were long, and in many minds are still, regarded as supplying the elements of prediction. In order to test the real value of the moon's changes on the weather, the Greenwich observations of 80 years were carefully examined, and it was found that the number of instances in which the weather was in accordance with the prognostication was one instance less than those in which the weather was different. When brought to the test of accurate examination and figures, the theory of the moon's changes on the coming weather is thus proved to be a complete delusion; but since most people have a bias towards forgetting the unsuccessful prognostications, and remembering the successful ones, the theory will likely continue to

be believed in, at least until some knowledge of the natural laws be more generally diffused, so as to reveal its absurdity.

For some years, Mr Thomas du Boulay predicted the general character of the weather of each summer from the weather-conditions which prevailed during the week of the spring equinox preceding, believing that the general character of the weather of the next six months is already settled, and that it only requires the necessary skill to read its features, since these will remain generally constant till autumn. For a few years, he speculated in grain on the faith of the predictions, which turned out pretty correct. Latterly, the predictions have not been verified.

*The truth is, that no prediction of the weather can be made, in the British Islands at least, for more than three, or perhaps only two days beforehand. Any attempt at a longer prediction is illusory.* We would here refer to the article STORMS, as shewing the possibility and mode of making real predictions of the weather. Almost all the weather-changes of Europe begin from the south-west, and pass over Great Britain to the north-east. Unsettled or bad weather is accompanied with a low barometer; elsewhere, the barometer is higher. Thus, then, suppose that, from weather-telegrams received, it is seen that everywhere in Europe barometers are high, we may be sure that no storm need be dreaded for two days at least. But if, on the following morning, barometers begin to fall a little in the west of Ireland, and an easterly wind begins to blow generally over Great Britain and Norway, and a south-east wind over France; then, since the winds blow towards the lowest barometer, or rather a little towards the right of it, the presumption is that a storm of greater or less severity is coming up, the centre of which is likely to pass over England. This ought, therefore, to be closely watched by the telegraph; and if the winds keeping in nearly the same direction, or veering slowly towards the south and west, increase in force, and barometers in the west of Ireland fall rapidly, a great storm is portended, of the approach of which warning should be at once telegraphed to the different seaports. But if, on the contrary, the winds do not increase in force, and the barometer fall slightly, or cease to fall, the storm has either passed considerably to the north of the British Islands, or its approach will be delayed for some time yet; and hence, no immediate warning is necessary.

It is our proximity to the Atlantic that makes it impossible to predict the weather beyond three days at the utmost. In Norway and the Baltic, and places towards the east of Europe, the weather may be predicted for a longer time, since each storm as it appears in the west may be followed in its course by the telegraph, and the places which it threatens be warned of the coming danger. In America also, where storms chiefly advance from west to east, gales and unsettled weather are predicted at the sea-board in the east some days before.

But the collecting of this information by the telegraph is a work which, owing to the expense, governments only can accomplish; and from its importance, it is an incumbent duty which they should discharge for the benefit of the seafaring population. From the great value of weather-telegrams to persons interested in shipping, we believe that the time is not far distant when each of our chief seaports will be supplied with daily telegrams of the barometer and the winds from five or six places, at some distance, and in different directions, from the particular seaport. A good deal may, however, be done by each one for himself, by

## WEATHERING—WEAVER-BIRD.

observing his barometer, the winds, and the face of the sky—especially the cirrus cloud—the most elevated and delicate of the clouds. But ere these simple observations can be turned to account, and made the basis of an intelligent prediction, some knowledge of the general features of Storms (q. v.) is indispensable. These specially—(1) Storms have a circular area; and (2) advance in an easterly direction, bearing a low barometric pressure with them. (3) Winds blow from a high to a low barometer, and (4) with a force proportioned to the difference of the pressure. (5) Storms are first felt in the upper regions of the atmosphere, or in the region of the cirrus cloud; and (6) in front of the storm the air is warm and humid; in the rear of it, cold, or cool and dry. With such observations (requiring only a barometer), intelligently interpreted, particularly if hills form part of the landscape, the character of the weather may be foreseen for one day, or longer.

But though no prediction of the weather for weeks or months beforehand can be made with any pretensions to trustworthiness, yet guesses or surmises may be formed which are not without value. All observation goes to prove that predictions based on solar or other astronomical causes are without foundation, and that averages based on terrestrial observations are the only guides we have in this matter. Of this class are the interruptions which occur in the regular march of temperature in the course of the year. Thus, cold weather generally prevails from the 11th to the 14th of April—that is, the period of the 'borrowing days' (O. S.), and in the second week of May; and these, with some other cold and warm periods, are almost co-extensive with the northern hemisphere of the globe. Hence, then, at these times, when the weather begins to get cold or warm, it may safely be predicted that such weather will last for several days. Again, if, after a long-continued prevalence of south-west winds, or the equatorial current, the polar current, or north-east wind, should set in, it is highly probable that easterly winds will prevail for some time; so that, if the season be winter, a continuance of frost, and perhaps snow, may be looked for; but if midsummer, the weather will become dry, warm, and bracing. But suppose easterly winds have been unusually predominant in autumn, and south-westerly winds begin to prevail in the end of November or beginning of December, it is most probable that the weather will continue exceptionally mild, with frequent heavy storms of wind and rain, till about Christmas. This period occurs nearly every year, and its commencement is popularly known as St Martin's summer. If easterly winds preponderate greatly above the average during the spring months, the summer is likely to be characterised by south-westerly winds, with much rain and moisture, and little sunshine; but if easterly winds nearly fail in spring, the summer will be dry and warm, it being expected that the polar current will prevail in summer, bringing clear skies and brilliant sunshine. This latter forecast of the summer is believed in by the Rev. L. Jenyns, and several meteorologists of note; but an examination of the weather for a period of eleven years shews that it is only generally true.—See Rev. Leonard Jenyns' *Meteorology* (1858); *Popular Prognostics of the Weather in Scotland*, by Arthur Mitchell, M.D.; *Journal of Scottish Meteorological Society*, No. xiii.—'Interruptions of Temperature.'

**WEATHERING**, a slight inclination given to the top of a cornice or moulding, to prevent water from lodging on it.

**WEAVER-BIRD** (*Ploceus*), a genus of birds of

the Finch family (*Fringillidae*), of a group or sub-family (*Ploceinae*), to most of which the name Weaver-bird is extended. The name has reference to the remarkable structure of the nests of these birds, which are woven in a very wonderful manner of various vegetable substances, and are objects of great interest. The *Ploceinae* are natives of the warmer parts of Asia, of Africa, and of Australia;



Taha Weaver-bird (*Ploceus Taha*).

none being found in Europe nor in America. The species are numerous. They are small birds, with a strong conical bill, the ridge of which is slightly curved, the tip entire. The claws are large and very long. The wings are pointed, the first quill remarkably short. There is great diversity in the form and appearance of the nests constructed by different species. One of the best-known species is the PHILIPPINE WEAVER (*P. Philippinus*), the BAYA (q. v.) of India.—Many of the other weaver-birds construct nests pretty much on the same plan with this—pouches elongated into tubes, entering from below; those of some are kidney-shaped, and the entrance is in the side. They very generally suspend their nests in the same way from the extremities of branches, and often prefer branches which hang over water, probably as affording further security against monkeys, squirrels, snakes, and other enemies. Social habits are very prevalent



Nest of Pensile Weaver-bird.

among them, and many nests of the same species are often found close together. Some of them attach the nest of one year to that of the year preceding, as the *Ploceus pensilis* of Madagascar, which sometimes thus makes five nests in succession, one hanging to another. Some of the African species build their nests in company, the whole forming one structure. Thus, the SOCIAL or REPUBLICAN

W. of South Africa (*Ploceus socius* or *Philoterus lepidus*) constructs a kind of umbrella-like roof, under which 800 or 1000 nests have been found, the nests like the cells of a honeycomb, and arranged with wonderful regularity. An acacia with straight smooth stem, such as predaceous animals cannot easily climb, is often selected by the bird-community. When the situation is chosen, the birds begin by constructing the roof, which is made of coarse grass, each pair afterwards building their own nest, which is attached to the roof. As new nests are built every year, the weight of the structure often becomes so great as to break down its support.—*Tector erythrorhynchus* is a bird of the W. group, which is commonly seen in South Africa accompanying herds of buffaloes, and feeding on the bots and other insects which infest them, alighting on their backs to pick them out of the hide. The bird is often of great use to the buffalo in another way, by giving warning of the approach of an enemy.—The Whydow Birds (q. v.), or Widow Birds, likewise belong to the group of *Ploceinae*.

WEAVING, the art by which threads or yarns of any substance are interlaced so as to form a continuous web. It is perhaps the most ancient of the manufacturing arts, for clothing was always a first necessity of mankind. The methods by which weaving is now accomplished have been explained and illustrated under LOOM (q. v.); it therefore only remains to describe the variations which may be effected by ingenious applications of the powers of the loom; and as these are almost endless, some of the more common and easily understood will be chosen. The simplest form of weaving is that employed in making the mats of uncivilised nations. These consist of single untwisted fibres, usually vegetable, arranged side by side to the width required, and of the length of the fibres themselves, which are tied at each end to a stick, which is so fixed as to keep the fibres straight, and on the same plane, as in fig. 1. Then the weaver lifts up

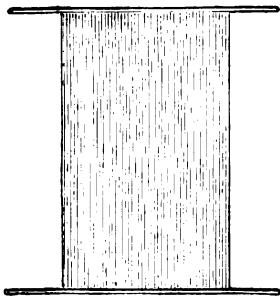

Fig. 1.

every other of these longitudinal threads, and passes under it a transverse one, which he first attaches by tying or twisting to the outermost fibre of the side he commences with, and afterwards in the same way to that on the other side, when it has passed through the whole series. The acquisition of the art of spinning threads of any length enables more advanced nations to give great length to the warp, or series of threads which are first arranged, and to pass the weft or transverse thread backwards and forwards by means of a shuttle, without the necessity of fixing at the sides. The mechanical appliances already described under LOOM aid these operations to an amazing extent. That kind of weaving which consists of passing the weft alternately over and under each thread of the warp is called *plain*

weaving, and a transverse section of the web would be represented by fig. 2; but if the weaver takes up first one and then two threads alternately of the warp series, and passes the weft under them for the first shoot of his shuttle, and raises those which



Fig. 2.

were left down before for the second shoot, he produces a cloth with a very different appearance, called TWILL (q. v.), many varieties of which may be produced by varying the numbers missed or taken up—as, for example, one and three, instead of one and



Fig. 3.

two. The simplest form of twill, viewed transversely, would be represented by fig. 3.

There are few arts which require more patience or skill than weaving. As many as from one to two thousand threads often constitute the warp; and these threads may be so varied in quality (see YARN) as to produce many varieties of fabric. From that cause alone, there are almost infinite variations. Many may be produced by the order in which the threads are lifted for the passage of the weft—that of itself can also vary as much or more in its quality and other circumstances, so that the inventive genius of the weaver finds incessant opportunities for its display, and nice arithmetical calculations are required in estimating and allotting the numerous threads to the endless variety of patterns which are constantly passing through the looms. A really practical knowledge of weaving can only be obtained by working with looms, and studying such technical treatises as Watson's *Theory and Practice of the Art of Weaving*, and some of the elaborate treatises by the French weavers. See WEAVING, in SUPP., Vol. X.

WEBER, CARL MARIA VON, a musical composer of high eminence, was born at Eutin in Holstein, 18th December 1786. Musical and dramatic talent had been hereditary in his family for some generations: his father, by turns officer in the army of the Palatinate, finance minister of the Elector of Cologne, music-director to the Prince Bishop of Eutin, and head of a company of strolling players, led a somewhat irregular and checkered life. Young W. shewed early a genius for music, but his instructors were often changed, in consequence of his father's change of residence. The teachers to whom he owed most were Hauschkel at Hildburghausen, Michael Haydn at Salzburg, and Valesi and Kalcher at Munich. His father's impatience and want of judgment were injurious to him in many ways, particularly in the efforts made to bring him before the public prematurely as a musical prodigy. At the age of 13, he composed an opera called *Die Macht der Liebe und des Weins*. When but 14, his second opera, *Das Waldmädchen*, was brought out, without much success at first; but was afterwards far better received than he himself thought it deserved. The next effort of the young opera-composer was *Peter Schmall und seine Nachbarn*, composed at Salzburg in 1801, and performed at Vienna with but indifferent success. At Vienna, he became acquainted, in 1803, with Joseph Haydn and the Abbé Vogler, and studied for some time under the latter. In 1804, he left Vienna, to be conductor of the Opera at Breslau, and while resident there, composed the greater part of his opera of *Rübezahl*.

We next find him, in 1806, with Prince Eugene of Würtemberg at his court of Carlruhe in Silesia, where he composed two symphonies and three concertos. In 1807, he went to Stuttgart, as private secretary to Duke Ludwig, becoming also musical instructor to his children; and while there, he composed the opera of *Silvana*, and a cantata called *Der erste Ton*, besides overtures, choral pieces, and pianoforte works. Getting into disfavour and pecuniary embarrassments, the result of his father's recklessness, he was dismissed the court of Würtemberg, and took up his residence successively in Mannheim, Heidelberg, and Darmstadt, at which last place he composed his operetta of *Abu Hassan*. He then made a musical tour through Germany, during which his concerts were everywhere well attended. From 1813 to 1816, he was director of the Opera at Prague, which he entirely remodelled; and during his residence in the Bohemian capital composed *Kampf und Sieg*, and numerous other songs, including that noble national series from Körner's *Leier und Schwert*, which had no little influence in rousing patriotic sentiment during the war of liberation.

In 1817, he was invited to form a German Opera at Dresden; and there, during the remainder of his life, he held the post of *Kapellmeister* to the king of Saxony. To this period belong his most important compositions, including *Preciosa*, *Der Freischütz*, *Euryanthe*, and *Oberon*. None of these works, however, were first brought out in Dresden. The music to Wolff's *Preciosa*, the subject of which is taken from a novel by Cervantes, was first produced on the Berlin stage, where it made a powerful impression. The author's *chef-d'œuvre*, the opera of *Freischütz*, the libretto of which was written by the composer's friend, Friedrich Kind, also first saw the light in the Prussian capital in 1822. It was a great success: its novelty and beauty, as well as the deep thought contained in it, excited an extraordinary sensation throughout Germany, which soon extended to France and England. *Euryanthe*, produced in Vienna in 1823, was not quite so warmly received. Bearing more the impress of labour and cultivation, and less that of the composer's natural vein of romance, it has never been in such general favour as its predecessor. *Oberon* was written in prospect of a visit to London to a libretto supplied by Mr Planché. When W. set out for England, he was already struggling against mortal disease. On the 8th March 1826, he appeared at Covent Garden Theatre as conductor of a selection from *Freischütz*; and on the 12th of April following he also conducted, on the first appearance of *Oberon*, with applause on both occasions, incessant and uproarious. At his benefit concert on the 26th of May, he was hardly able to go through the duty of conductor; and on the 5th of June he was found dead in bed in the house of Sir George Smart, whose guest he was. He was interred in the Roman Catholic Church, Moorfields; but in 1844, his body was removed to Dresden; and a statue of him by Reichel was erected in 1860 in front of the Dresden theatre. W. was married in 1818 to Carolina Brandt, an operatic singer of some note, daughter of Brandt the violinist, by whom he left a family.

The verdict of posterity, as well as of his contemporaries, has placed W. in the first rank of musical composers. He was the first to use those bold effects of harmony and modulation whose introduction forms an era in the history of music. In his operas, the spirit of the romantic school appears in its brightest and most captivating form; and the overtures are masterpieces of imagination, each presenting an outline of the work to which it belongs. Besides the above operas and songs, his musical

works are numerous, comprising concertos for the pianoforte, clarinet, oboe, bassoon, and violoncello—symphonies and overtures, one of the most beautiful and characteristic of them being the overture to the *Beherrscher der Geister*. Among his posthumous writings is an Autobiography. His Life has been written by his son, Baron Max Maria von Weber, and recently translated into English by Mr Palgrave Simson.

WEBSTER, DANIEL, American statesman and jurist, was born at Salisbury, New Hampshire, January 18, 1782, the second son of Ebenezer Webster, a small farmer, and justice of the county court. He entered Dartmouth College in 1797, and taught school in winter to pay his expenses, and aid his brother, Ezekiel, who became a distinguished lawyer, in fitting for college. On graduating in 1801, he commenced to study law, but was induced, by the offer of a salary of 350 dollars a year, to become preceptor of an academy at Fryburg, Maine, paying his board by copying deeds. In 1804, he went to Boston, and entered the law office of Mr Gore, refusing an appointment of clerk of the court of which his father was a judge, at 1500 dollars a year. In 1805, having been admitted to the Boston bar, he established himself at Portsmouth, New Hampshire; married in 1808; and having engaged in politics as a member of the Federalist party, was elected to Congress, where he immediately took rank with the foremost men of the country. His speech on the Berlin and Milan Decrees, and his mastery of the questions of currency and finance, gave him a high position; but he determined, in 1816, to remove to Boston, where, leaving politics, he engaged for several years in legal practice of the most extensive and varied character. In 1822, he was a member of the Massachusetts Constitutional Convention; and December 22, 1822, he pronounced at Plymouth, on the anniversary of the landing of the Pilgrims, the first of that remarkable series of discourses, or orations, which gave him the first rank among American orators. In 1825, he gave an oration at the laying of the corner-stone of the Bunker Hill Monument; in 1843, one on its completion. In 1826, he pronounced the eulogy of John Adams and Thomas Jefferson, two fathers and Presidents of the American republic, who died on the same semi-centenary anniversary of the Declaration of Independence; and in 1851, a patriotic discourse on the laying of the corner-stone for the extension of the Capitol at Washington. In 1822, he was elected to Congress from Boston, and was distinguished by his speeches on the Holy Alliance and the Greek revolution, and his labours in the revision of the criminal laws of the United States. In 1826, he was chosen senator; and in 1830, rose to the height of his forensic renown in a speech of two days, in the debate with Mr Hayne, of South Carolina, on the right of 'nullification.' W. and Clay were the leaders of the opposition during the administrations of Jackson and Van Buren. In 1839, he visited England, Scotland, and France; and in 1841, accepted the post of Secretary of State in the cabinet of General Harrison, and remained in that of Mr Tyler, who, as Vice-president, succeeded on the death of the President, until 1843. In 1844, he aspired to the presidency, but the choice of his party fell upon Mr Clay, whom he supported, but unsuccessfully. He was chosen senator for Massachusetts, and again, in 1848, was disappointed of the presidential nomination by the popular enthusiasm for the victor of Buena Vista, General Taylor. His senatorial efforts at this period were directed to the preservation of the Union by the advocacy of compromises on the slavery question, and he gave offence to the Abolitionists

by defending the Fugitive Slave Law. In 1850, he became again Secretary of State in the cabinet of Mr Fillmore; and in 1852 was once more, and no doubt grievously, disappointed at not receiving the nomination to the presidency, which was given to General Scott. He did not live to see the defeat of his rival; but, after a brief illness, died at his country residence at Marshfield, Massachusetts, October 24, 1852. Mr W. was a man of very striking appearance, large, swarthy, with deep-set eyes, a deep powerful voice, and a solemn and earnest manner. His collected writings and speeches have been published (6 vols. 8vo, 1851), and his Correspondence (2 vols. 8vo, 1855).

WEBSTER, NOAH, American author and philologist, was born at Hartford, Connecticut, October 16, 1758, and entered Yale College in 1774. In his third college year, he served under his father, a militia captain, in the war of the Revolution. He was admitted to the bar in 1781, but engaged in scholastic and literary occupations. Employed in teaching a school at Goshen, New York, he prepared his *Grammatical Institutes of the English Language*, published in three parts; and edited *Governor Winthrop's Journal*. In 1785, he wrote *Sketches of American Policy*, advocating the formation of a new constitution, and gave public lectures on the English language, which were published in 1789. He taught an academy in Philadelphia, and wrote on the Constitution; and in 1788, published the *American Magazine* in New York. After a few years' law-practice at Hartford, he engaged, in 1793, in the editorship of the *Minerva*, a Federalist daily paper in New York. In 1799, he published *A Brief History of Epidemic and Pestilential Diseases*, the yellow fever having broken out in New York; and pamphlets on International Law, Banking, and Finance. In 1807, he published *A Philosophical and Practical Grammar of the English Language*, and commenced his *American Dictionary of the English Language*; but finding difficulties in etymology, he devoted ten years to its study, and prepared a *Synopsis of Words in Twenty Languages*; then began his Dictionary anew, and in seven years completed it. In 1824, he came to Europe, to consult books and learned men, spending some months at Paris and at Cambridge. In 1828, an edition of 2500 copies of his Dictionary, in 2 vols. 4to, was issued; followed by one of 3000 copies in England. Numerous abridgments have been made, which found a large sale. His *Elementary Spelling-book*, founded on his *Institutes*, up to 1862, had been sold to the extent of 41,000,000 copies. A new and thoroughly revised and enlarged edition of his dictionary was finished in 1866, and it is now perhaps the most complete dictionary of the English language yet published. Mr W. also published a popular *History of the United States*, and a *Manual of Useful Studies*. He was a judge, a member of the state legislature, and one of the founders of Amherst College. He died at New Haven, May 28, 1843.

WEDGE, one of the mechanical powers, and in principle a modification of the inclined plane. Its normal form is here represented. The power is applied by pressure, or more generally by percussion, to the back B, thus forcing the edge A forwards. The wedge is employed for such purposes as the splitting of wood, the fastening firmly of the handle of an axe, the raising of a ship in a dry dock, &c. The investigation on statical principles of the mechanical advantage of the wedge is extremely unsatisfactory, the power, which is scarcely



ever a 'pressure,' being always assumed to be one, and the enormous friction on the sides of the wedge being generally neglected; the theoretical result thus arrived at is that the pressure applied at the back: the resistance or weight ::  $\frac{1}{2}$  width of back of wedge : length of side. In the application of the wedge to the splitting of wood in the direction of the fibres, the split generally extends some distance in advance of the edge of the wedge, and the action of the latter is then a combination of the action of the wedge with that of the lever; in fact, this compound action is found more or less in all applications of the wedge as a cutting or splitting weapon, and tends further to complicate the statical investigation of its mechanical properties. The best and simplest illustrations of the single wedge are axes, nails, plugs, planes, chisels, needles, and all sharp-pointed instruments.

WEDGWOOD, JOSIAH, the creator of British pottery as an art, was born at Burslem, in Staffordshire, in the year 1730. His father was a potter, and very early he was set to work at the same business. His education seems to have been of the scantiest. After an abortive attempt to settle himself at Stoke with a partner named Harrison, he returned to his native place, and there commenced business as a potter. From the first, his ardour for the improvement of the manufacture was conspicuous. His first efforts were directed to the refining of the material, and soon he succeeded in producing a beautiful cream-coloured porcelain, which became popularly known as Queen's Ware, Queen Charlotte having much admired it, and extended her patronage to the manufacturer. Subsequently, other improved materials were produced. The attention of W. was not less assiduously directed to considerations of form and decoration; he busied himself in emulating the grace of the antique models; and the celebrated sculptor, Flaxman, was employed to furnish designs to him. In this way, what he found a rude and barbarous manufacture, he raised to the level of a fine art; and he found his reward in the speedy amassing of an immense fortune. In 1771, he removed his works some little way from Burslem; and to the new site he gave the fanciful name Etruria, as that of the country of old most celebrated for the beauty of its ceramic products. Here he built himself a splendid mansion; and here, in 1795, he died.

Apart from his eminence in the art to which he mainly devoted himself, W. was a man of considerable culture. Natural philosophy, in particular, he studied with much success. He was a fellow of the Royal Society, as also of the Society of Antiquaries; and to the *Philosophical Transactions* he from time to time contributed papers. He likewise interested himself deeply in all matters of public concernment; and mainly through his influence it was that the Grand Trunk Canal, uniting the waters of the Mersey, the Trent, and the Severn, was carried out. He was a man of much benevolence of character, and the prosperity which flowed upon him through life, he distinguished by the exercise of an almost princely liberality.

Full particulars as regards this remarkable man may be found in two lives of him published in 1865, one by Eliza Meteyard, the other by Llewellyn Jewett. See also Eliza Meteyard's *Memorials of Wedgwood* (1875), and *Wedgwood Handbook* (1875).

WEDGWOOD WARE, a beautiful kind of pottery invented by Josiah Wedgwood in 1775. It consists of flint, Potter's clay, carbonate and sulphate of barytes, and zaffre, or some other colouring material. It is also called Jasper Ware. The beautiful classical designs on the earliest productions

of this manufacture were many of them executed by Flaxman, and are very highly valued.

WEDNESBURY, a market-town in the south of Staffordshire, in a district abounding in canals, coal mines, and iron-works,  $7\frac{1}{2}$  miles north-west of Birmingham by railway. It was called Weadesbury by the Saxons, and for a long time took precedence, in point of population and historical importance, of Birmingham and Wolverhampton. It was here that the great coal-field of Staffordshire was first worked. W. contains large works for the manufacture of railway plant; it produces also edge-tools, coach ironmongery, locks, screws, gun-locks and barrels, gas and water pipes. The town has been greatly improved by a Local Board of Health, appointed in 1865. By the Reform Act of 1867, W.—comprising also Bromwich and Tipton—was erected into a parliamentary borough, returning one member to the House of Commons. Pop. (1871) of town, 25,030; of parliamentary borough, 116,809.

WEDNESDAY, the fourth day of the week, the *Dies Mercurii* of the Romans, the *Mittwoch* (mid-week) of the modern Germans. The name Wednesday is derived from the northern mythology, and signifies Woden's or Odin's day. The Anglo-Saxon form was *Wōdanes dag*, the old German *Wuotanes tac*. The Swedish and Danish is *Onsdag*.

WEE'BO, or IBO, a small island off the coast of Mozambique, belonging to the Portuguese, about 150 miles south of Cape Delgado. The town is clean, with neatly-built houses; there are three forts, one of which serves as barracks for the garrison, and, though contemptible as a defensive work against a well-organised enemy, it is well adapted for resisting the natives, between whom and the Portuguese all along the Mozambique coast, there seems to be perpetual hostility. The pop. consists of nearly 3000 natives and a few Europeans; and though an important trade in ivory, copal, &c., is said to be carried on, there are few signs of activity in the harbour, and the natives for the most part seem miserable, fever-stricken wretches.

WEED, THURLOW, American journalist, was born at Cairo, New York, November 15, 1797, and at the age of 10 years was cabin-boy on a sloop on the Hudson River; at 12 he was an apprentice in the printing-office of Mr Croswell, at Catskill; then lived for a short time in a backwoods settlement, but at 14 returned to printing. He was a volunteer in the war of 1812, and at the age of 21 established a newspaper in Western New York, and during the Anti-Masonic excitement, was elected to the state legislature, 1826—1827, where his peculiar and almost unrivalled abilities as a political manager or 'wire-puller' were early recognised. In 1830 he settled at Albany, the state capital, and commenced the publication of the *Evening Journal*, an anti-Jackson, whig, or republican paper, which became the organ of the party, and of the state government when its party was in power. Declining all offices for himself, except the profitable one of state printer, he is supposed to have exercised almost supreme influence in nominations and appointments, and to have secured the choice of Presidents Harrison and Taylor; was through his whole career, the friend and adviser of Mr Seward. In 1861, he was sent in a semi-diplomatic capacity to Europe, and on his return was presented with the freedom of the city of New York, where he became part proprietor and one of the editors of the *New York Times*, and subsequently editor of the *Commercial Advertiser*. In 1866, he published *Letters from Europe and the West Indies*.

WEED (*Lymphangitis*), or a Shot of Grease, consists in inflammation of the large absorbent glands

and vessels situated between the horse's thighs. Rarely, it attacks the corresponding structures between the fore-limbs. It occurs in round-limbed, indifferently bred, hard-wrought horses; appears particularly after a day or two of rest, after exposure to cold, or during imperfect action of the bowels; and is said to depend upon more blood being produced than is required to replace the natural waste of the body. It is identified by lameness, tenderness in the groin, and fever. The horse must be bled, have a full dose of aloes, and when the pain and tenderness are great, ten drops of Fleming's Tincture of Aconite in water every two hours; the limb should be bathed for at least six or eight hours continuously in hot water, and then rubbed dry and kept warm. The subsequent swelling will be reduced by saline draughts, diuretics, rubbing of the limb, and exercise.

WEEDS, the name given to all those plants which grow wild in cultivated grounds, and injure the crops; which they do both by choking them, and by exhausting the soil. Those weeds which are annuals or biennials, as charlock, yellow rattle, and melilot, may gradually be got quit of by merely cultivating, for a succession of years, such plants as are to be cut before the seeds of the weeds are fully ripe. Perennial weeds, such as couch grass, can only be removed from the ground by repeated and careful tilling; and for this purpose, crops which require much hoeing are advantageously planted, and recourse is had to summer fallowing in fields, and frequent weeding in gardens. Thistles and other large weeds are frequently pulled in corn-fields before the corn comes into ear, and to prevent their seeding, they are cut in pastures. Sedges and rushes, which spring up in great abundance in damp grounds, disappear on thorough draining. Leafy crops which thickly cover the soil, prevent the growth of many weeds by the exclusion of air and light. Weeds which have been rooted up form excellent compost for manure. Those which make their appearance in fallow grounds, serve for green manuring when they are ploughed down.

WEEK (Goth. *Vico*; Old High-German, *Wehha* = order, cycle (?); Lat. *Vicis*; Gr. *Hebdomas*, *Sabbata*; Heb. *Shabna*, from *Sheba*, seven) designates generally a period of seven days. It was probably first instituted as a kind of broad subdivision of the periodical month, corresponding to the four quarters of the moon, or about  $7\frac{1}{2}$  days. Although found as a civil institution among some nations at the earliest time—a. g. with the Hindus, Assyrians, Persians, &c., it is only with the Jews that we see a religious signification given to the concluding or seventh day of that period itself. Both their cosmogony and legislation are connected with it. The Sabbath (q. v.) is emphatically the day of rest, while seven weeks after the Passover, the Pentecost or Feast of Weeks takes place, &c. (see SEVEN). It is doubtful whether it was through the Jews that this computation of weeks was introduced to the Egyptians, but it is certain that the latter at an early period counted seven periodical days, naming them according to the seven planets then assumed. The application of the names of the planets to the days of the week in the order they now stand, originated in this way: It was an astrological notion that each planet in order presided over an hour of the day, the order, according to their distances from the earth, being, on the geocentric system, Saturn, Jupiter, Mars, the sun, Venus, Mercury, the moon. Assuming Saturn to preside over the first hour of Saturday, and assigning to each succeeding hour a planet in order, the 22d hour will fall again to Saturn, the 23d to Jupiter, the 24th to Mars, and the

first hour of the next day to the sun; in the same way, the first hour of the following day falls to the moon, and so on. From Alexandria, this seven days' week was imported, together with the names of the individual days, to the Greeks—who previously divided their months into three decades—and to the Romans, about the time of Christ. Rome had previously counted her periods by eight days, the eighth day itself being originally called *Nundina*—a term later applied to the whole cycle—as returning *nono quoque die*, when the country-people were in the habit of coming to town for the purposes of business, and chiefly to inquire after public news, the changes in government and legislation, vacant places, and the rest. But the seven days' cycle soon found great favour among the Romans, owing partly, perhaps, to the spread of Egyptian astrology, although the change was not officially introduced before Constantine. It is certain that the Jewish name Sabbath came into use in Rome, and from Rome it spread to all the Romanic languages, even into the German. It survives in the Italian *Sabbato*, the Spanish *Sabado*, the French *Samedi* (*Sabbati dies*), and the German *Sambstac*, which afterwards became *Samstag*. In the same manner, the Latin *Septimana* (the Greek *hebdomae*) has become the modern designation for week in the Italian *Settimana*, Span. *Semana*, French *Semaine*, and even in the Irish *Sechtmaine*. The *Codex Theodosianus* is the first document which adopts the term *Septimana* in the meaning of weeks. The Jews, as well as the early Christians, had no special names for the single days, but counted their number from the previous Sabbath, beginning with Sunday, as the first after the Sabbath, and ending with Friday, as the sixth after the previous, or eve (*Ereb*) of the next Sabbath. After a very short time, however, young Christianity, which in the same manner had endeavoured to count from the *feria secunda*, or second day after Sunday, to the *Septima* (or Saturday), had to fall back again upon the old heathen names, previously introduced in Gaul, Germany, &c. by the heathen Romans. The Sunday, or *dies Solis*, alone was changed in many of the Romanic languages in accordance with the new creed. It was called *Kyriake*, *dies Dominicus* or *Dominica*, the Day of the Lord, a term which in Italian became *Domenica*, in Spanish *Domingo*, and *Dimanche* in French. The Germanic *Froniac* (from *frón = dominicus*) occurs but once. It is very curious to notice how the names of the five days of the week which followed those named after the sun and moon, became Germanised, as it were, or the names of the originally imported gods translated into those of the Germanic divinities. Thus, the day of Mars became that of *Ziu* (see *Tyr*). Mercury became *Wodan*; and the fourth day was called after the latter, in Dutch, English, and Scandinavian; while in Germany it was simply called the middle of the week = *Mittwoch*. The day of Jupiter became the day of *Thor* = Thursday, *Donnerstag*; while the *Dies Veneris* was transformed into the day of *Freya*, the wife of *Odin* (*Wodan*). The day of *Saturnus*, retained under this name in some northern tongues, became a *langardage*, or bathing-day, in others; while in Upper Germany it remained a Sunday-eve (*feria ante dominicam*) or *Samstag* (see above). From recent discoveries of Assyriologists, it seems certain that the Assyrians, and through them probably the other Semitic nations, derived their week of seven days from the *Accadians* or early *Turanian* inhabitants of *Babylonia*, who also observed the seventh day as a day of rest. To this remarkable people are also to be traced the planetary names which we still give to the days of the week. The Arabs, like

the Jews, count their days (beginning and ending with sunset) by sevens, without giving them planetary names. Greeks, Slavs, and Finns also count their days from Sunday, instead of naming them. The French Revolution altered the seven days' week into a decade of ten days; but the new computation introduced in 1793 was abrogated again in 1805. The 'weeks of years,' in Hebrew prophetic poetry (like the Roman *annorum hebdomadae*), indicate cycles of seven years.—See *Ideler's Chronologie* (1831); *Grimm's Deutsche Mythologie* (1835); and *Lenormant's La Magie chez les Chaldéens* (1874).

WEEKS, FEAST OF (Gr. *Pentecoste* = fiftieth, Heb. *Shabuoth*, also called Feast of Harvest, Day of the First-fruits, &c.), the second of the three great *Regalim* or Pilgrim Feasts of the Old Testament, was celebrated seven weeks, or forty-nine days, after the Passover. As the latter was the feast of the barley harvest, so the former was that of the wheat-harvest. The first two loaves of the new crop were offered up on the day of the festival—leavened, and containing about  $3\frac{1}{2}$  quarts each (the Mishnah speaks of their being 7 inches by 3), together with a peace-offering of two lambs. Besides this, a great burnt and sin offering—the former consisting of seven lambs, a bullock, two rams, together with the appropriate meat and drink offerings; the latter of one kid—were added, according to *Leviticus* (xxiii. 18); while *Numbers* (xxviii. 27) increases the number of the bullocks to two, and only mentions one ram—a number more in accordance with the regulations for the other festive sacrifices. The Jewish tradition, however, considers the animals mentioned in the later passage as an additional sacrifice; and *Josephus* has indeed added both up, except in as far as the rams are concerned, of which he only gives two. Tradition has given to this feast, which originally was only intended to represent the solemn closing of the harvest, a new significance by making it the anniversary of the *Sinaitic Legislation*, which indeed must have taken place in the first days of the third month. But the *Pentecost*, which is always fixed in the Jewish calendar on the 6th of *Sivan*, could not, before the establishment of astronomical computation, fall always on the same day, but must needs have fallen between the 5th and 7th of that month. *Moses* himself nowhere fixes the date of this festival as he does with the others. The *Karaites*, instead of referring the 'morning of [after] the Sabbath' of *Lev.* (xxiii. 15) to the 16th of *Nisan*, take it literally, and celebrate the festival always on a Sabbath. The uncertainty of the lunar calculation and observation among the Jews of the *Dispersion*, caused them also to add one day to this festival—a usage still retained at present. There seems to have been more of the character of a harvest-home inherent in this festival than in the *Passover*, which partook particularly of the character of a large and solemn family-gathering. For the Christian adoption of this festival, see *PENTECOST*.

WEEPING TREES are trees with remarkably elongated and pendulous branchlets, generally mere varieties of species which ordinarily have a different habit, as the Weeping Birch, Weeping Ash, and Weeping Willow, which are varieties of the Common Birch, Common Ash, and White or Huntingdon Willow. The Weeping Birch occurs in a wild state in some places in the Highlands of Scotland, and is a characteristic ornament of the landscape. Trees intermediate in their habit between the Weeping Birch and the common variety are of very frequent occurrence. Weeping trees are much esteemed for ornamental purposes, and are not only very beautiful

in themselves, but as a contrast to other trees in lawns and pleasure-grounds. They are therefore



Weeping Willow.

carefully propagated in nurseries. The Weeping Ash is often grafted on the Common Ash, but the



Weeping Birch.

result is seldom very satisfactory, the art of the gardener forcing itself too much upon attention. A

tendency to the weeping habit of elongated and pendulous branchlets is manifested in some kinds of trees, as the tendency to vary into a very opposite habit, with the branchlets drawn up close together (var. *stricta* of botanists), appears in others, of which the Swedish Juniper and the Irish Yew are familiar examples.

**WEERT**, an unwall'd town in the Netherlands, province of Limburg, 12 miles west-north-west of Roermond, on the ship-canal from Maastricht to 's Hertogenbosch. Pop. (1875) 7136. There are several good schools, a collegiate institution, town-house, two churches, and three market-places. In the Church of St Martin is the grave of the Count of Hoorn, who was beheaded at Brussels, in 1568, for adhering to the Prince of Orange in the struggle for religious and political freedom. A beautiful promenade leads to the other church, outside the town, north of which are the ruins of the old castle. Besides the markets for farm produce, horses, and pigs, W. has factories for making cloth, stockings, and hats, corn and oil mills. Here was born, 1594, Jan van Weert, who, in boyhood a shoemaker's apprentice, became commander of the Austrian army and viceroy of Bohemia.

**WEEVER**, or **STING-FISH** (*Trachinus*), a genus of acanthopteron fishes of the family *Uranoscopida*, also called *Trachinida*. In this family the ventrals are composed of a spine and five jointed rays, and are generally situated before the pectorals. The scales are cycloid, or wanting. The eyeballs

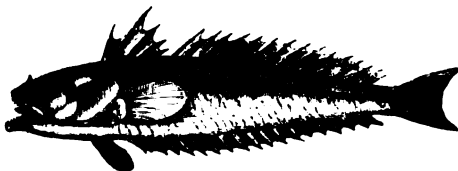

Greater Weever (*Trachinus draco*).

are capable of being raised in a remarkable manner out of their sockets, and of being retracted again to the level of the orbits. The species frequent the bottom of the sea. They are often furnished with barbels, and have also a peculiar membranous filament under the tongue, which they can protrude at pleasure. In the genus *Trachinus* the head is compressed, the eyes are placed high and close together; there is a long sharp spine on the hinder part of the gill-cover. There are two dorsal fins; the second dorsal and the anal are long; the ventrals are close to the throat. Two species are found on the British coasts, the **GREAT**ER W. or **STING-BULL** (*T. draco*), and the **LITTLE W.** or **VIPER W.** (*T. vipera*). The former attains a length of nearly one foot; the latter, seldom of more than four or five inches. The general form is long, narrow, and compressed; the Little W. is proportionally deeper in body than the Greater Weever. The head of both is short, compressed, flat between the eyes, and rough on the summit; both dorsals and the anal fins are spiny; and in both the gill-cover is furnished with a strong and sharp spine, which is directed backward, and can be appressed to the body, but which is also capable of being made to stand out so as to present its point to an adversary. Both species are of a yellowish brown colour. They inhabit parts of the sea having a sandy bottom, and often partially bury themselves in the sand, but are ready to move off with great celerity if disturbed. They can live long out of the water; and if left by the retiring tide, suffer no



inconvenience. If assailed, they can, by a sudden bending of the body, make use of one of the strong spines of the gill-covers against the assailant; and the wound thus inflicted is so severe, as to lead to the opinion that the spine is coated with a venomous exudation. Naturalists, however, generally supposed the popular opinion to be erroneous, and the severity of the wound to be merely owing to the laceration effected by the spine, until it was discovered by Dr Günther, in 1864, that poison-glands existed in connection with spines of some South American fishes of the family *Silurida*. A peculiar stinging sensation attends a wound by a spine of a W., which extends far up the arm, if the wound has merely been in a finger, and is much more severe than the pain of a wasp sting. There is also a groove in the spine, which has perhaps something to do with the conveyance of the poison; but no poison-gland has yet been proved to exist. In France, the fishermen are required, under a penalty, to cut off the spines of weevils before selling them. Weevils are esteemed for the table.

WEEVIL (*Curculio*), a Linnæan genus of insects, now forming the tribe *Rhynchophora*, of the order *Coleoptera*, and section *Tetramera*. They are remarkably characterised by the prolongation of the head into a beak or snout, at the extremity of which the mouth is placed, and from which the club-shaped antennæ spring. Some of them have straight antennæ; but the greater number have the antennæ *geniculated*, or bent forwards at the second joint. The species are very numerous, and are distributed over all parts of the world. They all feed on vegetable food, both in their larval and in their perfect state; and some of them are notable for the mischief which they do in the former state, to the young shoots, leaves, fruits, and seeds of plants. They are diurnal insects, many of them very small, but others of considerable size. They are slow, timid, and defenceless; although the long hard beak suggests to those ignorant of its real nature and of their habits an idea of danger in handling the larger species. Many of them are of very dull and uniform colour; but some are amongst the most beautiful of the *Coleoptera*—resplendent with the finest hues, and brilliant as gems. Such is the well-known Diamond Beetle (q. v.) of South America. The larvæ of weevils are soft, white, and footless, with very convex rings, hard heads, and horny jaws. The perfect insects are often found on leaves and in flowers of the particular kinds of plants on which they and their larvæ feed. *Rhynchites betuleti*, a W. often very injurious to vineyards, constructs a nest for its larvæ by rolling up the leaf of the vine, piercing the roll as it proceeds, and depositing eggs between the folds in the inner part of the roll. The larvæ feed upon the leaf, which the parents further adapt for their use by cutting the leaf-stalk half through, so that the leaf hangs down, and by the time they are ready to change into the chrysalis state, it drops off, or is blown off by the wind, when they bury themselves in the ground to wait for the return of spring. Other trees, as the pear-tree, are infested by weevils which destroy their leaves in a similar manner; the leaves of some, as of the peach, often suffer injury from weevils which devour them, like caterpillars, without rolling them up; and turnips are subject to the ravages of certain small species of W., which proceed in the same manner. Some species of W. gnaw young shoots. The shoots of fruit trees, and young grafts, are sometimes destroyed by weevils, which bore into them by means of their beak, and make a small chamber in the centre, in which an egg is deposited, being pushed into its proper place by the beak.

The shoot is then cut through a little lower down, and the parent W. may be seen climbing upon it, when the operation is nearly completed, to make it fall by her weight, and returning again to her work, if it is not yet ready to fall. She lays about two eggs a day, but continues her operations for many weeks, so that much destruction is effected. The larva feeds on the pith of the fallen shoot, and deserts it when ready to become a chrysalis, to bury itself in the ground.—The larva of a large species of W. (*Calandra palmarum*) inhabits palm-trees in South America, feeding on their central part, and is eaten and esteemed as a delicacy. When roasted, it almost melts into grease; but its flavour is said to be remarkably fine. This W. is black; about an inch and a half long; its larva is between two and three inches long. Another species (*Calandra sacchari*) is very destructive to the sugar-cane. Its larva is also eaten in the West Indies and Guiana.—The wood of pines and firs is the food of certain kinds of W., so that plantations suffer severely from their ravages. Thousands of acres of pines in the Southern States of America have been destroyed by a W. (*Hylobius pales*), not much more than a quarter of an inch in length; and some of its congeners in other countries are scarcely less destructive, as *Hylobius abietis* in Europe.—There are many species of W. which attack leaf-buds and flower-buds. Thus *Anthonomus pomorum* infests the apple-tree, depositing its eggs in the flower-buds, and cutting off the prospect of fruit. *Anthonomus pyri* is equally injurious to the buds of pear-trees. Some species of *Rhynchites* lay their eggs in fruits—as apples and plums—at an early stage of their growth, cutting the fruit-stalk, that the fruit may fall to the ground. The European Nut-W. (*Balaninus nucum*) lays its eggs in young hazel-nuts, upon which the larvæ feed as the nuts grow; a nearly allied species attacks, in like manner, the hazel-nuts of America, and another infests acorns. The Pea-W. (q. v.) feeds upon peas; and other leguminous plants have their peculiar species, which devour their seeds. The Corn-W. (q. v.) is very destructive to wheat, and other similar species to maize, rice, and other kinds of grain.

WEFT, or WOOFF, the thread which, in weaving, is passed by the shuttle backwards and forwards through the warp. See WRAVING.

WEIGHING-MACHINES are of various forms, according to the quantity and species of the goods whose weight is to be determined. The great majority of weighing-machines are founded upon the principle of the Lever (q. v.), the chief exceptions being the various forms of the Spring-balance (q. v.), to which might be added (though in such cases the term 'machine' is quite inapplicable) some of the methods employed to determine specific gravity, time of oscillation, &c. The simplest and primitive form of weighing-machine is the Balance (q. v.) with equal arms, which can be adapted either to the maximum of accurate weighing or to the most rapid equiponderance. But as this machine necessitates the *placing* in one scale of weights equal to the weight of the goods, it was soon found to be more convenient to employ a lever with unequal arms—the goods to be placed in the scale attached to the short arm, and therefore equipoised by less weights, the ratio of the weights in the two scales being in proportion to the ratio of length of the arms. On this principle the *steelyard* (see BALANCE), the *bent lever balance* (see BALANCE), and the *cart-steelyard* are constructed. But the convenience of equipoising a greater weight by one much less is counterbalanced by a considerable diminution in accuracy—one of the causes of error being the

greater liability to flexure of the longer arm of the lever; and another, the necessity, for convenience sake, of having the arm which is affected by the goods to be weighed as short as possible—the latter of itself reducing the accuracy of the steelyard to that of a symmetrical balance whose arms are each equal to the short arm of the steelyard. However, on behalf of the steelyard, there is again the advantage of rapid equipoise. Each of these machines is variously constructed, the modifications having reference either to convenience of use, or to the species or weight of the goods to be weighed: an example of the former is the equal-armed balance (fig. 1), made

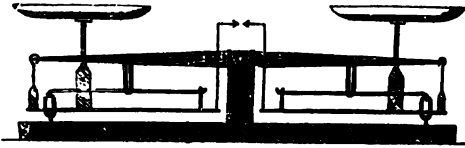

Fig. 1.

in an inverted manner, with the scales above, and the rods which connect the scales with the beam so united as to preserve their perpendicularity during oscillation; and the latter is appropriately illustrated by the form of cart-steelyard given in fig. 2. The dotted lines, DD, DD, indicate the grooved plates on which the wheels rest; E, E, E, E are the four points supporting the wheel-plates on the two triangular levers, CBB, CBB; the triangular levers

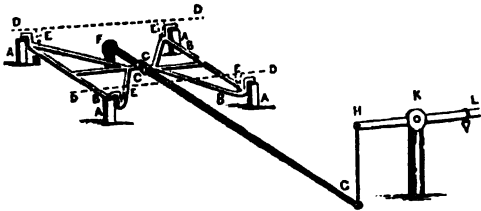

Fig. 2.

are supported by the hooked extremities of their bases, B, B, B, B, upon fixed supports, A, A, A, A; while their vertices, C, C, are attached to a lever, FG, whose fulcrum is at F; G is attached by a chain to H, the extremity of a lever of the first kind, whose fixed support is at K, and on whose other arm (graduated) the weights for equipoising the cart and its load are placed. The machine is thus seen to be compound, consisting of the two triangular lever pieces, of a simple lever of the second, and of one of the first kind; the weight L, if sufficient, raising H, and with it G, and thence raising C, and so balancing the downward pressure of the cart and its load at E, E, E, E. Various other forms of the cart-steelyard are in use. Mr Duckham's weighing-machine is an ingenious adaptation of hydrostatics.

**WEIGHTS AND MEASURES.** For the proper carrying on of mercantile transactions, and for many other purposes, it is necessary that there be fixed and readily-accessible standards of magnitude, of weight, and of value. The lengths implied by the names *a foot, a hand, a cubit, a fathom*, are far too indefinite to have long continued to satisfy the wants of civilised nations; and in every country, by common consent, or by the action of government, determinate measures have been agreed upon. These measures, left almost to chance, have been different from one nation to another, even from county to

county, sometimes from town to town, and still more awkwardly, often from one trade or guild to another.

Any one can appreciate the inconvenience of such a want of uniformity, for, in every transaction extending beyond his own sphere, he has to take account of the change of measure, the change of weight, the change of money, perhaps of all three at once. We all see and allow that there ought to be only one system of weights and measures in one country; that one bushel in Winchester, another in York—one acre in England, another in Scotland, and a third in Ireland; that Troy weights, avoirdupois weights, and all the other local, conventional, and trade variations which abound in the British dominions, form an aggregate of unbearable confusion, leading to endless mistakes and ceaseless quarrels. It is not more difficult to extend our observation, and perceive that if one system be advisable for one country, a universal cosmopolitan system would be no less advantageous for the whole world.

The only practicable method of establishing a system of measures is to construct standards of reference, and to preserve these carefully in some public place. In order that these standards may not be worn and injured by too frequent use, it is convenient to have authenticated copies deposited in the various towns, so that all dealers and artificers may have ready access to them, and so that all makers of weights and measures may be without excuse for errors in their workmanship.

To set up a standard of measure seems to be a very simple matter—the authorities have only to fix upon the proper length of a yard, to have a piece of wood or of metal made to that length, and to cause it to be properly marked and preserved. For common purposes, this seems to be quite enough: however, experience soon shows the inconvenience of this simple plan, for, by repeated contacts, the ends of the yard-measure get worn. Instead, therefore, of making a rod just a yard long, they make it a little longer, and upon it form two fine marks a yard distant from each other, and hold this distance to be the true standard. By this expedient, the effects of wearing are got rid of; copy after copy can be compared with the original, without deterioration of the standard.

But use is not the only cause of deterioration: wood decays or is worm-eaten, and metals are liable to oxidation, so that the material has to be carefully chosen. This is not all. Every substance which has been examined is found to change its size with a change of temperature; the standard bar is shorter in winter than in summer; and the change, though it be so small as to be of no moment to the haberdasher, the wright, or the mason, is enough to cause great trouble to those engaged in very accurate work. Hence, in the selection of the substance to be used for the standard bar, we must have an eye to smallness of expansion as well as to durability. The substances available, taken in the order of their expansibility, are—*deal, glass, platinum, gold, silver, iron, brass, copper*. Deal may be put aside as wanting in durability, and the choice may be said to lie between glass and platinum, neither of which is much acted on by the air, or by the vapours which are found in the atmospheres of large towns. The fragility of glass and the costliness of platinum are objections; but the latter is a mere trifle when a national standard is concerned. Platinum, then, seems to be the best substance.

The standard measure for the British Empire is a brass rod, into which two pins of gold are inserted; these are dressed flat with the surface of the bar, and a small dot is made in the middle of each. The

## WEIGHTS AND MEASURES.

distance between the centres of these dots, taken when the temperature is at 62° F., is declared to be the true yard.

In the same way as the standard of measure, so must the standard of weight be established. A piece of heavy metal is made of the desired weight, and is duly authenticated. The preservation of the standard of weight is a matter of very considerable difficulty. Every occasion on which it is used, each removal of dust from its surface, the actions of the oxygen of the air and of the products of combustion which are always floating about, produce a sure though slow waste; and all that can be done is to retard this waste as much as possible. Perhaps a lump of platinum would make the best standard; but its softness is a decided objection.

In the use of a standard of weight, another matter has to be taken into consideration. The apparent weight of any substance is less than its true weight by the weight of as much air as is displaced by it. Now, the density of the air is not constant—air, when warmed, expands very much more than any solid body; and therefore a piece of metal appears to weigh more in warm than in cold weather. Not only so, air is rendered more dense by an increase of pressure, and so, when the barometer is high, all heavy bodies become apparently lighter; when the barometer sinks, they appear to become heavier. Thus the apparent weight of the standard pound is continually changing. If we accurately adjust two weights of brass when the barometer is low and the air warm, and afterwards compare them when the barometer is high and the weather cold, we can perceive no change, for, though each has lost weight, they have lost alike. But if we had adjusted a weight of iron to a weight of platinum in light air, and again compared them in dense air, the change would have been at once seen. For, since a pound of iron is more bulky than a pound of platinum, it displaces more air, and its apparent weight undergoes a greater change than does that of the platinum. Fortunately, these changes are too small to have any perceptible influence on mercantile transactions, yet they are sufficient to create the necessity for it being enacted that the standard weight must be held as true when the air is in a specified state as to warmth and pressure. The standard brass pound, which serves for the British Empire, is directed to be used when Fahrenheit's thermometer is at 62°, and when the barometer is at 30 inches.

The thought naturally arises, what if, in the course of time, the original standards be lost or destroyed?

Time was when a seed of wheat gathered from a well-ripened ear served sufficiently well to define a grain weight; and even now the Eastern jewellers weigh their gems against the *carat* or carob-bean, the hardness and uniformity of which seem to justify the selection of it. But for the extended purposes of modern commerce, and particularly for the more delicate requirements of scientific research, it is indispensable that we find some unchanging object of comparison; and none can be preferred to the earth itself, as the most universally acceptable and as the best defined. For the purposes of geographers and navigators, the circumference of the earth is divided into degrees and minutes, the length of one minute being the geographical or nautical mile; and it certainly would have been convenient if the common or statute mile had agreed with this. The dimensions of the earth are now known with a precision far greater than is needed for ordinary purposes; the entire length of the circumference of a meridian circle being 131,236,000 of our standard feet, so that the length of a nautical mile is 6075

feet and about 9 inches; and it is highly probable that subsequent and more accurate measurements will not alter this determination more than an inch or two either way. It is usual to divide the minute into 60 seconds, so that a second of the earth's circumference is 101.25, and thus if our standard foot had happened to be one-eightieth part longer than it is, there would have been exactly 100 feet in a second, and 6000 feet in a nautical mile. When we reflect on the disparity of the foot used by different nations, and recollect that 100 Vienna feet make 103.6 English, as many Amsterdam feet 92.7, as many Berlin feet 99.2, we can hardly help regretting that our forefathers had not happened to hit upon the exact 100.

The ancient Greeks were fond of dividing into sixties; this division still continues in our scales for angles and for time; and it is worthy of remark, that if we divide the whole circumference of the earth into 60 parts, each of these into 60, and again each into 60, we arrive at a distance of 607.5 English feet. Now, the length of the ancient Greek stadium or furlong is stated to be 606½ feet by some writers; and if deduced from measures of the Roman mile, is between 605 and 613 feet; so that if we desire a cosmopolitan standard, we can hardly do better than go back to the ancient Greek *stadium* or the Chinese *li*, corrected to suit the more accurate determination of modern times: this would bring us to the geographical foot, one-hundredth part of a second of the earth's meridian.

The standard of weight is readily connected with the standard of measure. Some substance which can be easily obtained pure is chosen, and a definite bulk of it is weighed. Distilled water is universally selected for this purpose; and in the British system, the weight of one cubic inch of pure water is declared to be 252.458 grains when it is at the temperature of 62° F.

It has long been known that water does not continue to contract as it is cooled; the contraction becomes less and less as the temperature approaches to 41° or 39° F.; and the water, when cooled more, begins to expand, and continues to grow more bulky until it be on the point of freezing. On this account it has been proposed, and without any doubt it would be the best plan, to take water when at its greatest density as the standard for comparison, because then an error of a degree in temperature will produce no perceptible error in the weight.

The operation of verifying the standard of measure by comparing it with the size of the earth is necessarily an expensive and a complicated one, only to be attempted under the auspices of a wealthy government, or with the concurrence of several nations; and it is desirable to find out something more local and more easily obtained wherewith to compare our measures. The length of the Pendulum (q. v.) has been proposed; and, on account of a very simple and beautiful property of pendulums, the comparison can be readily made. If we imagine an excessively minute heavy body to be suspended by a thread so fine that the weight of the thread may be neglected, the compound so formed is called a simple pendulum; and the question becomes, what must be the length of such a pendulum in order that it may vibrate from side to side in, say, one second of time. Now, it is clear that we cannot obtain this length by direct experiment, since we cannot construct such a pendulum. M. Biot tried to approximate to it by using a small ball of platinum hung by a very fine wire. However it is known that if a heavy rigid mass, AB, be suspended by a knife-edge C, and if its vibrations be made in the same time with those of a simple pendulum of which the length is OD, then if we place another knife-edge

at D, and reverse the ends A, B, the compound pendulum will again vibrate in the same time as before. Hence, we have a very simple method of comparison. Having constructed a strong bar with two knife-edges at a known distance from each other, say at the distance of a yard; let us then by many trials, filings, and scrapings, so adjust it as that the times of vibration shall be alike for the two knife-edges, and, finally, let us count how many vibrations such a pendulum makes per day, and then we shall have a means of verifying our measure.



The act of parliament which fixes our present weights and measures, enacts that the length of a pendulum vibrating in one second of mean solar time is 39.13929 inches: now the lengths of pendulums are proportional, not to the times in which they vibrate, but to the squares of those times; and so, if we know the length of one pendulum, and the number of vibrations it makes per day, we can calculate what ought to be the length of another to vibrate a given number of times. A convertible pendulum having the distance between its knife-edges exactly 36 inches, ought to make 90088.42 vibrations per day.

When only a degree of accuracy sufficient for commercial and ordinary purposes is aimed at, the above process is by no means difficult; but when extreme precision is wanted, the operation is attended with many and very great difficulties; it involves considerations which would hardly have been

expected. In the first place, our experiments are made in air, and the buoyancy of the air lessens the actual weight of the pendulum; that buoyancy has to be allowed for, and therefore it is declared that the above length is that of a pendulum vibrating in a vacuum. Next, since the earth has a diurnal motion on its axis, every substance placed on it has a centrifugal tendency which goes to modify what otherwise would have been its gravitation; this centrifugal tendency produces the earth's oblateness, and causes a variation in the intensity of gravitation from one latitude to another. A stone is actually heavier in Edinburgh than it is in London. This change in gravitation cannot be measured by a balance, because the weights at each end of the balance are changed alike; but it is seen at once in the going of a clock; for a pendulum regulated to go truly in London is found to go too fast when taken to a higher latitude, and to lose time when carried nearer to the equator. Hence, the enactment that the pendulum must be swung in the latitude of London. And again, the attraction which the earth exerts upon bodies placed near it diminishes with their distances, being inversely as the squares of the distances; hence, a clock carried from the bottom to the top of a hill loses time perceptibly, and so it is necessary to have the additional enactment that the pendulum be swung at the level of the sea.

In addition to these niceties, there are others connected with the manipulation, such as the parallelism of the knife-edges, their bluntness, the extent of the area of oscillation, and the stability of the supports, so that altogether the exact measurement of the length of the seconds pendulum is a matter of very great complexity. All these difficulties and troubles notwithstanding, we may hold that for all practical purposes, our system of weights and measures—and it may be added, the systems of all other civilised nations—is perfectly well established, whether it be regarded as derived from

the dimensions of the earth, or from the intensity of gravitation.

No system of measures can ever claim to be of universal application from which geographical dimensions are excluded. It is essential that the unit of measure bear some simple relation to the earth's circumference, for otherwise the operations of the surveyor will not accord with those of the geographer. The only question, therefore, in regard to the establishment of a cosmopolitan system, is as to the number of parts into which the earth's circumference is to be divided. Now, the denary system of numeration has already asserted its supremacy; one by one the schemes followed by different nations have given way to it, and their very languages have been modified by its influence; sufficient traces remain to shew how extensive these modifications must have been. The *three-score and ten* is not yet forgotten in English, nor the *quatre-vingt dix neuf* in French. In many trades the counting is still in dozens and grosses; yet our merchants count their interest, their discount, and their dividends in cents. The surveyor divides the foot on his levelling staff into tenths, hundredths, and thousandths; he makes his Gunter-chain of 100 links. The astronomer no longer divides the second into sixty thirds, but into hundredths; he gives his equinoctial time in decimal fractions of the day, and he makes the arguments for the planetary disturbances in thousandth parts of the whole revolution. There is no single instance in which the decimal system, once adopted, has been abandoned; slowly, but surely, its influence will increase until it have displaced every other system. See DECIMAL SYSTEM.

No one opposes the abstract principle that one system for the whole world would be best; but each nation retains an excusable partiality for its own measures. We can never do away with our good old English penny; what! shall we give up our time-honoured standard yard, and adopt the new-fangled French *mètre*? Admit the force of such short-sighted arguments as these for ourselves, and we must admit them for all other nations, we must remain where we are. The very idea of a cosmopolitan system carries with it that of national abnegation; and of this the French set a noble example; they put aside their ancient *toise*, their *lieu*, their *pie*, and their *poise*, to adopt a measure which commends itself to all nations alike by its want of nationality, and which consequently has been already adopted by almost every European country, and several American states.

WEIGHTS AND MEASURES have, since 1824, been in great measure regulated by statute. The statute 5 Geo. IV. c. 74 was passed to enforce uniformity in the weights and measures used in various parts of Great Britain and Ireland; and a standard yard was defined as being then in custody of the clerk of the House of Commons, and it was enacted that all superficial measures should be computed and ascertained by the said standard yard. The act also described how, if the said standard yard were to be lost or destroyed, another was to be made. So the statute defined a standard brass weight of one pound troy, and a standard gallon. That statute was altered by a subsequent statute of 5 and 6 Will. IV. c. 63, and inspectors were authorised to be appointed by justices of the peace, who had power to examine and stamp weights and measures. It was enacted that any contract, bargain, or sale made by any weights or measures unauthorised by the act should be wholly void, and every such weight might be seized by the inspector, and forfeited. One or two exceptions were made by the act—such as weights above 56 lbs.; wooden or wicker measures used in the sale of lime; glass and earthenware jugs or

drinking-cups, though represented as containing the quantity of any imperial measure, or any multiple thereof, and these are not illegal, though incorrect. By a later act of 22 and 23 Vict. c. 56, inspectors have power to inspect the weights and measures of persons selling goods in streets and public places. By a statute of 29 and 30 Vict. c. 82, the custody of the imperial standards of weights and measures has been transferred to the Board of Trade; and periodical comparisons are to be made every ten years of certain standards.

WEIMAR, a small but interesting town of Germany, capital of the grand duchy of Saxe-Weimar-Eisenach, and residence of the grand duke, 60 miles south-west of Leipzig by railway. It stands in a pleasant valley on the left bank of the Ilm; but the environs are in no way remarkable, and the town itself is irregularly and rather poorly built. Though the residence of the court, and finding its subsistence in providing for the wants of distinguished visitors, W. carries on neither trade nor manufactures, and seems a dull, provincial-looking town. The lustre conferred upon W. by the residence here, at the close of the 18th and the earlier portion of the 19th centuries, of Goethe (q. v.), Schiller (q. v.), Herder (q. v.), and Wieland (q. v.) at the court of Karl-August (see SAXE-WEIMAR-EISENACH), has faded since that group was broken up by death; and now the interest of the town is almost wholly derived from its monuments, traditions, and associations. The town church (*Stadtkirche*), dating from the year 1400, has an altar-piece by Cranach, and contains a number of memorable tombs, among which are those of the brilliant soldier, Bernhard of Weimar (q. v.) and of Herder, the philosopher and critic. The ducal palace is a handsome building, some of the apartments of which are decorated by frescoes illustrating the works of Goethe, Schiller, Herder, and Wieland. The public library contains busts of these men of genius; and a number of relics, as the gown worn by Luther when a monk, and Gustavus Adolphus's leather belt, pierced by the bullet that caused his death at Lützen. The houses of Goethe, Schiller, and Herder are still pointed out. The two former of these poets lie interred in the grand-ducal burial-vault. The park and gardens of the palace, within which is the summer residence of Goethe, are much esteemed as a promenade. Pop. (1871) 15,998.

WEIR, or WEAR. See SUPP., Vol. X.

WEISSENFELS, a town of Prussia, in the government of Merseburg, and 12 miles south of the town of that name, on the Saale. Pop. (1871) 15,443, employed in the porcelain-factory and in wool-spinning, shoemaking, the manufacture of pianofortes, tanning, and a trade in timber. The castle, once the residence of the dukes of W., is now a barrack.

WELCKER, FRIEDRICH GOTTLIEB, one of the most distinguished scholars of Germany, was born in the year 1784 at Grünberg, in Hessen-Darmstadt; studied at Giessen; was appointed one of the masters of the Gymnasium there in 1803; and in the year 1806, travelled to Rome, where he remained two years. Here he became acquainted with the celebrated Danish archaeologist, Zoega, whose *Life and Essays* he afterwards published, and by whose example he was stimulated to that subtle appreciation of the works of ancient art which appears everywhere in his works. On his return from Italy, he was appointed to a professorship of Ancient Literature, first in Giessen, then in Göttingen, and finally (1819) in the newly erected Prussian university of Bonn, which continued to be the scene of his scholarly activity till his death in 1868.

W. belonged to that class of scholars who, since

Heyne and Wolf, have given such a lofty inspiration, such a philosophical significance, and such a historical comprehensiveness to those studies which, for want of a better name, we are forced still to designate philology. But philology in this country generally means the history and philosophy of language; with the Germans, as it did originally with the Alexandrian Greeks, it means, the sympathetic understanding and the imaginative reconstruction of the life and thought of famous ancient peoples, based on the critical treatment of ancient documents, or the tasteful appreciation of the monuments of ancient art. It is needless to say that this 'philology' is a very different thing from the minute verbal and metrical preciseness which was long the leading characteristic of scholarship in this country. For however important these minutiae may be in their place, they are manifestly valuable only as means to an end; and even when the end has been steadily kept in view, it cannot be denied that some of our greatest intellects have spent more of their strength on these subsidiary matters than their importance deserves. In W., Otrifed Müller, and other German scholars of the first class, we see a general reaction against this narrow school; and a reaction which was sure to prosper, as it was based on thorough academic training, and had learned to neglect no trifle and despise no minute point which could be made subservient to higher purposes. If it was the fault of German scholarship generally that it was too professional and too academic, it is the praise of Müller, W., and the school to which they belong that they have bridged over the gulf which separates learning from life, and inspired the dry bones of tradition with a spirit which makes them intelligible to the present, and significant of the future. The long academic career of W. was distinguished by an uninterrupted course of scholarly activity. Many of his works are tracts and essays on archaeological subjects without external unity, but all exhibiting a remarkable combination of extensive and accurate learning, fine taste, delicate sensibility, and sound judgment. We can only note here his three most important works of a larger compass. The first is the *Æschylean Trilogy* (1824), in which the organic connection and sequence of the Greek dramas are set forth with a richness of constructive detail not altogether free from that fanciful and problematic element which is one of the most distinguishing characteristics of German scholarship. The second is the *Epic Cycle* (1835—1849), a work which has done great service to the right appreciation of early Greek literature, by taking Homer out of that region of mysterious isolation in which he had been previously allowed to remain. The third, and perhaps his greatest work is the *Götterlehre*, or Greek Mythology (1857—1862), which embraces all that is good, and rejects all that is bad in the wide German literature of this subject, with a delicate tact and a just discrimination as valuable as they are rare. Of all W.'s works, this is the one that would most probably bear with credit the ordeal of an English translation.

WELD, or WOOLD, also called DYER'S ROCKET, DYER'S WEED, and YELLOW WEED (*Rhus Luteola*), is a plant of the same genus with MIGNONETTE (q. v.), a native of waste places in England, very common in Germany and in many parts of Europe. It has an upright stem, 2—3 feet high; lanceolate, undivided leaves; and long racemes of small yellow flowers, with 4-partite calyx and prominent stamens. It is used for dyeing. In order that it may yield a good dye, it requires to be cultivated with care. The best is grown in France, England, and

Holland; and that produced about Cette, in France, is preferred to all other. Good W. must have flowers of a beautiful yellow or greenish colour, and abound



Dyer's Rocket (*Reseda luteola*).

in leaves; that which is small, thin-stemmed, and yellow, is better than that which is large, thick-stemmed, and green; that which grows on dry sandy soils is better than that produced on rich and moist soils. It was formerly cultivated to a much greater extent in Britain than it is at present, and was also more used by dyers than it now is. W. is still, however, a valuable dye-stuff. It serves equally for linen, woollen, and silk, dyeing not only a rich yellow, but, with proper management, all shades of yellow, and producing a bright and beautiful colour. Stuffs previously dyed blue are, by means of W., changed to a very pleasing green.

Large quantities of W. are imported from France.

**WELDING**, the process by which some substances are united together in a softened state. It is generally applied to such metals as malleable iron, two pieces of which, heated to redness, may be made to unite by applying them together and beating with a hammer. Other substances, such as horn and tortoise-shell, can be welded by first making separate pieces soft by heat, and pressing them together, which causes so intimate a union that no traces of the junction remain after cooling.

**WELLESLEY, RICHARD COLLEY WELLESLEY, MARQUIS, K.G.**, English statesman, was born at the town residence of his family, Grafton Street, Dublin, June 20, 1760. The family of Wellesley was of Saxon origin, belonging to the county of Sussex, and was among the most ancient in Ireland, one of them having gone from England as standard-bearer to Henry II., who gave him large grants of land in Meath and Kildare. William de Wellesley was, in 1334, summoned to parliament as Baron Noragh, and was high in favour with Edwards II. and III. The name (originally *Welesley* or *Welseley*) was written Wellesley till the 16th c., when it became abbreviated into Wesley. Mr Garrett Wesley of Dangan, county Meath, married Miss Colley, of Castle Carbery; and on the decease of his son without issue, the estates were bequeathed to his cousin, Richard Colley, who thereupon assumed the name of Wesley. The Colleys, originally Cowleys, were also of ancient descent, and came originally from Rutlandshire. Richard Colley, who thus succeeded to the Wellesley estates, though in no way related by blood to the earlier Wellesley family, was created Baron Mornington. His eldest son received (1760) the dignities of Viscount Wellesley and Earl of Mornington, and enjoyed the still more enviable distinction of being the father of the Marquis Wellesley, the subject of this notice, and of Arthur, first Duke of Wellington, by his marriage with the eldest daughter of Arthur, first Viscount Dungannon. W.'s father, the first Earl of Mornington, although chiefly known for his talents as a musical composer, was a man of great abilities. W. received his education at Eton, and afterwards at Christchurch, Oxford, at both which

seats of learning his fame stood high. An eloquent speech was made by him at Eton as early as 1778; and in 1780, he gained the University prize for the best composition in Latin verse, in which he excelled through life. His father having died in 1781, W., on attaining his majority, took his seat in the Irish House of Peers, took upon himself the pecuniary obligations of his father, and placed the estates under the management of his mother, who survived her husband for nearly half a century. The debts of the first earl were liquidated, but W. was unable to preserve the family possessions. He was one of the original Knights of St Patrick when the order was founded by George III. in 1783. It appears, from a correspondence between Pitt and the Duke of Rutland, that at the age of 24 he had convinced both statesmen that he was destined to distinguish himself, and to render the public essential service. Dissatisfied with the limited field of distinction which Ireland afforded him, he obtained, in 1784, a seat in the British House of Commons as member for Beer-alston. In 1786, he became one of the Lords of the Treasury, when he was elected for Saltash. Being unseated on petition, he obtained a seat for Windsor, and became a favourite of George III. Accident directed his attention to India, and in 1795, he became one of the unpaid members of the Board of Control. In October 1797, he received a seat in the House of Lords as Baron W.; and, at a most eventful period, was selected to go to India as governor-general. Four powers then divided the sovereignty of India—the British; Tippoo Sahib; the Nizam; and the Mahrattas, comprehending Scindiah, Holkar, and the Rajah of Berar; and the west of India was the scene of invasion by Zemaun Shah. Tippoo hated the English, and meditated their expulsion from India; and the troops in the service of the Nizam and the Mahrattas were officered by Frenchmen. When W. arrived at Calcutta, in May 1798, Egypt had been conquered by Bonaparte; and the native powers of India, incited by the French, were unfriendly to British rule. His first operation was one of great boldness. Disregarding the remonstrances of the Madras Council, he ordered the Nizam to disband 14,000 men, surrounded them with a British force, secured the 124 Frenchmen by whom they were officered, and sent them instantly to Europe. Having annihilated French influence, he began the reduction of the empire of Mysore. On the 3d February 1799, he ordered General (afterwards Lord) Harris to march with an army of 20,000 men direct from the coast upon the Mysore capital. He himself removed to Madras, to be near the scene of this eventful operation. In one short month, the fortress of Seringapatam was taken, Tippoo Sahib slain, and his dominions partitioned. Having thus, in fifteen months, destroyed French influence, struck terror into the native princes, and overthrown the most inveterate enemy of British rule in India, he returned to Bengal. Up to this period, he had been the Earl of Mornington; he was now (Dec. 1799) created by the king Marquis of W., and received the thanks of parliament. The East India Company offered him £100,000 of the prize-money realised at Seringapatam, but he refused, disdaining to be enriched out of military spoil. He afterwards accepted an annuity of £5000 voted him by the Court of Proprietors. His next step was to place the territories of the Nabob of the Carnatic under the administration of the Company, in consequence of the treachery of that prince. He also concluded a treaty with Persia, to which he attributed 'the fall of Zemaun Shah, the confusion of the Afghan government, and the repression of the annual project of invading Hindustan from Cabul'—then, as since, the nightmare of Indian statesmen. In 1801,

he sent a force of 7000 men up the Red Sea, to assist in wresting Egypt from the French. The expedition, under General Baird, reached Egypt, and effected a junction with the army from England; but the French had already surrendered. In 1802, in consequence of differences with the Court of Directors, he tendered his resignation; but was induced to continue in office until January 1806. The Mahratta war broke out; the battles of Laswaree, Assaye, Argauum, and Delhi were fought; and Scindiah, the Berar Rajah, and Holkar were stripped of their dangerous influence, and reduced to submission. A large accession of territory rewarded the gallantry of the army; and in 1805, W. returned to England, after the most brilliant administration ever known in India. He had outdone even the native princes in the pomp and splendour of his progresses. He built the palace of Calcutta; founded and patronised the college for Indian literature; stimulated every attempt of natives and Europeans to bring to light the vegetable, mineral, and physical treasures of the 'golden peninsula;' and inaugurated those important financial reforms which in a brief period raised the revenue of the Company from 7 to more than 15 millions sterling. On his return, he was received with every mark of respect and approval by the directors; but as matter of course, there were many complaints that his administration had been oppressive, especially towards the native powers; and articles of impeachment were even presented to the House of Commons, though they were rejected with contempt. He now prepared to enter anew upon a parliamentary career. George III. wished him to be one of the secretaries of state in the Portland cabinet, but he declined the offer. He went to Spain as ambassador-extraordinary in 1809; landed at Cadiz on the day the battle of Talavera was fought, and on the 2d November met his brother, the Duke of Wellington, at Seville. In December 1809, he was appointed Secretary of State for Foreign Affairs; and in 1810, was elected a Knight of the Garter. He was favourable, both in and out of office, to the repeal of the penal laws affecting the Roman Catholics; and when, in January 1812, the Prince Regent refused to agree to a concession of Roman Catholic claims, W. resigned his seat in the cabinet. During the first ten years of the administration of Lord Liverpool, he remained in opposition. He protested against the insufficiency of the means placed at the disposal of the Duke of Wellington, and did not cease to demand that he should be assisted to the utmost extent of the national credit and resources, until the Duke had crossed the Pyrenees at the head of his victorious army, and brought the war to an end before Toulouse. When the settlement of the affairs of Europe was being arranged in 1815, W. protested against the neglect of commercial interests, but without effect. He now began to ally himself with the more liberal section of the Conservatives, who looked up to Mr Canning as their leader, and accepted the office of Lord-lieutenant of Ireland. Conciliation was to be the principle of his government, but he held office for five years without effecting any material amelioration, owing to the difficulties arising out of the state of the penal laws. He was recalled from Ireland by his brother when he took office in 1828. In 1830, W. accepted the post of Lord-steward of the Household from Earl Grey; and in 1833, in the 74th year of his age, he again proceeded to Ireland as viceroy, where he remained until Sir R. Peel's administration of 1834. In 1835, on the restoration of the Whig party, he accepted the post of Lord Chamberlain, which he only held for a few months. In 1837, it became known to the Directors of the East India

Company that he was in straitened circumstances, and deriving little if any advantage from their annuity of £5000 per annum; they therefore resolved that a sum of £20,000 should be vested in trustees for his benefit. In 1841, it was further resolved that his statue should be erected in the court-room, as a mark of the admiration and gratitude of the East India Company. He died at Kingston House, Knightsbridge, on the 25th September 1842; and, in compliance with his will, was buried in the vault at Eton College Chapel. An authentic record of his Indian administration was undertaken by Mr Montgomery Martin, under the direction and at the expense of the East India Company, and published in 1836 in 5 vols. 8vo, entitled *Despatches, Minutes, and Correspondence of the Marquis Wellesley, during his Administration in India*. A thin 8vo vol. issued in 1838 contains *Despatches and Correspondence of the Marquis Wellesley, during his Mission to Spain*. The marquis published several pamphlets on various occasions: *Substance of a Speech in the House of Commons on the Address in 1794; Notes relative to the Peace concluded with the Mahrattas; Letters to the Government of Fort George, relative to the new form of Government established there; Letters to the Directors of the East India Company on the India Trade; &c.* He was twice married, but left no issue, and the marquisate became extinct at his death; the earldom, &c., went to his next brother, but afterwards reverted to the second duke of Wellington, as son of the great duke, who was third brother.

**WELLINGBOROUGH**, so called from the medicinal springs in its vicinity, is a market-town in the county of Northampton, 10½ miles east-north-east of the town of that name. It carries on a considerable trade in corn, boots, and shoes. Pop. (1871) 9385.

**WELLINGTON, ARTHUR WELLESLEY, DUKE OF, K.G.**, one of England's greatest generals, was the third son of Garrett, first Earl of Mornington, and brother of the Marquis Wellesley (q. v.). He was born May 1, 1769, at Dangan Castle, Ireland, and completed his military education, a few years before the French Revolution, in the military college of Angers, in France. He entered the army as ensign in the 41st Regiment in 1787, and became lieutenant-colonel of the 33d in 1793. In 1794, he embarked in command of the 33d Regiment, to join the Duke of York's army in the Netherlands. In this, his first term of actual service, he commanded three battalions on the retreat of the army through Holland, and distinguished himself in several repulses of the French. In 1796, he accompanied his regiment to India, where his brother, the Marquis Wellesley, shortly afterwards arrived as governor-general. He commanded the subsidiary force of the Nizam, when the reduction of the Mysore was decided upon, and his division defeated Tipoo Sultan's right flank at Mallavelly. At the assault and capture of Seringapatam, he commanded the reserve in the trenches. He was appointed to the command in Mysore, and took the field (1800) against Dhoomdiah Waugh, a Mahratta freebooter, who was defeated and slain. He was named second in command of the expedition which sailed from India to assist the English army in Egypt, but was prevented from embarking by illness. It was in the Mahratta war of 1803 that the young general won his first fame. After besieging and capturing Ahmednuggur, W., with only 4500 men, came upon the combined Mahratta forces, 40,000 or 50,000 strong, and not waiting for a larger British force that was on its way, won the brilliant victory of Assaye (q. v.). The victory of Argauum followed; and the great fort of Gawulghur, supposed to be impregnable,

having been taken in December, the Mahratta chiefs sued for peace, after one of the most extraordinary campaigns on record. W. was made K.C.B., and received the thanks of the king and parliament. In 1805, he returned to England, and in November commanded a brigade in Lord Cathcart's expedition to Hanover. In 1806, he obtained a seat in the House of Commons for Newport, Isle of Wight; and in April 1807, was appointed Chief-secretary to Ireland, the Duke of Richmond being Lord-lieutenant. He held a command in the army under Lord Cathcart, in the expedition against Copenhagen in 1807; and after the affair at Kluge, negotiated the capitulation of Copenhagen. He received the thanks of the House of Commons in his place, and returned to Ireland. In 1808, he commanded an expedition which sailed from Cork, being the first division of the British army sent out to assist in the expulsion of the French from Spain and Portugal. He landed at Corunna, and offered his aid to the army and people of Galicia; but the offer being declined, he finally landed (August 1808) with 10,000 troops at the mouth of the river Mondego, in Portugal. The whole of the north of Portugal was then in arms against the French. The affairs of Obidos and Roliça were quickly followed by the battle of Vimieira, in which he defeated Junot, who lost 3600 men and 13 pieces of cannon. After this event W. signed the armistice which led to the Convention of Cintra (q. v.). He subsequently gave evidence generally in favour of this Convention at the Court of Inquiry (November 22). Being superseded in the command of the army by men who were only his superiors in military rank and seniority, he returned to England. For the battle of Vimieira, he again, in his place, received the thanks of the House of Commons. On the death of Sir John Moore, he returned to re-assume the command of the Peninsular army, previous to which he resigned the office of Chief-secretary of Ireland. He arrived at Lisbon, and assumed the command April 22, 1809. He had now to contend with Soult and Victor, who had entered Portugal at the head of a veteran army, and were in possession of its finest northern provinces. Oporto had been taken by Soult, and W. was anxious to bring him to action at once, in order that he might not make his retreat unharmed. The passage, at Villa Nova, of the Douro, a wide, deep, and rapid river, in the face of a formidable enemy, who had removed every boat and barge to the opposite side of the river, was one of the boldest and most successful operations of the war. W. entered Oporto the same day, and followed the French army. He was now, by a decree of the Prince Regent of Portugal, Marshal-general of the Portuguese army. The French had fallen back to a point where reinforcements were to meet them; and on the 27th and 28th July 1809, the enemy, commanded by Victor and Sebastiani, were defeated by the British under W. at Talavera. The slaughter on both sides was terrible, in this desperate, almost hand-to-hand conflict. W. was unable to follow up his victory owing to the non-co-operation of the Spanish army under Cuesta; and the want of supplies, and the junction of Soult, Ney, and Mortier in his rear, compelled him to fall back upon Badajoz. The thanks of parliament were voted for the victory of Talavera, and Sir Arthur Wellesley was created (4th September 1809) a peer by the titles of Baron Douro of Wellesley and Viscount Wellington of Talavera, with a pension of £2000. In May 1810, the French collected under Massena in such superior force in his front that he fell back upon Busaco, where he made a stand. Here the French (September 27) made two attacks upon his position, but were repulsed with great slaughter. After

this, he retreated to Torres-Vedras (q. v.), to the occupation of which line of defence, and his judicious method of maintaining it, the ultimate success of the Peninsular war may be chiefly attributed. Massena, being unable to find subsistence for his army, began his retreat to Santarem, followed by W., who pursued the French in their retreat along the line of the Mondego. In April 1811, he received the thanks of parliament for the liberation of Portugal. Spain, however, was now subdued by the French. The Spanish armies were annihilated, and it was of the last importance that W. should be able to keep his rear open to the Tagus. W. having invested Almeida, Massena attempted to relieve it, but was skillfully repulsed at Fuentes de Onoro, May 3 and 5. The fall of Almeida followed, and W. ordered Badajoz to be invested. At this time, he had great reason to complain of the want of support and reinforcements from England. He had only the force which had followed Massena from Torres-Vedras, diminished by 9000 men, *hors de combat* in so many sanguinary encounters. Writing to Marshal Beresford, he said: 'I enclose a dispatch from Lord Liverpool [then at the head of the Home Government]; I believe they have all gone mad.' The siege was carried on with vigour; but learning that Soult and Marmont designed to join their armies en masse, in order to relieve Badajoz, and his own inadequate force not justifying him in risking a battle, he raised the siege, and retired to the frontiers of Portugal. He next laid siege to the strong fortress of Ciudad Rodrigo; and on the night of January 19, 1812, it was carried by storm, and the garrison made prisoners. For this achievement he was created by the Regency a Grande of Spain, with the title of Duque de Ciudad Rodrigo. He again received the thanks of parliament, and a further pension of £2000 a year, and was advanced in the British peerage by the title Earl of Wellington. He next marched towards Badajoz, invested it in March, and carried it by storm, April 6, after a frightful carnage; the allies losing nearly 5000 men. In June, he advanced to Salamanca, captured the convents there, which had been fortified by the French, and drove Marmont to the Douro. On the 22d July, he gained at Salamanca one of his greatest military triumphs. Marmont extended his line, with the view of turning W.'s right: but the latter, perceiving that the enemy had thus weakened their left and centre, vigorously assailed the weak points, and after an obstinate resistance, put the whole army to rout. Ammunition, stores, two eagles, eleven pieces of cannon, and 7000 prisoners, were the trophies of victory. The loss of the allies was only about 700 killed and 4000 wounded. Marmont lost an arm, and four French generals were killed. W. received the order of the Golden Fleece, entered Madrid, was made generalissimo of the Spanish armies, and was advanced in the British peerage by the title of Marquis of Wellington. The thanks of parliament were again voted to him, together with the sum of £100,000, to be laid out in the purchase of lands to be settled on him, his heirs, and successors. In September, he marched to Burgos, but failing to capture it, he again retreated to the frontiers of Portugal. W. visited Cadiz and Lisbon, where he was received by the whole population. In May, he marched his army into Spain in two columns, and on the 21st June gained, at Vitoria, another signal victory over the French, commanded by King Joseph, assisted by Marshal Jourdan. The enemy lost 151 pieces of cannon and all their ammunition. The king's private carriage, letters, &c., fell into the hands of the victors. In exchange for the bâton of Jourdan, which was found on the field, the



Prince Regent forwarded to W. the bâton of a field-marshal of England. By this splendid and important series of victories, he had reached the summit of martial glory. The deliverance of Spain from the French was now certain. His infantry were soldiers who would, in his own words, 'go anywhere and do anything;' and even the invasion of France itself seemed to his countrymen to be no longer chimerical. He pursued the French army to France by Pamplona. He failed, July 25, to carry San Sebastian by assault, but gained another decisive battle over Soult at the Pyrenees, and the French army retreated into France. A second attempt to carry San Sebastian by assault was successful, but it cost W. 2300 in killed and wounded. He now crossed the Bidassoa, and invaded France. Pamplona surrendered. After the passage and battle of the Nivelle, and the passage of the Nive, the victorious army of W. was attacked, December 10 to 18, on the left and right, by Soult, who was defeated. Leaving two divisions to blockade Bayonne, W. followed Soult with the rest of the army. On 27th February 1814, he defeated Soult at Orthes, and crossed the Adour. The affairs of Aire and Tarbes were followed by the passage of the Garonne; and on the 10th April, W. consummated this series of brilliant victories by again defeating Soult under the walls of Toulouse. The allied Russian and German armies having entered Paris, and Napoleon having signed his abdication a few days before, this last battle would not have been fought, but for the non-arrival of news of the events of Paris. In a few weeks W. was in Paris, presenting the trophies of his brilliant campaign to the allied monarchs. He was created, May 3, Marquis of Douro, and Duke of W. in the British peerage, and received an annual grant of £400,000. He received for the twelfth time the thanks of parliament for his services, and on his arrival in England was greeted with the utmost enthusiasm. On the 28th June, he took his seat for the first time in the House of Lords. He next returned thanks at the bar of the House of Commons, and was addressed by the Speaker. He was appointed ambassador-extraordinary to the court of France in July 1814, whence he proceeded to the congress of Vienna. Napoleon having escaped from Elba, the congress was abruptly broken up. W. was appointed commander of the British forces on the continent of Europe, and from Vienna joined the army at Brussels. It appeared probable that Napoleon would make a bold advance into Belgium, and its defence was assigned to an Anglo-allied army under W., and a Prussian army under Blücher. The battles of Ligny (q. v.) and Quatre Bras (q. v.) were succeeded on the 18th June 1815 by the great battle of Waterloo (q. v.). Here the grand and decisive blow was struck; here for the first and last time the Emperor and the great English general met and measured swords, and here the power of Napoleon was finally crushed. The allied armies, under W. and Blücher, marched upon Paris; the French army evacuated Paris under a convention; and Louis XVIII. entered Paris the very day after the English army. Marshal Ney was brought to trial. He relied upon the terms of the capitulation of Paris, and appealed in vain to W., who denied that the French king was bound by the convention—a reading which it is impossible to justify, as Sir A. Alison has shewn in his *History of Europe*. At the request of the allied sovereigns, W. took the command of the army of occupation, and resided in Paris from 1815 to 1818. Two attempts were, during this period, made upon his life: gunpowder was placed in his cellar for explosion; and one

Canillon discharged a pistol into his carriage; for which attempt at assassination, Napoleon I. left the miscreant a bequest in his will. When the allied armies evacuated France in 1818, the emperors of Russia and Austria, and the king of Prussia, created W. a field-marshal of their armies. He was created Prince of Waterloo by the king of the Netherlands. The gratitude of the British nation was, meanwhile, enthusiastically manifested. Statues were raised to his honour in the metropolis. Parliament voted £200,000, in addition to former grants; and the mansion and estate of Strathfieldsaye were purchased, to be held by W. and his heirs. The office of Master-general of the Ordnance, now abolished, but then comprehending the control of the artillery branch of the service, was conferred upon him. At the coronation of George IV., in 1821, he officiated as Lord High Constable of England. In October, he attended George IV. to the field of Waterloo. In 1822, he represented Great Britain at the Congress of Verona, where he ineffectually exerted his influence to prevent the invasion of Spain by a French army, in support of absolutist principles. In 1826, he went on a special embassy to St Petersburg, when he induced the Emperor Nicholas to act in common with England and other powers, as mediators in the quarrel between Turkey and Greece. On his return, he was appointed Constable of the Tower. In 1827, he succeeded the Duke of York as commander-in-chief of the army, and was made colonel of the Grenadier Guards.

From this period, his political career may be said to begin. When Mr Canning received the commands of George IV. to form an administration, W., with six other members of the Liverpool administration (including Lord Eldon and Peel), resigned office. In the explanations which he gave, he emphatically denied that he had entertained the ambition of himself filling the post of first-minister; and said he felt his incapacity for such an office so strongly that he should have been 'mad' if he had coveted it. In August 1827, after Mr Canning's death, he again accepted the command of the army, which he resigned on being called upon by George IV. (January 8, 1828) to form an administration. Of strong Tory politics, he was, nevertheless, the first minister to cede to the growing popular power. The Test and Corporation Acts were repealed, and the removal of the Catholic disabilities was the first measure proposed by W. in the following session, upon the ground of the formidable attitude of the people of Ireland and the danger of civil war. This measure involved him in a bloodless duel with the Earl of Winchelsea. The French revolution of 1830 appears to have influenced him in making a firm stand against reform in parliament, in the same proportion that it raised the demands of the people; and when the struggle of Continental Europe to emancipate itself from arbitrary government, strengthened the popular cry for 'parliamentary reform,' he chose the earliest moment to declare the unalterable perfection of the representative system of the country, and the determination of his government to resist all measures of parliamentary reform. His unpopularity became excessive; and anticipating a defeat in the House of Commons, on Mr Brougham's proposition for reform in parliament, W. resigned office, and was succeeded by Earl Grey. He had meanwhile become Lord Warden of the Cinque Ports. Under the administration of Earl Grey, W. held no office. He strenuously opposed the Reform Bill, and a London mob broke the windows of Apaley House, and hooted and pelted him in the streets. In January 1834, he was elected Chancellor of the university of Oxford. Upon the enforced resignation of Lord Melbourne,

in November 1834, he was sent for by William IV. He declined to take the premiership, and was intrusted by the king with the whole charge of the government, and the seals of the three Secretaries of State, until Sir R. Peel could arrive from Rome. Peel constructed a Conservative government, in which W. took the office of Foreign Secretary. In April, Peel resigned, and henceforward W. ceased to take a prominent share in the civil government of the country. He gave a generous welcome to Soult, who represented France at the coronation of Queen Victoria, and was received with great cordiality by the people on this occasion. In August 1839, a grand banquet was given to him at Dover, as Lord Warden of the Cinque Ports, on which occasion Lord Brougham proposed his health in a brilliant eulogium. In 1841, he accepted a seat in the cabinet of Sir R. Peel, without office. In 1842, the Queen visited him at Walmer Castle, and in the same year he was reappointed to the command of the forces. In 1845, he doubted the policy of repealing the Corn Laws; but in conformity with his usual practice, of considering 'how the Queen's government was to be carried on,' he determined to stand by Sir R. Peel in his attempt to abolish them. W. not merely consented to remain in the cabinet, but accepted the higher office of President of the Council in lieu of the post of Lord Privy Seal. When the bill came up to the Lords, W., with great emotion and earnestness, warned the peers not to reject the bill, and never to separate themselves from both the crown and the House of Commons. His speech made a great impression, and the bill passed a second reading by a considerable majority. He retired with the Peel government in July 1846. After this event, he may be said to have withdrawn from political strife, nor is it to be denied that his share in the repeal of the Corn Laws cast a halo of popularity around the remainder of his life. In 1848, he called attention to the unsatisfactory state of the national defences, in a letter to Sir J. Burgoyne. As commander-in-chief, he directed great preparations to be made to prevent a Chartist outbreak on the 10th April. His last speech in the House of Lords was delivered in support of the Militia Bill, when he declared that England had been carrying on war in all parts of the world with an insufficient peace establishment. On September 14, 1852, he was seized at Walmer Castle with an epileptic fit, became speechless, and died the same afternoon. His remains were honoured by a public funeral. The body, after lying in state at Chelsea Hospital, was removed to the Horse Guards; and on the morning of November 18, was borne through the streets of London to St Paul's Cathedral, where it rests by the side of that of Lord Nelson. The funeral pageant was witnessed by a countless multitude. His *Despatches*, published by Colonel Gurwood, in 12 vols., are the proudest monument of his glory; they exhibit him as a commander who overcame countless difficulties by honesty, sagacity, singleness and constancy of purpose, and devotion to duty. Throughout his long career, he appears the same honourable and upright man, devoted to the service of his sovereign and country, and just and considerate to all those who served under him. As a general, he was cautious, prudent, and careful of the lives of his men; but when safety lay in daring, as at the battle of Assaye (q. v.), he could be daring in the extreme. He enjoyed an iron constitution, and was not more remarkable for his personal intrepidity than for his moral courage. The union of these qualities obtained for him the appellation of the 'Iron Duke,' by which he was affectionately known in his later years. His parliamentary oratory was plain and to the point. He spoke without

fluency or art, yet his strong sense and practical sagacious judgment gave him great weight with his brother-peers. His tastes were aristocratic; and his aides-de-camp and favourite generals were almost all men of family and high connections. Altogether, he was the very type and model of an Englishman; and in the general order issued by the Queen to the army, he was characterised as 'the greatest commander whom England ever saw.' He married, in 1806, the second daughter of the third Earl of Longford, and by her (who died in 1831) he left two sons—Arthur Richard, the second duke (who also inherited the earldom of Mornington), and Charles, deceased, whose son, Henry Wallesey, is heir-presumptive to the title.

Colonel Gurwood's *Despatches of the Duke of Wellington*, 12 vols.; Gurwood's *General Orders of Duke of Wellington, 1809—1818*; Napier's *History of the Peninsular War*; Alison's *History of Europe*; Thibaudeau, *Histoire de l'Empire*; Thiers, *Histoire de l'Empire*; Marquis of Londonderry's *Narrative of the Peninsular War, 1808—1813*; Gleig's *Life of Arthur, Duke of Wellington*; Bourrienne's *Mémoires sur Napoleon*; Las Casas, *Mémoires de Ste-Hélène*; La Vie de Wellington, by Brialmont; *Speeches in Parliament of Duke of Wellington*; *Sir R. Peel's Memoirs*, by his Literary Trustees; *Despatches, Correspondence, and Memoranda of Field-marshal Arthur, Duke of Wellington*, edited by his son the Duke of Wellington, and issued in two volumes, published respectively in 1871 and 1872—uniform with Gurwood's edition; the former reaching from 1794 to 1812, and the latter from 1812 to the end of the military series. An official record of the thoughts and acts of the emperor was issued in Paris, with the sanction of Napoleon III., under the title *Correspondance de Napoleon I.*

WELLINGTON, a small market-town in the county of Somerset, 7 miles south-west of Taunton, at the foot of the Blackdowns, which are crowned by a monument commemorative of the battle of Waterloo. The town gives title to the Duke of Wellington. Blankets, serges, and other woollen goods and earthenware are manufactured. Pop. (1871) 5119.

WELLINGTON, a small market-town of Shropshire, 10 miles east of Shrewsbury, at the foot of the Wrekin, on the Shrewsbury and Shropshire Canal. The town forms the junction of several railways. It is situated in a populous mining and agricultural district, with coal and iron mines, iron-works, limestone quarries, and wire-mills in the vicinity; while, in the town, there are smelting-furnaces, nail-works, and malt-kilns. The spacious public market, with town-house and assembly room, cost about £20,000. Pop. (1871) 5926.

WELLINGTON, NEW ZEALAND. See SUPP., Vol. X.

WELLINGTONIA, a genus of trees, of the natural order *Conifera*, of which only one species is known, *W. gigantea*, the greatest of all pines, and indeed by far the largest tree of temperate climates. The genus is nearly allied to *Sequoia* and *Taxodium*. The foliage is very similar to that of an arbor vitae, the leaves being very small, like scales, and closely appressed to small slender branchlets. The leaves of young plants are longer and somewhat needle-shaped. The branches divide into very numerous small branchlets. The flowers are generally solitary and terminal, the male and female flowers distinct, but on the same tree. The cones of the *W. gigantea* are ovate, from 1½ to 2 inches long, by 1½ inch broad, single, or in opposite pairs, rarely clustered, the scales wedge-shaped, with about four seeds under each. The *W. gigantea* has a columnar stem, with

branches only on the upper half of it, the branches of comparatively small size, and not forming an umbrageous head. The stem attains a height of 300 feet, and sometimes more, perfectly straight and erect. One tree is known, 321 feet in height; and



Wellingtonia gigantea: The Three Graces.  
(Copied from Hutchin's *Scenes of Wonder in California*.)

near it lies a larger one, which has fallen, and which was broken against another large tree in its fall, its diameter where it was broken, 300 feet from its base, being 18 feet. Another tree is 102 feet in circumference at the base. The *W.* is found only in a limited district in California, on the Sierra Nevada, at an elevation of 4000 to 5000 feet above the sea.



Cone and foliage of the *Wellingtonia gigantea*.

It was discovered in 1850, by Mr Dowd, who, being engaged in deer-hunting, came with astonishment into the midst of a group of these trees, now known as the Mammoth Trees of Calaveras. In this locality, within an area of 50 acres, are 123 large trees, 20 of which exceed 25 feet in diameter at the base, and are therefore about 78 feet in circumference. A tree which was felled was 302 feet in height, and 96 feet in circumference at the ground. It was sound to the centre. Its age may be guessed at something like

3000 years. It was calculated to contain about 500,000 cubic feet of timber. Five men were employed for 22 days in felling it, by boring great auger-holes and sawing between them. When it had been cut through, it remained steadfast on its base, and more than two days were spent in driving in great wedges, to cause it to fall. A round wooden house has been erected on the stump, where dancing-parties sometimes enjoy themselves. For several years, the Wellingtonias of Calaveras were supposed to be the only trees of their kind in existence, but groups have more recently been found in other parts of the same district, and scattered trees in a number of localities. The *W.* has been introduced into Britain, the climate of which is very suitable to it; fine young trees are now to be seen in many places, and plants are common in nurseries. The *W.* has been called *Washingtonia* by some American writers, but no reason, except national feeling, has been alleged for the change of the name. According to the generally acknowledged rule in natural history, the older name must be retained.

**WELLS**, an ancient city and municipal and parliamentary borough, in the county of Somerset, pleasantly situated at the foot of the Mandip Hills, 15 miles south-west of Bath. It is a clean and cheerful town, with runlets of water flowing through each principal street. The cathedral, a remarkably beautiful edifice, begun in 704, and enlarged in 1138, is for the most part in Early English; but its west front, one of the noblest façades in the kingdom, and which is enriched with 300 statues, is in Gothic. The bishop's palace, originally founded in 1088, is surrounded by a moat supplied from the abundant source of St Andrew's Well—from which the town is said to derive its name—and by lofty walls. There are no manufactures, and the trade is chiefly retail. Pop. (1871) 4518.

**WELL-STAIRCASE**, a winding staircase with an aperture left in the centre, called the *well*, by which light and air are admitted.

**WELSER**, the name of a famous extinct patrician family in Augsburg. **JULIUS W.** was knighted by the Emperor Otto I. for his services in the war against the Hungarians. His son, **OCTAVIAN W.**, settled in Augsburg, and from him descended the patrician family, which always held important posts in the council of that town. **BARTHOLOMEW W.**, privy councillor of the Emperor Charles V., was so wealthy, that he could vie with the Fuggers (q. v.) in munificence. With the emperor's permission, in 1526, he fitted out three ships in Spain, which, under the command of Ambrose Dalfinger of Ulm, sailed for America, and took possession of the province of Caracas, which the emperor gave W. in pledge. Twenty years after this, the Welsers gave up their possession voluntarily, and it reverted to Spain.—The most famous of the family was the niece of Bartholomew W., **PHILIPPINE W.**, a daughter of his brother, Franz W., born about 1530. She had received an excellent education from her clever mother, and was exceedingly beautiful. On the occasion of a Diet of the empire at Augsburg in 1547, she was seen by the Archduke Ferdinand, the second son of the subsequent emperor, Ferdinand I., who fell in love with her. The young girl firmly rejected all the advances of this fiery youth of 19, and refused to have any relation with him excepting by marriage. They were therefore married in 1550, without the knowledge of his father, or of his uncle, Charles V. His father, on hearing the news, was exceedingly angry, and for a long time his son did not venture to appear before him. Even in other countries, this misalliance made a great noise. In the meanwhile,

the loving couple enjoyed the greatest domestic happiness, and Philippine enchanted every one that knew her by her intelligence and kindness of heart. It was only after eight years that his father was reconciled. Philippine, in disguise, herself handed him a petition, and by her deportment on the occasion, as well as her beauty, disarmed the angry father. He forgave his son, declared his children legitimate, and raised their mother to be Markgravin von Burgau. This happy marriage lasted 30 years. Philippine died at Innsbruck in 1580. In the palace at Schönbrunn, the portrait of the lovely Philippine is still pointed out.

**WELSH LANGUAGE AND LITERATURE.** The Celtic languages are divided into two groups, Gaelic and Cymric. To the latter of these the Welsh belongs, and has even given name, as forming the most important member of the group, which comprises besides, Armorican (spoken in Bretagne) and Cornish (now extinct). A controversy has been waged concerning the nature and closeness of the intimacy existing between the Gaelic and Cymric tongues, but the question may now be considered settled by the researches of the Rev. Richard Garnett (*Gentleman's Magazine*, May 1839), who found, on examining the monosyllabic words in the introductory part of Neilson's *Irish Grammar*, that out of 270, no fewer than 140 were identical in sense and origin with corresponding Welsh terms, that 40 were cognate, an equal number borrowed from Latin, Saxon, &c., and that only 50 were peculiar to the Gaelic. Nevertheless, it is not to be supposed that the affinity is as close as that which exists between English and so-called Scotch. It is rather (according to Mr Garnett) such as exists between Icelandic and German. A Welshman cannot understand a Highlander or an Irishman; he cannot even understand a Breton (as used to be believed), though the language of the latter is undoubtedly Cymric. Most extraordinary hallucinations were formerly current in regard to the antiquity of the Cymric tongues. Pezron, the Breton investigator, gravely affirmed that Welsh and Armorican (which he considered the same) had been 'the language of the Titans, that is, the language of Saturn, Jupiter, and the other principal gods of heathen antiquity.' The Rev. Joseph Harris, editor of the *Seren Gomer*, remarked in 1814 that 'it is supposed by some, and no one can disprove it, that Welsh was the language spoken by Adam and Eve in Paradise.' The fact, on the other hand, is, that of the two branches of Celtic, the Cymric is less ancient than the Gaelic, and that among the Cymric tongues the Cornish is probably older than the Welsh. (See Norris, *Ancient Cornish Drama*, Oxford, 1859.) But preposterous as the views of most patriotic Welshmen are on this subject, it is undoubtedly true that the Welsh is one of the oldest living languages in Europe, and that it possesses a literature reaching back to remoter times than that of any modern tongue except Irish. The most striking peculiarities of the language are the abundance of its grammatical permutations, and its facility in forming derivatives and compounds. Of the former, two examples may be given by way of illustration. The Welsh word for 'father' is *tad*; for 'my,' *fy*. But you cannot say for 'my father,' *fy tad*. After *fy*, every word beginning with *t* must change the *t* to *tt*; and therefore the correct phrase is *fy ttad*. So after *ei*, *tad* becomes either *dad* or *thad*, according as *ei* means 'his' or 'her.' The rules of permutation are almost endless, and, in the opinion of such Welsh scholars as are not Welshmen, useless, nothing being gained in point of euphony or expressiveness. The Welsh affirm that their language is ex-

ceedingly harmonious, and it would serve no good purpose to dispute the assertion; but foreigners ignorant of the tongue, and associating no definite ideas with the words that issue from a Welshman's lips, generally fail to realize the fact, and consider it in this respect—though not in others—distinctly inferior to Gaelic. The language, or rather the structure of sentences and the phraseology, exhibits a certain staidness, or even grandiloquence, characteristic, indeed, of uncivilised nations. One thing specially deserves notice. The Welsh people are profoundly attached to, and familiar with it. It is not dying out, like Irish or Scotch Gaelic. It has a genuine literary, as well as oral existence even now, and though the changes it has undergone since the days of Taliesin are numerous and great—so great, indeed, that no modern unlettered Cambrian can understand a word of the early poetry of his country—yet it is essentially the same tongue as Cæsar and Agricola heard, and is consequently to be regarded with veneration as the solitary living link that unites those distant ages with our own.

There are extant, says Owen Pughe, some thirty old treatises on Welsh grammar and prosody. The most important of these is one composed by Geraint (830 A.D.), revised by Einion (1200 A.D.), and regularly privileged by the sovereigns who then exercised authority in Wales. It was first printed by the Welsh MS. Society in 1856, under the editorship of the Rev. J. Williams ab Ithel. Among English grammars of the Welsh language, the best is said to be that by the Rev. Thomas Rowland (2d ed. 1857); among dictionaries, that of Owen Pughe, entitled *Geiridder Cymraeg a Saesneg, a Welsh and English Dictionary* (2 vols. 1793; 3d ed. 1861, & seq.). It is, however, only a Welsh-English dictionary; the most satisfactory English-Welsh dictionary is that published by Daniel Silvan Evans (2 vols., Denbigh, 1852—1858).

The literature of Wales has been arranged into four periods: the first extending from the earliest times to the Norman Conquest (1066 A.D.); the second, from the Norman Conquest to the English Reformation (circa 1536 A.D.); the third, from the English Reformation to the beginning of the reign of George III. (1760 A.D.); and the fourth, from 1760 to the present day. To what date the oldest specimens of Welsh literature ought to be assigned, has been the subject of sharp dispute. These specimens are in verse, and are rhymed. The chief of their alleged authors, with their supposed periods, are Aneurin (510—560 A.D.), Taliesin (520—570 A.D.), Llywarch Hen, or 'the Old' (550—640 A.D.), and Myrddin or Merlin (530—600 A.D.). According to Pinkerton (see his preface to *Barboer*) and Laing (*Dissertation on Ossian*), they are not authentic; but the vindication of their authenticity, first by Sharon Turner in 1803, and afterwards, and more critically, by Mr Stephens of Merthyr-Tydvil, in his *Literature of the Kymry* (1849), and Mr Nash, in his *Taliesin, or the Bards and Druids of Britain* (1859), is considered conclusive. The last two of these writers, however, may almost be said to meet their opponents half-way. Of the seventy-seven poems ascribed to Taliesin in the *Myssrian Archaeology of Wales* (a collection of all the most celebrated works in Welsh literature, 500—1400 A.D.), which appeared in 1801—under the auspices of Mr Jones, Mr Edward Williams (better known as 'Edward of Glamorgan'), and Dr Owen Pughe—Mr Stephens considers fifty-seven to be demonstrably spurious, and only twelve to be probably genuine, that is, belonging to the age of Taliesin. Mr Nash enables us to form an independent judgment on the point, for he translates some fifty of these poems, and we

find that, instead of their exhibiting an antique Welsh character, they abound in allusions to mediæval theology, and frequently employ mediæval Latin terms. It is certainly unfortunate for the reputation of the 'Chief of the Bards,' that the specimens of his which are considered to be genuine possess exceedingly small poetic merit. The life of this famous but apparently over-rated genius is, of course, enveloped in legend. He is said to have been the son of a certain St Henwg, and to have been educated at the College of St Cadog. His life was spent successively at the courts of Urien Rheged, Gwyddno, Prince of Cardigan, and King Arthur, and his sepulchre is shewn near Aberystwith. It is still called *Bedd Taliesin* (Taliesin's Grave). Of the poems whose authorship is ascribed to Aneurin, a prince of the Cumbrian Britons, the most notable is that entitled *Gododin*, in which he pathetically laments a defeat of his countrymen by the Saxons. It is reckoned authentic. (Several English translations of the *Gododin* have been published, and a translation of the whole works of Aneurin was published by Mr Probert in 1820.) Llywarch Hen, also a Cumbrian warrior, is regarded as the finest and most poetical of all the semi-historical Welsh bards. Tradition reports that he lived to the age of 150. The burden of his verse is the miseries of old age, on which he descants with melancholy eloquence. (See *The Heroic Elegies and other Pieces of Llywarch Hen, Prince of the Cumbrian Britons*, with a literal translation by William Owen, 1792.) The pieces ascribed to Merddyn, in the *Myvyrian Archaeology*, are in all probability spurious. Besides the names already mentioned, other poets of the first period are Gwyddno, Gwilym ab Don, Golyddan, &c.

The earliest specimen of Welsh prose now extant is the collection of the laws of King Hywel Dda, or Howel the Good (died 748 A.D.)—a work of great value in illustrating the manners and morals of early Welsh times, but it is very uncertain when or by whom the collection was made. The oldest extant MS. belongs to the 12th century. The latest and most critical edition (Welsh and English) is that published in 1841 by the Record Commission, and edited by Aneurin Owen, son of Dr Owen Pughe. Another work, entitled *The Wisdom of Cadog the Wise* (a collection of proverbs pretending to be by a St Cadog, who flourished in the 6th c., and was a friend of Taliesin), is of such doubtful authenticity that its claim can only be noticed in our sketch.

*Second Period, 1066—1536.*—A few years after the date of the Norman Conquest, a new spirit was imported into Welsh poetry by the influence of Gruffydd ab Cynan, Prince of North Wales, and Rhys ab Tewdwr, Prince of South Wales, particularly of the former. Gruffydd had been born during his father's exile in Ireland, and was brought up in that country, where he appears to have acquired a familiarity with both the native Celtic literature and that of the Dano-Norse invaders. In the year 1100, he held a great Eisteddvod at Caerwys in North Wales, which was numerously attended by Irish bards and musicians. For the next three hundred years, Wales is rich in native bards, a fact that conclusively refutes the tragic story of Edward I. having caused them all to be slain, lest their patriotic songs should stir the Welsh to renew the struggle for independence. Nearly sixty names occur in the *Myvyrian Archaeology* between 1120—1380. The first is that of Meilyr (1120—1160), whose best piece is entitled *The Deathbed of the Bard*. Meilyr's son, Gwalchmai ab Meilyr (1150—1190), who is said to have accompanied Richard Cœur de Lion to Palestine, is a superior poet to his father. Fourteen of his productions are extant. Gwalchmai's son, Einion (1170—1220), also figures as a

poet. Forty pieces are ascribed to Cynddelw (1150—1206), a contemporary of Gwalchmai, of which probably the most interesting is *The Deathbed of Cynddelw*. He has also some verses addressed to Prince Madog or Madoc of Powys, whom enthusiastic Welshmen conceive to have discovered America before Columbus. Other bards of this second period are Llywarch ab Llewellyn (1160—1220); Hywel (1140—1170), a brother of Prince Madoc, and writer chiefly of erotic odes; Owain Cyveilioc (1150—1197), also of princely rank, whose *Hïrlas*, or the *Long Blue Horn*, is a great favourite with more than Welshmen; and above all, *Davydd ab Gwilym* (circa 1340—1400), who has been compared to Ovid, to Petrarch, and to Burns. In his verses, Welsh poetry undergoes a change—the bardic or Scaldic spirit disappears, and a more humane, if less patriotic spirit takes its place. Davydd sings of love and of social amusements; he was likewise a fierce satirist, though at times very penitent and pious; while, to complete his resemblance to the Scottish poet, and also to justify the biblical name he bore, he shewed an unmistakable predilection for illicit love. Davydd's poems were first published in Welsh, with a biography of the author by Owen Jones and Owen Pughe (1789). An English translation of some of them by Mr A. Johns appeared in 1834. Besides the poets already mentioned, the following names are in high repute: Iolo Goch, the friend and bard of the famous Owen Glendower, who is said to have lived to the age of 120; Sion Cent ('John of Kent'), a name given him from Kentchurch, in Hereford, where he resided (1380—1410), and who, having adopted the opinions of the Lollards, ultimately attained the reputation of a wizard; and Lewis Glyn Cothi, who flourished during the Wars of the Roses, and was bard to Jasper, Earl of Pembroke, son of Owen Tudor and the widow of Henry V.

*Prose.*—The oldest Welsh chronicle of the second period is Caradoc, a monk of Llancarvan, who flourished in the first half of the 12th century. His work narrates in Welsh the history of his native country from the death of Cadwallader, 689, to the times of Caradoc himself. It is a dry, illiterate affair, like the Anglo-Saxon Chronicle. Contemporary with Caradoc was the famous Geoffrey of Monmouth (q. v.), Bishop of St Asaph, who died in 1154. He, however, though a Welshman, wrote in Latin, and belongs, therefore, rather to the general literature of England than to Welsh literature. His *Chronicle* commences with the fall of Troy, and ends with the death of Cadwallader, so that it forms an introduction to that of his friend Caradoc. In it the legend of Arthur first assumes that romantic and chivalrous form in which modern readers are familiar with it. It is impossible here to enter into a discussion of the question where the materials of the Arthurian romance were first accumulated; suffice it to say, that evidence preponderates in favour of their Welsh origin. To this second period must also be assigned that charming collection, the *Mabinogion*, or Children's Tales, of which a MS. volume of more than 700 pages is preserved in the library of Jesus College, Oxford, and is known as the *Red Book of Hergest*, from the name of the place where it was discovered. A beautiful edition of this work in Welsh and English, with preface and notes, was published in 3 vols. (1838—1849) by Lady Charlotte Guest. The age of these tales, which relate principally to Arthur and the Round Table, is doubtful. The transcription in the *Red Book of Hergest* belongs probably to the 15th c.; but the date of their composition may be safely held to be much earlier, perhaps somewhere in the 13th century.

The *Triads* may also be here noticed. They are

collections of historical facts, maxims ethical and legal, mythological doctrines and traditions, and rules for the structure of verse; all expressed with extreme brevity, and regularly disposed in groups of three. They were a very popular species of composition among the Welsh, and are of all ages. Examples occur in the poems of Llywarch Hen, but the greater part are found in transcripts and miscellanies of the 16th and 17th centuries. The 'historical' triads are especially puzzling. They occur in a so-called collection, made by one Thomas Jones of Tregaron, about the close of the 16th century. This Jones was originally, it seems, an eminent robber—a Welsh 'Rob Roy;' but in his later years he reformed, married an heiress, and became a justice-of-peace for the county of Brecon. The peculiarity of his 'Collection' is, that it gives a totally different account of the origin of the Britons from Geoffrey of Monmouth, bringing them from a 'Summer Land' (supposed to be Constantinople or the Crimea) over a sea called the 'Hazy Sea.' The question arises, and has not been settled: Whether are we to suppose Jones the fabricator of these 'triads,' or his account of the origin of the Britons the genuine record of an ancient tradition? In favour of the former hypothesis, unfortunately, is the circumstance that there is no trace of such an ancient tradition in the anterior literature of Wales.

*Third Period (1536—1760).*—This and the remaining period may be briefly sketched. The most notable fact in its commencement is the comparative ease with which the Reformation made its way among the Celts of Wales. The Celts of the Highlands remained for a time, and those of Ireland remain to this day, obdurate adherents of the old faith; but those of Wales, on the whole, swiftly accepted the new religion. The art of printing had been in operation in England for more than half a century before it was applied to the Welsh language. The first book printed in the Welsh or any Celtic language was an almanac, with a translation of the Lord's Prayer and the Ten Commandments (Lond. 1546). The author, William Salesbury, was a scholar and a zealous Protestant. In 1547, he published the first dictionary of English and Welsh, and executed the greater part of the first translation of the New Testament into his native tongue (Lond. 1567). In 1588, appeared the earliest translation of the whole Bible into Welsh. The author was a Dr William Morgan, afterwards Bishop of St Asaph's. A revised edition of this, in 1620, by Dr Parry, Morgan's successor in the bishopric of St Asaph's, is the translation still in use among the natives of the Principality. Contemporary with Salesbury, but an adherent of the old faith, was Dr Griffith Roberts, who lived on the continent, and published at Milan a Welsh Grammar in 1567. Another contemporary was Dr John David Rhys, whose principal work, *Cambrobrytannica Cymraeave Linguae Institutiones et Rudimenta*, is a treatise on Welsh grammar. The suspicious Thomas Jones of Tregaron, possible author, rather than collector of the 'historical' triads, was a friend of Rhys, and died about 1620. In 1603, Captain Myddleton, one of the first three persons who smoked tobacco in England, published a metrical version of the Psalms in Welsh, partly executed while cruising about in the West Indies. The most celebrated poets of the third period are the Rev. Rees Prichard, vicar of Llandoverly (1579—1644), whose *Canoyll y Cymry* (Candle of the Cambrians) is a metrical version of his professional homilies or sermons, the eloquence of which had previously won for him a great reputation as a preacher; it is still popular,

the 20th edition having appeared as late as 1858: Huw Morus, or Hugh Morris (1622—1709), author of a variety of pieces, which his countrymen consider unsurpassed in humour, pathos, and even sublimity—an edition in 2 vols. appeared at Wrexham (1823), under the title of *Eos Ceiriog* (The Nightingale of Ceiriog); and Goronwy Owen (1722—circa 1780), a gifted bard, but likewise an incurable drunkard, whose principal poems are contained in the first volume of a book entitled *Diddanwch Teuluaidd* (Domestic Amusement, Lond. 1763). Of the prose writers, the only noteworthy are Ellis Wynne (d. 1734), author of the *Bardd Uweg* (Sleeping Bard, 1703); a series of visions of Hell and Hades, written with great beauty of style; and the Rev. Moses Williams (1685—1742), an antiquarian scholar of high merit, whose *Repertorium Poeticum*, or List of Welsh Poems and Catalogue of Welsh Books, is very valuable.

*Fourth Period (1760 to present time).*—Various causes co-operated to give a new impetus to Welsh literature after the accession of George III. Among these, the most powerful were the establishment of periodical publications, the institution of patriotic societies, and the spread of Methodism. The first important production of this period is entitled *Some Specimens of the Poetry of the Ancient Welsh Bards translated into English* (Lond. 1764), by Mr Evans, curate of Llanvair Talyhaern, in Denbighshire. The next name deserving of mention is that of Owen Jones (1741—1814), who, though engaged in mercantile occupations all his life, managed, by his enthusiasm and liberality, to quicken and extend the public interest in Welsh literature. In 1771, he founded the *Gwyneddigion* (society of the 'Men of Gwynedd'), which gave prizes for the best performances on the Welsh harp, and the best Welsh poems. In 1801—1807, he caused to be published at his own expense, under the editorship of Owen Pughe and Edward Williams, three volumes of the *Myvyrian Archaeology*, so called in honour of himself, who had assumed the bardic name of Myvyr, from his native vale in Denbigh. Owen Jones was, however, rather a Welsh Mæcenas than a Welsh litterateur. The next names of importance are those of the editors just mentioned, Owen Pughe and Edward Williams. The former (1759—1835), according to Southey, was a 'muddy-minded man;' nor is the fact that he was a follower of Joanna Southcott, and one of her twenty-four elders, adverse to this description of his intellect. Be this as it may, Owen Pughe is the great Welsh lexicographer; his Dictionary of Welsh (1793—1803) contains 100,000 words illustrated by 12,000 quotations. He also translated *Paradise Lost* into Welsh, in which work he threw off the chains of Welsh alliteration, an innovation generally acknowledged to be an improvement. Edward Williams (1745—1826), better known as Iolo Morganwg, is probably the finest Welsh genius of the fourth period. Southey knew him, and liked him greatly. His principal productions are *Salmu yr Eglwys yn yr Aniakoch* (Psalms of the Church in the Desert); but an *Ode on the Mythology of the Ancient British Bards in the Manner of Taliesin* (1792), accompanied by notes and specimens of 'Triads,' containing the metaphysical and religious doctrines of the old Druidical bards, provoked a long-protracted controversy. Morganwg said that he had copied them from a MS. collection of a Welsh poet, anno 1560, which was in his possession, and affirmed that the collection was of very great antiquity. He was often asked to produce it, but always declined; and Welsh critics of the stricter sort have now ceased to believe in its existence. The three associates in the publication

of the *Myvyrian Archæology* had each one son, and all of these have become eminent in connection with the literature of their native country. Taliesin Williams (1787—1847), son of Edward Williams, wrote poetry both in Welsh and English; Aneurin Owen (1792—1851), son of Owen Pughe, among other works, published an important collection of the *Laws of Wales*; while Owen Jones, son of Owen Jones, the Welsh Mæcenas, is still alive, and has a high reputation as an architect, the Alhambra at Sydenham being a favourable specimen of his professional talents. The fourth period of Welsh literature is naturally richer in critical than in creative works. Among Welsh antiquaries may be mentioned the Rev. Edward Davies (1756—1831), author of *Celtic Researches* (1804) and *Mythology of the Druids* (1809); the Rev. Thomas Price (1781—1848), author of the *Hæses Cymru a Chenell y Cymry* (1836—1842), a History of Wales and of the Welsh nation from the earliest times to the death of Llewellyn; an admirable work, comprehensive, critical, and literary (Price was an ardent and voluminous writer, contributing to no fewer than 15 periodicals at the same time); and the Rev. John Williams ab Ithel, rector of Llanymowddwy in Merioneth, and editor of the *Cambrian Journal*. In 1856, he edited, for the Welsh MS. Society, the *Grammar of Edeyrn, the Golden-tongued*, said to be composed about 1270; in 1860, the *Brut y Tywyrgion*, or Chronicle of the Princes; and in 1861 (*et seq.*), *The Traditionary Annals of the Cymry*, reprinted from the *Cambrian Journal*. Williams is a rather credulous and uncritical writer, but a scholar of undoubted merit. Probably the ablest Welsh scholar alive is Mr Thomas Stephens of Merthyr-Tydvil, a man at once patriotic and honest, enthusiastic and critical. To him, above all others, Englishmen desirous of obtaining some clear and credible knowledge of Welsh literature, ought to apply. His principal works are *Studies on British Biography*, and *Literature of the Cymry in the Twelfth and following Centuries*. The enlightened views of Stephens have met with great acceptance among such English scholars as have paid attention to the subject of Welsh history and literature.

The poetry of the fourth period is not remarkable. The principal names are—David Richards of Dolgelly (1751—1827), author of a sort of epic on the Trinity—a very unsuitable subject for an epic—and a paraphrase of the history of Joseph; David Thomas of Caernarvon (1769—1822), who was very successful at the Eisteddvods; David Owen of Givion (1784—1841), whose poems were collected and published under the title of *Blodau Arfon* (Flowers of Arvon); the Rev. Daniel Evans, a collection of whose pieces was published at Llandovery in 1831, under the title of *Gweinllan y Bardd* (The Poet's Vineyard); the Rev. Walter Davies (1761—1849), also great at Eisteddvods; the Rev. James Hughes (1779—1846); the Rev. William Rees of Liverpool, author of a spirited paraphrase of the Book of Job, &c.; and the Rev. William Williams of Caernarvon, author of *Grawn Awen* (The Treasure of the Muse), &c.

A good deal of indifferent Welsh prose has been written during this period on religious subjects, owing to the spread of Methodism among the Welsh, but it may profitably be overlooked by a foreigner; and with a glance at the history of Welsh periodicals and societies, we close our brief survey of the subject. The first Welsh periodical, edited by the Rev. P. Williams and Evan Thomas, appeared about 1770, and was entitled *Yr Ewgrawen Cymraeg* (The Welsh Treasure), but the first that attained any measure of success was the *Seren*

*Gomer* (Star of Gomer), which was published at Swansea (1814). At present, it exists as a Welsh 'quarterly' of evangelical views. In 1831, *Y Drysorfa* (The Treasury) was commenced, under Calvinistic auspices; in 1836, *Y Diwygiwr* (The Reformer), and *Y Dywedydd* (The Teacher); 1833—1841, *Y Gwladgarwr* (The Patriot), more a literary than a theological magazine, and tolerably clever; *Yr Haul* (The Sun), a journal advocating the interests of the Established Church; and *Y Traethodydd* (The Essayist), commenced at Denbigh (1845), distinctly the best literary organ in Wales. It discusses, in the Welsh tongue, the poetry and philosophy of modern Europe. In 1859, a new quarterly was started at Ruthyn, entitled *Taliesin*, as a companion and rival to *The Essayist*. The leading Welsh newspaper is the *Amserau* (Times).

A work of great value, commenced in 1856, is a Welsh Encyclopædia, under the editorship of the Rev. John Parry of Bala, and entitled *Encyclopædia Cambrensis—Y Gwyddoniadur Cymroig*. Periodicals, exclusively devoted to Welsh subjects, are the *Cambrian Register* (3 vols., 1796, 1799, and 1818); the *Cambro-Briton and General Celtic Repository* (3 vols., 1819—1822); the *Cambrian Quarterly Magazine* (5 vols., 1829—1833); and the *Cambrian Journal*, begun in 1854, and still going on. Another valuable periodical is the *Archæologia Cambrensis*, or 'Journal of the Cambrian Archæological Association,' begun in 1846, and published quarterly.

The leading Welsh societies, literary and antiquarian, that have existed, or still exist, are the Cymmrodorion, established in London in 1751, which lived for 30 years; the Gwyneddigion, also established in London in 1771, but extinct some 20 years ago; a second Cymmrodorion (1820—1843); The Society for the Publication of Ancient Welsh MSS. (founded at Abergavenny, 1837); and the Cambrian Institute, founded in 1853.

The best work on Welsh literature, as already mentioned, is that of Mr Thomas Stephens of Merthyr-Tydvil, to which the reader is referred; as also to the various Welsh quarterlies, where almost every question in Welsh literature is copiously discussed. A very excellent and complete survey of the subject is also to be found in Knight's *English Cyclopædia*, article 'Welsh Language and Literature.'

**WELSH ONION**, or **CIBOL** (*Allium fistulosum*; see **ALLIUM**), a perennial plant, a native of Siberia. It has fistular leaves and no bulb. Its leaves appear very early in spring, and are then used in soups and salads. Its flavour more resembles that of garlic than of the onion. It has been long cultivated in kitchen-gardens in Britain, and perhaps deserves more attention than it receives, because it is ready for use before any similar plant in spring. The seed is sown in spring or summer; leaves fit for use are produced in the following spring, and the bed continues to be productive for a number of years. The name Welsh Onion is from the German *Wilsch*, and merely indicates a foreign origin.

**WELSHPOOL** (often vulgarly called Pool), a municipal and parliamentary borough of North Wales, in the county of Montgomery (of which it is considered the capital), 13½ miles west-south-west of Shrewsbury. Powis Castle is an ancient edifice, the oldest parts dating from the 12th c.; and the park is much admired. Woollen mills, tanneries, and malt-houses are in operation. Pop. of parliamentary borough (1871) 6963. W. is connected by a branch with the Shrewsbury and Hereford and other railways.

## WENDS—WENTLETRAP.

WENDS from the same root as *wend*, to *wander*, and signifying the wandering or roving border tribes), the name given by the Germans to a branch of the Slaves (q. v.) which, as early as the 6th c., occupied the north and east of Germany from the Elbe along the coast of the Baltic to the Vistula, and as far south as Bohemia. They were divided into several tribes, which were successively subdued by the Germans, and either exterminated or gradually Germanised and absorbed, although remnants of them are still here and there to be found.—In a narrower sense, the name of Wends is given to those remnants of the Slavic population of Lusatia who still speak the Wendic tongue, and preserve their peculiar manners and customs. They number about 150,000. A collection of Wendic songs was published by Haupt and Smaler (3 vols., Grimma, 1843—1844). The Wends, like the other subject Slavic tribes, were, in early times, cruelly oppressed by their German masters; in recent times, their lot has been more tolerable.

WENER, LAKE, the largest lake in the Scandinavian peninsula, and after the lakes Ladoga and Onega in Russia, the largest in Europe, is situated 150 miles west-south-west of Stockholm, and about 30 miles inland from the Cattegat. It is over 90 miles in length, and varies from 15 to 48 miles in breadth, is 300 feet in greatest depth, and lies 150 feet above sea-level. Area, 2005 sq. miles. From the north shore a peninsula extends southward into the middle of the lake; and from the southern shore a peninsula extends northward to within about fifteen miles of the point of the northern peninsula; the portion of the lake lying to the west of these peninsulas receives the name of Dalbo Lake. Of the numerous rivers that feed the lake, the chief is the Klar, from the north, and its surplus waters are discharged into the Cattegat by the river Göta. It is connected by a canal with Lake Wetter, by means of which, the Göta Canal, Lake Roxen, &c., inland communication is established between the Cattegat and the Baltic Sea. The lake is rich in fish; it is often visited by sudden gusts of wind, and is in many places too shallow for navigation.

WENLOCK, a parliamentary and municipal borough in the county of Salop, 12 miles south-east of Shrewsbury. Pop. of parliamentary borough (1871), 21,208. The principal buildings in Much Wenlock are the church, a building of considerable antiquity, bearing traces of Saxon and Norman architecture; and the town-hall, a venerable and interesting structure, decorated internally with elaborate oak carvings of the time of Charles II. There are also a savings-bank, and a public library and reading-room. The extensive ruins of Wenlock Abbey afford a rich treat to antiquaries. The abbey was founded in the year 680, and was the parent church of Paisley Abbey, Scotland. The remains have been carefully preserved from further dilapidation by the owner, J. Milnes Gaskell, Esq., formerly M.P. for the borough, who converted a portion of them into an occasional residence for himself. W. is an ancient municipality, with separate quarter sessions, and is the first borough that acquired the right by charter of representation in parliament. The town of Wenlock proper, or Much Wenlock, is but small; but the parliamentary borough comprises 12 parishes spreading over a large area, and includes the market-towns of Madeley, Broseley, and Ironbridge, and the populous district of Coalbrookdale, where important iron and brick and tile works are carried on. There are also extensive limestone quarries in the neighbourhood. There is a railway connecting W. with the Severn Valley Railway at Buildwas, and

another connected with the Shrewsbury and Hereford line.

WENLOCK GROUP, an important series of rocks of Upper Silurian age, which are largely developed in the neighbourhood of Wenlock. The group is divided into an Upper and Lower series. The Upper, known as the Wenlock Limestone, consists of a considerable thickness, sometimes reaching 300 feet, of a gray subcrystalline limestone, so hard that it has withstood the weathering which has removed the softer shales above and below it. It forms a ridge parallel to that of the Aymestry limestone, running for 20 miles north-east to south-west through the south-eastern portion of Shropshire. Sometimes it contains huge concretionary masses of crystalline carbonate of lime, locally named 'ball-stones'; in other places, it becomes thin and fluggy. It abounds in fossils, especially in corals, crinoids, mollusca, and trilobites. The Lower Wenlock series consists of 1400 feet of Wenlock shale, and 150 feet of Woolhope limestone and grit. The Wenlock shale is generally a dark gray, almost black argillaceous rock, often containing elliptical concretions of impure earthy limestone. It is worked in some places for flagstones and slates. The Woolhope limestone and grit consists of gray argillaceous nodular limestones resting on fine shales. In Denbighshire, it appears as a coarse grit, often of great thickness, and producing a very barren soil. The fossils of the Lower Wenlock beds are of a similar character to those of the Upper series.

WENS are encysted tumours, much more common on the scalp than in any other situation, though occasionally observed on the face, shoulders, &c., and consisting of obstructed sebaceous glands, which enlarge by the internal pressure of their accumulated secretions. The closed orifice may be often noticed in the form of a small dark point, and in that case the duct may sometimes be gradually enlarged by the gentle introduction of a probe or director, and its contents pressed out. By this treatment, they may, at all events, be kept from being unsightly, and will sometimes shrivel up and disappear. If this treatment fail, and the patient finds the tumour so annoying that he insists upon its removal, it must be exterminated with caustic or the knife. In consequence of the well-known dangers (especially erysipelas) that frequently follow cutting operations of the scalp, the caustic treatment is generally preferable. The most prominent part of the wen must be thoroughly canterised with nitric acid or potash, which will lead to the formation and separation of a slough, which will lay open the tumour, which may then be left to empty itself and wither, or may be emptied by pressure, and canterised within. As a general rule, wens are better left alone, unless they can be emptied by simple pressure, as severe operations on them are frequently attended with danger.

WENTLETRAP (*Scaloria*), a genus of gasteropodous mollusca, of the family *Turridiellidae*. The shell is spiral, with many whorls, the whorls deeply divided, and not always close together, crossed by remarkably elevated ribs, the aperture round and rather small. The animal is furnished with a proboscis, and has the eyes placed on an external convexity, the foot short and oval. About one hundred species of this genus are known. Those which have the whorls close together are called False Wentletraps by shell-collectors, those in which they are not contiguous are known as True Wentletraps. Of the former, some are found in northern seas, as *Scaloria communis* on the coasts of Britain and of continental Europe, and *S. Gravelandica* on those of North America. *S. Gravelandica* is particularly



abundant on the banks of Newfoundland, and forms part of the food of the cod. The *true* Wentletraps are all natives of the seas of warm climates. Some of them are very beautiful. A species found in the south-east of Asia, and known as the PRECIOUS W. (*S. pretiosa*), was once in such esteem amongst shell-collectors, that an extremely fine specimen is

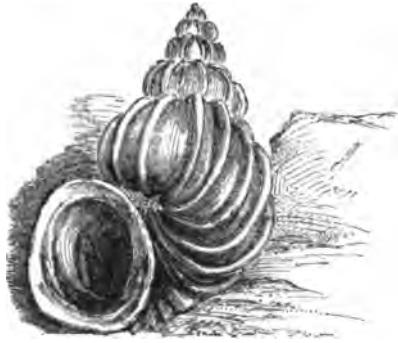

Wentletrap (*Scalaria pretiosa*).

said to have been sold for 200 guineas; and an ordinary price was from three to five pounds. This shell may now be purchased for a few shillings. It is from an inch and a half to two inches long, snow-white, or pale flesh-coloured, with eight separated—but not widely separated—whorls.

WERDAU, a town of Saxony, on the river Pleisse, 40 miles directly south of Leipzig, and 49 by railway. Pop. 11,216, mostly engaged in manufacturing cloth and in yarn-spinning.

WERDEN, a town of Rhenish Prussia, on the Ruhr, 17 miles north-east of Düsseldorf. Pop. (1871) 6685, employed in the manufacture of cloth, linen, and silk, and alum, and coal-mining.

WEREGILD (Ang.-Sax. *wer*, man; and *geld*, satisfaction), a composition by which, according to the custom of the Anglo-Saxons, Franks, and other Teutonic people, homicide and other heinous crimes against the person were expiated. There was an established progressive rate of weregild for homicide, varying at different times and among different Teutonic tribes, from the weregild of the *ceorl*, or peasant, to that of the king. In the time of Tacitus, the weregild for homicide among the Germans was due to the relatives of the deceased; that for other crimes one-half to the injured party, and one-half to the state. The sum paid to the relatives in case of homicide, also known as the *man-wyrt*, seems to have been looked on as the equivalent of the dead man's value. As the power of the community or king increased, the exaction of retribution for the death of its members was considered to be the duty of the state as well as of the relatives, and the principle of division was applied to homicide as well as minor crimes; each payment being a separate full equivalent for the value of the deceased, the one to appease the feud, the other to make atonement to the state. This double weregild is recognised in the compensation for the death of a king by the laws of the Mercians and Northumbrians. In the days of Edward the Elder the weregild had become a much more complicated penalty, the composition for homicide consisting of four different payments, two of which, the *fight-wite*, or penalty for a breach of the peace, and the *weregild*, went to the king as head of the state; while a sum called the *halsfang* was paid to the kindred to loosen the hand of the avenger of blood,

and the *manbote* was given to the overlord to compensate him for the loss of a vassal. The graduated scales of weregild in use among the different Teutonic nations throw much light on the gradations of society at the period. It does not appear that among the nations who recognised the principle of weregild, the relatives were bound to accept a compensation for their kinsman's slaughter, in place of appeasing the death-feud by blood; the latter practice was often resorted to instead. It was only through the exertions of Archbishop Theodore that Egfred, the Christian king of the Angles of Northumbria, adopted the alternative of accepting a weregild for his brother slain in battle by the Mercians, in place of demanding the blood of the slayer. A similar principle to that of weregild for homicide seems to have been recognised by the Celtic nations, and there are traces of it in the Mosaic code.

WERE-WOLF (Ang.-Sax. *wer*, a man), a man-wolf, a man who, either periodically or for a time, is transformed, or transforms himself into a wolf, becoming possessed of all the powers and appetites of a wolf in addition to his own, and being especially remarkable for his appetite for human flesh. The belief in the transformation of men into wolves or other beasts of prey has been very widely diffused; there is perhaps no people among whom some evidence of its former prevalence does not exist. It is not yet extinct, even in Europe. In many of the rural districts of France, the *loup-garou* (the latter part of the word is a corruption of the Teutonic *wer-wolf*), is still an object of dread. This superstition lingers too among the country-people of Northern Europe, and a particular form of it flourishes vigorously among the Bulgarians, Slavonians, and Serbs, and even among the more intelligent inhabitants of Greece. See VAMPIRE. Its details vary in different countries and districts. The definition given above includes only the commonest and the best marked of its incidents. Probably, it has not yet entirely disappeared in any country whose rural districts are infested with wolves or other wild animals; and manifestations fitted to suggest it may be occasionally observed in the mad-houses of most countries. See LYCANTHROPIA. The animal whose shape is taken, as already stated, is not always, though usually, a wolf; it was probably always the animal most formidable, or considered most inimical to man. In Abyssinia, it is the hyena.

Occasional notices of lycanthropy, as it is called, are found in classical writers; and lycanthropy, as there described, was the change of a man or woman into a wolf, so as to enable the man or woman to gratify an appetite for human flesh, either by magical means, or through the judgment of the gods, as a punishment for some dire offence. Sometimes the transformation was into the shape of a dog or a bull. Ovid, in his *Metamorphoses*, tells the story of Lycaon, king of Arcadia, who, when entertaining Jupiter at a banquet, resolved to test his omniscience by serving up to him a hash of human flesh. The god, to punish him for this, transformed him into a wolf. Herodotus describes the Neuri as sorcerers who had the power of taking once a year, for several days, the shape of wolves; and the same account of them is given by Pomponius Mela. Pliny relates that, in Arcadia, every year, at the festival of Jupiter Lycaeus, one of the family of Antæus was chosen by lot, and conducted to the brink of the Arcadian Lake, into which, after having hung his garments upon a tree, he plunged, and was transformed into a wolf. Nine years after, if alive, he returned to his friends, looking nine years older than when he disappeared. Some notices of lycanthropy are to be found in Petronius; and

## WERE-WOLF.

allusion to it is also made by Virgil in the 8th *Elogue*. Marcellus Sidetes tells us of men who, every winter, were seized with the notion that they were dogs or wolves, and lived precisely like these animals, spending the night in lone cemeteries. This disorder attacked men chiefly in the beginning of the year, and was usually at its height in February. It is worth while observing that the classical instances of lycanthropy mostly refer to Arcadia, a pastoral country, whose inhabitants suffered greatly from the ravages of wolves.

In Norway and Iceland, it used to be believed that there were men who were 'not of one skin.' Such men could take upon themselves other shapes than that of man, and the natures corresponding to the shapes which they assumed; they had the strength and other powers of the animal whose shape they bore, as well as their own. It was believed that the change of shape might be effected in one of three ways: simply by putting on a skin of the animal; by the soul of the man deserting the human body—leaving it for a time in a cataleptic state—and entering into a body borrowed or created for the purpose; or, without any actual change of form, by means of a charm, which made all beholders see the man under the shape of the animal whose part he was sustaining. The two former were the common modes of transformation; at any rate, the Sagas are full of illustrations of them; while illustrations of the third mode are comparatively rare. Nothing of the man remained unchanged except his eyes; by these only could he be recognised. Odin had, and freely exercised, the power of varying his shape. When men changed their shape to prey upon their kind, they always took the form of a wolf. It was believed that many had the power of thus transforming themselves; and great was the popular dread of were-wolves. Perhaps the best stories of were-wolves which are to be found are contained in the Northern Sagas. Scarcely anywhere did the belief in them go so deep into the minds of the people as among the northern races. In connection with it, notice may be taken of what is called the 'Berserkr rage,' which appears to have been a peculiar form of mania. The Berserkr yelled like dogs, or wolves rushing into conflict, bit their shields with their teeth, and committed terrible atrocities while the paroxysms of their disease were upon them. Berserkr has been rendered 'bare-skinned;' others make it mean 'wolf-skin-coated' (why not 'bear-skin-coated?').

Olaus Magnus states that in Prussia, Lithuania, and Livonia, though wolves were very numerous and troublesome, the ravages of the were-wolves were regarded as much more serious. Every year at the feast of the Nativity at night, the were-wolves assembled in great numbers at appointed places, and proceeded to look out for human beings, or tame animals, upon which they could glut their appetites. If they found an isolated house, they entered it, and devoured every human being and tame animal it contained; after which—shewing that they were not common wolves—they drank up all the beer or mead. Similar testimony with regard to Livonia is given by Bishop Majolus, who adds, that the transformation into the wolf-form continued for twelve days.

Instances of persons being changed into wolves by way of punishment, were freely believed in the middle ages; for example, St Patrick was believed to have changed Vereticus, king of Wales, into a wolf; and there was an illustrious Irish family which had incurred the curse of St Natalis, every member of which, male and female, according to the popular belief, had to take the shape of a wolf, and live the life of a wolf for seven years.

In the 15th and 16th centuries, the belief in were-wolves was, throughout the continent of Europe, as general as the belief in witches, which it had then come to resemble in many respects. It gave rise to prosecutions almost as frequent as those for Witchcraft (q. v.), and these usually ended in the confession of the accused, and his death by hanging and burning. It was calculated to inspire even greater terror than witchcraft, since it was believed that the were-wolves delighted in human flesh, and were constantly lying in wait for solitary travellers, and carrying off and eating little children. The were-wolves, like the witches, were now regarded as servants of the devil, from whom they got the power—often exercised by anointing with a salve—of assuming the wolf's form; and it was believed that great numbers of them trooped together to the devil's Sabbath. The stories of mutilations and other mishaps befalling them in the wolf-state, by which, when they resumed the human form, they were identified as were-wolves, exactly resemble the stories told of witches. In September 1573, we find a court of parliament sitting at Dole, in Franche-Comté, authorising the country-people to take their weapons, and beat the woods for a were-wolf, who had already—thus went the recital—'carried off several little children, so that they had not since been heard of, and done injury to some horsemen, who kept him off only with great difficulty and danger to their persons.' Throughout Europe, the judicial cognizance of witchcraft and of lycanthropy ceased at the same time. In Great Britain, where wolves had early been exterminated, the were-wolf was only known by rumours coming from abroad; but the belief that witches could transform themselves into cats and hares, which did prevail, was precisely analogous to the belief in were-wolves, especially in its later forms.

The later forms of this strange belief were obviously sophisticated. In its earlier shape, three things are to be noticed—the power ascribed to the were-wolf of transforming himself, either by changing the shape of his own body, or projecting his spirit into another body; his appetite for human flesh; his taking the shape and nature of the animal held to be most malicious against man—the wolf. As to the first of these, all that can here be done is to point to its connection with the doctrine of Transmigration (q. v.), and to add that it has been one of the commonest of human beliefs. As to the second, is it unlikely that in the early times in which the superstition had its origin, the appetite for human flesh may have been common enough to spread terror through whole districts? It is, at least, not improbable that every race of men has had an experience of cannibalism; and it may well have been that, in occasional cases, especially under conditions of disease, the taste for human flesh survived the general practice of using it. Modern Europe affords many unquestionable examples of this taste existing and being indulged in the midst of comparative civilisation. There can be no doubt that some of the unhappy multitude put to death as were-wolves had really murdered and eaten the flesh of human beings. But secret murders, unaccompanied by cannibalism, would tend to support a popular belief in cannibalism. We have not to go out of our own age for proofs of the existence of men afflicted with a homicidal tendency; and in times when the means of detecting crimes were very imperfect, it is conceivable that the murders committed by one or two such persons would spread terror, and give support to a superstitious theory throughout a large district. The *Maréchal de Retz*, who lived in the time of our Henry VI., had caused

to be stolen and put to death by torture, under the most inhuman circumstances, many hundred children—he confessed on his trial that he murdered 120 in a single year. (A memoir of Gilles de Laval, Maréchal de Metz, has been compiled from authentic documents by P. J. Lacroix, the eminent French antiquary.) Perhaps no society has ever been free from men similarly constituted, and acting similarly according to their opportunities. As to the third point, if it be granted that a certain practice of, or general suspicion of cannibalism existed among a people who believed in the power of transformation, it is easy to understand how the cannibal, getting his victims by stealth, was supposed to indulge his inhuman appetite under the guise of the animal most unfriendly to man. And the existence of a form of mania in which the madman had the hallucination that he was changed into a wolf, yelled like a wolf, lived in many respects like a wolf, was calculated strongly to confirm the belief in men-wolves. In conjunction with the mischief done by real wolves, this itself may be thought almost enough to have given origin to the superstition. The hallucination of having undergone transformation into a wolf from time to time, seems to have been one of the commonest by which weak and crazed brains were possessed during the period when the hunt for werewolves was kept up. The literature of this subject, though abundant, is for the most part fragmentary, and mixed up with other matters. A good account of the subject will be found in *The Book of Werewolves*, by Sabine Baring-Gould (Lond. 1865).

WERNER, ABRAHAM GOTTLIEB, a celebrated mineralogist and geologist, born at Wehrau, on the Queiss, in Upper Lusatia, September 25, 1750. His father was director of a smelting-work, and he was thus led almost in childhood to the study of minerals. After some time spent at the Mineralogical Academy of Freyberg, he went to Leipzig, where he studied natural history and jurisprudence. Here, at the age of 24, he published his first work on mineralogy, a mere pamphlet on the external characters of minerals. In 1775, he was appointed Professor of Mineralogy, and curator of the Mineralogical Cabinet at Freyberg. In 1780, he published the first part of a translation of Cronstedt's *Mineralogy*, in his notes to which he gave the first outlines of the system which bears his name. In 1791, he published a *Theory of the Formation of Metallic Veins*, which was translated into English and French, and greatly extended his reputation. He was not, however, a voluminous author, but his views were diffused by his pupils, among whom were the most eminent German mineralogists of the time. In 1792, he was appointed Councillor of Mines in Saxony. He died at Dresden in 1817.

W.'s influence was very great in the promotion both of mineralogy and of geology. In his mineralogical system, minerals were distinguished and arranged chiefly according to their external characters; and mineralogists have now learned to depend much more than he did on their chemical constitution. In geology, he did great service by arranging the facts already known, and guiding to proper methods of observation. His theory was extensively received for a time. It may be described as the opposite of the Huttonian theory, accounting for the present state of mineral substances in general by supposing them to have been dissolved or suspended in water; whilst the Huttonian theory ascribed almost everything to the action of fire. W.'s is sometimes called the Neptunian theory, whilst that of Hutton is styled the Plutonic. Modern geology recognises a certain measure of truth in both, but rejects them alike in that character of completeness or universality in which

they were once advocated. W. classified rocks into Primary, Transition, and Secondary; and the terms are still sometimes used, although merely as convenient names, not as indicative of opinions concerning the rocks designated by them.

WERNIGERODÉ, a small walled town of Prussia, in the government of Magdeburg, and 43 miles south-west of the city of that name, stands at the northern base of the Brocken Mountain. Its castle, the residence of the Counts Stolzberg-Wernigerode, comprises a library of 40,000 volumes, and a zoological garden. It manufactures linen, cloth, and tobacco; and carries on copper-smelting and paper-making. Pop. (1871) 6794.

WESSEL, a strongly fortified town of Prussia, on the Rhine, 32 miles north-north-west of Düsseldorf. The Rhine, which here is joined by the Lippe, is divided by a fortified island, and crossed by a bridge of boats, protected on the left bank by a fort. Of its churches, the Willibrod Kirche was first opened in 1181. Cloth, hosiery, serge, leather, hats, tobacco, and linen are manufactured, and book-printing is carried on. The citadel is defended by about 4500 men. Pop. (1871), inclusive of garrison, 18,519.

WESER (Lat. *Visurgis*), a river of Germany, formed out of the Werra, which rises in the Thuringer-wald, and the Fulda, rising in the Rhön-gebirge, on the frontiers of Prussia and Bavaria. These streams, after a northern course, unite at Münden, in Hanover; and the united stream, the W., flows north through Prussia, till, passing Bremen, it forms for about 40 miles the boundary between Oldenburg and Prussia, and enters the North Sea by a wide but shallow estuary, much interrupted by sand. Entire length, 260 miles. It communicates with the Elbe by a navigable canal; but though considerably improved in this respect, the W. is not of much use as a navigable stream. The principal trading-town on its banks is Bremen.

WESLEY, JOHN, the founder of the Methodists (q. v.), was born at Epworth, in Lincolnshire, England, 17th June 1703. The family name was variously spelled Wesley and Westley, and is supposed to be the same with Wellealey, and to be derived from a place of that name near Wells. An Irish gentleman, Garrett Wellealey, Esq., of Dunganon, offered to make Charles Wesley, younger brother of John, his heir, on condition of his settling in Ireland, believing him to be of his own family. The offer was not accepted; and the estate of Mr Wellealey went to another branch of the family, which was soon raised to the Irish peerage, with the title of Earl of Mornington, and from which the Duke of Wellington and the Marquis of Wellealey sprung. The more immediate progenitors of John W. were ministers of the church of England, of Puritan principles. Some of them suffered for non-conformity. Bartholomew Wesley, the great-grandfather of John, was ejected from his living by the Act of Uniformity in 1662. John Wesley, the son of Bartholomew, was also deprived of his living, and was often fined, and several times imprisoned for preaching contrary to the law. Samuel Wesley, a son of this John Wesley, conformed to the Church of England, but opposed the schemes of James II., refusing to be bribed by offers of preferment, which, on account of his erudition and talents, it was thought worth while to make to him. He supported the cause of the Revolution, in circumstances of personal danger, and in the beginning of the reign of William and Mary, was rewarded with the living of Epworth. He wrote an epic poem entitled *The Life of Christ*, and other similar works. He had a family of nineteen children. His wife, Susannah

Annealey, the daughter of an ejected minister, was a woman of remarkable intelligence and fervent piety, who devoted herself very much to the education, and particularly the religious education, of her children. His eldest son, Samuel, head-master of Tiverton school in Devonshire, was a Tory and High-Churchman, who strongly disapproved of the 'new faith' and peculiar course of his brothers John and Charles. John W. was the second son of Samuel, or the second who grew up to manhood. In his infancy, he had a narrow escape from being burned to death, when the parsonage of Epworth was burned by some of the parishioners in their rage against their pastor for his faithful reproving of their vices. Another remarkable story is connected with the parsonage of Epworth, and with the early years of John W.'s life—the continued disturbance of the family, throughout a considerable time, by loud knockings and other noises, which could not be accounted for, and which therefore were regarded as preternatural, although Mr Wesley and his household were less affected by the strange visitation than perhaps its authors expected them to be, and persisted in residing in the parsonage, even making sport of 'Old Jeffery,' their unseen visitor, who 'was plainly a Jacobite goblin, and seldom suffered Mr Wesley to pray for the king and the Prince of Wales without disturbing the family prayers.'

John W. was a very diligent and successful student. The religious history of his college life belongs to the history of Methodism (q. v.). After much conscientious hesitation as to his motives and fitness for entering into the clerical profession, he was ordained deacon in 1725, and in 1726 he graduated as M.A., and was elected fellow of Lincoln College, Oxford. In the same year he was appointed Greek lecturer and moderator of the classes. He became curate to his father at Wroote, a small living which Samuel W. held along with that of Epworth, and whilst serving here, he was advanced to priest's orders in 1728. He returned to Oxford, and along with his younger brother, Charles, entered into those religious associations from which Methodism sprang. The intercourse of the brothers Wesley at this time with William Law, the author of the *Serious Call*, had a great influence on their opinions and conduct. They walked two or three times a year from Oxford to visit Law at his house near London. In 1735, John W. was induced to go out to Georgia with General Oglethorpe, to preach to the Indians and colonists. His religious views at this time were strongly tinged with asceticism. His intercourse with Moravians, who were his fellow-passengers to America, and afterwards his fellow-labourers in the colony, tended to stimulate his religious zeal. He attempted to establish a discipline in the colony, very different from that of the Church of England at home, and failed in the attempt. The difficulties of his position were increased by an affair in which he became involved with the daughter of the chief magistrate of Savannah, whom he wished to marry; but on the advice of the Moravian bishop and elders, to whom he submitted the matter, he withdrew from her, and she very soon marrying another, W. refused her admission to the communion; upon which her husband raised an action at law, and W., finding Savannah no suitable place for him, and, as he said, 'shaking the dust off his feet,' returned to England, having resided in America not quite two years. With religious zeal undiminished, he maintained an intimate connection with the Moravians in London. On 24th May 1738, some months after his return to England, he attended a meeting of a society in Aldersgate Street, where, whilst one was reading Luther's preface to the Epistle to

the Romans, he experienced such a change of religious feeling that, notwithstanding all his previous zeal, he ever afterwards regarded this as the time of his conversion. 'I felt my heart strangely warmed,' he says; 'I felt I did trust in Christ, Christ alone, for salvation; and an assurance was given me, that He had taken away my sins, even mine, and saved me from the law of sin and death.' Many who accept generally Wesley's views of conversion, doubt his opinion as to the date of his own. After this, he visited the Moravian brethren at Herrnhut in Germany, made the acquaintance of Zinzendorf, and was introduced to the Prince Royal of Prussia, afterwards Frederick the Great. Returning to England, he became associated with his old college companion, Whitefield, and after his example began, in 1739, the practice of open-air preaching. From this time, the history of Wesley's life becomes very much the history of Methodism. In 1740, he solemnly separated himself from the Moravians, finding that he differed from them on important points of doctrine; and in the same year the breach took place between Whitefield and him, which divided the Methodists into two sections, Calvinistic and Arminian. In the evangelistic work which he carried on in England, and in organising the Methodist body, W. was indefatigable. He seldom travelled less than forty miles a day, usually on horseback, till near the close of his life, when he used a chaise. In 1782, he married a widow with four children, but the marriage proved an unhappy one, and a separation ensued. His health gradually declined during the last three years of his life, and after a short illness, he died in London, 2d March 1791, in the 88th year of his age. His remains lay in state for several days in his chapel in the City Road, dressed in the sacerdotal robes which he usually wore, with a Bible in his hand. W. was a voluminous writer. His writings are chiefly polemical and religious. His style in the pulpit was fluent, clear, and argumentative, not impassioned like Whitefield's; his countenance was mild and grave; and his manners agreeable, although he exercised a very imperial domination over the preachers of the Methodist body. He was a man of great benevolence, and gave away all his living to the poor. Probably no man ever exerted so great an influence on the religious condition of the people of England as John W., and his influence has extended to the most remote parts of the world.—CHARLES WESLEY, his younger brother, born at Epworth, 18th December 1708, was associated with him in the whole Methodist movement. Having studied at Christ Church, Oxford, and visited Georgia at the same time with his brother, he took an active part in the subsequent work in England. He was a clear and simple preacher, and a man of fervent piety, but of a disposition very far removed from asceticism. He is the author of a great number of hymns in use among the Methodists; some of which, however, are among the best and most admired hymns in the English language, replete with pious feeling, and of lyrical power and sweetness almost unsurpassed.—See *The Works of the Rev. John Wesley* (16 vols., Lond. 1809); *Life of the Rev. John Wesley, A.M.*, by Dr Coke and Mr Moore (Lond. 1792); and *The Life of Wesley, and the Rise and Progress of Methodism*, by Southey (2 vols., Lond. 1820; new edition in Bohn's Standard Library, Lond. 1864).

WESSEL, JOHANN, called also *Gangfort*, a predecessor of Luther, was born at Gröttingen, 1419, taught philosophy at Cologne, Louvain, Heidelberg, and Paris, and died (1489) in his native town. On account of his learning, he was called *Lux Mundi* (Light of the World); while his enemies, on account

of his opposition to the scholastic philosophy, termed him *Magister Contradictionum* (Master of Contradictions). In his doctrine of justification by faith, he forestalled Luther, who esteemed him very highly. After his death, a large portion of his writings were burned as heretical. Another portion appeared under the title of *Farrago Rerum Theologicarum*, of which Luther published an edition with a preface (Wittenb. 1522), but the most complete edition is that by Joh. Lydius (Amst. 1617). See Ullmann's *Joh. Wessel, ein Vorgänger Luther's* (Hamb. 1834), and Bähring's *Das Leben Joh. Wessel's* (Bielef. 1846).

WESSEX. See HEPTARCHY.

WEST, BENJAMIN, Anglo-American painter, was born at Springfield, Pennsylvania, October 10, 1738, of Quaker parentage, and with lack of opportunity or encouragement, surprised his friends by his skill in drawing at the age of seven years, and at nine painted a picture in water-colours, which, in some points, he declared in after-life, he had never surpassed. His first colours were made from leaves, berries, &c., and his brushes stolen from a cat's tail. Thus self-taught, at the age of 16 he practised portrait-painting in the villages near Philadelphia, and painted for a gunsmith his first historical picture, 'The Death of Socrates.' While the Society of Friends were discussing the propriety of his becoming a painter, he shocked their principles still more by volunteering in a military expedition to search for the remains of Braddock's army. At 18, he was painting portraits in Philadelphia, and later at New York, where, in 1760, he was aided by some generous merchants to go and pursue his studies in Italy. At Rome, he was patronised by Lord Grantham, whose portrait he painted, became the friend of Mengs, and, as the first American artist ever seen in Italy, attracted much attention. He painted his 'Cimon and Iphigenia,' and 'Angelica and Medora,' and was elected member of the Academies of Florence, Bologna, and Parma. In 1763, visiting England on his way to America, he was induced to remain in London, and in 1765 married Eliza Shewell, to whom he had been engaged before leaving America. His 'Agrippina landing with the ashes of Germanicus,' attracted the attention of George III., who was his steady friend and patron for forty years, during which time he sketched or painted 400 pictures. His 'Death of General Wolfe,' painted in the costume of the period, against the advice of all the most distinguished painters, effected a revolution in historic art. For the king, he painted a series of 28 religious pictures for Windsor Castle. His best-known works are 'Christ healing the Sick,' 'Death on the Pale Horse,' and the 'Battle of La Hague.' In 1792 he succeeded Sir Joshua Reynolds as the President of the Royal Academy, but declined the honour of knighthood. Through his whole career, he was the generous friend, adviser, and patron of young artists. *The Life and Studies of Benjamin West* were compiled from materials furnished by himself, by John Galt, in two parts (Lond. 1816—1820); and a biography of him is also given in Cunningham's *Lives of Eminent British Painters*. He died in London, March 11, 1820, and was buried with great pomp at St Paul's Cathedral. His wife died 1817. Two sons survived him.

WEST BROMWICH, a large and rapidly increasing town of South Staffordshire, one of the most important towns in the great manufacturing and mining district known as 'The Black Country,' five miles north-west of Birmingham. A few years ago, W. B. was a mere village on a barren heath, and it owes the rapidity of its growth mainly to the rich

mines of coal and iron in the vicinity, and to the industries to which these give rise. Very many canals, and three railways, run through the parish. There are numerous churches, schools, and other important establishments. There are very large glass-works and also gas-works in the town: much of the gas used in Birmingham, as well as all that supplied to W. B., Wednesbury, and many other towns in the vicinity, being made here. The manufactures of iron-wares of all kinds, as gun and pistol barrels, locks, swords, fire-irons, fenders, &c., and of all kinds of hollow-wares, as kettles, sauce-pans, &c., are among the great branches of industry. Pop. (1871) 47,981.

WESTBURY, a small and ancient parliamentary borough of Wiltshire, 20 miles north-west of Salisbury, and on the western declivity of the Salisbury Plain. Its church, a tasteful edifice, was erected—the older parts at least—in the 13th century. For the most part uninteresting in itself, W. stands in the midst of a locality interesting from its many antiquities. W. is a station on the Wiltshire and Somerset Railway. Pop. (1871) 6396, chiefly employed in agriculture, the manufacture of woollen cloth of a superior quality, and the smelting of iron ore, some extensive mines of which have lately been discovered near the town, and which afford employment to many hands.

WESTCHESTER, a beautiful town, in a rich agricultural district of Pennsylvania, U. S., 23 miles west of Philadelphia, with elegant residences, a granite court-house, a white marble bank, 10 churches, an academy, a state normal school, and 2 public libraries. Pop. (1870) 5630.

WESTERN AUSTRALIA, a British colony, and the western section of the great island-continent of Australia, embraces the whole of that island west of the 129th meridian. Its extreme length from north-east to south-west is 1370, its average breadth is 650 miles, and its area is estimated at 978,000 sq. miles. Pop. (1871) 24,353, of whom 15,375 were males, and 9410 females. Revenue (1874) £148,072; expenditure, £143,266. This colony was formed in 1829, and in 1851 had only 5886 inhabitants; but within recent years a considerable number of emigrants have been sent out under the auspices of the Government Emigration Board. W. A. was formerly named *Swan River Settlement*, from the river Swan, which joins the Indian Ocean, after watering a considerable district in the extreme south-west. Of the whole vast area, this district in the south-west is now, as formerly, the only portion inhabited. There, mountain-ranges rising in elevation from the coast inland, run parallel with each other from south to north; the highest summit being 5000 feet above sea-level. The climate is agreeable and salubrious; the soil, both on the coast and in the interior, is light and dry. Bands of fertile land, where the sandal-wood and other trees grow abundantly, and which are suitable for the culture of the vine, olive, and fig, occur in the middle districts of the country. Rivers, of which the Swan is the chief, abound; but are not of much use for navigation. Magnetic iron ore, lead, copper, and zinc ores are found in large quantities, and a little coal has been found. In 1874, 144 vessels, of 65,351 tons, entered the ports. There is a pearl-fishery on the N.W. coast, producing to the value of £74,000 in 1874. Imports in 1874 (chiefly groceries, beer, ironmongery, and clothing) amounted to £367,418; exports (chiefly wool, sandal-wood, timber, copper-ore, and horses), £398,901. The capital is Perth, and there are several smaller towns. The colony became (1849), at the request of the colonists, a settlement for convicts, and has much



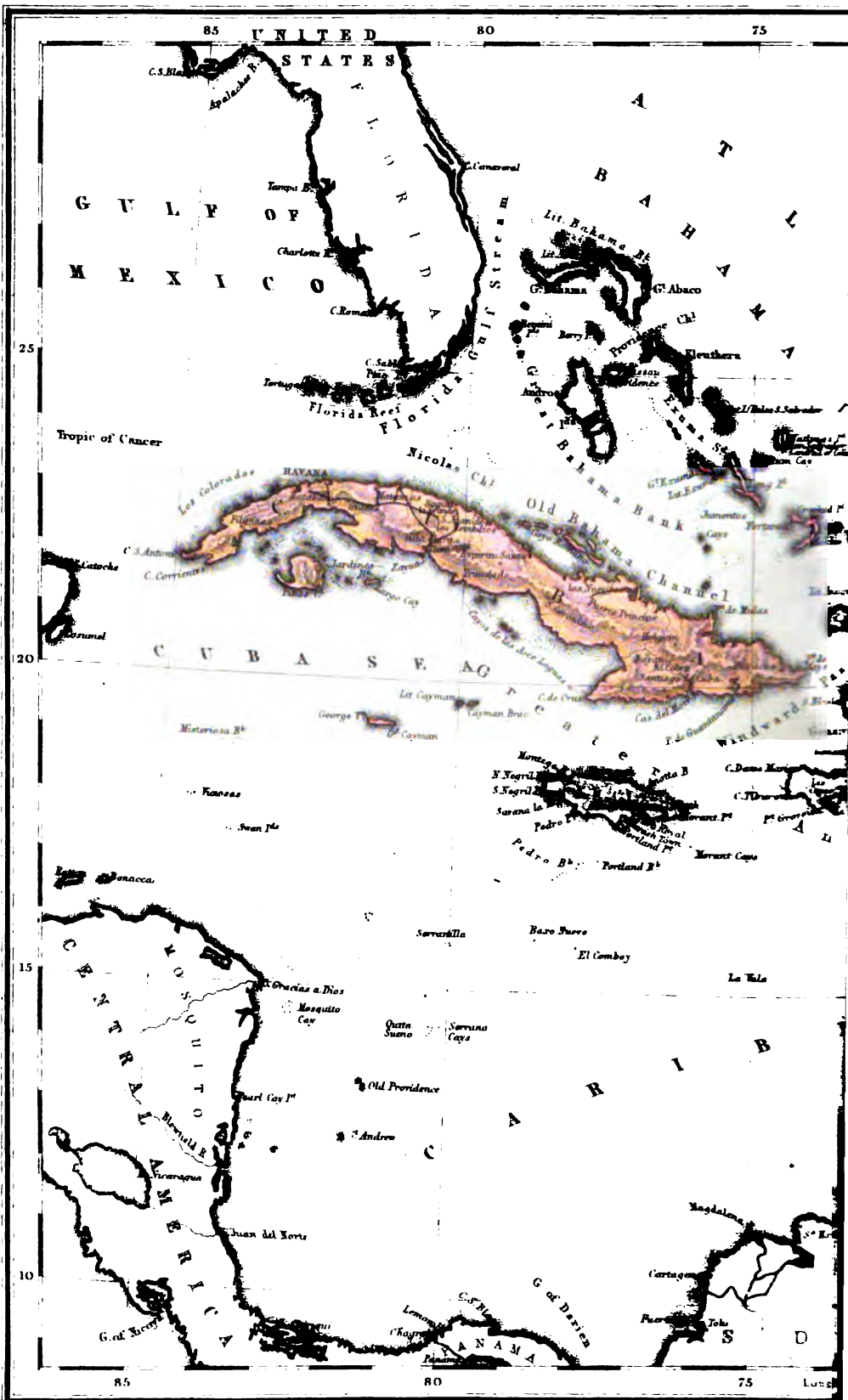

# WEST INDIA ISLANDS

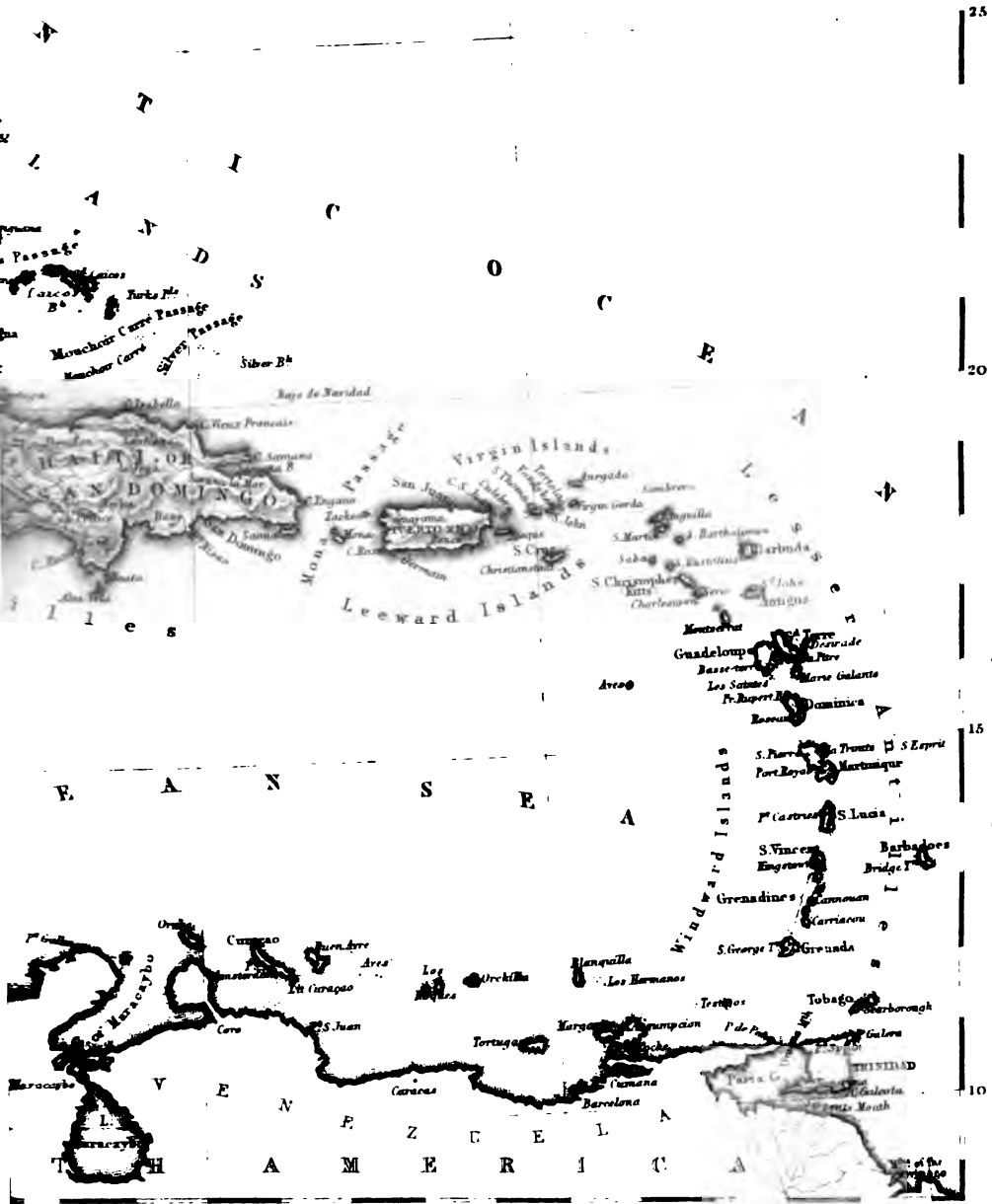
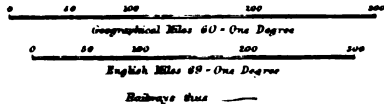

From Greenwich 70 65 60



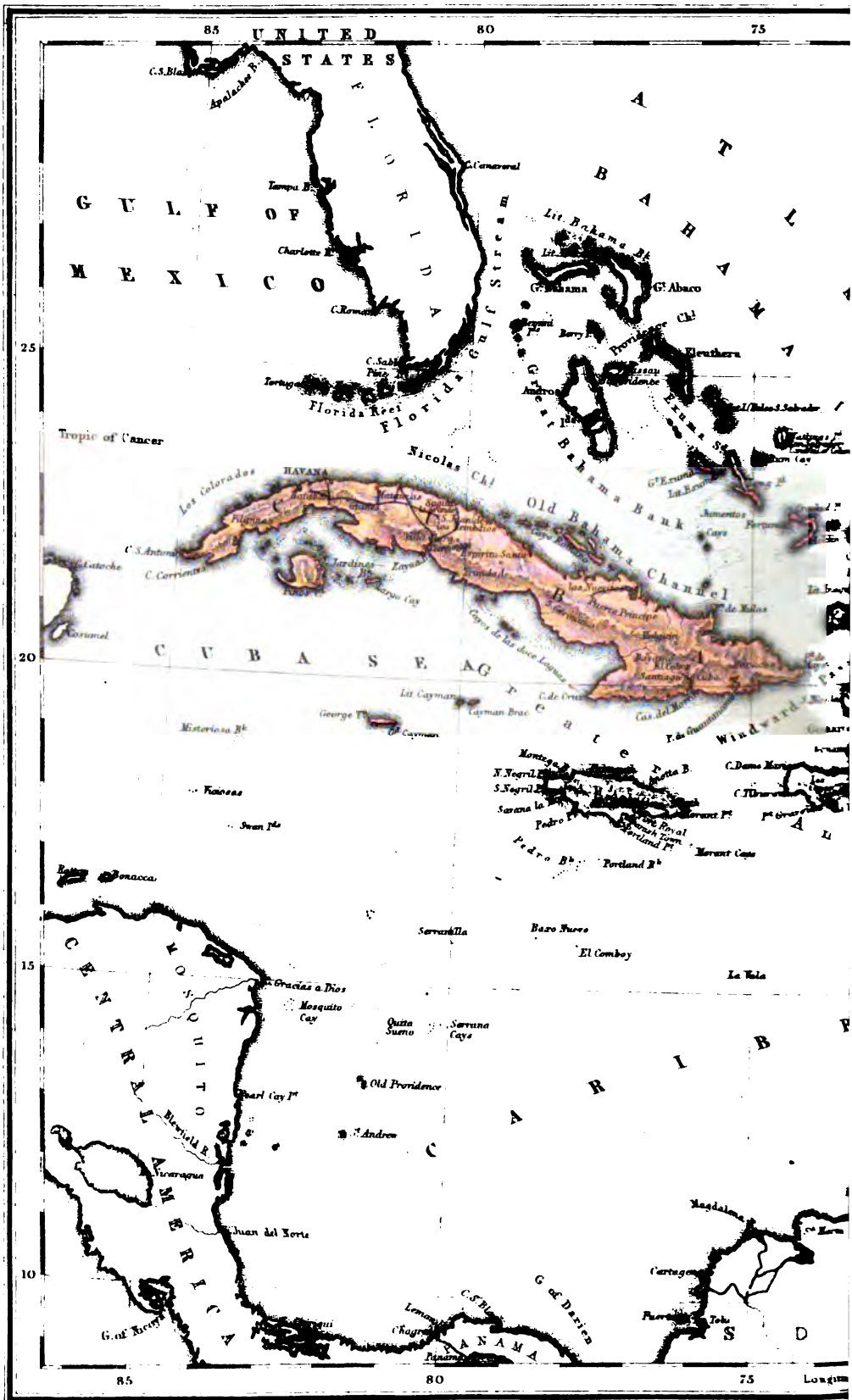

# WEST INDIA ISLANDS

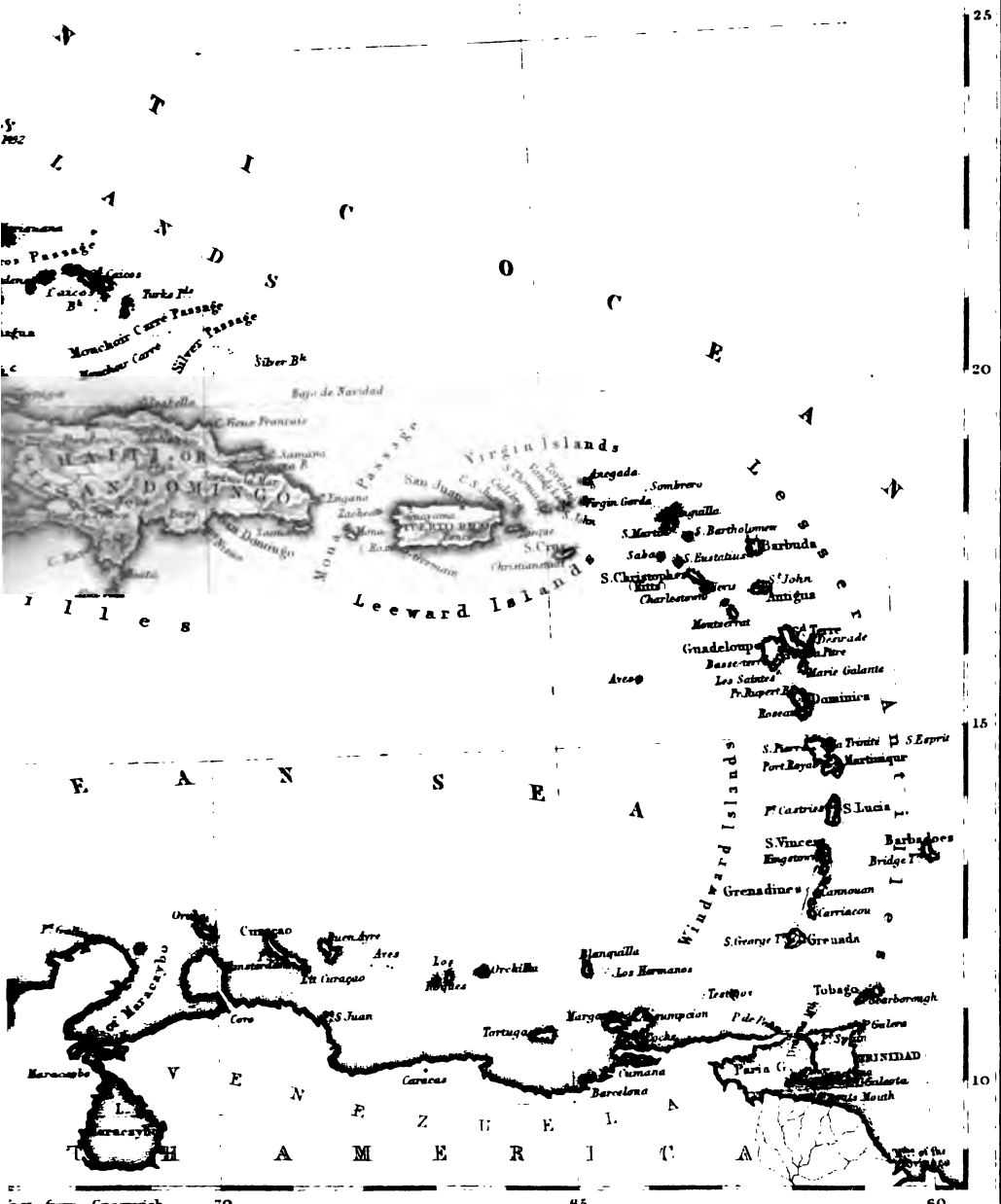
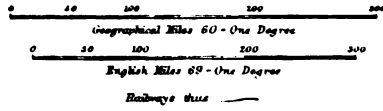

West from Greenwich 70 65 60

W. & A. K. Johnston Edinburgh

DON & EDINBURGH



benefited by their labour, a great extent of road, and many public buildings having been constructed by them. In 1868, the home authorities were, however, persuaded by the Australian colonists finally to discontinue transportation to Western Australia.

**WEST INDIES** are already described under **ANTILLES** (q. v.). See also the names of the islands themselves—Jamaica, Cuba, Martinique, &c.; as well as the European countries that possess them—Great Britain, Spain, France, Netherlands, &c.

**WESTMACOTT, SIR RICHARD, R.A.**, an eminent sculptor, the son of Richard Westmacott, also a sculptor in his day of some little note, was born in London in 1775. His predilection for art was early manifested, and was carefully cherished by his father. He received as a youth the best education which London could then furnish, and in 1793 he proceeded to Rome to complete his studies. Here he became in some sort a pupil of the celebrated Canova, who shewed him much kindness and attention. His progress was rapid, and he distinguished himself by carrying off the highest prizes offered to the competition of the rising geniuses of the day, in particular a gold medal given by the Pope. In 1797, having, meantime, in recognition of his talent and promise, been elected a member of the Academy of Florence, he returned to London, where, shortly after, he was married to a daughter of a Dr Wilkinson, then of some medical celebrity. His success in his art was not for a moment doubtful, and very soon he found himself in full employment. In 1805 he was elected an Associate of the Royal Academy; in 1816 he was advanced to the full dignity of Academician; and in 1835 the University of Oxford recognised his eminence by conferring upon him the honorary degree of D.C.L. Two years afterwards, the honour of knighthood was bestowed on him. Previously, in 1827, he had succeeded Flaxman as Professor of Sculpture at the Academy, in which capacity he continued to officiate till his death, which took place on September 1, 1856. The works of Sir Richard W. by which he is chiefly known are public monumental statues, in some of which he had much success. Of these it may suffice to mention his statues in Westminster Abbey of Pitt, Fox, Perceval, and Addison, with the monuments to Sir Ralph Abercromby and Lord Collingwood in St Paul's Cathedral. Many of his works in the antique classical manner, are also of exquisite beauty and finish.

**WESTMACOTT, RICHARD, R.A.**, son of the foregoing, was born in London in 1799. After being carefully educated under his father in the art which might seem to run in the family blood, he was sent to Rome in 1820 to prosecute his studies further. In Italy he passed six years; and after his return to London, he gradually won a reputation for himself as one of the ablest sculptors of the day. Besides being eminent in his art, he likewise made himself known as a man of considerable literary and general attainment; and in 1837 he had the honour to be elected a Fellow of the Royal Society. In the year following, the Academy recognised his more special claims by assuming him as an Associate; and in 1849 he attained the rank of Royal Academician. On the death of his father, he was appointed to succeed him in the Professorship of Sculpture, a post which he filled with distinguished ability and acceptance. He died in 1872.

**WESTMEATH**, an inland county of the province of Leinster, Ireland, bounded on the N. by the counties of Cavan and Meath, on the E. by Meath, on the S. by the King's County, and on the W. by Roscommon. It lies between N. lat. 53° 8'

and 53° 48'; and W. long. 6° 54' and 7° 55'. Its greatest length, N. and S., is 35 miles, and the greatest breadth is 25 miles; the total area being 708 miles, or 453,468 acres, of which 365,218 are arable, 56,392 uncultivated, 8803 in plantations, 628 in towns, and 22,427 under water. The population in 1851 was 111,109; in 1861, 90,879; in 1871, 78,432, of whom 71,765 were Catholics, 5997 Protestant Episcopalians, and the rest Protestants of other denominations. The surface is for the most part level, the hilly district, which is in the north of the county, not reaching at any point a higher elevation than 710 feet. Nevertheless, owing to the number of lakes, and the large extent of wood in some districts, the scenery is in many places highly picturesque. Geologically, W. belongs to the great central limestone series; yellow sandstone only occurring in two very limited districts. Of the numerous lakes which diversify the surface, one chain belongs to the basin of the Shannon, which river, with its lakes, forms the western boundary, and separates W. from Roscommon; the other, towards the east, flows into the basin of the Boyne. The Shannon is navigable for steamboats throughout that portion of its course which bounds this county; and the inland navigation is further provided for by the Royal Canal, which traverses W. from east to west, and by a branch of the Grand Canal. The county is also traversed by the Midland and Great Western Railway. The climate is mild and not very moist. The soil is a deep loam, producing herbage especially suited to the fattening of cattle, which are largely fed; sheep also are fed, but not in the same proportion: as are also horses and pigs. There is little tillage, and almost the only cereal crop is oats. The total acreage under crops of all kinds in 1875 was 99,408, of which only 141 were in wheat; 26,500 acres were in oats, 11,991 in potatoes, 5657 in turnips, 51,619 in meadow and clover. The quantity under other green crops than turnips and potatoes was small, and only 20 acres were in flax. On the other hand, the total number of cattle was 96,802, of sheep 161,034, of horses 11,833, and of pigs 19,154. The net annual value of property under the Valuation Act is £314,701. W. is divided into twelve baronies. The chief towns are the assize town and capital, Mullingar (q. v.), Moate, and Athlone, which is partly in the county of Roscommon. It returns three members to the imperial parliament, two for the county and one for the borough of Athlone. The constituency in 1875—1876 numbered 3552. The number of pupils at the national schools in 1875 was 16,972. W. anciently formed a portion of the kingdom of Meath (q. v.), but in the 34th of Henry VIII., it was erected into a separate county, and at first included Longford (q. v.) and part of the King's County (q. v.). Many antiquities of the Anglo-Norman period, and some of the Celtic, chiefly tumuli and raths, are found in this interesting and picturesque county.

**WESTMINSTER, THE CITY AND LIBERTY OF**, now forms part of the English metropolis. It is bounded by Temple Bar on the east, the Thames on the south, Chelsea and Kensington on the west, and Marylebone on the north. The early history of W. is that of the abbey, still the most interesting of its public buildings. In early times, that part of W. which adjoins the Thames was surrounded by a branch of the river, so as to form an island called Thorney Island, from its being covered with brushwood. Here, on the site of the present abbey, Sebert, king of the East Saxons, is said, in the 7th c., to have built a church. It is supposed to have been replaced by an abbey called Westminster, to distinguish it from the cathedral church of St

Paul's, called originally Eastminster. The first edifice erected on the site, of which we have any certain account, was one built of stone by Edward the Confessor in 1065. The Pyx House, a low apartment, 110 feet long by thirty feet wide, vaulted and divided by a central range of eight plain pillars with simple capitals, is nearly all that remains of it. The principal parts of the existing abbey were built by Henry III. In 1220 he erected a chapel dedicated to the Virgin, and a quarter of a century later he took down the old abbey of the Confessor, and erected the existing choir and transepts, and the chapel of Edward the Confessor. The remainder of the building was completed under the abbots, the western parts of the nave and aisles having been erected between 1340 and 1433. The west front and its great window were the work of Richard III. and Henry VII. The latter pulled down the chapel to the Virgin, erected by Henry III. at the east end of the church, and built the chapel known as Henry VII's chapel. This completed the interior of the abbey as it now stands; the only important addition made since then having been the upper parts of the two western towers, which were the work of Sir Christopher Wren. The whole building forms a cross. Its extreme length, including Henry VII's chapel, is 511 feet; its width across the transepts is 203 feet. The width of the nave and aisles is 79 feet; of the choir, 38 feet; and of Henry VII's chapel, 70 feet. The height of the roof is 102 feet, a loftiness unusual in English churches. It is the interior of the abbey which has at all times excited the most enthusiastic admiration. The harmony of its proportions, and the 'dim religious light' of the lofty and long-drawn aisles, leave on the mind impressions of grandeur and solemnity which churches of greater size fail to produce. The abbey was at one time the burying-place of the English kings, and it has become a national honour to be interred within its walls. It is crowded with tombs and monuments. The chapel of Edward the Confessor, at the east end of the choir, contains his shrine erected by Henry III, the altar-tombs of Edward I, Henry III, Henry V., and Edward III. The canopy of that last mentioned deserves especial notice. It is considered to be one of the greatest works in wood extant, and equal to anything in the best age of mediæval art. Against the altar-screen in this part of the church stand the two coronation chairs. One, the king's chair, encloses the stone brought by Edward I from Scone, on which the Scotch kings were crowned. The other, the consort's chair, was constructed for the coronation of Mary, wife of William III. Both are still used at coronations. Most of the English kings, from the time of Henry VII down to that of George III, were buried in Henry VII's chapel, and there accordingly are the tombs of Queen Elizabeth and Mary Queen of Scots. The most remarkable monuments in other parts of the church are those in the east aisle of the southern transept, known as 'Poets' Corner,' where many of the most eminent British poets have been buried. There monuments are erected to Chaucer, Beaumont, Drayton, Cowley, Dryden, Milton, Gray, Prior, Shakspeare, Thomson, Gay, Goldsmith, Addison, and Ben Jonson. In the north transept are the monuments of Pitt, Fox, Chatham, Canning, and Wilberforce. Elsewhere are the monuments of the great engineers and inventors, Telford, Watt, and Stephenson.

Since Dean Stanley (q. v.) became connected with the abbey in 1864, much has been done to restore and improve the interior, and services conducted in it have attracted much public interest; more especially the anniversary of the foundation, celebrated

on 28th December 1865, and the mission sermon delivered by Professor Max Müller on 3d December 1873, when the dean of an abbey asserted his right to allow a layman to preach there.

South of the abbey are the Pyx House, chapter-house—since 1866, restored under the direction of Sir Gilbert Scott—cloisters, and the building occupied by W. School, formerly the monks' dormitory, &c. W. School was founded by Queen Elizabeth for the education of 40 boys known as Queen's scholars, who are prepared for the universities. Other persons send their sons to it, and it has long been one of the leading English public schools.

The city of W. sprang up round the abbey, and the English kings, in consequence of the jealousy with which they regarded the privileges claimed by the citizens of London, early took up their abode there. Before Edward the Confessor began to build his new church at Westminster, the residences of the English kings had been the Roman fortress in London, or the Saxon city of Winchester. The king, to superintend the building of the church, took up his abode in the palace. William Rufus, in 1097, erected a palace between the abbey and the Thames. Its chief apartment was a banquetting-hall, which, becoming ruinous in the time of Richard II., he pulled down, and erected in 1397—1399, on the same site, and indeed on the same foundations, the great hall which still exists. It is 90 feet high, and 290 feet long, by 68 feet wide internally, and is roofed by 13 great ribs of timber, combined with a mechanical skill which has not been excelled in any work of the present age. The roof of Westminster Hall is the finest specimen of the purely English art of forming a Gothic roof of wood: with the exception, perhaps, of the Hall of Justice at Padua, it is the largest roof in Europe unsupported by pillars. The law courts were established at the hall in 1224, and they continue to be held in buildings which rest on the northern side of the building, and open into it by side-doors. These law-courts, as an excrescence and out of place, are to be removed to the new buildings about to be erected near Lincoln's Inn Fields.

The old Houses of Parliament which adjoined the hall, and like it lay between the abbey and the Thames, were burned to the ground in 1834. It was then determined to erect a new building on the same site, but on a much grander scale. The designs of Sir Charles Barry for 'the New Palace of Westminster' were selected as the best, and the work was begun in 1840. The building is the most magnificent erected in this country for many centuries. It may be roughly said to form a parallelogram, 900 feet long by 300 feet in width. The principal rooms are the House of Lords and the House of Commons, which occupy the centre of the building, and run on the line of its greatest length. They are separated by an 'Octagon Hall,' with a diameter of 70 feet between the walls. From this hall, one corridor runs north to the House of Commons, and another south to the House of Lords, beyond which are the royal apartments at the extreme south of the building. The entrance to the 'Octagon Hall' is by a passage known as St Stephen's Hall, which communicates by flights of steps with an entrance in the east front, and also with Westminster Hall, which, included in the new building, forms its northern vestibule. The state entrance of the queen is at the south-western extremity, and is, of course, in direct communication with the royal apartments. The building is surmounted by lofty spires and towers. In the centre, above the Octagon Hall, rises the central tower, 300 feet high. At each corner there are towers; at the south-west the Victoria Tower, 346 feet high; at the north-west the clock-tower, surmounted by a belfry spire 320 feet high. The

WESTMORELAND—WESTPHALIA.

clock has four faces, each 30 feet in diameter; and it strikes the hours on a bell weighing 9 tons, and known as Big Ben. The appearance of the eastern front is still marred by the buildings occupied as law courts, and it is believed that, on their removal, the picturesque outline of the palace, seen from the north-east, will for the first time prove all the merit of the architect's designs. The chief subject of regret in connection with the edifice is, that the stone of which it was built, a magnesian limestone from Yorkshire, has rapidly decayed, and that it has, in consequence, been found impossible to protect the rich ornaments of the exterior from the influence of the atmosphere. Many public improvements have been carried out recently in W., the chief being the construction of the Thames embankment, opened 13th July 1870, which forms a broad and magnificent thoroughfare between the Houses of Parliament and Somerset House; and the erection of the India and Foreign Offices at the eastern extremity of St James's Park, and thrown open to parliament in December 1873.—See *Historical Memorials of Westminster Abbey* (3d edition, Lond. 1869); *Dedication of Westminster Abbey*, by Dean Stanley; *The Memorials of Westminster*, by Rev. Mackenzie E. C. Walcott (1851).

WESTMORELAND, a county in the north-west of England, bounded on the E. by Yorkshire, on the S. and W. by Lancashire, and on the N. by Cumberland and Durham. Area, 500,906 acres, of which there were in 1875, 20,590 acres under corn crops, 10,518 under green crops, 17,626 clover and other grasses, 189,596 of permanent pasture. There were in the same year 7379 horses (used for agricultural purposes), 57,702 cattle, and 331,224 sheep. Pop. (1871) 65,005. The surface is almost wholly mountainous, the chief summit being Helvellyn (3055 feet), partly in Cumberland. The other more important summits are Loughrigg Fell, Bowfell, Crossfell, and High Street and Langdale Pikes. Lakes remarkable for their beauty occur. The chief are Windermere (q. v.), partly belonging to Lancashire; and Ullswater (q. v.), between W. and Cumberland. Moorlands are numerous and extensive; but along the courses of the Kent in the south, and the Eden in the north—the principal streams—there are tracts of fertile land. The climate is mild and moist, often with much snow in winter, the deep wreaths of which frequently prove fatal to travellers on the mountain tracks. The soil is mostly a dry gravelly mould, favourable to the culture of turnips, of which great crops are produced. Rich pasture-lands abound, and cattle, mostly of a large size, are extensively reared. The county town is Appleby, and the other chief towns are Ambleside, Kendal, and Kirkby-Lonsdale. The county returns two members to parliament.

WESTPHALIA, a province of Prussia, lies between Holland, Hanover, Brunswick, Hessen-Nassau, and the Rhine Province. Its area is 770 English sq. m., with a population (1875) of 1,907,195, who, with the exception of about 18,000 Jews, are of the purest German descent. Of the population, 949,118 were, in 1871, Catholics, and 806,464 Protestants. W. is divided into three districts—Münster in the north-west, Minden in the north-east, and Arnsberg in the south. The east of the province presents vast plains covered with grain, while the north-west exhibits an uninterruptedly flat expanse of uncultivated land. The climate is generally temperate. The chief rivers are the Weser (q. v.), the Ems, the Lippe, and the Roer, or Ruhr, each of which is navigable for a considerable part of its course. The prosperity of W. is chiefly due to its flax crops and its mineral treasures, especially coal

and iron. The chief of the industrial products are iron, and articles of iron, steel, and copper from the forges of Arnsberg; while manufacturing industry embraces flax-spinning and linen-weaving in Minden, and extensive production of woollen articles, stockings, and ribbons of esteemed quality. The exports consist of these products, and of meat, especially hams. The capital, Münster (q. v.), had, till 1818, a university, now a higher academy, and is the seat of the supreme Catholic and Protestant religious authorities.—W. derives its name from the Westfalen, a section of the great Saxon people, who migrated hither from the banks of the Elbe soon after the Christian era; and after the subjugation of the Saxons by Charlemagne, the deposed leader, Wittelkind, was allowed to remain *Duke of the Engern and Westfalen*. At this time, the country called W. (and occasionally denominated *Sauerland*) comprised all Germany between the Weser, Rhine, and Ems; and soon after, it was subjugated by the dukes of Lower Saxony, and held by them till, on the rebellion of Henry the Lion in 1179, the electoral archbishop of Cologne extended his sway over it. It then became one of the circles of the empire, and belonged to the Cologne electorate till 1802, when most of it was given to the Hesse-Darmstadt family. In 1807 arose the *kingdom of Westphalia*, which, besides a portion of W., also included Electoral Hesse, Hanover, Brunswick, and portions of Upper Saxony. This kingdom, erected by Napoleon as a preliminary to its incorporation into France, was given to his youngest brother, Jerome, who made Cassel his capital, and, despite the large French garrisons with which the country was burdened, and the extensive contributions in men and money which it was forced to pay to Napoleon, succeeded, by the establishment of the Code Napoleon, and by shewing in various other ways his strong desire to promote the welfare of his new subjects, in acquiring their esteem. But the oppressive conscriptions and taxes for the behoof of the French army and treasury gradually increased in amount, and excited such resentment, that Jerome's life was several times threatened. The king repeatedly remonstrated with Napoleon, but without the slightest effect; and despite his efforts, the 'continental system' was introduced into his states. In 1813, Jerome was chased from Cassel by the Russians; and though he returned for a few days, the defeat of Leipzig forced him to take shelter in France. By the treaty of Vienna, the states which had been joined to W. to form the kingdom, were restored to their former possessors, and W. itself, with the exception of a portion which had been annexed to Hesse-Darmstadt, was united to Prussia.

WESTPHALIA, TREATY OF, also known as the *Treaty of Münster*, was concluded at Münster and Osnabruck (towns in the circle of Westphalia) in 1648, and in putting an end to the Thirty Years' War (q. v.), restored tranquillity to Germany, established a new system of political equilibrium in Europe, and became the basis of all subsequent treaties down till the French Revolution. The minor states of Germany had long desired a cessation of hostilities; and as early as 1638, plenipotentiaries from France, Sweden, and the Empire had assembled at Hamburg; but it was not till several years after, that all parties agreed to Münster and Osnabruck as the places, and to March 26, 1642, as the time, of meeting of the congresses. Ferdinand, however, was very loath to commit himself to a definite negotiation till the success of his arms, the hope of succour from Spain, or a change in the French policy, should give him less the position of a beaten opponent willing to accept almost any terms; and he accordingly temporized

from time to time till his hopes of succour had vanished. In 1644, the congresses opened; the two places of meeting having been chosen to avoid any rivalry between France and Sweden for supremacy, to prevent any collision between the Swedish representatives and the pope, and to separate the Catholics from the Protestants. The representatives of France, the Empire, Spain, and the Catholics of Germany, met at Münster under the mediation of the pope, and those of Sweden, the Empire, and the Protestants of Germany under the mediation of the king of Denmark; the representatives of Spain, Portugal, the United Provinces, Savoy, Tuscany, Lorraine, Mantua, and Switzerland being also present; so that this congress included all the great European powers except Britain, and almost all the minor powers. As the conflict was still carried on with undiminished vigour, the inclination of fortune to one side was the signal for excessive demands, which were met on the other side by evasive proposals; and it was not till Torstensohn's decisive campaign of 1644—1645 that negotiations commenced in earnest, and the representatives made specific propositions. The successes of Turenne and Wrangel in Southern Germany, and the capture of Prague by the Swedes under Königsmark in July 1648, at length overcame all the emperor's dilatoriness, and, the Osnabruck representatives having arrived at Münster a few days before, the treaty was finally signed at Münster, 24th October 1648. Its terms, as regards the Germanic Empire, were as follows: The sovereignty and independence of the different states of the empire were fully recognized, and liberty was given them to contract any alliances with each other, or with foreign powers, if these were not against the emperor or the empire; all religious persecution in Germany was forbidden; the treaty of Passau and the religious peace of 1555 were confirmed; and with respect to the secularisation of ecclesiastical benefices, everything was to remain in Austria as it was in 1624 (hence called the *normal year*), and in the Palatinate, Baden, and Würtemberg as it was in 1618; the power of putting under the ban of the empire was only to be exercised with consent of the diet; and the Reformed were put on a footing of equality as to privileges with the Lutherans. The territorial changes were as follows: the Lower Palatinate was restored to the eldest son of the unfortunate 'Winter King' (Frederick V., Elector Palatine), and an eighth electorate was created in his favour, but the Upper Palatinate and Cham were given to Bavaria, on condition that, should the two states become united, one electorate was to be abolished (as happened in 1777, see BAVARIA); part of Alsace was ceded to France; Upper Pomerania, Rugen with Stettin, Gartz, Damme, Golnau, the isle of Wollin, Peine, Schweine, and Divenau in Lower Pomerania, Wismar, the secularised archbishopric of Bremen as a duchy, and the bishopric of Verdun as a principality, were obtained by Sweden as fiefs of the empire, with three deliberative voices in the diet, and an indemnification of 5,000,000 crowns to be paid by the empire; Brandenburg obtained, as compensation for its cessions in Pomerania, the secularised archbishopric of Magdeburg as a duchy, and the bishoprics of Halberstadt, Minden, and Camin; Hanover and Mecklenburg were compensated for their share in these cessions by secularised church lands; and Hesse-Cassel obtained the rich abbacy of Hirschfeld, with 600,000 thalers. The independence of the United Provinces was recognized by Spain, and that of Switzerland by the Empire. The pope's agent, Fabio Chigi (afterwards Pope Alexander VII.), protested vigorously against the liberal alienation of

the possessions of the Church, and withdrew; and the king of Denmark's mediation being stopped by his war with Sweden in 1644, the treaty was concluded under the sole mediation of the Republic of Venice, and France and Sweden became guarantors for its execution. France, Sweden, and the Protestants were the only gainers by this treaty, which, by weakening the great central authority of the empire, destroyed its unity, allowed France, as one of the guarantors, a pretext for continual interference with its internal affairs, and gave the *coup de grace* to the independence of the remaining free cities of the empire.

**WEST POINT**, site of the United States Military Academy, and of a fortress erected during the War of Independence, on the right bank of the Hudson River, 52 miles north of New York. The Military Academy is on a plain, 160 to 180 feet above the river, surrounded by the bold scenery of one of the finest river-passes in the world. The forts and a river chain were taken by the British in 1777, but abandoned after Burgoyne's surrender, and stronger forts were built, which General Arnold bargained to betray—a plot foiled by the arrest of Major André. The academy was established in 1802, for 40 cadet artilleryists and 10 engineers. The number was increased, in 1806, to 156; in 1812, to 250. It is governed by a board of five visitors and a staff of 51 professors and teachers. The education is free—each pupil engaging to serve eight years. Each member of congress has the right to nominate one cadet from his district, and ten are appointed by the president. The course of study and discipline is four years: (1) mathematics, engineering, fencing, bayonet-exercise, school of the soldier; (2) mathematics, French, fencing, tactics of infantry, artillery, and cavalry; (3) natural philosophy, chemistry, drawing, riding, tactics; (4) military and civil engineering, mineralogy, geology, chemistry, law, literature, practical military engineering, tactics.

**WESTPORT**, a small seaport town of Connaught, Ireland, county Mayo, stands in a pretty valley at the mouth of a small stream that falls into Clew Bay, about 35 miles north-north-west of Galway. Formerly W. was supported principally by linen manufactures; but it is now known mostly for its trade in corn and provisions, and for its facilities for sea-bathing. In the immediate vicinity is the Reek, a mountain 2510 feet high, from which magnificent views of the coast and neighbourhood may be obtained. In 1875, 99 vessels, of 14,187 tons, entered, and 70, of 10,144 tons, cleared the port. The population was (1871) 4417.

**WEST PRUSSIA**. See PRUSSIA, PROVINCE OF.

**WETSTEIN**, the name of a Swiss family illustrious for the talents and learning of its members, originally from Kyburg, in the canton of Zürich. Among the more noteworthy are—(1.) JOH. JAKOB W., born at Basel in 1594, who was first in the service of the Venetian state. In 1620, he became a member of the Supreme Council of his native town; represented Switzerland at the Peace of Westphalia (1648); was raised to the rank of a noble in 1653, and died in 1666.—(2.) JOH. RUD. W., son of the preceding, was born at Basel in 1614, and died there in 1683, professor of theology. He was a great opponent of the introduction of the *Formula Consensus*, and assisted Suicer in drawing up his *Thesaurus Ecclesiasticus*.—(3.) JOH. RUD. W., son of the preceding, born at Basel in 1647, and died there in 1711; also professor of theology, favourably known as an early editor of Origen.—But the most distinguished member of the family is JOH. JAK.

W., son of Joh. Rud. W., the younger, who was born at Basel, 5th March 1693. After a thorough study of the classics, Hebrew, philosophy, and mathematics, he was made a Ph.D. at the age of 16. Four years later, he became a minister, and gave himself up to the study of the New Testament. In 1717, he began to give lessons in theology at the university of Basel, and continued to do so until 1730, when (being suspected of Socinianism) he was forced to leave Switzerland. He sought an asylum in Holland, where the Remonstrants appointed him professor of theology at Amsterdam in 1733. He died there 23d March 1754. W.'s great work is his edition of the New Testament, with prolegomena, a collection of various readings, and Latin notes (2 vols., Amst. 1751—1752). Its publication marks an epoch in the history of New Testament criticism. Semler reprinted the prolegomena with additions (Halle, 1764).

WETTE, DE. See DE WETTE.

WETTER, LAKE, after Lake Wener (q. v.), the largest lake in Sweden, lies in Gothland, about 25 miles south-east of Lake Wener in direct line. It is 70 miles long, 13 miles in average breadth, has an area of 850 sq. m., is 370 feet in greatest depth, and is 300 feet above the level of the Baltic. It receives about 90 small tributaries, though its waters have only one outlet, the Motala River, which, flowing eastward, maintains the communication of the lake with the Baltic. Its waters are clear, and of a beautiful green colour, and it is surrounded by lofty romantic shores, almost unbroken by bays. It is remarkable for an irregular alternation of risings and fallings, and for an occasional undulation, which is so rapid and violent as to break the thick sheet of ice with which it is covered in winter. An intricate chain of small lakes, continued westward by the Göta Canal, connects Lake W. with Lake Wener, and thus with the Cattogat. Lake W. contains few islands, and of these the chief is Wisingsö, 7 miles long by 1½ miles broad.

WETTERHORN (Peak of Tempests), a lofty mountain of the Bernese Oberland, Switzerland, on the east side of the Grindelwald, and about 10 miles south-east of the Lake of Brienz. From the path by which it is ascended, it rises in one vast precipice of alpine limestone, seeming to threaten the traveller. The three peaks of the W. are respectively 12,149, 12,166, and 12,107 feet high.

WETZLAR, a small town of Rhenish Prussia, charmingly situated on the Lahn, 40 miles north of Frankfurt-on-the-Maine. Part of its old cathedral is said to date from the 11th century. W. is notable as the scene of the *Sorrows of Werther*. Pop. (1871) 6180.

WEXFORD, a maritime county of the province of Leinster, Ireland, is bounded on the N. by the county of Wicklow, on the E. by the English Channel, on the S. by the Atlantic, and on the W. by the counties of Waterford, Kilkenny, and Carlow. Its greatest length north and south is 55 miles, and its greatest breadth east and west is 34 miles. The total area comprises 900 sq. m., or 576,616 acres, of which 510,702 are arable, 45,501 uncultivated, 14,325 in plantations, 2392 in towns, and 3668 under water. Pop. (1871) 132,666, of whom 120,356 were Catholics, 11,296 Episcopalians, and the rest Protestants of other denominations. The coast-line of W., which extends from Kilmichael Point to the estuary of the Suir, Waterford Harbour, is irregular, and very dangerous for shipping. From the above-named Point to Wexford Harbour there is no opening for navigation; and as Wexford Harbour, besides being intricate and dangerous, is also

obstructed by a bar, it offers little security in boisterous weather; but considerable improvements have lately been made. The coast from the southern headland of Wexford Harbour, Rosslare Point, to the mouth of the Suir, presents a succession of bays and headlands. The headland called Carnsore Point is the south-eastern extremity of Ireland. Parallel with the northern coast-line, at a distance of a few miles, is a range of sandbanks; and the southern shores are beset by outlying rocks and islets, which, although somewhat guarded by light-houses and light-ships, frequently prove fatal to shipping. The greater part of the surface is tolerably level, but some detached hills rise to considerable elevation. The mountains of the border are much more elevated, the highest point of the Blackstairs being 2409 feet; and of Mount Leinster, 2610. There are few lakes, and these of small size. The principal river is the Slaney, which for some distance is the boundary between W. and Carlow, but enters W. near Newtownbarry, whence it flows by Enniscorthy into the sea in Wexford Harbour. In its geological structure, W. belongs to the eastern clay-slate tract, which stretches in a south-westerly direction from the north of Wicklow to the Atlantic, and which extends across the level districts as far as the granite range separating W. from Carlow. Granite is found in the south-east of the county, and in some of the detached hills, as are also beds of greenstone. Silver was formerly raised near a place called Clonmines, where traces of an ancient mine are still seen, and galena has been found in the same place. Copper ore is found at a place called Kerlogue, near W., and plumbago and asbestos near Enniscorthy. The climate is said to be singularly temperate, and the district is more suitable for agriculture than the counties of Carlow and Kilkenny, although inferior in fertility. The total acreage under crops in 1875 was 228,916; of which 10,186 was under wheat; 50,165 oats; 53,313 barley; 3302 beans and peas; 25,031 potatoes; 18,782 turnips; 61,649 meadow and clover, and the rest minor crops; only 2 acres being under flax. The annual value of property in W., under the Valuation Act, is £374,671. There are but few and inconsiderable manufactures, and the trade is chiefly in the export of agricultural produce, especially barley; butter, cattle, pigs, poultry, and eggs are also exported in large quantities. The pupils at the national schools in 1875 numbered 16,754. W. is divided into ten baronies. Of these the barony of Forth is very remarkable as having preserved, from the 12th c. down to the very last generation, a dialect of English quite peculiar, as well as many peculiar usages and social habits. The principal towns are Wexford (q. v.), Enniscorthy, New Ross, and Gorey; Newtownbarry and Taghmon have each a population of about 1000; and Duncannon is noticeable for its ancient fort and interesting historical associations. The maritime position of W. laid it open early to the incursions of the Danes, to whom the name Wexford, or Weisford, is traced by antiquaries. It was the first landing-place of the English in the invasion, and formed part of the tract granted to them by MacMurrough. By the marriage of Strongbow with Eva, MacMurrough's daughter, it came into his hands; and after the partition of his lands among his daughters at his death, W. underwent many changes of masters. During the civil wars which followed 1641, W. was the scene of frequent contests; and in the more recent insurrection of 1798, it formed the theatre of the only formidable conflicts of the peasantry with the regular troops. There are numerous relics of antiquity, Celtic as well as Anglo-Norman, in almost every part of the county. Upwards of a hundred castles are still traceable, and many ecclesiastical



remains, of which the monasteries of Dunbrody, Tintern, Ross, and some others are not unworthy of the best days of medieval architecture. W. returns four members to parliament, two for the county, one for the borough of Wexford, and one for that of New Ross.

WEXFORD, capital of the county of that name, a seaport, and parliamentary and municipal burgh, is situated at the mouth of the river Slaney, 74 miles south from Dublin, with which it communicates by the Wicklow, Wexford, and Waterford Railway, now completed. The pop. in 1871 was 12,077, of whom 11,196 were Roman Catholics, 717 Protestant Episcopalians, and the rest Protestants of other denominations. The town is situated on the south-western shore of the estuary of the Slaney, which is known as Wexford Harbour, and along which the quay extends nearly 1000 yards, forming a spacious and not inelegant terrace. Behind this, the town extends in two nearly parallel streets. There are two Protestant, and three Catholic churches. Of the latter, two are modern and handsome structures. One of the former, St Selsker's, is ancient, part of its walls dating from the English invasion. There are also a Presbyterian, a Methodist, and a Quaker meeting-house; a convent of Franciscan Friars, 5 nunneries, a Roman Catholic college, and National, Christian Brothers', and conventual schools. Besides the union workhouse, there are also an infirmary and a fever hospital. The only manufactures of any importance pursued are those of distillation and the grinding of corn; the chief industry of the town being in connection with the export trade of the county, already described. The position of W. for export trade, favourable in itself, is much marred by the shallowness and intricate character of the channel of the Slaney, which has the further disadvantage of being obstructed by a bar. Great improvements have been made, a patent slip and dock have been constructed, steamers are employed in the export of cattle and provisions, and an active shipping-trade is carried on. The W. fisheries also have long been reckoned among the most valuable on the eastern coast. The town is extremely ancient, and was occupied by the Danes as one of their strongest settlements. From the time of the invasion, it became an English stronghold against the native population. During the civil wars of 1641, it was occupied by the confederated Catholics, but was taken by Cromwell in 1644. The insurgents of 1798 also had possession of it for a short time. W. returns one member to the imperial parliament. In 1875, 703 vessels, of 66,696 tons, entered, and 268, of 34,376 tons, cleared the port.

WEYMOUTH, a township of Massachusetts, U.S., on Boston Harbour, twelve miles south-south-east of Boston, on South Shore Railway, containing the four post-villages of Weymouth, East Weymouth, North Weymouth, and South Weymouth, with large factories of nails, boots and shoes, &c. Pop. in 1875, 9819.

WEYMOUTH-AND-MELCOMBE-REGIS, a seaport, a fashionable watering-place, and a municipal and parliamentary borough of Dorsetshire, on a bend of the coast facing the south-east, and at the mouth of the river Wey, three miles north of the isle of Portland, and eight miles south of Dorchester by railway, seven in a straight line. A projecting point, called the Nothe, separates the two quarters—the old town of Weymouth lying to the south of it, the modern town, Melcombe-Regis, extending to the north, and facing the sea. The two quarters communicate by means of a bridge with a swing in the middle, to permit the passage of ships. The old town is uninteresting in appear-

ance; Melcombe-Regis, elegantly built, stands on a narrow peninsula, with the sea on the east, and an estuary on the west side. Its chief features are the sea-terrace and esplanade, the latter adorned with a statue of George III., who largely patronised Melcombe. The harbour has fourteen feet of water at full tide, and in the bay there is good anchorage in seven or eight fathoms. Portland Harbour, just recently completed, will be a source of great trade to the town. W.-and-M. is the seat of steam-traffic to the Channel Islands. Ship-building, rope and sail making, and the export of Portland stone and Roman cement, employ the great mass of the inhabitants. The town is connected with the Great Western and London and South-western Railways, and one connecting it with Portland Isle was opened in 1865. Pop. (1871) 13,259.

WHALE, the popular name of the larger cetaceans, particularly of all those belonging to the families *Balenida* and *Physeterida* or *Catodontida*. The latter family has already been noticed in the article CACHOLOP, and some of the species of *Delphinida*, also sometimes called whales, have been described in separate articles, as the CAALING WHALE and the BELUGA. The *Balenida* alone remain to be described now. In this family, the head is of enormous size, as in the *Catodontida*, but is



Jaws of Greenland Whale, shewing the Baleen.

entirely destitute of teeth, instead of which, the palate is furnished with an apparatus of baleen, or whalebone, for the purpose of straining out of the water the small crustaceans and scalepha, which form the food of these whales. Rudiments of teeth,

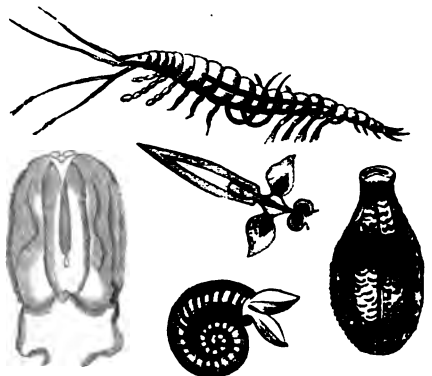

Food of the Whale, consisting of minute shrimp, sea-snails, medusae, &c.

however—dental pulps—appear in the fetus of the whale—sixty or seventy on each side of each jaw; but they are re-absorbed into the system, and the plates of whalebone are not produced from them, but from the integuments.

The fibrous structure of baleen, or whalebone, its elasticity, and its heaviness, are well known. The

## WHALE.

plates of it in the mouth of a W. are very numerous, several hundreds on each side of the mouth, and they are very closely placed together, so that the mouth is filled with them; the whole quantity in the mouth of a large W. sometimes amounting to nearly two tons in weight. They are suspended from the roof of the mouth; none proceed from the lower jaw. They extend on each side from the middle line of the palate, like the barbs of a feather; those in the middle of the mouth are longest. The base of each plate is embedded in the substance of the membrane that covers the palate, whilst its edge forms a loose fringe, composed of fibres or plant bristles. The vast mouth being opened, water is taken in; and the small animals which enter with it being retained for food, the water is allowed to escape by the sides of the mouth.

The tongue is a soft thick mass, not extending beyond the back of the mouth. The gullet of whales is very narrow; it is said not to be more than an inch and a half in diameter even in a large W., so that only very small animals can pass through it.—The head of whales occupies from a third to a fourth of the whole length. The skull is unsymmetrical, the right side being larger than the left. The flesh is red, firm, and coarse. The skin is naked, with the exception of a few bristles about the jaws, and its surface is moistened by an oily fluid. The lower surface of the true skin extends into a thick layer of *blubber*, an open network of fibres in which fat is held. The blubber is from a foot to two feet in thickness, the whole mass in a large W. sometimes weighing more than thirty tons, and serves the purpose of keeping the animal warm, as well as of making the specific gravity of the whole body much lighter than it would otherwise be, and of resisting the pressure of the water in the great depths to which it often descends.

The skin of whales is always infested with parasites; molluscs adhere to it; certain kinds of cirrhopods burrow and live in it; and crustaceans, such as the Whale-louse (q. v.) attach themselves to it, and feed upon it.

It has been attempted to calculate the age of whales from the transverse lines on the plates of baleen, and in this way it has been computed that they attain the age of 800 or 900 years, each transverse line being assumed to indicate an annual check of growth; but it is evident that there is no good ground for the assumption on which such calculation proceeds.

In the genus *Balæna* there is no dorsal fin, nor elevation of the back corresponding to it, as in some of the family. The belly is smooth, not plaited, as in the other genera of the family. The most important species, and indeed the most important of all the whales, is that known as the RIGHT W., or GREENLAND W. (*B. mysticetus*). It inhabits the seas of the northern parts of the world, and abounds chiefly in the arctic regions. It is sometimes seen on the coasts of Britain, and even in more southern latitudes. It attains a size of sixty or seventy feet in length. The body is thickest a little behind the *flippers*, or pectoral fins, tapering conically towards the tail, and slightly towards the head. The tail is five or six feet long, and from twenty to twenty-five feet broad; formed of two diverging lobes, broadest almost where they are united, but with a slight indentation. The pectoral fins are eight or nine feet long, and four or five feet broad. The mouth is fifteen or sixteen feet long. The eyes, which are situated on the sides of the head, about a foot above and rather behind the angles of the mouth, are not larger than those of an ox; but the sense of sight seems to be acute, at least in the water. The iris is white. The blow-holes are situated on the most

elevated part of the head; they are from eight to twelve inches long, but of comparatively small breadth. The upper parts are velvety black, the lower parts white. The upper parts, in very old whales, sometimes become piebald, the black being mixed with white and gray. The period of gestation is uncertain; one young one is produced at a birth, and is from ten to fourteen feet in length when born. The mother displays great affection for her offspring, of which whale-fishers sometimes take undue advantage, harpooning the young one—itsself of little value—in order to secure the mother. Suckling is performed at the surface of the water, and the mother rolls from side to side, that she and the young one may be able to breathe in turn. The usual rate of progress in swimming is about four or five miles an hour, and whales often swim not far beneath the surface of the water, with the mouth wide open to take in water from which to sift food.

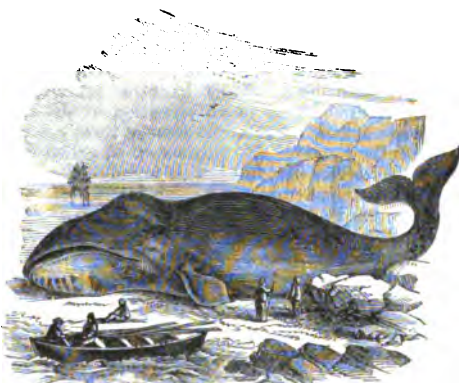

Greenland or Right Whale (*Balæna mysticetus*).

The W. is capable, however, of swimming with much greater rapidity, and when harpooned, it often descends to a great depth in a few seconds. Its tail is extremely powerful, and a single blow of it is sufficient to destroy a large boat, or toss it and its crew into the air, so that the whale-fishery is attended with no little danger. Whales usually come to the surface to breathe at intervals of eight or ten minutes, but they are capable of remaining under water for half an hour or more. When they come up to breathe, they generally remain on the surface about two minutes, during which they blow eight or nine times, and then descend. The noise which they make in blowing is very loud, and the spout of spray ejected ascends several yards into the air, appearing at a distance like a puff of smoke. They often assume, as if in sport, a vertical position, with the head down, and flap the surface of the water with the tail, making a sound which is heard two or three miles off. The Greenland W. is not properly gregarious, being generally found alone or in pairs, except when numbers are attracted to particular feeding-grounds, as is sometimes the case in the bays and inlets of northern coasts.

It was formerly supposed that the Greenland W. was an inhabitant of the southern as well as of the northern parts of the world; but the SOUTHERN or CAPE W. (*B. australis*) is now regarded as a distinct species, the head being smaller in proportion than that of its northern congener, and the colour a uniform black. It attains the length of 50 or 60 feet. It is usually found in comparatively shallow water near coasts. It occurs not only in the colder parts of the southern hemisphere, but throughout

its temperate regions, and its range extends into the tropics. It has been taken even as far north as Japan. Its capture is prosecuted to a considerable extent, particularly on the coasts of South Africa and New Zealand, although this whale-fishery is not nearly so important as that of the northern seas. Several other species of *Balæna* have been described, but they are imperfectly ascertained and characterised, specimens not often coming under the observation of competent naturalists in a perfect state. The *Nordkaper* of the Icelanders has by some naturalists been described as a distinct species, although it is more generally regarded as a variety of *B. mysticetus*. It differs, however, from the common variety in having the body more slender and the head proportionally smaller; the under jaw very round, deep and broad; and the plates of baleen comparatively short. It is of a gray colour; the lower part of the head of a brilliant white. It is said to be more active and more fierce than the Common W., so that its capture is attended with greater danger.

The species of the genus *Megaptera* are called HUMP-BACKED WHALES, and by whale-fishers ordinarily *Hump-backs*. They have a rudimentary dorsal fin, in the form of an elevation of the back. There are several species, but some of them are very imperfectly known. *M. longimana*, so called from the length of the pectoral fins, is found in the North Sea, and is included in the British fauna. *M. Americana*, the BERMUDA HUMP-BACKED W., occurs chiefly about the Bermudas, from which its baleen is extensively imported. Another species, *M. Paskop*, occurs at the Cape of Good Hope.

The genus *Balænoptera*, *Physalus*, or *Rorqualus* is distinguished by having a dorsal fin. See RORQUAL.

All the species of these genera are objects of pursuit to whale-fishers, although the Greenland W. is that which they prefer.

Important as the W. is to civilised man, both for the oil and the whalebone which it yields, it is still more important to the rude natives of arctic regions, as the Esquimaux and Greenlanders, who use its oil for food as well as for burning, and to whom its flesh also is a chief article of food; while its bones and baleen are used for making tents, sledges, boats, harpoons, and spears; the sinews supply a substitute for twine or thread; and the membranes are used instead of glass for windows. There is no essential difference in the way in which the capture of whales is prosecuted by the rudest tribes and the most civilised nations. The whale-fishers approach the whale in boats, and attack it by harpoons to which lines are affixed, following up and repeating the attack, until its strength is exhausted, taking advantage of the necessity which it experiences of coming at intervals to the surface to breathe, and finally killing it with lances, which are thrust into the most vital parts.

In its most simple form, the harpoon is an iron spear about 5 feet in length, with a much flattened point, having sharp cutting edges, and two large

weapon with all his force into the animal's side. In its fleeing from the attack, the line is rapidly drawn out of the boat, until the creature is tired, and rises to the surface for air. The boat follows, keeping as much of the line as possible, until, exhausted by pain and loss of blood, the animal succumbs. It will be seen that much depends upon the sharpness of the blade-like edges of the barbs, and their power to hold when in; hence many ingenious devices of movable barbs have been contrived, which close on the shaft of the instrument in going into the animal's flesh, but open outwards as soon as there is any strain on the shaft. The gun-harpoon is a short bar of iron with the barbed spear at the end, and a ring with chain for the attachment of the line; this is fired from a small swivel cannon attached to the whaler's boat. However well the harpoon may be fixed in the animal's body, its death and capture are still very difficult matters to accomplish, and take much time. To obviate this, a very ingenious expedient was suggested by Dr Christison, the eminent toxicologist of Edinburgh University, that glass tubes containing prussic acid should be so placed in the shaft of the harpoon, that the moment the cord or line was pulled tight, they would be broken in the animal's body, and occasion instant death. This plan has been tried with great success, but has met with opposition from the whale-fishers, who have a prejudice against using a poison which they see has such deadly effects. Another mode of employing prussic acid is to enclose a glass tube containing it, in a hollow rifle bullet about four inches long, which is fired from a rifle made for the purpose, the bullet containing also an explosive substance connected with a fuse, which is kindled as the rifle is fired, so that the bullet bursts immediately after penetrating the whale, and spreads its deadly contents through the flesh. The bullet is made of zinc, because it breaks into fragments more angular than any other metal. The success of this method has been found to be perfect, but sailors object to its use, dreading to touch the carcass of a whale which has been killed by so powerful a poison, for a whale struck by a bullet charged with prussic acid only disappears for about five minutes, and rises to the surface dead. Strychnia has been used instead of prussic acid, and with similar results.

The lance used for killing the W. has generally a blade 5 or 6 inches long, and 2½ or 3 inches broad, with sharp cutting edges, and a long wooden handle.

The ships fitted out for the northern whale-fishery are generally screw-steamers, of from 400 to 600 tons burden. To protect them from injury by ice, they are fortified with an additional series of planks, iron plates, and a false or ice stem, on the sides of which are *ice-knees*—angular blocks of wood filling up the concavity formed by the stem and fore-planks. The stern is also defended by *ice-plates* of half-inch iron; and many timbers and stanchions are added in the interior of the vessel, great strength being a more important requisite than fast sailing. Each ship has generally six or seven boats, *carvel-built*, from 23 to 28 feet in length, each capable of carrying 6 or 7 men, with 7 or 8 cwt. of whale-lines, &c. The crew of a whaler consists of 40 or 50 men, each of whom, from the master to the boys, generally receives, in addition to his fixed wage, a gratuity for every W. caught, and a certain sum for every tun of oil produced by the cargo. Each boat carries 2 harpoons and 6 or 8 lances. When the ship arrives in the vicinity of a whaling-ground, a look-out is stationed at the mast-head. As soon as a W. is discovered, the boats are lowered, and a competition ensues among their



Harpoon.

flattened barbs. Many modifications have been made, the most important perhaps being the gun-harpoon. The ordinary harpoons are attached to a long line at the opposite end to the barbed point, and when the boat is near enough to the W., the man whose duty it is darts or plunges the

## WHALE.

crews, all exerting their utmost strength to reach the W. first. The harpooner is ready, as soon as the boat is sufficiently near the W., to hurl his harpoon with all his force; the crew instantly back the boat, and the W. generally plunges in terror to a great depth, sometimes carrying out more than 200 fathoms of line. It remains below for 20 minutes or more, and when it rises, the boats hasten to it again; it is struck with a second harpoon, and probably, instead of at once descending, it strikes violently with its tail, to destroy its enemies, when great caution is requisite. It cannot now remain long below the surface, and when it comes up, probably sprouts blood through the blowholes. When it is lanced, it sometimes dies almost at once, but sometimes there is a terrific struggle—the water is lashed into foam, and dyed with blood. It not unfrequently happens, that instead of dying at the surface of the water, the W. descends, and does not rise again, so that it is lost to the whaler. The carcass of the W. is towed by the boats to the ship, and made fast to the ship's chains. The process of *flensing* is then commenced. Some of the crew, having their boots armed with iron spikes, to prevent them from slipping, descend upon the carcass, and cut into the blubber with *blubber-spades*, removing a broad strip or *blanket* of skin, 20 or 30 feet long, which is hoisted to the deck by means of a hook and tackle. Great cubical pieces of blubber, of half a ton or a ton in weight, are then cut out, and hoisted on deck. In this way, the process is carried on, the W. being turned over and over, that every part may be reached; till, in three or four hours, the whole mass of blubber is removed from it—probably amounting to 20 or 30 tons. Meanwhile, others of the crew have descended into the mouth of the W., and removed the baleen. The remainder of the carcass is then flung adrift, and sometimes sinks, but often swims, in consequence of incipient putrefaction, to afford food for bears and fishes. The blubber, after being received on deck, is cut into smaller cubical pieces, and subjected at leisure to a process by which the cellular tissue is separated from it. This is called *making-off* or *trying-out*; and to accomplish it, the blubber is heated in a large pot, and afterwards strained, the scraps or cracknels from one pot serving as fuel for another, and the ship being made filthy with smoke, soot, and grease. The product is finally stored in casks, to be conveyed home, and boiled for oil. A ton of blubber yields nearly 200 gallons of oil. A single W. often yields blubber and whalebone to the value of £700 or £800. The whalebone is subjected to no process but that of drying till it is brought home.

Ships often return from the whale-fishery *clean*—i. e. without having captured a single whale. The greatest number of whales known to have ever been captured by a single vessel in a season is 44; yielding 299 tons of oil, of 252 gallons each. This was in 1814; the fortunate whaler belonged to Peterhead, in Scotland, and the oil alone, according to the price of that year, £32 per tun, was worth £9568. When the price of oil and whalebone has been higher, even greater profits have been realised by whalers making fewer captures.

It is usual for whalers to resort to the arctic whale-fishery in spring, and to return in autumn; but Captain Penny adopted with great success, in 1853—1854, the method of wintering in the arctic regions.

The Norwegians sent vessels to Greenland for the whale-fishery in the 9th century. They had previously prosecuted it on their own coasts, and the Norman settlers on the Bay of Biscay carried it on there, whales inhabiting that bay in considerable numbers, till, through the eager prosecution of the

fishery, they became so few that about the 15th c. it became unprofitable, and was relinquished. In 1261, a tithe was laid upon the tongues of whales brought into Bayonne, they being then highly esteemed for food. The French, Spaniards, and Flemings early began to fit out vessels for the northern whale-fishery; the English entered upon it with great spirit in the end of the 16th c., and about the same time the Dutch, Danes, and Hamburgers. The British Muscovy Company obtained a royal charter, giving them a monopoly of the whale-fishery of the coasts of Spitzbergen, on the pretence of its having been discovered by Sir Hugh Willoughby, although, in fact, it was discovered by the Dutch navigator Barentz. Other nations were not disposed to acknowledge the claims of the English; the Dutch in particular sent out a strong fleet, between which and the ships of the Muscovy Company an engagement took place in 1618, and the English were defeated. The Spitzbergen bays and seas were afterwards divided into fishing-stations, allocated to the whalers of the rival nations. No nation now asserts a claim to the exclusive right of whale-fishing in any quarter. The Spitzbergen fishery was thrown open to all nations in 1642.

The English for some time prosecuted the whale-fishery sluggishly and with incompetent means; the Dutch carried it on with great vigour and success. During the latter half of the 17th c., the Dutch furnished almost all Europe with oil. In 1690, they had 260 ships and about 14,000 men employed in the whale-fishery; but from that time the Dutch fishery began to decline. In 1732, Great Britain attempted to encourage the whale-fishery by a bounty of 30s. a ton to every ship of 200 tons engaged in it, which was raised in 1749 to 40s., reduced to 30s. in 1777, and again raised to 40s. in 1781. The object of the bounty was not only to encourage the trade, but to make it a nursery for seamen. Ships, however, were fitted out rather for the bounty than for the capture of whales, and during the next five years after the reduction of the bounty in 1777, the number of ships employed in the trade was reduced from 105 to 39. After 1781, it rapidly increased, and continued to increase although the bounty was reduced. The bounty was finally altogether withdrawn in 1824; yet in 1815, when the British whale-fishery was in its most flourishing condition, only 164 ships were engaged in it. The Dutch whale-fishery had in the meantime almost entirely ceased, owing to the national calamities consequent on the French Revolution. The British whale-fishery is still prosecuted, although not nearly to the extent that it was fifty years ago. The French whale-fishery has in like manner declined. The Americans are at present more actively engaged in the whale-fishery than any other nation. The New England colonies entered upon this enterprise at a very early period, at first merely by boats on their own coasts, which, however, were deserted by whales before the middle of the 18th c., and ships then began to be fitted out for the northern seas. For a number of years, however, the American whale-fishery also has been declining, owing to the scarcity of whales, and because substitutes for whale-oil and whalebone have been found.

Of all British towns, Peterhead and Dundee are those which of late have shewn the greatest enterprise in the whale-fishery, and next to them is Hull. In America, New Bedford demands special notice. It is at present the greatest whaling-port in the world.

The ships engaged in the whale-fishery generally add to their cargoes of oil by the capture of seals.

WHALES, in point of law, belong to the crown, according to the law of England, if they are caught

or found within the territorial sea—that is, within the limit of three miles from the shore; or in the inner seas, as distinguished from the open sea. This is contrary to the general rule—that he who first captures a wild animal is entitled to the property thereof. Whales are thus called royal fish; and it is said sturgeons and porpoises also fall under the same class. If the whales are not caught in the territorial seas, which are part of the realm, but in the open sea, then the law of nature applies, or rather a secondary law or custom governs the right of property, and that law, though varying slightly according to locality, is, that the person who first captures the whale is entitled to keep it. In the Greenland seas, the local custom is that the first harpooner who strikes the whale is entitled to the property only if he continues to hold the whale by the line attached to his harpoon; but if his line break, and a subsequent harpooner from another ship finish the capture by obtaining possession, then the latter is entitled, for it is a loose fish. This rule, however, has been qualified in this way, that the first harpooner who strikes the fish and keeps it entangled is entitled, even though a volunteer come up and officiously strike the fish, thereby causing it to struggle and break from the first line. At Gallipagos, South America, the custom is that he who first strikes the whale with a drong, or loose harpoon, is entitled to receive half of it. The same rules govern the right of property in whales when similar questions arise between parties litigating in Scotland. The law of Scotland, as well as England, adopts whatever local custom prevails where the whale was captured.

**WHALEBONE.** The baleen plates which take the place of teeth in the mouths of the Baleen Whales (see **WHALE**), constitute the whalebone of commerce. They vary in length from a few inches up to ten, and even in rare instances to twelve feet. Their chemical constitution is albumen hardened by a small proportion of phosphate of lime. Their colour is usually of a bluish black, but in some species they are striped longitudinally with bands of a whitish colour; and they terminate at the point in a number of coarse black fibres of the baleen, which fibres are also found more or less down both sides of the blade. These fibres are much used by brushmakers. There are three principal kinds in the market, and they are generally known as *whale-fins*. The first is the *Greenland*, or *Davis' Strait* and *North Sea* fins; second, the *South Sea*, or *black fish-fins*; third, the *North-west coast*, or *American whale fins*. Whalebone requires some preparation before being fit for use; this, however, is very simple. It is first trimmed—that is, all the hairs are removed from the point and edges of each blade; and generally the surface of each flat side is scraped. The blades are then boiled in water for several hours, until they become soft enough to be cut easily with a common knife. The workman then cuts them into lengths fitted for the purposes to which they are to be applied. They are chiefly used in thin strips, such as stay-bones and umbrella-ribs, and can be easily split for such purposes, owing to their lamellar structure. Generally, the boiling is combined with a dyeing process, to make the whalebone perfectly black, which is preferred to the not agreeable natural colour. The quantity annually imported into Britain rarely exceeds 150 tons; but as the price ranges from £350 to £500 per ton, that represents a large value.—Strips of rattan canes dyed black are used as a cheap kind of artificial whalebone, but the best imitation is made of vulcanite or prepared caoutchouc, which in many respects is superior to the real whalebone.

**WHALE-LOUSE** (*Cyamus*), a genus of Crustacea, of the order *Leuodipoda*, having the body short and rather broad; the legs short and stout; seven pair of legs; the first pair more slender than the rest; the first, second, fifth, sixth, and seventh pair furnished with sharp hooked claws, the third and fourth not terminating in claws, but in a long almost cylindrical joint. All the species are parasitic on Cetacea, attaching themselves to the skin by means of their claws. Whales are sometimes so completely covered with



Whale-louse.

them, as to appear of a whitish colour even at a distance; and when the whale is captured, its skin is found to be deprived of the epidermis. *Cyamus Ceti* is said also to infest the mackerel and other fishes of the family *Scomberida*.

**WHANG-HAI**, or **YELLOW SEA**, an important inlet of the Pacific Ocean, washes the north part of the east coast of China, and is bounded on the W. by the Chinese provinces of Shang-tung and Keang-su, and on the E. by the peninsula of the Corea and Japan. It terminates on the north-west in the Gulfs of Pe-chih-li and Leao-tong, and opens out in the south-east into the Tung-hai, or Eastern Sea. It is more than 600 miles long, and over 400 miles in average breadth. The W. is shallow, and near the land its waters are of a lemon colour, owing to the nature of the bottom, which is often furrowed by vessels navigating it. By degrees, it is becoming more and more shallow, owing to the quantity of alluvium borne down into it by the rivers Hwang-ho (q. v.) and Yang-tze (q. v.).

**WHARNCLIFFE MEETING.** By a standing order of the House of Lords, which was proposed by Lord Wharnccliffe, and is still known by the title of the 'Wharnccliffe Order,' no bill to empower any company already constituted by act of parliament to execute, undertake, or contribute towards any work other than that for which such company was originally established, or to sell, lease, or abandon its undertaking, or any part thereof, or to amalgamate with any other undertaking, or to dissolve, is allowed to proceed in the House of Lords until it is reported that such bill has been submitted to a special meeting of the proprietors of the company, convened by public advertisement, and by circular addressed to each proprietor; that such meeting was held not earlier than seven days after the last insertion of such advertisement; and that at such meeting the bill was submitted to the proprietors present, and approved of by proprietors present, in person or by proxy, holding at least three-fourths of the paid-up capital of the company represented at such meeting. Of late years, a number of bills are in each session originated in the House of Lords; and since the introduction of this practice, the meetings held in conformity with this order are popularly known as 'Wharnccliffe Meetings.' The House of Commons has adopted a corresponding standing order applicable to such bills coming from the Lords.

**WHARTON, PHILIP** **WHARTON, DUKE OF**, was the son of Thomas, Marquis of Wharton, an eminent member of the Whig party in Queen Anne's reign, and Lord-Lieutenant of Ireland from 1708 until after the fall of the Godolphin administration in 1710. Macaulay says he was licentious and corrupt; but the faults of his Irish administration

were largely redeemed by his appointment of Addison as Chief-secretary. George I. made him Lord Privy Seal and Marquis of W. in 1715, but he died three months afterwards. His son, Philip, born 1693, was educated at home by his father, who aimed at making him a great orator, a Whig in politics, and a Presbyterian in religion. In a boyish freak, he contracted a clandestine marriage at the Fleet with the daughter of Major-general Holmes. The shock is said to have killed both his parents. W. soon parted from his wife, and in 1716 went abroad with a French Huguenot tutor, to be brought up according to his father's dying instructions, in strict Presbyterian principles, at Geneva. He contracted debts, spurned the restraints of his tutor, and ran away to Lyon. He visited the Pretender at Avignon, and, it is said, accepted from him the title of Duke of Northumberland. He next visited Paris, and after various extravagances, set out for Ireland, where, although he had not yet reached his 19th year, he was allowed to take his seat in the House of Peers. He soon displayed such splendid abilities in debate, and supported the government with so much zeal, that although still under age, he was, January 20, 1718, raised to the highest rank in the English peerage. He did not take his seat in the English House of Peers until 1720. Here he opposed with much warmth the government measure on the South Sea Bill, and the bill of pains and penalties against Bishop Atterbury. His affairs became hopelessly involved by his extravagance, so that although he had succeeded to an estate of £16,000 a year, he was soon compelled to accept a yearly allowance of £1200 from his creditors. He set up a political paper, called the *True Briton*, in 1723; and lost no occasion of speaking, as well as writing, against the ministry and the court. In 1724, he set out for Vienna, and then visited Madrid, where he was served with an order from the Privy Seal to return home. He treated the order with contempt, and afterwards went to Rome, and appeared openly at the court of the Pretender, from whom he accepted the Order of the Garter. He now assumed the title of Duke of Northumberland. In 1727, he fought with the Spaniards and against his countrymen at the siege of Gibraltar. This last mad act lost him his English title and estates, and led to his conviction under a bill of indictment for high treason. He refused to make his submission to the government; and the rest of his life was passed in France and Spain, at one moment squandering his precarious supplies of money in drunkenness and luxury, and at another suffering the extremest poverty. He died in a miserable condition at a Bernardine convent in Catalonia, May 31, 1731. His brilliant talents and wasted life were sketched by Pope in his *Moral Essays*, in the lines beginning—

Wharton, the scorn and wonder of our days.

The *Life and Writings of Philip, late Duke of Wharton*, were published in 1732 (Lond. 2 vols. 8vo); and another two-volume publication, entitled *The Poetical Works of Philip, late Duke of Wharton, and of the Duke's Intimate Acquaintance*, appears, with the exception of the title-page and a prefixed biography of W., to have been printed in 1727. This publication, however, contains little that is even attributed to the duke.

WHATELY, RICHARD, Archbishop of Dublin, was born in Cavendish Square, London, 1st February 1787, and was the fourth son of Dr Joseph Whately of Nonsuch Park, Surrey, Prebendary of Bristol, Vicar of Wiford, and lecturer at Gresham College. He was sent in due time to a private school at Bristol, from which, in 1805, he passed to Oriel

College, Oxford. He took his Bachelor's degree in 1808, taking a second class both in classics and in mathematics. He got the English-essay prize in 1810. In the following year, he was elected a Fellow of Oriel College, which at that time ranked among its Fellows not a few men destined to play a considerable part in the world, and already remarkable for their attainments and intellectual activity—a. g., Arnold, Keble, Pusey, and the elder Newman. In 1815, he became one of the tutors of his college; and about this time he wrote (originally for the *Encyclopædia Metropolitana*) what he afterwards expanded into his popular treatises on Logic and Rhetoric. In 1821, he married a daughter of W. Pope, Esq., of Hillingdon, Middlesex. In the same year, he published two works; the one a volume of sermons on *The Christian's Duty with respect to the Established Government and the Laïcs*; the other a work which is among the most celebrated and characteristic of his writings: this was *Historic Doubts relative to Napoleon Bonaparte*. Its object was to throw ridicule upon the criticism to which the Gospel narratives were subjected by sceptical writers, by applying the same kind of criticism to events within the memory of all the world, and starting doubts as to whether these events had occurred. This *jeu d'esprit* with a purpose created a great sensation. It has been translated into several foreign languages. In 1822, W. was presented to the living of Halesworth, in Suffolk. In the same year, he delivered the Bampton Lectures at Oxford, taking for his subject the 'Use and Abuse of Party Feeling in Religion.' In 1825, he was appointed by Lord Granville Principal of St Alban's Hall, which, under his energetic rule, quickly lost the bad character it had long sustained in the university. In 1829, he was appointed Professor of Political Economy; but he was destined not to hold this office long enough to do more than deliver an introductory course of lectures. In 1831, Lord Grey's government, at the instance of Lord Brougham, appointed him Archbishop of Dublin and Bishop of Glendallagh. Afterwards, in 1846, his episcopal charge was enlarged by the addition of the bishopric of Kildare.

During the ten years preceding his appointment to the archbishopric, W. had incessantly been writing and publishing, chiefly upon theological and ecclesiastical subjects. He belonged to the Liberal school in religion and in politics; he was opposed, that is, to High Church or Catholic views in theology, and to Toryism in politics. He had taken a keen interest in the political questions of the time, and especially had made himself conspicuous in the university by his advocacy of Catholic emancipation, of which the party in the church which had most sympathy with the theology and ecclesiastical system of the Roman Church were the most determined opponents. When Sir R. Peel, after his change of views on the emancipation question, voluntarily submitted himself for reelection to the university, W., though a Liberal, came forward to support him, and was one of the most active of those who endeavoured to prevent his rejection. His *Essays on some of the Peculiarities of the Christian Religion* appeared in 1825; his *Elements of Logic*, in 1826; the *Elements of Rhetoric*, in 1828; his *Essays on some of the Difficulties in the Writings of St Paul, &c.*, also in 1828; his *Thoughts on the Sabbath*, in 1830; and in the same year, the *Errors of Romanism traced to their Origin in Human Nature*. His *Introductory Lectures on Political Economy* were published in 1831. By this time, his writings, and the great activity and ability which he displayed in his various public functions, had placed him among the foremost

men of the university, and had also got him rank among the most remarkable thinkers and writers of his time. Though many distrusted him as a Liberal, questioned the soundness of some parts of his theology, or thought his manners too eccentric, and his habit of mind too peculiar, for one who was to rule over others, nobody questioned that his abilities and reputation were equal to the high position bestowed upon him by Lord Grey.

As Archbishop of Dublin, W. was very active in all matters of importance, social and ecclesiastical, and shewed a deep interest in every question affecting the welfare of Ireland. He was one of the original members of the Board of National Education, and continued a member till 1853, when he retired, in consequence of a departure, as he thought, having been made from the principles on which, up to that time, the national education had been carried on. He was perhaps the most active member of the Board, and the success of the national system was in a great measure owing to him. He and members of his family were always foremost in supporting well-devised charitable schemes. His liberality was, in fact, unbounded, though an opposite impression prevailed among those who did not know him, because he wrote and spoke strongly against casual benevolence, and used to say he had never given a penny to a beggar. As archbishop, his rule was firm and judicious. A slight disregard of etiquette was about the worst thing ever alleged against him; he was not disposed to make much difference between a rector and his curate. His activity as an author was not stifled by his energetic discharge of his public duties; indeed, he seems to have been always either writing a book, or affording literary help to others. Besides many charges, sermons, and a few pamphlets, his *Kingdom of Christ Delineated*, one of the most remarkable of his works; his *Introductory Lectures to the Study of St Paul's Epistles*; his *English Synonyms*; and his annotated edition of Bacon's *Essays*—perhaps the best example of good editing in the English language—belong to this period of his life. A work, published anonymously in 1856, *Scripture Revelations respecting Good and Bad Angels*, has been generally ascribed to Whately.

He died on the 8th October 1863. The world's esteem and the regard of his friends for him had been growing to the last. In early life, there was much about him to shock the fastidious, and some things which might hurt the sensitive; but his peculiarities softened and wore off as he advanced in years. At Oxford, he was noted for his rough unceremonious manners, for which (together with his dress) he was nicknamed the White Bear; and for the plain speaking and rough ridicule with which he would overwhelm an opponent in an argument. He was remarkable, too, for his fondness for athletic sports, which he indulged with a perfect indifference to the minor proprieties. He used to say that his abrupt and careless and seemingly unfeeling ways were a recoil from the painful shyness for which he had been remarkable in his youth. Those who knew him, however, made light of his peculiarities; and few things about him are more pleasing than his firm belief in the merits of his friends, and the number, the warmth, and the permanence of his friendships. He had great talents for conversation, and was famous for his bon-mots, happy repartees, and conversational pleasantries of every kind. His writings are not so much remarkable for subtlety of thought or novelty of view as for strong logic, acuteness, felicity of arrangement and exposition, and the frequency and homely force of his illustrations. He had the happy power of building up materials which might be old into a new,

commodious, and almost a beautiful structure. He did nothing for mere ornament's sake: though his imagination was abundantly fertile, it was used only to illuminate his argument; his images are seldom impressive for their beauty, though admirably fitted for didactic purposes. His theological works have been charged with a 'cold rationalistic' tendency, and with being wanting in reverence; and it has been inferred, though perhaps too hastily, from some passages in his writings, that he was heretical on the subject of the Trinity. The *Historic Doubts*, the *Essays on the Peculiarities of the Christian Religion*, the *Errors of Romanism*, and the *Kingdom of Christ*, are perhaps the most valuable and characteristic of his writings.—The *Life and Correspondence of R. Whately, D.D., &c.*, by his daughter, E. Jane Whately, was published at London in 1866. It is an interesting, though in some respects a partial, and in some degree an inadequate, memorial of Dr Whately. As might be expected, the 'White Bear' side of his character is kept in the shade: but few examples are given of the coarse but racy conversational wit which was one of the Archbishop's claims to distinction among his contemporaries. And it is scarcely possible to gather from it what his exact position was in theology or in literature, though the letters, which form a great part of it, give a very fine impression of the qualities which distinguish his works.

WHEAT, the most valuable and, next to maize, the most productive of all the cereal grasses. The genus *Triticum*, of which the species are popularly known either as *Wheat* or *Wheat-grass*, is distinguished by a spike with many-flowered spikelets, without stalks, and seated one on each notch of the rachis, their sides directed to the rachis, which is zigzag; and two glumes, of which the lower is either awned or awnless; the outer palea of each floret having at the top a notch, in the centre of which is the terminal point, sometimes prolonged into an awn, or, in some species, with many florets tapering into an awn without a notch. A number of species are found in Britain, of which *T. repens*, well known as Couch Grass (q. v.), is the most common; but the seeds of none of them are of any value. The native country of the cultivated W. has generally been supposed to be the central part of Asia; but a discovery was made not many years ago by M. Fabre of Agde, in the south of France, that the *Ægilops ovata*, a grass of the regions near the Mediterranean, and of the west of Asia, becomes transformed by cultivation into wheat. The announcement of this discovery was at first received with much doubt, although the possibility of the transformation had been suggested by previous botanists; but it has been confirmed by subsequent observations and experiments. The genus *Ægilops*, as hitherto recognised by botanists, is distinguished from *Triticum* chiefly by its more numerous awns, the glumes of *Æ. ovata* being generally terminated by 3 or 4 awns, prolongations of their ribs, and the palea by 2 or 3 short awns. The awns of grasses, however, afford very uncertain characters, being extremely liable to disappear through change of circumstances; and among the cultivated varieties of W., every farmer is familiar with some that are awned or bearded, and some that are beardless, having scarcely a trace of awn. In the wild *Ægilops*, the ear is also much more easily broken from the rachis than in wheat. In cultivation, the *Æ. ovata* very soon loses the awns of its palea and of the lateral ribs of its glumes, and thus assumes the characters of W., the ears at the same time losing their fragility, the grain also increasing in size, whilst the floral envelopes are proportionally diminished, the leaves become larger, and the stem

## WHEAT.

stronger. From seeds of the *Æ. ovata* sown in a garden in 1838, M. Fabre obtained W. of fair quality in 1846. Professor Buckman, of the Royal Agricultural College, repeated the experiment in England. His first sowing was in 1855, and notwithstanding the disadvantages of cold seasons and a cold situation on the Cotswold Hills, he found the spikelets much modified in 1859, the warm summer of that year producing a greater change than had taken place in previous years (see *Popular Science Review* for October 1861). The annexed cut shows the natural state of a spikelet of *Æ. ovata* (fig. 1); the spikelet as modified by cultivation from 1855 to 1859 (fig. 2); and for comparison, an ear of ordinary bearded W. (fig. 3). The identity of the principal cultivated forms of *Triticum* with *Æ. ovata* may now be regarded as fully established. These forms have generally been included by botanists under the name *T. vulgare*.

W. has been cultivated from the earliest ages, and was a chief crop in ancient Egypt and Palestine, as it still is in all the temperate parts of Europe, Asia, and Africa. It is cultivated to a considerable extent in the north of India. In North America, it is very extensively cultivated, and many parts of the United States and British provinces are admirably adapted to it. Wide regions of South America are equally suitable, and W. of the finest quality is produced in Australia. In the torrid zone, W. does not succeed, except in elevated situations; but it nowhere succeeds better than in subtropical regions, although it is a hardy plant, and when covered by snow, endures even very severe winters in the north of Europe. For its successful cultivation, however, it requires a mean temperature of at least 55° F. for three or four months of the year. It is an annual plant, and its capacity of enduring the cold of winter is of importance only in connection with the advantage to be derived from sowing in autumn, so as to have it more forward in spring. Its cultivation does not extend so far north as that of barley or oats, or even of rye. In Europe, its northern limit is about lat. 60°. The quality of the grain varies much in different soils and climates, and particular varieties are also distinguished by difference of quality as well as by external characters. The W. of the eastern parts of Britain, where the climate is comparatively dry, is superior to that of the western parts, where the sky is more cloudy and the climate more humid, although the crops in the west are not less luxuriant; and the W. produced in Britain is not found suitable for the manufacture of macaroni, to which that of the countries near the Mediterranean is particularly adapted. Although hardy in winter and early spring, W. becomes more delicate and susceptible of climatic influences as it advances in growth; a prevalence of dry weather, with bright sunshine from the time when it comes into ear until it is ripe, is of the greatest importance.

COMMON W. (*T. vulgare, aestivum, or sativum*) grows to a height generally of 3 or 4 feet, and has ears or spikes generally 3 or 4 inches long; the spike 4-cornered, the spikelets about 4-flowered; the pales ventricose, ovate, truncate, mucronate or awned, compressed under the point, rounded at the back, the grain free. In consequence of long cultivation, in a great variety of climates, the cultivated varieties of W. are very numerous, more so than in

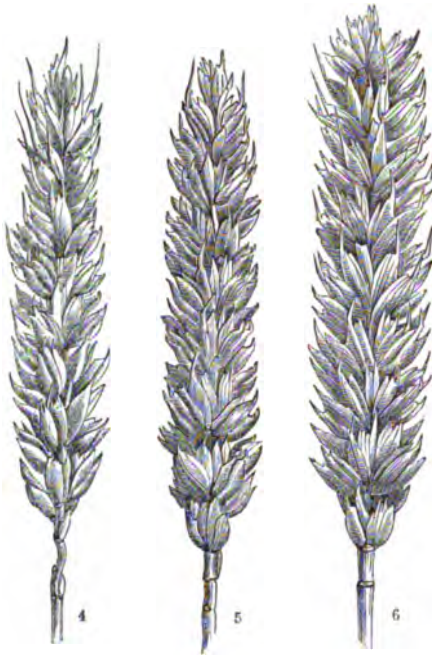

4, Chiddam Wheat; 5, Pearl Wheat; 6, Spalding's Prolific Red Wheat.

any other kind of grain. New varieties are continually coming into notice; and many are in high estimation in particular districts, although little known beyond them. Some botanists have attempted to distinguish species among them, appropriating the name *T. aestivum* to the awnless kinds, and *T. hybernium* to the awned; but intermediate forms are very numerous, and the length or shortness of the awn seems to depend upon accidental circumstances. Nor do the awnless or beardless kinds perfectly correspond with the Summer W. of farmers, preferred for sowing in spring with a view to a crop in the same season, and the awned or bearded kinds to the Winter W., sown in autumn, as some of the hardy varieties of Winter W. are awnless, and some of those usually sown in spring are bearded. Besides being classified as Bearded and Beardless, the varieties in cultivation are also distinguished according to the colour of the grain, as *White* and *Red* wheats. Some having the ears covered with a short soft down are known as *Woolly* wheats. There are also differences in the length and compactness of the spike, and in the size and form of the grain, which is more rounded in some, and more elongated in others. A number of varieties, having the spike very compact or square, have been sometimes classed together under the name of *T. compactum*, and the distinction is very obvious and permanent, although there is no reason for regarding it as characterising a distinct species. Akin to this



## WHEAT.

is the MUMMY W. (*T. compositum*), in which the spike is branched, and which is said, but on insufficient evidence, to have been produced from seeds found in mummy-cases in Egypt. Mummy W. has been grown in England, of which the ears have had 10 or 11 branches, and 150 grains have been found in one ear; whilst 60 ears have been produced by a single seed. Notwithstanding these apparent advantages, however, this variety does not serve the purposes of the farmer so well as some others. In

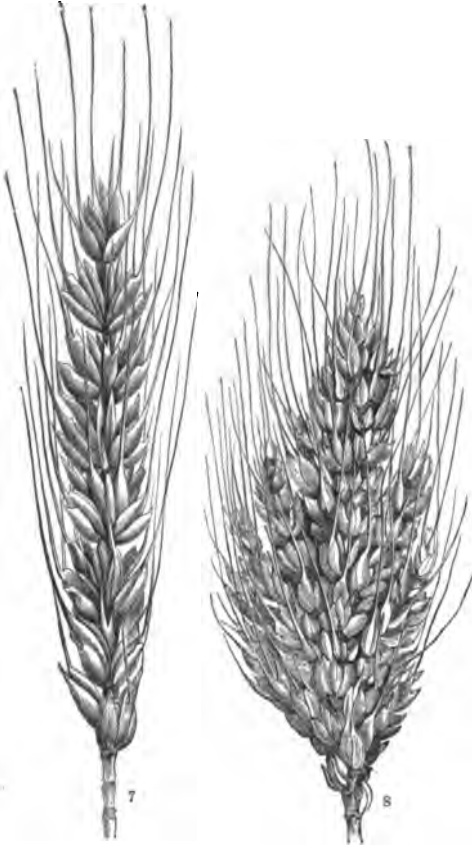

7, Fern Wheat; 8, Mummy Wheat.

another group of varieties with compact ears (*T. turgidum* of some botanists), the glumes are remarkably tumid, and always awned. These are known by the names of Gray W., Pollard W., Duckbill W., &c., and in Germany are commonly called English Wheat. Polonian W. (*T. Polonicum*) is the common name of a number of kinds of a very peculiar appearance, with a long, loose, and somewhat nodding spike; the glumes awned, and remarkably long—twice the length of the florets. The stems are also very tall, sometimes more than 6 feet high. These kinds, sometimes called *Grecian* or *MOGADORE W.*, are cultivated in some parts of the south of Europe, in the south of Siberia, and in Africa. **HARD W.**, or **HORNY W.** (*T. durum*), has rather small, elongated, and very hard grains, the paleæ have remarkably long awns, and the leaves are very broad. It is much cultivated in the countries near the Mediterranean, and Dr Royle suggests that it would be a valuable acquisition to India, as it yields a good crop on comparatively sterile soils.

The red varieties of W. are generally more hardy than the white; the grain is inferior in quality, and yields less flour, but these disadvantages are more than counterbalanced in many soils and situations by the greater productiveness of the crop. Red wheats are therefore preferred for comparatively poor soils, but the white kinds are generally cultivated wherever the soil and climate are suitable. The varieties with long straw yield the best crops in dry seasons, but the short-strawed kinds are best when the season is wet. W. is particularly suited to clay soils, and rich heavy loams; but with good farming, excellent crops are produced even on light sandy or gravelly, and on chalky soils. Where the climate is moist, a light dry soil is most suitable; soft deep soils being productive chiefly of straw. The land intended for W. must, at least in Britain, be in a high state of cultivation. W. is commonly sown after green crops, beans, or bare fallow; in the south of England, often after grass or clover. It may be sown, at least in autumn or the beginning of winter, when the ground is so saturated with moisture, that any other kind of grain would be almost sure to perish. It is either sown broadcast or in drills, and the practice of drilling becomes more and more prevalent, both on account of the saving of seed and the superiority of the crops produced. The land prepared for W. is very often manured with farm-yard manure; artificial manures—as guano—are also used. In Scotland, it is a common practice, when W. is to be grown after turnips, to plough down the turnip-leaves in autumn, before the W. is sown, and to apply guano in spring. Nitrate of soda is another favourite top-dressing for W., but sometimes causes the plants to grow too rapidly, so that they become tender, and suffer from climatic influences. Many farmers use both guano and nitrate of soda for top-dressing W., and the nitrate of soda is often mixed with common salt, which is thought to be useful in giving strength and vigour to the W. plants, preventing *lodging* and mildew. W. ought to be reaped before it is *dead ripe*, unless when it is intended for seed, and it ought to be stacked as soon as it is sufficiently dry to be free from danger of heating. On very rich land, W. sometimes becomes too luxuriant in spring, and its growth needs to be repressed by cutting the leaves with a scythe—a practice essentially agreeing with that mentioned by Virgil in his *Georgics* (i. 111), of allowing cattle to feed upon the young blades:

Quid, qui, ne gravidis procumbat culmus aristas,  
Luxuriam segetum tenerâ depascit in herba,  
Quum primum sulcos sequant sata?

The relative proportions of straw and grain differ very much in different varieties of W., and according to differences of soil, climate, and season. The proportion of the weight of grain to that of the whole plant when dried so as to be ready for stacking, varies from 20 to 47 per cent. The composition of the grain itself varies considerably, as to the proportions of starch, gluten, &c. which it contains. 100 parts of the grain of W., dried in the ordinary manner, contain on an average—water, 14·83; gluten, 19·64; albumen, 0·95; starch, 45·99; gum, 1·52; sugar, 1·50; oil, 0·87; vegetable fibre, 12·34; ash, 2·36: total, 100·00.

The ash is rich in phosphoric acid, magnesia, and potash. Its composition is as follows: Potash, 29·97; soda, 3·90; magnesia, 12·20; lime, 3·40; phosphoric acid, 46·00; sulphuric acid, 0·33; silica, 3·25; peroxide of iron, 0·79; chloride of sodium, 0·09: total, 100·00. For the processes by which starch and gluten are obtained from W., see these articles.

The value of W. depends mainly on the quantity

## WHEAT.

of fine flour which it yields; the best W. yielding 76—80 per cent., sometimes even 86 per cent. of fine flour, whereas inferior kinds seldom yield more than 68 per cent., and sometimes only 54—56 per cent. In general, the smoother and thinner the grain is in skin, the greater is the produce of fine flour. The greater part of the husk of W. is separated from the flour by the miller, and is known as *bran*. That portion of the bran which is more finely divided than the rest, receives the name of *sharp* or *pollard*. See the articles *BRAN* and *FLOUR*.

W. straw contains, on an average, in its ordinary state of dryness—nitrogenous substances, 1·85; non-nitrogenous substances, 67·56; mineral substances, 4·59; water, 26·00; total, 100·00; and the composition of the ash is as follows: potash, 12·14; soda, 0·60; magnesia, 2·74; lime, 6·23; phosphoric acid, 5·43; sulphuric acid, 3·88; silica, 67·88; peroxide of iron, 0·74; chloride of sodium, 0·22; total, 100·00.

The principal diseases to which W. is subject, some of which are often productive of great loss to the farmer, are either owing to or connected with the presence of parasitic fungi. See *BURST*, *MILDEW*, *RUST*, and *SMUT*. An animalcule causes the disease known as *EAR-OCKLES* (q. v.). W. suffers also from the ravages of numerous species of insects. See *HESIAN FLY*, *WHEAT-FLY*, *CORN-MOTE*, and *WIREWORM*. The larva of a Ground Beetle (*Zabrus gibbus*) is often very destructive to young W. in winter and spring.

*SPELT* (*Triticum spelta*) is regarded as a distinct species from Common W., and is supposed to be a cultivated form of *Aegilops caudata*, a native of the countries near the Mediterranean. The spikelets are smaller than in Common W., and each spikelet has two or three, rarely four, perfect florets, besides a barren terminal one, the outer glumes and the pales are very broadly truncate at the top, and notched, the awns very slender; the ripened grain adheres closely to the pales or chaff. Spelt is supposed to be the grain called *Zea* by the Greeks and *Far* by the Romans. It is of little value in comparison with W., but can be grown on inferior soils, and is cultivated in Switzerland at an elevation where W. would not succeed. The bread made of it is coarse, and is used chiefly by the poorer classes.—Another species, sometimes called *LESSER SPELT*, or *ONE-GRAINED W.* (*Triticum monococcum*), is also occasionally cultivated on poor soils and in elevated situations in the centre and south of Europe. It is sometimes called *St Peter's Corn*. The ear is small and compressed, the spikelets contain only one perfect floret and a rudimentary one; the awns are long; the grain is small, and adheres closely to the chaff.—*Triticum Bengalense* may be regarded as a kind of spelt. It has remote spikelets, long awns, and long irregularly triangular grains. It is cultivated to some extent in India.

Wheat being the most esteemed of all the cereals, particularly for the making of bread, the increase of its cultivation and use has marked the progress of agriculture and of wealth in many countries, and particularly in Britain. It is only of late that bread made of wheat has become a common article of food among the labouring classes in Britain. In some parts of the country, it is still, indeed, far from being a principal article of food among the peasantry, who use barley and oats in various forms. In the 8th c., the monks of the abbey of St Edmund, in England, ate barley-bread, because the income of the abbey would not admit of their using wheaten bread regularly. At a later period, wheat was largely used, at least in the southern parts of England, for a short time after harvest, but the supply was soon exhausted, and recourse was again had to inferior

kinds of food. There was then no trade in corn to equalise the price over the year. In 1317, when an abundant harvest had been gathered in, the price of wheat fell at once from 80s. to 6s. 8d. per quarter. The rejoicings of harvest-home were, therefore, in these times connected with a transition from poor to good fare, and from comparative want to abundance, such as happily does not attend the same occasion in our day. Down to the end of the 17th c., wheaten bread was a principal article of food only among the more wealthy; and the servants in their houses were still furnished with oats, barley, and rye. In the northern parts of England, as well as in Scotland, the use of wheaten bread was comparatively rare even at the middle of last century. 'So small was the quantity of wheat used in the county of Cumberland,' says Eden, in his *History of the Poor* (1797), 'that it was only a rich family that used a peck of wheat in the course of the year, and that was used at Christmas. The usual treat for a stranger was a thick oat-cake (called *haver-bannock*) and butter. An old labourer of 85 remarks that when he was a boy he was at Carlisle market with his father, and wishing to indulge himself with a penny loaf made of wheat-flour, he searched for it for some time, but could not procure a piece of wheaten bread at any shop in the town.' At the period of the Revolution, 1689, the quantity of wheat grown in England was estimated at about 14,000,000 bushels, or about three bushels to each of the population, which was then under five millions. In 1828, about 100,000,000 bushels were produced, or about seven bushels to each of the population, then under fifteen millions (see *Library of Entertaining Knowledge; Vegetable Substances used for the Food of Man*, Lond. 1832). In 1875 there were 3,240,344 acres under wheat in England and Wales, and 102,137 acres in Scotland, the produce of which may be estimated at about 100,000,000 bushels; besides which, a very large quantity of wheat is imported from other countries. The cultivation of wheat now extends to the most northern parts of Scotland, 4705 acres having been under this crop in 1875 in the county of Elgin, and 6139 in Ross and Cromarty, and even in Sutherland 114, and in Caithness 38 acres. The population of England and Scotland being now about 26,000,000, it appears that the quantity of home-grown wheat consumed amounts to nearly 4 bushels for each of the population; but the wheat imported in 1875 amounted to about 72,000,000 bushels; raising the amount consumed to nearly 7 bushels per head of the population. Ireland is left out of account, as not being to a great extent either a wheat-growing or a wheat-consuming country. The produce per acre is greater in Britain than in any other wheat-growing country, owing to superior farming, notwithstanding disadvantages of climate and often of soil. The extent of land now under wheat has, however, of late years diminished, owing to the foreign supply, and the high price of butcher-meat making pasturage now profitable. The quantity of wheat produced in the United States in 1874 was estimated at about 309,102,700 bushels. The chief wheat-growing states and their production in 1873 were—Iowa, 34,600,000 bushels; Illinois, 28,417,000 bushels; Minnesota, 28,056,000 bushels; Wisconsin, 26,322,000 bushels. The progress of wheat-cultivation in the western states has been extremely rapid. Iowa now produces more wheat than any other state of the union. Chicago has become one of the greatest wheat-exporting ports in the world. The exportation of wheat from Chicago began in 1838, when 78 bushels were exported; and in 1872, the quantity exported amounted to 12,160,046 bushels; this rapid increase being due to the increase of wheat-culture

in previously unsettled regions. The greater part of the wheat exported from North America is to Great Britain. Of the wheat imported into the United Kingdom in the year 1875, the United States contributed 45 per cent.; Russia, 18 per cent.; Germany, 12 per cent.; British North America, 7 per cent.; Egypt, 4 per cent.; France, 2½ per cent.; and Turkey, 2½ per cent.

**WHEATEAR, or FALLOW-CHAT** (*Saxicola oenanthe*), a bird of the genus popularly known by the name Chat (q. v.), of the family *Sylviada*, a common summer visitant of Britain, abounding on downs and fallow fields. Its geographic range is



Wheatear (*Saxicola oenanthe*).

wide. Its winter retreat is in the countries near the Mediterranean, and chiefly in Africa; its summer migrations extend to the furthest north of Europe, and to Iceland and Greenland. A few wheatears spend the winter on the southern coasts of England. The entire length of the W. is about six inches and a half; the tail is almost square; the wings are long and pointed; and the legs are long, enabling the bird to hop about actively in quest of food. Its food consists of worms and insects, and it may often be seen perched on the top of a clod or stone, looking out for them, and at the same time on the watch against enemies. The male is of an ash-brown colour on the upper parts; the forehead, a band above the eyes, and the throat, white; a black mark extending from the base of the bill to each eye, and expanding behind it, so as to cover the orifice of the ear; the wings, black; the rump, and two-thirds of the tail, except the two middle feathers, white; the tip of the tail, black; the two middle feathers of the tail, entirely black; the breast, buff-colour; the belly and flanks, pale buffy white. The female is less gaily coloured, brown and gray prevailing. The W. makes its nest in an old wall, or in a crevice of a quarry or gravel-pit, often in a deserted rabbit-burrow, and generally lays six pale-blue eggs. The male has a pleasant, but not loud song, and sings well in confinement, in winter as well as in summer. This little bird is much esteemed for the table, and great numbers are therefore annually caught, not only on the continent of Europe, but in England, where comparatively few small birds are sought after for such use. It is chiefly on the downs of the south of England, where vast flocks congregate before their autumn migration, that wheatears are caught for the market. The shepherds catch them by means of nooses placed in little excavations made in the ground, advantage being thus taken of the habits of the bird, which upon the least alarm, or even the shadow of a passing cloud, runs to hide itself in any little hollow that may be near. The usual practice of the shepherds is to cut out an

oblong piece of turf, about 11 inches by 8, and 6 inches thick, which they lay across the hole that is made, making sloping entrances at the ends of the hole, and setting nooses under the turf in the centre. As many as 84 dozen wheatears have been thus caught by a single shepherd in a day. It is not unusual for a shepherd and his lad to look after from 500 to 700 of these traps. The season for catching wheatears extends from the end of July to the end of September. They are partly sent to the London market, but very many are consumed at the watering-places on the Sussex coast.

**WHEAT-FLY**, the popular name of certain species of dipterous insects, which are often very injurious to wheat-crops. One of them, *Cecidomyia tritici* (see *CECIDOMYIA*), sometimes called the **WHEAT MIDGE**, and belonging to the same genus with the destructive Hessian Fly of America, is too common both on the continent of Europe and in Britain, but fortunately is not very abundant except in particular years. It is supposed to be the same fly which appeared in the north of New England in 1828, probably imported from the Old World, and thence spread into New York and Canada, destroying a tenth part of the wheat-crop for several years, and only disappearing on being starved out by a change of crop, or by late spring-sowing of wheat. The eggs are deposited in the wheat when it is coming into flower, and the larvæ abstracting the juices, cause the grain to shrivel. The perfect insect appears in June, when great numbers may sometimes be seen on wing in the evening, their chief time of activity. It is about one-tenth of an inch in length, pale ochreous or orange, downy, with large black eyes, and long slender legs; the male with very long antennæ. The antennæ of the male differ much in structure from those of the female, as will be seen by the annexed fig. (g, h),

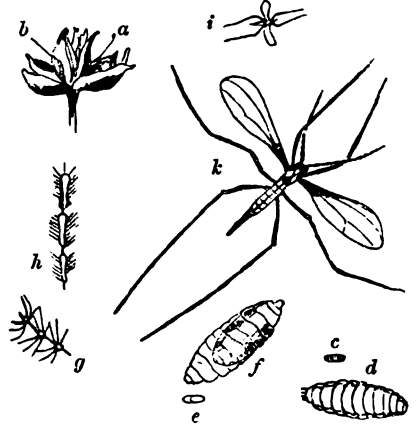

Wheat-fly (*Cecidomyia tritici*).

(From Morton's *Cyclopædia of Agriculture*.)

a, larva in spikelet of wheat; b, pupa in the same; c, larva, natural size; d, do. magnified; e, pupa, natural size; f, do. magnified; g, a few joints of one of the antennæ of a male wheat-fly; h, do. of female; i, female wheat-fly, natural size; k, do. magnified.

and are of twenty-five joints, whilst those of the female have only thirteen. The larvæ are small and lemon-coloured. A little black ichneumon lays its eggs in the larva of the W., and is thus useful to the farmer by destroying it.—The name W. is also given to species of the genus *Chlorops* (see *CORN-FLY*) destructive to wheat.

**WHEATON, HENRY**, American jurist and diplomatist, was born at Providence, Rhode Island,

November 27, 1785, educated at Brown University; admitted to the bar in 1802; after which he spent several years in France, and six months in London, engaged in legal and literary studies. On his return to America, he resided in New York, where he contributed papers on International Law to the *National Advocate*, a daily newspaper, and was appointed a justice of the Marine Court. In 1815, he published a *Digest of the Law of Maritime Captures or Prizes*, which has been commended as one of the best works, in English, on the subject. About the same time, he published an *Essay on the Means of maintaining the Commercial and Naval Interests of the United States*. In 1816, he was appointed Reporter of the Proceedings of the Supreme Court of the United States, a post he filled until 1827. His Reports, filling twelve volumes, a distinguished German has called 'the Golden Book of American Law;' and it is considered by the legal profession as a work of extraordinary ability and value. He also made frequent contributions to the *North American and American Quarterly Reviews*, and delivered addresses before literary societies. In 1825, he was engaged in revising the statute laws of New York; in 1826, he wrote his *Life of William Pinckney*, of which he furnished an abridgment for Sparks's *American Biographies*. In 1827, he was appointed *Chargé d'affaires* to Denmark, and resided at Copenhagen till 1835, when he was appointed Resident Minister at Berlin, and in 1837, Minister Plenipotentiary, which post he occupied with distinguished credit until 1846. In 1831, his *History of the Northmen* appeared at Philadelphia, London, and Paris; in 1836, his *Elements of International Law*; in 1841, his *Essay*, for which he received the prize of the French Institute, entitled *L'Histoire du Droit des Gens en Europe, depuis la Paix de Westphalie jusqu'au Congrès de Vienne*, which, in 1846, was published, greatly enlarged, in Leipzig and Paris, and an English translation in New York. This work is a standard authority, and its author received the highest honours from the learned societies of Europe, and his own countrymen. Having retired from political life, he died at his residence at Dorchester, Massachusetts, March 11, 1848.

WHEATSTONE, SIR CHARLES, physicist and electrician, was born at Gloucester in 1802. From school he went to the making of musical instruments, and afterwards entered into business on his own account in London. But he was no ordinary manufacturer: the scientific principles involved in the construction of instruments occupied his thought; he made many improvements, and in 1823, published a paper entitled *New Experiments on Sound*. Endowed with remarkable ingenuity, he produced numerous models and apparatus to illustrate the phenomena of acoustics and of light, his attention having been drawn to the latter by the analogies between the two subjects. Few men have done so much towards enabling the student to apprehend the principles on which scientific theories are based, particularly those of the undulatory theory of light.

In 1833, Mr W. communicated his first paper, *On Acoustic Figures*, to the Royal Society; followed, in 1834, by *Experiments to measure the Velocity of Electricity*, in which, with a mirror revolving 800 times in a second, he demonstrated the velocity at 238,000 miles in a second—greater than that of light. In the same year, he was appointed Professor of Natural Philosophy in King's College, London. In 1836, he was elected a Fellow of the Royal Society; and in a course of lectures at the College on the velocity above referred to, he anticipated the electric telegraph by experimenting through four miles of copper wire. In May

1837, a patent was taken out in the joint names of Cooke and W., 'for improvements in giving signals and sounding alarms in distant places by means of electric currents transmitted through metallic circuits.' From this instrument, which had five needles, has grown that system of electric telegraphs which now ramifies over the length and breadth of the United Kingdom. The first working-telegraph—insulated copper wires enclosed in an iron tube—was constructed on the Blackwall Railway in 1838.

To enumerate the titles only of Professor W.'s papers on scientific subjects, and describe his various inventions, would fill many pages: a few only can be indicated here. In a paper on Binocular vision laid before the Royal Society in 1838, he explained the principle of the stereoscope, an instrument of his invention: in 1840, he shewed that, by means of electro-magnetism, a number of clocks far apart might be kept going with absolute exactitude from one central clock; and in 1843, he brought out his new instruments and processes for determining the constants of a voltaic series. In 1840, and again in 1843, the Royal Society awarded him their Royal Medal—a high acknowledgment of the merit of his researches. For a long time after that date, scarcely a year passed without a paper on some recondite scientific subject, or some new invention, or improvement on former inventions, from the hand of Professor W., which heightened his reputation, and procured him substantial pecuniary reward. Among his inventions are his cryptograph; his automatic telegraph in two forms; his telegraph thermometer and barometer, by which an observer at the foot of a mountain could read the indications as shewn by the instruments on the summit; a machine for the conversion of dynamical into electrical force without the use of permanent magnets, by which large quantities of electricity can be produced at a cheap rate; and an apparatus for conveying instructions to engineers and steersmen on board large steam-vessels.

Professor W. sat many times on the Council, and was a vice-president of the Royal Society. He was also a corresponding member of the leading foreign scientific academies, and in 1873 he was elected Foreign Associate of the science department of the Institute of France. In 1868, he received from Her Majesty the honour of knighthood, and in the same year the Royal Society bestowed on him its Copley medal. He was made LL.D. in 1869 by the university of Edinburgh. He died in 1875.

WHEEL AND AXLE, the second of the Mechanical Powers (q. v.), is a modification of the Lever (q. v.). Its most primitive form is a cylindrical axle, on which a wheel, concentric with the axle, is firmly fastened. When employed for raising heavy weights, the weight is attached to a rope which is wound round the axle, and the power is applied either to a rope wound round the grooved rim of the wheel, or to a handle fixed at right angles to the wheel's rim (in the latter case, the wheel may be dispensed with, unless it is useful as a conservator of momentum [see FLY-WHEEL], and an ordinary winch substituted). The accompanying figure exhibits a transverse section of the common form of the wheel and axle, and shews that the wheel and axle is neither more nor less than a lever, whose extremities are not points as in the normal form,

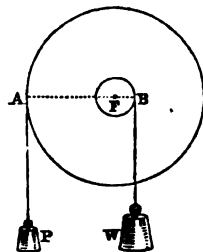

but the circumferences of the circles, whose radii are FA and FB. Accordingly, the power and weight are not attached to particular points in these circumferences, but to cords wound round them, and thus the imaginary simple lever, AB (formed by joining the points where the cords become tangents to the circles), is preserved unaltered in position and magnitude. The conditions of equilibrium are, that  $P \times AF = W \times FB$ , or, since the circumferences of circles are proportional to their radii, that  $P : W ::$  circumference of axle : circumference of wheel. When there is no wheel, but only a winch, the circumference described by the power in one revolution is substituted for the circumference of the wheel. The *capstan* and *windlass* are simple and common examples of this mechanical power, and combinations of toothed-wheels, or of wheels from one to another of which motion is communicated by an endless band, are compound illustrations of the same. See WINDLASS.

#### WHEEL-ANIMALCULE. See ROTATORIA.

**WHEEL, BREAKING ON THE,** a very barbarous mode of inflicting the punishment of death, formerly in use in France and Germany, where the criminal was placed on a carriage-wheel, with his arms and legs extended along the spokes, and the wheel being turned round, the executioner fractured his limbs by successive blows with an iron bar, which were repeated till death ensued. There was considerable variety in the mode in which this punishment was inflicted, at different times and in different places. By way of terminating sooner the sufferings of the victim, the executioner was sometimes permitted to deal two or three severe blows on the chest or stomach, known as *coups de grâces*; and occasionally, in France at least, the sentence contained a provision that the criminal was to be strangled after the first or second blow. Mercy of this kind was, however, not always allowed to be shewn to the victims of the wheel: when Patkul, the envoy of Peter the Great, was put to death on the wheel by order of Charles XII. of Sweden, it is said that the officer in command of the guard was cashiered by the Swedish king in consequence of having allowed the head to be struck off before life was extinct in the mangled limbs. The punishment of the wheel was abolished in France at the Revolution; in Germany, it has been occasionally inflicted during the present c., on persons convicted of treason and parricide.

**WHEELERA,** a genus of trees of the natural order *Leguminosæ*, sub-order *Papilionaceæ*. The wood of *W. ebenus*, a native of the West Indies, and of the tropical parts of America, is imported into Britain under the name of *American Ebony*. It is very hard, of a brownish-green colour, takes a fine polish, and is employed by cabinetmakers and musical-instrument makers.

**WHEEL'LING,** a city and port of entry of West Virginia, U.S., on the left bank of the Ohio River, and both sides of Wheeling Creek, 40 miles direct, and 92 by river, below Pittsburg. The city is built at the foot of the hills, which rise to the Alleghanies, and is the terminus of the Baltimore and Ohio, and of the river division of the Cleveland and Pittsburg railways. The great national road here crosses the Ohio, over which is a wire suspension-bridge, 1010 feet long. The hills around the city are full of bituminous coal, which sells for 1d. a bushel. In 1864, there were 49 steamboats, numerous foundries, and other metallurgic works, glass-houses, paper-mills, flour-mills, breweries, tanneries, &c.; and 2 daily newspapers. Pop. in 1870, 19,280.

**WHEEL-WORK.** The arrangement for conveying motion from one axis to another by means of toothed-wheels, is familiar to every one; it has

been in use since the days of Archimedes, and was in use, probably, for many centuries before; but it is only in modern times that the action of such wheels has been critically examined and understood. To a superficial observer, the action appears to be extremely simple: a tooth of the driver pushes against a tooth of the driven wheel, thereby causing that wheel to turn round; and, since by this turning the teeth must become disengaged, it is requisite that, before one tooth let go, a second tooth of the driver be ready to take hold of another tooth of the driven wheel. For this purpose, it is enough that the distances between the teeth on the two wheels be alike; in other words, that the diameters be proportioned to the number of the teeth.

When two unequal wheels act upon each other, the smaller one turns faster than the larger. Thus, if a wheel with 60 teeth work into one of 20, the latter will turn 3 times as quickly as the former; and it is on this principle that the trains of clock-work are arranged. For example, the *great-wheel* of a common house-clock may have 180 teeth, and may drive a smaller wheel, or *pinion* as it is called, of 15 leaves, and in this case, if the great-wheel turn once in 12 hours, the pinion must turn once in every hour; the axis of this pinion carries the minute-hand. On the same axis the *hour-wheel* is fixed, which may have, say, 96 teeth, and may drive a pinion of 12 leaves. This pinion, then, must turn 8 times per hour, or once in  $7\frac{1}{2}$  minutes. On the same axis with this last-mentioned pinion there is fixed the *third-wheel*, having, perhaps, 75 teeth, and this drives a pinion of 10 leaves, which, turning  $7\frac{1}{2}$  times as fast, must make one turn per minute. On the axis of this last pinion the *escape-wheel* is fixed. This escape-wheel has 30 teeth, each tooth acting twice upon the pendulum, thus making 60 beats per minute. In such a case as this, there is no difficulty in arranging the numbers of the teeth, and these may be varied in many ways, provided the proper proportions be kept. But in other cases, a considerable amount of skill, and often a great deal of labour, is required for the discovery of the proper numbers. Thus, if it be wished to indicate the moon's age on the dial of a clock, we must have an index turning once in the time between new moon and new moon. This time, which astronomers call a *lunation*, averages 29 days, 12 hours, 44 minutes, and nearly 3 seconds (2853), and it is by no means an easy matter to find out what number of teeth will produce this motion. The month-wheel would need to turn rather more than 59 times as slowly as the great-wheel of the clock; and if the mean lunation had been 29 $\frac{1}{2}$  days, without the odd 44 minutes, the thing could have been managed by making a pinion of 8 teeth lead a wheel of 59 teeth, on the axis of which another pinion, say, of 10 teeth is fixed, and made to work a wheel of 50 teeth. But then such an arrangement would go wrong nearly three-quarters of an hour every month, and in three years would indicate new moon a day too early. In order to obtain a better train, we may compute the number of days in 2, 3, 4, 5 lunations until we get nearly a number of half-days. Now, 16 lunations consist of 472 days, 11 hours, 45 minutes, or almost exactly 945 turns of the great-wheel. This proportion can be obtained by causing a pinion of 12 teeth to lead a wheel of 81 teeth, and another pinion also of 12 teeth to lead a wheel of 105 teeth. This arrangement gives an error of one quarter of an hour in 16 months, or hardly an hour in 5 years. If still greater precision be required, we must carry the multiples further: 33 lunations make 974 days, 12 hours, 134 minutes, or 1949 turns of the great-wheel of the clock; but then this number 1949 has no divisor, and it is quite impracticable to make a

## WHEEL-WORK.

wheel of 1949 teeth; so that we must continue our multiples in search of a better train. In this way, when great exactitude is desired, we often encounter an unexpected amount of labour. For reducing this labour, the method of continued fractions is employed, and the toil is further lessened by the use of tables of divisors.

Such calculations have to be made for the construction of orreries, by which the times of the revolutions of the planets are shewn; and engineers have to make them, as when a screw of a particular pitch has to be cut. If, for instance, we have to cut a screw of 200 turns to the French mètre on a lathe having a leading-screw of 4 turns to the English inch, the axis of the lathe must make 50 turns while the screw makes 39 and a fraction, since the mètre is  $39\text{-}37079$  inches. By applying the method of continued fractions, we discover that, for 2225 turns of the lathe-spindle there must be 1752 turns of the screw; and as these numbers can be reduced into products—viz., 2225 into  $5 \times 5 \times 89$ , and 1752 into  $2 \times 2 \times 2 \times 3 \times 73$ , we can easily get trains to produce the required effect. From these illustrations, it is apparent that the computation of the trains of wheel-work is intimately connected with the doctrine of prime and composite numbers.

The general sizes of the wheels and the number of the teeth having been fixed on, the next business is to consider the shape which those teeth ought to have. Now, for the smooth and proper action of machinery, it is essential that the uniform motion of one of the wheels be accompanied by a motion also equable of the other wheel. Two curves have been known to give this quality of equable motion—viz., the epicycloid, formed by rolling one circle upon another, and the involute of the circle traced by the end of a thread which is being wound upon a cylinder, or unwound from it. But the general character of all curves which possess this property has been only lately examined. If it were proposed to construct two wheels which shall have their centres at the points A and B (fig. 1), and the one of which may make 5 turns while the other makes 3, we should divide the distance AB into 8 parts,

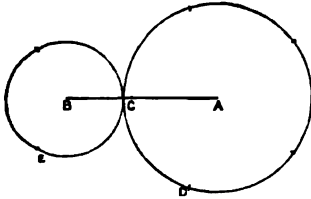

Fig. 1.

and assign 5 of these for AC, the radius of the one wheel, the remaining 3 parts for the radius BC of the other wheel. Wheels made of these sizes, and rolling upon each other, would turn equably, and if the circumferences be divided into 5 and 3 parts respectively, the points of division would come opposite to each other as the wheels turned. The circumferences of these circles are called the *pitch-lines*, and the portions of them included between two teeth is called the *distance of the teeth*: the distance, or arc CD, on the one wheel must be equal to the distance CE on the other wheel, in order that the motion may bring the two points D and E together. For a reason that will appear in the sequel, we cannot use wheels with so few as 3 or 5 teeth, and therefore we subdivide the distances CD and CE into some number of parts, say 4, and thus obtain wheels of 20 and 12 teeth instead. Since the tooth of the one wheel must necessarily

come between two teeth on the other, the distance between the teeth must be halved, the one half being given for tooth, and the other half for space.

Having then divided off the pitch-line of the wheel B, as in fig. 2, CD being the distance of the teeth, CG the half-distance, let us sketch any contour, CFGHD, for the shape of a tooth, and let us examine what should be the characters of this outline. In the first place, the form of this outline must be repeated for each tooth; and in the second place, the line should be symmetric from the top, F, of the one to the top, I, of the next tooth, in order that the wheel may be reversible face for face. These obvious conditions having been attended to, let us cut, in thin sheet-brass or other convenient

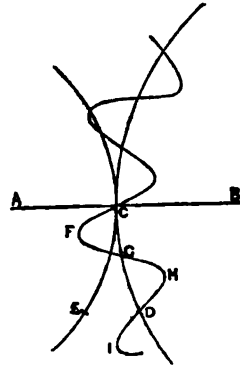

Fig. 2.

material, a disc having this outline, and let us pin its centre at the point B. Having prepared a blank disc on which the outline of A is to be traced, let us slip it under the edge of the previous one, and pin its centre at the point A. If, now, B and A being held fast, we trace the outline of B upon A, we move each of them slightly, but in the proper proportion forward, and make a new trace upon A, and so continue as far as needed, we shall obtain a multitude of curve lines marked upon A. The line which envelops and touches all these curves is, obviously, the proper outline for the wheel A; and thus it appears, that whatever outline, within reasonable limits, may have been assumed for the teeth of B, it is always possible, by a geometrical operation, to discover the proper corresponding form for the teeth of A. These forms may be called *conjugate* to each other, inasmuch as, that if the disc A were now cut out and used as B has been, the identical form of B would be reproduced.

We may obtain a whole series of wheels, A', A'', A''', &c., from the same original B; and from A, as an original, we may obtain another series, B', B'', B''', &c., having various numbers of teeth. And it has been shewn that any wheel of the series A will work accurately along with any one of the series B. So far well; but then the wheel B of 20 teeth may not be like the wheel B of the same number of teeth. It becomes, therefore, a desideratum to choose the form of the teeth of B in such a manner that its conjugate of the same number of teeth may have the same form; by such an arrangement, we shall obtain a series of wheels, any one of which will work with any other.

If the number of the teeth of B be augmented indefinitely, the outline of the pitch-line will become nearly straight; and so drawing through C (fig. 3) a straight line to touch the pitch-line of A, we shall have the pitch-line of the straight rack, as it is called, which could be worked by any wheel of the series A. The reverse of this rack would work with any one of the series B, and therefore, if the series A and B be identical with each other, the

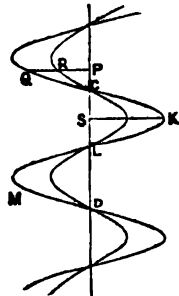

Fig. 3.

## WHEEL-WORK.

rack must be its own reverse. Thus we obtain a very important general result—viz., that if we mark off along a straight line distances, CD, equal to the desired interval between the teeth, and then draw any line CKLMD, consisting of four equal parts, CK, KL, LM, MD, symmetrically arranged, all the wheels obtained from this, as the original, will work into each other; and, moreover, the forms thus obtained answer for internal as well as external teeth.

Being then at liberty to choose any line whatever, subject to the above condition of symmetry, for the figure of the straight rack, we may inquire whether it may not be arranged so as to bring about other desiderata. This line, it may be noted, is not necessarily curved; it may be composed of straight lines, or partly of straight and partly of curved lines.

The general appearance of this wavy line recalls that curve known as the curve of sines, which, indeed, is the simplest known curve, consisting of equal and symmetric undulations, and unlimited in extent. By changing the ordinates in any ratio, say in the ratio of PQ to PR, the waves of the curve may be made shallower or deeper; and on studying the effects of such a change, we discover some new and very important laws concerning the contacts of the teeth of wheels.

Beginning with the curve of sines *proper*, in which the greatest ordinate, SK, is equal to the radius of a circle of which CD is the length of the circumference, it is found that wheels traced from it can only touch each other at *one* point: of course such wheels cannot work, because the solitary contact is now on the back and now on the front of the tooth. In this case, the contour of the tooth crosses the pitch-line at an angle of  $45^\circ$ . On deepening the teeth, still keeping to the same kind of curve, it is found that the wheels begin to touch at more points than one; and when they are made so deep as that the contour crosses the pitch-line at an angle of  $65^\circ$ , there are always three contacts, neither more nor less. If the teeth be still further deepened, the contacts become more numerous; they appear and disappear in pairs, so that with an inclination of, say,  $68^\circ$ , there would be sometimes three, and sometimes five contacts. When it becomes  $70^\circ 17'$ , there are always five; and with an inclination of  $73^\circ 11'$ , there are always seven points in contact at once.

Of these points of contact, some are on the sides of the teeth, and others are near the top and bottom; the latter, on account of the obliquity of their action, are of no use in driving; they may be called supplementary, and their number is always one less than the number of useful or working contacts. In the system of seven contacts, four are useful, two of them being forwards, and two backwards, so that two teeth are always in action at once; an arrangement by which a gradual improvement in the equality of the teeth is secured by their wearing.

When two properly formed wheels are put in motion, the points of contact move also, and describe a peculiarly shaped line, the nature of which depends on the character of the primary form adopted for the tooth of the straight rack. Conversely, if this path of the points of contact be first assumed, and the law of motion in it be observed, the form of the tooth of any wheel may thence be obtained; and this leads us to the most convenient way of making the delineation.

In fig. 4, the form of the straight rack and the corresponding shape of the teeth of a wheel of 20 are shewn in contact, the depth of the tooth being such as to give five contacts, which in the drawing are at the five points marked 0. If we suppose the rack to be slid upwards, carrying the wheel along with it, the points of contact will

change; and when the motion has been one-eighth part of the interval between two teeth, these points will occupy the positions marked 1. When a

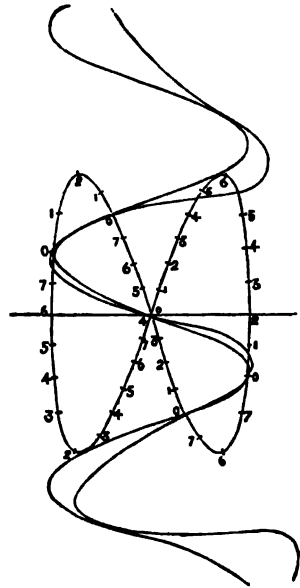

Fig. 4.

change of another eighth is made, the two upper contacts on the left hand merge into one, and are about to disappear; at the same instant, two new contacts begin at the lower point, marked 2; and thus the motion continues in the order of the numbers marked along the peculiarly shaped path of the points of contact. Those contacts which occur along the crossing lines of the curve, are working

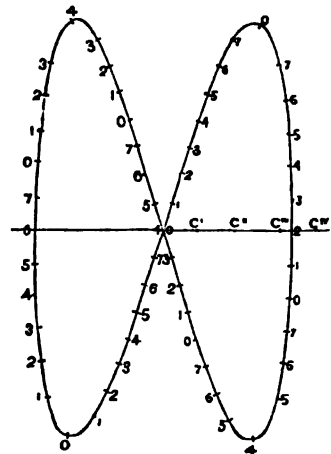

Fig. 5.

contacts; those which happen along the two external arcs, are supplementary. When the form of this path, and the positions of the successive points in it have been obtained by calculation, the outline of any wheel is easily traced geometrically. Figs. 5, 6, and 7 shew the path for the system of seven contacts; fig. 5, when the outline of the rack is the curve of sines; fig. 6 when the teeth of the wheels

## WHEEL-WORK.

have the involute, and fig. 7 when they have the epicycloidal form. In these figures,  $C'$ ,  $C''$ ,  $C'''$ , are the positions of the centres of wheels of 1, 2, 3 teeth.

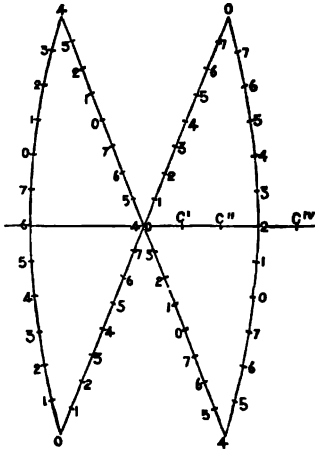

Fig. 6.

In well-constructed machinery, there should never be fewer than seven contacts in the system, since of these only four are working; and therefore only two teeth are fully engaged; and it is necessary

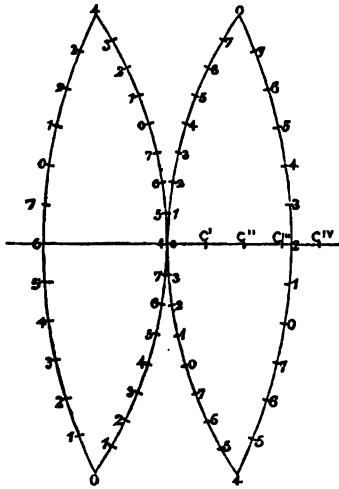

Fig. 7.

that two teeth be engaged at once, in order that the wearing may tend to remove any unavoidable inequalities of workmanship.

When we attempt to delineate the forms of wheels with few teeth by help of any of these orbits, we find that the contours overlap each other; in such cases, the following tooth of the conjugate wheel effaces, as it were, the trace belonging to the preceding tooth; and the contacts, though still holding good of the geometrical curves, become mechanically impossible. Thus it is that there are limits below which we cannot go in the numbers of the teeth. If the overlapping occur at the shoulder of the tooth, some of the useful contacts are wanting; but when the replication is only at the point of the tooth, the want of the supplementary contact

occasions no inconvenience. An examination of the different cases shews that with seven contacts, the smallest numbers which can be used on the three systems just mentioned are 19, 17, and 11, so that the system of epicycloidal teeth has, in this respect, the advantage over the others. Clock pinions, then, should not have fewer than eleven leaves.

This method of considering the subject was first published by the writer of this article in *A New General Theory of the Teeth of Wheels* (Edinburgh, 1852).

It remains to cut the actual wheels to the shapes thus formed. The essentials of the operation are these: The blank wheel is attached to the axis of a large divided circle, which can be turned round and held in any desired position. A cutter, generally a revolving cutter, is brought down upon the blank, so as to notch out the space between two teeth; this done, the circle is turned round by the proper number of divisions, and another space is cut, and in this way the whole circumference of the wheel is gone over. In order that the work be well done, it is essential that the cutter be truly shaped; and when the edges get blunted by use, it is no easy matter to avoid spoiling the shape in the resharpening. Whatever system be followed, the form of the tooth varies from one number to another, so that the cutter which answers for a wheel of 20 cannot do for one of 30 teeth; and hence, when accurate results are wanted, there must be a cutter for each wheel. In order to avoid the expense of so many cutters, each requiring to be carefully made, the slovenly practice is too often followed of having, perhaps, two cutters, one to be used for pinions, the other for wheels; and the result is the intolerable noise which is so common in mills, and which, if properly understood, should be taken as an indication of unnecessary expenditure of power.

When, as in the wholesale manufacture of clocks and watches, multitudes of wheels are to be cut of one size, careful attention can be given to the shape of the cutter. The labour is economised by binding a considerable number of blanks together on the dividing engine, and ploughing out the teeth of the whole of them at once. For the small wheels, technically called pinions, which cannot conveniently be fixed on the dividing-engine, *pinion-wires* are used; these are wires of brass or steel drawn through holes of the proper shape, and having the leaves running all along them. The watchmaker removes the leaves from those parts where they are not wanted, and thus obtains the pinion and its axle in one piece; in this way he gains the advantages of solidity and economy of workmanship.

Among the many purposes to which wheel-work is applied, it sometimes happens that an unequable motion is wanted. Thus, in the construction of an orrery, it is desirable that while one index turns uniformly to shew the time, another may turn so as to shew the unequal motion of the sun in the ecliptic. In that case, the variations of the velocity are small, and it is enough to divide the teeth unequally, as the slight inequality can hardly affect the working of the apparatus. But when the changes of velocity are considerable, the matter must be more carefully looked into. If we suppose the pitch-lines of two wheels to be uneven, and to roll upon each other without regard to the positions of their centres, the forms of teeth to be arranged upon those pitch-lines may be traced out almost in the manner already explained for round wheels. The pitch-line must be divided into equal distances, and the disc must receive a half-sliding half-turning motion, so that the pitch-line may pass through the point  $C$  (fig. 8) always perpendicularly to the line  $AB$ , which is the line of centres for round



wheels. The combination of this motion with the proper motion of the points of contact gives true forms for the teeth.

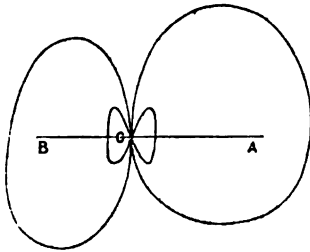

Fig. 8.

Thus, the form of the tooth can be obtained when that of the pitch-line is known. Now, when two discs, turning on fixed centres, touch each other at any point out of the straight line joining these centres, there is a slipping of the one surface over the other; and therefore, in order that the pitch-lines may roll together, they must be so shaped as that the point of contact may be in the line of centres. It can be shewn that, for any assumed contour of the wheel A, another contour having its centre at B, and rolling upon A, is possible. But, except in one or two special cases, the working out of the problem has not been accomplished. It will be enough here to mention the single case of elliptic wheels. The action of these is founded on the well-known property of the ellipse, that the sum of the distances of any point in it from the two foci is constant, and that the curve makes equal angles with these two lines. Hence two equal ellipses turning on their foci, when their centres are at a distance equal to the major axis of the ellipse, will roll upon each other; and teeth formed upon these as pitch-lines will work perfectly. In fig. 9, the

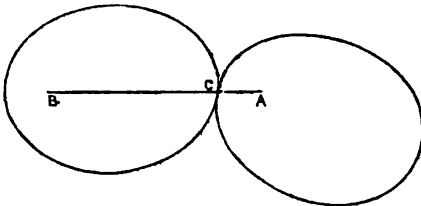

Fig. 9.

ellipses have their major and minor axes in the proportion of 5 to 4; with that proportion the focus is at one-fifth part of the major axis from one end; and therefore B, at one part of the revolution, moves four times as fast—at another part, four times as slowly—as A.

Sometimes one of the wheels has to be quite at rest during part of the motion of the other wheel. This is accomplished by causing some part of the wheel that is to be stationary, to bear upon a part of the circumference of the moving-wheel which is concentric with its axis. This is exemplified in the arrangement for counting wheels shown in fig. 10. The object of this apparatus is to count and record the revolutions of the wheel B. As this wheel turns round, a pin E attached to it enters into the slit GH, and thus carries the wheel A round as long as the pin remains in the slit, that is, until the slit GH be brought into the position IK. As soon as E leaves the slit at I, there would be no further connection between the two wheels, and A

could be moved anyhow, altogether independently of B. In order to prevent this, the disc B is made nearly five-sixths entire, and parts of A are scooped out between the slits so as to receive and to fit B. By this means A is prevented from being turned either backwards or forwards until the pin E again come into one of the slits. When this happens, the projecting part at G finds room in the recess F. If there be seven slits, GH, round the wheel A, and if B turn once in twenty-four hours, an index attached to A would shew the days of the week; and the index might be made to be stationary all day, the change being effected during the night. Another example of this kind of interrupted motion is seen in the ordinary dead-beat clock escapement, in which the detaining surface of the pallet is concentric with the axis of the crutch.

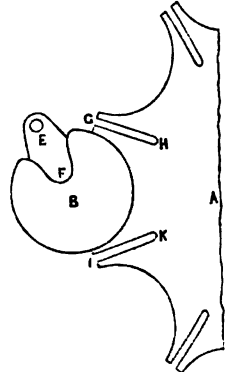

Fig. 10.

When the axes are inclined to each other, bevelled wheels are used. Just as common wheels may be regarded as fluted cylinders, bevelled wheels may be described as fluted cones having a common apex. The principles which regulate the formation of the teeth of these are the same as for plane wheels; but the application of these principles is considerably more intricate. Since both the teeth and the spaces between them are tapered, it is impossible to notch out the intervals by means of a revolving cutter. Attempts have been made to construct machinery for planing the teeth by means of a cutter moving in a line towards the apex of the cone, but the complexity of the apparatus, and the slowness of the process, have prevented its introduction; and thus the accurate formation of bevelled wheels has still to be accomplished by hand.

WHELK (*Buccinum*), a genus of gasteropodous molluscs, of the family *Buccinidae*. The shell is ovate, turreted, and more or less ventricose; its mouth ovate, emarginate, or produced into a very short canal below, the outer lip expanded, the inner lip usually thin and smooth within. The operculum is horny. The animal has a broad head, with two tentacula, with the base of which the stalks bearing the eyes are united; the proboscis is large, and the tongue armed with teeth, which are used for the purpose of rasping substances used for food—almost any animal substance being welcome for this use—or for perforating the shells of other molluscs in order to prey upon them. There are about twenty



Whelk (*Buccinum undatum*): a, the eggs.

known species, chiefly found on the coasts of the colder parts of the world. The British coasts produce several species, of which the most abundant is the COMMON W. (*B. undatum*). It occurs from

low-water mark to a depth of 100 fathoms, is sometimes three inches in length, grayish or brownish white, with numerous raised ridges and spiral striae. It is very widely distributed in the northern parts of the northern hemisphere, and is one of the most common molluscs of the arctic regions. It is much used as an article of food, is cooked simply by boiling, and is generally eaten with vinegar and pepper. Great quantities are consumed in London, chiefly by the poorer classes. In former times, whelks would appear to have been more highly esteemed than now. Eight thousand of them were provided for the enthronisation feast of William Warham, Archbishop of Canterbury, in 1504. Yet on some parts of the British coasts, as on those of Scotland, whelks are never eaten, a prejudice existing against them as unsuitable for food. The whelks brought to the London market are mostly obtained by dredging. On the coast of Galloway, where they are used as a bait for catching cod, they are procured by letting down baskets containing pieces of fish in about ten fathoms water. The baskets being taken up next day, are found to contain many whelks which have crept into them to feed on the garbage. The name *W.* (or *Wilk*) is popularly given in Scotland to the Periwinkle, the *W.* being known by that of *Buckie*.—There are more than 100 fossil species of *W.* in the Miocene formations.

**WHELK, or BUBUCLE.** These are terms used by the older English writers, and by Dr Craigie in recent times, to signify the cutaneous disorder now commonly known as *Acne*. The simple whelk, the black whelk, the inveterate whelk, and the crimson whelk, correspond to *Acne simplex*, *A. punctata*, *A. indurata*, and *A. rosacea* of the more modern dermatologists. The symptoms of the crimson whelk, or fiery-face, must have been carefully observed by our great dramatist before he could have written Fluellen's graphic description of Bardolph: 'His face is all bubukles, and whelks, and knobs, and flames of fire, but his lips plows at his nose; and it is like a coal of fire, sometimes plue, and sometimes red.'—*King Henry V.*, act iii. sc. vi. The *Chin-whelk* is the old name for the affection now known as *Sycosis* or *Mentagra*.

**WHEWELL, WILLIAM, D.D.**, was born in 1795 at Lancaster. His father intended him for his own trade—that of a joiner; but the boy having excelled at school in mathematics, was persuaded to go to Cambridge. He entered at Trinity College, and graduated (Second Wrangler, and Second Smith's Prize-man) B.A. in 1816. He became a Fellow, and afterwards a Tutor of Trinity, where also, for many years, he acted as a successful 'coach,' or private tutor. In 1820, he became a Fellow of the Royal Society. Between 1828 and 1832, he was Professor of Mineralogy in Cambridge; and between 1838 and 1855, Professor of Moral Theology, or Casuistry. In 1841, he was appointed Master of Trinity; and in the same year, he was President of the British Association at its meeting at Plymouth. He was also, for a time, President of the Geological Society. In 1865, he became Vice-chancellor of the university of Cambridge. He died at Trinity (1866), in consequence of injuries sustained through a fall when riding.

*W.*, when he acted as a private tutor, produced several text-books on mathematical subjects (one of which, his *Dynamics* (1823), is deservedly admired), which were for a time popular, but may now be said to have been superseded. He also contributed a variety of papers to the Transactions of learned and scientific societies, and to scientific journals, and to the reviews. In some of these, he treated of such subjects as the Tides, Electricity, Mag-

netism, and Heat; in others, of abstruse and recedite subjects, literary, historical, and metaphysical. Later in life, while he continued to write papers of this class, he concentrated his powers mainly on the production of large works. Among the most important of his books are—*Astronomy and General Physics considered in Reference to Natural Theology*, being the third Bridgewater Treatise (Lond. 1833); *History of the Inductive Sciences, from the Earliest to the Present Times* (3 vols., Lond. 1837); *The Philosophy of the Inductive Sciences, founded upon their History* (2 vols., Lond. 1840); *The Elements of Morality, including Polity* (Lond. 1855). Among his other works are—*The Plurality of Worlds*, which had considerable popularity from its subject; *The History of Scientific Ideas, Novum Organum Renovatum; Notes on the Architecture of German Churches; Lectures on the History of Moral Philosophy in England; Indications of the Creator*; translation of Goethe's *Herman and Dorothea*; translation of Auerbach's *Professor's Wife*; translation of Grotius's *Rights of Peace and War*; a translation of Plato's works; and *The Platonic Dialogues for English Readers*. Besides these books, he published many essays, as yet uncollected. His last composition, so far as is known, is an attack on Combe and Positivism, which appeared in *Macmillan's Magazine* after his death.

*W.*'s acquisitions were most various; it would have been sufficient occupation for the lives of most bookworms to have made them. His writings, again, were so various and voluminous, it might be thought sufficient employment of the life of a mere clever bookmaker to have produced them. *W.* was neither bookworm nor bookmaker. A clear-headed student, he was always increasing his stock of knowledge; a vigorous and independent thinker and writer, he was always giving forth the results of his studies to the public; and having thus proceeded during a long life of almost uninterrupted good health, he may be taken as illustrating what at the best may be achieved by a man of ambition, ability, and unflagging industry, without genius. He was nowise superficial, like many pretenders to encyclopedic knowledge; he was really master of all that could be learned on a great many subjects. It has been said of him, 'knowledge was his forte, omniscience his foible;' but it is absurd to suggest that a man can have and strain after too much knowledge, if it be, as his was, thorough knowledge. His chief ambition was to grasp, survey, and co-ordinate the sciences; and he did excellent service both to science and history in the effort to gratify it. The task suited one of his extraordinary acquisitions, good sense, and philosophic comprehension. Had he been a man of more imagination and ingenuity, he might, of course, have been better employed in endeavouring to advance some single science. As he was, this was beyond him: he made some original investigations; but the results must be pronounced unimportant.

*W.* was a large, strong, erect man, with a red face and a loud voice. He was an effective preacher and lecturer, though in both characters wanting in that 'something' which wins and rivets the hearer. He was accused of being arrogant; and his general bearing gave colour to the charge. A story, long current, may be told as illustrating at once his varied knowledge and his personal relations to his brother Fellows. He used so to overwhelm with his learning the company at the Fellows' table and in the Combination Room, that a conspiracy was formed to put him down. Some Fellows got up a knowledge of Chinese music from scattered articles in old reviews, with which they presumed he would be unacquainted. They then made Chinese music

the subject of, as it were, a casual conversation at table. For a time, contrary to his usual habit, he took no part in the conversation. When they had about exhausted themselves, however, he remarked: 'I was imperfectly, and to some extent incorrectly, informed regarding Chinese music when I wrote the articles from which you have drawn your information.' They were caught in their own trap, and had, as on other occasions, to submit to be instructed.

**WHEY.** When any substance, possessing the property of coagulating casein, is added to milk, the coagulated casein separates in flakes and clots, and sinks to the bottom, constituting what is termed the *curds*; while the supernatant, straw-coloured fluid is known as the *whey*. Cheese-making affords the principal source of whey, which, thus obtained, forms, like butter-milk, a very valuable kind of drink. The whey of goat's milk is regarded as specially beneficial, and in Switzerland and elsewhere, large establishments have been set up for carrying out the *whey-cure*, either alone or in association with the *grape-cure*. There can be no doubt that, were the cases judiciously selected, much good, in the way of eliminating morbid matter, might be effected in a few weeks by confining the patients to a diet of brown bread, grapes, and whey; while, on the other hand, many diseases might be much aggravated by that treatment. In ordinary medicine, we recognise several useful varieties of whey, as: White-wine whey, prepared by the addition of sufficient sherry to a tumbler of heated milk to coagulate the casein. On decanting off the whey from the curds, and sweetening, we obtain a favourite sudorific draught, which may be taken with advantage as a sudorific at bedtime, whenever there is a threatening of incipient cold in the head. *Cream-of-tartar whey* and *nitre-whey*—the former prepared by boiling 100 grains of cream of tartar in a pint of milk, and the latter by the similar use of nitre—act in the same way as wine-whey, but more powerfully. *Tamarind whey* has been already described in the article on that fruit.

**WHIG AND TORY**, the names which for the last two centuries have been popularly applied to two opposite political parties in Great Britain. Both were at first names of reproach. *Whig* was originally a nickname of the peasantry of the Western Lowlands of Scotland, said by some to be derived from a word or sound used by them in driving their horses; by others, from *whig*, 'an acetous liquor subsiding from sour cream.'—*Jamieson*. Its next application was to the bands of Covenanters, chiefly from the west of Scotland, who, subsequently to the murder of Archbishop Sharpe, took up arms against the government, and after gaining some successes in encounters with the king's troops, were defeated at Bothwell Bridge. Thence the name Whig (or Whigamore) came to be fastened, first, on the whole Presbyterian zealots of Scotland, and afterwards on those English politicians who shewed a disposition to oppose the court, and treat Protestant nonconformists with leniency. The word *Tory*—said to be derived from *tora*, *tora*, in Irish, 'give, give,' or 'stand and deliver'—was first given to certain bands of outlaws, half-robber, half-insurgent, professing the Roman Catholic faith, who harassed the English in Ireland; and was thence applied reproachfully to all who were supposed to be abettors of the imaginary Popish plot; and then generally to persons who refused to concur in the exclusion of a Roman Catholic prince from the throne. These two nicknames, which came into use about 1680, immediately became familiar words, and have since been retained as designations of two opposite political sides—the Tories being,

generally speaking, the adherents of the ancient constitution of England without change, and the supporters of regal, ecclesiastical, and aristocratic authority; while the Whigs have been the advocates of such changes in the constitution as tend in the direction of democracy. The most sweeping constitutional change of the present century which the Whigs have carried is the Reform Bill of 1832. Each party, while preserving within certain limits a general consistency of purpose, has undergone many changes in its principles, professions, and modes of action with the altering circumstances of the country; and among persons who have been considered adherents of each side at any given time, there have seldom been wanting a variety of more or less distinctive shades of opinion. A division in the ranks of either party has often led the more moderate section of that party to coalesce with the opposite side; and at other times, the extreme party of innovation, dropping their connection with the Whigs, have adopted another name, as when those politicians whose desire was to have the whole institutions of the country remodelled on a democratic basis, assumed the designation of *Radical Reformers* or *Radicals*. See also **CHARTISM**. For a considerable time after the Reform Bill, the governing section of the Whig party were more disposed to maintain the principles of the changes already made, than to insist on further constitutional changes; and the principles maintained by Whigs and Tories sometimes approximated so closely that the difference seemed more one of men than of measures. Sometimes one party, sometimes the other, has appeared as the advocate of measures which have proved beneficial. In the agitation for the repeal of the Corn-laws, which lasted from 1841 to 1846, the Tories were ranked on the side of protection, and the Whigs of free trade; but the relations of the two parties had been the reverse at a former period, when Mr Pitt's advocacy of free trade between England and Ireland was opposed by the manufacturers of Lancashire, who succeeded in getting his measure postponed. During the last thirty years, the names *Liberal* and *Conservative* have to a great extent superseded the former party designations of Whig and Tory.

**WHIMBREL** (*Numenius phaeopus*), a bird of the same genus with the Curlew (q. v.), and much



Whimbrel (*Numenius phaeopus*).

resembling it in form, plumage, and habits, but of smaller size, and with a bill considerably shorter in proportion. The female, which is larger than the male, is about eighteen inches in length, the bill being about three inches and a half. The plumage of the W. is of a bright ash colour, with streaks of brown on the neck and breast. The W. is a very

widely distributed bird, being found from the north of Africa and of India to the arctic regions of Europe and Asia. It occurs also in Japan. It is a bird of passage, and visits Britain chiefly in the course of its spring and autumn migrations. A few whimbrels breed in Shetland; but the number is diminishing, the eggs being in great request as a delicacy. The flesh is also highly esteemed.

WHIN. See FURZE.

WHIN-CHAT (*Saxicola rubetra*; see CHAT), a bird very similar to the Stone-chat (q. v.), a summer visitant of Britain and of the northern parts of Europe. It is widely diffused over the British islands in summer, but nowhere very abundant. The head, sides of the neck, and upper parts of the body



Whin-chat (*Saxicola rubetra*).

are blackish brown, each feather bordered with rusty yellow; an elongated streak of white above each eye; the throat and a streak on each side of the neck white; the breast, rust-colour; a large white spot on each wing; the tail white, except the two middle quills and the tip, which are blackish brown. The colours of the female are less distinct than those of the male. The W. frequents furze (or whin) bushes. Its song is pleasant.

WHINSTONE (probably from the same root as *whine*, and meaning the sounding, ringing stone), a name popularly given in Scotland to any hard and compact kind of stone, as contra-distinguished to sandstone or freestone, and rocks of alaty structure. Thus, in most parts of Scotland, it is the common appellation of basalt, greenstone, and other trap rocks, whilst in some districts it is applied to granite.

WHIPPING. Corporal punishment by whipping, public as well as private, was formerly often awarded by the criminal law of England for minor offences, such as petty larceny, and was not unfrequently superadded to some other punishment, such as imprisonment or the pillory. In early times, and by the usage of the Star Chamber, whipping could not be competently inflicted on a gentleman.—In Scotland, sentence of whipping was also frequent, the terms of the sentence sometimes requiring it to be repeated at intervals and in different parts of the kingdom. In the last century, the Scottish burgh magistrates were in the habit of awarding sentence of whipping on summary convictions for police offences, such as broils, street outrages, and the keeping of disorderly houses; but in modern practice the competency of inflicting this sentence at common law without the intervention of a jury has been made matter of doubt. Whipping used not long since to be an occasional addition to the sentence of the Justiciary Court on persons convicted of aggravated assaults.

The infliction of corporal punishment by whipping on women was prohibited by act 1 Geo. IV. c. 57. In Act 5 and 6 Vict. c. 51, directed against attempts to injure or alarm the Queen by discharging fire-

arms in her Majesty's neighbourhood, or otherwise, the infliction of public or private whipping not exceeding three times is made part of the punishment. Act 26 and 27 Vict. c. 44 (not applicable to Scotland) authorises whipping in addition to penal servitude in convictions for robbery, assaults with intent to rob, and attempts to strangle or render insensible with the view of committing a crime, the number of strokes not exceeding 50 in the case of an adult, or 25 in the case of a boy under 16. Recent legislation, both in England and Scotland, has made various provisions for the infliction of this description of corporal punishment on juvenile culprits. Whipping of boys under 16 for various offences is authorised by the English Criminal Consolidation Act (1861); it being provided that the whipping is to be private, and not repeated more than once, and the instrument of punishment to be specified in the sentence. Similar provisions, with some additional ones, occur in 25 Vict. c. 18 as to the mode in which the same punishment is to be administered on summary convictions by justices. In Scotland, the Prisons Amendment Act, 14 and 15 Vict. c. 27, and the act 23 and 24 Vict. c. 105, which superseded it, authorise the whipping of boys under regulations made by the Lord Advocate, and approved by the Secretary of State. By act 25 Vict. c. 18, no person above the age of 16 can now be whipped in Scotland for theft, or any crime against person or property. It is a very general impression among magistrates that whipping to the moderate extent allowed by 26 and 27 Vict. has had a most salutary effect in repressing certain kinds of outrage, the apprehension of mere imprisonment, or even of penal servitude, having little efficacy in the way of prevention. Thus, personal chastisement, the oldest form of punishment for crime, has to a certain extent been resumed in the administration of the criminal law.

As regards corporal punishment in the army and navy, see FLOGGING.

WHIP-POOR-WILL (*Caprimulgus* or *Antrostomus vociferus*), a species of Goatsucker (q. v.), a native of North America, common in the eastern parts of the United States. It receives its popular name from the fancied resemblance of its notes to the words *Whip poor Will*. It is about ten inches



Whip-poor-Will (*Caprimulgus vociferus*).

long, the plumage very like that of the European goatsucker, much mottled and indistinctly marked with small transverse bands, the top of the head streaked with black, a narrow white collar on the throat. The bristles at the base of the bill are very stiff, and more than an inch long. This bird is seldom seen during the day, but seeks its food by night, catching moths, beetles, and other insects on the wing. Its flight is near the ground, zigzag, and noiseless. Its notes are heard only during the

night, and are clear and loud, so that when a few of these birds are close at hand, the noise is such that those unaccustomed to it cannot sleep. In the more southern parts of the United States, the *W.* is replaced by a larger species, the Chuck-Will's-Widow (q. v.), and on the Upper Missouri and to the west by a smaller one (*C. or A. Nuttallii*).

**WHIRLPOOL**, a circular current in a river or sea, produced by opposing tides, winds, or currents. It is a phenomenon of rare occurrence on a large scale, but illustrations in miniature may be noticed in the eddies formed in a river by means of obstacles or deflections. The two celebrated sea-whirlpools, Charybdis (see *SCYLLA*) and Malström (q. v.) are now known to be merely 'chopping seas,' caused by the wind acting obliquely on a rapid current setting steadily in one direction while the tide is flowing, and in the opposite direction when it is ebbing. During calm weather, neither of these so-called whirlpools is dangerous for large ships, but when the current and the wind are strongly in opposition, the broken swell is so violent and extensive in the Malström as to founder large ships, or drive them against the rocks. Though in neither of these two cases, formerly so much dreaded, is there any vortical action, instances of such action do actually occur in various localities, as in the whirlpool of Corrivrekin (q. v.), and in some eddies produced by opposing winds and currents among the Orkney Islands.

**WHIRLWINDS AND WATERSPOUTS.** Whirlwinds differ in many respects from the storms described in the articles *STORMS* and *TYPHOONS*. They seldom continue longer than a minute at any place, and sometimes only a few seconds; their breadth varies from a few yards to nearly a quarter of a mile; during their short continuance, the changes of the wind are sudden and violent; and the barometer is not observed to fall



Dust Whirlwinds.

(From Baddeley's *Whirlwinds and Dust-storms of India*.)

The direction of the eddy of the whirlwinds, especially when the diameter is very small, differs from the rotation of winds in a storm, in that it may take place either way—right to left, or left to right—according to the direction of the stronger of the two winds which give rise to the whirlwind. Thus, suppose it to arise from a north wind blowing side by side with a south wind, and to the west of it,

then, if the north wind be stronger, the whirl will be north, west, south, and east; but it will be in a contrary direction if the south wind be the stronger. Whirlwinds often originate within the tropics during the hot season, especially in flat sandy deserts; these becoming unequally heated by the sun, give rise to ascending columns of heated air. In their contact with each other, the ascending currents result in eddies, which draw up with them large clouds of dust, and the whole is borne forward by the wind that may happen to be blowing at the time. This is the origin of the *dust whirlwinds* of India, which have been admirably described and illustrated by P. F. H. Baddeley. These dust-storms are frequent in dry warm regions; and in the case of the *Simoom* (q. v.), which may be regarded as a succession of such whirlwinds, they appear on a scale of the most appalling grandeur.

Extensive fires, such as the burning of the prairie in America, and volcanic eruptions, also cause whirlwinds, by the conflicting currents of heated air they occasion; and these, as well as the whirlwinds already mentioned, are generally accompanied with heavy rains, hail, and electrical displays. Whirlwinds are also of frequent occurrence in France, doing great damage to the vineyards and other crops; but in Great Britain they seldom occur.

**Waterspouts** are whirlwinds occurring on the sea or on lakes. When fully formed, they appear as tall pillars of cloud stretching from the sea to the sky, whirling round their axes, and exhibiting the progressive movement of the whole mass precisely as in the case of the dust-whirlwind. The sea at the base of the whirling vortices is thrown into the most violent commotion, resembling the surface of water in rapid ebullition. It is a popular fallacy that the water of the sea is sucked up in a solid mass by waterspouts, it being only the spray from the broken waves which is carried up. Observations of the rain-gauge conclusively prove this.

What are sometimes called *waterspouts on land* are quite distinct from these phenomena. They are merely heavy falls of rain of a very local character, and may or may not be accompanied with whirling winds. They generally occur during thunder-storms, being quite analogous to severe hail-storms, from which they differ only in point of temperature. Also all the moisture that falls is the result of condensation; whereas, in the true waterspout, the rain is mixed with spray which has been caught up from the broken waves, and carried aloft by the ascending currents of the whirlwind.

**WHISKY** (Gaelic, *uisge*, water; *uisge-beatha*, commonly written *usquebaugh*, water of life), a spirit made by distillation from grain, roots, and other materials, the best being produced from barley after it has been malted, though what is termed raw grain whisky (made from wheat, oats, rice, rye, Indian corn, buckwheat, millet, &c.), after being kept for two or three years, is scarcely inferior in quality. *W.* is also made from beetroot, potatoes, beans, molasses, sugar, &c. In these cases, malt is used to a small extent. The mode of manufacture is described under **DISTILLATION**. *W.* was formerly almost exclusively manufactured in Scotland, Ireland, and the United States; but distilleries are now at work largely in England, Prussia, Sweden, France, Holland, and Belgium, the foreign spirit being, however, coarser, and only suited for fortifying wines and for methylated spirit for manufacturing purposes. According to the statistics for 1871, there was distilled in Scotland 13,813,062; in Ireland, 9,302,253; and in England 7,739,720 gallons; and of this, duty was paid in England on 10,300,597; in Scotland on 7,970,092; and in Ireland on 6,842,702 gallons—the largest amount being thus

WHISKY—WHIST.

made in Scotland; but owing to a large quantity of the spirit being removed to England duty free, to be converted by English rectifiers into British gin, duty is paid on it in England. Scotland sends to England, in excess of the quantity returned from that country, about 3½ millions, and Ireland sends upwards of a million gallons annually. The surplus not accounted for is either exported or retained in bond. Owing to legislation in 1848, the export of British spirits rose from less than 300,000 gallons very rapidly, though with great fluctuations, till in 1856—1857, it reached nearly 6 millions of gallons; but owing to continental competition, our export has fallen below 1½ million gallons annually, and the trade is now almost entirely colonial. Export is encouraged by a drawback in excess of duty of 2s., while 5d. a gallon is added to duty on foreign spirit imported (except rum, on which 2s. is charged). This allowance is to equalise the loss caused by excise restrictions to the native producer. The manufacture of whisky (as well as of other spirits) in the United Kingdom is placed under the surveillance of the Excise, and by act of parliament (6 Geo. IV. c. 80) the distiller is subjected to numerous stringent regulations, with a view to prevent the evasion of the very high duties.

Parliament attempted, about the beginning of the 18th c., to check the excessive use of ardent spirits by imposing the enormous duty of 20s. a gallon, and taxing retailers. The trade became unprofitable, and got entirely into the hands of the profligate and criminal classes. Smuggling flourished, the excise-officers were violently opposed, and informers hunted down. The act became a dead letter, and was repealed in 1742, and a moderate duty imposed.

In Ireland, the repressive system was carried to a still greater extent, a fine being imposed on the *district* in which illicit distillation was detected, and the unfortunate operatives subjected to transportation for seven years. The effect of this was, that of 10,000,000 gallons annually (1820—1823) consumed, only about 3,000,000 paid duty; frequent and murderous conflicts took place between the smugglers and the excise-officers and military, and much of the country was almost in a state of rebellion. In Scotland also, illicit distillation flourished apace at each rise of the duty; lawless violence was resorted to freely, the common people invariably sympathising with or aiding the smugglers; and in many cases the officers of excise were effectually intimidated. The difficulty of dealing with illicit distillation in Ireland and Scotland led to the adoption, beginning with 1823, of a considerably lower duty in these two countries than in England. The following table exhibits the relative rates of duty on spirits in England, Scotland, and Ireland at different periods during the present century:

	England.	Scotland.*	Ireland.
1802, . . . . .	5 4	3 10½	2 10½
1803, . . . . .	8 0		3 7
1804, . . . . .		5 10	
1811, . . . . .	10 3	8 0½	2 6½†
1814, . . . . .	..	9 4½	6 1½
1817, . . . . .	..	6 3	5 7½
1819, . . . . .	11 8½		
1822, . . . . .		2 4½	2 4½
1823, . . . . .	7 0	2 10	2 10
1830, . . . . .	7 6	3 4	3 4½
1840, . . . . .	7 10	3 8	2 8
1853, . . . . .		4 8	3 4
1865, . . . . .	8 0	4 0	6 2
1868, . . . . .	9 0	8 0	8 0

In 1858, the duty on spirits was equalised in the three kingdoms, thus putting a stop to the systematic and (as was found) irrepressible practice of smuggling spirits from Scotland and Ireland into England, which had prevailed for a long time previously. The duty was in 1860 raised to 10s. per imperial gallon, at which rate it still remains. This rate was increased to its present value by Mr Gladstone with the avowed intention of diminishing the consumption of ardent spirits; and though it does not seem to have produced this effect, neither has it, as was always the case formerly, increased the practice of illicit distillation, owing to the improved moral tone of the population, the more thorough execution of the law, and the great capital embarked in the distilling trade acting as a deterrent against fraudulent distillation on any extensive scale. Illicit distillation is now very much on the decrease, and is almost confined to Ireland. The high price of whisky, besides limiting its consumption, has had a deleterious effect in increasing the temptation to produce a cheaper drink for the poorer classes by introducing noxious materials resembling it in effect and flavour. In years when the vine crop in France is a failure, large quantities of whisky are sent to that country, and returned as French brandy. In the United States, the process of manufacture is the same as in this country, and is largely carried on in New York, Pennsylvania, Ohio, Illinois, Indiana, Kentucky, and, in a less degree, in Tennessee, Missouri, and California. A large quantity is also rectified, and reduced to alcohol, and much is exported and in part returned in the form of 'French brandy,' 'Hollands,' &c. The 'Monongahela' whisky of Pennsylvania, and that from Bourbon County, Kentucky, are considered the best in the United States, and always fetch a high price.

WHIST, a game at cards, believed to be of English origin; probably a development of the game of *trump* (or, more properly, *triumph*), which was played in England at least as early as the time of Henry VIII. Trump (or triumph) is mentioned in a sermon delivered by Latimer on the Sunday before Christmas 1529. The game of trump is also mentioned by Shakspeare punning on the word triumph, (see Douce's *Illustrations*, and *Antony and Cleopatra*, act iv. scene 12). The game of whist is not mentioned by Shakspeare, nor by any writer of the Elizabethan era.

The earliest mention of *whist* (or, more properly, *whick*) is in the poems of Taylor the Water-poet (1621). In the first edition of Cotton's *Complete Gamester* (1674), whist has no place; but it is added in the second edition (1680) as a game 'commonly known in England.' Cotton says that 'the game of whist is so called from the silence that is to be observed in the play;' and this derivation of the word has been generally accepted, and was adopted by Dr Johnson, to the extent of explaining whist to be a game requiring silence. But if the original name of the game was whick, Cotton's derivation fails. The derivation from an interjection signifying silence seems to have been taken for granted somewhat hastily.

The game was formerly played nine-up. The change to ten-up seems to have taken place in the first quarter of the 18th century. Whist played ten-up is called *long whist*. About 1785, the experiment of dividing the game into half was tried, and *short whist* was the result. The short game soon came into favour; and in 1864, the supremacy of short whist was acknowledged by nearly all the London and by many country clubs, the clubs adopting as their standard the laws of short whist as

\* The duty differed in the Highlands and Lowlands till 1814, the difference varying from 6s. to 2s. 5d., giving rise to a considerable amount of smuggling.

† For two years—afterwards doubled.

‡ Reduced to 2s. 4d. after 1834.

framed by committees of the Arlington and Portland.

Edmond Hoyle, the first writer of any celebrity on whist (commonly called the father of the game), was born in 1672—it is said in the neighbourhood of Halifax, Yorkshire, but on insufficient grounds. He was educated as a barrister. He first published his *Short Treatise* about 1742. He used to give lessons in whist at a guinea a lesson. His *Short Treatise* ran through many editions (16 or more) during his lifetime; and since his death, his works have been reproduced in numberless ways. Hoyle died in Welbeck Street, Cavendish Square, on August 29, 1769, aged 97.

The game of whist is played by four persons, two being partners against the other two. The partners sit opposite to each other. The partnership is determined by cutting. The two lowest are partners against the two highest, and the lowest has the deal and the choice of seats and cards. In cutting, the ace is reckoned lowest. Each player has a right to shuffle the pack once before each deal, the dealer having the privilege of a final shuffle. The shuffling being concluded, the player to the dealer's right cuts the pack. The dealer having reunited the packets, is bound to deal the cards one at a time, to the players in rotation, beginning with the player to his left. He turns up the bottom card (called the trump card). The deal being completed, the players sort their cards, and the player to the dealer's left (or leader) plays a card face upwards on the table. The other players follow in rotation, being bound to follow suit if they can. When all have played, the trick is complete. It is then gathered and turned over by the winning side. The highest card wins the trick. The ace is highest in playing; and the other cards reckon in the order, king, queen, knave, ten, &c., down to the deuce, or two, which is lowest. If any player cannot follow suit (i. e., has none of the suit led), he may play any card he pleases. If he plays a card of the suit turned up (called trumps), he wins the trick, unless another player also, having none of the suit led, plays a higher trump. The player who wins the trick becomes the leader for the next trick, and so on till the whole hand (consisting of 13 tricks) is played out.

After scoring, the mode of which will be presently described, the player to the last dealer's left deals in his turn; and in subsequent deals, each player deals in turn, the rotation going to the left.

After the hand is played out, the scoring is thus performed: the side who win more than six tricks reckon one for each trick above six; and the side who either separately or conjointly hold more than two of the following cards, ace, king, queen, and knave of trumps (called honours), reckon as follow: If they hold any three honours, they score two (that being the excess of their honours over their opponents'); and similarly if they hold four honours, they score four. At short whist, players who are at four, cannot score honours. The same at long whist with players who are at nine. The side who thus in one hand or in a succession of hands first reach five at short whist, or ten at long, score the game.

A game at short whist is called a single, if the adversaries have already scored three or four; a double, if they have scored one or two; a treble, if they have scored nothing. A game at long whist is a single, if the opponents have scored five or more; a double, if they have scored less. There is no treble at long whist.

A rubber consists of the best two games out of three. If the same players win two consecutive games, the third is not played. The winners of the

rubber win in points the value of the games they have won, and where the rubber has consisted of three games, the value of the loser's game is deducted. And whether two or three games are played, two points are added for the rubber at short whist; one point for the rubber at long. Thus, if at short whist A B (partners) win a single and a double, they win three points on the games, and they add two for the rubber, making five points. Had A B won the same, but C D (their opponents) won a treble, they would have to deduct three points, the value of the opponents' game, and would only win two points. Long whist is now seldom played.

Whist is a mixed game of chance and skill. The chance resides in the holding honours, and the fortune of having high cards dealt in the hand. The skill consists in the application of such knowledge as shall, in the long run, turn the chances of the cards in the player's favour. At the commencement of the hand, the first lead presents a problem of almost pure chance; but as the hand proceeds, observation of the fall of the cards, inference therefrom, memory and judgment come in, so that towards the end of the hand we are often presented with a problem of almost pure skill. It is these ever-varying gradations of skill and chance that give the game its chief interest as a scientific pastime.

In order to become a skillful player, it is necessary to bear in mind that the game is not one of any given player's hand against the other three, but a combination of two against two. In order that two partners shall play their hands to the best advantage, they must strive, as much as possible, to play the two hands as though they were one. To this end, it is advisable that they should pursue some uniform system of play, in order that each partner shall understand the plans of the other, and so be placed in the most favourable position to assist him in carrying them out. The experience of the last hundred years has developed a system of play tending to this result. Of this we proceed to give an epitome.

The first, or, as it is commonly called, the *original* lead should be from the player's strongest suit. A strong suit is one that contains either a large number of cards (four or more) or several high cards. The suit containing the largest number of cards (numerical strength) is the one to be mostly preferred. The object aimed at in opening with the strongest suit is to exhaust the cards of that suit from the other hands. When this object is accomplished, the cards of the suit which remain in the leader's hand (called long cards) obtain a value which does not intrinsically belong to them. They often become of great service, for when led, they either compel the adversary to trump, or they make tricks. And when trumps are all out, the player who has the lead makes as many tricks as he has long cards.

On the other side, by opening weak suits, there is considerable risk of sacrificing partner's strength, and of leaving long cards with the opponents.

Some players are prone to lead single cards, but experience shews that weak leads, as a rule, do more harm than good. Sometimes a trick or two is made by playing a trumping game; but the chances are that such tactics sacrifice partner's hand, and clear the suit for the adversaries.

The proper card of the strong suit to lead is, as a rule, the lowest. The intention is for the third player to play his highest, and so to assist in clearing his partner's strong suit. Moreover, if the leader keeps the best cards of his suit in his own hand, he has a fair chance of getting the lead again when his suit is nearly or quite established. But with ace and four or more small ones, it is considered best to begin with the ace, lest the ace is trumped, second

## WHIST.

round. Also, with a strong sequence in the strong suit, it is best to lead one of the sequence first, lest the adversaries win with a very small card. The following are the principal leads from sequences :

From ace, king, queen—lead king, then queen.

From ace, king, and small—lead king, then ace.

From ace, queen, knave—lead ace, then queen.

From king, queen, knave, and more than one small—lead knave.

From king, queen, knave, and one small—lead king.

From king, queen, and small—lead king.

From king, knave, ten, nine, &c.—lead nine.

From king, knave, ten, and small—lead ten.

From queen, knave, ten, and small—lead queen.

From knave, ten, nine, and small—lead knave.

After the first trick, the lead may remain with the first leader. His best play, as a rule, is to continue his suit. If the lead falls to another player, his play, as a rule, will be to open his best suit; and so on. If the lead falls to the first player's partner, he has choice of two modes of play. If he has a good strong suit of his own, as, for instance, one of those in the list above, and containing four or more cards, he would, as a rule, open it; if not, he would, as a rule, do well to continue the suit his partner first led; or, as it is commonly called, to return his partner's suit. The object is to strengthen partner by assisting to clear his strong suit.

In returning a suit, if the player has only two cards of it remaining in his hand, he should return the highest; if more than two, the lowest. The exception is, if he has the winning card, he should return that irrespective of the number of other cards in the suit. The reason of this rule is that, with but two cards of the suit remaining, the player is weak in the suit, and he is therefore bound to sacrifice his good card to support his partner. But with three or more remaining after the first round, he is strong, and is therefore justified in calling on partner to support him.

This rule of play is most important. It should be carefully observed with even the smallest cards, as it enables partner to count the situation of the remaining cards. For example: A leads a suit in which C (his partner) holds ace, three, and two. In returning A's suit, after winning with the ace, C is bound to return the three, and not the two. When C's two falls in the third round, A will know that his partner has no more of the suit. But suppose C's cards to be ace, four, three, and two. In returning the suit, C is bound to choose the two. Then after the third round, A will conclude with certainty that C has at least one more card in the suit.

Late in a hand, the considerations with regard to the lead vary. If there is no indication to the contrary, it is best for each side to continue the suits originally opened by them. But the fall of the cards may shew that it is disadvantageous to persevere in the suits first led. In such cases, the player must have recourse to other and weaker suits. The general rules to be observed here are—to choose a suit in which there is reason to infer that the right-hand adversary is weak; or—but this is less favourable—one in which the left-hand adversary is strong. In either case, if the suit chosen contains but three cards, none higher than knave, or only two cards, it is generally right to lead the highest.

The second player, as a rule, should play his lowest card, in order to preserve his strength in the leader's suit. The first trick in the suit is left to partner, who has an even chance of holding a better card than the third player. But if the second hand has a strong sequence, he should play the lowest of the sequence, by which partner's hand may be saved, and a high card still remain over the original leader.

The following are the principal sequences :

With ace, king, queen—play queen.

With ace, king, &c.—play king.

With king, queen, knave—play knave.

With king, queen, &c.—play queen.

With queen, knave, ten—play ten.

With queen, knave, and one small—play knave.

When a high card is led, it is sometimes advisable for the second player to cover it with a higher one. The shortest rule is to put an honour on an honour, if with but two or three cards of the suit. With king or queen, and four of the suit, it is better to pass an honour led.

When the second hand has none of the suit led, he should, as a rule, trump, if he has but two or three trumps; but he should not trump a losing card if he has more than three trumps, the reason of which will be explained when treating of the management of trumps.

The third hand, as a rule, plays his highest card in order to support partner in his suit. The exceptions are, with ace, queen, &c., the queen is to be played; and if partner has begun with a high card, it is often right to pass it.

The management of trumps varies according to whether the player is strong or weak in them. If strong (i. e., with four or more), they should not be used for trumping, if it can be avoided, but should be kept together, in hopes of establishing a suit, and of remaining with the long trump, with which to get the lead after the other trumps are out, and so to bring it in. Thus, if the opponents lead a losing or doubtful card, it is better, as a rule, not to trump it when holding four trumps. But if the opponents lead a winning card, it is, as a rule, better to trump it, though holding four trumps, than to pass it in hopes of bringing in a suit.

With five trumps, the chance of succeeding in exhausting the opponents' hands, and of remaining with the long trump, is so considerable, that a player having five or more trumps, should lead them; and as number is the principal element of strength, he should not be deterred from leading trumps merely because the fourth hand has turned up an honour.

With four trumps only, it is better first to lead the strong suit. When the adversaries' hands are cleared of that suit, or so far cleared that the holder of the long cards in that suit commands it, it is, as a rule, safe to lead from four trumps.

As a rule, less than four trumps should not be led from. But a player is justified in leading from weak trumps, if he holds winning cards in every suit; if the adversaries are both trumping a suit; or if the game is lost, unless partner has strength.

It is most important to return partner's trump lead at once, unless he has led from weakness; for partner, by leading trumps, declares a strong game, and it is then the best policy to abandon one's own plans, and to support his.

It follows that a player should not, as a rule, lead a card for his partner to trump, unless he has four or more trumps; for with less than four trumps, the player is weak; and if he forces his partner to trump, partner is weakened also; and the chances are that by weakening partner under such circumstances, the command of trumps will remain with the adversaries.

But a player may force his partner, although weak himself, if partner has already been forced, and has not afterwards led trumps; if partner has already declared weakness in trumps, as by trumping a doubtful card second hand; if two partners can each trump a different suit; and when one trick from partner's hand wins or saves the game.

The same considerations which make it inexpedient to force partner when weak one's-self, shew the



WHIST.

advantage of forcing a strong trump-hand of the opponents.

There are yet some general rules of play which have not been explained.

The second, third, and fourth players should always play the lowest of a sequence. The rule here given is in conformity with the play that would naturally be adopted in playing cards that are not in sequence; and by keeping to a uniform plan, players are enabled to infer what cards their partner does or does not hold. It is true that the adversaries often gain the same information; but it is found by experience that it is of more advantage to inform partner than to deceive the opponents.

As a rule, it is advisable to lead out the winning cards of partner's suit. The presumption is that he has led from his strong suit; and by leading out the winning cards, the suit is cleared for him, and his long cards are not obstructed. The reverse applies to suits led by the adversaries. It is mostly right to retain the winning cards of such suits as long as possible, in order to stop the establishment of them.

When a player has none of the suit led, he should, as a rule, throw away from his weakest suit; for by discarding from a strong suit, its numerical power is damaged. But when the adversaries have shewn great strength in trumps, it is not advisable to keep small cards of a long suit, as it is not likely that it can ever be brought in. Under such circumstances, the player should throw away from his best protected suit, and keep guards to his weaker ones.

Players should watch the cards as they are played, and endeavour to infer from them where the others lie. Thus, if a player wins a queen with an ace, it may be inferred that he has not the king, the rule being to win with the lowest; if a player leads trumps at starting, it may be inferred, as a rule, that he is strong in trumps, or has a very fine hand. By recording in this way, and by counting the number of cards played in each suit, skilled players will often, towards the close of a hand, know the position of all the important cards remaining in; and by means of this knowledge, they will be able to play the end of the hand to the same advantage as though they had seen all the cards.

And lastly, and most important of all, players should play to the score. Thus, wanting but one trick to save or win the game, a winning card should be played at once. The example is stated as for one trick; but it should always be kept in mind how many tricks are requisite to win or save the game, or even a point, and the play should be varied accordingly.

The previous condensed outline embodies the principal rules of play. For more detailed information, the reader is referred to Professor P.'s Essay on the modern scientific game (Longman, Green, &c.); *Cavendish's Principles of Whist* (De la Rue & Co.); and 'J. C.'s' Treatise on the game (Harrison). They should be read in the order here indicated.

ILLUSTRATIVE HAND.

The following example (the figures for which were kindly lent by the proprietors of *The Field*, in whose columns are given many excellent illustrative hands) is given to shew how the play at whist is conducted in accordance with the preceding general rules, and also how inferences from the fall of the cards may be drawn and used. The example is of the simplest kind, and is not intended to exhibit any fine stroke of play. A, B, C, and D are the four players; they sit round the table in the order of the letters, A C being partners against B D. A is the first leader, and D the dealer. We will suppose ourselves to be A, the score to be loveall, and D to have turned up the four of hearts.

A'S HAND.

Ace, 2 of ♠  
 Queen, 8, 7, 5 of ♥  
 9, 6, 5 of ♦  
 Queen, Knave, 7, 2 of ♣

[Note.—It is a great assistance to inexperienced players to sort the hand from a pack, and play a card to each trick, as would be done in actual practice.]

THE PLAY.

[Note.—The cards in each trick are placed in the order in which they are played, the leader's card standing first. The capital letter in front of each card shews by whom it was played.]

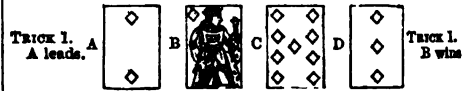

Remark.—A leads from his strongest suit. He leads the lowest card of it. (For reasons, see preceding article.)

Inferences.—C being unable to win the king, A should note that the best diamond is against him, probably in B's hand, as the rule is with ace and king to put on king second hand. (See preceding article.) Some players put on king second hand, with king and one small one; but, as a rule, the smallest should be played, unless the second hand holds a sequence. C dropping the nine, and A holding queen and knave (refer to A's hand), A concludes C to have ten or no more, the rule being to play the smallest when unable to head the trick.

It is in this way, by comparing the cards that fall with those that remain in hand, that players obtain an insight into the game to guide them in their future conduct of the hand.



Inference.—A infers clubs to be B's strongest suit. This inference does not affect the subsequent play. But it might; and, at all events, it is an inference that A ought to draw.

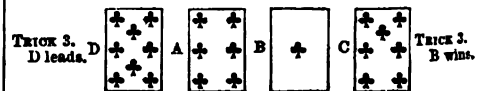

Remark.—D returns his partner's lead (for reasons, see preceding article).

Several inferences might here be drawn as to the position of the remaining clubs—as, for instance, that C has the queen; but as they do not affect the play, they are omitted, for the sake of brevity.

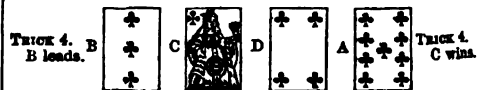

Remark.—B continues his suit (for reasons, see preceding article).



Inferences.—Spades may be taken to be C's strongest suit.

WHIST—WHISTON.

D, putting on queen second hand, probably has king (see preceding article). Also, he may be presumed not to have the knave, or he would play the lowest of the sequence.

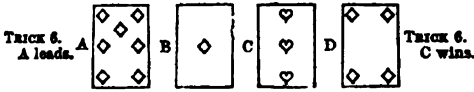

*Remark.*—A continues his suit. As a rule, with second and third best (in this case, queen and knave), one of those should be led; but C having played the nine to the king, in the first trick (refer to Trick 1, and last inference therefrom), A would part with strength unnecessarily by leading a high card, as C either has the ten or will trump.

This is an example of direct departure from common rule, owing to previous fall of cards.



*Remark.*—C continues his suit.

*Inference.*—The ten falling from B's hand, it may be inferred that he holds knave or no more.

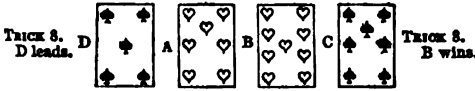

*Inferences.*—B not playing the knave of spades, C may be inferred to hold it (see inference, previous trick, and last inference, Trick 5).

As regards the lead of the spade here, it may seem at the first glance to be contrary to the rules of play advocated in the preceding article. It is a return of the adversary's lead, and up to the strong hand. But it must be remembered that whist is not a stereotyped game of rule; rules can only be given for the general case, and they have to be departed from more or less frequently as the circumstances of the hand become developed. In the case before us, any other lead would probably be worse. We may take it for granted that D is not very strong in trumps, or he would have led them. The diamond lead would enable the adversary to make the winning diamond, and then probably a small trump on the next round. The spade lead would probably enable B either to make the knave of spades or a small trump (see inference, Trick 7).

It may be asked: Why, if D is not strong in trumps, does he lead a card which may force his partner? This question may be satisfactorily answered by referring to the score (see preceding article). B D have four tricks up, and one more saves the game if either B or D holds an honour. D is justified at this point of the game in forcing his partner, even though weak in trumps. Or D may have four trumps, and so be strong enough to force at any score, but not strong enough to lead trumps (see management of trumps in preceding article).

*Remark.*—A trumps, as the knave may be with B. He chooses the seven rather than the five, in order to prevent B from making so small a card as the six by overtrumping.

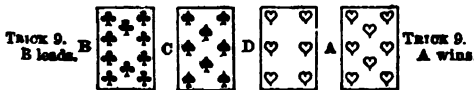

*Remark.*—B leads the thirteenth club.

*Inferences.*—It is probable, from this lead, that B

has strength in trumps, such as an honour guarded. When a thirteenth card is led before trumps have been played, it generally means that the leader has such strength as above presumed, and that he wants his partner to put on his best trump, in order to make the trumps separately. It may be, however, that the leader only wants his partner to be led up to if the thirteenth card is trumped by the fourth hand. It is a difficult point in the game for the third hand to know whether to trump a thirteenth card high or to pass it.

A further inference from this trick is, that D is probably weak in trumps, as he only puts on the six. If he trumps at all, he will most likely trump with his highest. Looking at the fact that if the trump lead comes from A, the lead will be presumably up to a weak suit, and also that A has the best diamond and his partner the best spade (see inferences, Tricks 5 and 8), A determines to lead a trump. Accordingly,



*Remark.*—Having but two of the suit, A leads the best (see preceding article).

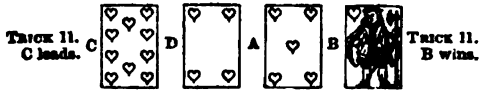

*Remark.*—C returns his partner's lead of trumps. As a rule, partner's trump lead should be returned immediately (see preceding article); but it does not follow that C is bound to return trumps here, a strengthening trump being led late in the hand. C, however, does well to return the trump in this case, as, on the whole, perhaps the best chance for the odd trick is to bring the trumps down this round, and to find A with the winning diamonds.

*Trick 12.*—B leads a diamond (he has only diamonds in hand), and A makes the knave and queen. A C score the odd trick.

WHISTON, WILLIAM, was born on 9th December 1667, at Norton, in Leicestershire, of which place his father was rector. His earlier education he received at home; subsequently, he became the pupil of a Mr Antrobus at Tamworth, and finally he went to Cambridge, where he greatly distinguished himself, chiefly as a student of mathematics. In 1690, he took his degree, and obtained a Fellowship in 1693. The year after, he became chaplain to Dr More, Bishop of Norwich; and in 1698, having been presented to the living of Lowestoft, in Suffolk, he was married to Miss Antrobus, the daughter of his old preceptor, his Fellowship being thus forfeited. Meantime, in 1696, had appeared his *Theory of the Earth*, a work which, despite, or perhaps in virtue of, the oddity of certain of its speculations, procured him a considerable reputation. That his genuine claims as a man of science were considerable, is made clear by the fact, that in 1703, by the express influence of Sir Isaac Newton, whose acquaintance he had made some years previously, he was appointed to succeed him in the Lucasian Professorship at Cambridge. On receiving this appointment, he gave up his living, and again settled himself at the university. In addition to the duties of his chair, he engaged in clerical work; and such was his success as a preacher, that he would probably have attained high position in the church, had not the development of his theological opinions led him into Arian heresy—his

frank and fearless avowal of which at once in his preaching and his writings led, in 1710, to his expulsion from his professorship and the university. In the same year appeared the most noted of his original writings, *An Historical Preface to Primitive Christianity Revived*. His subsequent prosecution in the church courts forms a curiously complicated chapter in the history of such matters. The result was, that after five years of vexatious suspense, during which the proceedings swayed hither and thither in the strangest way, they proved in the end abortive, and W. was permitted to remain formally a member of the Church of England. By many of the clergy, however, much dissatisfaction was expressed; the famous Dr Sacheverel in particular thundered from the pulpit against the delinquent, and refused to admit him to communion—an example which was followed by others. It seems significant of the social stigma attached to him in the minds of the orthodox, that when Halley, in 1720, proposed him as a member of the Royal Society, his old friend Newton successfully opposed his admission. W. himself, the most amusingly vain of men, remained indeed deeply convinced that Newton's conduct was dictated by jealousy of his superior scientific genius—a notion in which he probably found not many to agree with him. Having no ostensible means of livelihood, W. was frequently reduced to great straits; but he had kind friends, who were ready to assist him at need. In the dissemination of his religious opinions he continued unwearied; his publications on the subject were numerous; also, he occasionally delivered lectures; and he instituted a religious society, which had meetings at his own house. He also busied himself much with scientific crotchets, chief among which was a scheme for calculating the longitude, of the success of which he was assured. He died on the 22d of August 1752, at the great age of 85. Of all his numerous works, a translation of Josephus was the only one which continued for a time to perpetuate the name of its author; and of this there have been several reprints. His *Memoir of his own Life* (published in his lifetime in 3 vols. 1749—1750) is a curious specimen of self-portraiture, and conveys a very vivid image of this strange, whimsical, eccentric, but thoroughly honest and conscientious man.

WHITBY, a parliamentary borough, market-town, and thriving seaport in the North Riding of Yorkshire, on both sides of the mouth of the Esk, about 50 miles north-north-east of the city of York by railway, and 42 in a straight line. A stone bridge with a swivel, by which vessels are admitted into the inner harbour, connects the two parts of the town. Two piers, of which the west one is about 1000 feet long, run out into the German Ocean, and protect the outer harbour, and it is further protected by two inner piers, which break the force of the waves during storms. On a cliff about 350 feet high stands the parish church, which is approached from the town below by a flight of nearly 200 steps. There are dry docks for the building and repair of ships; iron and jet ornaments are extensively manufactured—the jet found in the vicinity having a world-celebrity. Alum and ironstone—the latter found in great quantities—are exported. Of late, W. has risen into importance as a watering-place. In 1872, 398 vessels of 22,329 tons entered, and 23 of 1277 tons cleared the port. Pop. (1871) 13,094.

The Saxon name of the place was Streoneshalch, but when the Danes took possession of it they called it Whitby (white town), just as they changed the Saxon Northweorthing into Deoraby or Derby. The termination *by*, which is characteristic of Danish settlements, is a corruption of the old Norse *byr*,

modern Icelandic *boer*, a dwelling, farmstead, town. In Devon the suffix occurs in the form *bere* or *beer*, as in Rockbere, Larkbeer.

WHITCHURCH, a small market-town of Shropshire, on a height, 20 miles north-north-east of Shrewsbury by railway. Trade in malt, hops, and shoes is carried on. Pop. (1871) 3696.

WHITE, GILBERT, author of the *Natural History and Antiquities of Selborne*, was born at Selborne, in Hampshire, on July 18, 1720. Educated at Oriol College, Oxford, he received his M.A. degree in 1746, and in 1752 he was made a senior proctor of the university. At an early period of his life he retired to his native village, to indulge his taste for literature and natural history; and there he died on June 20, 1793. His charming *Natural History and Antiquities of Selborne*, which has made W. an indisputable English classic, was published in 1789. Probably no book on natural history has been more frequently reprinted. Among the various editions may be mentioned that of E. T. Bennet, and the one by Frank Buckland, with a chapter on antiquities by Lord Selborne (1875). After W.'s death, Dr Aikin published a selection from his natural history journal, under the title *A Naturalist's Calendar*.

WHITE, HENRY KIRKE, was born on the 21st March 1785, at Nottingham, in which place his father was a butcher. At the age of 15 he was apprenticed to an attorney; and, while in his business he shewed exemplary diligence, his leisure-hours were passionately devoted to intellectual pursuits, and especially to the cultivation of poetry. He also became a member of a literary society in Nottingham, and began to attract notice by his fluency and ability as a speaker. To the *Monthly Mirror* he was wont to send contributions, and the merit of his verses drew to him the attention of Mr Hill, its proprietor. Acting on the advice of this gentleman, and Mr Capel Lofft, who also took a generous interest in him, he published in 1804 a small volume of poems, which was cruelly treated by the critics, and found little acceptance with the public. It was the means, however, of securing him influential friends, notably Southey, and the Rev. Mr Simeon, through whose influence a sizarship in St John's College, Cambridge, was procured for him. In his studies he highly distinguished himself; but the ardour with which they were pursued speedily proved the ruin of a constitution at all times delicate; consumption rapidly developed itself, and he died October 19, 1806. The year after, two volumes of his *Remains* were published by his friend Southey, to whom his MSS. had been intrusted, prefaced by a pleasing *Memoir of the deceased poet*. W.'s poetry, however, is now almost forgotten.

WHITE, REV. JOSEPH BLANCO, was born at Seville, in Spain, on 11th July 1775. His father was a merchant there of Irish parentage, who had married a Spanish lady of old Andalusian family. Finding his father's counting-house on trial not at all to his mind, he quitted it to prepare himself for holy orders, and in 1799 he was ordained a priest. But born with a mind curiously restless and inquisitive, he ceased in no long time to find himself at home in the Romish communion; and in 1810 he came to England, which he never afterwards quitted. Joining himself to the English Church, he seems to have meditated becoming one of its clergymen; an intention which it was quite as well he did not carry out, inasmuch as his speculations rapidly led him to results not recognised by English orthodoxy. On coming to England, he settled himself in London, where for some years he conducted a monthly Spanish paper called *El Español*. On the cessation of the Peninsular War in 1814, this publication

ceased also, as having no longer a *raison d'être*; but meantime its services to the government of the day had been such as to secure for its editor a pension for life of £250 per annum. Subsequently, Mr W. lived chiefly in London, employed as a man of letters. Though in literary circles recognised as a man of fine talent, and known as a contributor to the *Quarterly* and *Westminster Reviews*, and other high-class periodicals, he scarcely succeeded in making a permanent impression on the public by any of his more formal publications. Of these, the most important were: *Letters from Spain* (1822), contributed some years before to the *New Monthly Magazine*; *Practical and Internal Evidence against Catholicism* (1825); *Poor Man's Preservation against Popery* (1825); and *Second Travels of an Irish Gentleman in Search of a Religion* (2 vols. 1833). He died on the 20th May 1841, in Liverpool, whither he had removed some years before. In 1845 there was given to the world, as his legacy to it, by much his most striking and valuable work, *The Life of the Rev. Joseph Blanco White, written by himself; with portions of his Correspondence*; edited by John Hamilton Thom (London, 3 vols. 8vo). This book, at the time of its appearance, excited a good deal of interest, and is still eminently worth referring to. The curious picture it presents of a mind at once pious and sceptical, longing and sorrowing after a truth which it can nowhere find, or finding, contrive to rest in, has, in the present unsettled state of religious opinion, a very particular significance. Poor W.'s life-long 'search for a religion' seems not to have been a successful one, and to have landed him at the last in a condition of nearly entire scepticism.

**WHITEBAIT**, a small fish, called by Valencianes *Rogenia alba*, and for which he constituted the genus *Rogenia* as a distinct genus of the Herring family (*Clupeidae*), but which is now generally regarded by naturalists as merely the fry of the herring. The W. fishery is actively prosecuted on

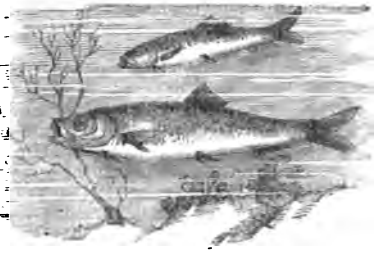

Whitebait.

some parts of the British coast, particularly in the estuary of the Thames, where the W. is very abundant in spring and summer, beginning to appear in the end of March or early in April. Adult W. are caught on the coasts of Kent and Essex during winter, and in this condition are about six inches in length. W. is also found in the Forth. It is much in request as a delicacy for the table, forming a favourite dish of epicures. At the time when ordinarily captured, W. are only from an inch and a half to four inches in length. They are caught by means of bag nets sunk four or five feet below the surface of the water. For several months they continue to ascend the river in shoals with the flood-tide, and descend with the ebb-tide, not being able to live in fresh water. They are fried with flour or crumbs; they are often laid on a napkin and sprinkled with fine flour and a little salt, rolled about till well covered with flour, and then thrown

into a pot of boiling lard, where they remain till they are of a pale straw colour. Londoners resort to Greenwich and Blackwall to enjoy W. dinners. It has become the practice for her Majesty's ministers to repair to Greenwich for a W. dinner every year before the prorogation of parliament in autumn. Some of the corporations of London indulge in a similar annual festivity. The W. has the body more compressed than the mature herring; the belly is serrated; the lower jaw is longer than the upper; the scales are very soft, small, and thin, and very easily rubbed off; the colour is silvery white, greenish on the back. The food of the W. seems to consist of minute crustaceans. It seems probable that the fry of all the British *Clupeidae*—the pilchard, the sprat, and the shad—are indiscriminately taken and used like the fry of the herring, under the name of whitebait.

**WHITEBOY**, the name of an illegal association of the peasantry in Ireland, which for a long series of years was the fruitful source of agrarian outrage, sometimes of a very revolting and sanguinary character. The association had its origin in the early years of the reign of George III.; and first took an organised form in the county of Tipperary, where it appeared in the shape of a united resistance to an attempt on the part of certain proprietors to enclose and appropriate lands up to that time common. The movement at the beginning was confined to throwing down the newly erected fences, and destroying the enclosure, from which circumstance the rioters were in the first instance called 'Levellers'; but their views soon extended further, and they addressed themselves to the redress, first, of the oppressive exactions of tithes, and afterwards of various other grievances, especially those connected with the tenure of land. The name of Whiteboys was given to them in consequence of their wearing white shirts in their nightly expeditions. Many acts of cruelty and outrage having been committed, a special commission was issued in 1762 for the trial of the offenders; but the repression was only partial and temporary, and Whiteboyism reappeared more than once in the southern province. In 1787, a new association, the members of which called themselves 'Right-boys,' appeared in the same district, and was made the subject of discussion in the Irish parliament. The conflicts of the northern Orangemen (q. v.) and Ribbonmen (q. v.) for a time drew attention away from the minor discontents of the south; but the same spirit of secret combination has continued among the peasantry down to the present day. The Shanavests, Caravats, Rockites, Terry Alts, and other more obscure or more local denominations, must be regarded as embodiments of the very same discontent, which has long held its ground among the poorer classes in Ireland, and which, although undoubtedly exaggerated and embittered by the recollections of hereditary wrong inseparable from the condition of a conquered people, are held, even by politicians of moderate views, to have much justification in the social condition of the people, and in certain striking anomalies of the legislature in reference to Ireland. The ground of discontent furnished by the endowment and establishment of the church of a small minority of the population, has now ceased to exist. See FENIAN SOCIETY in SUPP., Vol. X.

**WHITE COLOURS.** The principal white pigments used by painters are: (1) *White Lead* (see LEAD), which is not only used as a colour, but forms the body of most oil-paints; (2) *Derbyshire White*, which is sulphate of baryta; (3) *Pearl White*, or trisnitate of bismuth; and (4) *Zinc White*, or hydrated oxide of zinc.

WHITEFIELD, GEORGE, one of the founders of Methodism, was born in the Bull Inn, at Gloucester, on the 16th December 1714. He was educated at the grammar-school of his native town, at which he appears to have distinguished himself, especially by elocutionary displays at the annual visitations. On leaving school, he was for a time engaged assisting in the business of his mother, the hostess of the Bull Inn; but he obtained admission as a servitor at Pembroke College, Oxford, when in his 16th year. About three years earlier, John and Charles Wesley had laid, in the university of Oxford, the foundations of Methodism—a system which, at first, resembled the rule of a religious order more than the bond of a religious sect; requiring from its professors ascetic observances and devotion to works of piety and charity. It was not till he had been upwards of a year at the university that W. became associated with the Methodists. He at once made himself remarkable among them for zeal, for the austerity of his asceticism, for labour too great for his strength among the sick and the prisoners in the jail. His health gave way, and he had to go home, when his native air soon restored him; after which he carried on at Gloucester the same pious and self-denying practices which he had begun at the university. His conduct drew upon him the attention of the bishop of the diocese, who offered, though W. was only twenty-one, to admit him immediately into orders. The offer was accepted, and W. was ordained a deacon in 1736, before he had taken his degree. He preached his first sermon in Gloucester Cathedral, and the effect of it was remarkable. The vehemence and earnestness of his oratory deeply moved the audience; and five persons are said to have been driven mad with fear and excitement. Complaints were made to the bishop; but this good man gave no heed to them—simply saying that he hoped the madness would last to the following Sunday. During the next two years, W. preached with similar results in various churches in England.

Meanwhile, Wesley had been in America establishing missions among the colonists; and in 1738 he desired W. to join him, a request that was immediately complied with. W. had to go to London to make arrangements for his journey; and this visit, though not his first, seems first to have made him known to the inhabitants of the metropolis, upon all classes of whom—fine gentlemen like Chesterfield, and cool sceptics like Bolingbroke, as well as the more mobile crowd—he afterwards made an impression such as, probably, no other preacher ever produced. His success in London was immediate, and much exceeded all that had befallen him previously. The doors of the church in which he was to preach were besieged before the dawn; the unlighted streets in the early morning were filled with persons carrying lanterns, making their way to the place of worship many hours before the time of service. This lasted until his departure for America. He was hereafter to be almost as closely connected with evangelical labours in America as in England itself; but on this first occasion, his stay was short—only a few months. He returned to be admitted to priest's orders, and to collect funds for the establishment of an orphanage in Georgia. He soon went back to America, but not before a beginning had been made of his split with the English Church, whose clergy he offended by preaching in the open air, whether he got permission from the parish clergyman or not, and by deviating, whenever he thought fit, from the liturgy of the church. But the remarkable and beneficial effects of his preaching on the rude miners and others who

flocked to hear him, consoled him for clerical censures; and after this, he seems to have preached almost by preference in the open air. His second visit to America occupied nearly two years. He came back in 1741.

It was about this time that doctrinal differences led to his separation from John Wesley—both of them being by this time disowned by the Established Church. Wesley believed and preached the doctrine of universal redemption; W. was a rigid Calvinist. Each thought his belief of the utmost importance, and in the end, each excommunicated the other. W.'s supporters now built him a large shed at Moorfields, near Wesley's chapel—which, being temporary, was known as the Tabernacle; and his preaching gathered immense audiences around him. But he had no talent for organisation; and as soon as he went away on his frequent and protracted journeys, his supporters began to disperse. But that the Countess of Huntingdon, a lady of wealth and of abilities, became a convert to his views, W., in all probability, would not have founded a sect. But this lady appointed him her chaplain; she built and endowed chapels to maintain his Calvinistic doctrines; and thus a slight memorial of W.'s preaching, though it more directly commemorated the zeal and energy of Lady Huntingdon, remains in what is known as the Huntingdon connection.

One of his most famous missionary journeys was that which he made to Scotland in 1741. He went to Scotland on the invitation of Ralph and Ebenezer Erskine, well known as leaders of a secession from the Church of Scotland; but his notions were too catholic for his friends; he was as ready to preach in a parish church as to a seceding congregation, and more ready still to preach in the open air; and the Erskines soon differed from and separated from him. That the impression he made upon the people of Scotland was very strong and very general, may be inferred from the fact that the leading corporations of Scotland—Edinburgh, Glasgow, Aberdeen, Stirling—admitted him to their citizenship. At Cambuslang, in Lanarkshire—a mining district, mainly inhabited by rude colliers, then *adscripti glebe*—his preaching produced one of the most remarkable 'revivals' of modern times; many thousands were stricken with concern about their souls, and violent physical manifestations followed upon their excitement—foaming at the mouth, bleeding at the nose, convulsions—which, by many who read of them, were attributed to Divine influence, by others to the devil. It was on his return from this visit to Scotland, that W., making a stay in Wales, met and married a widow, a Mrs James. His marriage, like that of Wesley, was not a happy one; and it is recorded that the death of his wife, when it occurred, 'set his mind much at liberty.'

To America, W. paid seven visits, several of which lasted for two or three years. He set out for America for the last time in 1769. He was ailing at the beginning of the voyage; he was ill at the end of it; and he died somewhat suddenly not long after his arrival in America, at Newberry, near Boston, on the 30th September 1770. A collection of his sermons, letters, and controversial writings was published in the following year (*The Works of the Rev. George Whitefield*, 6 vols. London, 1771); and in 1772 were published his memoirs, by Dr Gillies. His writings do not sustain the impression which would be derived from the accounts of his preaching. They shew him as a man of somewhat slender talent and common-place quality of mind; quite unlearned; entirely free from the casuistical turn, as well as deficient in the worldly

knowledge and prudence, for which Wesley, like many other enthusiasts, was pre-eminent. His success as a preacher seems to have been in no small degree due to a sonorous but expressive voice; no doubt it was mainly due to the earnestness of his faith, to the fluency and rude strength of his homely language, and to that vehemence and impetuosity of nature which, perhaps, is the thing most distinctive of the orator. Of the *Memoirs of the Life and Character of George Whitefield*, by J. Gillies, D.D., of the College Church, Glasgow, originally published at London in 1772, subsequent editions, containing additional matter, appeared in 1798, in 1811, 1812, 1813, and in 1827. An anonymous *Life of George Whitefield*, founded upon his journals and letters, and borrowing largely from the work of Dr Gillies, appeared at Edinburgh in 1826. *Whitefield's Life and Times*, by Robert Philip, D.D., was published at London in 1837; and there has since appeared a full memoir, under the title *George Whitefield: a Light rising in Obscurity*, by Andrews (Lond. 1864).

**WHITEFISH** (*Coregonus albus*, see COREGONUS), a fish of the family Salmonidae, of the same genus with the Gwyniad, Vendace, Powan, Pollan, &c. It is found in the lakes and large rivers of North America, from the St Lawrence and its tributaries to the Arctic regions, and is one of the most valuable of American fresh-water fishes, abounding over a great extent of country, and being excellent for the table. It is the *Attihawmeg* of the north-western Indians. The body is elongated but thick, the head small and the muzzle pointed, the tail forked, the scales large. The mouth is destitute of teeth. It sometimes attains a length of two feet and a half, and weighs ten pounds. It is bluish-gray on the back, lighter on the sides, and white below. It spawns in October, proceeding from the lakes up the rivers for this purpose. It usually swims in shoals, like its small British congeners. It feeds chiefly on insects and entomostraca. It is caught by nets, which are often spread under the ice, and the fishery is attended with much labour and exposure. The Indians sometimes spear it through holes in the ice. The W. forms the principal food of many Indian tribes, and of the fur-traders, during great part of the year. It is often salted by them. The flesh is bluish-white, changing to a pure white when boiled, whence the name. The most southern lake in which the W. is found is Lake Champlain. No fresh-water fish better deserves to be made the subject of piscicultural experiments than the W., and its acclimatisation in Britain would probably be as easy as it is desirable.—An allied species, the OTSEGO W. (*C. Osego*), found in Lake Otsego, is also of exquisite flavour; but it is now rare.

**WHITE FLUX.** See FLUX.

**WHITE GUNPOWDER** is a mixture that was at one time employed in blasting, but is now scarcely ever employed in consequence of the danger attending its preparation, and the facility with which it explodes by friction. Its ingredients are chlorate of potash, dried ferrocyanide of potassium, and sugar.

**WHITEHALL**, a village of New York, U.S., at the head or southern extremity of Lake Champlain, and termination of the Troy and Champlain Canal, with important railway and steam-boat connections, and water-power for saw and flouring mills, machine woollen and carpet factories. It was settled by Major Philip Skene in 1761, and called Skeneborough; in the war of 1812 it was an important military depot. Pop. in 1870, 4322.

**WHITEHAVEN**, a parliamentary borough and seaport of Cumberland, near the point where the estuary of the Solway Firth joins the Irish Sea, 40 miles south-west of Carlisle by railway, 36 in a straight line, and 34 miles east-north-east of Ayre Point, the northern promontory of the Isle of Man. It contains a market-house, custom-house, baths, and a theatre, as well as the West Cumberland Infirmary. The harbour is commodious, but is now dry at low water. The sources of the prosperity of the town are its vicinity to extensive collieries—some of which extend beneath the town and stretch out under the sea—and the extraordinary abundance and richness of the hematite iron ore found in the neighbourhood. Coal and iron mines are numerous, there are iron-smelting works, and iron and brass foundries—the manufactured iron being shipped mostly to the Welsh and Irish markets. There are dry docks for the building and repair of vessels; and rope-making and the manufacture of thread and sail-cloth are important branches of trade. W. returns one member to the House of Commons. In 1872, 3493 vessels, of 311,899 tons, entered and cleared the port. Pop. (1871) 18,451.

**WHITE LADY**, a being who, according to popular legend, appears in many of the castles of German princes and nobles, by night as well as by day, when any important event, whether joyful or sad, but particularly when the death of any member of the family is imminent. She is regarded as the ancestress of the race, shows herself always in snow-white garments, carries a bunch of keys at her side, and sometimes rocks and watches over the children at night when their nurses asleep. The earliest instance of this apparition spoken of was in the 16th c., and is famous under the name of Bertha of Rosenberg (in Bohemia). The W. L. of other princely castles was identified with Bertha, and the identity was accounted for by the intermarriages of other princely houses with members of the house of Rosenberg, in whose train the W. L. passed into their castles. In the castle of Berlin she is said to have been seen in 1628, and again in 1840 and 1850. The most celebrated in Britain is the W. L. of Avenel, the creation of Sir Walter Scott. It was long a common belief in the Highlands that many of the chiefs had some kind spirit to watch over the fortunes of their house. Popular tradition has many well-known legends about white ladies, who generally dwell in forts and mountains as enchanted maidens waiting for deliverance. They delight to appear in warm sunshine to poor shepherds or herd-boys. They are either combing their long hair, or washing themselves, drying wheat, beating flax, or spinning; they also point out treasures and beg for deliverance, offering as reward flowers, corn, or chaff, which gifts turn in the instant into silver and gold. They wear snow-white, or half white half black garments, yellow or green shoes, and a bunch of keys at their side. All these and many other traits that appear in individual legends may be traced back to a goddess of German mythology who influences birth and death, and presides over the ordering of the household. Still more distinctly the appellation W. L. and the name Bertha point back to the great goddess of nature, who appears under various names, and who, as *Bertha* (i.e. the brilliant, shining, white), held her circuit on Twelfth-night and revealed her power. When the legend goes on to say that the Bohemian Bertha of the 15th c. promised the workmen of Neuhaus a sweet soup on the completion of building the castle, and that this soup, along with carp, is still given in remembrance of it to the poor on Mann'dy Thursday, we recognise again the festival dishes consecrated to Bertha, such as fish, oatmeal

gruel or dumplings, &c., which it is still customary to eat about the time of Twelfth-night and Christmas in most districts of Germany.

**WHITE LEAD.** See **LEAD.**

**WHITE MOUNTAINS**, a mountain-chain of New England, U.S., regarded as an outlier of the Appalachian range, commences at the headwaters of the Aroostook River, in Maine, where its first summit is Mount Katahdin, and extends in a broad plateau, from 1600 to 1800 feet high, west by south nearly across New Hampshire, where it has twenty bold peaks, with deep, narrow gorges, wild valleys, beautiful lakes, lofty cascades and torrents, forming the 'Switzerland of America,' and a favourite resort of summer tourists. Mount Washington, the highest summit in New England, 6285 feet, has a practicable carriage-road and a hotel on its summit; Mount Pleasant, the second of the group, is 4712 feet; the lesser are named Franklin, Monroe, Jefferson, Adams, Madison. In the Franconia group are Lafayette, 5500 feet, and Mooschillock, 4636. These mountains furnish the chief sources of the Connecticut, Merrimack, and Androscoggin rivers. The rocks are ancient metamorphic, with naked granite and gneiss. The Ammonoosuck River falls 5000 feet in 30 miles, the Androscoggin 200 in a mile. Five narrow and precipitous notches seem to have been rent in the mountains, and give passage to as many rivers.

**WHITE PRECIPITATE.** See **MERCURY.**

**WHITE RIVER**, a river of Arkansas and Missouri, U.S., rises in the Ozark Mountains, flows north-east into Missouri, then turning east and south-east into Arkansas, drains the north-eastern portion of the State, and flowing southerly, empties itself into the Mississippi near the mouth of the Arkansas. It is 800 miles long, and navigable 350 miles.

**WHITE SEA** (Russ. *Bjeloje-More*), an arm or great bay or inlet of the Arctic Ocean, which, between Cape Kanin on the Kaninskaia Peninsula, and Cape Sviatoi on the Kola Peninsula, penetrates the Russian government of Archangel southwards to lat. 64° N. At its entrance between Capes Kanin and Sviatoi it is 100 miles broad; after penetrating the land 150 miles in a south-easterly direction, it narrows to a width of 35 miles; but after sweeping south for 200 miles, it again considerably widens, forming in the north-west the Gulf of Kandalak, and in the south and south-east the great Gulfs of Onega and Archangel or Dwina. The W. S. covers an area estimated at 47,000 sq. m., and the length of its coast-line is over 1000 miles. The coasts in the north and east are mountainous, in other places they are mostly low, and abound in lakes, which communicate with the sea by rivers. The greatest depth of the W. S. is 1133 feet. From the middle of August ice forms on the coasts sometimes to the width of 30 miles, and is not melted till the following July.

**WHITE SULPHUR SPRINGS**, a watering-place in Virginia, U.S., on Howard's Creek, 205 miles west of Richmond. Pop. (1870) 976. It has hotel accommodation for 1500 guests. The spring is in the lowest part of a beautiful valley, and is covered by a dome supported by 12 Ionic columns, and surmounted by a statue of Hygeia: it is 2000 feet above tide-water; yields 30 gallons per minute of water at 62° Fahr., impregnated with sulphates of lime, soda, magnesia, carbonate of lime, chlorides of calcium and sodium, iron, iodine, sulphur, carbonic acid, sulphuretted hydrogen, oxygen, nitrogen. It is considered efficacious in dyspepsia, liver diseases, gout, rheumatism, and diseases of the skin and

kidneys. The Red, Salt, and Blue Sulphur Springs, at a distance of 22 to 24 miles from the above, are also much resorted to.

**WHITE SWELLING.** See **JOINTS, DISEASES OF.**

**WHIT'THROAT** (*Curruca cinerea*), a bird of the family *Sylviadae*, a summer visitant of Britain; plentiful during summer in the greater part of England and in Ireland, but comparatively rare in Scotland. It is also common during summer in the south and middle of Europe, and is found even in the north. It places its nest in a low bush, or among a tangled mass of brambles and weeds. Its food consists both of insects and berries. Its song is not



Whitethroat (*Curruca cinerea*).

very sweet, but is delivered with great energy, and it seems to vie with other birds in singing, refusing to be outdone. It is very lively and amusing as a cage-bird, and very easily tamed. The whole length of the W. is 5½ inches. Its plumage is brown, of various shades; the breast and belly brownish-white, tinged with rose-colour in the male.—The Lesser W. (*Curruca sylvicola*) is a species of much rarer occurrence in Britain. The Whitthroats belong to the same genus with the Blackcap (q. v.) and the Garden Warbler (*C. hortensis*), which is not uncommon in Britain, and almost rivals the Blackcap in the richness of its notes.

**WHITE VITRIOL.** See **ZINC.**

**WHITE-WASH**, slaked quicklime, reduced to the consistency of milk by means of water. It is used for colouring walls, and as a disinfectant. If merely for colouring, a little size is added, but not when used for sanitary purposes.

**WHITE-WOOD BARK.** See **CANELLA.**

**WHITGIFT, JOHN**, the third Protestant Archbishop of Canterbury, was born at Great Grimsby, in Lincolnshire, according to one account in 1530, according to another in 1533. His father was a merchant, and is said to have belonged to a family long established in Yorkshire. His early years were passed within the Abbey of Wellow, near Grimsby, of which his uncle was the abbot; and from that he went to St Antony's School in London, a religious house then in great reputation. About 1548, he was entered at Queen's College, Cambridge. After a short time, he removed to Pembroke Hall, of which he continued a member till 1555, when he was elected a Fellow of Peterhouse. He took orders in 1560, and as he shewed a remarkable talent for preaching, the Bishop of Ely appointed him his chaplain, and gave him the living of Feverham. In 1563, he was appointed Lady Margaret's Professor of Divinity. In 1567, he became Master of Pembroke Hall; and in the course of the same year, Queen Elizabeth, who admired his preaching, and had made him one of her chaplains, appointed him to the Mastership of Trinity College. About

this time, he also obtained the Regius Professorship of Divinity, and took his Doctor's degree. He was appointed Dean of Lincoln in 1571, Bishop of Worcester in 1577, and Archbishop of Canterbury in 1583. He at one time held together—under a dispensation from the archbishop—the Deanery of Lincoln, the Mastership of Trinity, the Regius Professorship of Divinity, and the living of Feversham; and the dispensation enabled him to hold, along with these, any other benefice whatever. This cannot have been often paralleled, even in the history of pluralities. Of course, the man so favoured had rendered and was rendering considerable services to the church and to the crown.

His first work, on becoming Master of Trinity, was upon a revival of the statutes of the university. He obtained such powers for the heads of houses as enabled them to eject from the Lady Margaret's Professorship the able and energetic Puritan, Cartwright, on the score of his Calvinistic creed. He afterwards, at the request of Archbishop Parker, published an answer to an 'Admonition of Parliament' (drawn up by a clergyman named Field), presented to the House of Commons on behalf of the Puritans, in which it was maintained that, in matters of doctrine and discipline, the church should admit nothing as authoritative but what was contained in the Word of God. This work was published in 1572. It has always been held that in it W. vindicated the position of the Anglican Church against the Puritans with no less ability than Bishop Jewell shewed in defending it against the Romanists. He was answered by Cartwright on behalf of the Puritans; he replied, and Cartwright rejoined; and as the works on either side were revised by the most learned and eminent men of the two parties, they give an excellent view of the state of opinions in the Anglican Church at this time. After becoming primate, W. laboured assiduously to secure uniformity of discipline in the church. He had the full confidence of Queen Elizabeth, who placed all the church patronage of the crown, including the bishoprics, in his disposal, and he was armed with full powers for carrying out his design. He required the clergy not only to subscribe to the Royal Supremacy, the Liturgy, and the Thirty-nine Articles of the Church, but also to a set of additional articles framed mainly with the view of purging the church of Puritanism. The bishops were required to administer those tests; and the clergymen who refused to accept them were deprived of their livings. This measure was harshly conceived; but W. is said to have been a kindly man, and to have used his authority over the clergy gently, especially in his later years. He was made a Privy Councillor in 1586, and in that capacity drew up a set of statutes for cathedral churches, to make their services conform to the principles of the Reformation. He was offered the chancellorship by Queen Elizabeth, but he declined the office. On the accession of King James, he seems to have been much alarmed for the stability of the system which he had spent his life in rearing; and though the monarch treated him with the utmost observance, anxiety upon this account is said to have hastened his end. He died of paralysis on the 29th February 1603. He is undoubtedly entitled to rank with the ablest and most distinguished prelates that have adorned the English Church. He founded a magnificent hospital and a grammar-school at Croydon.

WHITING (*Merlangus*), a genus of fishes of the family *Gadidae*, differing from the cod, haddock, and their congeners (*Gadus*, or *Morrhua*) in having no barbule on the lower jaw, and also in their more slender form, which adapts them for pursuing their prey more actively and further from the bottom of

the sea. The COMMON W. (*M. vulgaris*) is abundant on many parts of the British coast, particularly on the western coasts of Britain, and on the coasts of Ireland; on the northern coasts of Scotland it is comparatively rare. It not unfrequently attains a weight of three or four pounds—although the whittings brought to market are seldom of this size; but a W. has been taken of seven pounds weight. The head and body are compressed; the deepest part is at the vent, which is opposite the middle of the first dorsal fin; the upper jaw extends a little beyond the lower; both jaws have long sharp teeth, and there is a triangular patch of teeth on the palate. The scales are small. There are three dorsal fins, and two anal fins; the tail-fin

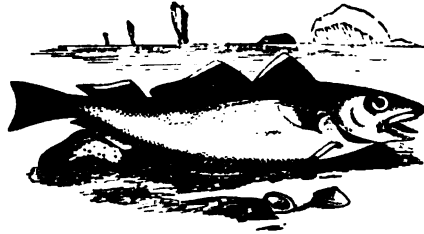

Whiting (*Merlangus vulgaris*).

is even. The colour is dusky yellow on the back, the sides paler, the belly silver white; there is a black spot on the upper part of the root of the pectoral fin. The W. is a voracious fish, preying on molluscs, worms, crustaceans, and small fishes. It is caught chiefly by hand-lines and long lines; mussels and pieces of cuttle-fish are very generally used for bait. It is in high esteem for the table, and is regarded as particularly delicate and easy of digestion. The flesh is of a pearly whiteness, whence the English name. It very soon suffers change, however, and is in good condition only a short time after being caught; but great numbers of small whittings are sent to market, salted, and dried, under various names.—Another species of W., COUCH'S W. (*M. albus*), is sometimes taken on the British coasts. It is more abundant in the Mediterranean. It is more slender than the Common W., and the under jaw is a little longer than the upper. The Coal-fish (q. v.) and the Pollack (q. v.) also belong to the genus *Merlangus*.

WHITING is an impure carbonate of lime, prepared by grinding and then washing chalk, so as to separate the coarser particles from the finer ones, which are collected in masses, and dried. It is extensively used for size-painting, and as an article of household economy, for cleaning plate; and on emergency, may be employed as an antidote (in suspension in milk) in cases of poisoning with oxalic, or one of the mineral acids.

WHITFLOW, or PARONY'CHIA, is a painful inflammatory affection of the phalanges of the fingers, almost always proceeding to suppuration. There are several varieties of this affection, according to the texture primarily attacked; thus, it may be situated in the skin, the cellular (or connective) tissue beneath the skin or under the nail, the tendons or tendinous sheaths running along the fingers, or the periosteum. If the skin be the seat of inflammation, vesicles appear, which soon discharge pus, after which relief is rapidly afforded. Such cases require little care or attention, and give rise to hardly any constitutional disturbance. If the cellular tissue is the primary seat of inflammation, there is a painful sensation of tenseness and



throbbing of the part, and often considerable febrile disturbance, until the pus can be evacuated. Although this form is painful, no serious mischief is to be apprehended. When, however, the tendons and their sheaths, or the periosteum, are affected, a much more serious form of whitlow is developed, which has been already discussed in the article TSWOON. In this form, the suppuration may extend up the arm, and occasion destruction of the joints, and even death.

Whitlow may originate either spontaneously, or after an external injury, such as a prick from a needle, thorn, &c. In the treatment of the milder forms, the finger or thumb should be held for half an hour or longer in water as hot as can be borne, after which lunar caustic should be rubbed freely over the painful surface; and if there are any febrile symptoms, the patient may take a powder, consisting of 4 grains of calomel, 3 of James's Powder, and 3 of Dover's Powder, at bedtime, to be followed in the morning by an ordinary black draught. The hot local baths should be carried on till matter shows itself; and as soon as its presence and seat are determined with certainty, an incision should be made, to admit of its escape. Even if suppuration has not taken place, a free incision into the inflamed part often gives great relief. There is a very pernicious popular idea that the application of cobblers' wax, or some other stimulating substance, will draw the inflammation to the surface, and bring the whitlow 'to a head.' There is reason to fear that a considerable number of fingers are annually sacrificed to this delusion. As it is not always easy to state in an early stage how a whitlow may turn out, it is advisable that surgical aid should always be at once obtained.

WHITNEY, ELL, American inventor, was born at Westborough, Massachusetts, December 8, 1765, and was educated at Yale College, where he paid his expenses, partly by school-teaching, partly by mechanical labour. Having graduated in 1792, he went to Georgia as a teacher; but finding a generous patron in the widow of General Greene, of the Revolutionary army, he resided on her estate, and studied law. The cotton culture at this period, especially that of the best kind, the 'green seed,' was limited by the slow and difficult work of separating the cotton from the seed by hand; but Mrs Greene told her complaining neighbours that she was sure W. could help them out of their trouble, for he could make anything. At their desire, he set to work under great disadvantages, for he had to make his own tools, and even draw his own wire; but the reports of his success prompted some lawless people to break into his workshop, and steal his machine, and get others made before he could secure a patent. He, however, formed a partnership with one Miller in 1793, and went to Connecticut to manufacture cotton gins; but the lawsuits in defence of his rights took all his profits, and 50,000 dollars voted him by the state of South Carolina. Finally, in 1798, he got a government contract for the manufacture of firearms, and was the first to effect the division of labour, by which each part was made separately. He made a fortune by this manufacture, carried out with ingenious machinery at Whitneyville, Connecticut; while he had but barren honour from the gin, one of the most important of the whole series of inventions connected with the cotton manufacture. He died at New Haven, January 8, 1825. See COTTON.

WHITSTABLE, a long, straggling, maritime village in Kent, on the south shore of the mouth of the Thames, at the mouth of the Swale, 6 miles north-north-west of Canterbury, with which it is

connected by railway. It is noteworthy chiefly because some of the largest artificial oyster-beds lie off the coast, which are regularly farmed by different companies and proprietors. There are breweries, rope-works, copperas-works, and boat-building-yards. Some Roman pottery has been found among the oyster beds, indicating that probably a Roman station existed here. Pop. (1871) 5431.

WHITSUNDAY, in Scotland, is one of the usual terms for regulating the letting of houses and farms. It was formerly movable, but was fixed by stat. 1690, c. 39, to mean the 15th May. In many respects, however, local usage overrules the statute; thus, in Edinburgh, the term of entry to a house is the 25th of May.

WHITSUNTIDE ('White-Sunday-tide'), the English name of the season of Pentecost (q. v.), is so called from the white garments anciently worn by the newly-baptised catechumens, to whom that sacrament was usually administered on the vigil of Pentecost. The name 'Whitsuntide' comprehends the entire octave or the week which follows Pentecost Sunday; but the word is more strictly applied to the Sunday, Monday, and Tuesday of that week. The two latter days, down to a very recent date, were observed in the Roman Catholic Church as holidays of strict obligation. Many festive observances were anciently practised in connection with the Whitsuntide holidays, which in England and other Protestant countries still subsist, having outlived the religious association out of which they originated.

WHITTIER, JOHN GREENLEAF, American author and poet, was born at Haverhill, Massachusetts, December 1807, in the Society of Friends. He worked on a farm and at shoemaking in his boyhood; but at the age of 18, having a strong desire for learning, he studied for two years at a local academy. In 1829, he became editor of the *American Manufacturer*, a paper established at Boston to advocate a protective tariff; in 1830, he was editor of the *New England Review*, at Hartford, Connecticut, where he wrote a *Life of Brainard*, and *Legends of New England*. The subjects of these legends he afterwards worked out in his poems, as *Magg Megone*, *Bridal of Pennacook*, *Cassandra Southwick*, and *Mary Garvin*. Returning to his farm, he was, in 1835, elected to the Massachusetts legislature; in 1836 appointed Secretary of the Anti-slavery Society, and editor of the *Pennsylvania Freeman* in Philadelphia; in 1840 removed to Amesbury, Massachusetts, as correspondent of the *National Era*. His principal writings are—*Voices of Freedom*, poems collected in 1836; *Leaves from Margaret Smith's Journal*, poems collected in 1836; *Old Portraits and Modern Sketches*, biographical, 1850; *Collected Poems*, 1850; *Songs of Labour, and other Poems*, 1851; *The Chapel of the Hermits*, 1853; *Literary Recreations*, 1854; *The Panorama*, 1856; *Home Ballads*, 1859; *In War Time*, 1863; *National Lyrics*, 2 vols., 1865—1866; *Snow-Bound, and Maud Miller*, 1866; *The Tent on the Beach*, 1867; *Among the Hills*, 1868; *Ballads of New England*, and *Miriam*, 1870; *Child Life*, 1871; *The Pennsylvania Pilgrim*, 1872; *Mabel Martin*, 1874; and *Hazel Blossoms*, 1875. These poems have that rugged picturesqueness, and correspondence of sound to sense, which secure wide circulation.

WHITTINGTON, RICHARD. See SUPP., Vol. X.

WHITTLESEY, or WHITTLESEA, a decaying village and market-town in Cambridgeshire, 5 miles east of Peterborough. The population in and about W. are mostly employed in agricultural pursuits and in brickmaking. *Whittlesea-mere*, a shallow

lake, which formerly existed in the north of Huntingdonshire, 4 miles south-west of W., was 2 miles in length by 1 in breadth, and abounded in fish, water-fowl, &c., is now drained and laid out in fenlands, which are under cultivation. W. is connected by a branch with the Great Northern and Great Eastern Railways. The population, in 1871, was 4297.

**WHORTLEBERRY** (*Vaccinium*), a genus of small shrubs, of the natural order *Vacciniaceae*, having a 4—5-toothed calyx, a 4—5-cleft bell-shaped or urceolate corolla, with the limb bent back, 8 or 10 stamens, with two-horned anthers, and a 4—5-celled many-seeded berry. The species are numerous, mostly natives of the northern parts of the world, with evergreen or deciduous, more or less ovate leaves.—The **COMMON W.**, or **BILBERRY** (*V. myrtillus*), called in Scotland the *Blaberry*, is very common in Britain, and in the middle and north of Europe. It is found also in Iceland and in the northern regions of North America. It delights in dry situations, but is often found in woods, and often on very elevated mountains. It varies from a few inches to almost two feet in height, and has ovate deciduous leaves, and dark purple berries. A variety occurs, but rarely, with white berries. The berries are very sweet and agreeable, and are much used for making jelly. A kind of spirituous liquor is also made from them in Germany.—The **BOG W.**, or **GREAT BILBERRY** (*V. uliginosum*),



Whortleberry (*Vaccinium myrtillus*).

is common in the northern parts of Britain, and in the north of Europe and Asia. It is said to cover extensive tracts in Greenland. It grows in marshy situations, and is a taller plant than the Common Whortleberry. It has deciduous, obovate, entire leaves, and a fruit larger than the Common W., and inferior to it in flavour. The fruit is said to cause giddiness when eaten in large quantity. An intoxicating liquor is made from it in Sweden and in Siberia. The only other British species is the **RED W.** (*V. vitis Idæa*), which is often called *Cranberry*, because of the similarity of its acid fruit to the *Cranberry* (q. v.). It is a native of the north of Europe, Asia, and America, and is plentiful in some parts of Britain. Its fruit is much esteemed for preserves, and is used in the same way as the *cranberry*. Large quantities are sent to the south of Europe from the shores of the Gulf of Bothnia. The plant is a pretty dwarf shrub, with obovate evergreen leaves, and racemes of flowers. *V. buxifolium* is generally regarded as a mere American variety of it.—Many species of *Vaccinium* are in occasional cultivation as ornamental shrubs, and the fruit of most of them is agreeable, although in general it wants acidity. Their more general cultivation has perhaps been prevented by the prevalent notion that they require a peat soil, but they succeed on other soils also. Most of them are North American, and the fruit of some of them is often brought to market in North American towns.—The **BLACK W.**,

or **HUCKLEBERRY** (*V. angustifolium* or *Gaylussacia angustifolia*), is a shrub about two feet high, much branched and erect, with deciduous oval leaves. The berries are of a shining black colour, and sweet. It is widely diffused from Canada to Georgia. The **BLUE TANGLE-BERRY** (*V. frondosum*, or *Gaylussacia frondosa*) is a rather larger and more spreading shrub, which grows near lakes and springs. The fruit is slightly acid.—The **BEAN W.** (*V. ursinum*, or *Gaylussacia ursina*) is found on the mountains of North Carolina; the **BOX-LEAVED W.** (*V. brachycerum*, or *Gaylussacia brachycera*) in Pennsylvania and Virginia. There are other North American species, as *V. Canadense*, *V. humifusum*, and *V. parvifolium*, humble evergreen shrubs. Several species are natives of Mexico. *V. arctostaphylos* is a native of the coast of the Black Sea; and *V. padifolium* is a native of Mount Caucasus and of Madeira, on the loftiest parts of which island it forms impenetrable thickets, growing from six to ten feet high.

**WHYDAW**, or **WHIDAW**, a maritime province of Dahomey (q. v.), on the Bight of Benin. It is populous and very fertile, and exports palm-oil, gold-dust, ivory, and many slaves.—The town of W. is the principal seaport of Dahomey, a decaying place, owing to the suppression of the slave-trade. It is still, however, the principal seaport of the kingdom. Pop. formerly 50,000, now under 12,000. It is situated about a mile and a half from the sea, close to a lagoon and a swamp, between which and the sea a sandy neck intervenes. Into the lagoon flow several rivers, known to slave-traders.

**WHYDAW BIRD**, **WHYDAW FINCH**, or **WIDOW BIRD** (*Vidua*), a genus of birds of the family of Weaver-birds (q. v.), having long wings, and a boat-shaped tail, the two middle feathers of the tail of the males excessively lengthened during the breeding-season. The name is derived from the country of Whydaw in Western Africa, and *Widow Bird* is a mere corruption of it, which, however, has given to the genus its name *Vidua* (Lat. widow), regarded as appropriate, because the long tail of the male drops off after the breeding season, and also because of the general dark colour of the plumage. The species are natives of the tropical parts of Africa and the south-east of Asia. They are frequently brought to Britain as cage-birds, both on account of their plumage and the sweetness of their song. The best known species (*V. paradisæa*) is a small bird, about the size of a canary, with black and brownish-black plumage, with a broad collar of orange-rufous colour, and breast of somewhat similar colour; two feathers of the tail in the male very broadly webbed in the breeding season, and ending in a hair-like shaft, two feathers very much elongated, sometimes a foot in length, and about three-quarters of an inch in breadth.

**WICHERN**, JOH. HEINRICH, superintendent of the Rauhes Haus (q. v.), near Hamburg, and known by his exertions in the affairs of the German Home Mission, was born at Hamburg on the 21st April 1808. He attended the Gymnasium of his native town, and then studied theology at Göttingen and Berlin. Shortly after passing his examinations at Hamburg, he directed himself to practical usefulness, visited the poor and the wretched in the courts and lanes of the town, and undertook the direction of a Free Sunday School for poor children, in which he soon gathered round him from 400 to 500 scholars, instructed by 40 voluntary male and female teachers. At this time, W. declined the offer of a charge in the neighbourhood of Hamburg, as he already entertained the idea of an institution such as the Rauhes Haus, which he opened in 1833. From about 1840, W. was much engaged with undertakings of a

similar kind in Germany, to which his mother-institution gave rise. The example was soon followed by France on a great scale (Mettray, near Tours), then by England, Holland, and other countries. It was chiefly through the instigation of W., that at the first Protestant Ecclesiastical Assembly held at Wittenberg in 1848, for the purpose of concerting united action, a central Home Mission Committee was appointed, under which title W. had formed the idea of comprehending all exertions on behalf of the poor, the miserable, and the morally and religiously lost. This Home Mission has exerted a wide and beneficial influence on the north of Germany; and as a member of the committee, W. found in it an extended field for his exertions. Travelling through all parts of Germany, W. was the means, by his exhortations, of founding all sorts of institutions and societies for education and the care of the sick, of the poor, and of prisoners. On his return from a visit to England in 1851, the Prussian government commissioned him to inspect all the houses of correction and prisons, to the general supervision of which he was appointed in 1853. Prevented by this constant practical usefulness, he has published but little. In his *Home Mission of the German Evangelical Church* (Hamburg, 1849), he explains his views of Christian charity, and its relation to the ecclesiastical and social questions of the day. Since 1844, he has published his *Fliegende Blätter* (Fugitive Leaves), which contain parts of his discourses at the ecclesiastical diets. In 1851, W. received from the university of Halle the degree of D.D.

WICK, a royal, parliamentary, and municipal burgh and seaport, capital of Caithness-shire, stands on both sides of Wick Water, at the mouth of that stream, and at the head of an inlet called Wick Bay, 16 miles south-south-west of Duncansby Head, and 20 miles east-south-east of Thurso. The parliamentary boundaries include the royal burgh, containing (1871) 1767 inhabitants, which, with the suburbs of Louisburgh and Boathaven, containing 1000 more, lies on the north side of the river and bay, and Pulteney-town on the south side, pop. over 5000—the total pop. of the parliamentary burgh being, in 1871, 8145. Pulteney-town, a settlement of the British Fisheries Society, is a flourishing town, managed by Improvement Commissioners. The bay is about a mile long by half a mile broad, exposed to frequent storms from east and north-east. There is an excellent tidal harbour of considerable capacity, the property of the said society. The society some years ago undertook the construction of a breakwater in deep water, and spent large sums upon it. Considerable progress was made with the work; but a series of storms destroyed the greater part of it, and the completion of it seems now to be abandoned. The institutions within the parliamentary burgh comprise a county court-house and prison, nine churches and chapels, a town-hall, the Pulteney-town Academy, and a chamber of commerce. There are two weekly newspapers. W. is the great centre of the herring-fishing in Scotland, though of late years the take has not been so great as it had formerly been. Everything in the town is subservient to the herring-fishery; and the trades—chiefly barrel-making, boat-building, and rope-making—are directly supported by it. A railway connecting W. with the south was opened in 1874. In 1873, the number of herring-boats was 705; and the number of barrels taken was 107,072. In 1875, 926 vessels, of 72,835 tons, entered, and 965, of 68,319 tons, cleared the port.

WICK, the material used for the centre of candles and lamps, which, from its porous nature, draws up the oil by capillary attraction in such quantities as

to burn easily. Usually, wicks are made of cotton, but formerly flax, hemp, and rushes were used. For ordinary candles, the wick consists of a bundle of cotton thread, lying parallel with each other; but for wax, spermaceti, paraffin, stearin, &c., they are usually of twisted or plaited cotton. Very ingenious contrivances have been applied to the manufacture of candle-wicks, to prevent the necessity of snuffing. See CANDLE.

WICKLOW, a maritime county of the province of Leinster, Ireland, is bounded on the N. by the county of Dublin, E. by the Irish Channel, S. by the county of Wexford, and W. and S.-W. by the counties of Carlow and Kildare. Its greatest length is 40 miles, and greatest breadth 33; the total area being 781 sq. m., or 500,178 acres, of which 118,000 are under tillage, 249,200 pasture, 19,500 in plantations, 112,300 towns, waste, &c., and 1090 under water. The pop. in 1851 was 92,978; and in 1871, 78,697, of whom 63,392 were Roman Catholics, 13,963 Protestant Episcopalians, and the rest Protestants of other denominations. The coast-line stretches in a southerly direction about 39 m., in many parts precipitous, and being, moreover, obstructed by sandbanks, is very dangerous for shipping. The surface ascends in some parts most abruptly from the sea, and a large portion is mountainous and unproductive. The Wicklow Mountains, however, form rather a group than a range, and on the western and north-western side, decline less precipitously towards the central plain. The most elevated point is Lugnaquilla, which is 3039 feet above the level of the sea. Several other peaks approach this elevation, and the glens which lie between the several mountains or groups are exceedingly picturesque, especially Glendalough, Glendalure, Imaal, the Glen of the Downs, and Avoca, the scene of Moore's well-known Irish melody, *The Meeting of the Waters*. The valleys are, for the most part, of limited extent; but some plains of considerable size lie upon the eastern and southern shores. The lakes, although strikingly beautiful, are few in number, and of small size; and the rivers, some of which drain the eastern, and others the western slope, are little more than mountain streams, at least so far as their course lies within the limits of this county. The Liffey and Slaney rise in W., but do not reach any considerable volume until after they have issued from it. The great central group of mountains is a mass of granite, which protrudes through mica and clay slate, to which latter formation the minor elevations both on the eastern and the western side generally belong. The granitic protrusion, which is one of the most remarkable and best defined in the kingdom, falls away on the east side towards the sea, and on the west, towards the great central limestone. The minerals of W. are numerous and varied in character. In the granite and mica-slate are found galena, green and white lead ore, and copper pyrites. From the clay-slate tract are obtained gold, silver, copper, iron, lead, zinc, tin, tungsten, manganese, arsenic, and antimony. The quantity of gold found is very small. Silver is found in combination with lead, which is raised with great success and profit at Glenmalur. The copper mines also are very productive; and of late years, the utilisation of the sulphur, which was formerly wasted, has added largely to the profit of the mining operations.

The climate resembles that of Wexford (q. v.). The soil is very various in character. In the mountains, it is thin and poor, but generally dry, although there is a considerable proportion of bog. In the valleys and level districts, the subsoil is generally gravel, and the soil is for the most part either dry, or, even in the boggy districts, susceptible of drainage. On the

## WICKLOW—WICLIFFE.

whole, in the lowlands, the soil is moderately fertile; but there is little cultivation of wheat, the chief agricultural pursuits being dairy-farming and grazing; and the culture, on a limited scale, of barley, oats, turnips, and potatoes. In 1875, the acreage under crops was 112,436, of which more than one-half—viz. 60,883—was under meadow and clover; 25,536 under oats; 11,854 under potatoes; 4458 under wheat; 5678 turnips; 1411 barley; and the rest under the minor crops in small proportions. Flax-culture still remains entirely blank, and in the year 1875 was not represented by a solitary acre. In 1875, the number of cattle was 82,290; sheep (of which a small breed prevails in this county), 217,104; horses, 11,518; and pigs, 22,137. The total annual value of property in W., under the Valuation Act, was £272,380 in 1874. There is a large number of villas, with extensive and highly cultivated parks, especially in the picturesque district which lies between Bray and Wicklow. The county is divided into eight baronies. The principal towns are Wicklow (q. v.), the capital, Arklow, Baltinglass, Shillelagh, Rathdrum, Bray, and Newtown-Mount-Kennedy. W. returns two members to the imperial parliament. The schools, in 1872, numbered 57, with 12,216 pupils. W. is described by Ptolemy as the territory of the Cauoi, and the names of the rivers mentioned by him are still traceable in their modern appellations. At the invasion, the greater part of the lands of W. were granted to Maurice Fitzgerald, and W. was included by John in the shire of Dublin. Generally speaking, however, the authority of the English in W. was little more than nominal; the territory being under the command of the chief of the O'Byrne. A vigorous effort was made by the Lord-deputy, Sir Arthur Chichester, to establish the king's authority in W., and in 1605 it was erected into a separate county; but again, in 1641, the population joined in the general uprising. From the date of the settlement, however, they were effectually held in subjection. During the rebellion of 1798, W. was the scene of more than one conflict, and the peasantry, in some districts, suffered severely from the vindictive character of the repressive measures adopted by the ascendant party.

W. abounds with antiquities of the highest interest. Many tumuli, raths, cromlechs, and other Celtic remains are preserved; and there are very many ecclesiastical remains of almost every period of Irish Christian architecture; those of Glendalough, which include a round tower, are especially interesting.

**WICKLOW**, a seaport, capital of the above county, is situated at the mouth of the river Vartrey, N. lat. 52° 58', W. long. 6° 3', 32 miles south-southeast from Dublin, with which city it is connected by the Wicklow, Wexford, and Waterford Railway. The pop. in 1871 was 3164, of whom 2433 were Catholics, 613 Protestant Episcopalians, and the rest of other denominations. It is an assize town, the smallest in Ireland. The municipality is administered by 21 town commissioners; but although it is a seaport the export trade is extremely small; nor are the fisheries of much value. The principal exports are the products of the mining operations and the agricultural produce of the district. The streets are narrow and ill built, nor is there any public building deserving of notice.

**WICLIFFE**, JOHN DE, the greatest of all the 'Reformers before the Reformation,' was born in 1324, and is supposed to have been a native of the parish of the same name, near the town of Richmond in Yorkshire. He studied at Oxford; but of his early university career nothing is known.

W. first emerges into public notice in 1361, when

his name appears as master of Balliol Hall—as Balliol College was then called. In May of the same year he was instituted to the rectory of Fylingham in Lincolnshire, and shortly after resigned his mastership and went to reside at his rectory. About 1363 he took his degree, and began to read lectures on divinity at Oxford, in which his anti-Romish views were first expounded. In 1368, he exchanged the rectory of Fylingham for the living of Ludgershall, in Bucks; and in 1374, was presented to the parish of Lutterworth, of which he remained priest till his death.

In the great struggle maintained by Edward III. and his parliament against the pretensions of the papacy, regarding the exaction of certain tribute-money which had been granted by King John in acknowledgment of the fealty of the kingdom to the Roman see, W., who had been advanced to be one of the king's chaplains, was called upon to reply to a defence of the papal claim, which had been anonymously sent abroad. This he did publicly at Oxford in an ingenious and powerful manner, and thus early showed his antipathy to the pretensions of Rome. A clear evidence of his growing reputation is furnished by his appointment, in 1374, as second in a commission sent to Bruges to confer with the papal legate as to certain abuses on the part of the papacy complained of by the English parliament. It was probably on his return from this mission, that W. was promoted to a prebend in the diocese of Worcester, and at the same time presented to the rectory of Lutterworth in Leicestershire. Here he laboured with great zeal, preaching not only on Sundays, but on the several festivals of the Church, and shewing himself 'a most exemplary and unwearied pastor.' Here also he began at length to speak his mind as to the papacy. The insight into papal doings which he had received at Bruges seems to have confirmed suspicions previously forming in his mind, and he is said, soon after his return to England, to have styled the pope 'Antichrist,' the proud worldly Priest of Rome, the most cursed of Clippers and Purse-kervers' (cut-purses). Then began in real earnest his troubles with the hierarchy. In the beginning of 1378, he was summoned to a meeting of Convocation, to be examined for his opinions. He obeyed the summons, but he appeared attended by his friend John of Gaunt and others. A great tumult ensued, the London citizens bursting into the chapel, and frightening the synod of clergy, who were ordered to sist proceedings. The papal authority was then invoked against him, and Gregory VI. issued several bulls, three addressed to the Archbishop of Canterbury and other bishops, one to the king, and one to the university of Oxford, commanding an inquest into the erroneous doctrines attributed to the Reformer. W. was accordingly again summoned before the prelates at Lambeth; but on this occasion also he was favoured by circumstances, and escaped merely with an injunction to refrain from preaching the obnoxious doctrines.

These proceedings only served to make W. a more thorough Reformer. He now entered upon his great work of translating the Scriptures, and circulating them among the common people. He had a great retinue of poor preachers, who went from village to village bearing copies of parts of them. He also challenged the doctrine of transubstantiation. Many of the people, the burghers and the middle class, heard him gladly, and matters seemed tending to an open rupture with the papacy. But the times were not as yet ripe for this. Many who otherwise sympathised with the Reformer were afraid of his views about transubstantiation. He was especially summoned to answer on this head, first,

before a synod at the Greyfriars, London, and finally before Convocation in 1382. He appeared, and defended himself with great subtlety and power. His defence was unavailing. Twenty-four 'erroneous' statements were picked out of his works, which were in consequence condemned and ordered to be burned. He was banished from Oxford, but was allowed to retire to his parish of Lutterworth. His health was already shattered by hard work and many anxieties, and on the last Sunday of the year 1384, he was struck down by paralysis while conducting public worship, and two days afterwards expired. W. appears to have been a man of simple faith and of earnest and manly courage. He made a strong impression upon his age; an impression there is reason to think not entirely effaced even to the time of the Reformation. The Lollards, as his disciples were called, were to be found not only among the poor, but in the church, the castle, and even on the throne. Political mischances, however, overtook the party in the following century, and only a few traces of it survived here and there when the movement of the 16th c. began.—See the Rev. W. Shirley's edition of the *Fasciculi Zizaniorum Magistri Johannis Wyclif* (1858), published under the direction of the Master of the Rolls.

WIDDIN, or WIDIN, a fortified town of European Turkey, capital of a sanjak of the same name in Bulgaria, on the right bank of the Danube, 140 miles east-south-east of Belgrade. It is surrounded on the land-side by morasses, and is defended by a strong citadel, by walls, and by a fortified island in the Danube. Its streets and bazaars are pestiferously dirty. For centuries, W. has been a strong post in all the contests between the Turks and their northern neighbours, and it is called by the Turks the Virgin Fort, from its never having been taken. W. has thriving industries and trade. At the close of the war of 1877-78, the treaty of peace between Russia and Turkey provided for the demolition of the fortifications of W. Pop. about 25,000.

WIDGEON, or WIGEON (*Marca*), a genus of ducks of the non-oceanic section, with the hind-toe not webbed, having the bill shorter than the head, and of equal width throughout, much rounded at the tip, with a broad strong nail; the lamellæ of the upper mandible prominent; the wings long and pointed; the tail wedge-shaped. The species are

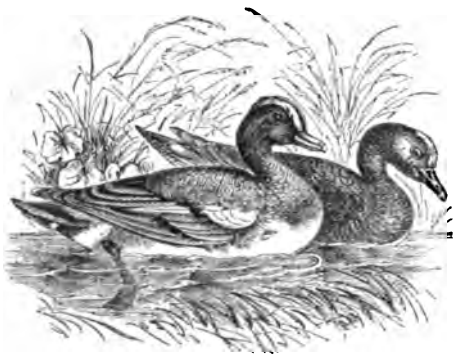

Widgeon, Male and Female (*Anas penelope*).

pretty numerous, migratory birds, appearing in great flocks in the warmer countries which they visit during the winter. The COMMON W. (*Anas* or *Marca penelope*) is plentiful in Britain during winter. A few breed in the most northern parts of Scotland, but the ordinary breeding-place is in more

northern regions. This species is found at some season of the year in almost all parts of Europe, and in Asia, as far south as the north of India. It is found also in North America, along the Atlantic coast. It is known as one of the birds of Japan. Its whole length is about 18 inches. The forehead and top of the head in the male are white, the cheeks and hind-part of the neck reddish chestnut; the upper parts grayish white, crossed with irregular zigzag lines of black; the tail nearly black; the wing-coverts white, tipped with black; the primaries dark brown; a green speculum edged with black; the throat, pale rufous; the breast and belly, white. The female is very different, the head and neck rufous brown, speckled with dark brown; the back varied with two shades of brown, darker in the centre, and paler in the edges of the feathers. The W. is the most common of all the duck tribe in Lapland, frequenting grassy swamps, lakes, and rivers. Flocks of W. appear in Scotland and England, on lakes and rivers, in winter, and most abundantly in severe winters. They feed during the daytime, and chiefly on grass. The note of the W. is a shrill whistle, whence its French name *Siffleur*, and the English names, *Whew Duck* and *Whewer*. Its flesh is good for the table.—The AMERICAN W. (*Anas* or *Marca Americana*) is a larger bird than the European W., being about 22 inches long. The upper parts are finely waved transversely with black and reddish brown, the under parts are mostly white; the top of the head is almost white; the wing-coverts white, the greater tipped with black; the speculum green, encircled by black. It breeds chiefly in the northern parts of America, and is common in winter on the coasts of the United States, and in the rice-grounds. Its flesh is highly esteemed. It is known as an occasional, but very rare visitant in the British Islands.

WIDOW (see *JUS RELICTÆ, SUCCESSION, MARRIAGE*). A widow's right to dower, by the common law of England, extends to a life estate in one-third of the lands and tenements of which her husband died seised, and which any issue she may have had might by possibility have inherited. The law of dower was considerably altered by a statute 3 and 4 Will. IV. c. 105; and in cases where married parties are entitled to real property, their rights are generally regulated by contract. There are certain modes of conveying and devising property so as to prevent dower arising, and a widow's right to dower is also generally prevented by giving her a jointure. A woman loses her dower by a divorce, but not by judicial separation or other misconduct.

WIELAND, CHRISTOPH MARTIN, one of the greatest of German poets, was born, 5th September 1733, at Oberholzheim, near Biberach, his father being pastor of that place and afterwards in Biberach itself. The precocity of his powers early excited attention, and when only 12 years of age, he had essayed his poetical talent both in Latin and in German verses. In 1750, W. went to the university of Tübingen to study law, but occupied himself more with the classics, and with recent literature both native and foreign. From Tübingen, he returned to Biberach in 1752. At this time, Klopstock's example had an extraordinary influence on him, so that he gave himself up to a mystical piety, foreign to his nature, which he gives utterance to in the *Empfindungen des Christen* (The Christian's Experiences). While in this mood, an invitation from Bodmer led him to give up the intention of graduating at Göttingen, and go to Zürich. The number and nature of his productions at this time shew the effect which the example of Bodmer's desultory way of working was beginning to have

upon him. He soon, however, returned to the more congenial field of the literature and life of the Greeks. The lively interest which he took in Frederick the Great, prompted W. to work out the ideal of a hero in a great poem, for which purpose he fixed on Cyrus. The first five cantos appeared 1757, and a new edition 1769; but the reception it met with was not very cordial, and consequently it remained unfinished. The beautiful episode from the *Cyropaideia* of Xenophon, *Araspe und Panthea*, appeared about this time, and revealed W. as the poet of love. In 1760, he received an appointment in his native town in connection with the law-courts. At this period, he engaged in the arduous task of translating Shakspeare (8 vols., Zfr. 1762—1766). However little W., whose mind had been formed after Greek, Roman, and French models, and who was constitutionally inclined to pleasant and easy trifling, was calculated to enter fully into the spirit of Shakspeare, he nevertheless was, for his time, tolerably successful, and opened up the path for his successors.

W. now spent much of his time at Warthausen, near Biberach, the estate of the Count von Stadion, an accomplished and highly intellectual man, but thoroughly a man of the world, and averse to all religious enthusiasm. From the tone of the society he met here, as well as by the course of his reading, W. became imbued with that modern French philosophy which runs through the most of his later writings. In some of these, there is an unmistakable tendency to licentiousness, from which his personal life always remained free; in most of them, however, he has blended the Greek sensibility to outward impressions with the French love of pleasure into a peculiar graceful philosophy of life. The first production which bears the impress of this French-Greek sensuousness, was the poetical tale *Nadine*, which he himself calls a creation in Prior's manner. In 1766 and 1767, *Agathon*, a romance in 3 vols., made its appearance, which greatly contributed to establish W.'s fame. His views on the subject of love are most fully and worthily expounded in the didactic poem *Musarion* (1768), a work of singular grace and harmony of treatment, which he himself called a philosophy of the Graces. W. had, in the meanwhile (1765), married a lady of Augsburg, and accepted a call to Erfurt (1769), as Professor of Philosophy in the university. He terminated what may be called the erotic period of his literary career with the *Verklagten Amor* (The Impeachment of Love), wherein he, in a manner, vindicated the kind of poetry to which he had till then devoted himself.

A period of delightful leisure and undisturbed work began for W. when the widowed Duchess Anna Amalie invited him to Weimar (1772), as tutor to her two sons, with the status of Hofrath, and a salary of 1000 thalers, which was continued to him after his duties as tutor ceased. W. was entirely in his own place in the society of the distinguished men (such as Musäus and Von Einiedel) already gathered round this court; and his genius began to soar more courageously. He wrote his vaudeville, *Die Wahl des Hercules* (The Choice of Hercules), and the lyrical drama, *Alceste* (1773), which were received with great approbation. Of greater importance for German literature was the publication of the *German Mercury*, a monthly periodical, to which W., till towards the close of his life, devoted himself with the greatest earnestness, and which he made the vehicle for disseminating his æsthetical views. On the whole, however, his criticism was neither genuine nor very deep, and suffered from that conventional narrowness which was then dominant in France. His letters on his

*Alceste* in the *Mercury* (September 1773) contain sufficient traces of this tendency, at which Goethe and Herder were so much offended. The former wrote in relation to it the satire *Götter, Helden, und Wieland* (Gods, Heroes, and Wieland). W. answered the attack with pleasantry and with his characteristic good nature. Shortly afterwards, Goethe himself joined the circle at Weimar, the soul of which was the Duchess-mother, Anna Amalie. W.'s literary powers developed themselves here more and more; and for more than 20 years, almost nothing of any importance occurred, either in the political or literary world, in which he did not take a more or less active part. His literary productiveness shewed itself chiefly in the *Geschichte der Abderites* (History of the Abderites, 1773), a charming work, depicting the follies of small communities, in which the muse of Wisdom is disguised under the garb of the Satyr. This was followed by a series of tales and stories, partly imitations of foreign originals, and partly of his own invention. *Oberon*, a romantic heroic poem, the most perfect and enduring of his greater works, appeared 1780 (last ed. Leip. 1853). It was followed by the translation of Horace (*Letters*, 1782; *Satires*, 1786) and of Lucian (1788). W. pronounced the *Epistles* of Horace with the commentaries to be those of his works on which he put the greatest value. He has given us a complete sketch of his conception of the Greek world in the *Aristippe* (1800). A collected edition of W.'s works up to 1802, in 36 vols., with 6 supplementary vols. in large quarto, and large and small octavo (new edition with the poet's life, 53 vols., 1828; 36 vols., 1839), was got up by the bookseller Gúechein in Leipzig. From the proceeds, W. was enabled to buy the estate of Osmanstädt, near Weimar. From 1796 to 1803, he lived here in the circle of his numerous family (his wife, in the course of 20 years, had brought him 14 children), and devoted the greatest part of his time to literary labours, among which his *Attic Museum* (1796—1804) and the *Neue Attic Museum* (1805—1809) were not the least. In these publications, he strove to make his countrymen familiar with Greek poetry, philosophy, and rhetoric. In 1803, he sold his estate, and returned to Weimar, where he very soon became intimate with Schiller. Here he lived to see the day of the battle of Jena, the death of the Duchess Amalie, and also of Herder and Schiller. The marks of honour which he received from Alexander and Napoleon, and his admission to the French 'Institut,' helped to alleviate his many griefs, among which one of the greatest was the death of his wife, 1801, with whom he had lived for so many years in great happiness. His own death took place 20th January 1813.

W. had neither the spirit of a reformer like Klopstock and Lessing, nor did he attain the poetical greatness of Goethe or Schiller; nevertheless, he did great service to German literature, which has not always been sufficiently recognised. He gave to German poetry, as it was rising into true national importance, the still wanting grace and harmony of expression and versification, in which respect Goethe learned much from him. The poetic handling of mediæval chivalry was an entirely new creation of his, and thus the school of romantic poetry is indebted to him for its origin. He also introduced poetical materials from England, France, Spain, and Italy, which were not without influence. In all his appropriations W. exercised that fine discernment which seizes upon what is universally human, so that he nowhere appears as a blind imitator. His criticism, too, with all its shallowness, contributed much to the diffusion of general culture.—Compare, besides Gruber's

*Biographie Wieland's* (4 vols., Leip. 1827; vols. 50—53 of the *Works*), *Wieland's ausgewählte Briefe* (4 vols., Zür. 1815), *Auswahl denkwürdiger Briefe* (2 vols., Wien, 1815), and *Briefe an Sophie Laroche*, Berl. 1820).

WIELICZKA, a small town of Austrian Galicia, 10 miles directly east-south-east of Cracow, and the same by railway. It is remarkable for its salt-mines, in which the majority of its inhabitants (4945 in number in 1869) are employed. The mines were discovered in 1250, and have been continuously worked since that time; though some assert that there is abundant evidence to prove that they have been worked since the 9th century. The town itself is entirely undermined by the excavations, which extend upwards of 9590 feet from east to west, 3600 feet from north to south, and are 1780 feet in depth. The mines extend to four stories or 'fields,' one below the other. In the second story, the visitor is rowed across a salt lake, and when he has reached and is exploring the third story, he is informed that the lake he lately crossed is now right above his head. The stories are simply large chambers excavated in one enormous mass of rock-salt, of great purity, and apparently of inexhaustible extent. In one of the chambers, the miners have scooped out a Gothic chapel, and skilfully carved a number of statues and obelisks, from the solid rock-salt. The mines produce 61,500 tons English per annum.

WIESBADEN, chief town in the Prussian district of the same name, in the province of Hesse-Nassau (formerly the independent duchy of Nassau), one of the oldest and most famous of the German watering-places, delightfully situated on the south slopes of Mount Taunus, 26 miles W. of Frankfurt, and 5 miles N.W. of Mainz by railway. The town has been called 'a city of lodging-houses,' and this may be understood from the fact, that during the 'season' the number of the visitors is greater than that of the resident inhabitants. But though almost every house is appropriated to the reception or entertainment of guests, the town is well and regularly built. The *Kursaal* comprises an extensive dining-hall, in which frequently 300 people sit down to dinner, and which also serves as a ball-room, together with good reading-rooms, &c. In the large gardens behind the *Kursaal*, it is the habit of the visitors to sit in the evenings at their numerous small tables, regaling themselves with coffee or ices—the men smoking, the women knitting—and all either chatting or listening to the music played by a band on such occasions. Other buildings are the *Schlösschen* (Little Palace), containing a library of 60,000 vols., and a collection of antiquities, in which are a number of curious Roman *bassi-relievi*, statues, altars, &c. found in the vicinity; the handsome Protestant church, finished in 1860; the superb Greek chapel, built by the Duke of Nassau as a mausoleum, in which repose the remains of his first wife. There are 14 hot springs, all of a high temperature, and numerous bathing-houses throughout the town; but the principal is the *Kochbrunnen* (Boiling-spring), the temperature of which is 156° Fahr. The spring has all the appearance of a boiling caldron, and so copiously does it pour forth its waters, that, though they are used both for drinking and to supply the principal baths in the town, a vast quantity escapes, and runs away through gutters and drains, sending up clouds of vapour in its passage along the streets, and adding to the warmth of the temperature of W. in summer. Next in heat and volume to the *Kochbrunnen* is the spring that rises in the garden of the *Adler* (Eagle) Hotel, the temperature

of which is 134° Fahr. The use of the W. hot-springs is considered highly efficacious in cases of gout, rheumatism, scrofula, and other skin diseases and nervous affections. The waters of these springs are saline, and contain silica and iron. The prosperity of W. is entirely due to its springs; and the beauty of its situation and environment, the agreeable walks and rides, the charming views of the vicinity, and the never-failing gaiety that prevails during the season, render it one of the most popular of the spas. The season lasts from June to September, and the number of visitors annually is over 20,000. Pop. (1871) 35,463.

W. is very ancient; its springs are the *Fontes Mattiaci* mentioned by Pliny. The Romans built a station here, and erected a fort on a hill on the north-west side of the town, still known as the *Römerberg*, and which was garrisoned by the 22d Roman legion. The *Mattiaci*, a subdivision of the German tribe called the *Catti*, allied themselves with the Romans; but in the 3d c., the barbarian Germans rose against the Romans, and destroyed their forts, including Wiesbaden. Urns, tiles, coins, &c. are found abundantly whenever the foundation of a house is dug; and that the Romans appreciated the virtues of the waters is proved by the remains of ancient baths that have been found, and by the votive tablets recording the thanks of Romans who had been restored to health by the waters, still preserved in the museum.

WIG (Lat. *pilus*, the hair; *pilare*, to pluck off the hair; from which was formed *piluicare*, and hence *piluca*, a head of hair; this was transformed in Ital. into *perruca*, French *perruque*, whence *Eng. periwig*, shortened into *wig*). The use of false hair for concealing baldness, or for the supposed adornment of the head, appears to belong to all ages and countries. There is an Egyptian wig in the British Museum, supposed to be about 4000 years old; and some of the South Sea islanders are said to be skilful wig-makers. Xenophon mentions that Astyages wore an immense wig. Several of the Roman emperors wore wigs, and Lampridius relates that the wig of the Emperor Commodus was highly perfumed, and sprinkled with gold dust. After this, there are no historical traces of the wig till about the end of the 14th c., when wigs made their appearance in France, and hence spread gradually over other European countries. The fashion of wearing wigs set in strong in the reign of Louis XIII. (1610—1643), and for more than a century, no gentleman of fashion could appear without one. Such was the extravagance in this article of dress, that as much as three guineas an ounce was paid in England for fine qualities of hair, and wigs were made at a cost of £140. It was only towards the end of the 18th c. that the unnaturalness of this ornament appears to have been thought of, and it began to be superseded by the queue with Hair-powder (q. v.). Except by judges and barristers, wigs are now used only in cases of baldness, and then they are made in imitation of nature, which was by no means the case with the wigs of old times.

WIGAN, a prosperous market and manufacturing town, and municipal and parliamentary borough, in Lancashire, on the Douglas, 15½ miles south-south-east of Preston, and about the same distance from Liverpool on the south-west, and Manchester on the south-east. Originally rather irregularly built, W. has for some years progressed rapidly in the improvement of its streets and buildings. It is well sewered and liberally supplied with water. The parish church of All Saints is an ancient stately edifice, and has recently been almost entirely rebuilt.

## WIGAN—WIGHT.

There are 21 churches and chapels belonging to the Establishment; 9 Roman Catholic, and 21 other dissenting places of worship. W. stands in a coal-field, where cannel coal abounds. Cotton-spinning, the manufacture of calicoes and other cotton goods, checks, and home-made linens, are extensively carried on. There are also brass and iron foundries, factories for edge-tools, chemical-works, paper-works, and corn-mills. The river Douglas, and the Leeds and Liverpool Canal, afford facilities for inland navigation. Pop (1871) 39,110.

WIGHT, ISLE OF, an island in the English Channel, remarkable for the variety and beauty of its scenery, and the mildness and salubrity of its climate, lies almost centrally, close off the southern coast of England, in which it is partially embayed, and is divided from it by a channel varying from less than 1 mile to more than 6 miles in breadth, known as the *Solent* (q. v.), which spreads out to the east into the broad and safe anchorage of *Spithead* (q. v.) and *St Helen's Roads*. Its form is remarkably regular, its longer and shorter diameters (22 miles 5 furlongs, and 13½ miles in length respectively) running almost due east and west, and north and south. Its shape is rhomboidal, and has been compared to a bird with expanded wings or to a turbot. It is 56 miles in circuit, and embraces an area, including its inlets, of 98,320 acres. Pop. (1871) 66,165. *Newport*, which returns one member to parliament, the island returning one, is the capital; the other chief towns are *Ryde*, *Cowes*, and *Ventnor* (all described under their separate headings), of which the first and last have sprung up from small villages within the present century. *Yarmouth* is a small decayed town near the western extremity of the island, formerly returning two members, a privilege once also possessed by *Newtown* on the north-west coast, a once important town, now sunk to an insignificant hamlet. On the south-east coast, the delightful health-resorts of *Sandown* and *Shanklin* have lately acquired the size and importance of towns. Railway communication has been opened between *Ryde* and *Ventnor*, and between *Cowes* and *Newport*. Throughout the island there are good though generally narrow roads, for the most part picturesque and bounded by hedgerows. The chief physical feature of the island, to which it owes its shape and much of its beauty, is a long undulating range of chalk downs, extending, as a kind of backbone, from the *Culver Cliffs* on the east, to the *Needles* on the west, rising to its greatest elevation in *Mottistown Down*, 661 feet (*Ashey Down* is 424 feet, and *Bembridge Down* 355 feet) above the sea. The river *Medina*, rising near the southern extremity of the island, flows north through a gap in this range, expands into a tidal estuary below *Newport*, and flows into the *Solent* at *Cowes*, and divides the island into the hundreds of the *East* and *West Medine*. In addition to the central ridge, a second range of chalk downs of greater elevation—*St Boniface Down*, 783 feet, *Dunnose* (*Shanklin Down*), 771 feet, *St Catherine's*, 769 feet—rises at the southern point of the island, and expands into a broad promontory, the south face of which forms the picturesque district known as the *Undercliff*, or 'Back of the Island,' of which *Ventnor* is the capital. This district owes its remarkable beauty to a series of landslips on a gigantic scale, of pre-historic date, which have laid bare a long wall of rugged cliff, below which a succession of sunny terraces, due to the gradual subsidence of the strata, slope gently down to the sea. The whole of this part of the island is completely sheltered from the colder winds, and enjoys a well-merited reputation as a residence for invalids suffering from consumption or any disease of the respiratory organs. Its remarkable healthi-

ness is attested by the returns of the registrar-general, which prove that the death-rate of the district is absolutely the lowest in the kingdom; while the mildness of its climate is evidenced by the luxuriance of the myrtles, fuchsias, sweet-scented verbenas, and other exotics, which live through the winter without protection.

In a geological point of view, the Isle of W. is most interesting. The great variety of strata displayed within so small an area, under circumstances so favourable for examination, renders it one of the best available localities for the young observer. The north side of the island presents a succession of Tertiary or Eocene strata, including beds of freshwater limestone, which have been extensively worked for building-stone for many centuries, and based on beds of London and Plastic Clay. In *Alum Bay*, at the west extremity of the island, the rapid succession of vertical layers of sand and clays of bright and varied hues, produces a singular and beautiful effect. The central ridge or backbone consists of strata of chalk imbedding layers of flints, and the underlying formations in an almost vertical position. Isolated masses of chalk that, in consequence of their superior hardness, have survived the marine and atmospheric waste, form the well-known *Needles*, at the west opening of the *Solent*, and the picturesque rocks of *Freshwater Bay*. The downs at the south of the island belong to the same formation, but here the strata have been undisturbed, and are nearly horizontal. The cliffs of the *Undercliff* are of the *Upper Greensand*, or *Firestone*, underlying the chalk. Below this comes the *Gault*, or *Blue Marl*. To the action of the land-springs upon this unctuous formation, the landslips to which the *Back of the Island* owes its beauty are due. The *Lower Greensand* succeeds the *Gault*, occupying the greater part of the area between the north and south chalk downs. This forms excellent corn-land, and presents a wall of cliff to the sea, diversified with many narrow picturesque gorges, locally known as *Chines*, where a small rivulet has eaten away the friable strata. The chief of these are those of *Shanklin*, *Luccombe*, *Blackgang*, and *Whale Chine*. The freshwater *Wealden* formation is the lowest visible in the island, and is seen in the cliffs of *Brook* to the west, and of *Redcliff Bay* to the east. Bones of the colossal *iguanodon* and other saurians are found in this formation.

The soil of the island is very varied, both in nature and fertility. That of the northern half is, to a considerable extent, a cold, stiff clay, more suited for the growth of wood, especially oak, than corn. Of late years, however, much of the woodland has been cleared, and judicious draining operations, in which the late *Prince Consort* led the way on the royal domain of *Osborne* (near *East Cowes*), have produced very beneficial results. Farming is still on the whole somewhat primitive; even on large farms the flail may still be seen in use. The soil of the south half is chiefly a red loam, which is exceedingly productive, especially in crops of barley, and, in the more rich and sheltered lands, of white wheat. Red wheat is grown in abundance in other parts of the island; while the stiffer clays of the north grow capital crops of oats. The chalk downs afford admirable pasturage for sheep, which are celebrated for the pureness of their wool, chiefly exported to *Yorkshire*, and which furnish the *London market* with early lamb. The chief exports are wool, corn, flour, cement stones (*septaria*), and white glass-house sand. The principal communication between the mainland and the island is by steam-boats plying daily between *Portsmouth* and *Rhyde*, at both of which places there are good landing-piers.



The *History of the Isle of W.* presents but comparatively few points of interest. It is supposed, with much probability, to have been the tin mart of the Greek traders mentioned under the name of *Ictis* by Diodorus Siculus. The Romans knew it as *Vecta* or *Vectis*, which is merely the Latinised form of the native name. It was conquered for the Romans by Vespasian in the reign of Claudius (43 A.D.). Cerdic, the founder of the kingdom of Wessex, took the island 530 A.D., and handed it over to his nephews, Stuf and Wihgar. In 661 A.D., it was reduced by Wulphere of Mercia, and given to Ethelwold, king of Sussex, from whom it was wrested (686 A.D.) by Ceadwalla of Wessex, to whom, under the benign influence of Wilfrid, Archbishop of York, the island owes the introduction of Christianity. During the three centuries preceding the Norman Conquest, it was repeatedly devastated by the Danish pirates, who made it their stronghold, to which they retired with their plunder. William the Conqueror gave it to his kinsman, Fitz-Osborne; Henry I. transferred it to the family of De Redvers, in whose hands it remained till the reign of Edward I., when it passed by sale to the crown. During the French wars of Edward III. and his successors, the island was repeatedly invaded and pillaged by the French. At the close of the reign of Henry VIII., the armada despatched by Francis I., under the command of D'Annebault, made several landings on the coast, and inflicted some damage, but were ultimately driven back by the prowess of the islanders. The most interesting event in the history of the island is the imprisonment of Charles I. in the castle of Carisbrooke, after his flight from Hampton Court, from November 23, 1647 to September 15, 1648. Carisbrooke was also the place of the imprisonment of his children, Prince Henry and the Princess Elizabeth, the latter of whom died there, and was buried in Newport Church, where a beautiful monument by Baron Marochetti has been erected to her memory by Queen Victoria.

Among the celebrated natives of the Isle of W. we may notice Dr Robert Hooke, the experimental philosopher, born at Freshwater, 1635; and Dr Thomas Arnold of Rugby, the regenerator of public-school education, born at East Cowes, 1795.

The antiquities are not numerous. Sepulchral barrows occur on the downs, and Saxon burial-places have been discovered in several localities. There are the remains of a Roman villa, with a tessellated pavement, at Carisbrooke. The remains of Quar Abbey, near Ryde, are very scanty. Carisbrooke Castle is a fine ruin, occupying a commanding position. The churches are picturesque, but not remarkable for beauty of architecture. There are but few monumental brasses or other sepulchral memorials of interest.

**WIGTON**, a market and small manufacturing town of Cumberland, in the midst of a specially agricultural district, 11½ miles by railway south-west of Carlisle. It carries on manufactures of gingham and checks. Pop. (1871) 3425.

**WIGTOWN**, a county forming the south-west corner of Scotland, is bounded on the W. by the Irish Channel, N. by Ayrshire, E. by the Stewartry of Kirkcudbright and the Solway Firth, and S. by the Irish Sea. Its extent from east to west is computed at from 32 to 34 miles, and from north to south 24 to 28 miles. This county, which constitutes West Galloway, was formed about the year 1341; and is between 54° 38'—55° 4' N. lat., and 4° 16'—5° 6' W. longitude. W. is somewhat irregular in form, being deeply intersected by two arms of the sea, one of which, Lech

Ryan, a long narrow inlet, stretches southwards from the north-west corner for fully 9 miles into the county, while Luce Bay on the south makes a wide indentation 18 miles long with an average of 12 wide, the heads of the inlet and bay being only 6 miles apart. The western part of W., known as the *Rhins of Galloway*, thus forms a peninsula whose length (from north to south) is 28 miles, and breadth 1¼—6 miles; its northern extremity is Corsewall Point, and its southern the Mull of Galloway, each promontory being provided with a light-house. The south-eastern half of W. is separated from the Stewartry by Wigtown Bay, 15 miles long and 14 wide at its mouth, and between this latter and Luce Bay, W. extends southwards in a blunt triangular form, terminating in Burrow Head. The inhabitants of W. were originally of Celtic origin, and up to the middle of the 16th c., a Celtic dialect was universally spoken; and for a century afterwards, it was in use in the remote districts. W. is irregular in its surface, but its eminences are inferior in height to those of any other county of Scotland—none of them exceeding 500 feet. The soil is varied, and—with the exception of a portion lying along the sea-shore, especially in the south-east, which consists of a rich loam—the quality is mostly inferior. There is a large extent of moss and moor, mostly of a very poor and unproductive nature, judging from the appearance and produce of much of what has been reclaimed. There has, however, been a considerable improvement made of late years in farm-buildings. The climate is rather mild, but moist, the rainfall being comparatively great. There are many dairy establishments in this county, almost exclusively for making cheese similar to the Somersetshire cheddar. The cows are frequently let for hire at from £9 to £12 per cow, the farmer supplying all food, and the dairyman the labour. Most of the cows are of the Ayrshire breed; it is difficult to obtain the pure native breed of cattle; and the Galloway pony, formerly in such vogue, is now hardly to be met with. The area of W. is over 512 sq. m., or 327,906 acres, of which about three-fifths would be unprofitable to reclaim. The government returns for 1875 give 144,506 acres under all kinds of crops, bare fallow, and grass; under corn crops, 38,581; under green crops, 19,065; clover, sanfoin, and grasses under rotation, 45,040; permanent meadow pasture, 41,375. There were 5542 horses for the use of agriculture; also 39,938 cattle, 127,627 sheep, and 8963 pigs.

Besides numerous small streams, W. contains three rivers of considerable size, the Cree, which forms the eastern boundary, and the Bladnoch—both of which fall into Wigtown Bay—and the Luce, which empties itself into Luce Bay; the former two are navigable for a few miles, and yield salmon and trout. The county also possesses several small fresh-water lochs. In the Rhins of Galloway, on the south-west, is situated the parish of Kirkmaiden, the most southerly point in Scotland—hence 'from Maidenkirk to John o' Groat's.' There were at an early period a considerable number of religious houses in the county; and the church, believed to be the oldest in Scotland, founded by St Ninian, was built near the site of what is now the village of Whithorn. At the Reformation there were 21 parishes; the number was reduced to 17, but is now 20. The principal towns are Wigtown, Newton-Stewart, Stranraer, and Whithorn. There is no mineral wealth, and little trade or manufacture carried on in W. There is a distillery at Bladnoch, a woollen manufactory at Kirkcowan, and some saw-mills and starch-mills at Stranraer and elsewhere. The mail-coach was first run through W. in 1804, and was only superseded by a railway

from Castle Douglas to Port Patrick in 1857. A branch railway is formed from Newton Stewart to Wigtown, and is now continued to Whithorn. The valued rent of W. in 1674 was £5634; the valuation for 1875—1876 was £222,806. Pop. (1871) 38,830; parl. constituency (1875—1876), 1817.

WIGTOWN, a royal, municipal, and parliamentary burgh, market-town, and seaport in the south-west of Scotland, capital of the county of Wigtown or West Galloway, is situated on Wigtown Bay, near the mouth of the Bladnoch Water. It is 40 miles west-south-west of Dumfries, and nearly 150 miles distant by railway from Edinburgh. The parish church was erected in 1852. It is of Gothic architecture, and much superior to the ordinary run of country churches. In the churchyard there are three tombstones in memory of martyrs who suffered in the time of Episcopal persecution. Two of them are old. On the summit of the Windyhill, the highest ground in the neighbourhood of the town, an obelisk of freestone was placed some years ago, in memory of these same martyrs—two of whom, women, are said to have been drowned here. The authenticity of this event, though lately questioned by some, is doubted by very few in the locality where it is said to have happened. A large and very handsome building, which is used as a town-hall and court-house, was erected in 1863. Pop. (1871) 1780. There is no particular trade carried on in the town. At Bladnoch Bridge, however, which is held to be part of the burgh, although nearly three-fourths of a mile distant to the south, there is a distillery of considerable extent; also an iron foundry and a coach-building establishment. W. unites with Whithorn, Stranraer, and New Galloway in electing a member to the House of Commons. The registered tonnage of the port in 1872 was 2271.

WIKANA, the *Wacaca des Indes* of the French, a dietetic preparation of cacao much used in France for invalids. It consists of roasted cacao nibs and sugar, in the proportion of three parts of the latter to one of the former, well mixed together, and flavoured with cinnamon, vanilla, ambergris, and musk.

WILBERFORCE, WILLIAM, was born at Hull, on 24th August 1759. His father was a wealthy merchant, descended from an old family, proprietors of Wilberfoss, in the East Riding of York. W., at the age of 9, on his father's death, was sent to school at Wimbledon, where, under the care of a pious aunt, he ran the risk of becoming a Methodist. But his mother did not approve of a serious education, and removed him to a Yorkshire school, where the religious impressions he had received were soon dissipated by a life of gaiety. His constitution was delicate, but he was quick and spirited, and fond of society, in which his lively conversation and musical talent made him a great favourite. While at school, he addressed a letter to a York paper 'in condemnation of the odious traffic in human flesh,' a subject he seems never afterwards to have lost sight of. At 17, he entered St John's College, Cambridge, and in due time he passed his examinations with credit. He came, on attaining his majority, into possession of a large fortune, and determined to enter parliament. In 1780, he was returned for Hull. He had known Mr Pitt when at Cambridge, and in London they became inseparable friends. W., in parliament, however, remained independent of party. The elevation of Mr Pitt to the premiership gave him an opportunity of taking office, but he declined to do so. He rendered, however, efficient service to his friend. In March 1784, on the eve of a dissolution, he spoke at a county meeting in York, called to vote an address against the Coalition Ministry; and such

was the effect of his eloquence, that when he had concluded, a resolution had been come to by the freeholders that he should be asked to stand for the county. He did so; and in spite of opposition from the great Whig families, he was returned without a contest. W.'s success in the leading county, set an example to other constituencies, which was of very great advantage to the Pitt ministry. In the same year, W. made a tour on the continent with some ladies of his family and Isaac Milner, the Dean of Carlisle, during which the serious impressions of his youth seem to have been revived. In 1787, he in a great measure eschewed gaiety, and founded an association for the discouragement of vice; and in the following year, while in very bad health, he entered on his great struggle for the abolition of the slave-trade, to which he thenceforward dedicated his whole time. He was powerfully supported by the Quakers, and by Mr Thomas Clarkson, who kept alive interest in the subject beyond the walls of the House of Commons. In 1789, he first proposed the abolition of the slave-trade in the House of Commons, and met, as he expected, with powerful opposition. In 1804, his bill was first carried through the Commons; it was thrown out in the Lords; and in the following year it was again lost in the Commons. In 1806, however, a resolution was moved by Mr Fox, pledging the Commons to a total abolition of the slave-trade in the following session. It was adopted by the Lords. Just before the discussion began in January 1804, a work had been published by W. against the slave-trade, which had a marked influence on public opinion and the subsequent debates. The bill was passed by the Lords. In the Commons, it was carried by an enthusiastic majority. Sir Samuel Romilly, who supported the measure, compared the feelings of Napoleon, then at the height of his glory, with those of the English philanthropist, 'who would that day lay his head upon his pillow, and remember that the slave-trade was no more;' and the whole House burst into applause, and greeted W. with enthusiastic cheers. W. now sought to secure the abolition of the slave-trade abroad. He at the same time entered on an agitation for the total abolition of slavery itself. Declining health, however, compelled him in 1825 to retire from parliament, in which, since 1812, he had sat for the borough of Bramber. The movement against slavery was then intrusted to Sir T. Fowell Buxton. Three days before W.'s death, news was brought him that the Abolition Bill had passed a second reading, and he thanked God he had lived to see his countrymen spend 20 millions sterling in such a cause. He died 29th July 1833, and was buried as a national benefactor in Westminster Abbey. In 1797, W. married the daughter of Mr J. Spooner, the banker of Birmingham, by whom he had a large family. W. is the author of a *Practical View of Christianity*, which, on its publication in 1797, met with great success.—See the *Life of Wilberforce*, by his sons. His third son, Samuel (born 1805, died 1873), became bishop of Oxford in 1845, and bishop of Winchester in 1869. He distinguished himself in parliament by his eloquence, and was author of a *History of the Episcopal Church in America, Agathos, and The Rocky Island*, allegories, sermons, &c.

WILDBAD, a small town of Wurtemberg, in the Black Forest, romantically situated in a valley watered by the Enz, about 32 miles south-south-east of Karlsruhe, 18 miles of which are by railway to Pforzheim, and the remaining 14 by road, through a beautiful portion of the Black Forest. It is noted for its thermal springs and baths, the water of which ranges from 90° to 100° F. in temperature. The baths consist of numerous basins formed round the springs

as they gush from the rocks, and floored with sand for the comfort of the bathers. From the circumstance that these baths are natural, or *wild*, and not artificial, the town derives its name. The waters are nearly pure, the principal ingredient they contain being common salt. They are peculiarly beneficial for rheumatism, gout, stiffness of limbs, paralysis, &c., and for some skin-diseases. The season lasts from May till September, and the number of visitors has steadily increased from 470 in 1830 to about 5000 annually. Goitre abounds here and in the neighbouring close valleys of the Black Forest. Pop. (1871) 3049.

**WILD-FOWL**, a popular term, synonymous with *Water-fowl*, and generally applied to web-footed birds, but sometimes employed also to include herons, plovers, and other birds which frequent rivers, lakes, and sea-shores. The different kinds are noticed under their proper heads.—*Wild-fowling* is one of the most difficult, and yet one of the most interesting pursuits of the British sportsman. *Rock-fowling* (see **FOWLING**) is not included under this term. Wild-fowling is prosecuted in a great variety of ways. The wild-fowler seeks his game with a gun and dog, generally a retriever; or he uses a small boat, called a *punt*, adapted to the shallow waters in estuaries which wild-fowl frequent; or he proceeds a little further to sea, in a boat with sails; sometimes he employs a yacht, or he endeavours to

modern decoy-pipe, the birds, however, being generally driven, and not enticed into it. The *panthera* was a large purse or drag-net, placed along the banks of rivers. The ancient wild-fowlers sometimes practised a system of decoying, apparently less perfect than the modern system, but essentially of the same nature, enticing the birds to their snares by movements intended to excite their curiosity, and for this purpose the fowlers clothed themselves in feathered jerkins, and danced with peculiar motions and gestures. Nooses and bird-lime were also much employed in ancient times. The Egyptians made much use of the *throw-stick*, a missile similar to the boomerang of the Australians, and which was dexterously thrown so as to hit the neck of the bird. In more recent times, falconry was much practised for the capture of wild-fowl. The gun, decoys, and flight-ponds are now chiefly in use. Although many wild-fowl are killed with the ordinary fowling-piece, it is not thus that the greatest numbers are obtained. Much larger guns are used in punts and yachts, by which many are killed at one shot. The *stalking-horse* is still used in some parts of England, in order to enable the wild-fowler, armed with an ordinary fowling-piece, to get within reach of the birds, whilst they are feeding on the level swampy ground which they chiefly frequent. A horse well trained for the purpose advances towards them, the fowler concealing himself on the side of it



Fig. 1.—Stalking-horse.

(From Blaine's *Encyclopædia of Rural Sports*. By kind permission of the publishers, Messrs Longman.)

approach his game on land by the aid of a *stalking-horse*; or he has recourse to decoys, and other contrivances, by which great numbers of wild-fowl are captured. It is chiefly on the eastern and south-eastern coasts of England that wild-fowl abound in Britain, and they are most abundant in severe winters, coming as migratory birds from the north; but the draining of the fen-lands has greatly reduced their numbers. The ancient Greeks and Romans captured wild-fowl by various kinds of nets, one of which, called the *argumentum*, was not unlike the

furthest from them. An ox is sometimes trained for this use, and indeed the kind of animal with which the birds are most familiar in the locality is most suitable. Artificial stalking-horses are sometimes employed, made of canvas, and stuffed with straw, the head being down, as if grazing. This practice is common in some parts of France. The use of the stalking-horse is very ancient. Wild-fowl shooting is not unattended with danger. In the pursuit of wounded birds on the ooze, the sportsman or fowler must use *splashes*, thin boards about 18 inches square, attached to the feet, to prevent him from sinking; and if he fall, it is very difficult for him to regain his feet. He cannot raise himself by resting his hands on the mud, which only makes him sink deeper and deeper, nor can he do it by getting upon his knees. The only method is to roll over on the back, drawing the arms out of the mud, and placing one foot with his splashers firmly on the ooze, to press both hands on the knee of the leg so raised, and give a vigorous spring. The punter is also in great danger of losing himself in foggy weather when pursuing wounded birds, and being unable to get back to his punt, when a fearful death awaits him on the return of the tide.

The curly-coated retriever is the best dog for the wild-fowl shooter, but good training is necessary to fit the dog for his use. The punter ought not to carry a dog with him, because the dog, having no opportunity of exercise after his return from the water, soon suffers from the cold of the winter weather in which the sport is pursued.

*Sledging for wild-fowl* is practised by professional wild-fowl shooters on some parts of the English

coast, particularly that of Hampshire. The sledge traverses the cozes by means of a small light sledge called a *launching-punt*, with a gun in the fore-part. He pushes it ahead, crawling on his knees, and often at full length on the mud, till he gets within range. His most severe work is on sands and dry ground.

The *gunning-punt* is a small generally flat-bottomed boat, about 17 feet in length, with a gun placed in the front of it, generally carrying about half-a-pound of shot at a charge. The punt must be nicely trimmed, so that the gun is nearly on a level with the surface of the water; and the fowler, having approached the

birds where they are congregated, often kills great numbers by its discharge. The sport is pursued both by day and by night. The punt is generally constructed to carry only one person, and although he rows it in the ordinary manner till he discovers the birds, he is obliged then to lie down in the punt, and force it forward by a pole or by the oars with no little exertion, till he gets within range. The danger is not inconsiderable of his mistaking another punt in the darkness of night for an assemblage of wild-fowl, and firing at his fellow-sportsman. In a clear moonlight night he proceeds, if possible, against



Fig. 2.—Gunning-punt approaching Wild-fowl.  
(By permission of Messrs Longman.)

the light, so that he may see, and not be seen. By a successful shot, great numbers of water-fowl are often killed. The punt-gun is capable of being *tipped*, that is, elevated so as to shoot water-fowl on the wing; and the most successful shots are often made by waiting till they rise, and tipping the gun. The punter cannot expect to recover all his wounded birds, and there are men on some parts of the coast who make their living during winter mostly by seeking for them in the morning.—The *sailing-punt* is a mere modification of the ordinary gunning-punt; the sail saving much hard work to the fowler, but its use is attended with greater danger, and it is utterly unsuitable for rough water. A *shooting-boat* is therefore sometimes used; but in it the gun cannot be fixed level with the surface of the water, as in the punt, and still more is this the case with the *shooting-yacht*. The practice of the sportsman is therefore considerably different, and the best shots are generally made after the birds are on the wing. The helmsman of the shooting-yacht must be quick and skilful in luffing up, in such a manner as to cross the flight of the birds, that they may be well exposed to the gun, which is generally larger than the punt-gun. Great numbers of wild geese, swans, &c., are often killed from the shooting-yacht. In approaching the birds, the greatest caution is necessary, and the men in the yacht must be carefully concealed behind the bulwarks.

Notwithstanding the draining of the fen-lands, many of the decoys of the eastern coast of England are still very valuable, and in some instances, they afford a considerable part of the living of the parochial clergy. A good decoy-pond attached to a rectory adds not a little to its value. It is in severe winters that the decoy-pond is most productive. It must be in a secluded situation, and the proprietor

takes care to keep it as secluded as possible, permitting no use of the gun or rifle in its neighbourhood. An extent of three or four acres is about the best for a decoy-pond. Very large ones are found to be comparatively much less productive. The decoy-pond ought to be surrounded with trees and copse; reeds and sedges being permitted to flourish near the water. Several *pipes* are led off from the pond,

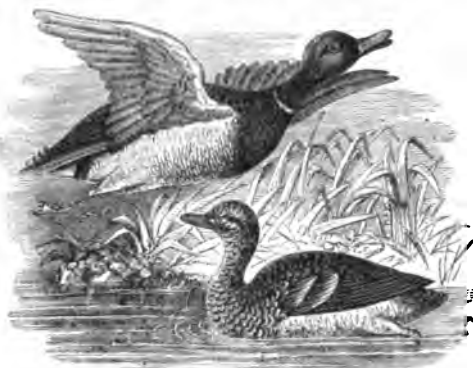

Fig. 3.—Wild-duck or Mallard, Male and Female.

in different directions, ditches of six or eight inches in depth, of a curved form, and becoming narrower towards the extremity. It is in these pipes that the wild-fowl are caught, particularly mallards, teal, and widgeons, and often in very great numbers. The length of the pipe is generally from sixty to eighty yards, its breadth at the mouth from twenty

to thirty feet, diminishing to two feet at the extremity, where it terminates in a tunnel-net, generally carried out on the dry land. The whole pipe is spanned with a light netting, spread upon semi-circular bars of iron rod, in an arch of about twelve feet above the water at the entrance, but becoming lower as the pipe becomes more narrow. To attract wild-fowl to the pond, and to induce them to enter the pipe, *decoy-ducks* are kept, constant inhabitants of the pond, and regularly fed. Wild-fowl come more readily to the pond because of their presence, and follow them also to the mouth of the pipe, and into it, when they come at the well-known whistle of the decoy-man, to feed on the grain which he scatters for them on the water. It is only thus that the decoy-ducks are of use. They are not trained in any way, nor do they display any intelligence beyond response to the whistle which invites them to their food. Very different is the case with the decoyer's dog, the *piper*, so called not from any vocal powers, but from his use in enticing birds into the pipe. The dogs best adapted for this purpose are of a peculiar breed, small, fox-like, and very lively and frolicsome. They are very carefully trained, and their peculiar qualities seem to be in some measure hereditary. On the convex side of the curve of the pipe, for about thirty or forty yards, instead of netting coming down to the ground, screens made of reeds are placed of height sufficient to conceal the decoyer; but they are placed obliquely, with narrow outlets between them, through which his dog may pass, and with bars in



Fig. 4.—Wild-fowl Decoy-pipe.

the intervals about 18 inches high, for the dog to leap over. When the wild-fowl have been attracted to the mouth of the decoy, and the decoyer, peeping through the screens, perceives that they are in the proper situation, he sends out the dog, which makes sportive gambols in their sight, and they are attracted by the strange object, as sheep are when a small dog plays about in the field where they graze. They enter the pipe in pursuit, as if for gratification of their curiosity, and the dog leaps over the first leaping-bar, and disappears behind the screens, where his master immediately rewards him with a piece of cheese or other delicacy. When the wild-fowl have advanced a little further, the dog is sent out again, repeats his gambols, leaps over the second leaping-bar, and gets a second piece of cheese. The curiosity of the birds seems to increase, and when they have proceeded far enough the man shews himself, whereupon a rush is made by the birds towards the far end, where they are captured. The dog is trained to keep perfect silence. A single bark would disperse the birds. The success of the

decoyer depends very much on the state of the weather, and he must consider the direction of the wind in order to the choice of the pipe he is to use. Into such details, however, we cannot enter. It is in the daytime, and not by night, that wild-fowl are captured in the decoy. They generally leave the decoy-pond at night for neighbouring feeding-grounds. The decoyer often finds it profitable not to attempt the capture of birds when they first appear on the pond, but to wait for a few days, when they congregate in greater numbers.

Decoys are of so great value that many acts of parliament have been passed for their regulation and protection. A decoy which has been established for twenty years enjoys certain privileges secured by law, particularly as to the quietude of its vicinity, which must not be disturbed by the firing of guns at wild-fowl apparently going to the pond, even by the proprietors of land over which they pass.

*Flight-ponds* alone remain to be noticed. These are used chiefly for the capture of pochards or dun-birds, which very seldom enter the pipes of the decoyer. The same pond is sometimes used both as a decoy-pond and a flight-pond. The pochard, having its legs placed far back, cannot rise from the water so suddenly as the wild-duck or widgeon, and skims the surface for many yards, proceeding by a very gradual ascent. To capture flights of pochards, nets are used, which are fixed to a cumbersome apparatus of poles at the side of the pond. The pond may be about seventy or eighty yards square. On an embankment, about ten yards from the water, strong posts are fixed, about twelve feet high, two together, and about fifty yards apart—the corners of the pond being generally occupied by trees. Further back, about fifty feet, are slighter posts, about fifteen feet high. Other posts are required for the working of the net, the position and use of which we cannot explain; but the purpose of the whole is that the net, which is of the form of a parallelogram, may be suddenly thrown up into the air. In order to this, it is attached to cross-bars, which work between the twin posts, and heavily-weighted boxes attached to two poles, aid in bringing it into an erect position when required. The fowler's skill relates very much to the moment of raising his net, which he does by drawing a bolt or trigger. The net ought to rise so as fully to confront the birds as they issue from the pond. Pens are formed on the embankment in front of the net of reed-screens about three feet

high, by two or three feet square, and the birds falling into them on being thrown back from the net, are caught, not being able to rise again. The number of pochards caught at once is sometimes very great. For full particulars concerning Wild-fowling, the reader is referred to Colonel Hawker's well-known work on *Shooting*, and to *The Wild-fowler* by Folkard.—An Act was passed in July 1876 *For the Preservation of Wild-fowl*, making it punishable by fine to kill them, or to use any instrument for that object, during the breeding season—15th February to 10th July.

Folkard, in his excellent work upon Wild-fowling, remarks that writers upon sporting literature generally apply correct terms to game and birds of the land, while water-fowl are invariably classed by them as 'flocks.' The modern terms, as applied to water-fowl, are, according to Folkard, as follows: 'A' herd of swans. A gaggles of geese (when on the water). A skein of geese (when on wing). A paddling of ducks (when on the water). A team of wild-ducks (when flying in the air). A sord or

suit of mallards. A company of widgeon. A flight or rush of dunbirds. A spring of teal. A dopping of ahedrakes. A covert of coots. A herd of curlews. A sedge of herons. A wing or congregation of plovers. A desert of lapwings. A walk of snipes. A fling of oxbirds. A bill of ruffs. A small number of wild-fowl, as ducks and geese (about thirty or forty), is termed a "trip." The same of widgeon, dunbirds, or teal, is termed a "banch;" and a smaller number (from ten to twenty) is called a "little knob." Of swans, it would be said, a "small herd;" and sometimes of geese, a "little gaggle," or a "small skein;" and so of ducks, a "short" or "long team."

WILD HUNT (Ger. *Wilde* or *Wühende Jagd*; also *Wüdes* or *Wühendes Heer*, Wild or Maddening host; *Nachtjäger*, Night Huntsman, &c.), the name given by the German people to a fancied noise sometimes heard in the air at night, as of a host of spirits rushing along over woods, fields, and villages, accompanied by the shouting of huntsmen and the baying of dogs. The stories of the Wild Huntsman are numerous and widespread: although varying in detail, they are uniform in the essential traits, and betray numerous connections with the myths of the ancient gods and heroes. The root of the whole notion is most easily discernible in the expression still used by the peasants of Lower Germany when they hear a howling in the air, 'Wode hunts' (*Wode jaget*), that is, Wodan or Odia marches, as of old, at the head of his battle-maidens, the Walkyries, and of the heroes of Walhalla; perhaps, too, accompanied by his wolves, which, according to the myth, along with his ravens, followed him, taking delight in strife, and pouncing upon the bodies of the fallen. The heathen gods were not entirely dislodged from the imagination of the people by Christianity, but they were banished from all friendly communication with men, and were degraded to ghosts and devils. Yet some of the divine features are still distinctly recognisable. As the celestial god Wodan, the lord of all atmospheric and weather phenomena, and consequently of storms, was conceived as mounted on horseback, clad with a broad-rimmed hat shading the face, and a wide dark cloak; the Wild Huntsman also appears on horseback, in hat and cloak, and is accompanied by a train of spirits, though of a different stamp—by the ghosts of drunkards, suicides, and other malefactors, who are often without heads, or otherwise shockingly mutilated. One constant trait of the stories shews how effectually the church had succeeded in giving a hellish character to this ghost of Wodan—when he comes to a cross road, he falls, and gets up on the other side. On very rare occasions, the Wild Huntsman shews kindness to the wanderer whom he meets; but generally he brings hurt or destruction, especially to any one rash enough to address him, or join in the hunting cry, which there are many narratives of persons in their cups having done. Whoever remains standing in the middle of the highway, or steps aside into a tilled field, or throws himself in silence on the earth, escapes the danger. In many districts, heroes of the older or of the more modern legends take the place of Odia; thus, in Lusatia and Origan, Berndietrich, that is, Dietrich of Bern; in Lower Hesse, Charles the Great; in England, King Arthur; in Denmark, King Wademar. The legend has also in recent times attached itself to individual sportsmen, who, as a punishment for their immoderate addiction to sport, or for the cruelty they were guilty of in pursuing it, or for hunting on Sunday, were believed to have been condemned henceforth to follow the chase by night. In Lower Germany, there are many such stories current of one Hakkelberand, whose tumb even

is shewn in several places. Still, the very name leads back to the myth of Wodan, for Hakkelberand means literally the mantle-bearer (from O. H. Ger. *habtū*; O. Norse, *hokull* or *hebla*; Ang.-Sax. *hacela*, drapery, mantle, armour; and *bera*, to bear). The appearing of the Wild Hunter is not fixed to any particular season, but it occurs frequently and most regularly in the twelve days between Christmas and Epiphany.

Another version of the Wild Hunt is to be found in the legend prevalent in Thuringia and the district of Mansfeld. There the procession, formed partly of children who had died unbaptised, and headed by Frau Holle or Holda (see BERCHTA), passed yearly through the country on Holy Thursday, and the assembled people waited its arrival, as if a mighty king were approaching. An old man, with white hair, the faithful Eckhart (see TANNHÄUSER and VENUSBERG), preceded the spirit-host, to warn the people out of the way, and even ordered some to go home, so that they might not come to hurt. This is the benign goddess, the wife of Wodan, who, appearing under various names, travels about through the country during the sacred time of the year. This host of Holda or Berchta also prefers the season about Epiphany. In one form or other, the legend of the Wild Hunt is spread over all German countries, and is found also in France, and even in Spain. In Lower Germany, it has been preserved in an older and purer form than in Upper Germany. It has probably some connection with Celtic mythology, but not apparently with the Slavonic.—See Grimm, *Deutsche Mythologie*.

WILFRID, SAINT, an Anglo-Saxon bishop, was born, of noble parents, in the kingdom of Bernicia in 634. He was remarkable when a boy for his good looks, graceful manners, and ability. He became at 14 the attendant on a Saxon nobleman, who had retired to spend the last years of his life in the monastery of Lindisfarne. There his attention was directed to the controversy as to the time of celebrating Easter (q. v.) existing between the two sections into which the Anglo-Saxon Christians were divided; the one advocating the Roman practice, which was that of the continental churches generally, the other adhering to the Scoto-British. W. resolved to visit Rome to ascertain which was in the right, and thither he went at the age of 19, with recommendations from the courts of Kent and Bernicia. He returned to England a warm partisan of the Roman party. From Alfrid, king of Northumbria, he received a grant of land and a monastery at Ripon, and there, in 664, he was ordained a priest. The synod of Whitby, which met in 664 to discuss the disputed questions between the two parties in the church, was attended by the most distinguished members of both, and among others, by Colman, Bishop of Lindisfarne, and Wilfrid. We have a curious account of this conference. The king presided, and seems at first to have been puzzled by the arguments, but he noticed that Colman always referred to St Columba, W. to St Peter—and it struck him that the relative power of these saints had a close connection with the points at issue. 'St Peter,' said W., 'is the rock on which the Lord founded his church, and to him he intrusted the keys of heaven.' 'Did St Columba not receive the same power?' asked the king. Colman could not say he had. 'Then you both admit that God has given the keys to St Peter?' Both said they did. 'Well,' continued the king, 'if it is so, I shall not oppose him. Were I to do otherwise, I might find no one to open the gate when I came there; St Peter might turn his back on me. We must not offend him.' The council and audience were carried

away by this argument, and the king decided in favour of the Roman party. W. was afterwards named Bishop of York, but he did not enter into possession of his see until 869. He then surrounded himself with great pomp, built churches, one of which, at Hexham, was said to be the finest north of the Alps, and strove to oppose the ecclesiastical to the royal power. A quarrel followed with the new king of Northumbria, named Egfrid, and W. was deposed. He started on a journey to Rome, to make a personal appeal to the pope; but he was driven by a storm to the coast of Friesland, the inhabitants of which were still pagan. There, however, he was hospitably received by the king. To his arrival, the people attributed an excellent fishing-season and abundant harvest. He was asked to preach, and he did so in his own Anglo-Saxon tongue, which was perfectly intelligible to the Frisians. Such was the effect, that he baptised many thousands of the people, and all the princes. The event is one of the most memorable in the history of Northern Germany and Scandinavia, for with it began the conversion of these countries to Christianity by Anglo-Saxon missionaries, and the introduction into them of the arts and knowledge inherited from ancient civilisation (see BONIFACE; WILLIBROD). W. reached Rome, and the pope decided in his favour; but on his return to England, the king gave no heed to the decree, and committed him to prison. He escaped, however, to the Weald of Sussex, where he converted the pagan inhabitants. He was afterwards recalled to his see; and a proposal was made to elevate him to the primacy, but he was still opposed, as the leader of the Roman party, and ultimately he was deposed, and excommunicated. He again went to Rome, remained there some years, returned to England in 705, and died at Oundle, in Northamptonshire, in 709.—There is a very interesting sketch of the saint's life given in the 19th chapter of Bede's *Ecclesiastical History*. See also Lappenberg's *History of England under the Anglo-Saxons*.

WILHELMSHÖHE. See CASSEL.

WILKES, CHARLES, American naval officer and explorer, was born in New York in 1801, and entered the navy as midshipman in 1816, served in the Mediterranean in 1819—1820, and in the Pacific in 1821—1823, where he was selected for a separate command. In 1826 he gained the rank of lieutenant, and in 1830 was appointed to the *Dépôt of Charts and Instruments* at Washington, and was the first in the United States to set up fixed astronomical instruments and make observations. After being employed in surveying George's Bank, he was, in 1838, appointed to the command of an exploring expedition of five vessels and a storeship, in which he surveyed the Samoan group in the Pacific, discovered many islands and the antarctic continent, which he coasted through 70° of longitude, explored the Fiji group. In 1842, he was made a commander, and published a *Narrative of the United States Exploring Expedition* (5 vols. 1845), for which he received the gold medal of the Royal Geographical Society. Of the 11 supplementary vols., he was the author of the one on Meteorology; and in 1849, of a volume on California and Oregon, entitled *Western America*. In 1856, he published his *Theory of the Winds*. Having been promoted to the rank of captain in 1855, he, in 1861, took command of the United States steamer *San Jacinto*, and forcibly removed from the British mail-steamer, *Trent*, Messrs Mason and Slidell, commissioners of the Confederate States to England and France, and conveyed them to Boston, receiving the thanks of Congress and the acclamations of the people; but

at the demand of the British government, his act was disapproved, and the commissioners restored. In 1862, he was promoted to the rank of commodore, and in 1863 commanded a squadron in the West Indies. In 1866 he was commissioned as rear-admiral on the retired list.

WILKES, JOHN, a celebrated public character, was born in London, October 17, 1727. His father, a brewer or distiller at Clerkenwell, sent him when a lad to the university of Leyden, where he received an excellent education. On his return to England in 1749, he married a Miss Mead, an heiress, ten years his senior. His good manners, learning, ready wit, and open table secured him many friends, but extravagance and dissipation soon involved him in difficulties. He and his wife separated, and in a lawsuit which followed, facts came out most damaging to his character. He was nevertheless named High Sheriff of Buckinghamshire, and in 1757 returned to parliament as member for Aylesbury. In the House, he joined in the popular clamour against Lord Bute; and in June 1762, founded a paper entitled the *North Briton*, in which he denounced him with such vigour and success as to drive him from the ministry. He attacked with equal bitterness the next ministry, insinuating that although Mr Greville was nominally at the head of affairs, Lord Bute still had the ear of the king. In the 45th number of the *North Briton*, he charged the king with having uttered a falsehood from the throne, and in consequence, his house was entered, and his papers were seized. He was himself committed to the Tower, on a general warrant. But he was released by Chief-justice Pratt, on account of his privilege as a member of parliament. His paper was burned, by order of the House of Commons; but a riot ensued, shewing that public sympathy went with Wilkes. A prosecution was next instituted against the Under-secretary of State by W. for the illegal seizure of his papers; and he obtained £1000 of damages—a declaration being at the same time made by the Chief-justice that general warrants are illegal. W. then went to France, on the plea of bad health, and was expelled from the House of Commons. In his absence, he was convicted of having printed privately an obscene poem, of which he was one of the authors. It was hoped that evidence of his immoral character would disgust the public with him. But the copy of the book on which the prosecution had been founded had been obtained surreptitiously from a printer employed; and this fact becoming known, the steps taken by the government, instead of injuring W., only added to the outcry against ministers. On the formation of a new ministry under the Duke of Grafton, W. returned to England, and becoming a candidate for Middlesex, harangued great crowds in London. After his election, he was arrested, in consequence of his outlawry; and on the way to prison he was rescued by a mob. He, however, after it had dispersed, voluntarily gave himself up to justice. When parliament met, a crowd assembled to convoy him to the House of Commons. A riot took place, and the military were ordered to fire on the mob in St George's Fields. Many persons were wounded, and one was killed. The coroner's jury who sat on the body returned a verdict of murder against the magistrate who had given the order to fire; and he was tried for that crime, but acquitted. W. secured a copy of a letter from Lord Weymouth to the chairman of the Lambeth Quarter Sessions, in which it was recommended that the military should be employed to suppress disturbances in London. It was published with a preface by W., in which he charged the Secretary of State with having planned 'the massacre in St George's Fields.' The House declared

the preface to contain a seditious libel, and W. was again expelled. He was after this re-elected several times as member for Middlesex; but the elections were declared void. Colonel Luttrell, who vacated his seat and opposed him, obtained only 300 votes; but he was declared to be duly elected, in defiance of a protest from the whole country. W., still in prison, was now recognised as the champion of public liberty, and became the most popular man in England. In 1769, he obtained a verdict against Lord Halifax in the Court of Common Pleas, with £4000 damages. He was shortly after discharged from prison on giving a bond for good behaviour during seven years. In 1774, he was chosen Lord Mayor of London, and again returned for Middlesex, which he continued to represent for many years. In 1782, the resolution by which he had been declared incapable of re-election was expunged from the minutes of the House of Commons, as subversive of constitutional rights. The other resolutions relating to W. were at the same time expunged. Two years later, he withdrew from the House of Commons. He died 27th of December 1797.

**WILKIE, SIR DAVID**, a distinguished Scottish painter, was born in Fifeshire, at Cults, of which parish his father was minister, 18th November 1785. His boyish passion for art was too strong to be resisted by his father, who, with much reluctance, sent him, in 1799, to study in the Academy at Edinburgh. Here he greatly distinguished himself; and returning home, in 1804, he painted his 'Pitlessie Fair,' a piece in which already his peculiar genius is pronounced, and which brought him the sum of £25. The price seems paltry; but for the work of an unknown country stripling in an original walk of art, it was perhaps to be considered handsome. Shortly after, W. proceeded to London, intending to return to Scotland after a year or two of study; but the great success of his picture, 'The Village Politicians,' determined him to settle in the metropolis. Not that, pecuniarily, he was very greatly benefited, £30 being all that the Earl of Mansfield could with difficulty be got to pay for the picture, though aware that, on a point of honourable scruple, the artist had refused repeated offers of £100; but the originality and humour of the work greatly captivated the public, and at once established the reputation of the painter, who had soon commissions in plenty, at greatly advanced prices. In 1809, his brethren of the Royal Academy ratified the favourable verdict of the public by electing him an Associate; and two years afterwards, he was advanced to the rank of Academician. In 1814, in company with his friend Haydon, he visited Paris, and inspected with great delight the art-treasures at the Louvre. Though his father had died some years before, and his mother and sister were now living with him at Kensington, in 1817 he made a run into Scotland, and while the guest of Scott at Abbotsford, painted his well-known picture of the great poet and his family. During these years, W. had been engaged on the series of pictures on which mainly his fame rests; pictures familiar by engraving to every one ('The Blind Fiddler,' 'Card Players,' 'Rent Day,' 'Jew's Harp,' 'Village Festival,' 'Blind Man's Buff,' 'Distraint for Rent,' 'The Penny Wedding,' 'Reading of the Will,' &c.), in which the homely humours of humble life are expressed by a vehicle appropriately simple, and—though scarce in the higher sense to be called colour—of charming purity and transparency. In this style, distinctively his own, his genius is commonly held to have culminated in 'The Chelsea Pensioners listening to the News of Waterloo,' which was painted during the years 1820—1821. This work was a commission from the Duke of

Wellington, who paid the artist 1200 guineas for it. Subsequently, he changed his style, sought to emulate the depth and richness of colouring of the old masters, and deserting the homely life, which he could treat so exquisitely, chose elevated, and even heroic subjects, to the height of which he could never rightly raise himself. The florid picture, painted in 1830, of 'George IV. entering Holyrood,' which, though not without its fine points, can delight no one but a flunkey, gave the first hint of the change; and no doubt a tour over nearly the whole continent, which he made for his health, in 1824, everywhere, of course, intent upon the grand old masterpieces, did something to stimulate the new and unwise ambition. By common consent, it has been adjudged unwise; and W. remains, and will remain, memorable, not for the quasi-high art of his later years, but for the simpler, truer, and, in every right sense, higher art of his earlier time. He never, however, ceased to be popular, and honours continued to be showered upon him. On the death of Sir Henry Raeburn, he succeeded him as Limner to His Majesty; in 1830, he was made Painter in Ordinary to His Majesty, in room of Sir Thomas Lawrence deceased; and in 1836, the honour of knighthood was conferred upon him. W. had never been robust, and his health now began to give way seriously. In 1840, seeking to re-establish it, he once more left England; but he did not find what he sought. Having visited Syria, Palestine, and Egypt, he died on his voyage home, off Gibraltar, and his body was committed to the deep.

As an illustrator of Scottish character and manners in humble life, W., in his best pictures, may take rank with Burns in poetry, and Scott in fiction. As a man, he was kindly, warm-hearted, and of essential generosity of disposition.—See *Life and Letters of W.* by Allan Cunningham (1843).

**WILKINSON, SIR J. G.** See SUPR., Vol. X.

**WILL** is, in English Law, a writing by which a person entitled to property declares what is to be done with such property after his death. Though, by the Wills Act, 1 Vict. c. 26, a writing is indispensable to a will, yet there is an exception in the case of soldiers or sailors who, from their occupation, and while in actual service, are allowed to make a verbal or nuncupative will; and this exception only extends to their personal estate, for they must make a written will, like other persons, in order to deal with their real estate. An infant, or person under 21 years of age, cannot, since 1838, make a will. A married woman can only make a will if she has separate property, or her husband assents to her will, or she makes the will by virtue of some power of appointment vested in her. As a general rule, it is absolutely necessary that the party making a will should have a free and disposing mind at the time; and hence, if he or she is a lunatic, or drunk, or acting under compulsion, fear, or undue influence, the will is invalid. There is no limit as to the time preceding death when a will may be made: it is enough that the testator was at the time capable and sensible, though he died immediately after. A will must be executed in presence of two witnesses, who see the testator sign the will, or at least hear him acknowledge it. But there is no particular form of words in which a will must be made for the purpose of disposing either of realty or personality. The will must be in writing, but it need not be in ink or written continuously. The testator may sign by his mark or by an assumed name. Though a seal is not equivalent to signature, yet a person may have a stamp to sign papers with, and that will be sufficient for a will also. The testator need not sign the will if he authorise some one to do so for him in his



presence. The signature must be at the foot or end of the will; but if it is placed so as to lead a court to the conclusion that it was intended to give effect to the will, that will be enough. Though the witnesses need not know it is a will, they must be present together when the testator signs it or acknowledges his signature. The witnesses must sign their names or make their marks. A legatee, or the wife or husband of a legatee, may be an attesting witness, but by being so, he or she will forfeit any legacy left to him or her by the will. But one may be an executor though he attests the will. A will is revoked by the marriage of the testator or testatrix. The mere fact of making a subsequent will does not of itself operate to revoke a prior will, unless there is some inconsistency in whole or in part; and, as a general rule, no will will be revoked by any presumption of an intention on the ground of an alteration in circumstances. The usual way of revoking a will is to burn, tear, or destroy it with the intention of revoking the same; or by executing another will which expressly revokes the prior will. When a testator tears or cuts away that portion of his will containing the signature and attestations, the presumption is that he intended to revoke the whole. But merely cutting out a part of the will, or striking it through with a pen, does not amount to a revocation. It is to be borne in mind that, in order to revoke by tearing, &c., there must be an intention to revoke, so that a mere accidental tearing will prevent the act from having the force of revocation. When there are interlineations or alterations in a will, it is presumed these are made after signature, unless there is evidence to prove the contrary. A will which is in any manner revoked can only be revived by re-execution, or by a codicil shewing an intention to revive it; but many nice questions have arisen as to what causes a will to revive.—In Scotland, a will is used only to denote a testament affecting personal or movable property; while a will affecting real or heritable property can only be made by way of a deed having a present operation. A will or testament may be written in the handwriting of the testator, and if signed by him, will not require witnesses, being then called a holograph will. In other respects, wills are subject to nearly the same rules which prevail in England with respect to revocation, &c. Wills of real property are called Dispositions or Deeds, and have a present operation, and the mode in which they are drawn up is that of conveying the property to the donee, but reserving the testator's liferent. The effect of this is that the testator retains the property in his own hands while he lives; but the moment he dies, the disposition *mortis causa* comes into play, and the donee then takes the property, subject to the deed. See DEED.

**WILL.** The Mind is divided into three distinct functions—Feeling (see EMOTION), Intellect or Thought (see INTELLECT), and Will or Volition. Under Will, is included the putting forth of active energy to move our own organs, or change something about us; but all energy is not voluntary energy. The peculiarity of action from Will, in contrast to other activities, as the powers of nature—wind, gravity, &c., is its being preceded or inspired by feelings, or by the pleasures and pains of an individual mind. Hence, Will is defined, *action prompted by feeling*. The feelings that prompt the will, called motives, are our pleasures and our pains; pleasure felt or imagined moves us to continue and increase the pleasurable state; pain urges us to work for the abatement of the pained condition.

In the maturity of the powers, a human being, or animal, can perform a great variety of specific actions at the bidding of the various wants or desires.

The sensation of thirst induces at once a series of complicated movements, ending in the relief of the painful feeling. But no man or animal is born with the ability to make a journey to a well, whenever thirst is felt; the human infant cannot even perform the voluntary act of lifting anything to its mouth. Our most ordinary voluntary movements are the result of an education; and the explanation of the volitional energies consists in ascertaining what are their beginnings or germs in the mental constitution, and how they are brought to the finished state.

Three different facts of our nature appear to concur in forming the collective aptitudes of the Will.

I. The fact termed Spontaneous Activity, or the self-acting energy of the system, whereby movements arise without waiting the stimulus of the senses. Any actively disposed animal, after rest and nourishment, begins to move merely through a surplus of nervous power, and not because it is awakened out of dormancy by the solicitations of sensible objects. Without this tendency to commence movements in the first instance, there would be no apparent basis for the voluntary acquirements. See SPONTANEITY. In imitation with the voice, for example, we must begin by uttering sounds, and then discover by the ear their agreement or disagreement with the sounds heard.

II. The second fact is the tendency to abide by a movement giving pleasure, and to relax a movement coincident with pain. From the first moments of sentient life, every animal appears to possess this property. If a movement happens to coincide with an access of pleasurable warmth, the animal maintains, and possibly increases, the movement: if the warmth passes into pain, the movement ceases. The infant sucks so long as the feeling is pleasurable, and ceases when satiety comes on. This power may be an offshoot of the general law connecting pleasure with an increase, and pain with a diminution of vital energy. See EMOTION. However arising, the fact is unquestionable, and is exemplified all through life. Without our going through any process of deliberation or resolution, we sustain an activity that brings us agreeable sensation, and remit an activity ending in pain. We keep our eyes fixed on a cheerful flame, and withdraw them when the glare is overpowering: the process is self-acting and intuitive.

III. The third fact is the operation of the Retentive power of the mind, in joining together, by a permanent association, movements and feelings that have existed together for some time. This is a branch of the great law of Contiguous Association. See ASSOCIATION OF IDEAS. The Will is an educated function, and education supposes the plastic or fixing operation expressed by the above-named law.

But the chief nicety in explaining the growth of the Will consists in shewing how the proper movements and feelings originally came together. This is the problem of the Development of Voluntary Power, which would demand an extended illustration. A brief indication of the process must suffice.

One of the easiest examples is the moving of the head to follow a light or other object pleasing to the gaze. This power is not possessed at the commencement of life, and the process of arriving at it is supposed to be as follows. The child has its eyes fixed on the light, and enjoys the luminous excitement. The light is moved to one side, and is therefore lost to the direct gaze, and there is no power to recover it. An accidental movement of the head, occurring by mere spontaneity, carries the eyes round to encounter the light again, or to follow it as it moves; the consequence is, that the recovered

pleasure of the spectacle sustains the movement that brings it. Now, every such coincidence tends to become fixed, by the law of plastic association; and after a few repetitions of the accidental concurrence, there is a connection formed between the optical impression and the movement that is found to go along with and sustain it. Thus it is, that a movement of the object to the right hand, which leaves a characteristic trace on the visual organ, becomes associated with a movement of the eyes and the head to the right hand; and whenever the optical fact arises, the movement is apt to follow. This makes one distinct item in our volitional acquisitions; one instance of the power of definitely acting to a definite feeling.

Another example might be taken from the feelings of warmth and chillness—both very powerful sensations in all animals. One of the most obvious means of attaining comfortable warmth is to crouch and bring all the limbs close to the body. A very early experience would connect this posture, accidentally hit upon, with the comfortable sensation; and, by virtue of the primary law of the mind, connecting pleasure with exalted energy, the movement, once coinciding with the pleasure, would be sustained and adhered to, so long as it brought the pleasure; and in course of a few repetitions, a definite association would be formed between the state of chillness and this mode of relieving it. By a more lengthened and round-about process, more complicated associations would be formed, such as coming close to the warm body of a companion, running into shelter, approaching a fire, going into the sunshine, &c.; but, in all cases, the only mode of attainment that can be pointed out, is (1) the concurrence of spontaneous movements with feelings of pleasure, or relief from pain; (2) the maintenance of those movements by the first law of self-conservation; and (3) the forming of a link between the two by the force of plastic association.

The illustration may be varied by viewing the case from the side of pain. The immediate and direct result of pain, from the dawn of sentient life, is to lower active energy for the time, and therefore to arrest whatever movements are in progress: this is the general rule, although there is an important exception in the case of acute or pungent pains, which, in the first stage, stimulate and excite the active members. Hence, when a movement happens to coincide with a pain, it is liable to be arrested; a bitter morsel in the mouth makes one cease chewing, by reducing the active power for the moment. The primitive endowment of the system would lead to nothing further, until some chance movement of the mouth tended to get rid of it, which movement would be promoted and sustained by the pleasurable feeling of relief, which is the operation of the principle from the other side.

The growth of the Will is conspicuously shewn in Imitation, which is an acquired aptitude, and a department of our voluntary power. In imitation, there must be (1) a spontaneous tendency to move the active organs concerned—the voice, the mouth, the hands, &c.; (2) a sense of the effect, with a certain pleasure in attaining it; and (3) a cementing process, as already described. In learning to speak, the infant must first articulate something of its own accord; the resulting sound affects its own ear, and is discovered to coincide with a sound heard from others. The frequent repetition of the articulate effort leads to its being coupled in the mind with the sound that it gives; and when this association is mature, the sound heard will induce the articulating movement; and this is the power of imitation. But previous to the opportunity of associating the exertion of the mouth, throat, and lungs

with the sound emitted, there does not appear to be any capability to imitate articulate sounds. The same would apply to imitation by the hands.

The Will in its full development includes not merely a series of associations of movements with the ordinary pleasures and pains, but also the power of performing actions to the word of Command, the Imitative faculty just discussed, and the power of acting from a mere Wish to perform a certain action, or to produce a certain effect upon things about us—as to open a window or stir the fire. It might be shewn that all these various aptitudes grow, by successive stages, out of the three fundamental facts above described. The process involves many struggles and failures, from there being so much in it depending on accidental commencements; hence one reason of the slowness of the early education of human beings.—See Bain on *The Emotions and the Will*. See also FREE-WILL.

WILLEMS, JAN FRANZ, a distinguished Flemish philologist and writer, and noted as one of the originators of the great Flemish national movement, was born, in 1793, at the little village of Bouchout, near Antwerp. W., at the age of twelve, was sent to the town of Lierre, to learn singing and music, for which he had early evinced considerable aptitude. At Lierre, which continued to be the seat of some of those ancient Belgian literary associations known as 'Réderyk-Kamers,' or Chambers of Rhetoric, mysteries and other scenic representations were given from time to time in connection with these institutions; and during W.'s residence in the town he was frequently called upon to take part in these singular entertainments, a circumstance to which he ascribed his first impulse towards the study and cultivation of the old Flemish language and literature. The talents which he exhibited in his acting, and in the composition of satirical verses, attracted the notice of several influential persons at Lierre, through whose agency he was sent to Antwerp, to study in the office of a notary; and in 1811, he contended successfully for the prize awarded for the best poem on the battle of Friedland and the peace of Tilsit. From this period, his poetical and dramatic compositions followed each other in rapid succession. His ode *Aen de Belgen* (To the Belgians), which appeared in 1818, in which he exhorted his countrymen to resume the use of their native Flemish, and his clever treatise on *De Nederduytsche Taal en Letterkunde* (1819—1824), in which he traced the history of the Flemish and Dutch tongues from their common origin to their gradual but slight divergencies, marks an epoch in the literary history of Belgium. The Dutch government shewed their sense of his anti-French tendencies by giving him the post of Keeper of the Archives at Antwerp, while the Royal Institute at Amsterdam elected him a member of its learned corporation; but the Catholic party in Belgium resenting the attempt made by W. to refer the decline of Belgian national renown to the abandonment of the Flemish vernacular, looked upon his writings with mistrust; and in 1830, when Belgium was definitely separated from Holland, the dominant Belgian party deprived W. of his office, and left him for a time in obscurity and neglect. In 1835, chiefly through the influence of his old opponent, S. Van de Weyer, he was, however, promoted to the place of Keeper of the Archives at Ghent, where he continued to reside in the enjoyment of numerous literary successes and national honours, till the period of his death, which took place in 1846. W. had the satisfaction, during the latter years of his life, of seeing the gradual growth of the Flemish movement, which, since his death, has continued to advance with steady progress,

and has resulted in the formation of many literary societies, the publication of numerous literary and historical remains of the old Flemish, and a more general cultivation of the vernacular. Among the numerous Flemish works published by W., special notice is due to his version of the medieval poem of *Reineke Vos*, or *Reynard the Fox*, for which he claims a Flemish origin; while, among the more important of his strictly national works, we may instance his editions of the rhymed chronicles of Jan de Klerk and Jan van Heelu, and his *Mengelingen van Vaderlandschen Inhoud*.

**WILLEMSTAD**, a fortified town in North Brabant, on the Hollandsdiep, 19 miles north-west of Breda, erected by William I., Prince of Orange, to protect the traffic between Holland and Zeeland. There are 7 bastions, 2 forts, 2 inundation sluices, and a good haven. Pop. (Jan. 1, 1870) 1826. In 1793, Baron van Boetzelaar successfully defended W. against the French, under Dumouriez, who, after a heavy bombardment, were obliged to break up the siege. It was the birthplace of the naval hero, Callenberg, who, when De Ruyter fell in action with the French, succeeded to the command.

**WILLEMSTADT**, chief town of the island of Curaçao (q. v.).

**WILLET** (*Symphemia semipalmata*), a bird of the family *Scolopacidae*, a native both of North and South America. It is about fifteen inches long; dark ash-colour above; the rump, upper tail coverts, and under parts white, the tail grayish, the tail-feathers, all except the two middle feathers, spotted with dark-grayish brown; the secondaries of the wings white, with dark-brown spots. The bill is two inches and a half in length, very thick, compressed; the wings long; the legs long and strong, the tail short and nearly square; the toes partially webbed. This bird is found in summer as far north as the coasts of New England; in winter, it retreats to the Gulf States. The flesh is highly esteemed, and the eggs are reckoned a delicacy. Willets are usually seen in flocks, and generally near the sea. The name is derived from the note.

**WILLIAM I.**, king of England, commonly called *William the Conqueror*, was the illegitimate son of Robert, surnamed *Le Diable*, Duke of Normandy. He was born in 1027, and succeeded to the dukedom on the death of his father, in 1035. Previous to his father's death, he had been intrusted to the care of Henry I. of France; but it was owing rather to the quarrels and jealousies of his own subjects than to the protection of Henry, that he was able to preserve his dominion intact until his arrival at manhood. In 1047, he gained a victory at Val de Dunes over a powerful competitor, Guido of Macon; and in 1054, he defeated another rival, Guillaume, Count of Arques, being aided in both contests by the French. His ambition now began to extend to England, where Edward the Confessor reigned at this time. On visiting England, W. found his hopes of succeeding Edward much strengthened by the dominance of Norman influence in the councils of that monarch. On Edward's death, however, the Witenagemôte (q. v.) chose Harold (q. v.) to fill the English throne; ignoring, according to the monkish chroniclers of Norman bias, in so doing, an alleged bequest of Edward in favour of William. The Norman asserted his pretended rights by a powerful invasion, and the result was his acquisition of the crown by the famous battle of Hastings, October 14, 1066. Harold having been killed in the fight, the Saxons chose Edgar Atheling as his successor. Edgar was, however, soon obliged to yield, and W. was crowned king of England,

December 25, 1066; from which day his reign is dated. Edgar remained for some time at his court, and his treatment of the conquered people was at first mild and conciliatory; but his savage suppression of a rebellion, which broke out in the north in 1070, laid the foundation of an irreconcilable antipathy between Saxon and Norman, which rendered a continuance of this policy impossible. Before long, W. began to rule like a true conqueror. Everywhere, the Saxons were reduced almost to a state of slavery. The higher classes were deprived of every office of church and state, while the people were ground down by new and oppressive taxes. Fortresses were erected over the country, and garrisoned, to overawe the Saxon inhabitants. In 1072, the Saxons were so far reduced to submission, that W. found time to lead an army across the border into Scotland, in order to punish the king of that country, Malcolm Canmore, for having received and protected Edgar Atheling. The Conqueror marched as far north as the Tay, and received a nominal submission from Malcolm. In 1085, an attempt was made to overturn the power of the English king by Canute, king of Denmark. A great naval armament was got together for the purpose of invasion, but the enterprise was abandoned, its abandonment being caused partly by bad luck, and partly, it is supposed, by a skilful application of W.'s treasure. The tax called the *Danegeld* (q. v.) was re-imposed to meet the expense caused by the threatened war. Disputes having arisen between W. and his son Robert respecting the duchy of Maine, which had come to W. through his marriage, November 2, 1053, with Matilda, daughter of Baldwin, 5th Earl of Flanders, father and son took up arms against one another. The dispute was ultimately adjusted, through the intercession of Queen Matilda. Most of the latter part of W.'s life was spent in Normandy, the government of England being entrusted mainly to his half-brother, Odo, bishop of Bayeux. W. was of a corpulent habit of body, at which fact it seems that his brother-monarch, Philip I. of France, had pointed some sarcasm. W., in a fit of wrath, raised an army, and invaded France. He took the city of Mantes, and set it on fire; but while in full enjoyment of the blaze, his horse, stumbling on some hot embers, threw him, and the injury he received proved fatal. He died September 9, 1087. Stern and ruthless as W. undoubtedly was, he yet knew how to govern a nation and protect it from foreign aggressions. For more than two centuries England had been harassed by the frequent descents of piratical hordes. He put an end to these. Never after W.'s time did a Norse rover venture to shew face on the English coast. In the common administration of justice, he was royally impartial; many of his severities are even referrible in part to his thorough hatred of anarchy, while his attitude towards the church is admirable. He clearly defined the limits of ecclesiastical judicature, and when the formidable Hildebrand desired that the conqueror should do homage to him for the kingdom of England, the latter boldly refused.

**WILLIAM II.**, king of England, surnamed *Rufus*, second son of William the Conqueror, was born in Normandy in 1056. He was educated by the celebrated Lanfranc, Archbishop of Canterbury. He was the favourite son of his father, who, on his deathbed, recommended him to the barons and prelates as his successor to the crown of England. W. was, at the time of his father's death, along with him in Normandy. But no sooner had the event taken place than he set out for England. Landing at Dover, he obtained possession of its castle and of several other fortresses. He then presented

himself to Lanfranc, who proposed him to the nobles and prelates as their king. No opposition was offered, and W. was crowned on September 26, 1087. Meanwhile, his elder brother, Robert, had entered upon possession of the duchy of Normandy. The relative position of the brothers was such as, in these times, was sure to lead to war between them. Robert, at the instigation of Odo, Bishop of Bayeux, endeavoured to excite an insurrection in England. This attempt having failed, W., in revenge, invaded Normandy in January 1091. An arrangement having been ultimately come to through the mediation of Philip I. of France, Robert and W. then turned their united arms against their third brother, Henry, who had purchased from Robert the district of Cotentin, comprising nearly one-third of Normandy. The fortune of war went against Henry, who was driven into exile. Returning to England, W.'s next enterprise was an invasion of Scotland. The life of W. seems to have been a continual scene of strife. Returning from Scotland, he felt himself called upon to renew the contest with his brother, who had, meanwhile, strengthened himself by an alliance with Philip of France. A pecuniary payment, however, by W. to Philip soon dissolved the bond between him and Robert. W. would now, doubtless, have taken signal vengeance on his brother, had he not been recalled to England by disturbances in Wales and in the north. In the year 1096, Robert, having resolved to go to Palestine, sold his duchy of Normandy to W., for £10,000. This transaction led to a contest between W. and a chieftain named Helle de la Flèche, who had all along disputed Robert's right to the Maine district of Normandy. Helle was not, however, able to withstand the English monarch, who now took the field against him. He was obliged to disband his forces and take to flight. This was the last warlike achievement of William Rufus. He was shot (it is said, accidentally, though there appears equally good reason to believe the act intentional) by an arrow, supposed to come from the bow of Sir Walter Tyrrel, while hunting in the New Forest, on August 2, 1100. His body was found by a poor charcoal-burner, who conveyed it in a cart to Winchester. W. inherited the courage, energy, and political talent of his father, but he was ruthless and unprincipled.

WILLIAM III., king of England, was the posthumous son of William II. of Orange, and Mary, eldest daughter of Charles I. of England. He was born in 1650. The alliance of his family with the Stuarts excited the jealousy of Oliver Cromwell, and by his influence, the young prince and his descendants were declared to be excluded from the Stadtholdership of the United Provinces. W. 'found himself,' says Macaulay, 'when first his mind began to open, the chief of a great but depressed and disheartened party, and the heir to vast and indefinite pretensions, which excited the dread and aversion of the oligarchy, then supreme in the United Provinces.' The restoration of the Stuarts, however, in England greatly improved his prospects; and on the murder of De Witt, W., then in his 22d year, was chosen Stadtholder. The republic was at this time carrying on an apparently hopeless war with its powerful neighbour, Louis XIV. of France; but by the wisdom and determination of the young Stadtholder, the contest, which lasted for nearly seven years, was in 1678 terminated by the treaty of Nimeguen, in a manner highly advantageous and honourable for the United Provinces. A few years before, their ruin had seemed inevitable; and the fame of W. became great over Europe. Shortly before this event, he had married his cousin, the Princess Mary, eldest daughter of the

Duke of York, afterwards James II. of England. This marriage, entered into solely from political considerations, did not at first prove a happy one. W. seems to have been jealous of his wife's position, and too reserved to give utterance to his feelings. According to Macaulay, a complete explanation and reconciliation were ultimately brought about by the agency of Bishop Burnet.

In 1686, W. became the head of a league formed among the Protestant princes of Germany, the kings of Spain, Sweden, and others, having for its object to curb the power of Louis XIV. The treaty by which the alliance was constituted was signed at Augsburg in July 1686. In England, the tyranny of James II. was now beginning to estrange from him the affections of every class of his subjects. The eyes of all were turning towards the Stadtholder as their only hope. Having formed his resolution, W. conducted his operations with great secrecy and skill. On the 5th November 1688, he landed at Torbay, with an army of 15,000, composed of English and Dutch. His success was rapid and bloodless. Men of influence of all parties gave him their presence and support; and on the 18th of December following, he entered London triumphantly as a national deliverer. The adherents of James held out for some time in Scotland and Ireland; but the death of Dundee ended their resistance in the former country; while in the latter it was ended in 1691, after a vigorous contest of two years, in which the Stuart party had, in most cases, the advantage. The object of W., in accepting the crown of England, was probably not so much to free the English nation from the tyranny of James, as to enlist its power on his side against that of France. In spite of his sterling qualities, and of the debt which they owed to him, the English nation never really liked William III. The death of his wife, on whom the crown had been conferred jointly with himself, in 1695, materially injured his position. His schemes were thwarted by parliament; continual plots for his assassination were hatched by the adherents of James; and in his warfare with France, victory was almost always on the side of Louis, W. being in person repeatedly defeated by Luxembourg (q. v.); and it was not without a struggle and a pang that he agreed to the terms of the peace, eminently popular, however, which was concluded at Ryswick on 10th September 1697. The death of Charles II. of Spain in 1700, and the succession of Philip of Anjou, was another blow to his policy. He carried it on, however, with unflagging vigour till his death, which was occasioned by a fall from his horse, on 8th March 1702. The massacre of the Macdonalds of Glencoe (q. v.), and his conduct to the promoters of the Darien Scheme (q. v.), are two blots on W.'s reputation which his most thoroughgoing apologists have been unable to efface. However, he was undoubtedly a practical genius of the highest order, and the services which he rendered both to England and to his native country can hardly be overrated. During his reign the Bank of England had been founded, the modern system of finance introduced, ministerial responsibility recognised, the liberty of the press secured, and the British constitution established on a firm basis. In his domestic life, he committed the error of a too stern repression of all manifestation of kindly or genial feeling. His manner was wholly Dutch, and even his countrymen thought him blunt. 'In his intercourse with the world in general,' says Lord Macaulay, 'he appeared ignorant or negligent of those arts which double the value of a favour, and take away the sting of a refusal.'—See Macaulay's *History of England*.

**WILLIAM IV.**, king of Great Britain and Ireland, third son of George III., was born on 21st August 1765. Until 1771, he remained, along with the Prince of Wales and Prince Frederick, under the care of Dr Majendie. He was then sent to Kew, where, with Prince Edward, afterwards Duke of Kent, he was under the guardianship of Colonel Bude. On 15th June 1779, he entered the navy as midshipman on board the *Prince George*, then under Rear-admiral Digby. The *Prince George* then joined Admiral Rodney's squadron, on its way to Gibraltar. After seeing a considerable amount of service, Prince W. was made a lieutenant on 17th June 1785; and in the year following, he received his commission as captain. In 1789, he was created Duke of Clarence and St Andrews, and Earl of Munster, with an allowance from parliament of £12,000 a year. Subsequent to this, several acts of insubordination rendered an actual continuance of his professional career impossible. He was, however, formally promoted through the successive ranks until he was made Admiral of the Fleet in 1801. Meanwhile, however, he had been living almost entirely ashore, along with Mrs Jordan, a celebrated actress, with whom he had become connected in 1791. By her he had a family of five sons and five daughters who became known by the surname Fitzclarence, and were raised to titular dignities. On 11th July 1818, he married Adelaide, eldest daughter of the Duke of Saxe-Meiningen. The issue of this marriage was two daughters, both of whom died in infancy. By the death of the Duke of York in 1827, the Duke of Clarence became heir-presumptive to the throne, to which he succeeded, on the death of his brother, George IV., on 26th June 1830.

The great event of the reign of W. IV. was the passing of the Reform Bill. After a fierce and protracted struggle, the bill was read a third time in the House of Lords on 4th June 1832, and three days afterwards it received the royal assent. The first Reformed parliament met on 29th January 1833. The abolition of colonial slavery, the reform of the poor-laws, and of the Irish church, were the immediate results of the great constitutional change. King W. died, after a short illness, on 20th June 1837. He was succeeded by his niece, Queen Victoria.

**WILLIAM THE LYON**, one of the early kings of Scotland, succeeded his brother, Malcolm IV., in 1166. He is commonly called W. the Lion, but why he obtained that title is one of the mysteries of history. When heraldry long afterwards became a science, and was supposed to have been in use earlier than it really was, it was not unnaturally supposed that he was the first king who used, as a heraldic achievement, the lion, afterwards the chief feature in the arms of Scotland. His predecessors had long contested with the kings of England the sovereignty of Northumberland and other districts of what is now the north of England. Under Malcolm, these claims were virtually abandoned, and the king of Scots received, as a sort of equivalent for them, the earldom of Huntingdon and other valuable estates holding of the English crown. William had still, however, a hankering after the Northumbrian districts. He attended Henry of England in his continental wars, and is supposed, when doing so, to have pressed for a portion at least of the old disputed districts. In his disappointment, he invaded them, after the example of his ancestors. On the 13th July 1174, he fell, almost by accident, into the hands of an English party. For security, he was conveyed to Normandy, and there he consented, as the price of his liberation, to perform that homage for his kingdom which the English kings so long in vain attempted to exact

from the government of Scotland. How far the Scots community would have admitted that he had a right to bind them to such a condition, may be doubted. The treaty of Falaise, however, as the transaction was termed, from the place where it was adjusted, was revoked in the year 1189 by Richard I. of England, in consideration of a payment of 10,000 marks, which he wanted for his celebrated expedition to Palestine. W. had several disputes with the church, but he was one of the early benefactors of the regular ecclesiastics, and founded, in 1178, the great abbey of Arbroath, which he dedicated to Thomas à Becket, who had been slain eight years earlier. King W. died in 1214.

**WILLIAM, PRINCE OF ORANGE, and COUNT OF NASSAU**, the founder of the independence of the Netherlands, was born at Dillenburg, April 16, 1533. His father, William, was the second son of Count John of Nassau-Dillenburg, and succeeded to the German possessions of the family; while his elder brother, Henry, obtained the extensive estates in Luxemburg, Brabant, Flanders, and Holland. The latter also by his marriage with Claudie of Chalons, added the charming and valuable little principality of Orange to his already extensive domains; but his son René dying without issue, left Orange along with the Low Countries' estates to W., in 1544. W. had hitherto lived at Dillenburg under the care of his father, who was a zealous Lutheran; but on his becoming the most powerful lord of the Low Countries, he was sent to the Queen Regent's court at Brussels, and brought up in the Catholic faith. At the age of 15, he became page to the Emperor Charles V., who took an almost paternal care of him, attentively watched the development of his character, and, satisfied with the result, took him into his inmost confidence, making him the safe repository of the most important secrets, employed him in various diplomatic offices, and in 1555, promoted him, over the heads of all his veteran officers, to the command of the imperial army on the French frontier. In all these various situations, W. acquitted himself completely to his patron's satisfaction; displaying acute intelligence, sound judgment, and a precocious knowledge of men, while bearing himself with a grace and dignity of manner that gained universal esteem. Charles, on his abdication, strongly recommended W. to his son Philip as a confidential adviser; and accordingly, we find him employed to draw up the treaty of Cateau-Cambresis, and selected as one of the four hostages to be given to France for its fulfilment. During W.'s residence in France, he was confidentially informed by Henry II. of a secret arrangement which was being formed between France and Spain for the complete extermination of heretics in both countries; and with admirable nerve, dissembling his horror of the project, he resolved in his own mind to oppose the execution of the scheme in the Netherlands to the uttermost of his power. On returning to the Low Countries, he became the leader of the party which devoted itself to the maintenance of the chartered liberties of the country, agitated for the recall of the Spanish troops, opposed the augmentation of the number of bishoprics (a pet scheme of Philip's, for his opposition to which he first incurred the bitter dislike of his sovereign), and finally broke entirely with Cardinal Granvelle, the president of the council, and the willing agent of Philip's tyranny. Expostulations to the Regent Margaret of Parma, and directly to Philip himself, far from producing any good result, seemed only to hurry the bigoted monarch to more extreme measures; the cruel edicts against heretics were made still more stringent, and at the end of 1564, the inquisition was established. W., how-

ever, steadily refused to allow these oppressive enactments to take effect in his hereditary governments of Holland and Zeeland; and though he did not join in the famous protest known as the 'Compromises' which was presented to the regent by the 'Beggars,' he supported their proposals at court, seeing that, though maintained with somewhat too much violence, their aims were the same as his own. For the next few years, he was unremitting in his exertions to impress both the rulers and the people with the desirableness of moderation, and on several occasions succeeded by his personal influence in repressing religious dissension. Hitherto, he had laboured conjointly with Counts Hoorn and Egmont, but failing to convince his two associates of the rank duplicity of the king, of which he himself was assured by means of the spies in his pay at the Spanish court, and of his perfidious designs against them, he was compelled to leave them to their fate, and retired to his German estates. Hoorn and Egmont were seized and executed; W., cited as a rebel (January 1566), and, on the ground of being a knight of the Golden Fleece and a sovereign prince, refusing to appear, had his estates confiscated, and the Duke of Alva arrived at Brussels, to reduce the provinces to submission. W. had hitherto lived in a most luxurious and extravagant manner, the splendour of his household far exceeding that of his royal master; but now he effected a thorough retrenchment, and disposed of his valuables, to equip four armies for the invasion of the Low Countries. Two of the armies failed completely; the third, under his chivalrous brother Louis, was destroyed at Jemmingen by Alva; and the fourth, 30,000 strong, under his own immediate command, lay in Brabant, unable to force Alva's army to a conflict, till want of the means of paying his soldiers forced him to retreat. His next attempt was made in 1572, and though as unsuccessful on land as before, he succeeded in exciting Holland, Zeeland, Gelders, Overijssel, and the bishopric of Utrecht, to rise for their liberties; and was proclaimed by these provinces as their stadtholder for the king, whose authority he and they still acknowledged. Meantime, his coadjutors, the 'Beggars of the Sea,' had taken Brill and Flushing, and had committed heavy depredations on Spanish commerce. But ere long the fortune of the Spaniards on land was again in the ascendant; fortress after fortress fell into their hands, despite W.'s utmost efforts to relieve them; and though Holland and Zeeland still remained faithful to the cause of liberty, he found it impossible to raise an army which could fairly cope with the enemy. He succeeded, however, by breaking the dykes, in saving Leyden, though Antwerp and Haarlem experienced all the horrors of a siege and capture. It was at this period that W. openly professed himself a Calvinist, though, with his usual moderation, he utterly disclaimed the bigoted fanaticism which characterised his co-religionists, and in which they went near to equal their adversaries the Catholics. Success still attended the patriot fleet, and though the gallant Louis, with his brother Henry, was defeated and slain at Mooker-Heide (14th April 1574), the ruinous condition of the Spanish finances, and the general detestation in which the soldiers of Philip were justly held, helped W. to hold his ground. In March 1575, conferences were opened at Breda between the belligerents, but Philip obstinately refusing to yield an iota, they were broken off; and in October of that year, the provinces of Holland and Zeeland pronounced Philip's deposition, and gave power to W. to choose the country under whose protectorate they were to be placed. Meantime,

the rapacity of the Spanish soldiery had roused the fifteen provinces which still remained loyal to Philip, and the league, known as the *Pacification of Ghent* (October 1576), the object of which was to drive out the foreign troops, and establish, at least for a time, toleration in religion, was the consequence. This was a brilliant success for W.; and though Don John of Austria, the new governor, tried to dissolve it by the 'Perpetual Edict' (12th February 1577), in which he granted nearly all demands, W. succeeded, by skilful policy, in foiling the attempt. War was accordingly resumed, and the patriots were defeated at Gemblour (31st January 1578), though their spirits were from time to time buoyed up by an occasional success. The next governor, Alexander Farnese, succeeded, however, in detaching the Wallooa provinces from the league, though, to compensate for this, W. obtained the signature of the *Union of Utrecht* (23d January 1579), the first foundation of the Dutch Republic. In the following year, his two faithful provinces, Holland and Zeeland, after having been nominally under the sway of the Archduke Matthias of Austria, and of the Duke of Anjou, proclaimed W. their sole ruler, the Duke of Anjou being still acknowledged as sovereign of the others. W., however, after his long and desperate struggle for his country's freedom, was not destined long to enjoy the honours of sovereignty, for, on 15th March 1580, Philip had, by Granvelle's advice, put a price of 25,000 gold crowns on his head, and the incitement of this magnificent bribe produced various attempts to assassinate him, the last of which, by Balthasar Gerard, was successful at Delft, 10th July 1584. W. was four times married, and left by his first wife, Anne of Egmont, Philip-William, Prince of Orange; by his second, Anne of Saxony, the famous Maurice (q. v.); and by his fourth, Louise de Coligny, Frederick-Heary, who succeeded Maurice as stadtholder of Holland.

**WILLIAM I** (Ger. **FRIEDRICH-LUDWIG WILHELM**), king of Prussia, and, since 1871, emperor of Germany, is the second son of Frederick-William III., and was born 22d March 1797. He joined the army at an early age, and was engaged in the campaigns of 1813—1814 against France. On the accession of his elder brother, Frederick-William IV. (q. v.), to the throne in 1840, W. became governor of Pomerania, and afterwards sat in the Prussian diet, and vigorously supported the absolutist party. In consequence, he was so much disliked by the people, that on the outbreak of the revolution of 1848 he had to flee to England; though he returned some months after, and was elected to the National Assembly. However, from this time he interfered little in the quarrels between the Constitutionalists and Absolutists, though he gladly accepted the command of the troops despatched to put down the rising in Baden; and in October 1857, the king having become incapacitated for business, W. was commissioned to act as regent, a commission renewed from time to time till his permanent installation in October 1858. At this time he was very popular in Prussia, owing to his supposed opposition to some of the obnoxious measures of the king's ministers, and to his vigorous advocacy of conjoint action with Britain and France in the war of 1854; and his election as regent was consequently opposed by the aristocratic and pietistic parties, who were, on his elevation, dismissed from power, and a more liberal ministry formed. On January 2, 1861, W. ascended the throne; and on the occasion of his coronation at Königsberg on 18th October following, he himself put the crown on his head, declaring that he 'ruled by the favour of God, and of no one else.' The

result of the elections to the Chamber of Deputies, which were being carried on at the same time, being much in favour of the liberal party, W., who was quite astonished at the fact of the party whom he looked upon as the opponents of the crown having a majority, attributed it to the intrigues of secret enemies; and in his address at the opening of the Chambers, saying that he 'never could permit the progressive development of our inner political life to question or to endanger the rights of the crown and the power of Prussia,' disclosed the principle of his policy, a policy which, with all the unflinching perseverance and unconquerable obstinacy which characterise men, like him, of thorough honesty, unflinching firmness, and considerable narrow-mindedness, he has since unremittingly pursued. The first chamber which sat after his coronation was dissolved, despite the protest of a large majority of the members; but the succeeding elections further increased the liberal majority; and though some popular measures were brought forward, and some obnoxious taxes abolished, the new chamber proved as refractory as its predecessor, and refused its consent to the extensive changes in the Prussian military system (the king's pet scheme), and to the raising of money by loan, to be applied for that and other ministerial projects, till its constitutional powers were fully acknowledged. On September 22, 1862, Herr von Bismark-Schönhausen, formerly the ambassador at Paris, was made prime minister; and the deputies having not only rejected the ministerial budget, but resolved that the expenditure of moneys not sanctioned by them was a breach of the constitution, the chamber was dissolved, October 14, the king declaring by message, that as the three estates could not agree, he should continue to do his duty to his people, without regard to 'these pieces of paper called constitutions,' in which he had no faith. The number of the liberals was further increased in the following year, and the contest continued; the deputies displaying the same firmness and extreme moderation as before; while the king and his ministers made it plainly understood, that if the lower chamber did what the government asked it to do, all would be well; but if not, the king would 'do his duty' without its aid. However, this strife between the old feudal and the modern liberal doctrines was shelved at the close of 1863, by the able strategy of Bismark, who revived the old dispute with Denmark regarding its government of Slesvig and Holstein, and by forcing Austria to conjoint action, contrived to make the question one of 'German' interest. See SLESVIG. Then came the war (see GERMANY in SUPP., Vol. X.) between Prussia and Austria. W. became the head of the North German Confederation in 1867. At Ems, in July 1870, took place the memorable interviews between W. and the French ambassador, Benedetti, which ended in the war of 1870—1871. W. accompanied the army, and commanded at the decisive battles of Gravelotte and of Sedan. On January 18, 1871, W. was proclaimed emperor of Germany in the palace of the French kings at Versailles; and now, as if completely to re-habilitate the old imperial title, the ancient enmity between pope and emperor has been fully revived by the recent education measures of the German government. W. married, 11th June 1829, Maria Louisa of Saxe-Weimar, by whom he has issue Friedrich-Wilhelm, the Crown Prince of Prussia, who married Victoria, the Princess-royal of England, and has issue; and Louisa, the present Grand-duchess of Baden.

**WILLIAM II.** (FRIDERICK GEORGE LEWIS), King of the Netherlands, Grand Duke of Luxemburg, Duke of Limburg, &c. (1840—1849), son of William I., was born at the Hague, 6th December

1792. In 1795, the Orange family sought an asylum in England, whence a few years later, the hereditary Prince of Orange-Nassau, afterwards William I., king of the Netherlands, went to settle at Berlin, where his son attended the Military School. At the age of 17, he was sent to study at Oxford; and in 1811, joined the army in Portugal, and served on the staff of Lord Wellington, to whom he became adjutant, and speedily obtained the rank of colonel. His bravery was conspicuous at Fuentes de Onoro and Ciudad Rodrigo. At Badajoz, the storming column having been repulsed, the young prince met and rallied the retiring troops, leading them anew to the attack, and was the first to spring into the breach. He took an active part at Salamanca, Vittoria, and the battles of the Pyrenees. On the return of the Orange family to the Netherlands, William I. made him commander of the army. The last campaign of Napoleon brought the prince again into active service, and he gained fresh laurels at Quatre Bras and Waterloo, where he was wounded. The Prince of Orange married, 26th February 1816, Anna Paulowna, youngest sister of the Emperor Alexander I. of Russia. When the Belgian revolution began in 1830, he was called again into public life; and, as governor of the loyal districts, tried by concessions to allay the storm, but the provisional government at Brussels was not to be satisfied, and having over-stepped the limits of his commission, the prince was recalled. In July, he took command of the army, and pushed to the centre of Belgium; when at Louvain, his victorious course was interrupted by French intervention, and the Dutch army retired to the north. Having more liberal views than were then common, the prince took little share in state affairs, and spent his life chiefly at Tilburg, as commander of the army of observation. On the abdication of William I. (see NETHERLANDS), the Prince of Orange assumed the reins of government (1840) as William II. The political movements of 1848 were felt in the Netherlands, as in other countries; and the ministerial plans of reform not having satisfied the party of progress, the king announced his willingness to sanction whatever changes in the constitution were thought necessary, and the storm was averted. The new constitution was proclaimed 3d November 1848. W. died on the 17th March 1849, regretted by all ranks. He was Marshal in the British army, and held a multitude of European orders.—See *Het Leven van Willem II.*, door J. J. Abbink; also the same by Bosscha.

**WILLIAM III.** (ALEXANDER PAUL FREDERICK LEWIS), reigning king of the Netherlands, was born 19th February 1817, and succeeded to the throne on the death of his father, William II., in 1849. The kingdom has since enjoyed uninterrupted peace, material prosperity has increased, and the public debt has been considerably reduced. W.'s reign has been chiefly distinguished for undertakings which contribute to the true greatness of a nation. The drainage of the Haarlem Lake (q. v.) was completed in 1852, removing an ever-enlarging enemy, and adding nearly 50,000 acres to the wealth-producing power of the country. In 1863, the slaves in the Dutch West Indian colonies were emancipated, under wise restrictions. Railways have been extensively constructed; the water-way to Rotterdam is being improved; and the Isthmus of Holland has been cut by a canal, which is continued through the IJ, and when completed will admit vessels drawing 22 feet direct to Amsterdam; while two piers have been built into the North Sea to form a harbour. While Prince of Orange, W. married, 15th June 1839, the Princess Sophia Frederica Matilda, daughter of the late King William I. of Würtem-

berg. They have two sons—William Nicholas Alexander Frederick Charles Henry, Prince of Orange, born 4th September 1840; and William Alexander Charles Henry Frederick, born 25th August 1851.

WILLIAM AND MARY COLLEGE, next to Harvard College, the oldest institution of learning in America, was established at Williamsburg, Virginia, 1693, and endowed with lands, and placed under the patronage of the king and queen of Great Britain. The trustees of the Hon. R. Boyle, the English philosopher, who left his personal estate for 'charitable and pious uses,' presented a great part of it to this college for the education of Indians. At the Revolution it lost most of its possessions, half the students entered the army, and the French troops occupied its buildings as a hospital. Here were educated Presidents Jefferson, Madison, and Monroe, Chief-justice Marshall, and General Scott. In 1875—1876 there were 7 instructors and 86 students.

WILLIAMS, JOHN, a celebrated missionary, was born at Tottenham, London, 29th June 1796. At the age of 14, he was apprenticed to an ironmonger, and during his apprenticeship, displayed a great taste for mechanics, and acquired a knowledge of mechanical arts, which he afterwards turned to great account. Having become deeply religious, he offered himself to the London Missionary Society as a missionary to the South Seas. He was ordained in 1816, and sent to Eimeo, one of the Society Islands. Two months after his arrival, he was able to preach to the people in their native tongue. From Eimeo, he soon went to Huahine, and afterwards to Raiatea, the largest of the Society group. His labours here were attended with great success; the island became Christian, and the arts and habits of civilisation were introduced along with Christianity. Wherever W. went, he not only preached the gospel, but instructed the people in the arts, so as to elevate them from their state of barbarism. At Raiatea, he heard of Raratonga, the chief of the Hervey Islands, and thither he went in 1823. The mission which he founded there was eminently successful; not only Raratonga but the whole group of the Hervey Islands being soon Christianised. In his missionary work, W. made great use of native teachers, trained by himself. He translated the New Testament into the Raratongan language, and prepared books for the schools which he established. After spending some time in Raratonga, he wished to return to Raiatea; but the island in which he lived lay out of the way of vessels, and he resolved to build one. He made all the necessary tools, and in about 15 weeks completed the vessel itself, a boat 60 feet long, and 18 wide, the sails of native matting, the cordage of the bark of the *Hibiscus*, the oakum of cocoa-nut husks and banana stumps. In this vessel, during the next four years, he visited many of the South Sea Islands, extending his missionary labours to the Samoa Islands. In 1834, he came to England, where he remained for nearly four years, during which he procured the publication of his Raratongan New Testament by the Bible Society, and raised £4000 for the purchase and outfit of a missionary-ship for Polynesia. In 1838, he returned to the chosen sphere of his labours, visited many of the islands, and finally the New Hebrides, where he hoped to plant a mission, but was killed, 20th November 1839, and most of his body eaten by the savage natives of Erromanga, on the shores of which he had landed. His death was the occasion of great lamentation in the islands which owed to him their Christianisation and civilisation. W. was remarkably successful as a missionary, not only by his own preaching, but through the instrumentality of natives whom he trained. He possessed in an

extraordinary degree the power of organising. His mechanical skill and genius were also of great service, and no other missionary has ever been so successful in making the progress of civilisation attend upon the progress of Christianity.

WILLIAMS, ROGER, founder of the state of Rhode Island, U. S., was born at Conwyl Cayo, Wales, in the year 1606. In his youth, he came to London, and attracted the attention of Sir Edward Coke by his short-hand notes of sermons, and speeches in the Star Chamber; and was sent by him to Sutton's Hospital, now the Charterhouse School, in 1621; and on April 30, 1624, he entered Jesus College, Oxford, where he obtained an exhibition. He studied Latin, Greek, Hebrew, French, and Dutch, and was ordained a clergyman of the Church of England, but soon became an extreme Puritan, and emigrated to New England, arriving at Boston, February 5, 1631, 'a young minister, godly and zealous, with his wife Mary.' He refused to join the congregation at Boston, because the people would not make public declaration of their repentance for having been in communion with the Church of England; he therefore went to Salem, as assistant-preacher, but was soon in trouble for denying the right of magistrates to punish Sabbath-breaking and other religious offences, as belonging to the first table of the Law. For his opposition to the New England theocracy, he was driven from Salem, and took refuge at Plymouth, where he studied Indian dialects. Two years later, he returned to Salem, only to meet renewed persecution and banishment from the colony, for denying the right to take the Indians' lands without purchase, and the right to impose faith and worship. He held that it was not lawful to require a wicked person to swear or pray, which were both forms of worship; and that the power of the civil magistrate extends only to the bodies, goods, and outward state of men, and not to their souls and consciences. Banished from the colony in 1635, and threatened to be sent back to England in order to prevent the infection of his new doctrines from spreading, he escaped in mid-winter to the shores of Narraganset Bay, accompanied by a few adherents, where he purchased lands of the Indian chiefs, founded the city of Providence, and established a government of pure democracy. Having adopted the belief in adult baptism of believers by immersion, W. was baptised by a layman, and then baptised him and ten others, and founded the first Baptist church in America. Later, he doubted the validity of this baptism, and withdrew from the church he had founded. In 1642, he came to England to procure a charter for his colony, and published a *Key to the Languages of America*, and *The Bloody Tenent of Persecution for Cause of Conscience Discussed*, &c.—his chief work on the nature and sphere of civil government. After returning to Rhode Island, he came a second time to England on business of the colony in 1651, when he published *Experiments of Spiritual Life and Health, and their Preservations*, dedicated to his friend, Lady Vane, and written, as he says, 'in the thickest of the native Indians of America, in their very wild houses, and by their barbarous fires;' also, *The Hireling Ministry none of Christ's*, and *The Bloody Tenent yet more bloody by Mr Cotton's Endeavour to wash it White in the Blood of the Lamb*. At this period, he engaged in an experiment of teaching languages by conversation, and made the acquaintance of Milton. He returned to Rhode Island in 1654, and was elected President of the colony; refused to persecute Quakers, but held a controversy with them, and published *George Fox digged out of his Burrows*. By his constant friendship with the Indians, he was of great service to the other colonies; but they



refused to remove their ban, or to admit Rhode Island into their league. He died in 1683.—See *Memoirs*, by James D. Knowles (Boston, 1833); William Gammell (Boston, 1846); Romeo Elton (London, 1852).

**WILLIAMSBURG**, a city of Virginia, U. S., between York and James rivers, 60 miles southeast of Richmond, the site of William and Mary College (q. v.), and the Eastern State Lunatic Asylum. W. was founded in 1632, is the oldest incorporated town in the state, and was the colonial and state capital till 1779. A battle was fought here between General McClellan and the Confederates, May 5, 1862. Pop. in 1870, 1392.

**WILLIAMS COLLEGE**, an institution of learning in Williamstown, Massachusetts, U. S., founded by a bequest of Colonel Ephraim Williams in 1755; incorporated in 1793, with further endowments of state grant, and the privilege of raising money by a lottery. In 1836, it was provided with an astronomical and magnetic observatory, the first in America. It has since been liberally endowed by Amos Lawrence, Nathan Jackson, the government, &c., and had in 1875-1876, 11 instructors, 170 students, and a library of 17,000 vols.

**WILLIAMSPORT**, a city of Northern Pennsylvania, U. S., on the West Branch of the Susquehanna. It is on the West Branch Canal, and the intersection of three railways, and is one of the three great lumber marts of the Union. It has 35 saw-mills, 13 planing-mills, 5 iron-foundries, and numerous factories. There are 32 churches, 7 banks, 2 daily and 7 other newspapers, 1 high school, and 8 public schools. Pop. in 1870, 16,030.

**WILLBROD**, or **WILBROD**, St. first Bishop of Utrecht, and 'apostle of the Frisians,' claims notice as being one of that meritorious band of British and Irish missionaries by whom Christianity was established in Northern Germany. He was born about the year 658, in the kingdom of Northumbria; and, although educated in the monastery of Ripon, where he received the tonsure, was sent, for final instruction, like most of the monks of that age, to the schools of Ireland. After a sojourn of thirteen years in that country, he resolved to devote himself to the conversion of Friesland, in which some of his fellow-monks had already engaged with little success. In 690, he sailed with twelve companions, and passing up the Rhine, arrived at Ultrajectum, the present Utrecht, soon after the victory of Pepin over the Frisians. By Pepin, they were warmly received; and W. having established the first beginnings of his mission, went to Rome in 692, whence he returned, with the sanction of the pope, Sergius I., and continued his labour till 695, when he again visited Rome, and received episcopal consecration, together with the pallium of an archbishop. Fixing his see at Utrecht, he converted a large number of the inhabitants, and extended his missionary colonies from that centre as far as the Danish provinces; and, although he received some check upon the death of Pepin in 714, yet the successes of Charles Martel enabled him soon afterwards to resume, under similar favourable auspices, the work which, after many alternations, ended in the successful establishment of Christianity. W. died at a very advanced age in 738, at the monastery which he had founded at Echternach, near Treves. His festival is the 7th of November.—See Bede's *Ecclesiastical History*, chaps. 10 and 11.

**WILLIS**, NATHANIEL PARKER, American author, was born at Portland, Maine, January 20, 1807. His father became the publisher of the *Boston Recorder*, said to be the first religious newspaper ever permanently established. Educated at Yale College, he

obtained in 1828 a prize for *Scriptural Poems*. On the completion of his college course, he established the *American Monthly Magazine*, afterwards merged in the *New York Mirror*, in which he was associated with George P. Morris. In 1830, he visited Europe, and contributed to the *Mirror* his *Pencilings by the Way*. Appointed *attaché* to the American legation at Paris, he had favourable opportunities for observing European society; and after a visit to Greece and Turkey, returned to England in 1835, and was married to a daughter of a British officer, General Stace. While in England, on account of some personalities in his writings, more consonant to American than English manners, he became involved in a quarrel with Captain Marryat, which led to a duel. He contributed to the London *New Monthly* his *Inklings of Adventure*, also published in three vols.; and in 1839, returned to New York, and published a literary paper, *The Corsair*, and *Letters from under a Bridge*, written at a beautiful country-seat, named, in compliment to his wife, Glenmary. He wrote also at this period *Tortosa the Usurer* and *Bianca Visconti*, dramas, and the descriptions of scenery illustrated in Bartlett's *United States and Canada*. In 1844, he engaged with General Morris in editing the *Daily Mirror*. His wife died, and he revisited Europe, and published *Dashes at Life with a Free Pencil*, 1845; returned to New York in 1846, he was married to a daughter of the Hon. Joseph Grinnell, of Massachusetts, and with his former partner established the *Home Journal*, to which he contributed most of the following works, also published in a collected form: in 1850, *People I have Met, and Life Here and There*; 1851, *Hurrygraphs, Memoranda of a Life of Jenny Lind*; 1853, *Fan Jottings, A Health-trip to the Tropics, A Summer Cruise in the Mediterranean*; 1854, *Famous Persons and Places, Out-doors at Idle Wild*; 1855, *The Rag-bag*; 1856, *Paul Fane, or Parts of a Life as Untold*; 1860, *The Convalescent*. Much of this work was done during a long, brave struggle with what appeared to be consumptive disease. Mr W. was an observant and thoughtful writer, discursive, fragmentary, picturesque, sprightly, quaint, and graceful, full of elaborate ease, and ingenious spontaneity. He edited the *Home Journal* (General Morris having died in 1864), and resided at his romantic highland retreat of Idle Wild, until his death, January 21, 1867.—His sister is a popular writer, under the *nom de plume* of 'Fanny Fern;' and his brother, Richard Willis, is a musician and musical critic.

**WILLOW** (*Salix*), a genus of trees and shrubs of the natural order *Salicaceæ*, otherwise regarded as a sub-order of *Amentaceæ*. This order or sub-order, to which the Poplar (q. v.) also belongs, is distinguished by having the flowers naked or with a cup-like perianth; numerous ovules; a naked, leathery, one-celled, two-valved fruit; seeds with long hairs; leaves with stipules. In the willows, the flowers are absolutely naked, the stamens from one to five in number, the leaves simple and deciduous. There are many species, but their precise number is not likely to be soon determined, as they are very difficult to distinguish botanically, and varieties are very numerous. They are mostly natives of the colder temperate regions of the northern hemisphere, although some are found in warm countries, as *Salix tetrasperma* in the hottest parts of India, and another species abundantly on the banks of the Senegal. Most of them are shrubs, and some are of very humble growth, particularly those of arctic and alpine regions. Thus, *S. herbacea*, which is common on the mountains of Scotland, seldom rises more than an inch from the ground. *S. arctica* and *S. polaris* are the most northern woody plants. Other

small species are also found to the very limits of perpetual snow in different countries, as *S. Lindleyana* on the Himalaya. Some of the species have already been noticed in the articles OSIER and SALLOW. Some of those which more generally receive the popular name W., are trees of large size, and remarkably rapid growth. The wood of some of them, as the WHITE W., or HUNTINGDON W. (*S. alba*), and the CRACK W. (*S. fragilis*), is used for many purposes, being remarkably durable, especially in damp situations, although light and soft. It was anciently used for shields. Cork-cutters and others employ it for whetting sharp-edged implements. It is very tough. It is used for making paddles of steam-boats, because it wears better in water than any other kind of wood. Willows are often planted as ornamental trees, especially near streams and in moist grounds. Many kinds are also planted on the banks of rivers, to retain the soil in its place, and restrain the encroachments of the river. They are the better adapted for this purpose that they grow readily by cuttings; and willow-stakes driven into a moist soil strike root, and soon become luxuriant. The twigs of most of the willows are very tough and flexible, and are used by coopers for making hoops, and by gardeners for tying espalier trees, and for many similar purposes. They are much used for basket-making and other kinds of wicker-work. See OSIER. Willow withes were probably amongst the first ropes used by man. But the young shoots of many of the kinds with ovate or little elongated leaves, are comparatively brittle, and ill adapted for wicker-work. Willow trees are sometimes treated as pollards, and the lop used for fuel and other purposes. They are also often grown as coppice-wood, yielding a great bulk of hoops, poles, fuel, &c. The leaves and young shoots are in some countries used as food for cattle, and even dried and stacked for that use. A fragrant water is distilled in the north of India from the catkins of the EGYPTIAN or CALIPH W. (*S. Egyptiaca*). A principle called *Salicine* exists in the bark of willows, which has been found efficacious in intermittent fevers, and is sometimes used as a substitute for quinine. It is crystalline and intensely bitter.—The flowers of the W., which in many species appear before the leaves, are much sought after by bees. The male catkins of many species are very beautiful, the prominent anthers being of a fine yellow colour, or as in *S. purpurea*, of a rich purple. The WEEPING W. (*S. Babylonica*), of which an illustration is given under WEEPING TREES, is a very ornamental species, a native of the East, now much planted in Britain, and on the continent of Europe, on account of its beautiful pendent twigs. What is called NAPOLEON'S W. is a variety of it.—The White W., or Huntingdon W., is by far the largest species known in Britain. It attains a height of eighty feet, and grows so rapidly that a cutting has been known to become a tree of thirty feet in ten years. Its head is much branched and spreading, its leaves narrow elliptical-lanceolate, silky beneath, and sometimes also above.

**WILLOW-MOTH** (*Caradrina cubicularis*), a species of moth, of which the caterpillars feed upon the grain of wheat, often doing very much mischief. The perfect insect is of a mouse colour, and its wings are closed flat upon its back when it is at rest. On the upper wings are three transverse wavy lines, and some black dots. The under wings are pearly white, with a slight tinge of brown near the fringe, and brownish nervures. The body is slender, the antennae thread-like. The whole length, without the antennae, is rather more than half an inch. The caterpillar varies in colour from dull ochreous red to dirty green, with a blackish head, two brown spots on the first segment, a wavy line on each side edged with

black. The chrysalis is bright brown. This moth is often abundant in summer, in hayfields, gardens, and barn-yards. The caterpillar feeds on grain

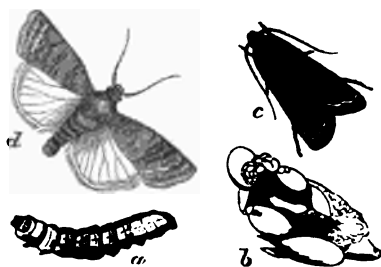

Willow-moth (*Caradrina cubicularis*):

a, caterpillar; b, pupa in its cocoon; c, willow-moth at rest; d, insect with wings expanded.

through the winter, and draws the corn together with a thin silken web in February or March, when about to assume the chrysalis state.

**WILMINGTON**, a city and port of Delaware, U. S., on Christiana Creek, near its junction with the river Brandywine, 28 m. S.W. of Philadelphia, on the Philadelphia, Wilmington, and Baltimore Railway. It is a handsome, regular town, commanding fine water-views, and has 45 churches, a town-hall, large hospital, St Mary's Roman Catholic College, 5 banks, 13 newspapers, and manufactories of steam-engines, railway cars, and wheel car springs, iron steamboats, machinery, galvanised iron; flour-mills, powder-mills, &c. Pop. (1870) 30,841.

**WILMINGTON**, a city and port of North Carolina, U.S., on the left bank of the north-east branch of Cape Fear River, 20 miles from the sea. It has a good harbour, with extensive internal navigation, and railway connections, and large exports of lumber, tar, rosin, turpentine, shingles, cotton, &c. During the war of 1861—1865, it was one of the chief ports of the Confederacy, and was frequented by blockade-runners, until it surrendered to General Terry in 1865. Pop. (1870) 13,446.

**WILNA**. See VILNO.

**WILSON**, ALEXANDER, American ornithologist, was born at Paisley, Scotland, July 6, 1766. He was the son of a weaver, and was apprenticed to the weaving-trade, at which he worked seven years, amusing himself at the same time by writing verses. As soon as he was free he gratified a roving disposition by mounting a pedler's pack, and went to Edinburgh to take part in a discussion, in which he maintained the poetic claims of Fergusson against Allan Ramsay, and, in the same cause, wrote *The Laurel Disputed*, a Poem. The piece by which he is best remembered, is a droll poem in the Scottish dialect, styled *Watty and Meg*. He also contributed to *The Bee*, and made the acquaintance of Burns. He was prosecuted for a lampoon upon a resident of Paisley, and condemned to a short imprisonment, and to burn the libel with his own hand at the Paisley cross. Determined to leave a country where his genius was unappreciated, he sailed from Belfast for America, and landed at Newcastle, Delaware, July 14, 1794, with a few borrowed shillings in his pocket, and no acquaintances. He got work with a copperplate-printer in Philadelphia, then with a weaver; travelled as a pedler in New Jersey, where the brilliant plumage of the birds attracted his attention; then engaged as a school-teacher in Pennsylvania, and then walked 800 miles to visit a nephew in New York. Teaching a school once more in New Jersey, he lived near the botanic garden of William

Bertram, who was well acquainted with birds, and stimulated and encouraged in his studies of nature, W. resolved to make a collection of all the birds that were to be found in America. In October 1804 he set out on his first excursion, in which he travelled to Niagara Falls, and wrote *The Foresters, a Poem*. In 1805, he learned etching of a Mr Lawson, from whom he had already learned to draw; and was employed on the American edition of *Rees's Cyclopaedia*. He soon prevailed upon the publisher, Bradford, to undertake an American Ornithology. In September 1808, he brought out the first volume, but in a style too costly for the tastes and fortunes of the period, so that he obtained only 41 subscribers in the eastern states, and had no better success in the southern. The second volume was, notwithstanding, brought out in 1810. In 1811 he made a canoe voyage down the Ohio, and travelled overland through the Lower Mississippi Valley, from Nashville to New Orleans, collecting specimens for his third volume. In his eager pursuit of a rare species of bird of which he long wanted a specimen, he swam across a river, and caught cold, which ended in his death, at Philadelphia, Aug. 23, 1813, when he had nearly completed his work—the 8th and 9th volumes being published after his death. It was continued by Charles Lucien Bonaparte, in 4 vols. (1825–1833). A monument was erected to his memory in Paisley Abbey churchyard in 1874.—See Grosart's *Poems and Miscellaneous Prose of Alexander Wilson* (1876).

WILSON, DANIEL, LL.D., a distinguished writer on archaeological subjects, Professor of History and English Literature at the university of Toronto, was born at Edinburgh in 1816. His works include *Memorials of Edinburgh* (1848); *Pre-historic Annals of Scotland* (1851); *Pre-historic Man, his chief work*, (1862); a *Life of Chatterton*, and a *Life of Cromwell*.

WILSON, GEORGE, M.D., F.R.S.E., chemist, brother of the above, was born at Edinburgh in 1818. In 1840, after studying in various laboratories, and graduating in medicine at Edinburgh, he received a license as lecturer on chemistry from the Royal College of Surgeons in that metropolis. He subsequently became lecturer on chemistry in the School of Arts, and in the Veterinary College; and in 1855 he was appointed Professor of Technology in Edinburgh University. In conjunction with this office he held the curatorship of the Industrial Museum, an institution which owes much of its completeness and order to his knowledge and skill. Professor W., who had long struggled with ill-health, died in 1859. Among his scientific works mention may be made of his *Text-book on Chemistry* in Chambers's *Educational Course*, *Researches in Colour-blindness*, and *The Five Gateways of Knowledge*. He also wrote on miscellaneous subjects, and was the author of several poems. A memoir of W. by his sister (Mrs Sime), was published in 1860.

WILSON, HORACE HAYMAN, a distinguished Sanscrit scholar, was born in London in the year 1786, and was educated for the medical profession. In 1808 he went to India as assistant-surgeon on the Bengal establishment, and in a short time afterwards, on account of his proficiency in chemistry, obtained an appointment in the Calcutta mint as assistant to Dr Leyden. He now applied himself diligently to the study of Sanscrit, and in a few years obtained so high a reputation for his scholarship, that, upon the decease of Dr Hunter in 1811, W. was appointed to succeed him as secretary of the Asiatic Society of Bengal, on the recommendation of Mr H. T. Colebrooke. In 1813, W. published his first work, viz., *The Mégha Dûta, or Cloud Messenger, a Poem in the Sanscrit Language,*

by Kâliddsa; translated into English Verse, with Notes and Illustrations, by H. H. Wilson. This work, originally published at Calcutta in 1813, was reprinted in London in the following year. His next publication was *A Dictionary, Sanscrit and English, translated, amended, and enlarged from an original Compilation prepared by Learned Natives* (Calcutta, 1819–1840). This work proved to be of great advantage to students of Sanscrit, and added considerably to W.'s reputation. His next publication was *A Collection of Proverbs and Proverbial Phrases in the Persian and Hindustani Languages; compiled and translated chiefly by the late Thomas Roebuck* (Calcutta, 1824). To this, W. prefixed a valuable Introduction, at the same time that he edited the whole, with considerable additions of his own. Among W.'s subsequent publications are: 1. *Select Specimens of the Theatre of the Hindus, translated from the Original Sanscrit*, 3 vols. (Calcutta, 1827). 2. *A Descriptive Catalogue of the Oriental Manuscripts and other Articles illustrative of the Literature, History, Statistics, and Antiquities of the South of India; collected by the late Lieutenant-colonel C. Mackenzie*, 2 vols. (Calcutta, 1828). 3. *The Raghu Vansa, or Race of Raghu, a Historical Poem, by Kâliddsa, with a Prose Interpretation of the Text, by Pundits of the Sanscrit College of Calcutta* (Calcutta, 1832). Of this publication, W. was the editor. 4. *Observations on Lieutenant Burnes's Collection of Bactrian and other Coins, by H. H. Wilson and J. Prinsep* (1834). 5. *The Vish'n'u-Purd'n'a, a System of Hindu Mythology, translated from the Original Sanscrit, and illustrated by Notes* (Lond. 1840). 6. *An Introduction to the Grammar of the Sanscrit Language, for the Use of Early Students* (Lond. 1841); 2d ed. (Lond. 1847). 7. *Ariana Antiqua, a Descriptive Account of the Antiquities and Coins of Afghanistan, with a Memoir on the Buildings called Topes, by C. Masson* (Lond. 1841). 8. *Rig-Veda-Sanhita, a Collection of Ancient Hindu Hymns, translated from the Original Sanscrit* (Lond. 1850). 9. *A Glossary of Judicial and Revenue Terms, and of useful Words occurring in Official Documents relating to the Administration of the Government of British India, from the Arabic, Persian, Hindustani, &c.* (Lond. 1855). 10. *Principles of Hindu and Mohammedan Law, republished from the Principles and Precedents of the same, by the late Sir William Hay Macnaghten, and edited by H. H. Wilson* (Lond. 1860). Many of these works were produced while W. held the office of Assay-master and Secretary of the Mint at Calcutta. In his official capacity, he often received the thanks of the government of India for reforms in the coinage and other services. He was for many years secretary to the Public Instruction Committee at Calcutta, and took great trouble in directing the studies of the Hindu College. He was at the same time noted for his musical skill, and his talents as an amateur actor. In 1833, the Boden Professorship of Sanscrit was founded in the university of Oxford, and W. was elected to that lucrative post, not without strong competition. Soon after his arrival in England, he was appointed Librarian at the East India House, in succession to Sir C. Wilkins. This appointment he held in conjunction with the professorship until his death, which occurred on May 8, 1860. He was married to a grand-daughter of the celebrated Mrs Siddons, by whom he had several children. W., as an orientalist, takes rank with Sir W. Jones and H. T. Colebrooke. Many of his researches are embodied in papers contributed to the *Journal of the Asiatic Society of Bengal*, and other periodicals.

WILSON, JOHN, famous as Professor Wilson, and the Christopher North of *Blackwood's Magazine*, was born on May 18, 1785, at Paisley, where his

father was a wealthy manufacturer. His earlier education he received in the house of Dr M'Letchie, minister of the parish of Mearns, a wild moorland district in Renfrewshire, his boyish residence in which he long afterwards commemorated in some of his most charming essays. After having been transferred for a time to the care of the Rev. Joseph Macintyre of Glenorchy, in the Highlands, the love of which became for him a lifelong passion, he was sent to the university of Glasgow, where he remained for four years, distinguished as on the whole a diligent and successful, though somewhat fitful and irregular student. In 1803, he went to Magdalen College, Oxford, where he became notable at once for the splendour of his intellectual gifts, and for his supremacy in the various athletic sports—boxing, rowing, running, &c.—which have always formed a not inconsiderable part of the education bestowed at the English universities. In 1806, he signalised himself by his Newdigate prize poem, *On the Study of Greek and Roman Architecture*; and the year after, he took his degree of B.A., that of M.A. following in 1810. Meantime, he had left Oxford, and settled himself in Cumberland, attracted partly by the beauty of the Lake Country, and partly by a desire to cultivate the intimacy of Wordsworth, of whose genius he was already a devout admirer. He purchased the lovely little property of Elleray, where, for some years, he resided almost constantly. Besides Wordsworth, there were available in the district for intellectual converse De Quincey, Southey, and Coleridge (to whose *Friend* he contributed some essays). With all of them, he became intimate; and when he wearied a little of 'celestial colloquy divine' with them, he sought a variety to life in measuring his strength against that of the far-famed Cumberland wrestlers, the very sturdiest of whom has left it on express record that he found him 'a vera bad un to lick.' In 1810, he married a Miss Jane Penny, a Liverpool lady, of great personal attractions and much amiability of character, in his union with whom he found the main happiness of his life. He now seriously devoted himself to poetry; and in 1812, published his *Isle of Palms*, which attracted considerable attention, and was followed in 1816 by *The City of the Plague*. This work showed a marked increase of power; but it is questionable, despite the grace, music, and tender feeling of much of his verse, whether, as a poet, W. would ever have succeeded in developing the real force of his genius. His true field, however, was found on the starting, in 1817, of *Blackwood's Magazine*. Some years previously, a pecuniary disaster had befallen him; the fortune of £30,000 left him by his father being so seriously curtailed by the misconduct of a relative as to necessitate the breaking up of his establishment at Elleray. On this, he transferred himself to Edinburgh, where, in 1816, he was called to the Scottish bar; but it does not appear that he had any opportunity of practice. As one of the briefless, with plenty of spare time on his hands, along with his friend Lockhart, then in similar case, he lost no time in proffering his aid to Mr Blackwood. The astute publisher was at no loss to estimate the value of their alliance; and it is not too much to say that during its earlier years, Lockhart and W. were the soul of the success of the magazine. Presently, Lockhart was withdrawn to succeed Gifford as editor of the *Quarterly Review* in London; and W., though never in any strict sense its editor—Blackwood himself throughout exercising a severe control—became, in the eye of the public, more and more identified with the Magazine; in a certain modified, yet very real sense, to all intents for many years he was editor

of the Magazine, and under his famous pseudonym of Kit North, swayed it before the world. In 1820, he was appointed to succeed Dr Brown, deceased, as Professor of Moral Philosophy in the university of Edinburgh, his friend, Sir W. Hamilton, being one of the defeated candidates. His real claims to such a post, though not to be compared with those of Hamilton—who, at that time, however, had given little or no proof before the public of his consummate accomplishment and ability—have been somewhat unduly depreciated. They were not so by Hamilton himself, whose opinion it was, as reported by Mr De Quincey, that 'Wilson's philosophic subtlety of intellect was not the least wonderful of his many wonderful gifts.' Thus much is certain, that as a professor, though somewhat desultory in his methods, he had an almost unexampled power of stimulating the enthusiasm of his students. Out of his class-room, however, it must be admitted he but indifferently succeeded in attaining the staid ideal proper to the learned and respectable class of men with whom he was thus somewhat oddly associated. He was the most 'muscular' of 'Christians,' and on more than one occasion, the singular spectacle was exhibited of a Scotch professor of moral science taking off his coat in a public marketplace, to inflict personal chastisement on some ruffian, whose obnoxious proceedings had done outrage to his nicer sense of the fitness of things. Though sedulous and strict in his discharge of his duties as a professor, W. was loyal in his adhesion to Blackwood, and his contributions to the Magazine, in their mere amount enormous, continued to form the main part of his activity. In 1840, he suffered an irreparable loss in the death of his wife. His grief for a while nearly prostrated him, and seems to have flung something of a shadow over what of life remained to him. He continued, however, to contribute to *Blackwood*, though now somewhat more intermittently; and in 1842, he published, as *The Recreations of Christopher North*, a selection, in two volumes, from the mass of his essays furnished to it. During the session 1852—1853, he was smitten by an attack of paralysis, which permanently incapacitated him for the discharge of professorial duty; and in Edinburgh, on April 3, 1854, he died. During his last years, he enjoyed a pension of £200 a year from government, in acknowledgment of his literary services. Besides his poetry and periodical writings, he published in 1822 a volume of sketches, entitled *Lights and Shadows of Scottish Life*, which was followed the year after by his tale of *Margaret Lyndsay*. In these, as in his poems, the robust side of his mind is scarcely, if at all, represented; but the tender idyllic grace and charm by which they are pervaded, secured for them an extensive popularity, some portion of which they have since continued to retain. In his miscellaneous prose essays, critical and descriptive, and most especially in the celebrated series of dialogues entitled *Noctes Ambrosiana*, the true power of his genius is revealed. Of the genius, there can be little question; though as to whether it has succeeded in embodying itself in forms which are likely to be permanent, there may reasonably be difference of opinion. The materials for judgment are before the world in the collected (or rather selected) edition of his *Miscellanies*, published since his death by his son-in-law, Professor Ferrier. As a magnificent *potentiality*, it is scarcely exaggeration to speak of W. along with Burns and Scott as a member of the trinity (so to speak) of Scottish literary genius. Certain it is, that nearly as effectually as they did, he stormed the heart of the Scottish people, and became, in his later years—the Great

Novelist being gone—their idol and accepted literary representative. If he has left behind him no work sacred as his literary *monument*, thus much was almost involved in the conditions under which he wrote. Writing as he did from month to month for the instant purpose of the hour, wise and steady concentration of his energies became more and more difficult for him. Not the less, when all reasonable deduction is made, he holds his place as one of the most notable literary figures in the earlier half of this century. His *range* of power is extraordinary: from the nicest subtleties of feminine tenderness, he passes at will to the wildest animal riot and the most daring grotesqueries of humour; and in what he terms 'numerous prose,' the prose poem or rhapsody—a questionable and perilous, though, within wise limits, a legitimate form of art—he may be held, in his finer passages, to be at this day unrivalled. See the affectionate and felicitous *Memoir* by his daughter, Mrs Gordon (1863). A selection from the *Noctes Ambrosianæ—Comedy of the Noctes Ambrosianæ*—by J. Skelton, appeared in 1876.

WILSON, RICHARD, an English landscape-painter of great eminence, was the son of a clergyman in Montgomeryshire, and was born in 1713 at Pinegas in that county. His early love of drawing attracted the attention of Sir George Wynne, his relation, who had him placed under the tuition of a portrait-painter in London, by name Thomas Wright. In portrait-painting, W. had considerable success, but can scarcely be said to have become eminent, when in 1749 he went to Italy to study the works of the old masters. At Venice, he formed the acquaintance of the then famous Zuccarelli, who was so struck with the merit of a careless and random landscape sketch dashed off by him as the whim of an idle moment, that he earnestly advised him to forsake portrait for landscape, as plainly his true vocation. He was further encouraged in doing so by the praises of Vernet at Rome, who was greatly charmed by some of his earlier efforts. To landscape-painting, he now exclusively devoted himself; and before returning to England in 1755, he had succeeded at Rome in establishing a considerable reputation. In London, in 1760, he exhibited his great picture, the 'Niobe,' which was bought by the Duke of Cumberland, and at once secured him rank as one of the first painters of his time. Another celebrated work, his 'View of Rome from the Villa Madama,' was exhibited in 1765, and found a purchaser in the Marquis of Tavistock. Strange to say, however, his pictures, since so famous, failed to hit the general taste; and while far inferior artists were eagerly patronised by the public, W. was for the most part neglected. Failing in the general market, he fell into the hands of the picture-dealers, to whom he would frequently for a few pounds dispose of pictures which have since been sold for large sums. So straitened did he frequently find himself, that in 1770 he was fain to solicit, and happy to obtain, the appointment of Librarian of the Royal Academy, with the trifling salary attached to it. As explanation in part of his otherwise almost unaccountable want of success, it is alleged that his manners were rude, and his temper somewhat unaccommodating; with his brethren in art, he was notoriously the reverse of popular; and it is probable that in the general conduct of life he exhibited some lack of that tact and skill which even men of the most distinct genius may find of some little avail to procure them a prompt recognition of it. By the death of a brother, who left him a handsome sum of money, he was rescued from the indigence, as it may almost be called, in which the greater portion of his life had been passed; and retiring to Lilamberris in Denbigh-

shire, he died there some few years after in 1782. Of his numerous pictures, now much prized, many are familiar to the public by engravings; in the National Gallery, three very fine specimens of him may be found; and several others form part of the well-known Vernon Collection.

WILSON, GENERAL SIR ROBERT THOMAS, was born in the year 1777 in London, where his father was a painter. He was educated at Westminster, and afterwards at Winchester, and when scarcely 17, he joined the 15th Light Dragoons, then serving under the Duke of York in Belgium, and took part in some sharp service, in which the regiment greatly distinguished itself. Shortly after his return to England, he was married to a lady of great beauty and some fortune, to whom, through life, he seems to have been ardently attached. In 1798, he was engaged in Ireland in the suppression of the rebellion; and the year after, he served in the unfortunate campaign of the Helder, and was present with his old regiment at the battle of Egmont-op-Zee. That in everything he proved himself a capable officer, may be inferred from his appointment soon after to command the small force of cavalry which served under Sir Ralph Abercromby in Egypt. Here he formed a warm friendship with General, afterwards Lord Hutchinson, who succeeded to the command of the army after the death of Abercromby. His next service was at the conquest of the Cape of Good Hope in January 1806, where again he commanded a small cavalry force. In the latter part of that year he went abroad on the staff of his friend, Lord Hutchinson, who was sent on a mission to the king of Prussia, then a fugitive from his capital, and awaiting the result of the conflict pending between Napoleon and his allies, the Russians. W. had now, for the first time, an opportunity of seeing war on a really gigantic scale, being present at the desperate battle of Eylau (q. v.). The peace of Tilsit ensued, and W. thereupon returned to England. The struggle in the Peninsula had now commenced, and W. was sent to take part in it; he was active in the embodiment and training of the Portuguese army, and subsequently, under Wellington, he commanded a Spanish brigade at the battle of Talavera. From this field of action he was, however, withdrawn; and in 1812, he was attached to the Russian army as English military commissioner. During the tremendous struggle which resulted in the capture of Moscow, and the operations which followed in pursuit of the doomed French army, he rendered important service both in council and in the battle-field; and he seems to have won the especial regard and confidence of the Emperor Alexander. Throughout the subsequent campaigns in Germany, and those which followed in France, ending with the capture of Paris in 1814, he was present in a similar capacity in the camp of the allies. At Lützen, he took command of the Prussian reserve, and at a particular crisis of the battle, succeeded in severely checking the enemy. At Bautzen, he also distinguished himself; and a day or two after, the Emperor of Russia presented to him publicly the cross of the Order of St George, saying that he gave it 'as a memorial of his esteem for his courage, zeal, talent, and fidelity to my service.' His services during this period will be found noted in every military History of the time; and they amply prove him to have been a most gallant and accomplished soldier.

After the peace, he became involved in the unfortunate matter of Queen Caroline; and for his censure of the course pursued by government he was dismissed the army. He was afterwards, however, reinstated. In 1841, he attained the rank of general; and from 1842 to 1849, he held the post of governor

of Gibraltar. In 1818, he had been returned to parliament in the Liberal interest for Southwark, and he retained his seat till 1831. On 9th May 1849, having just returned from Gibraltar, he died suddenly in London. During his life, he published several works; in 1804, *An Inquiry into the Military Force of the British Empire*; in 1811, *Campaigns in Poland, with Remarks on the Russian Army*; and in 1817, a *Sketch of the Military Power of Russia*. During his foreign campaigns, he kept copious private diaries; and of these, two most interesting volumes, 'edited by his nephew and son-in-law, the Rev. Herbert Randolph, M.A.,' were some years since published by Murray of London. A *Life* of him has likewise been published by Murray, under the same superintendence.

**WILTON**, a market-town and parliamentary borough in Wiltshire, at the junction of the Nadder and Wily, affluents of the Avon, 3½ miles west-north-west of Salisbury. The New Church, a magnificent Romanesque edifice, decorated in the richest and most tasteful manner, was erected in 1844 by the Right Hon. Sidney Herbert, at a cost of £20,000. The principal industry of the town is the manufacture of carpets, especially Axminsters, and the carpets called Saxony, made of short staple wool. The burgh returns one member to the House of Commons. It is a station on the Salisbury branch of the Great Western Railway. Pop. of parliamentary borough (1861) 8657; (1871) 8865.

W., a very ancient, and at one time important town, was the capital of the Anglo-Saxon kingdom of Wessex, and gave name to Wiltshire. From the 9th c. to the year 1244, it was a busy and prosperous place; but in that year, the Great Western Road, which had formerly passed through it on its way from Old Sarum, was diverted, and the prosperity of the town came to a close. The town stands near the site of a monastery given to Sir William Herbert, first Earl of Pembroke, by Henry VIII.; and the locality is rich in associations connected with the Herbert family. Here Sir Philip Sidney wrote part of his *Arcadia*. The present mansion is noted for its collection of statues, and for its pictures, including several excellent Van Dycks.

**WILTSHIRE**, or **WILTS** (called by the Anglo-Saxons *Wiltonshire*, from their capital town, Wilton, q. v.), one of the south-western counties of England, bounded on the W. and N. by Somerset and Gloucester, and on the E. and S. by Berks, Hants, and Dorsetshire. Area 859,303 acres; pop. (1871) 257,177. The county is divided into two unequal parts—the plains in the north, and the hill district, which comprehends the greater part of South W.; and the separation between these two parts is very nearly that of the main line of the Great Western Railway, the course of which across the county is from north-east to south-west, past Swindon and Chippenham. The plains incline north to the basin of the Thames, which forms in part the northern boundary, and are noted for their agricultural capabilities. The surface of this district is checkered with corn-fields and rich pastures, and here the cheeses for which W. is favourably known are produced. The hill district (on the chalk) presents ranges of bleak downs, with deep valleys, and is thinly peopled, much of it consisting of solitary sheep-walks, on which it is estimated 700,000 sheep are pastured. Inkpen Beacon, 1011 feet high, at the junction of W., Hampshire, and Berkshire, is the nucleus whence proceed the North and South Downs of Surrey and Sussex, and the hills which, running south through this county, become the North and South Downs of Dorsetshire. Agriculture is carried on with the assistance of modern

improvements; many swine are reared, and W. bacon is famous. Portland stone is quarried at Swindon, Tisbury, and in other localities; a fine oolite, known as Bath stone, is extensively worked at Box and the neighbourhood; and a stone called Forest Marble yields coarse tiles and flagstones, and often retains in perfect preservation 'the ripple-marks of waves and the footprints of crustaceans.' The manufacture of woven goods, carpets and other woollen goods, silks and linens, is carried on at Trowbridge, Wilton, Bradford, Devizes, Westbury, &c. There are iron mines and blast-furnaces at Westbury and Seend, and Swindon is one of the greatest railway workshops in the kingdom. The principal rivers are the Thames, with its tributary, the Kennet; the Bristol Avon (which communicates with the Thames and Severn by the Wilts and Berks Canal, and again with the former by the Kennet and Avon Canal), and the Salisbury Avon, with four tributaries spreading over the whole of South W. The county sends four members to the House of Commons, and the boroughs 14 more. Before 1832, W. had 34 members. Cap., Salisbury; but the assizes are held alternately there and at Devizes.

W. abounds in early and interesting antiquities. Among these may be mentioned its Druidical temples (see *AVEBURY* and *STONHENGE*), British entrenchments, roads, and villages, barrows (in which beads, rude axes of stone, arrow-heads of flint, and sometimes articles in gold, brass, or iron, have been found along with the relics of mortality), Saxon encampments, Roman roads and Norman castles, of which there are many remains. Long-leat, Wilton, Bowood, Stourhead, and Corsham are the most remarkable modern houses of the nobility. —See *History of Ancient Wiltshire*, by Sir R. O. Hoare.

**WINCHESTER**, a famous historical city, and parliamentary and municipal borough, chief town of Hampshire, is situated in the middle of the county, on the right bank of the Itchen, 67 miles south-west of London by railway, and 60 in a direct line. It consists of one main street, crossed by a number of streets running at right angles to it, and was in early times surrounded by a wall, of which remains exist. The houses for the most part spread over a hill rising from the valley of the Itchen; but the cathedral, and some of the older and more interesting portions of the city, stand on level ground close to the river-bank. The Castle-hill is the site of the old castle or royal palace, built in the 13th c. by Henry III., and of a magnificent hall, of which the only remaining portion is used as the County Court. About a mile from the town is the famous hospital of St Cross, founded in 1136 by a bishop of W., Henry de Blois, for 13 poor men, 'decayed and past their strength.' It was munificently endowed; but its sources of income have been narrowed, and its ancient charters and grants were destroyed during the 13th century. Its income is £1068 per annum, and it supports 13 poor brethren, affords relief to a number of external poor, and distributes general doles on the eves of great festivals. The hospital is entered by a gateway, after passing which a pleasing view is obtained of the buildings, which occupy three sides of a quadrangle, the fourth side being occupied by a neat, picturesque, ancient church in Transition Norman, which formed part of the institution. There is a city library and a museum; the latter contains some very interesting local antiquities. Charles II. commenced a palace here, but the part completed is now used as barracks. The city cross in the High Street, dating from the 15th c., is very beautiful in design.

The college of W., called originally 'Seinte Marie College of Wynchestre', now Saint Mary's or Winchester College, was founded by William of Wykeham, bishop of W., in 1387, and the buildings were completed in 1393. The buildings are, for the most part, of the age of the founder, and consist of two quadrangles and a cloister, together with recently erected houses for the commoners. The famous *Dulce domum* is sung by all the boys in the courts of the college before the breaking up of the school at the long vacation. The foundation consisted originally of a warden, 10 Fellows, 70 scholars, a head-master (*informator*), an usher (*ostiarus*), or second master, 3 chaplains, 3 clerks or singing-men, and 16 choristers. By an ordinance of the Oxford University Commission, which took effect in 1857, the number of Fellowships has been reduced, as vacancies occurred, to six, the number of scholars being increased to 100, and 20 exhibitions have been founded. The charter of the school, which is in existence, was granted by Richard II. in 1396, and confirmed by all the subsequent sovereigns, Mary excepted, down to Charles II. The visitor is the Bishop of W., and the warden and two Fellows of New College, Oxford, hold an annual 'scrutiny', which, however, is generally merely formal. The endowment, which amounts at present to about £17,600 annually, consists of landed property and funded stock; and of this about £2600 goes to expenses of management. The warden and Fellows are the governing body of the college. The pupils of the school are of two classes—foundation scholars and commoners. The scholars are elected, between 10 and 14 years of age, by competitive examination; the average annual number of vacancies being 10, and the number of candidates 150. The scholars are well boarded, lodged, and educated, at the expense of the foundation; having to pay, for some incidental charges, only from £1, 10s. to £5, 14s. per annum; but tradition exercises a powerful influence at W., and many of the quaint old customs of the school, such as dining off wooden trenchers, &c., are still retained. The number of the commoners has fluctuated much; but owing to the better position in which they were placed by the new regulations of 1857, they have averaged 200 annually for some years; they generally enter between 11 and 16 years of age, and stay 3—4 years, and not being foundation-boys, are boarded in the houses of the head and other masters, at a total annual cost of about £115 (including expense of tuition, pocket-money, and cost of travelling). W. possesses 15 Fellowships and 30 scholarships at New College, Oxford (also founded by William of Wykeham), open to scholars and commoners alike, and tenable for five years, besides numerous other prizes. Fagging is permitted to the 18 chief boys, who are called 'prefects.' The monitorial system was first established in this college.

A church is said to have been built at W. in the year 169; to have been destroyed in 266, restored in 293, and converted into a 'temple of Dagon' (by whom we are to understand Wodin) by the Saxons under Cerdic in 495. In 635, the polluted church was pulled down, and a new one commenced, under the superintendence of Birinus, the first apostle of Wessex; and King Kynegils granted the whole of the land for the space of seven miles round the city for the support of the episcopal seat and the re-established monks. From the year 674, the succession of bishops of W., of which the celebrated St Swithin (see SWITHIN, St) was one, continues unbroken. Of Birinus's cathedral, however, in which most of the Saxon kings of Wessex (see HEPTARCHY) were interred, and on the altar of which, according to tradition, King Canute hung up his crown after

the well-known scene on the sea-shore, no portion remains, and a new cathedral—the present one—was built 'from the foundations' by Bishop Walkelin (1070—1097); and after its completion, and the removal into it of the precious relics of Birinus's cathedral, that old edifice was pulled down. William of Wykeham was bishop of W. from 1367 to 1404, and has more closely than any other bishop associated his name with his episcopal city and its cathedral. He greatly enlarged and beautified the building, and he began the remarkable transformation of the nave from Norman to Perpendicular. The cathedral is 520 feet long, longer than any other English cathedral, with the exception of those of Ely (560 feet), and Canterbury (525 feet). Its breadth at the transepts is 208 feet, the length of its nave is 351 feet, its height 86 feet, and a low central Norman tower 150 feet high. The exterior is somewhat disappointing, owing to its unusual want of decoration, and to the lowness of the tower; but the interior is magnificent, and contains many objects of the highest interest—as the tomb of William Rufus; bronze figures of Charles I. and James I.; mortuary chests which contained the ashes of a number of West Saxon kings and bishops, but which were rifled during the Civil War; the golden shrine of St Swithin, with some excellent specimens of sculpture, both ancient and recent; the tomb of Edmund, the son of King Alfred, and the tomb of Izaak Walton. The various architectural styles to be noted in the cathedral are: Early Norman in the crypt and transepts; Early English in the eastern aisles and chapels behind the presbytery; Decorated in the piers and arches of the presbytery; and Perpendicular in the nave, which, for beauty and grandeur, is only rivalled by York. After the cathedral, there are some churches of interest in the Transition Norman and Perpendicular styles; and there are many other buildings of a religious and educational kind. The industries of W. are unimportant. Pop. of municipal and parliamentary borough (1871) 14,705, represented by two members.

W., the Roman *Venta Belgarum*, was the site of a British city before the arrival of the Romans in Britain, *Cœr-Gwent* (*Gwent* = champaign or down). It afterwards became a Roman station, and, as such, was a place of considerable importance, and contained temples of Apollo and Concord. When taken by the Saxons in 495, it is said to have contained at least one Christian church. The Saxons changed the name *Venta* into *Winte*, and called the town *Wintanceaster*—i. e., the city of the *Winte*, or Winchester. In 1265, during the barons' war, W. was sacked. Up to this time the trade of this town had been considerable, but it never again recovered its commercial prosperity. From the time of Charles II., the town has gradually declined—its chief sources of life and movement being the cathedral and the college.

WINCHESTER, a city of Virginia, U.S., in the valley of the Shenandoah, 150 miles north-north-west of Richmond, 67 west-by-north from Washington; 32 miles by railway to Harper's Ferry. It has 15 churches, an academy, two newspapers, manufactures of shoes, gloves, furniture, soap, &c. March 12, 1862, it was occupied by the Federal General Banks, and was during the war the scene of frequent conflicts, and occupied in turns by the Federal and Confederate armies. Pop. in 1870, 4,477.

WINCING MACHINE, the wheel used by dyers for winding out of their dye-vats long pieces of cloth. The vat is often divided by a partition, and the wincing-machine is generally so placed that it will wind the piece of cloth from one

compartment to the other, according to the direction given to the handle.

WINCKELMANN, JOHANN JOACHIM, well known as the critical expounder and historian of ancient classical art, was born of poor parents in the year 1717, at Stendal, in Prussia. He very early shewed an eager desire for knowledge, and being sent to the free school of the place, became so special a favourite with the rector of it, that he was taken into the rector's house as a companion, when age and blindness made some assistance necessary to him. After studying for a time in Berlin, he went, in 1738, to the university of Halle, where he remained two years engaged in the study of theology, which, however, he found so distasteful that, at the end of that time, he relinquished it, accepting a situation as tutor in a private family at Osterburg. In 1743, he became a schoolmaster at Seehausen—a wretched position, from which he was rescued by the Count von Büнау, who employed him as secretary in his library at Nothenitz. Here he remained some years. Being in the vicinity of Dresden, he had frequent opportunities of inspecting the famous treasures of art accumulated there. He also made the acquaintance of some artists of eminence, among others, the well-known Oeser; and the enthusiasm was awakened which determined his subsequent career. To the theory and history of art he now resolved to devote himself; and on being thrown into the society of the Pope's nuncio, Cardinal Archinto, he was induced, after some hesitation, to become a Roman Catholic, on a promise of a pension being procured for him, to enable him to proceed to Rome. Thither he repaired in 1755, having previously published at Dresden a treatise, entitled *Gedanken über die Nachahmung der Griech. Werke, &c.* (Reflections on the Imitation of the Antique, 1754). Of this work he issued, in 1756, a new and enlarged edition. At Rome, he prosecuted his studies with the utmost ardour, and every facility was afforded him. In 1758, he visited Naples, to examine the celebrated remains of Herculaneum, Pompeii, and Pæstum; and went also to Florence, for the purpose of cataloguing the famous collection of antique gems belonging to Baron de Stoeck, a labour which occupied him for nine months. Soon after, the Cardinal Albani appointed him his librarian, and the salary attached to this post, with the pension continued from Dresden, in itself a somewhat meagre pittance, enabled him to prosecute his studies in comfort. The first-fruit of these appeared in his treatise, entitled *Anmerkungen über die Baukunst der Alten* (Remarks on the Architecture of the Ancients), which was printed in Germany in 1762; and two years afterward, the great work of his life, on which he had been long engaged, the celebrated *Geschichte der Kunst des Alterthums* (History of Ancient Art), was issued from the press of Dresden. In 1767, a supplement to it was added. He also gave to the world the result of his researches at Herculaneum; and in 1766, his *Monumenti Antichi Inediti*, an elaborate work with plates.

In 1768, W., by this time famous throughout Europe, set out to revisit Germany. His destination was Berlin; but on the way, a strange yearning seized him for the Italy he had left; on his reaching Munich, it was no longer to be resisted; and he started thence on his return to Rome. He went by Vienna, where the most flattering attentions were paid him; proceeding thence to Trieste, where he came by his tragic end at the hands of a fellow-traveller, by name Francesco Arcangeli, who murdered him in order to plunder his effects. In this he did not succeed, being scared almost in the act, and presently caught and executed.

W. was the forerunner of a great movement; and his influence has been deeply felt in all the subsequent literature of the subject to which he devoted himself. Even at this day, when a good deal of it is regarded as obsolete, his great *History* remains as a work not to be neglected by any one seriously concerning himself with the study of this branch of æsthetics. The most complete edition of W.'s works is Fernow, Mayer, and Schulze's (8 vols. new ed. Leip. 1823).

WIND is air in motion. The force of the wind is measured by Anemometers (q. v.), of which some measure the velocity, and others the pressure. The following are a few velocities of wind, translated into popular language: 7 miles an hour is a gentle air; 14 miles, a light breeze; 21 miles, a good steady breeze; 40 miles, a gale; 60 miles, a heavy storm; and 80 to 100 miles, a hurricane sweeping everything before it. We also add a few comparisons of velocity and pressure: 5 miles an hour is a pressure of 2 oz. on the square foot; 10 miles,  $\frac{1}{2}$  lb.; 20 miles, 2 lbs.; 30 miles,  $4\frac{1}{2}$  lbs.; 40 miles, 8 lbs.; 51 miles, 13 lbs.; 60 miles, 18 lbs.; 70 miles, 24 lbs.; 80 miles, 32 lbs.; and 100 miles, 50 lbs. During the severe storm which passed over London, on February 6, 1867, the anemometer at Lloyd's registered a pressure of 35 lbs. to the square foot—in other words, the wind during that storm acquired a velocity of 83 miles an hour. Wind is most frequently measured by estimation.

Seamen have more need than landmen to pay attention to every minute variation in the strength of the wind, as well as its direction, and to adopt such phrases as will render that strength generally intelligible. The *Anemometer* (q. v.), which is used on land by scientific men for this purpose, is unsuited to the wants of seamen. They have found it convenient to divide winds into twelve kinds, in relation to strength, designated thus: *saint air, light air, light breeze, gentle breeze, fresh breeze, gentle gale, moderate gale, brisk gale, fresh gale, strong gale, hard gale, and storm*. Each of these is determined by the amount and kind of sail which a ship can safely carry at that moment. The estimate of the wind's force by the scale 0 to 12, means that 0 represents a calm, and 12 a hurricane. If such estimations be divided by 2, and the quotient squared, the result will be the pressure in pounds, approximately.

All wind is caused, directly or indirectly, by changes of temperature. Suppose the temperature of two adjacent regions to become, from any cause, different, the air of the warmer, being lighter, will ascend and flow over on the other, whilst the heavier air of the colder region will flow in below to supply its place. Thus, then, a difference in the temperature of the two regions gives rise to two currents of air—one blowing from the colder to the warmer along the surface of the earth, and the other, from the warmer to the colder, in the upper regions of the atmosphere; and these currents will continue to blow till the equilibrium be restored.

Winds are classed into *Constant, Periodical, and Variable Winds*.

CONSTANT WINDS. *The Trade-winds*.—When the part of the earth's surface which is heated is a whole zone, as in the case of the tropics, a surface-wind will set in towards the heated tropical zone from both sides, and uniting will ascend, and then separating, flow as upper currents in opposite directions. Hence, a surface-current will flow from the higher latitudes towards the equator, and an upper-current towards the poles. If, then, the earth were at rest, a north wind would prevail in the northern half of the globe, and a south wind in the southern half. But these directions are modified by the rotation of the earth



on its axis from west to east. In virtue of this rotation, objects on the earth's surface at the equator are carried round toward the east, at the rate of 17 miles a minute. But as we recede from the equator, this velocity is continually diminished; at lat. 60°, it is only 8½ miles a minute, or half of the velocity at the equator; and at the poles it is nothing. A wind, therefore, blowing along the earth's surface to the equator, is constantly arriving at places which have a greater velocity than itself. Hence, the wind will lag behind, that is, will come up against places towards which it blows, or become an *east* wind. Since, then, the wind north of the equator is under the influence of two forces—one drawing it south, the other drawing it west—it will, by the law of the composition of forces, flow in an intermediate direction, that is, from north-east to south-west. Similarly, in the southern tropic, the wind will blow from south-east to north-west. All observation confirms this reasoning. From the great service these winds render to navigation, they have been called the Trade-winds. It is only in the Pacific and Atlantic Oceans that the trade-winds have their full scope. In other parts of the trades' zone, such as Southern Asia and intertropical Africa and America, they are more or less diverted from their course by the unequal distribution of land and sea, as explained under MONSOON (q. v.).

In the Atlantic, the *North Trades* prevail between lat. 9° and 30°, and in the Pacific, between lat. 9° and 26°; and the *South Trades*, in the Atlantic, between lat. 4° N. and 22° S., and in the Pacific, between lat. 4° N. and 23½° S. These limits, however, are not stationary, but follow the sun, advancing northward from January to June, and southward from July to December.

*Region of Calms.*—This is a belt, 4° or 5° broad, stretching across the Atlantic and Pacific, parallel to the equator. It marks the meeting-line of the north and south trades, where they mutually neutralise each other. Here also occur heavy rains, and thunder-storms almost daily. This belt varies its position with the trades, reaching its most northern limit in July, and its most southern in January. When the belt of calms nears the African coast, in the Gulf of Guinea, the copious rainfall gives rise to the strong steady-blowing gales of that coast, called *Tornadoes*.

*Return Trades.*—It is proved by observation that, while there is within the tropics a surface-wind blowing toward the belt of calms, there is at the same time prevailing, in the higher region of the air, a counter-current constantly flowing toward the poles. These great aerial currents descend to the surface after they have passed the limits of the trade-winds, forming the south-west or west-south-west winds of the north temperate, and the north-west or west-north-west winds of the south temperate zones. The *vesting* of these great equatorial currents is produced by the same cause that gives *easting* to the trade-winds, viz., the rotation of the earth on its axis. Owing to the interference of the north-east or polar current with these winds, the irregular distribution of land and water, mountain and plain, and storms diverting them out of their course, they do not blow with the constancy of the regular trade-winds. They are, however, sufficiently marked and decided to be classed with the constant winds.

*PERIODICAL WINDS. Land and Sea Breezes.*—These are the most general, as well as most easily explained, of the periodical winds. On the coast, within the tropics, a breeze sets in from the sea in the morning, at first a mere breathing on the land, but gradually it increases to a stiff breeze in the heat of the day, after which it sinks to a calm towards

evening. Soon after, a contrary breeze springs up from the land, blows strongly seaward during the night, and dies away in the morning, giving place to the sea-breeze as before. These winds are caused during the day, by the land getting more heated than the sea, consequently the air over it ascends, and the cool air from the sea flows over on the land to supply its place; and during night, by the temperature of the land falling below that of the sea, and the air becoming thereby heavier and denser, flows over the sea as a land-breeze. It is within the tropics where sea-breezes are most marked and constant, because there the sun's heat is greatest, and atmospheric pressure is practically uniform, except in those rare instances where it is disturbed by hurricanes. But in countries such as Great Britain, where atmospheric pressure is most commonly, to some extent, greater or less than that of surrounding regions, the strength of the wind blowing from the high to the low barometer is far stronger than that which would result from the disturbance caused by the unequal heating of land and water; and consequently the sea-breeze is not felt. In the warm months, however, when barometers are nearly equal over northern and western Europe, there is a gentle sea-breeze all round Great Britain during the heat of the day, and a land-breeze during night. Quite analogous to the land and sea breezes are the Monsoons (q. v.), which are only the north trades drawn out of their course in summer by the heated regions of Southern Asia—the south-west monsoon being only a vast sea-breeze blowing on Southern Asia, and continuing several months of the year.

*VARIABLE WINDS.*—These winds depend on purely local or temporary causes, such as the nature of the ground, covered with vegetation or bare; the physical configuration of the surface, level or mountainous; the vicinity of the sea or lakes; and the passage of storms. Within the tropics, all except the last of these is borne down by the great atmospheric currents, which prevail there in all their force. But in higher latitudes this is not the case; these, therefore, are the regions where variable winds prevail. The most noted of these winds are the Simoom (q. v.), Sirocco, Solano, and Harmattan (q. v.). The *Puna Winds* prevail for four months in the year in a high barren table-land in Peru called the Puna; as they are part of the south-east trade-wind, after having crossed the Andes they are drained of their moisture, and are consequently the most dry and parching winds that occur anywhere on the globe. In travelling over the Puna it is necessary to protect the face with a mask from the glare and heat of the day, and from the intense cold of the night. The *East Winds* which prevail in the British Islands in spring are part of the great polar current which at that season descends over Europe through Russia. Their origin explains their dryness and unhealthiness. It is a prevalent notion that the east winds in this country are damp. It is quite true that many easterly winds are peculiarly damp; all that prevail in the front part of Storms (q. v.) are very damp and rainy, they being simply an indraught of the air towards the low barometer which is advancing from the west at the time; and it is owing to this circumstance that in the east of Scotland the greater part of the annual rainfall falls with easterly winds. All of these damp easterly winds, however, soon shift round to some westerly point. But the genuine east wind, which is the dread of the nervous and of invalids, does not shift to the west, and is specially and intolerably dry. In the third week of May 1866 this character was strongly marked, when at many places in Scotland the humidity was only 40,

## WINDAGE—WINDERMERE

and on some occasions as low as 29; the degree of this dryness will be appreciated when it is stated that the driest month during eleven years ending with 1866, shewed a humidity only of 73, saturation being 100. While this wind lasted, the daily range of temperature was double the usual amount, the soil was parched, and the leaves of trees and plants were blackened and destroyed. Deaths from brain-diseases and consumption reach the maximum in Great Britain during the prevalence of east winds. The *Blesian Winds* are northerly winds which prevail in summer over the Mediterranean Sea. They are caused by the great heat of North Africa at this season, and consist in a general flow of the air of the cooler Mediterranean to the south, to take the place of the heated air which rises from the sandy deserts. The *Mistral* is a steady, violent north-west wind, felt particularly at Marseille and the south-east of France, blowing down on the Gulf of Lyons. The *Pampero* blows in the summer season from the Andes across the pampas of Buenos Ayres to the sea-coast. It is thus a north-west, or part of the anti-trade of the southern hemisphere, and so far analogous to the stormy winds which sweep over Europe from the south-west. But since it comes from the Andes over the South American continent, it is a dry wind, frequently darkening the sky with clouds of dust, and drying up vegetation.

Lord Bacon remarked that the wind most frequently veers with the sun's motion, or passes round the compass in the direction of N., N.E., E., S.E., S., S.W., W., and N.W., to N. This follows in consequence of the influence of the earth's rotation in changing the direction of the wind. Professor Dove of Berlin has the merit of having first propounded the *Law of the Rotation of the Winds*, and proved that the whole system of atmospheric currents—the constant, the periodical, and the variable winds—obey the influence of the earth's rotation.

**WINDAGE**, in a Gun, the difference in diameter between the bore of the piece and the projectile with which it is loaded. Formerly, a considerable

windage was allowed; but this only served to diminish the force of the explosion, and to give an irregular motion to the shot. In the present rifled artillery, it is sought to reduce the windage to a minimum, as  $\cdot 01$  of an inch. Some windage is indispensable, or the shot would jam either going in or coming out.

**WINDAGE** (from cannon-balls), or **WIND CONTUSIONS**. Military surgeons so often meet with cases in which serious internal mischief (as, for instance, the rupture of the liver, concussion of the brain, or even a comminuted fracture of a bone) has been inflicted, without any external marks of violence to indicate its having resulted from the stroke of a cannon-ball, that they were led to the conclusion that solid objects projected with great velocity through the air might inflict such injuries indirectly by aerial percussion; the hurt being inflicted either directly by the force with which the air is driven against the part, or indirectly by the rush of air to refill the momentary vacuum created by the rapid passage of the ball. So many observations have, however, been made of cannon-balls passing close to the body (even shaving part of the head, tearing away portions of uniform, or carrying off the external ear or the end of the nose, without further mischief), that this hypothesis is totally untenable, and is now generally rejected. The true explanation of the cases formerly attributed to the windage of cannon-balls appears to rest, according to recent views, 'in the peculiar direction, the degree of obliquity with which the missile impinges on the elastic skin, together with the situation of the structures injured beneath the surface, relatively to the weight and momentum of the ball on one side, and hard resisting substances on the other.' See Longmore's article on 'Gun-shot Wounds' in Holmes's *System of Surgery*, vol. ii., pp. 18—20, where the subject is fully discussed.

**WINDERMERE**, **WINANDERMERE**, or **LAKE WINDER**, the largest lake in England, called, on account of the supposed superiority of



Lake Windermere, from Ellaray.

its shores, in point of natural beauty, over those of the other lakes of North-western England, the 'Queen of the Lakes,' is partly in the county of Lancaster, and partly divides that county from Westmoreland. It is 11 miles long, and about 1 mile in extreme breadth, is fed by the Brathay and the Rothay, the waters of which become united before

entering the lake, and by the streams which drain the neighbouring lakelets of Esthwaite, Troutbeck, and Blelham, and discharges its surplus waters southward into Morecambe Bay by the Leven. Next to Wast Water, W. is the deepest of all the English lakes, its greatest depth being 240 feet, while Wast Water is 270 feet deep. It contains

a number of islands, the largest being 28 acres in superficial extent, and the chief of which are Rough Holm, House Holm, Lady Holm, and Curwen's or Belle Isle. Soft rich beauty is the principal characteristic of the islands of the lake, of the wooded shores, and of the scenery around; there being a total absence of that wildness and sublimity which characterises some of the other lakes, except at the north end, where Langdale Pikes, Harrison Stickle, Sca Fell, and Bow Fell stand forward prominently in the landscape. The east and west shores are bounded by gentle eminences exuberantly wooded, and numerous villas and cottages peeping out of the woods give an aspect of quiet domesticity to the landscape. About a mile from Waterhead, at the north extremity of the lake, is the town of Ambleside,  $1\frac{1}{2}$  miles north-west of which is Rydal, the residence of the poet Wordsworth; in the vicinity of Waterhead is Dove's Nest, the cottage at one time occupied by Mrs Hemans; further down the east shore is Ellaray, famous as the residence of 'Christopher North;' and half-way down the lake, on the eastern shore, is Bowness.

WINDGALLS are puffy swellings about the joints of animals, particularly of horses, correspond to the ganglions of human surgery, and result from irritation and inflammation being set up within the delicate synovial cavities, which thus secrete an unusual quantity of thickened synovia. Rest, moderate work, wet bandages, and occasional blisters reduce the swellings, but with fast roadwork they are apt to reappear, especially in old horses.

WINDHAM, RIGHT HON. WILLIAM, English statesman, born, 1750, in Golden Square, London, was son of Colonel Windham of Felbrigg Hall, Norfolk, in which county the family had been settled since the 12th century. He was educated at Eton, and was afterwards sent to Glasgow University, where he studied mathematics with success. In 1761, he entered at University College, Oxford. After the usual course of travel, he began to acquire notoriety as an opponent of the administration of Lord North. His oratorical exercises were interrupted by a design of visiting the North Pole, and he accompanied the expedition in which Nelson, then a youth, took part. He found the sea-sickness intolerable, was put on shore in Norway, and returned home in a Greenland whaler. In 1781, he was returned to parliament for Norwich, and took his seat among the Whigs. In 1783, on the formation of the Portland ministry, remarkable for the coalition of Lord North and Mr Fox, he became principal secretary to Lord Northampton, then lord-lieutenant of Ireland. Before leaving England, he called upon his friend Dr Johnson, and lamented that his situation would compel him to sanction practices he could not approve. 'Don't be afraid, sir,' replied the doctor, 'you will soon make a very pretty rascal.' Ill-health, or, perhaps, conscientious scruples, soon caused him to resign his secretaryship. In 1784, he seconded Burke's motion for a representation to the throne on the state of the nation. There is an admirable and characteristic sketch of W. in Macaulay's description of the trial of Warren Hastings: 'There, with eyes momentarily fixed on Burke, appeared the first gentleman of the age, his form developed by every manly exercise, his face beaming with intelligence and spirit—the ingenious, the chivalrous, the high-souled Windham.' Abandoning his old friends the Whigs, he followed Mr Burke, and ranged himself on the side of Mr Pitt in opposing the speculative doctrines of the French Revolution, and supporting the war with France. In 1794, he became secretary-at-war under Mr Pitt, with a seat in the cabinet.

He now attacked his former friends with the utmost acerbity. He went out with Pitt in 1801, and sided with the Grenvilles in stigmatising the peace of Amiens, concluded by the Addington administration in 1801. This lost him his seat for Norwich, but he was elected for St Mawes, and on the return of the Grenville party to power, he became colonial secretary. In 1806, he brought forward his plan of limited service in the army, proposing that the infantry should be enlisted for seven years only, with liberty to renew their services for another seven years, receiving an increase of pay; cavalry and artillery to be enlisted for ten years, the second period six, and the third five years. He also proposed to increase the pay and pensions of officers and men, and generally to better the condition of the soldier. The plan was strenuously opposed, but passed into a law. He went out of office in 1807, when the Portland administration was formed (having previously declined the offer of a peerage), and strongly denounced the expedition against Copenhagen, and afterwards the disastrous Walcheren Expedition. In 1806, a clause was introduced by Lord Castlereagh (who had succeeded W. in office) into the Mutiny Act, permitting men to enlist for life, contrary to W.'s scheme of limited service, which was, however, re-adopted in 1847. In May, he underwent a surgical operation for extracting a tumour from his hip, from the effects of which he died June 3, 1810.

W. was an excellent speaker, and one of the most effective and skilful debaters of his time, as will appear from his speeches collected by Mr Amyott, his secretary, and published, with a Life prefixed, in 3 vols. 8vo. Fox said he had never met a meditating man with so much activity, or a reading man with so much practical knowledge. Pitt declared that his speeches were the finest productions possible of a warm imagination and fancy. Canning described his eloquence as, if not the most commanding, at least the most insinuating that was ever heard in the House of Commons. Dr Johnson, who was much attached to him, declared that, in the regions of literature, W. was *inter stellarum lumen minores*. He possessed brilliant conversational powers. Yet, notwithstanding his great talents and rare gifts, he appears in the page of history as the mere shadow of a man. In his lifetime, he gained the disparaging nickname of 'the weather-cock.' He was fond of paradox, and once defended bull-baiting in the House of Commons with great vivacity and ingenuity. Although a man of refinement and sensitiveness, he had a passion for pugilism, and was a regular attendant upon prize-fights. The publication of his *Diary from 1784 to 1810*, by Mrs Henry Baring (1866) discloses the secret of his weakness. Morbidly self-conscious, he was always watching himself, pulling himself to pieces, and recording the doubts that haunted him as to his mental capacity. Acknowledged by his contemporaries to be one of the manliest of men, he succeeded in infusing into his mind doubts with respect to his own courage. He got rid of this delusion by going under fire in the trenches at the siege of Valenciennes; but no sooner was he convinced that he was not a coward than he began to be afraid he was discreditably insensible to the scenes which were passing around him! With brilliant faculties, he was in fact an intellectual hypochondriac incapable of achieving anything great.

WIND-INSTRUMENTS, musical instruments of which the sounds are produced by the agitation of an enclosed column of air. They are generally classified into *wood instruments* and *brass instruments* (both of which are played by the breath), and the *organ*.

## WINDLASS—WINDMILL.

The name wood instruments is applied to musical instruments constructed either of wood or of ivory, of which the principal are the flute, piccolo, clarinet, flageolet, basset-horn, oboe, and bassoon. They are generally characterised by a soft, smooth, aerial tone, resembling the human voice. By the use of holes and keys, considerable compass is given to them; they are capable of producing only one sound at a time, but with considerable command of piano and forte. Of brass instruments the chief are the horn, trumpet, trombone, cornet-a-piston, euphonium, bombardon, and ophicleide. They are generally more powerful, and their quality more piercing than wood instruments; the ophicleide, however, approaching more than the rest to wood instruments in capabilities and tone. In a full orchestra there are generally two flutes, two oboes, two clarinets, two or four horns, and two bassoons, frequently with the addition of two basset-horns, one or two piccolos, and one or two ophicleides or trombones. Each part, except when there is an unusually large number of bow-instruments, is single.

The organ is a combination of a large number of wind-instruments, sounded, not by the breath, but by the admission of air into the wind-chest, by means of keys pressed down by the performer.

**WINDLASS** is that modification of the wheel and axle which is employed in raising weights, such as bucketsful of water from a well, coals from a pit, &c. Its simplest form is that of an axle supported by pivots on two strong upright pieces, and pierced near one end with four or six square holes,

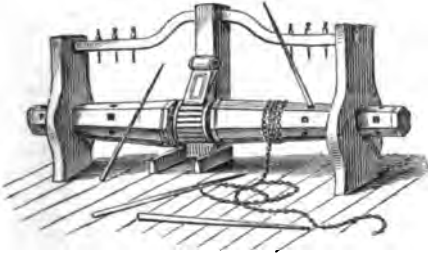

Fig. 1.—Ship's Windlass.

into which handles, known as *handspikes*, are inserted. In other forms, a winch at each end is substituted for the handspikes. If the weight (say a bucket of water) is to be lifted a considerable distance, the length of the rope which attaches it to the axle largely increases the weight, and thus aids the power when descending, and counteracts it when ascending. This difficulty is partially got over by employing a double rope with two buckets, one of which ascends while the other descends; but this modification, though partially effective for the end in view, lends aid to the power when aid is least, and hinders it when aid is most, required. A more efficacious plan is to form the axle not cylindrical, but of a barrel-shape, like two truncated cones placed base to base, and to fasten two ropes, one to each end, so that when coiled up round the barrel they approach the middle; in this case, when one rope is fully uncoiled, and winding-up commences, the gross weight, which is then at its maximum, acts at the minimum leverage of the end, and as the progress in winding up diminishes the weight, its leverage so increases that the momentum is preserved uniform. On the other hand, the empty bucket, when commencing its descent, acts at its greatest leverage, and as the unwinding of the rope adds to the weight, its

leverage becomes smaller, so that the momentum of the descending weight always remains the same; and thus the strain on the power is preserved uniform. The ratio of the weight to the power it is sometimes found necessary to increase greatly; but with the ordinary windlass this could only be effected by similarly increasing the ratio between the leverage of the handle and the radius of the axle—an object attained by a great increase of the former, rendering the machine too cumbrous, or by greatly diminishing the latter, and so weakening it. The desired result is attained, however, in a manner not liable to these objections, by the use of

the *differential axle* (fig. 2), an axle of which one half is of greater diameter than the other, and the single rope, after being coiled round the whole axle from end to end, is fastened at each end of the axle, and the weight is hung by a pulley, which is supported in a bulge in the centre of the rope. As the portion of the rope

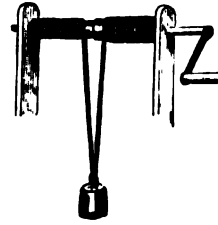

Fig. 2.

on one half of the axle is unwound, that on the other half is wound up; but since the rates of winding and unwinding are different, the bulge of the rope increases when the rope is wound on the smaller end of the axle, and decreases when it is wound off the smaller end. The more nearly equal the two radii of the axle are, the greater is the weight which can be raised by the power—the ratio between the two being  $W$

radius of circle described by power

$P = \frac{\text{difference of radii of the portions of the axle}}{\text{radius of circle described by power}}$ ; so that if the radius of the power is 18 inches, and the radii of the axle 5 and 4 inches, the power balances a weight = 18 times itself; while the strength of the axle requires to be only equal to that of one of the ordinary kind, in which the power can only balance a weight =  $4\frac{1}{2}$  times itself. The same principle is applied to the Screw (q.v.). For a very accurate estimate of the mechanical advantage of the windlass, the thickness of the rope must be taken into account, by adding half of its diameter to the radius of the axle.

**WINDMILL** is a mill for grinding corn, sawing wood, or performing any other species of work for which fixed machinery can be employed, the motive-power being the force of the wind acting on a set of sails in a manner similar to that of a current of water impinging obliquely on the float-boards of a water-wheel. The structure is a conical or pyramidal tower of considerable height, and covered over at the top with a species of dome, *aaa* (fig. 1), which is so fastened as to revolve upon it round the upper extremity of the shaft *c*, as a centre, the motion being aided by the interposition of 'castors' between the wooden rings which form respectively the base of the dome and the top of the tower; the sails, *b, b*, are attached to the extremity of the axis *d*, so as to revolve in a plane at right angles to it, and the motion they communicate to the axis is transferred by the bevelled wheels *e* and *f* to the upright shaft *c*, by which it is in turn conveyed to the working machinery at the bottom of the tower. The axis *d* of the sails, which is inclined at an angle of about  $10^\circ$  to the horizontal, is fixed at one end to a projection from the top of the shaft *c*, and at the other to a circular orifice in the side of the dome, so that it revolves with the latter, carrying the sails along with it; this arrangement is adopted for the

purpose of enabling the plane of rotation of the sails to be placed always at right angles to the direction of the wind. This transference of the plane of rotation was at one time effected by manual labour

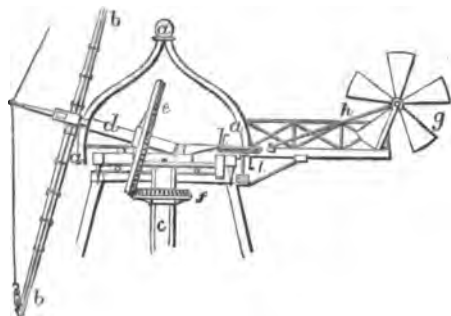

Fig. 1.

applied to a winch at the bottom of the tower, the rotation being communicated, by an endless band and wheel-work above, to the dome, the outer circumference of the base of which, was, for this purpose, furnished with a circle of rack-work. But this clumsy arrangement was superseded in English windmills by an ingenious contrivance due to Sir William Cubitt, by which the wind itself was made to turn the sails into their proper position. The apparatus by which this is effected consists of a revolving flyer or fan, *g*, projecting from a gallery fastened to the dome on the side opposite to the sails; *h*, a long thin shaft to which a revolving motion is communicated by a toothed wheel on its outer extremity, from a corresponding wheel on the axis of the flyer (these wheels are not seen in the fig., being behind the flyer);

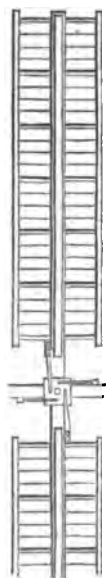

Fig. 2.

a pinion at the other end of the shaft acts upon the cog-wheel *h*, which carries, on the lower extremity of its axis, a pinion *i*; and this last can, at pleasure, be put into gearing with the rack-work or cog-circle on the lower edge of the dome. The construction of the sails, which are four in number, is shewn in fig. 2. Each sail consists of a whip or radius of from 33 to 40 feet in length, firmly fastened at right angles to the sail-axle, and pierced at from  $\frac{1}{3}$ th or  $\frac{1}{4}$ th of its length from the axle to its extremity with about 20 holes, into each of which is inserted a cross-bar of 5–6 feet in length; and this framework, strengthened generally by light rods connecting the ends of the cross-bars, is then covered with canvas. The cross-bars, however, are not, as in the figure, set in the plane of revolution of the whips, for, in that case, the wind, acting in a direction coinciding with that of the sail-axle, would impinge perpendicularly on the sails, and no rotatory motion would result; the bars, therefore, are set at an angle to this perpendicular direction, yet not all at the same angle, for the velocity of each point of the sail increasing with its

distance from the sail-axle, the inclination must vary from the first cross-bar to the outer extremity. It is found that a variation of the angle from 18°, at the first cross-bar, to 7° at the extremity, is a very effective form. The amount of sail that a windmill can carry with advantage is limited, according to

Mr Smeaton (q. v.), one of the great authorities on this subject, to  $\frac{1}{3}$ ths of the area of the circle described by one whip; the velocities of a sail, when unconnected with, and when producing its maximum effect on the machinery below, are as 3 to 2; also, the increase of useful effect varies with the square of the wind's velocity, and is proportional to the cube of the length of the whip, in sails of similar form. A windmill with sails of 40 feet radius is equivalent to 65,000 foot-pounds per minute. Another species of windmill, known as a horizontal windmill, is a large circular frame of wood which rotates on a vertical axis, and carries a set of sails which revolve in a horizontal plane. This form is, however, not nearly so effective as the other, it being evident that the wind can only act effectively on one sail at a time. According to Sir David Brewster, the power of a horizontal mill is only about one-third or one-fourth of that of a vertical mill, the number and size of the sails being equal in each. An ingenious form of horizontal windmill was patented by Mr Giraudat of New York in 1861. The peculiarity is in the sails, which are hinged in such a way that the force of the wind acting on one face of them preserves their perpendicularity to it, and secures a maximum effect, but when, after a further semi-revolution, the other side is presented to the wind, they are raised to a horizontal position. Most of the recent improvements in windmills have had for their object the regulation of the sail-area exposed to the wind to counterbalance the variations in the latter's force, and so produce uniformity of motion; but these are too numerous to be here noticed. We may mention, however, that the inventions, with this object, of Mr Bywater in England, M. Berton in France, and Mr Henry Glover of Massachusetts, are both ingenious and effective. Windmills were introduced into Europe from the Saracens, and were formerly much more extensively used in England than now. They are, however, still common in the midland and southern districts; on the continent, especially in Holland and France; and in the United States.

WINDOW (connected with *wind*, as Lat. *fenestra* with *ventus*) is an opening in the wall of a building for the admission of light and air. In the East, from time immemorial, windows open not upon the street, but upon the court, and are usually provided with lattices or jalousies. The Chinese use, instead of window-glass, a thin stuff varnished with shining lac, polished oyster shells, and thin plates of horn. Among the Romans, windows were originally closed with shutters; afterwards they were made of a transparent stone, *lapis specularis*, which, from the description, can be nothing else than mica; and in the 2d c. after Christ, of horn. According to some, there are traces of glass windows having been used in Pompeii; but the matter is doubtful. The first indisputable mention of glass windows is made by Gregory of Tours in the 4th c. of our era, who speaks of church windows of coloured glass. Wilfrid (q. v.), on succeeding to the archbishopric of York in 669, filled the vacant windows of the cathedral with glass. In 674, Abbot Benedict Biscop brought artists from France to glaze the windows of the Abbey of Weremouth; and the Bishop of Worcester did the same in 726. Leo III., in the end of the 8th c., put glass windows into the church of the Lateran. Glass began to be used in windows of private houses in England as early as 1180; in France in the 14th century. As late as 1458, it struck Aeneas Sylvius very much that in Vienna most of the windows were glazed. See GLASS.

In ancient temple architecture, windows were unknown—the light being obtained from openings in the roof. In Gothic architecture, however, the

window is one of the most important features, giving, by the infinite variety of its outline, and the graceful forms of its tracery, as much character and beauty to the Gothic edifices, as the styles and colonnades of ancient art gave to the classic temples.

In the early Gothic or Norman style, the windows were small and comparatively stunted—they were either simple openings with semicircular head, or two such grouped together with a larger arch over

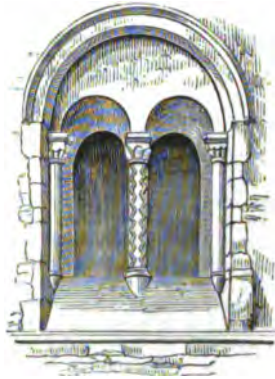

Fig. 1.—Bucknell, Oxford.

both, and with the usual mouldings and ornaments of the style (fig. 1). The inside had generally a deep splay, and simple moulding on the outside. Small circular windows sometimes occur in Norman work.

In the early English style, the windows were more elongated, and had pointed arches. They are frequently grouped in twos or threes, and placed so close, that the wall between becomes a mullion. The wall over the group contained within the enclosing arch, then becomes perforated with a quatrefoil or other ornamental opening, and thus



Fig. 2.—Little St Mary, Cambridge, circa 1350.

the simpler forms of tracery become introduced. The interior arches are splayed off, and are frequently very elaborately decorated with shafts and

arch mouldings. The lancet window (so called from its shape) is common in this style. Circular windows are also used with tracery formed by little radiating shafts with small arches. The triangular window, on a small scale, is also occasionally to be met with.

It is in the Decorated style that the windows become enlarged and filled with mullions and tracery. This is at first simple, and composed of geometric figures such as the origin and progress of Tracery (q. v.) naturally led to. As the style advanced, more flowing forms were introduced, until, in the 15th c., the tracery passed into the Perpendicular Style (q. v.) in England, and into the Flamboyant (q. v.) in France. The heads of the lights, and the apertures in the tracery, are usually foiled, and the inner jambs are splayed and ornamented with mouldings, shafts, &c. (fig. 2). In elaborately traceried windows, the jamb and arch mouldings are occasionally very small, but they are usually bold and deep.

In the later Tudor style, the window-heads became flattened into the four-centre arch; and in the time of Elizabeth and James I., the arch gave place altogether to the flat lintel with the opening divided by mullions into rectangular lights, sometimes foiled at top. Circular windows, with elaborate tracery, are chiefly found in the Decorated period.

In domestic buildings, the windows are similar to the above, but square-headed windows occur more frequently to suit the height of the floors; and the space between the sill and the floor is recessed and fitted with seats. Transoms are also of common occurrence. The Bow or Bay Window (q. v.) is also a frequent and very elegant feature in the later Gothic buildings.

In the revived Classic styles, the windows are almost invariably plain rectangular openings, with either a flat lintel or semicircular arch-head. They have sometimes architraves round the jambs and lintel, or are ornamented with pillars supporting an entablature or pediment above. The architraves are frequently carved, and the cornices carried on trusses at each side.

The style of shop-fronts has been much modified, and the windows enlarged, in consequence of the facilities afforded by the use of plate-glass.

WINDSOR, properly called *NEW WINDSOR*, a municipal and parliamentary borough of Berkshire, beautifully situated on the right bank of the Thames, 23 miles west-south-west of London. W. and Eton in reality form one town. The town is chiefly interesting on account of its being the scene of *The Merry Wives of Windsor*, and the antiquity of its castle and parks, which have been a favourite residence of English monarchs, especially since the time of William the Conqueror. The elevated plateau of natural chalk upon which it stands marked it out, no doubt, as a naturally strong place from the earliest dates, but the deficiency of water which such a position entailed, was a serious objection to its being adopted as a permanent residence for many years. The older palace of the English kings was at *Old Windsor*, about two miles distant, and considerable doubt seems to exist among antiquaries and historians as to the first English king who built solid work of masonry at Windsor Castle. In the time of Edward the Confessor it was probably a wooden structure, as stone was difficult to be had, and wood was abundant. William the Conqueror probably built the first substantial stone buildings, and regularly fortified the place; but the absence of water, except what was carried to it from the Thames, must have for a long time been a serious drawback to its importance as a military station. The history of the existing fabric begins in the reign of Henry

III. The buildings may be said to be grouped in three portions—the Middle Ward containing the Round Tower; the Lower Ward, on the west, containing St George's Chapel, the houses of the Military Knights, cloisters, &c.; and the Upper Ward, on the east, containing the sovereign's private apartments. The unfinished chapel, which was begun by Henry III., was completed by Edward III., rebuilt by Henry VII., and added to by Cardinal Wolsey. Under this chapel is the burial vault of the present royal family. The Round Tower, formerly believed to be Norman, but in which there is not a single yard of Norman masonry, was built in the 18th year of Edward III. to receive the Round Table of the knights of the newly founded order of the Garter. Pop. (1871) 11,769. The park and forest immediately adjoining are 13,000 acres in extent, and contain many historic trees, such as Elizabeth's Oak; Shakspeare's Oak; the Long Walk, made in the reign of Charles II.; and Queen Anne's Ride of Elms, three miles long. Herne's Oak, rendered so famous by Shakspeare, was blown down in Sept. 1863, and a stone and young tree now mark the spot. The oldest planted timber in England, viz., that of the reign of Elizabeth, is also in Windsor Park, and there are many oaks of which it is well established the age must be 1000 years.—See *Sat. Review*, Aug. 11, 1866; Tigue's *Annals of Windsor*; Menzies' *History of Windsor Forest and Parks*.

WINDWARD ISLANDS. See ANTILLES.

WINE, CHEMISTRY AND MANUFACTURE OF. Before entering into the chemistry of this subject, it is necessary that the composition of the grape, from whose juice it is derived, should be understood; and as there is an immense variety of vines yielding grapes of corresponding variety, and as the same variety\* will, under different external influences, produce very different grapes, it is obvious that our researches must be confined to the most typical form of grapes. The principal component of the juice of ripe grapes is water, in which are various substances, either held in solution or very minutely divided. The juice as obtained by pressure, is thick, and exposure to the heat of the sun rapidly changes it into a fermented liquid. As principal components held in solution in the water, Professor Mulder mentions 'sugar (both grape-sugar and fruit-sugar), gelatine or pectine; gum, fat, wax, vegetable albumen, vegetable gluten, and some other substances of the nature of extractive matters, which are not, however, accurately determined; tartaric acid, both free and combined with potash (as cream of tartar), partly also combined with lime; in some cases, we find also racemic acid, malic acid, partly quite free, partly combined with lime, and, according to some, tartrate of potash and alumina; further, oxide of manganese and oxide of iron, sulphate of potash, common salt, phosphate of lime, magnesia, and silicic acid may also exist.'—*Chemistry of Wine*, p. 5. Although no other ingredients have as yet been discovered in grape-juice, others, which only appear during fermentation, and impart not only the vinous smell common to all wines, but the aroma (bouquet) and the flavour peculiar to each wine, must exist in it in small quantities. In those cases where the skins are allowed, as in the preparation of red wine, to ferment with the juice, the constituents imparting odour and flavour may be drawn from

them. Colouring matter and tannic acid are undoubtedly found in the skin, and are thus imparted to red wines. Moreover, the grape-stones, which are left with the skins, yield tannic acid freely during fermentation. The different proportions in which the inorganic matters—the potash, soda, lime, magnesia, iron, manganese, sulphuric acid, phosphoric acid, and chlorine—exist in grape-juice, exert a very great influence upon the quality of the wine, both in relation to its colour and its taste. A relative excess of phosphoric acid, or of lime, or of soda, will induce changes sufficiently obvious to the chemist, but which we have not space to discuss. With regard to the acids of grape-juice, or *must*, as it is technically called, Professor Mulder observes that, as a general rule, the three—viz., tartaric, malic, and citric—are rarely found together in one fruit, and he doubts whether the presence of citric acid has been fully proved. Malic acid exists in unripe, and tartaric acid in ripe grapes; and while no malic acid exists in wine made from perfectly ripe grapes, a small quantity is present in most wines. In the article TARTARIC ACID, it is shewn that a nearly allied acid, *racemic acid*, exists in exceptional cases in grapes. The quality of wine is only affected if this acid be largely present, because less lime than usual will be found in it, racemate of lime being less soluble than tartrate of lime, and further, because cream of tartar is more soluble than bitartrate of potash. Such wines are consequently sweeter, and—if red wines—darker coloured, than wines containing only tartaric acid. The quantity of sugar varies extremely. In the juice of very ripe grapes, it may reach 40 per cent. According to Fontenelle, the juice produced in the south of France contains from 30 to 18 per cent.; while in the neighbourhood of Stuttgart, Reuss determines it at from 25 to 13 per cent. In the low and variable temperature of Holland, the juice of the best grapes yields only 10 or 12 per cent. of sugar. The composition of the albuminous matter is not clearly determined. In an analysis of the must of the Riesling grapes of Grumbach, Beltz found that the gluten (no albumen was found) was thirty times less abundant than the sugar. It probably varies at from 1 to  $\frac{1}{4}$  per cent. The only other ingredient requiring notice is fat, which is chiefly but not entirely derived from the grape-stones, in which it is an abundant ingredient. It occurs in wine, in minute quantity, in the form of a fatty acid.

On the subject of the fermentation of the grape-juice we shall only offer a few remarks. It has been already stated that the saccharine contents of grape-juice range from 13 to 30 per cent. If we regard all this sugar as grape-sugar,  $C_{12}H_{22}O_{11}$ , with an equivalent of 180, then each atom may be resolved into 2 atoms of alcohol,  $C_2H_5O$ , with an equivalent of 46, and 4 of carbonic acid gas,  $CO_2$ , with an equivalent of 22, according to the equation—



provided that there is no loss; or under the most favourable conditions of fermentation, 180 parts (by weight) of anhydrous grape-sugar, or 198 of the hydrated sugar (with the formula,  $C_{12}H_{22}O_{11}$ ), may yield 92 parts of alcohol; or, roughly speaking, 2 parts of sugar yield 1 of alcohol. 'According to this,' says Mulder, 'the juice of French and German grapes gives, when analysed, as a maximum, from 7 to 15 per cent. of alcohol by weight. But some of the sugar remains undissolved, and, during fermentation, more alcohol is evaporated than water; therefore, for such grape-juice, or rather for the wine

\* A certain variety of grape, when grown upon the Rhine, furnishes a species of Hock; the same grape, when raised in the valley of the Tagus, yields Bucoellas; whilst in the island of Madeira it produces the wine known as Sercial, which has a flavour quite different from either of the others. See Miller's *Organic Chemistry*, 3d ed. p. 187.

to be produced from it, the alcoholic contents must be under 15 per cent. as maximum, and 7 per cent. as minimum.—*Op. cit.*, pp. 49, 50. According to Mulder, sugar is found in all wine,\* and its quantity depends to a considerable extent upon the treatment to which the grapes are subjected before pressure. Tokay wine, for example, is prepared from grapes which have been allowed not only to get over-ripe, but partly to dry on the vines; *vin de paille* is obtained from grapes dried on straw exposed to the sun; and in both these cases, water is evaporated, and the concentrated juice yields a wine of extra strength. The strong heavy wines used by the ancients were thus prepared. When the grapes are dried on the vine, the wine is called *vin sec*; and when the juice has been evaporated by the aid of heat, the wine is called *vin cotti*.

In consequence of the close connection which exists between the amount of sugar in the grape-juice and the excellence of the wine which it yields, attempts are often made, especially in bad seasons (want of heat and light, and excess of rain), to introduce extraneous sugar into the juice; or, as it is technically called, to *doctor* it. For this purpose, a cheap fermentable sugar is added to the sour juice, an adulteration which cannot subsequently be detected by chemistry, although it may be suspected, from the absence of the proper aroma from the wine. Similarly, sugar is often added to good grape-juice, in order to obtain a stronger wine than the natural product. Many imitations of Port wine are thus manufactured. The character of the wine is much influenced by the extent to which the process of fermentation is allowed to proceed. If it goes on till all the sugar is converted into alcohol, a *dry* wine is produced; when it is checked before the change is completed, a rich *fruity* wine is produced; and when the wine is bottled whilst the fermentation is still in progress, effervescent wine is formed.

Shortly after the must has passed from the wine-press, symptoms of fermentation appear; the juice becomes more turbid, bubbles rise to the surface, and a froth soon settles there. This process in a moderate climate usually reaches its highest point in three or four days; and before it is quite finished, the whole liquid mass is stirred up so as to re-excite the process. For this purpose, in many districts, a naked man used (we do not know if the custom generally still exists) to go into the wine-tub, who both accomplished the necessary stirring, and promoted fermentation by his animal heat. Several persons have been killed in this way by suffocation from the atmosphere of carbonic acid gas. In two or three weeks, the fluid becomes comparatively clear, and a precipitate forms at the bottom. The wine is now removed from the sediment into another vessel, and a slow form of fermentation—*after-fermentation*, as it is termed—goes on for several months, sugar being constantly converted into alcohol and carbonic acid, and a fresh precipitate forming at the bottom. Several similar changes into other vessels are made, to get rid of the sediment, till it is fit for transferring into casks. That the process of fermentation may go on satisfactorily, not only must water, sugar, and a nitrogenous matter in a state of actual change be present, but there must be a certain temperature and a certain amount of atmospheric air present. 'Although,' says Mulder, 'there is a wide interval between the

extremes of temperature at which fermentation is possible, the boundary is very narrow which limits good and active fermentation in every kind of wine. The grapes of each country ripened under different degrees of summer warmth, and very unequal rich in constituents, require very different temperatures during fermentation; and different temperatures are also required for grapes which are the product of a warmer or a colder summer. But on these points we have little accurate knowledge. All we know is, that a high temperature during autumn promotes fermentation, and a low one is detrimental to it; and that inequality of temperature during fermentation is extremely injurious, and not unfrequently spoils the wine altogether.'—*Op. cit.*, p. 61. To what extent it is expedient to admit atmospheric air to the must, so that the fermentation may go on most favourably, is a point regarding which there has been much discussion, and which is not definitely settled. While some have asserted that no air is necessary to the development of fermentation, others have maintained that the wine is improved by the free admission of air during fermentation. Gay-Lussac proved experimentally that air is essential to initiate fermentation, which would then be continued without any fresh supply; and for many years wine was made in France with an almost total exclusion of air from the fluid by an arrangement intended to prevent the escape of alcohol by evaporation; but when the same chemist proved that by the use of open vats scarcely 1/10th part of the alcohol was lost, this arrangement fell into disuse. Judging from the method of preparing Bavarian beer, in which air is allowed to enter freely, Liebig recommended the same in the case of wine, and suggested that a large opening should be made in the casks in which fermentation takes place. This method has been tried on a large scale by Von Babo, Crasso, and others, with red wine, which was found to be of a better quality than that which underwent the same process in a cask which was closed, and only provided with a glass tube for the escape of the carbonic acid. But in other experiments made with white wine, the wine in open casks appeared to lose in aroma; and hence the solution of this question apparently depends on the kind of wine. Liebig's opinion has been very fiercely, and, as Mulder thinks, unfairly attacked; the probability is, that wines containing much sugar may be allowed with advantage to ferment in closed vessels, while those less rich in that substance may be left in open casks, provided the temperature be low and equable. When the main object is to increase the quantity of alcohol, the admission of much air is injurious, since it promotes the formation of acetic acid, and causes a corresponding loss of alcohol.

The actual substance—*ferment*—which causes the breaking-up of sugar into alcohol and carbonic acid, has been submitted to careful chemical and microscopical examination. One hundred parts of sugar require about 1.5 parts of ferment reckoned in the dry state; and as the analysis of ferment shews that about half of it consists of albuminous matter, it follows that 3/4 of a part of albuminous matter are required for the conversion of 100 parts of sugar into alcohol and carbonic acid. Ferment consists of cells or globules of *Torula* (q. v.), which are precisely the same in the production of wine and beer. It is the contents of these cells which contain the active albuminous matter; while the cell-wall, consisting of cellulose,  $C_{12}H_{10}O_{10}$ , and produced from gum or vegetable mucus, is inert.

The leading points in which the constituents of grape-juice and those of wine differ from one another in consequence of fermentation, are, that in the

\* Dr Bence Jones, in the Appendix to his translation of Mulder's work, declares, on the other hand, that while Port, Sherry (except in two instances), Madeira, and Champagne always contain sugar; Claret, Burgundy, Rhine, and Moselle wine (excepting one sample of Sauterne) are always free from every kind of sugar.



wine there is a diminution (1) of the mucilaginous and saccharine matters, in consequence of the formation of ferment and alcohol; (2) of those substances which are insoluble in common water, but are held in solution in the viscid must, as, for example, phosphate and sulphate of lime; and (3) of cream of tartar, tartrate of magnesia, and sulphate of potash, which, being less soluble in spirit than in water, fall as the formation of alcohol increases. Red wines lose a portion of colouring matter and of the tannin, which is withdrawn by these salts, and hence become of a lighter colour and less astringent. Before noticing the alcoholic strength of different wines, we shall briefly describe the concluding steps necessary for rendering wine fit for use. The process of *clearing* is undertaken with the view of removing all the sediment in which albuminous matters may still occur, and of diminishing the colouring matter and tannin of red wines. Amongst the substances used for these purposes may be mentioned albumen, isinglass, gum, milk, lime, gypsum, &c. In warm countries, gum is preferable to albumen or isinglass. The addition of lime throws down a precipitate of salts of lime, which carries down, in the case of red wine, a considerable quantity of colouring matter; its addition gives a sweeter and less astringent taste to the wine, and an appearance of age. As a general rule, clearing increases the durability of wine. *Sulphurising* is a process which is especially applied to sweet white wines, which possess an excess of sugar and albuminous matter, and little tannic acid, and thus become easily decomposed. Its object is to check undue fermentation, and to prevent the formation of mould, which afterwards imparts a musty taste to the wine. The process is effected by burning sulphur in bottles or casks, and instantly pouring in the wine, which absorbs the sulphurous acid. Wine intended for exportation to warm climates is usually strongly sulphurised. Of course, great care must be taken that the sulphur is free from its common impurity, arsenic. In place of sulphurising, another method of hindering the fermentation of sweet wine is adopted in some parts of France; it consists in putting  $\frac{1}{16}$  part of powdered mustard into the wine; but how it acts is unknown.

Having traced the chemical history of wine from its original state of grape-juice to the time when, having been clarified, and poured into casks and bottles, it is fit for use, we ought, in order to complete the sketch, to notice the subsequent changes which, in the course of time, it undergoes in the cellar. The ages at which different wines attain their perfection are, as is well known, extremely different. 'As a general rule,' says Mulder, 'wines which have retained a considerable portion of albuminous matter, and possess but little tannic acid, cannot resist the influence of time; they become acid, or undergo some other change. This occurs in the case of Rhine wines, which contain but little alcohol; and all those wines which contain much sugar, or but little tannic acid, cannot be kept long. Wines which can be *cellared* are those which improve; or, to speak more correctly, those wines are stored which improve with age. In these, odoriferous substances are formed, and the wine becomes less acid and better tasted. Such wine as is coloured often deposits a considerable amount of sediment; and if it be stored in casks, there is a constant increase of alcohol.'—*Op. cit.*, pp. 105, 106. Wine is improved by being kept in wooden casks, as water escapes by evaporation, and the other constituents are relatively increased. The vinous constituents being thus concentrated, exert a stronger chemical action upon each other, and render the wine not only stronger, but better flavoured. The change, how-

ever, does not stop here. The loss of water must be replaced by the addition of wine, otherwise the action of the air would turn the wine sour, and convert the alcohol into acetic acid; and the diminution of water, which is thus replaced by wine, causes a constant increase of tartaric acid. Wines which are poor in sugar may thus soon become too sour; and consequently, all wines cannot undergo this process. The popular idea, that wine which has grown old in bottles has therefore become richer in alcohol, is altogether false, and is doubtless founded on the fact, that it is only the strongest wines that can be preserved. The colour, however, of bottled wine is materially affected by age: liqueur-wines and red wines containing no large amount of tannic acid, becoming darker, while wines which are rich in tannic acid, as Port, for example, deposit a sediment, and become lighter. Old bottled wines contain odoriferous constituents—ethers of various organic acids—which are not found in new wine. For an explanation of the mode of formation of these compounds, to which wine owes its *aroma*, we must refer to the chapter on 'The Odoriferous Constituents of Wine,' in Mulder's work; we will here merely remark, that diminution of the free acids is necessarily associated with the formation of these compounds, and that this diminution can only occur by the acids being either decomposed or combined with non-acid substances, both of which operations here take place as the result of a very slow chemical process. This effect of time may, however, be imitated by art; and if bottles corked, but not quite filled with wine, are placed for two hours in warm water at a temperature of 185°, and after cooling, are filled, their contents possess the flavour and aroma of wine that has been bottled several years. This result was originally obtained by Appert; but Pasteur and others have, during the last few years, again brought the subject before the French Academy. Wines which have been long in bottle sometimes acquire a peculiar flavour, which is incorrectly referred to the cork. It is in reality due to the peculiar mould which grows from the outside of the cork inwards; and should it reach the inner surface, it imparts to the contents of the bottle a peculiar taste; and this wine is said to be *corked*. Very similar to this is what is known as 'the taste of the cask,' a peculiar flavour sometimes acquired by wine before bottling. This flavour is regarded as dependent on the development of a peculiar essential oil, during the growth of 'mould,' on the surface of the wine. It can be removed by the addition to each pipe of about a quart of olive oil, which dissolves the unpleasant flavouring matter, and carries it to the surface.

In submitting matured wines to chemical analysis it is found that they differ materially from one another in their composition; and especially as the wine is, or is not, red. In white wine, no special colouring matters are found, and only a trace of tannic acid; while in red wine, both are present. In wine generally, the principal ingredients are alcohol and water; then sugar, gum, extractive and albuminous matters; then free organic acids, such as tartaric, racemic, malic, and acetic acid; and salts, such as the tartrates of potash, of lime, and of magnesia, sulphate of potash, chloride of sodium, and traces of phosphate of lime; also, especially in old wines, substances imparting aroma, as cœnanthic and acetic ethers, and other volatile odoriferous matters (amongst which Mulder mentions butyric and caprylic ethers, each having a pine-apple odour, caproic, pelargonic, capric, and propionic ethers, amylic alcohol, and many of its ethers and other compounds, aldehyde, acetal, and probably racemic, citric, and malic ethers). In red wines, and in many

others, a little iron, and possibly some alumina, may be found; and lastly, the best wines contain, according to Fauré, a peculiar matter, which he terms *amantia*, and to which he ascribes the substance or body of the wine; but which seems to other chemists scarcely to differ from gum or dextrine. These ingredients, as Mulder observes, vary exceedingly in proportion. The quantity of some is so small that the substance almost disappears during analysis; others can just be determined by a delicate balance; while others, again, are freely present. Putting aside taste and smell as standards of comparison, most of the essential dietetic and therapeutic properties of wine depend upon the alcohol, sugar, and free acids, especially tartaric acid, contained in it. In his chapter on 'The Amount of Alcohol in Wine,' Mulder gives a large number of analyses of different wines in which the percentage of alcohol is determined. We shall here only give the abstract of the analyses made by his translator, Dr Benoe Jones, who found that the alcohol varies in

	Per Cent.	Per Cent.
Port, . . . . .	from 20.7	to 23.2
Madeira, . . . . .	19.0	19.7
Sherry, . . . . .	15.4	24.7
Champagne, . . . . .	14.1	14.8
Burgundy, . . . . .	10.1	13.2
Rhine Wine, . . . . .	9.5	13.0
Claret, . . . . .	9.1	11.1
Moselle, . . . . .	8.7	9.4

while in

Brandy, . . . . .	there was 50.4	" 53.8
Rum, . . . . .	" 72.0	" 77.1
Geneva, . . . . .	" 49.4	"
Bitter Ale, . . . . .	" 6.6	" 12.3
Porter, . . . . .	" 6.5	" 7.9
Cider, . . . . .	" 5.4	" 7.5

Sugar is found in all wines,\* although in certain kinds very little exists. According to Fresenius, the sugar in four kinds of Rhine wine amounts to exactly six-sevenths of the extract remaining after evaporation, the seventh part consisting of the salts and non-volatile unfermentable matter. In red Bordeaux, on the other hand, very little sugar is found; red Sauterne contains less than 1 per cent. of extract, and Hermitage 1.7; hence the quantity of sugar must be very minute; while some kinds of Muscat yield 24.5 of an extract, containing about 22 per cent. of sugar. Small as is the quantity of sugar in some wines, it is of great importance in diminishing the sharp taste of the free acids, and in imparting an agreeable flavour to the wine. Good red wines should contain at least one-half per cent. of sugar, and the quantity is sometimes larger. Some of the sweet wines contain nearly one-fourth of their weight of saccharine matter.

The following results were yielded by the experiments of Dr Benoe Jones:

Sherry (18 samples), sugar in 1 oz. varied from 4 to 18 grains.	
Madeira (9 samples), . . . . .	6 to 20 "
Champagne (4 samples), . . . . .	6 to 28 "
Port (8 samples), . . . . .	16 to 34 "
Malmsey Madeira, . . . . .	56 to 66 "
Tokay, . . . . .	74 "
Cyprus, . . . . .	102 "

Under the term 'free acids' are included the acid tartrate of potash, known as cream of tartar, and other soluble bitartrates found in wine, besides such acids as are quite uncombined, such as tartaric, malic, and acetic acid, and a trace of free tannic acid. Sugar has so much power in concealing the free acids, that their amount cannot be estimated with any certainty by the flavour of the wine, and must be estimated chemically by ascertaining how much of an alkaline solution of given strength must be used

\* In the preceding foot-note we have mentioned that Dr Benoe Jones denies the accuracy of this statement.

in order to render a given quantity of wine perfectly neutral to test-paper. Volatile acids, as, for example, acetic acid, may either be determined separately, or included with the others; and, excepting this acid, all the other acids occurring in wine may practically be calculated as tartaric acid. Mulder found that acetic acid was present in 20 different kinds of wine which he examined, the amount of the anhydrous acid ranging from 1.75 thousandth parts in Madeira to 0.25 thousandth parts in Tavella. In the same 20 kinds of wines, the free tartaric acid ranged from 2 to 7 parts in 1000 of wine, Tavella having the largest, and Bordeaux Sauterne the smallest quantity. With regard to the tannic acid, traces of it may be found in all white wines, but in no white wine is it sufficiently abundant to be of the slightest importance in a medical or dietetic point of view. On the other hand, it is abundant in Port and heavily loaded Bordeaux wines, especially when new. In the course of time, this tannic acid becomes oxidised into a sparingly soluble compound, which is called by Berzelius the *apothema*, or precipitate of tannic acid—a process which is facilitated by the exposure of the wine in bottles to full daylight. There is no doubt that this acid, by combining with the albuminous matters, tends to increase the durability of these wines. Dr Benoe Jones, in his Appendix to Mulder's treatise, gives numerous results of experiments made regarding the acidity of wines by Prout, Liebig, Fresenius, and himself. His general conclusions are, that, 'proceeding from the least acid wine to the most acid, we have Sherry, Port, Champagne, Claret, Madeira, Burgundy, Rhine wine, Moselle. The least acid fluids examined were Geneva and whisky; then rum, brandy, ale, porter, stout: the wines were all more acid than the malt liquida.' Mr Griffin has made 22 determinations of the acidity of light wines for Dr Druitt, which are published at the end of that physician's instructive little work on *Cheap Wines*, and has subsequently published an independent volume on the mode of determining the acidity of wines.

In conclusion, we may say a word or two on 'the diseases of wine,' by which term we understand those conditions in which the wine has become so altered and unfitted for use as to have lost its distinct character. The most important of these diseases are:

1. *The Turning of Wine*.—This disease is incidental to young wine, and seems to occur under special conditions of the weather. The colour becomes darker, and the taste first disappears, and if the disease goes on, becomes disagreeable; the wine becomes turbid and acid. This disease is caused by a decomposition of tartar.

2. *The Ropiness of Wine*.—This disease consists in the formation of vegetable mucus from the sugar of the wine, and is known as mucous fermentation. The wines liable to this change are those which are deficient in tannic acid.

3. *The Bitterness of Wine*—to which Burgundy wines are especially exposed—seems due to a second fermentation, inasmuch as a large amount of carbonic acid is evolved. It has been ascribed, whether correctly or not, we cannot say, to the formation of citric ether, which is very bitter. The disease is caused by the sediment, and often ceases on being drawn off into other casks.

4. *The Acidifying of the Wine* depends upon the conversion of the alcohol into acetic acid, and may be stopped at its commencement by adding alkaline carbonates, which, however, destroy the colour, and affect the taste of the wine.

5. *The Mouldiness of Wine* is a disease in which mould-plants are produced on the surface of the

wine. How or under what conditions the mould is formed, is not known, except that the admission of air is favourable to the disease.

For further information on this subject, we may refer, *inter alia*, to Henderson's *History of Ancient and Modern Wines*, Bence Jones's translation of Mulder's *Chemistry of Wine*, and to the recent works of Shaw and Denman, in English; to those of Julien, Chaptal, Fauré (1844), and Batilliat, in French; and to those of Ritter, Baling, Von Babo, Bronner, &c., in German; also to the chief works on technological chemistry in all languages.

**Manufacture.**—The mode of manufacturing wine varies in its details in different countries. Pagnierre, in his treatise *On the Wines of Bordeaux*, gives the following description of the manufacture of the superior Clarets. The grapes, after being gathered, are picked; all that are likely to injure the quality of the wine being carefully removed. A principal vat of the best fruit, which is called the mother-cask (*cuve-mère*), is then made, into which, after picking, the workmen continue to put the best grapes, without their stalks, and without treading them, till they are from 15 to 20 inches deep; after which they throw about two gallons of old Cognac or Armagnac upon them, and then another bed of picked grapes, followed by two gallons more of brandy, and so on till the vat is full. Spirit of wine is then added, about four gallons being used for a wine-vat of from 30 to 35 tuns. The amount of brandy and spirits that is added varies with the quality of the vintage, the better vintages requiring the less spirit. When there is a deficiency of saccharine matter in the grapes, starch-sugar is sometimes added. The *cuve-mère*, when filled, is closed and well covered with blankets to prevent the entrance of air, and is left in this state for about a month. A small cock or tap is placed in the side of the vat at about a third of its depth from the bottom, in order to allow of the progress of fermentation being observed; and to enable the manufacturer to know when the wine, having become cool and sufficiently clear, may be racked off and put into casks, previously prepared by scalding and rinsing with a little spirit. While the *cuve-mère* is at work, the ordinary vintage goes on as follows: The grapes are trodden or acted on by machinery in the press, and put with their stalks into the vats, when the fermentation takes place naturally. About a foot of the upper part of the vat is not filled, in order to leave space for the fermentation, which in very mature vintages sometimes occasions an overflow of these limits. The term *chapeau* is applied to the floating mass of stalks, seeds, and skins on the surface. The vats are lightly covered, and in from a week to a fortnight the wine is ready for being drawn off; for if it is left upon the lees (*marre*), or in contact with its crust (*chapeau*), it would take the disagreeable taste of the stalks. The barrels in which it is then placed are filled to about two-thirds or three-fourths, after which the *cuve-mère* is emptied, and its wine is poured in equal portions into these casks so as to fill them; and the remainder is used to replace every week what is lost by evaporation, or may have leaked away. All proprietors have not the means of making a *cuve-mère*; but in its absence, and with the employment of small vessels, wine of an inferior character is produced. The casks being full, are left unbunged for about a week, the bung-hole being in the meantime covered with a brick or piece of wood. They are filled up every two days, and after bunging, at least once a week, till the wine is in a state to allow the cask to rest with the bung-hole at the side, which is not till after a year and a half.

White wines are made in a somewhat different

manner. The grapes are not, as in making red wine, put into the vat to ferment, but after the removal of the stalks, they are trodden, and when taken from the press, the juice, skins, and seeds are put into casks, in which the fermentation takes place, and wine is formed. When the fermentation has ceased, the wine is racked off from the barrels into smaller casks; and any loss that subsequently occurs from evaporation must be replaced once or twice a week.

The nature of the wine-press possesses many modifications. The wine-presses of the Jews consisted of two receptacles, or vats, placed at different elevations, in the upper one of which the grapes were trodden, while the lower one received the expressed juice or must (see Joel iii. 13). These vats were usually hewn out of the solid rock (Isa. v. 2 (margin), and Matt. xxi. 33). In Wilkinson's *Ancient Egyptians*, vol. i. p. 46, there is a figure of a wine-press thus composed of two vats or receptacles. The process of treading, which seems to have prevailed from the earliest ages, is shown in our copy of that figure, the treaders being assisted

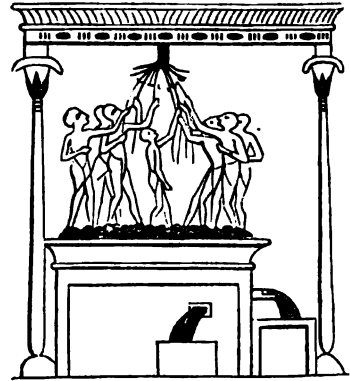

Ancient Egyptian Wine-press.

by ropes fixed to the roof of the press. A certain amount of juice was allowed to exude from the ripe fruit by its own pressure before the treading began. This was kept separate from the rest of the juice, and formed the *gleucos*, or 'sweet wine' noticed in Acts ii. 13. The first drops that reached the lower vat were called the *dema*, or tear, and formed the first-fruits of the vintage, which were to be presented to Jehovah (Ex. xxii. 29). Although the ancient system of treading the grapes still prevails in many countries, it is being gradually displaced by various mechanical appliances. In some parts of France, two wooden cylinders turning in opposite directions are employed to crush the fruit; and the reader will find accounts of more complicated presses in the various works on wine by Cyrus Redding and later authors.

**Commerce.**—The manufacture of wine has been carried on in all countries where the grape could be successfully cultivated, from the very earliest periods of history; and during the present century, it has followed the footsteps of man, and become established in the American and Australian continents, and promises to become, especially in the latter, a most important introduction. The vine, like most cultivated plants, is capable of producing very numerous varieties, and these, of course, give rise to different qualities of wine; but far more influence is exerted upon the quality of the wine by climate, soil, and the position of the vineyard

as to the sun's influence; so that we not only have wines peculiar to particular countries, but of those, again, we have usually very numerous varieties, produced by special causes within those countries; and in addition to all these, again, we have other differences, produced by the degrees of skill in the manufacture. The earliest wines of which we have any account were made in Asia, but of these we know very little. Later on, we find abundant evidence of the high esteem in which wine was held by the Greeks, Romans, and other civilised contemporary nations; and the name of one of the choicest Roman wines has continued in use to the present time, viz., the Falernian. From what we learn from Pliny and other writers regarding the extraneous additions made by the Romans to their grape juice, and the treatment of the interior of their casks, we should much doubt whether even Falernian would be appreciated by the English palate. The following extract from the article 'Vinum' in Smith's *Classical Dictionary* will give a notion of the way in which the ancients 'cooked' their wines: 'The principal substances employed as *conditura* or seasonings were—(1) sea-water; (2) turpentine, either pure or in the form of pitch (*pix*), tar (*pix liquida*), or resin (*resina*); (3) lime, in the form of gypsum, burnt marble, or calcined shells; (4) inspissated must; (5) aromatic herbs, spices, and gums; and these were used singly or cooked up into a great variety of complicated confections. It was customary to line the interior of both the *dolia* or casks, and the *amphora* or pitchers, with a coating of pitch; but besides this, it was customary to add this substance, or resin, in powder, to the must during the fermentation, from a conviction that it not only rendered the wine more full-bodied, but also communicated an agreeable bouquet, together with a certain degree of raciness or piquancy (Pliny, *N. H.* xiv. 25; Plutarch, *Symp.* v. 3).<sup>1</sup> The modern Greeks, it is said, use turpentine or resin in the preparation of their wine, as their ancestors did two thousand years ago. Most Sicilian wines (the ancestors of the Sicilians were Greeks) have a decided resinous taste, as have also the Cape wines. The mediæval history of wine is involved in much obscurity; but we find such abundant mention of Sack and Canary, that although we are not quite clear as to the exact history of those wines, we are not left in doubt as to the high appreciation felt for them by the priesthood and nobility of those times. The Greek islands seem to have furnished a large portion of the wine then consumed in Europe; and the Malmsey of those times was not the produce of Madeira, but of the islands of Tenedos, Lesbos, Chio, and Candia. At a later period the Burgundy Wines (q. v.) of France and the Rhine-wines (q. v.) of Germany became famous, and may be regarded as the commencement of that vast commerce which has now spread all over those countries, and has led to such variety and perfection in the manufacture of this valuable drink. It is beyond the limits of this article to give even a full list of all the known varieties of wine, much less to specify their peculiar qualities. The chief wines of France and Germany are noticed under the heads of Bordeaux (known in England as Claret), Burgundy, Champagne, and Rhine-wines (see also HOCHREIM and MOSELLE). There are very choice sparkling wines made in Germany of both the Rhine (or Hock) and Moselle classes; the Moselle wines have latterly been artificially flavoured either with musk or with elder-flowers, to imitate the flavour of the Muscat grape. At first, it was carefully and judiciously done, but is now often carried to excess.—Hungarian and Austrian wines have lately come into notice in Britain, and the former have found

much favour with some consumers. But although Hungary produces the Tokay (q. v.), which, if genuine and old, is scarcely rivalled in the world, yet the wines commonly used are inferior in many respects to the ordinary wines of France and Germany, which they most resemble. The best known are Carlowitz, St George, and Odenburg—white; and Erlauer, Ofner, Menes, Buda, and Grosswardein—red wines. The best Austrian wines are those of Steinberg, Vöslan, and Goldeck—red and white of each; also an effervescing wine somewhat like Sparkling Burgundy, called Sparkling Vöslauer.

The wines of Spain and Portugal are in the highest esteem in Great Britain—those of the former country best known under the general name of Sherry (from Xeres), and those of the latter as Port (q. v.). The Spanish and Portuguese wines, like those of other countries, differ widely in quality. The highest class of sherries are those which are technically called *dry*, that is, are free from sweetness. The Montilla, Manzanilla, Amontillado, and Vino de Pasto, are of this kind. Some red wines are also made in Spain, as the Tent or Rota Tinto, Pazarété, Val de Penas, Benicarlo, &c. The produce of Spain is enormous, being estimated at nearly 136 millions of gallons.

About the middle of the last century, Port, or the wine of Portugal, became the most important wine for British use, and for the highest qualities, very high prices have always been given; indeed, such is the demand for very old wines of the best vintages, that as much as £35 per dozen bottles, or £17, 10s. per gallon, was realised at a sale for Port wine of the year 1820, not many years ago. This is probably the highest price ever reached for Port; but on the continent, the finest Tokay has realised even more than £36 per dozen at Cracow. Besides Port, we receive from Portugal Bucellas and Lisbon, white wines; and Colares and Calcuvella, red.

The Italian wines are very numerous. The best *reds* are Lambrusco, Barbera, Barolo, Brachetto, Grignolino, Aleatico, Brolio, &c.; the best *whites*, Malvasia, Vino Santo, Lachryms Christi, Vernaccia, &c. Of *sparkling* wines, the Red and White Asti, Passeretta, Nebiola, and one or two others, are very good. They differ much from the sparkling wines of other countries in being much less effervescing.

The chief Greek wines are those of Candia and Cyprus, but not much of either comes to Great Britain.

Madeira was long famous for its fine white wine, but the almost total destruction of the vines by the fungous growth known as the oidium, and causing the grape-disease, temporarily stopped the trade. It is, however, beginning to revive.

From the Cape of Good Hope, very large quantities of inferior wine are sent to Europe, and sold as Sherry. The Red and White Constantia of that colony are, however, excellent sweet wines, of a very luscious character.

The United States of America have begun to grow the vine extensively, and to produce wine. At present, it has all been used for home consumption. The most celebrated is the Catawba, and a very good imitation of Champagne.

The Australian colonies have also commenced wine-making, and have produced very fair qualities; the best is a Hock-like wine, called Cwarra.

Owing to the very fine produce of two small vineyards on the banks of the river Yalta in the Crimea, belonging to Prince Woronzov, the Russian government established a School of Wines in the Crimea, but with very indifferent results, as the efforts of this establishment have been to imitate the wines of other countries, instead of producing distinctive ones of their own locality. The wines of the Prince

Woronzov are great favourites where known: the finest is called *Ai Danil*; the second, *Massandra*; and the third, *Muscot*. They are light white wines, of a most agreeable flavour, and fine golden-yellow colour.

The following, taken from the annual government returns, will shew the vast commerce carried on in this article of trade. Wine imported into Great Britain in 1865, 14,269,752 gallons, value £3,914,196; in 1875, 13,472,406 gallons, value £6,820,679.

*Dietetic and Medical Value of Wines.*—It may be laid down as a general rule, that the use of wine, even in moderate quantity, is not necessary for young or adult persons enjoying good ordinary health, breathing fresh country air, and not exposed to overwork or any other abnormal depressing agency. As, however, life advances, and the circulation becomes languid, wine in moderation becomes an essential, or, at all events, a valuable article of food; and even in earlier life, the physician meets large numbers of townspeople, especially women engaged in sedentary occupations, who cannot digest the national drink, beer, which is admirably suited to our outdoor labouring population, and to persons of higher rank who indulge freely in open-air exercises. In such cases, the beer is replaced by the more grateful beverage, tea, which, however, when taken too freely, and without sufficient solid food, gives rise to a form of distressing dyspepsia, which too often impels the sufferer to seek refuge in spirits. In many such cases, cheap wine, which may be purchased under our new tariff at from 1s. 6d. to 2s. a bottle, mixed with an equal bulk of water, will be found an excellent substitute for the beer or tea. We shall first notice the medical uses of those numerous cheap French, German, and Italian wines which have been, during the last few years, so prominently brought before the attention of the British public by certain enterprising wine-merchants; and then briefly notice the uses of the more expensive wines, such as Port, Sherry, Champagne, &c. In the first department of the subject, we shall take Dr Druitt's *Report on Cheap Wines* as our chief authority, and we shall regard as cheap wines those whose price does not exceed 2s. 6d. a bottle. In prescribing wine, whether cheap or dear, the physician desires to give not merely alcohol, for that might be given far more cheaply under the form of gin or British brandy, but a compound liquid containing not only more salts or mineral ingredients than many a mineral water, but also the extractive parts of grape-juice, and the powerful oils and ethers which give to wine its special flavour or bouquet, and its singular exhilarating properties. 'The distinctive elements of wine,' says Dr Druitt, 'are to be had in abundance in cheap Bordeaux, Burgundy, and other French wines; in Rhine wine; in the Hungarian, Austrian, and some Greek wine; and in all with a natural and not injurious quantity of spirit. In prescribing *pure wine*—i. e., light natural, virgin wine—the practitioner has a perfectly new article of both diet and medicine in his hands.—*Op. cit.*, p. 22. In cases of debility and indigestion, such wine as that which we are now considering, diluted with cold water, may often be freely prescribed with great advantage in place of tea at breakfast, as well as at luncheon or dinner, or dinner and supper, according as the patient arranges his meals. The best of the cheap wines are those of Bordeaux: they are pure, light, and exhilarating; moderately strong, seldom containing 20 per cent. of alcohol; free from sugar and other materials likely to induce gout or headache; and are admirably adapted, according to Dr Druitt (who has experimented largely upon them), for children with capricious and bad appetites, for

literary persons, and for all whose occupations are chiefly carried on indoors, and which tax the brain more than the muscles. They should be taken *at*, not *after*, meals; and in many cases, when judiciously prescribed, they will be of more service to patients suffering from anæmia, chlorosis, dyspepsia, or gouty or rheumatic tendencies, than any form of medicine. The Bordeaux wines are, moreover, of great use in relieving the restlessness, nightly wandering, and thirst that accompany scarlet fever and measles in children; one part of wine with one or two of cold water, according to age, being an excellent drink, acting at once as a diaphoretic, saline, and sedative. The Burgundy wines are fuller, stouter (on an average, from 2 to 4 per cent. stronger in alcohol), and higher flavoured than the Bordeaux of equal price. The cheap Burgundies are inferior to the Bordeaux as medicinal agents; but the higher-priced wines (at and above 4s. a bottle) are of extreme service in cases of debility with nervous exhaustion, and, as Dr Druitt remarks, 'what Bordeaux is to the blood, that is Burgundy to the nerves.' Some of the Hungarian wines which are being now introduced into this country, are excellent substitutes for Bordeaux; and not having the acidity, austerity, and coldness of the latter, are often preferred by patients. Amongst the most important of the *dearer* kinds of wine are Port, Sherry, and Champagne. Good old Port is a tonic of great value in cases of fever and other forms of extreme debility; but many persons past 40 dare not take it if they have any predisposition to gout. Port wine given with warm water, administered with a biscuit at bedtime, often induces a good night's rest during convalescence from fever or other weakening diseases. But during the last 20 or 25 years, its price has risen from 30 to 100 per cent.; and the Port purchased at a vintner's by a poor invalid at 4s. a bottle is usually nothing but doctored British spirit that has been sent to Hamburg to be transmuted into wine. In place of good Port, now unattainable by the poor, the physician had better prescribe good British brandy, if a strong stimulant be required; or such wines as the Hungarian Ofter or French Madeira, if it is the nutritive value of wine that is required. Sherry is, in a dietetic point of view, the wine in most general use in this country, and if pure, it agrees well with most constitutions. It is the only wine admitted into the Pharmacopœia, in which it is employed in the composition of aloetic, antimonial, colchicum, and other medicated wines. It is a wine that suits the stomach in many cases of dyspepsia, but is not often prescribed medicinally. Champagne is a wine that acts as a most valuable medicine in cases of vomiting, irritable stomach, &c., and when the appetite flags, and there is great general debility. Genuine Tokay is so rare a wine that it is almost unnecessary to notice it; it is, however, when procurable, extremely valuable as a cordial for aged persons of broken-down constitution.

WINNIPEG, LAKE, the largest of the lakes belonging wholly to British North America, lies 90 miles north of the state of Minnesota, and about 350 miles north-west of Lake Superior, in lat. 50°-54° N., 96°-100° W. It is 264 miles long, 35 miles broad, has an area of 9000 sq. m., and lies 628 feet above sea-level. It is connected by navigable channels with Lakes Winnipegos and Manitoba, which lie to the west, and run almost parallel with it. Its tributaries drain an area of 400,000 sq. m. Of these, the largest is the Saskatchewan (q. v.), which flows eastward from the Rocky Mts. through a rich alluvial country, and joins the lake near its northern extremity. The Winnipeg River, 300 miles long, and flowing in a north-westerly direction,

WINNIPISCOGEE—WINTER'S BARK.

connects Lake W. with the Lake of the Woods and Rainy Lake. The Red River and its great branch, the Assiniboin, discharge their waters at the southern extremity of Lake W., after flowing through the region to the south and south-west—a region which presents a singular and important combination of prairie and woodland, looking, in many places, like the result of careful culture. Other affluents of the lake, of smaller size, and watering a region incapable of supporting any considerable population, flow from the east. Nelson's River, issuing at the north end of Lake W., is its principal outlet: it flows into Hudson's Bay near York Factory, and forms a great highway of communication between Hudson's Bay and the territory north and west of Lake W.

The basin of Lake W. and its tributaries may be considered as forming the new province of Manitoba. The access to it from Lake Superior lies through a rugged country. There is, however, a prospect of a railway being soon constructed to connect the present Canadian system with the Pacific, running through the heart of the province, and opening up its immense agricultural and mineral wealth.

**WINNIPISCOGEE, or WINNIPESAU'KEE** (the latter being the usual pronunciation), a beautiful lake of New Hampshire, U. S., 25 miles long, by some 10 miles wide, but extremely irregular, with deep bays, bold promontories, and numerous islands from a few yards to many acres, with water clear as crystal, stored with fish, and surrounded with hills and mountain peaks. It is navigated by a steamboat, and is a favourite resort of tourists to the White Mountains.

**WINSEY, or WINCEY**, a cloth of Scotch manufacture, consisting chiefly of wool mixed with a portion of cotton.

**WINTER GREEN**, the popular name of plants of the genera *Pyrola* and *Chimaphila*, of the natural order *Pyrolaceae*, which, according to some botanists, is a sub-order of *Ericaceae*, distinguished chiefly by difference of habit, but also by declinate styles, seeds with a loose winged skin, and a minute embryo in the base of fleshy albumen. Only about twenty species of *Pyrolaceae* are known. They are natives of woods throughout the whole of the northern hemisphere, and are herbaceous or half-shrubby plants, with a corolla of four or five segments, which are almost petals, but are slightly united at the base. Several species of *Pyrola* are natives of Britain, perennial herbaceous plants, with flowers of some beauty. Two species of *Chimaphila*, half-shrubby plants, with beautiful evergreen leaves, natives of North America, *C. umbellata* and *C. maculata*, are valued for their tonic, diuretic, and narcotic qualities, and are used in dropsy, calculus, strangury, and other diseases.

**WINTERGREEN, OIL OF, or Gaultheric Acid**, is an essential oil yielded by the flowers of the *Gaultheria procumbens* (see GAULTHERIA), abundant in New Jersey, and consisting chiefly of salicylate of methyl ( $C_6H_5O, C_{14}H_9O_6$ ), mixed with a small quantity of a hydrocarbon, termed *Gaultherilene*, which is isomeric with oil of turpentine, and which, being more volatile than the salicylate of methyl, is easily separated from it. The latter is so much the more abundant constituent of the oil, that the two may be practically regarded as identical. This oil is not only yielded by the distillation of other plants, as the leaves and flowers of *Monotropa hypopitys*, and the bark of *Betula lenta*, but may be artificially formed by distilling a mixture of 2 parts of crystallised salicylic acid, 2 of anhydrous wood-spirit, and 1 part of oil of vitriol. In whatever mode it is obtained, it presents the appearance of a colourless or yellow oil, of a

powerful, agreeable, and persistent odour; and hence it is largely used in perfumery.

**WINTER MOTH** (*Cheimatobia brunata*), a species of moth, the caterpillar of which is very injurious to plum trees. It has long been well known as common in many parts of the continent of Europe, and has of late begun to be very abundant also in some parts of England, as in the Vale of Evesham, in Worcestershire, celebrated for its

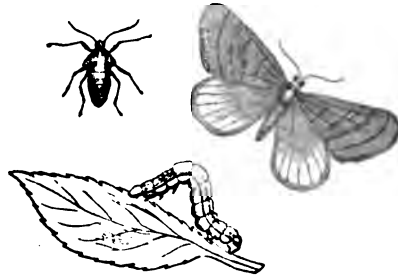

Winter Moth, wingless Female, and Caterpillar.

plum plantations, where damage has been done by it to the extent of £20,000 or £30,000 in a year. It is an insect about half an inch long, of a light-brown colour. The male alone has wings; the female, as in a few other moths, is wingless. The eggs are hatched early in spring, and the caterpillars, at first very minute, feed upon the buds of the plum. The eggs are deposited on trees, chiefly around the base of the buds, and in chinks of the bark. Like most of the moths, this insect is nocturnal in its habits. It is during night that the males fly about the trees, and the wingless females creep up their stems. The best mode of preventing its ravages is to surround the stems of the trees with something over which the females cannot climb from the ground, in which they pass their chrysalis stage. Boxes are used for this purpose in Germany, in which the ascending insects are trapped. A more easy method is to coat the trees with a composition of tar and grease in the beginning of winter, the time at which these moths appear in their perfect state, and when, of course, the laying of eggs takes place. By visiting the plantation of plum trees with a lantern at this season, the gardener is often also successful in killing great numbers of them.

**WINTER'S BARK**, a stimulant, aromatic, and



Winter's Bark (*Wintera aromatica*).

tonic bark, resembling cinnamon, and used for the same purposes. It derives its name from Captain

Winter, who first brought it from the Strait of Magellan in 1579. It is the produce of *Drimys Winteri*, a native of some of the mountainous parts of South America, and abundant in the lower grounds of Cape Horn and Staten Island—an ever-green shrub with laurel-like leaves, corymbs of white flowers, and many-seeded berries. This shrub belongs to the natural order *Magnoliaceæ*, and to a section of it which has by some been constituted into a separate order, *Winteraceæ*, chiefly distinguished by dotted leaves and aromatic qualities. The Star Anise (*Illicium*) is nearly allied to it. The bark of other species of *Drimys* has similar properties to Winter's Bark, as that of *D. Granatensis*, much used in Brazil as a remedy for colic, and of *D. acillaris*, a New Zealand tree.

WINTERTHUR, one of the most industrious and beautiful of the smaller towns of Switzerland, in the canton of Zurich, stands on the Eulach, 14 miles north-east of Zurich. Its situation among hills, many of which are clothed with vines, is specially pleasant. Cotton-spinning, cotton-printing, dyeing, and the manufacture of machinery and weapons, are actively carried on. Pop. (1870) 9404.

WINTHROP FAMILY.—JOHN, governor of the colony of Massachusetts, was born in Groton, county of Suffolk, England, January 12, 1588, was bred to the law, appointed Justice of Peace at the age of 18, and on account of his excellent and pious character, was, in 1629, elected by the governor and company of Massachusetts Bay to govern their colony. He sold his estate, and April 7, 1630, sailed from Yarmouth with 900 persons. During the voyage, he composed an essay, entitled *A Model of Christian Charity*. He was re-elected governor every year until 1634, when he became deputy-governor under Sir Harry Vane, with whom he had an animated controversy on the doctrines of Mrs Hutchinson. In 1637, he was elected over Sir Harry, and continued governor, with a brief interval, during his life, and had more influence probably than any other man in forming the political institutions of the northern states of America. He was opposed to an unlimited democracy, for he said: 'The best part of a community is always the least, and of that best part the wiser part is always the lesser.' He kept a journal up to 1649, two books of which were published in 1790; and the third, found in the New England Library, kept in the tower of the Old South Church in Boston, in 1816. A revised edition was published at Boston, in 2 vols. (1825—1826). He died at Boston, March 26, 1649.—JOHN, governor of Connecticut, son of the preceding, was born at Groton, England, February 12, 1606; educated at Trinity College, Dublin; made the tour of Europe; went to America in 1631, was chosen a magistrate in Massachusetts, but returned to England; and in 1635 went to Connecticut, built a fort at the mouth of the Connecticut River, was made governor of the colony, and founded the city of New London in 1661. He obtained a charter for the colony from Charles II., and was first appointed governor under it; and, in 1676, represented his colony in the congress of the united colonies at Boston. He was a man of eminent virtues, and considerable acquirements. Some of his papers are contained in the *Philosophical Transactions*. He died at Boston, April 5, 1676.—JOHN, LL.D., American scholar, a descendant of the first Governor W., was born in Massachusetts, 1715; graduated at Harvard College, 1732; and in 1738 was appointed Hollis Professor of Mathematics and Natural Philosophy. In 1740, he observed the transit of Mercury; and, in 1761,

went to Newfoundland to observe the transit of Venus. He published tracts on Earthquakes, Comets, and other astronomical subjects. Died at Cambridge, May 3, 1779.—ROBERT CHARLES, LL.D., American statesman and orator, descendant of the sixth generation from the first Governor W., was born at Boston, May 12, 1809, graduated at Harvard College in 1828, studied law with Daniel Webster, and was admitted to the bar in 1831, but soon abandoned law for politics, and was elected to the state legislature in 1834, where he served five years, three as Speaker of the House. In 1840, he was elected to Congress, of which he was a member for ten years. In 1847, he visited Europe, and was the Whig candidate for Speaker, but defeated after a balloting of three weeks. In 1850, he succeeded Mr Webster, who became Secretary of State, as senator from Massachusetts, a place in which he was succeeded by the more radical Charles Sumner. He was also defeated as a candidate for governor of Massachusetts. He published *Life of J. Winthrop*, *Memoir of N. Appleton* (1861), *Speeches* (1853—1867), and *Washington, Bowdoin, and Franklin* (1876).

WIRE AND WIRE-DRAWING. The facility with which any metal can be drawn into wire depends upon its ductility. Most metals have this property; but some, like bismuth and antimony, are so brittle that they can only be drawn out with difficulty, and wire made from such metals is useless, from want of tenacity. See DUCTILITY.

Metals largely used for making wire, such as iron, brass, and copper, are drawn by essentially the same process. We may take iron as an example. It is prepared by cutting up flat rolled plates into square rods of a given thickness. This is done by means of a pair of slitting rollers; one of these has

grooves, equal to the breadth of the rods wanted, fitting into corresponding grooves in the other, which cut up the metal like scissors. The rods are cleaned of scales of oxide, either by mechanical rubbing, or by chemical treatment with dilute sulphuric acid. If the rod is thick, it has its square edge taken off by rollers. It is then drawn into wire by forcing it through the hole of a *draw-plate*. This is an oblong piece of hard steel pierced with conical holes, gradually diminishing in diameter, and having the smallest ends of these tapering holes carefully prepared to the required size. Sometimes cubical-shaped dies, each with a single trumpet-shaped hole, are used. A wire-drawer's bench is shown in the annexed figure, in which A is the drawing-plate, and B the drawing-block or cylinder. The motion is given by means of bevelled wheels connected with a shaft driven by steam or water power.

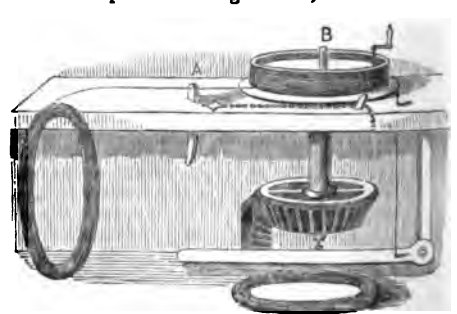

Wire-drawer's Bench.

The workman commences by making a point on the rod, so as to allow it to pass through the hole, and be grasped by a pair of pincers attached to a chain, which draws it out till the length is sufficient

to pass round the cylinder. This much is done by hand, and then the cylinder, being put in gear, is made to revolve and pull the wire through the draw-plate—coiling it round itself as the drawing proceeds. After being once drawn, it is again passed through a smaller hole, and so the process is repeated till it has been reduced to the size required. Fine wire may require from 20 to 30 drawings. The cylinder revolves slowly with a thick wire, and the speed is increased as the size diminishes. After being passed a few times through the draw-plate the metal becomes brittle, and requires to be annealed. Sometimes, a lubricating substance—as wax, grease, or soap—is employed during the drawing, especially for fine wires.

For some very accurate purposes, such as chronometer springs, and for gold and silver lace, the wire is drawn through jewelled holes, that is, holes perforated in rubies and other hard gems. A silver wire 170 miles long, and about  $\frac{1}{1000}$ th of an inch in diameter, has been drawn through a hole in a ruby, and found, by a micrometer, to be of exactly the same size at the end as at the beginning; whereas the drawing of a length of 16 miles of brass wire through a steel draw-plate necessitates a readjustment of the hole.

Platinum wire can be drawn as thin as  $\frac{1}{1000}$ th of an inch in diameter by first encasing it in silver, drawing down the compound wire, and then dissolving off the silver with nitric acid. By the same process, gold wire can be obtained only  $\frac{1}{1000}$ th of an inch in diameter. It has been shewn by Babbage, as an illustration of how greatly labour increases the value of a raw material, that one pound of iron, which costs twopence, will yield 50,000 wire pendulum springs for watches, each weighing about one-seventh of a grain, and selling at the retail price of twopence.

Wire, although mostly cylindrical in form, is drawn of many different sections, such as oval, half-round, flat, triangular, moulded, and the grooved pinion-wire from which the small toothed pinions for clocks and watches are cut. Copper wire of different forms is used to form patterns in the blocks used by calico-printers.

The following table (given by Dr Tomlinson) of weights, omitting fractions of a pound, which were sustained by wires  $\frac{1}{8}$ th of a line in diameter, shews the comparative tenacity of a few of the metals: Iron, 549 lbs.; copper, 302 lbs.; platinum, 274 lbs.; silver, 187 lbs.; gold, 151 lbs.; zinc, 110 lbs.; tin, 35 lbs.; lead, 28 lbs. It may be remarked here that some kinds of brass wire have been noticed to become extremely brittle in the course of time, especially if subjected to vibration, and even to break when used to support objects, without any assignable cause.

The quantity of wire used in the English manufacturing districts must be enormous, steel and iron wire being required for the manufacture of needles, fish-hooks, hooks and eyes, carding-machines, screw-nails, fencing, and basket-work; brass wire for the manufacture of pins, wire-cloth for paper-making and other machines, and chain-making; and copper wire for bell-hanging. Nothing, however, has increased the production of wire, both iron and copper, more than the electric telegraph. Belgium, which a few years ago exported none, now exports 1200 tons annually of iron wire.

WIRE-ROPES have come greatly into use of late years for winding purposes in mines and on inclines, for the rigging of ships, and for numerous engineering contrivances; also for the construction of electric-telegraph cables. They are almost always 'galvanised,' that is, coated with zinc. A hemp rope 6 inches in circumference, and weighing

9 lbs. per fathom; an iron-wire rope  $2\frac{1}{2}$  inches in circumference, and weighing 5 lbs. per fathom; and a steel-wire rope  $1\frac{1}{2}$  inch diameter, and weighing 3 lbs. per fathom, are all of equal strength—the breaking strain of each being 10 tons.

WIRE-WORM, a name given by farmers and gardeners to the larvæ of Click Beetles (q. v.), which are long and hard, and often swarm in corn-fields, gardens, and pastures, feeding on the roots of crops, and doing great mischief. The best known British species are *Elatæ* or *Agriotes lineatus*, *E.* or *A. obscurus*, and *E.* or *A. sputator*. The first of these, which is the largest, is in its perfect state about half an inch long, with brown head and thorax, clothed with cinereous down; the elytra tawny, striped with brown. The larva, when full grown,

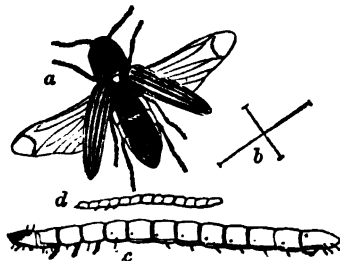

Wire-worm :

a, perfect insect, magnified; b, natural size of perfect insect; c, wire-worm magnified; d, natural size of wire-worm.

is fully half an inch long, very narrow, yellowish, hard, and shining, the jaws tipped with black. The second species named is in its perfect state of an earthy-brown colour. The third has a black head and thorax, with many dots, the elytra light brown with dotted lines. It is only about a quarter of an inch in length. Wire-worms are very small when first hatched, and are said to live for years in the larva state. Moles, rooks, and pheasants are useful in destroying them. Clover crops are said to have the effect of increasing their numbers. Farmers and gardeners resort to various means in order to get rid of this pest, as hard rolling after a top-dressing of lime, and mixing spirits of tar, gas-lime, or rape-cake with the soil; but one of the most effectual is the strewing of slices of potatoes or turnips on the ground, under which they soon congregate, and great numbers are thus easily destroyed. The name *W.* is often very vaguely used, so as to include not only the larvæ of some moths, but even myriapods of the genus *Julus* (q. v.), which somewhat resemble the true wire-worms in form, although in reality very different, and probably not injurious to crops, as they are.

WISBECH, or WISBEACH, a market-town in Cambridgeshire, in the Isle of Ely, occupies a position of importance in the Fen District, on the Nen, 18 miles east-north-east of Peterborough. *W.* is connected by a branch of the Great Eastern Railway with Peterborough; and two railways are at present in course of construction, which, when completed, will connect it with the Great Northern branch to King's Lynn, and directly with the Great Northern main line. By the Nen, which falls into the Wash, at the distance of 12 miles below *W.*, communication is maintained between this town and the North Sea. The navigation of the river has been much improved within recent years, and *W.* is considered the port of Cambridgeshire. It is generally well built, contains a number of useful institutions, and carries on rope-spinning,



brewing, and general trade. Corn, timber, wool, salt, and seeds are exported; wine, deals, oil-cake, corn, slates, and coal imported. In 1876, 431 vessels, of 70,029 tons, entered, and 324, of 48,456 tons, cleared the port. Pop. (1871) 9362.

WISBY, a once famous seaport of the Swedish island of Gothland (q. v.), capital of the island, and situated on its west coast, about 130 miles south of Stockholm. It is of the highest historical and antiquarian interest; and though the time of its foundation is unknown, it was, during the 10th and 11th centuries (200 years before the establishment of the Hanseatic League in 1241), one of the most important commercial cities in Europe. It was a principal factory of the Hanseatic League during the 14th and 15th centuries. The eastern trade, which during the 11th and 12th centuries passed through Russia, and thence down the Baltic to Gothland, centred in W., and greatly enriched that port. In 1361, Valdemar III. of Denmark took the town by storm, and, plundering it, obtained an immense booty. This was a fatal blow to the prosperity of the place. The architecture of W. is exceedingly interesting. Its ancient feudal walls and towers exist in almost as entire a state as they were in the 13th c., and render its appearance, as seen from the sea, exceedingly striking. The early grandeur of the town is attested by the fact, that it contains, well preserved, the remains of 18 churches, all of which date from the 11th and 12th centuries, are varied in form and ornament, and are a mine of interest to the student of Early Gothic. The oldest is the church of the Holy Ghost, built in 1046. St Mary's, built in 1190, is the only church now kept up for the use of the inhabitants. Pop. about 6300.

WISCHEHRAD (Old Slav. and Bohem. *wyschegrad*, Pol. *wyszogrod*) is the name of numerous towns and castles in all Slavonic countries; e. g., the original residence of the princes of Bohemia, now a quarter of the city of Prague. The word is composed of the root *wys* or *wysch*, high, and *hrad* (Rus. *gorod*, Pol. *grad*, in some dialects *grätz*), a fort, castle, town. *Hrad* is from the same root as Ang.-Sax. *hrecod*, Eng. *reed*, *rod*, another form being *yerde* or *yard*. It signified primarily a place defended by rods or poles, a palisaded fort, and hence a town. See Ton.

WISCONSIN, one of the United States of America, between lat. 42° 31'—47° N., and long. 87° 8'—92° 54' W.; 302 miles from north to south, and 258 from east to west; containing 53,924 sq. m., or 34,511,600 acres; is bounded N. by Lake Superior and the state of Michigan, E. by Lake Michigan, S. by Illinois, and W. by Iowa and Minnesota, from which it is separated by the Mississippi and St Croix rivers. It is divided into 60 counties. Its chief towns are Milwaukee, Fond du Lac, La Crosse, Oshkosh, Racine, Janesville, Watertown, Madison (the capital), &c. Its chief rivers are the Mississippi and its branches, Rock, Wisconsin, Black, Chippewa, and St Croix, which drain four-fifths of its surface; the Menomonee on the north-eastern border; Wolf and Fox, emptying into Green Bay; and numerous small rivers emptying into Lakes Michigan and Superior. Besides these great lakes and Lake Winnebago, the whole state is studded with small, clear, and beautiful lakes, well stocked with fish. The country is a high rolling prairie, from 600 to 1200 feet above the sea, with no considerable mountains, but numerous hills or mounds. In the rainy season, the rivers Fox and Wisconsin, emptying into the Mississippi and Lake Michigan, flow into each other. The geological formations extend only from the Primitive to the

Devonian. On Lake Superior are primitive rocks, granite, magnetic iron, quartz, slates, sandstone, drift, and beds of red clay and marl; sandstone cliffs on the Mississippi; the middle and southern parts of the state have the Lower Magnesian Limestone, a belt of white sandstone with beds of shells, then the lead-bearing group of Upper Magnesian Limestone. Besides the great magnetic iron bed on Lake Superior, and the rich lead region bordering on Illinois, copper is found in several places; zinc, some silver, plumbago, bitumen, peat, fine marble (some of light pink with red veins, and blue and dove colour), gypsum, and coal in small quantities. Of the curiosities are earthworks in the forms of men and animals; ancient fortifications; Devil's Lake, of 600 acres, on the summit of a mound 300 feet high; the precipitous shores of Lake Pepin rising to 500 feet, 200 feet being a perpendicular wall of magnesian limestone; the high bluffs of the Mississippi and Wisconsin rivers; the falls of the St Louis (320 feet in 16 miles) and of the Menomonee (134 feet in 1¼ mile). The climate is cold, the winters long and severe; but the state is considered one of the most healthy in the west. The soil in the north is broken, with drift and boulders, covered with heavy pine forests, and not well adapted to cultivation; the middle and southern region, of prairies and park-like oak openings, is exceedingly rich and productive, raising great quantities of wheat, Indian corn, oats, barley, potatoes, tobacco, &c. Besides the great pine-forests of the north, there are spruce, cedar, various oaks, hickory, birch, elm, sycamore, sugar-maple, &c. Of animals there remain the elk, deer, bear, foxes, wolves, beaver, gopher, &c.; and numerous birds and water-fowl, fattening upon the wild rice, on the margins of the numerous lakes. The chief manufactures are of iron, lumber, agricultural implements, flour, spirits, and malt liquors. The amount of wheat raised in 1873 was estimated at 26,322,000 bushels. The total valuation of property in 1875 was 421,283,359 dollars. In 1876, there were 2565 miles of railway, and extensive lake and river navigation. State and government appropriations of land have richly endowed a state university at Madison, normal, high, and common free schools, and the usual state asylums. The constitution and government closely resemble those of the older states. In 1870, there were 1466 churches, of which 396 were Methodist, 304 Roman Catholic, and 142 Baptist. W. was explored by the French missionaries in the latter part of the 17th c., and Indian trading-posts were also established; but the actual peopling of the state has been recent, and very rapid—a large proportion being of foreign birth—German, Norwegian, Irish, Welsh, &c. It was organised as a territory in 1836, and admitted into the union as a state in 1848. Pop. (1840) 30,945; (1850) 305,391; (1860) 775,873; (1870) 1,054,670; (1875) 1,236,729.

WISCONSIN, a river of Wisconsin, U.S., rises in the northern centre of the state, and flows south and west to join the Mississippi. Length, 270 miles. A canal, completed in 1850, connects with the Fox River; so that there is steam-boat communication between Lake Michigan and the Mississippi.

WISE, HENRY ALEXANDER, American statesman, was born at Drummondtown, Accomac county, Virginia, December 3, 1806; graduated at Washington College, Pennsylvania, in 1825; studied law at Winchester; settled and married at Nashville, Tennessee, but two years after returned to his native county, and engaged in politics; in 1825, advocated the nomination of General Jackson at the Baltimore Convention; opposed nullification, but maintained

the state-rights doctrines of Jefferson and Madison as expressed in the Virginia resolutions of 1798, that 'each state for itself is the judge of the infraction of the constitution, and of the mode and manner of redress.' Elected to Congress in 1833, he was involved in a duel with his opponent, whose arm he fractured. On the removal of the government deposits by General Jackson, he went over to the opposition or Whig party, but was sustained by his constituents, over whom he had an unbounded personal influence. In 1837, he was the second of Mr Graves, a member of Congress from Kentucky, who shot Mr Cilley, a member from Maine, in a duel. In 1840, he secured the nomination of John Tyler as Vice-president; and on Tyler becoming President by the death of General Harrison, had a powerful influence in his administration. Nominated minister to France, he was rejected by the Senate, but confirmed for Brazil, where he resided until 1847. He was now once more identified with the Democratic party; and in 1854, after an arduous electioneering campaign, in which, though in feeble health, he travelled 3000 miles, and made 50 stump speeches against the 'Know-nothing' or Protestant native American party, he was elected governor of Virginia. In 1859, he published a treatise on Territorial Government, maintaining the right of Congress over the institution of slavery. In December of this year, he signed the death-warrant of John Brown, hanged for treason in attempting to excite a negro insurrection. In 1861, as member of the Virginia Convention, he laboured for conciliation; but when his state voted for Secession, he entered heartily into the war, and was appointed Brigadier-general, serving in the Kanawha Valley, and later, defending Roanoke Island, where his son, Captain Wise, was killed.

WISEMAN, NICHOLAS, Cardinal and Roman Catholic Archbishop of Westminster, was born August 2, 1802, at Seville, of an Irish family settled in Spain. He was brought to Ireland in his childhood, and received his first education at Waterford, whence he was removed to the Roman Catholic college of St Cuthbert at Ushaw, near Durham. In his 16th year, he entered as an ecclesiastical student the English College at Rome, and after a very brilliant course, received holy orders at Rome in 1823, at which time he was also admitted to the degree of Doctor of Divinity, and was appointed Vice-rector of the English College, and Professor of Oriental Languages in the university of the Sapienza. In 1828, he published his *Horæ Syriacæ*, and in the end of that year was named Rector of the English College. It was while he held this office that he delivered his *Lectures on the Connection of Science and Revealed Religion* (2 vols. 8vo, 1836). But in England he first became known by a series of lectures on *The Doctrines of the Catholic Church*, delivered at Moorfields Church, and published in two vols. in 1836. In the same year he established, in concert with Mr O'Connell, the *Dublin Review*, a journal which has since continued to be the quarterly organ of the Roman Catholic body, and to which Dr W., even while residing abroad, was a regular contributor. In 1840, he was named Coadjutor Vicar-apostolic of the Central District of England, with the title of Bishop of Melipotamus *In Partibus Infidelium* (q. v.). At the same time he was appointed President of St Mary's College of Oscott, where he took up his residence. The circumstances of religious parties in England at this period contributed much to bring Dr W.'s very remarkable abilities as a polemical writer into prominence; and the dissensions which arose in the Church of England during the Tractarian Controversy, were turned to effect by him in various lectures, pamphlets, reviews,

essays, &c. In 1846, he was transferred as Coadjutor Vicar-apostolic to the London district; and in 1849 became himself acting vicar. In the following year, he came still more remarkably into notice, during the progress of a change in the position of the Roman Church in England, which, for a time, was the occasion of almost unexampled religious excitement in the country. From the reign of Elizabeth, the sees in England having been occupied by bishops of the Established Church, and it being penal for a bishop or priest of the Roman Catholic Church to officiate in England, the Catholics, for the necessary religious ministrations of their church, had resorted to the well-known expedient of a system of bishops *In Partibus Infidelium* (q. v.), with the title and authority of Vicars Apostolic (q. v.). This form of church government, with some modification, had in substance subsisted from the time of James I.; but from the date of the passing of the Catholic Emancipation Act, a desire had gradually sprung up among Catholics for the restoration of the normal form of church government by the appointment of regular bishops. This measure was finally determined on by the pope in the year 1850, and a new distribution of the kingdom was made into twelve sees (one of them archiepiscopal), in which, in order that it might not be supposed to clash with the existing episcopal system, the names of the ancient sees were carefully avoided, the titles of the new bishops being taken exclusively from cities and towns which were non-episcopal. Dr W. was named archbishop of the see of Westminster, which included great part of the district already under his charge, and was at the same time created cardinal. This measure, for which the Protestant public were but little prepared, and which was made more formidable in their eyes by the language which was employed, although but following the established canonical forms, and bearing altogether on the spiritual concerns of the Catholics, was supposed to involve an invasion of the rights and dignities of the Established Church and of the crown, and called forth a storm of religious excitement which was unexampled during the memory of the living generation. Whilst this excitement, which was much influenced by a letter addressed by the prime minister to the Bishop of Durham, was at its height, the new cardinal, who had gone to Rome to receive the cardinal's hat, returned to England, and published an explanatory address of great ability and moderation, but yet firmly asserting the strictly constitutional rights of his fellow-Catholics, entitled *An Appeal to the Reason and Good Feeling of the People of England on the Subject of the Catholic Hierarchy*. This address, as well as certain lectures subsequently delivered by him, and extensively circulated, did much to mitigate the excitement, which nevertheless led to violent debates in parliament, and to the passing of an act prohibiting the use of ecclesiastical titles other than those recognised by the law. See ECCLESIASTICAL TITLES ASSUMPTION ACT. Notwithstanding these unfavourable circumstances of his introduction into notice in England, however, the undoubted abilities and great literary eminence of Cardinal W. eventually compelled the admiration of the British public. He took frequent occasion, moreover, by public lectures and addresses on the neutral subjects of education, literature, and art, to identify himself with the spirit of progress, and with the national sentiments of his fellow-countrymen; and notwithstanding the infirmity of his constitution, which began to fail soon after his return to England as cardinal, he published during these years a succession of works which, although with the strong religious bias natural to a Roman Catholic churchman of earnest convictions,

possessed much, nevertheless, congenial to the sympathies of cultivated Englishmen of every degree. The *Lectures on Religion and Science* already referred to; *On the Connection between the Arts of Design and those of Production*; *on the Influence of Words on Thought and Civilisation*; *on the Points of Contact between Science and Art*; *Recollections of the Last Four Popes*, and other similar works, obtained an extensive circulation; and partly from their effect upon the public mind, partly, no doubt, from the reaction consequent on what was soon felt to have been a groundless and exaggerated alarm, Cardinal W. came by degrees to command the respect of the public at large. He died in his 63d year, on the 15th February 1865; and his funeral, which was conducted with great solemnity, and excited great public curiosity and interest, was witnessed with every demonstration of respect by one of the largest assemblies seen for many years in London. Besides admittedly high professional learning, he was a scholar of rare and singularly various attainments, an eminent linguist, a well-informed scientific scholar, a distinguished orator, a graceful and vigorous writer, and an accomplished critic and connoisseur of art. In addition to the works incidentally mentioned above, he published *The Real Presence of the Body and Blood of Our Lord Jesus Christ in the Eucharist* (8vo, 1836); *Reply to Dr Turton on the Eucharist* (8vo, 1839); *Lectures on the Ceremonies of Holy Week* (8vo, 1839); *Essays on Various Subjects* (3 vols. 8vo, 1853)—a selection of articles contributed to the *Dublin Review* and other periodicals, and of other fugitive essays; *Fabiola, or a Church of the Catacombs*; a singularly truthful and life-like picture of early Christian life in classic Rome; *Sermons* (2 vols. 8vo, 1864); with many shorter publications. He also left a large collection of MSS., many of them prepared for the press. In 1866 appeared *The Witch of Rosenberg, a Drama in Three Acts*; and *Daily Meditations* in 1868.

WISHART, GEORGE, one of the early Reformers of Scotland, is supposed to have been a native of Forfarshire, a son of James Wishart of Pittarrow, justice-clerk in the reign of James V. The exact date of his birth is unknown. He first emerges into notice in the beginning of the 16th century. At this time he taught a grammar-school at Montrose, and made himself remarkable by introducing the study of Greek. He began also to preach the doctrines of the Reformation, and was obliged to flee into England. Here he is found at Bristol about 1538, preaching the same doctrines, but being seized upon and threatened with death, he publicly recanted. Later he is found at Cambridge, in the centre of the Anglican Reform movement, which had begun there under the influence of Bilney and Latimer. He is described at this time by a pupil of the name of Tylney as a 'tall man polde-headed, of melancholy complexion, black-haired, long-bearded, comely of personage, well spoken after his country of Scotland, courteous, lowly, lovely, glad to teach, desirous to learn, abstinent in his habits, and very charitable to the poor.' His portrait, which has been preserved in the university of Glasgow, answers to the personal characteristics here mentioned. He returned to Scotland in 1543 or 1544, with the commissioners sent to negotiate a treaty with Henry VIII., and it was then that he entered upon his special reforming mission, terminating in his martyrdom. He appears to have possessed great powers as a preacher, although it is doubtful whether he ever took orders; and he travelled from town to town, and county to county, making everywhere a great impression by his stirring words. Knox has given in his *History*, Book i., a very striking descrip-

tion of the effects of W.'s preaching. Its effect upon himself was the most important and fruitful of all. When the preacher came to Lothian, Knox, charmed by his character and teaching, attached himself to his person, bearing a 'two-handed sword' before him. This precautionary defence was rendered necessary by two attempts supposed to have been instigated by Beaton against his life. His activity and influence were too prominent long to escape notice. Cardinal Beaton had had his eye upon him for some time, and while he rested at Ormiston, after preaching a powerful sermon at Haddington, he was made a prisoner by the Earl of Bothwell. Beaton himself was in the neighbourhood with a considerable force, in case it should have been attempted to rescue him. He was conveyed to St Andrews, and immediately put upon his trial before an ecclesiastical tribunal. Arran, the governor, refused to give his countenance to the proceedings; but the Reforming preacher was nevertheless condemned to be burned at the stake; and the sentence was carried out before the castle or episcopal residence at St Andrews on the 1st of March 1546.

W. is reported to have given utterance at the stake to a prophecy of the death of the cardinal, which took place about three months after his martyrdom. 'But he who from yonder high place beholdeth us with such pride shall, within a few days, be in the same as ignominiously as now he is seen proudly to rest himself,' are the words attributed to him. This has appeared to some recent writers to strengthen the suspicion, otherwise suggested, of W. having been accessory to the plot for assassinating the cardinal. The main ground of this suspicion is the discovery of a document in the State Paper Office, bearing that 'a Scotchman called Wyshart, a friend of the Laird of Brunstone, was concerned in this plot. Mr Tytler confidently adopted the view that this friend of the Laird of Brunstone and the Reformer were the same person, and it cannot be denied that there are reasons in favour of this inference, not in the mere coincidence of the name, perhaps, but in the fact of the association of the person bearing it with the Laird of Brunstone, who was a familiar friend of W.; and further, in the fact, that Kirkaldy of Grange and the Master of Rothes, who are mentioned in the document as conspiring either to 'apprehend or slay the cardinal,' were afterwards really his murderers. At the same time, it cannot be said that there is decisive evidence to prove that the 'Wyshart' of the state document was George W., the Reformer and the martyr. The coincidences might be accidental, and the question will probably remain among the *questiones vexate* of Scottish history.

WISHAW, a thriving town of Scotland, in Lanarkshire, 15 miles south-east of Glasgow, has made great advances within the last thirty years. The staple trade of the district is coal, of which upwards of 1,000,000 tons are sent from W. annually. There are also numerous iron-works, &c. Pop., with Cambusnethan (1871) 10,607.

WISMAR, the second seaport of Mecklenburg-Schwerin, at the head of a bay of the same name, an inlet of the Baltic. Its harbour is the best on the Baltic coasts, and is furnished with shipbuilding docks. Its old fortifications have been removed; but many of its old buildings, which are exceedingly curious and picturesque, remain. Commerce, the fisheries, tobacco and sail-cloth manufactures, and agriculture are the principal employments of the inhabitants; there are also breweries and distilleries. W. is the terminus of a branch of the Mecklenburg Railway, and communication by steamers subsists between it and Copenhagen. Pop. (1870) 13,883.

WISSEMBOURG (German *Weissenburg*), till 1871 a French fortified town, now capital of a district in the German province of Lower Alsace, is on the Lauter, 34 miles north-north-east of Strasburg. It has a flourishing trade, and a pop. of (1871) 5885. Here was fought, on the 4th August 1870, the first great battle of the Franco-German war. Besides the fortifications of W., demolished in 1872, the Lines of W. are famous—a line of works extending to Lauterburg, 9 miles south-east.

WISTA'RIA, a genus of plants of the natural order *Leguminosæ*, sub-order *Papilionaceæ*, having pinnate leaves and flowers in terminal racemes, the pod leathery. The species were formerly included in the genus *Glycine*. Some of them are amongst the most magnificent ornamental climbers known in British gardens. *W. frutescens*, a native of Virginia, Illinois, and other parts of North America of



*Wisteria Chinensis.*

similar climate, found chiefly in marshy grounds, attains the length of 30 feet, and has beautiful racemes of fragrant bluish purple flowers. *W. Chinensis* or *consequana*, a native of China, has larger flowers in pendulous racemes, and its branches run to the length even of 90 feet. In Britain, these plants are generally trained on walls.

WITCHCRAFT\* is merely the form that the belief in the arts of magic assumed under the action of certain notions introduced by Christianity. The powers supposed to be possessed by the witches,

and the rites and incantations by which they acquired those powers, were substantially the same as belonged to the devotees of the Greek Hecate (q. v.), the Striga and Venefica of the ancient Romans, and the Vala or Wise Woman of the Teutonic pagans. But when, along with the knowledge of the one true God, the idea of a purely wicked spirit, the enemy of God and man, was introduced, it was natural that all supernatural powers not proceeding directly from the true God, should be ascribed to him. This gave an entirely new aspect to such arts: they became associated with heresy; those who practised them must be in compact with the devil, and have renounced God and the true faith. Previously, if a witch was punished, it was because she had been guilty of poisoning, or at least was believed to have poisoned or wrought some other actual mischief. Now, however, such power was only the power to work evil; and merely to be a witch was in itself a sin and crime that filled the pious mind with horror. This feeling, zealously fostered, first by the Catholic clergy, and then no less by the Protestant, rose to a frenzy that for four centuries filled Europe with the most shocking bloodshed and cruelty.

Almost all the various notions and practices noticed under the heads MAGIC, DIVINATION, INCANTATION, AUGURIES, CHARM, TALISMAN, ORDEAL, FETTERING, EVIL EYE, &c., are embodied more or less prominently in the huge mass of superstitions which formed the creed of witchcraft in its full development. A reference, therefore, to those heads, and to the kindred subjects of ASTROLOGY and ALCHEMY, saves the necessity of entering into descriptive details of what witchcraft was. What was new and distinctive in the witchcraft of Christendom was the theory of magical arts which it involved. The doctrine of the Devil (q. v.), as finally elaborated in the middle ages, established in the world a rival dominion to that of the Almighty. The Arch-fiend and his legions of subordinate Demons (q. v.) exercised a sway, merely permitted, no doubt, but still vast and indefinite, not only over the elements of nature, but over the minds and bodies of men—all except those who had been admitted by baptism into the number of the 'redeemed' (see ATONEMENT), and continued to be guarded by the faith and rites of the church. The faithful could not be led into evil against their will, nor essentially injured in person; but not even they were altogether exempt from diabolic annoyance, for the immunity does not seem to have extended to

\*Not a little light is thrown on the original conception of witchcraft, and the magic arts in general, by observing the primary meaning of the various terms employed in connection with them. The most striking thing is the number of those terms that come from roots signifying simply to do, perform. From this notion, the transition is easy to a variety of shades of meaning, as is seen in Lat. *facinus*, which radically signifies a deed (from *facere*, to do), but became restricted to a bad deed, a crime. The Greek *εργον*, or *ergon* (= Eng. work), and the Lat. *facere*, *operari*, were used, without any addition, to signify to perform sacrifice or other sacred or magical rite. Accordingly, in Low Lat., *factura* signified sorcery; and in modern Ital. *fattura* = incantation, and *fattucchiera* = a sorceress or witch. Lat. *factum* becomes in Span. *hecho*, and means a crime; while *hechicero* is a sorcerer, and *hechiera*, a witch. The Portuguese *feticiao*, magic, is also from Lat. *factum*; and Sans. *kratu*, a sacrifice, is from *kri* (= Lat. *creare*), to make.

The Eng. *witch* is *vicca* in Ang.-Sax., which has also *vician*, to fascinate, and *vicancraft*, the art of magic; the Low Ger. dialects have similar forms (e.g., Dutch *wickkerij* = witchcraft); in High Ger. there are no cognate names. These words, as is seen in the Dutch form,

have clearly no connection with *witan* (Ger. *wissen*), to know, which is usually given as the root of the English witch; and the most probable etymology is that proposed by J. Grimm, who derives them from the Gothic *veihan* (O. H. Ger. *wihan*, modern Ger. *weihen*), which signified to consecrate, but which he infers to have meant primarily to do, make, perform (see *Deutsche Myth.*, pp. 36, 58, 408; *Deutsche Grammatik*, iii. 181). *Wihl*, or *wicht*, is evidently a derivative from this root, and signified a thing made (Lat. *factum*), a creature, a person, and, in some Teutonic dialects, a demon. A *vicca* was thus a doer of sacred or magic rites (compare the 'I'll do, I'll do, I'll do!' of Shakespeare's witches). *Wicked* is a participle from the same root, and signified primarily bewitched, accursed, hence perverse. *Wizard* is probably a masculine form of *vicca*.

Nearly corresponding to English witch were the Lat. terms *saga*, a knowing or wise woman; *strix*, *striga*, a kind of nocturnal bird, hence a witch; *venefica*, literally, a poison-maker, a concocter of drugs. The Ger. *hexe*, Old Dutch *hagetisse*, Ang.-Sax. *hæglesse*, or *hægesse* (from which Eng. *hag*), appear to come from *hag*, cognate with Lat. *saga*. In O. Norse, *hagr* signifies dexterous, cunning.

their belongings. As a strictly logical consequence of this assumed constitution of things, it followed, that those mortals who had the gifts of producing supernatural effects of any kind (and that such gifts had been possessed by individuals in all ages and countries, was not for a moment questioned), must derive their power from the Prince of Darkness and be acting as his agents—always excepting, of course, those miraculous powers which the church herself claimed to exercise in the name of Heaven. Moreover, as the universally coveted powers of fortunetelling, and of controlling the elements for your own benefit or the hurt of your enemies, could not be supposed to be bestowed by a being of the devil's character except as a *quid pro quo*, and as the object dearest to the devil's heart—the very aim and end, in fact, of his struggle with the kingdom of light—was to win back as many as possible of the souls that had been redeemed from his dominion by the death of Christ; it was natural to conclude that the price he would demand for his gifts would be a renunciation of Christianity and entrance into his service. Hence it came to be the established belief, that in order to acquire the powers of witchcraft, the person must formally sell his or her soul to the devil. The idea of a covenant with the Arch-enemy was not involved in the early and heathen conception of magic. Originally, magic was identical with the lowest form of religion, that is, Fetichism (q. v.). It was grounded on the idea that certain natural objects and certain rites and observances had, in themselves, a mysterious power of producing wonderful effects; and the art of the magician consisted in the knowledge of these mysterious powers, and in the skill to combine and direct them to special purposes. The effects were not conceived as being produced by the interference of any conscious being—god or devil. On the contrary, a human being could, through magical means, acquire control over supernatural beings. The Hindus carry this notion so far, that they represent some of their sages as practising austerities and performing sacrifices and other rites, until they can control the gods themselves, and even threaten their destruction along with that of the universe (see VISWAMITRA). The higher kind of European magic in the middle ages was mixed up with what physical science there then was; and the most noted men of the time were addicted to the pursuit, or were at least reputed to be so. So far from deriving their power from the kingdom of darkness, the scientific magician, by the mere force of his art, could compel the occasional services of the Arch-fiend himself, and make inferior demons the involuntary slaves of his will. A belief, however, had early existed that individuals in desperate circumstances had been tempted to purchase, at the price of their souls, the help of the devil to extricate them from their difficulties (see THEOPHILUS); and hence a suspicion began to grow that many magicians, instead of seeking to acquire their power by the laborious studies of the regular art, had acquired it in this illegitimate way. At last, as the system of dualism above mentioned became more perfect, the art of magic was wholly diabolised, and a compact with the Evil One was thought to be the sole charter of supernatural power. See FAUST. This transformation took place earlier and more completely (about the 13th c.) in regard to those lower forms of the magical art which constitute witchcraft proper, and which have from ancient times been considered the special province of women. The chief cause of the prominent part assigned to the female sex in this matter is noticed in the article MAGIC. In addition, it may be observed, that their more excitable temperament renders them peculiarly liable to those

Ecstasies (q. v.) which have been associated with the gift of divination from the priestesses of the ancient heathen oracle down to the medium of modern spiritualism. Further, when witchcraft came to be prosecuted as heresy, the part assigned to woman in the Scripture account of the Fall led to her being looked upon as specially suited to be the tool of the devil. Founded on this circumstance, a constant element of the creed of witchcraft came to be the belief in a carnal intercourse between witches and evil spirits. The devil was supposed to tempt them in the shape of a wooer, and the unholy compact was consummated in carnal fashion.

The bargain was usually in writing, signed with the witch's own blood. She was rebaptised, receiving a new name, and had to trample on the cross and renounce God and Christ (among Roman Catholics, also the Virgin Mary) in forms parodying the renunciation of the devil in the formula of Christian baptism. A mark was impressed on some part of her body; this mark remained for ever after insensible, and was one of the means of discovery employed by the witchfinders. The powers conferred by Satan on these covenanted servants of his, were essentially the same as had always been attributed to sorcerers; the mode of exercising them was also the same, namely, by charms, incantations, concoctions, &c. The only change was in the theory. These mystic rites, instead of producing their effects by an inherent virtue, were merely symbols by which the witch conveyed her behests to the devil and his ministers, who obeyed them according to the compact. Another difference to be noted is, that the power was exclusively directed to work evil—to raise storms, blast crops, render men and beasts barren, inflict racking pain on an enemy, or make him pine away in sickness (which was usually done by making an image of wax, and sticking it full of pins, or setting it to melt away before the fire). If a witch attempted to do good, the devil was enraged, and chastised her. A remarkable circumstance is, that witches seem to have been powerless to serve their own interests, for they remained poor and miserable.

A prominent point in witchcraft was the belief in stated meetings of witches and devils by night, called *Witches' Sabbaths*. First anointing her feet and shoulders with a salve made of the fat of murdered and unbaptised children, the witch mounted a broomstick, distaff, rake, or the like, and, making her exit by the chimney, rode through the air to the place of rendezvous. If her own particular demon-lover came to fetch her, he sat on the staff before, and she behind him; or he came in the shape of a goat, and carried her off on his back. At the place of assembly, the arch-devil, in the shape of a large goat, with a black human countenance, sat on a high chair, and the witches and demons paid homage by kneeling to him, and kissing his posteriors. The feast was lighted up with torches, all kindled at a light burning between the horns of the great goat. Among the viands there was no bread or salt; and they drank out of ox-hoofs and horses' skulls; but the meal neither satisfied the appetite nor nourished. After eating and drinking, they danced to music played on a bagpipe with a horse's head for the bag, and a cat's tail for a chanter. In dancing, they turned their backs towards one another. In the intervals, they narrated to one another what mischief they had done, and planned more. The revel concluded with obscene debauchery; after which, the great goat burned himself to ashes, which were divided among the witches, to raise storms with. They returned as they came; and the husband was kept from being aware of the wife's absence by a stick being laid in the bed,

which he mistook for her. The places of meeting were always such as had feelings of solemnity and awe attached to them, derived from tradition or otherwise; the more noted are known to have been places of sacrifice in heathen times (see *WAL-FURGA*).

The prosecutions for witchcraft form one of the most deplorable episodes in human history. They show more strikingly than anything else has ever done, on the one hand, what relentless cruelty human nature is capable of under the influence of a fanatical delusion; and on the other, how little reliance is to be placed on the concurrence of any number of witnesses when any extensive excitement prevails on a subject involving the sentiment of wonder. Multitudes will be found testifying, and testifying honestly, to alleged facts which fall in with the prevailing belief, but have no better foundation than their own heated imaginations.

In the early laws of Rome, the Twelve Tables, there were penal enactments against him who should bewitch the fruits of the earth, or conjure away his neighbour's corn into his own field. A century and a half later, 170 Roman ladies were convicted of poisoning under the pretence of charms and incantations; which led to additional laws against such practices. But in all this, the penalties were directed against those who had done, or were believed to have done, positive injury to another; and this is probably the meaning of the Mosaic law against witchcraft. At all events, in the heathen world, the mere possessing, or being believed to possess, supernatural powers was not in itself a crime. It was feared, no doubt, as being liable to be turned to malicious purposes; but on the whole, magic was looked upon as a beneficial art, being, in fact, the only form of the healing art known, and in part also the religion of domestic life. This view of the subject continued to prevail for many centuries after the reception of Christianity. Constantine, in the 4th c., while ordaining capital punishment for those who practised noxious charms against the life or health of others, is careful to protect from prosecution all magical means used for good—such as warding off hailstorms and excessive rains (*Codex Justin.* lib. ix. tit. 13); and the distinction between *black* and *white* magic was long kept up. It was through the prosecutions directed against heresy, which were systematically organised in the 11th c. (see *INQUISITION*), that the magic arts came gradually to be all dyed black alike. Along with errors in doctrine, the heretics were almost always accused of magical practices, and their secret meetings were represented as a kind of devil-worship, attended with all kinds of abominations. Thus sorcery and heresy became synonymous; and to the dread of supernatural power was added the feeling of pious horror. White magic, no less than black, was now looked upon as the work of Satan; and the counter-charms against the malice of him and his agents were to be sought only in the rites of the church as ministered by the accredited servants of Heaven. The belief in this ecclesiastical white magic was as zealously cultivated by the Protestant clergy as by the Roman Catholic.

Fostered chiefly by the proceedings against heresy, the popular dread of witchcraft had been on the increase for several centuries; and numerous executions had taken place in various parts of Europe. At last, Innocent VIII., by his celebrated bull, *Summis Desiderantes*, issued in 1484, gave the full sanction of the church to the prevalent notions regarding sorcery, and charged the inquisitors and others to discover and put to death all practisers of these diabolical arts. Two special inquisitors, appointed for Germany (to which country the bull

was specially directed), Heinrich Institor and Jacob Sprenger, with the aid of a clergyman of Constance, Johannes Grempfer, drew up the famous *Malleus Maleficarum*, or Hammer for Witches; in which the whole doctrine of witchcraft was systematised, a regular form of trial laid down, and a course of examination appointed by which inquisitors everywhere might best discover the guilty. From this we may date the beginning of the witch-mania proper. The edict of 1484 was subsequently enforced by a bull of Alexander VI. in 1494, of Leo X. in 1521, and of Adrian VI. in 1522—each adding strength to its predecessor, and the whole serving to increase the agitation of the public mind upon the subject. The results were dreadful. A panic fear of witchcraft took possession of society; every one was at the mercy of his neighbour. If any one felt an unaccountable illness, or a peculiar pain in any part of his body, or suffered any misfortune in his family or affairs; or if a storm arose, and committed any damage by sea or land; or if any cattle died suddenly, or, in short, if any event, circumstance, or thing occurred out of the ordinary routine of daily experience—the cause of it was witchcraft. To be accused, was to be doomed; for it rarely happened that proof was wanting, or that condemnation was not followed by execution. Armed with the *Malleus Maleficarum*, the judge had no difficulty in finding reasons for sending the most innocent to the stake. If the accused did not at once confess, they were ordered to be shaved and closely examined for the discovery of devil's marks, and if any strange mark was discovered, there remained no longer any doubt of the party's guilt. Failing this kind of evidence, torture was applied, and this seldom failed to extort the desired confession from the unhappy victim. A large proportion of the accused witches, in order to avoid these preliminary horrors, confessed the crime in any terms which were dictated to them, and were forthwith led to execution. Other witches seemed to confess voluntarily, being probably either insane persons, or feeble-minded beings, whose reason had been distorted by brooding over the popular witchcraft code.

In Germany, the prosecutions were carried to a frightful extent. In the small bishopric of Bamberg, 600 fell victims to the delusion in the course of about four years; and in Würzburg, which is not much larger, 900. In the small district of Lindheim, a twentieth part of the population were sacrificed in the same space of time. Similar accounts are on record regarding the other countries of Europe. In Geneva, in three months (1515—1516), 500 persons were burned. In the district of Como, 1000 were burned in one year (1524), and 100 per annum for several years afterwards. In France, about the year 1520, fires for the execution of witches blazed in every town; and throughout the century, the provincial parliaments were incessantly occupied with witch-trials and enactments against them, especially against that form of the superstition known as Lycanthropy (q. v.; see also *WERE-WOLF*).

In England and Scotland, the witch-mania was somewhat later in setting in than on the continent; but when it did so, it was little if at all less virulent—the Reformation notwithstanding. The statute of Elizabeth, in 1562, first made witchcraft in itself a crime of the first magnitude, whether directed to the injury of others or not; and the act of James VI., in the first year of his reign in England, defines the crime still more minutely: 'Any one that shall use, practise, or exercise any invocation of any evil or wicked spirit, or consult or covenant with, entertain or employ, feed or reward any evil or wicked spirit, to or for any purpose; or take up any dead

man, &c.; such offenders, duly and lawfully convicted and attainted, shall suffer death.' Many years had not elapsed after the passing of the statute, ere the delusion, which had heretofore committed but occasional local mischief, became an epidemical frenzy, devastating every corner of England. The poor creatures who usually fell victims are thus described by an able observer: 'An old woman with a wrinkled face, a furred brow, a hairy lip, a gobber tooth, a squint eye, a squeaking voice, or a scolding tongue, having a ragged coat on her back, a spindle in her hand, and a dog by her side—a wretched, infirm, and impotent creature, pelted and persecuted by all the neighbourhood because the farmer's cart had stuck in the gateway, or some idle boy had pretended to spit needles and pins for the sake of a holiday from school or work'—such were the poor unfortunates selected to undergo the last tests and tortures sanctioned by the laws, and which tests were of a nature so severe that no one would have dreamed of inflicting them on the vilest of murderers. They were administered by a class of wretches, who, with one Matthew Hopkins at their head, sprung up in England in the middle of the 17th c., and took the professional name of *witch-finders*. The practices of the monster Hopkins, who, with his assistants, moved from place to place in the regular and authorised pursuit of his trade, will give a full idea of the tests referred to, as well as of the horrible fruits of the witchcraft frenzy in general. From each town which he visited, Hopkins exacted the stated fee of 20s., and in consideration thereof, he cleared the locality of all suspected persons, bringing them to confession and the stake in the following manner: He stripped them naked, shaved them, and thrust pins into their bodies to discover the witch's mark; he wrapped them in sheets, with the great toes and thumbs tied together, and dragged them through ponds or rivers, when, if they sank, it was held as a sign that the baptismal element did not reject them, and they were cleared; but if they floated—as they usually would do for a time—they were then set down as guilty, and doomed. He kept them fasting and awake, and sometimes incessantly walking, for 24 or 48 hours, as an inducement to confession; and, in short, practised on the accused such abominable cruelties, that they were glad to escape from life by confession. If a witch could not shed tears at command, said the further items of this wretch's creed, or if she hesitated at a single word in repeating the Lord's Prayer, she was in league with the Evil One. After he had murdered hundreds, and pursued his trade for many years—from 1644 downwards—the tide of popular opinion finally turned against Hopkins, and he was subjected, by a party of indignant experimenters, to his own favourite test of swimming. It is said that he escaped with life, but from that time forth he was never heard of again.

The era of the Long Parliament was that, perhaps, which witnessed the greatest number of executions for witchcraft. *Three thousand persons* are said to have perished during the continuance of the sittings of that body, by legal executions, independently of summary deaths at the hands of the mob. Witch-executions, however, were continued with nearly equal frequency long afterwards. One noted case occurred in 1664, when the enlightened and just Sir Matthew Hale tried and condemned two women, Amy Dunny and Rose Callender, at Bury St Edmunds, for bewitching children. It is stated that the opinion of the learned Sir Thomas Browne, who was accidentally present, had great weight against the prisoners. He declared his belief that the children were truly bewitched, and

supported the possibility of such possessions by long and learned arguments, theological and metaphysical. Yet Sir Matthew Hale was one of the wisest and best men of his time, and Sir Thomas Browne had written an able work in exposition of Popular Fallacies! Chief-justices North and Holt were the first individuals occupying high places who had at once the good sense and the courage to set their faces against the continuance of this delusion, and to expose the general absurdity of such charges (1694). Summary executions, however, continued for some years to be still common, in consequence of confessions extracted after the Hopkins fashion. In 1716, a Mrs Hicks and her daughter, aged nine, were hanged at Huntingdon for selling their souls to the devil, and raising a storm by pulling off their stockings and making a lather of soap! With this crowning atrocity, the catalogue of murders in England closes.

In Scotland, witchcraft as a crime *per se* was first made legally punishable by an act passed in the reign of Mary (1563). On coming to execute the functions of majesty, James VI made numerous official investigations into alleged cases of witchcraft, and derived a pleasure in questioning old women respecting their dealings with Satan. In 1590, James, it is well known, made a voyage to Denmark to bring home his appointed bride, the Princess Anne. Soon after his arrival, a tremendous witch-conspiracy against the happy conclusion of his homeward voyage was discovered, in which the principal agents appeared to be persons considerably above the vulgar. The king had all the accused brought before himself for examination, and even superintended the tortures applied to them to induce confession. One of them, Mrs Agnes Sampson, declared that one great object with Satan and his agents was to destroy the king; that they had held a great witch-convention at North Berwick for no other end; and that they had endeavoured to effect their aim on many occasions, and particularly by raising a storm at sea when James came across from Denmark. The witches demanded of the devil why he bore such hatred to the king, who answered that the king was the greatest enemy he had in the world. On this occasion, 30 persons were executed on the Castle-hill of Edinburgh. These proceedings, no doubt, gave occasion to the famous work on Demonology which James VI published shortly after. The removal of James to England moderated but did not altogether stop the prosecutions. As the spirit of Puritanism gained strength, however, they again increased. The General Assembly was the body in fault on this occasion, and from this time forward, the clergy were the great witch-finders in Scotland. The Assembly passed condemnatory acts (1640, 1643, 1644, 1645, 1649), and with every successive act the cases and convictions increased with even a deeper degree of attendant horrors than at any previous time. At a single circuit held at Glasgow, Stirling, and Ayr in 1659, 17 persons were convicted and burned for this crime. The popular frenzy seems to have exhausted itself by its own virulence in 1661—1662. After this period, the dying embers of the delusion only burst out on occasions here and there into a momentary flame. The last regular execution for the crime is said to have taken place at Dornoch in 1722, when an old woman was condemned by David Ross, sheriff of Caithness. The number of victims in Scotland from first to last has been estimated at upwards of 4000.

In the British colonies of New England, the witchcraft mania raged with peculiar intensity. As in Scotland and elsewhere, the clergy were the prime movers. Two clergymen have obtained a

special and unenviable notoriety for the part they acted in this matter. The one was the Rev. Cotton Mather (q. v.), a man who was considered a prodigy of learning and piety, but whose writings and proceedings in regard to the trial and execution of witches, of which he was the chief instigator, shew a degree of fanaticism, credulity, and blind cruelty that is almost incredible. The other, a Samuel Parris, minister of Salem, made use of the popular feeling to gratify his own spite at individuals. At last, in the 'Salem tragedy,' as it is called, in 1692, the executions, torturings, and imprisonments rose to such a height as to be no longer endurable, a complete revulsion of public feeling took place, and the delusion was broken. For details of New England witch-trials, we must refer to No. 141 of *Chambers's Miscellany of Tracts*.

Dr Sprenger, in his *Life of Mohammed*, computes the entire number of persons who have been burned as witches during the Christian epoch at nine millions.

Throughout the middle ages, it is doubtful if one person could have been found who doubted the reality of witchcraft; and it was not till the middle of the 16th c. that any one had courage to raise his voice against the enormities which the delusion was occasioning. The first, probably, to do so was a physician of the name of J. Weier (*De Præstigiis Dæmonum*, &c.), in Germany, in 1563. He was followed in 1584 by Reginald Scot (q. v.), 'a solid and learned person, beyond almost all the English of that age' (Hallam), who demonstrated the absurdity and impossibility of the prevalent notions. The delusion, however, was still in the ascendant, and found multitudes of defenders, who branded the sceptics as 'Sadducees.' The most prominent of these champions was James VI. of Scotland, who, through his treatise on Demonology (1597), and his activity in the inquisition of cases, is entitled to rank with Pope Innocent and the inquisitor Sprenger, as at the same time a chief enemy and chief encourager of witchcraft. At last the world began to awaken from the horrid nightmare; the feelings of the humane began to be shocked by the continued butchery, and the more intelligent to question, if not the existence of witchcraft, at least the evidence on which the accused were for the most part condemned. Advocates took courage to defend a reputed witch, and judges, like North and Holt in England, to throw cold water on the proceedings; and the frenzy gradually subsided all over Europe. Individual cases occurred later on the continent than in Britain. A man was executed at Würzburg in 1749 on a charge of sorcery; and a witch was burned at Glarus, in Switzerland, in 1782. Perhaps the latest instance of a judicial execution for witchcraft occurred in 1793, in the grand duchy of Posen. The laws against witchcraft were formally repealed in England in 1736, in Austria not till 1766.

The cessation of judicial proceedings, however, did not all at once put an end to popular outrages on supposed witches. In 1751, an aged female pauper and her husband were killed by a mob near Tring, in Staffordshire; and for the murder, one of the perpetrators was tried and executed. Not longer ago than 1863, a reputed wizard was drowned in a pond at the village of Hedingham, in Essex; and it was considered worthy of notice that nearly all the sixty or seventy persons concerned in the outrage were of the small-tradesmen class, none of the agricultural labourers being mixed up in the affair. Besides such violent outbreaks, striking revelations are frequently made in the course of judicial proceedings, how deep-seated and general the dread of witches continues to be throughout the more ignorant strata of European society, especially in rural

places; and, concurrent with this, the faith in the skill of certain 'wise men' and 'wise women' (white witches) to counteract their malicious practices. As recently as March 1867, a man calling himself Dr Harris (S. Wales) was committed for trial at the next Radnorshire Assizes, for duping various persons, by persuading them that their ailments were caused by their being 'witched,' and pretending to cure them by giving them written charms to wear. From one man he had extorted £4, from another £6, and so on.

The belief in magic or sorcery, in fact, continues to be the most energetic belief of the ignorant and degraded all over the world, no matter what their nominal religion is. To the mass of the adherents of Buddhism in Central Asia, the lama or priest is merely a wizard who knows how to protect them from the malignity of evil spirits; and, according to Livingstone and other travellers, trials and executions for witchcraft are at this day common throughout Africa, as they were in Europe in the 17th c., and under forms ludicrously similar. See ORDEAL, MAGIC.

Of the numerous books written about witchcraft, we note the following: *Sadducismus Triumphatus*, *Sadducism Vanquished*, or, *Considerations about Witchcraft*, a work vindicating the belief in witchcraft, by Dr Joseph Glanvil, Chaplain-in-ordinary to Charles II., who was one of the first Fellows of the Royal Society, and wrote a meritorious treatise shewing the value of scepticism in science. R. Baxter (q. v.), in his *Certainty of the World of Spirits*, upholds the same side. Balthazar Bekker, a Reformed Dutch clergyman, was the first, at the end of the 17th c., to attack the very foundation of the superstition—namely, the belief in the devil himself, or, at all events, in the possibility of his interference in the affairs of this world. A successor of Glanvil, D. F. Hutchinson, chaplain to George I., in his *Historical Essay concerning Witchcraft* (1718), writes from the sceptical point of view. Sir W. Scott, *Letters on Demonology and Witchcraft*, entertaining but superficial. Brand's *Popular Antiquities of Great Britain*, edited by Sir H. Ellis (1855), gives a collection of witch-beliefs put together without much connection or method. H. Williams's *Superstitions of Witchcraft* (1865) takes a wide historical view of the subject, and evinces extensive reading: although loosely put together, and a good deal spoiled by the ambition of fine writing and the display now and then of narrow Protestant feeling, it is on the whole one of the best books on the subject in English. C. Mackay gives a good digest of it in brief space in a section of his work on *Extraordinary Popular Delusions* (1841). Thomas Wright, *Narratives of Sorcery and Magic*, 2 vols. (1852), contains a large collection of the most interesting stories of individual cases. Soldan, *Geschichte der Hexenprocesse* (History of Witch-trials), (Stut. 1843). Garnet, *Histoire de la Magie en France*. Ennemoer, *Geschichte der Magie*, 2d ed. (Leip. 1844); translated by W. Howitt (Lond. 1854). L. F. Alfred Maury, *La Magie et l' Astrologie dans l' Antiquité et au Moyen Age* (Lond. 1860), attempts to give a philosophy or theory of all superstitious beliefs. J. Grimm, *Deutsche Mythologie*, with his wonted sagacity and prodigality of learning, traces the several elements of the witch-creed to their roots in the beliefs of pagan times.

WITCH-HAZEL (*Hamamelis Virginica*), a North American shrub of the natural order *Hamamelidaceæ*. This order contains only a very small number of species, much diffused over the world, but none of them European; shrubs or small trees, with alternate, stipulate, feather-veined leaves, and small axillary unisexual flowers. The W. is



often not more than 6 or 8 feet in height, dividing at the base into several cylindrical grayish branches. Sometimes it attains a height of 20 or 30 feet. The leaves are about four inches long, and two or three broad. The flowers are clustered, yellow and showy, with long linear petals. They appear in winter, or at the season when other trees and shrubs are parting with their leaves. The English name is derived from the supposed virtues of a forked twig as a divining-rod. The bark is much esteemed as a sedative and discutient.

WITENA-GEMOT (A.-S. *witena*, genitive plu. of *wita*, a wise man, from *witan*, to know, and *gemót*, assembly, from *metan*, to meet), the great national council of England in Anglo-Saxon times, by which the king was guided in all his main acts of government. Each kingdom had its own Witena-gemót before the union of the Heptarchy in 827, after which there was a general one for the whole country. It was composed of the chief ecclesiastics, the ealdormen (see ANGLLO-SAXONS) of shires, and some of the chief proprietors of land. It would rather appear, though the matter is not quite free from doubt, that the lesser thanes, who formed part of the *scir-gemót*, or next inferior court, were not entitled to form part of the general council. In the year 934, there were present at one of these assemblies King Athelstane, four Welsh princes, two archbishops, seventeen bishops, four abbots, twelve dukes, and fifty-two thanes.

The powers of the Witena-gemót seem to have been very extensive. The king's title, however hereditarily unexceptionable, was not considered complete without its recognition, and it possessed the power of deposing him. It could make new laws and treaties; and along with the king it appointed prelates, regulated military and ecclesiastical affairs, and levied taxes. Without its consent, the king had no power to raise forces by sea or land. It was also the supreme court of justice, civil and criminal. The Witena-gemót was abolished by William the Conqueror, and its powers were only in part transmitted to parliament.—See Hallam's *Middle Ages*, c. 8; Sir F. Palgrave's *Rise and Progress of the English Commonwealth*; and Kemble's *Saxons in England*.

WITHER, GEORGE, was born on the 11th June 1588, at Bentforth, an estate in Hampshire of which his father was proprietor, and which in due course fell to the son. He was educated at the grammar-school of Colemore, and afterward at Magdalen College, Oxford, which he entered in 1604. He remained there several years, and after passing some time at home, he went to London, and entered himself at Lincoln's Inn. His bent was, however, rather to literature than law; and he shortly became known in certain circles as a writer of clever verses. In 1613, he came before the public in a volume of satire, the title of which, *Abuses Stript and Whipt*, in some sort defines its contents. Certain things in the book were considered offensive by the authorities, and he was sent to the Marshalsea prison, and kept there for some months. During his imprisonment were composed his *Satire to the Kings* and his *Shepherds' Hunting*. In 1622, appeared a collection of his poems under the title *Mistress of Philarete*, and in 1635, his *Emblems, Ancient and Modern*. Though he had very much identified himself with the party of the Puritans, among whom his writings were most popular, on the breaking out of civil disturbance, he served as a captain of cavalry in the ill-judged and abortive expedition of Charles I. against the Scotch Covenanters in 1639. When a little later, however, the general discontent deter-

mined itself into the grand struggle between the king and the English parliament, he promptly sided with the latter, and raised a troop of horse for its service by the sale of his estate. In the army of the parliament he attained the rank of major; but of his special services not much is known. On one occasion he was taken prisoner, and is said to have owed his life to a joke of Denham's, who besought the royalists to spare his life, on the ground that so long as W. lived, he (Denham) was not the worst poet in England. On the final triumph of the side with which he had ranged himself, it appears that opportunities were afforded him of feathering his nest rather comfortably by the spoil of the defeated party. With the Restoration naturally a reverse came; and as the reputed author of a pamphlet entitled *Vox Vulgi*, of a so-called seditious tendency, he was committed to the Tower, and an impeachment of him having been ordered, his life for a time seemed to be in some danger. The impeachment was not, however, proceeded with, and sooner or later—the date seems somewhat uncertain—he obtained his liberty. He died in London on 2d May 1667.

W. was an excessively voluminous writer. Upwards of 100 separate publications of his have been noted by modern bibliographers (see 1st and 2d vols. of Park's *British Bibliographer*), yet, after his death, his poetry fell into oblivion, or, so far as remembered, was regarded with such contempt that we find him introduced by Pope in the *Dunciad*, as 'wretched Withers.' A later time has, however, revised this decision; the grace, sweetness, fancy, and charm of natural simplicity which distinguish not little of his verse have since been sufficiently recognised; and a modest niche in the temple has been accorded him, from which he cannot now be degraded. The men to whom the resuscitation of his fame is chiefly owing are Southey, Lamb, and Sir Egerton Brydges. In his *Shepherds' Hunting*, in particular, passages occur of such rare and finished beauty, that no collection of the choicest things in English poetry could be held to be complete which should omit them. His *Hymns and Songs of the Church* were edited, with an introduction, by Mr Ed. Farr in 1856. By far the best and most complete account of W.'s life and writings is to be found in Wilmott's *Lives of the Sacred Poets* (Lond. 1834).

WITNESS, a person summoned, or capable of being summoned, by a court of law, or some officer authorised to take evidence relating to a judicial or other proceeding. All persons are liable to be witnesses, either voluntarily or involuntarily, and it is a duty which every citizen owes to his fellow-citizens, to be available whenever his testimony is deemed desirable. It is a compulsory duty, and the presence of any person can be enforced, both in civil and criminal cases. In England, the usual mode of summoning a witness in a court of law, is by serving him with a *subpena*, i. e., a formal writ proceeding in the Queen's name, reciting that a certain action is pending in a court named, and a trial is to take place, and commanding the witness to lay aside all and singular business and excuses, and appear at the time and place before the court mentioned, under a penalty (*sub poena*) of £100. This is called a *subpena ad testificandum*. The corresponding term in Scotch law is Diligence (q. v.). If the witness is required to produce a document in his possession, it is called a *subpena duces tecum*, and he is told in the writ to bring the document. If a witness do not attend at the time and place mentioned, he is liable to be punished, either by attachment, i. e., summary imprisonment for contempt, or by an action for damages at the suit of the party summoning

him. The subpoena, or notice to attend, must be served a reasonable time before the witness is wanted, and it is generally necessary to give a day's notice beforehand. During a witness's attendance on this public duty, he is privileged from arrest: thus, he cannot be taken into custody for debt while he is going to, remaining at, or returning from the court. Moreover, he is entitled, before he goes to the court, to have his reasonable travelling expenses paid to him, and a sum for subsistence while he remains in attendance. He is also entitled to a reasonable allowance for his lost time while attending a civil trial, and courts of law allow 5s. per day to a labourer or journeyman, 7s. 6d. to a master-tradesman, and £1, 1s. to £3, 3s. to professional men; to females, according to their station in life. A witness may, in a civil case, but not in a criminal case, refuse to give evidence until his expenses are paid. A witness, before examination, is required to take an oath, which may be in any form which he considers most binding on his conscience; but he must at least believe in a God and a future state of rewards and punishments. When a witness is examined, he is generally asked specific questions, first, by the party calling him, and during this examination in chief, the rule is that he is not to be asked leading questions, i.e., questions which suggest the answer that is required. The opposite party is then allowed to cross-examine the witness, and in doing so, may ask leading questions, or test in every way the truth of the witness's statement. After this, the witness is re-examined. There is a technical rule that the party calling a witness is not allowed to impeach his credit, or ask anything having that effect. There are certain questions which a witness may refuse to answer. Such are questions the answer to which might render the witness liable to a criminal charge or penalty; but he cannot refuse if the effect would merely be to render him liable to a civil action, or merely to degrade him. If a witness live in a foreign country, he cannot be compelled to come to this country by any subpoena, and therefore the only way of getting his evidence is to send a commission to some person in the foreign country to take the examination there. Where, however, a witness residing in Scotland is required for a trial in England, and *vice versa*, he may now be compelled by subpoena to attend in the same way as if he had resided in England or Scotland respectively. If the witness is aged or infirm, so that his attendance at the trial would be dangerous to him, he may be examined by a commissioner or examiner before trial. In England, when a witness is sworn, a New Testament is put in his hand, and after the officer of court repeats the form, he kisses the book. The form is: 'The evidence you shall give to the court and jury, touching the matter in question, shall be the truth, the whole truth, and nothing but the truth.' When the witness is a Jew or foreigner, the form varies. In Scotland, the witness, when sworn, stands, holding up his right hand, while the judge of the court repeats this form: 'I swear by Almighty God, as I shall answer to God at the great day of judgment, that I shall tell the truth, the whole truth, and nothing but the truth, in so far as I know or shall be asked.'

WITNEY, a small market and manufacturing town of Oxfordshire, in a dreary district on the Windrush, 10 miles west-north-west of Oxford. It is a neat and well-built town, consisting principally of two streets. There is a spacious cruciform church, a blanket-hall (built 1721), a town-hall, and cross (1683). It is celebrated for its blankets, which are distinguished for their peculiar whiteness, communicated, it is said, by the sulphureous qualities of the waters of the Windrush, used in their manu-

facture. This branch of industry has, however, somewhat declined, from the introduction of machinery for blanket-making in other towns. Gloves, malt, pilot-cloths, and felting for paper are also manufactured. The Saxon form of the name is *Witaneye*, and means, 'the island of the Wise Men,' or 'the island of the parliament.' W. is connected by a branch with the Great Western Railway. Pop. (1871) 2976.

WITTEKIND, a Westphalian chieftain, the most celebrated leader of the Saxons against Charles the Great, made his first appearance as leader in the expeditions which the Saxons undertook in 774 against the fortress of Eresberg, in Westphalia, and the Frankish province of Hesse, while Charles was subduing the Lombards. When most of the Saxon nobles submitted to the Emperor Charles at the imperial diet at Paderborn in 777, W. fled to Siegfried, king of Jutland, whose sister Geva he is said to have married. In 778, he returned, and when Charles was absent in Spain, began to lay waste the Rhine country. Charles's return obliged him again to take refuge in Jutland; but in 782 he fell upon the Frankish army by surprise at the Sintelberg, and entirely annihilated it—an act for which Charles took frightful vengeance by the execution of 4500 Saxons. On this, all the Saxon tribes rose in arms, and the war was again led by W. until 785, when Charles entered into negotiations with him, the result of which was, that W. repaired to the emperor's camp at Attigny in Champagne, and received baptism. After that, he appears no more in history. According to the legend, however, that is still current among the people in Westphalia, Charles promoted W. to be Duke of the Saxons, and made over Engers to him. From his castle called Babilonie, situated in the neighbourhood of Lübeck, he is said to have ruled with gentleness and justice till 807, when he met his death in a campaign against Duke Gerold of Swabia. His bones repose in the parish church of Engers, in the duchy of Ravensberg, where Charles IV., in 1377, erected a monument to him; and on October 18, 1812, another monument in his honour was erected at Minden by the Westphalian Society. The higher of the two hills which form the Westphalian gates on the Weser, near Minden, bears the name of Wittekindsberg.

WITTENBERG, a town of Prussian Saxony, a fortress of the third rank, stands on the right bank of the Elbe, 55 miles south-west of Berlin, and 59 by railway. It is interesting as having been the capital of the electorate of Upper Saxony, as the cradle of the Reformation, and as containing the remains of the reformers Luther and Melancthon. The once famous university, in which Luther was professor, and mentioned by Shakspeare as the school where Hamlet studied, is now removed and incorporated with that of Halle. In the *Stadt-Kirche* are two remarkable but poor pictures supposed to be by their contemporary and friend Cranach, in one of which Melancthon is represented as dispensing the sacrament of baptism, and Luther as preaching to a congregation, of which the two foremost figures are his wife and son. In the *Schloss-Kirche* are the tombs of Luther and Melancthon, as well as those of Frederick the Wise (with a noble bronze statue by Vischer) and John, electors of Saxony. Upon the doors of this church—burned down by the French, but replaced by others of metal—Luther hung up his 95 theses against the papal doctrine of indulgences. The house of the great Reformer, containing his chair, table, &c., and two portraits of him by Cranach, remains almost unaltered. The houses of Melancthon and Cranach are also shewn. In the market-place is a bronze

statue of Luther by Schadow, not far from which is also one of Melancthon; and outside the Elster Gate, a spot is pointed out as the place where Luther burned the papal bull. Manufactures of woollen and linen goods, hosiery, and leather are carried on. Brandy is distilled, and beer brewed. Pop. (1871) 11,567.

**WOAD** (*Isatis*), a genus of plants of the natural order *Crucifera*, having a 1-celled, 1-seeded, laterally compressed pouch, with the valves keeled and eventually separating. It contains only a few species, mostly natives of the countries around the Mediterranean.



Dyer's Woad  
(*Isatis tinctoria*).

*I. tinctoria* is sometimes found in cultivated fields in England, but most probably has been introduced, as it was formerly much cultivated both in England and Scotland, for the sake of a blue dye obtained from its root-leaves. The use of this dye has in great part ceased, in consequence of the more general introduction and diminished cost of indigo. Dyer's W. is a biennial plant, with oblong crenate root-leaves about a foot in length, on pretty long stalks; an upright, much branched leafy stem, about 3 feet high; small yellow flowers, and large seed-vessels, about half an inch long and 2 inches wide, hanging from slender stalks. The leaves when cut are reduced to a paste, which is kept in heaps for about fifteen days to ferment, and then formed into balls which are dried in the sun, and which have a rather agreeable smell, and are of a violet colour within. These balls are subjected to a further fermentation before being used by the dyer. When W. is now used, it is always in union with indigo, which improves the colour. Even by itself, however, it yields a good and very permanent blue. It is supposed that W. was the dye used by the Picts for painting their persons. W. is now cultivated only to a very small extent in Britain.

**WOBURN**, a township of Massachusetts, U. S., 10 miles north-north-west of Boston, on the Boston and Lowell Railway, containing numerous factories supplied with water-power, country residences of wealthy Bostonians, numerous churches, academy, &c. Pop. (1860) 6778; (1870) 8560; (1875) 9568.

**WODEN**. See **ODIN**.

**WODROW**, ROBERT, the second son of James Wodrow, professor of divinity in the university of Glasgow, was born at Glasgow in the year 1679. He was educated at the university of his native city, and after passing through the classes in arts, studied theology under his father. At an early age he devoted a considerable portion of his time to historical researches, and to this taste he probably owed his appointment as librarian to the university. He did not hold this office long. Having finished his theological studies, in the year 1703 he received a license to preach from the presbytery, and in the month of October of the same year was appointed minister of Eastwood, a parish in the county of Renfrew, at no great distance from Glasgow. In that parish he remained till his death, faithfully discharging the duties of his office, and declining

offers which were made to him of appointments to pastoral charges of more importance. He had been brought up in the strictest principles of presbyterianism, and he zealously adhered to the party in the Established Church, which was most strenuous in maintaining those principles, and in resisting what were deemed to be the encroachments of the secular power. Soon after his settlement at Eastwood, he began to devote his leisure hours to what became the chief object of his life—the writing of a history of the Church of Scotland from the Restoration to the Revolution. He spared no pains and no expense, so far as his limited means could afford, in collecting materials for this work. He corresponded with all persons who could give him any information, and transcribed with his own hand the civil and ecclesiastical records bearing on his subject. The work was published in two folio volumes, the first in 1721, and the second in the following year. It was dedicated to King George I., whom the author styles 'the best as well as greatest of kings;' and in the year 1725 he received an order on the Scottish exchequer for £105, as a mark of the royal bounty. It is probable that this sum was the chief pecuniary recompense of his labours; but considerations of that nature formed no part of the inducements which had led him to undertake the work. A second edition of the history, in 4 vols. 8vo, was published at Glasgow in 1823, under the editorship of Dr Robert Burns. W. contemplated other works, chiefly of a biographical character, illustrative of the ecclesiastical history of Scotland. None of these were published till the present century. Two vols. of his collections on *The Lives of the Scottish Reformers and most eminent Ministers*, and 4 vols. entitled *Analecta; or, a History of Remarkable Providences*, have been printed by the Maitland Club. Three volumes of his correspondence were published by the Wodrow Society—a literary club called after his name, and instituted in 1841 for the publication of the works of the fathers and early writers of the Reformed Church of Scotland. This correspondence, which extends from the year 1709 to the year 1731, throws much light on the ecclesiastical history of the time, and contains letters addressed to persons of some note in their day, not only in Scotland, but in England, Ireland, and North America. W.'s health was impaired by the eagerness with which he prosecuted his laborious studies. He died on the 21st of March 1734, in the 55th year of his age. His great work—the one by which his name is generally known—is the history. It is what it professes to be in the title-page, a 'History of the Sufferings' of the Presbyterian Church, rather than an ecclesiastical history of the period. This of itself implies a one-sided character, and warns its readers that they need not expect an account of events not coming within its limited range. Of its great value as a storehouse of materials to the student of Scottish history, no one who has examined its pages can have a doubt. As little hesitation will there be in regard to the absence of every grace of style. The only question will be as to the degree of credit to be given to the facts which the writer relates. So far as concerns his fidelity in transcribing records, and incorporating in the text the narratives furnished to him, there is no reason to doubt his general accuracy. But beyond this nothing can be said. His credulity was so great as to make him entirely unable to give any weight to intrinsic improbabilities or the conflict of external evidence. He could rarely admit a fault in those of his own side, and it is hardly an exaggeration to say that he could never see a virtue in his opponents. Much of his history is gathered from the records of the Privy Council of Scotland, and

an examination of these valuable and voluminous papers will make it pretty evident that W. disingenuously neglected to extract particulars which tell against his party. It is obvious, therefore, that in the perusal of his work, allowance must be made, not only for the absence of whatever does not come within its proper subject, but also for exaggerations of the virtues and sufferings of one party, and the crimes and errors of the other. The fullest memoir of W. is that which is prefixed by Dr Burns to his edition of the history. Interesting details of his domestic life and of his labours and studies will be found in the printed volumes of his correspondence.

WOJWODA (Polish, *Wojewoda*), an old Slavonic word (composed of *woi*, warrior, and *wodit*, to lead), means, literally, army-leader or general, and was from early times used by most Slavonic nations in this sense. Afterwards, it became the title of the elective princes before hereditary monarchies were formed. Thus, at one time, the princes of Walachia and Moldavia were called Wojwodas; from the Greek emperors, with whom they had been in intimate alliance from the year 1439, these princes next received the title of Despots, a title they afterwards exchanged for that of Hospodar. The name was also given to the elective princes of Transylvania, whether dependent or independent. The same title of Wojwoda was applied to the elective chiefs of the Polish government before the beginning of the Piast dynasty. Later, the name denoted office and dignity; and was given, in the former kingdom of Poland, to the governors in the districts, or Wojwodschafft, into which the kingdom was divided. They had at first only a military authority; afterwards, however, both the civil and military were united in one person, so that Wojwoda and Palatine were one and the same. The name of Wojwodschafft was preserved in Russian Poland till recent times; now the Polish Wojwodschafft are named uniformly with the other Russian 'governments.'

WOJWODSCHAF (or WOJWODINA) OF SERVIA. See BANAT.

WOKINGHAM, or OAKINGHAM, a small but improving market-town of Berks, 7 miles south-east of Reading, at the junction of the Reading and Staines and the Reading and Guildford Railways. Shoes are made, and gauze and silks woven. In the original *Rose* inn, Gay, Swift, Pope, and Arbuthnot, being detained here by wet weather, composed among them the old song of *Molly Mog*. All Saints Church, a magnificent building, lately restored, is remarkable for its massive chalk pillars. W. is the only town in Windsor Forest. The ancient amusement of bull-baiting was continued here until within the last 30 years. Pop. (1851) 2272; (1861) 2404; (1871) 2868.

WOLCHOV, or VOLKHOV. See ILMEN, LAKE, and LADOGA, LAKE.

WOLCOT, DR JOHN, better known under the pseudonym of *Peter Pindar*, was born at Dodbrooke, in Devonshire, in 1738. He was educated at the charge of his uncle, a respectable surgeon and apothecary of Fowey, in Cornwall. After studying medicine at the London hospitals, he accompanied Sir William Trelawny to Jamaica in the capacity of medical attendant; but finding his professional income too small for his wants, he solicited and obtained a church-living in the island. His congregation consisted mostly of negroes, and Sunday being their principal holiday and market, the attendance at church was very limited. Sometimes not a single person came; and W. and his clerk—the latter being an excellent shot—used at such times, after waiting for ten minutes, to proceed to

the seaside, to enjoy the sport of shooting ring-tailed pigeons. The death of his patron, Trelawny, induced him to abandon both Jamaica and the church. Returning to England, he tried to establish himself as a physician at Truro, in Cornwall, but does not appear to have succeeded. At any rate, he soon removed to London, where he gave himself up to writing audacious squibs and satires in verse, on all sorts of persons, from King George III. down to the Liverymen of London, and even lower. W.'s line in literature is not a very respectable one, and most people would probably prefer obscurity to a reputation like his; but, to do him justice, Peter Pindar is an excessively clever writer. Unscrupulous, impudent, and coarse, he is yet a master of burlesque humour and comic caricature: his verse is easy, vigorous, and idiomatic; and his fancy rich in the production of ludicrous metaphor. Two of his raciest pieces, levelled at his sovereign, are *The Apple-dumplings and a King*, and *Whitbread's Brewery Visited by their Majesties*. Besides these, we may mention his *Lyrical Odes* on the Royal Academy Exhibition (the earliest of his London efforts, and dating from 1782); *Bozzy and Piozzi, or the British Biographers*; *Peeps at St James's*; *Epistle to a Fallen Minister*; *Odes to Mr Paine*; and the *Lousiad, a Heroi-comic Poem*, in five cantos; &c. The *Lousiad* has its foundation in the fact, that an obnoxious insect had been discovered in the king's plate among some green peas, which produced a solemn decree that all the servants in the royal kitchen were to have their heads shaved. Some of W.'s serious effusions actually possess considerable merit. If the matter, or rather the themes of his verse, had been less worthless, it would have stood a better chance of permanent popularity. In his own lifetime, his pieces were greedily read, and he had an annuity from the booksellers of £250 for the copyright of them. He was considered so formidable a personage, that the ministry are said to have endeavoured to bribe him into silence. W., who records this proof of his power, also asserts the incorruptibility of his patriotism. He died 14th January 1819.

WOLF, FREDERICK AUG., the most gifted classical scholar and first critic of his age, was born 15th February 1759, at Haynrode, near Nordhausen. He was brought up and educated with great strictness by his father, the leader of the choir and organist of the place; but was afterwards sent to the gymnasium at Nordhausen. Here, under the training of the rector Hake, were developed in him not only that restless ardour for the thorough study of the ancient languages which actuated him throughout life, but also, what was afterwards the predominating trait of his character, the habit of inquiring and judging for himself, and of pursuing only one object at a time. Before leaving the gymnasium for the university, he had read the principal ancient authors, as well as the French, Italian, Spanish, and English; and had also perfected himself in the theory and practice of music. At the university of Göttingen, which he went to in 1777, with the intention of studying philology exclusively, he attended the lectures very irregularly, being already much given to private study. For the rest, he lived very retired, was little visited or known, and was only intimate with a few. However, he gave lessons to several students in Greek and also in English, for which he published Shakespeare's *Macbeth*, with explanatory notes (Gött. 1778). From Heyne (q. v.), who had once excluded him from hearing a course of lectures on Pindar, on account of the irregularity above noticed, he kept himself quite aloof. In order, however, to commend himself to a man who had so much influence as Heyne had, he laid before him,

shortly before his departure in 1779, a dissertation, containing some novel views regarding the Homeric poems; which, however, Heyne coldly returned. In the same year, he went as teacher to the Pädagogium at Ifeld, and there first established his fame by an edition of the *Symposium* of Plato, with notes and introduction in German. In 1782, he was appointed to the rectorship of the High School at Osterode, in the Harz; and, in 1783, accepted an invitation to Halle, as professor of philosophy and of pedagogical science. In Halle, W. had at first difficulties to encounter, as he rather estranged than attracted students by the high tone of his teaching. However, he soon learned to adapt himself to his audience, and then the crowd of eager pupils was very great. As academical teacher, he went on the principle that classical antiquity should be looked upon chiefly as serving for a model of what is noblest and greatest in public and private life, and as such, is to be employed as a medium of education. He made it the principal duty of his office to provide able teachers and superintendents for the schools of his native country, and to deliver education, as much as possible, from the scientific pedantry of the old school of pedagogues. Literary labours and fame he looked upon more as a subordinate object; and his effectiveness as a teacher was unparalleled during the twenty-three years he lived at Halle. He nevertheless established his reputation as a scholar and critic by an edition of Demosthenes's *Oratio adversus Leptinem* (1789), which attracted much attention, and still more by his celebrated *Prolegomena ad Homerum* (1795), in which he unfolded, with prodigious learning and acuteness, his bold theory, that the *Odyssey* and *Iliad* are composed of numerous ballads or rhapsodies by different minstrels, strung together in a kind of unity by subsequent editors (see *Homka*). This work made a great sensation through the whole of Europe. Some scholars gave out that they had long entertained similar notions regarding the Homeric poems; and Heyne insinuated that the *Prolegomena* were only a reproduction of what W. had heard at Göttingen. This gave rise to the spirited *Briefe an Heyne* (Letters to Heyne, Berl. 1797), of which the first three may be considered as models of scholarly polemic and fine irony. Some years afterwards W. published the text of the four orations of Cicero, whose genuineness had been called in question by Markland in England—namely, *Post reditum in Senatu*, *Ad Quirites post reditum*, *Pro domo sua ad pontifices*, *De haruspicum responsis*—appending the previous controversy, and adding striking observations of his own in proof of their spuriousness. He next went still further, and attacked the authenticity of the oration *Pro Marcello*, which had long been studied by the Ciceronians as a model of eloquence and style, pronouncing it to be mere inflated declamation, in a diction hardly Latin, and which Cicero never could have written. This audacious scepticism produced no little alarm. After having refused a call in 1796 to Leyden, in 1798 to Copenhagen, and in 1805 to Munich, his position was considerably improved, and he received the title of Privy-councillor. After the disasters of 1806, the university at Halle was dispersed, and W. was for a time reduced to great straits. However, he soon found a suitable position as member of the Academy of Sciences at Berlin, where he took an active part in the reorganisation of the university, and became a professor. He was taken into the Ministry of the Interior as member of the section for public instruction; but, finding that the duties interfered with his time and strength for teaching, which he considered his mission, he continued only a short time in public office. He next gave up the

work of an ordinary professor, and reserved at last only the privilege of lecturing in the university on such subjects as he chose. For the benefit of his health he took a journey to the south of France in April 1824, and died at Marseille, 8th August 1824. The multitudinous works of W. we cannot attempt to enumerate. They consist chiefly of critical editions of classical writings, with dissertations and annotations, and often with admirable translations either in German or Latin. While in Berlin he edited, along with Buttman, the *Museum der Alterthumswissenschaften* (1807—1810), and afterwards the *Literarische Analecten* (1817—1820), which has been pronounced perhaps the best philological journal that has ever been published, and which contains, among other papers by W., a long notice of Richard Bentley. From the papers which he left, his son-in-law, Körte, published *Ideen über Erziehung, Schule und Universität* (Ideas on Education, School and University; Quedlinb. 1835).—See Hanhart, *Erinnerungen an Fr. Aug. W.* (Bas. 1825); Körte, *Leben und Studien Fr. Aug. W.'s des Philologen* (2 vols., Essen. 1833); Gottholdt, *Fr. Aug. W. die Philologen und die Gymnasien* (Königsb. 1843).

WOLF, JOHANN CHRISTIAN VON, a celebrated philosopher and mathematician, was born in 1679, at Breslau. His father, a rather poor but well-informed artisan, made it his chief object to give a good education to his son, who at an early age shewed excellent abilities. W. received the elements of his education at the gymnasium of Breslau, and went to Jena in 1699 to study theology. However, mathematics and philosophy were his favourite sciences, and to them he almost exclusively devoted himself. In particular, he studied Descartes and Tschirnhausen's writings, to whose *Medicina mentis* he wrote annotations, which brought him into connection with Leibnitz. In 1703, he delivered at Leipzig a graduation disputation, *De Philosophia Practica Universalis, Methodo Mathematica Conscripita*, which made a very favourable impression, and then began to give lectures in mathematics and philosophy, which were very numerous attended. By various works which he published on special branches of mathematics, his name became celebrated even in foreign countries. When the incursion of Charles XII. into Saxony obliged him to leave Leipzig, he received, on the recommendation of Leibnitz, a call to Halle, as professor of mathematics and natural philosophy. He there acquired great celebrity by his systematical method of teaching, as well as by numerous mathematical writings. The clearness and definiteness of the ideas and propositions which he exhibited in his mathematical lectures, were something till then quite unknown. Hence it came that his system of metaphysical and moral philosophy, which he worked out according to this mathematical method, and published, met with universal approbation, and quickly spread through Germany: it became a kind of rage to treat all sorts of subjects in the mathematical method, the effect of which was often ludicrously pedantic. W., however, was violently attacked by his colleagues in Halle, especially by those theologians who favoured the pietism then coming into vogue: he was declared to be a despiser of religion, and a teacher of error; and a formal accusation was brought against him to the government. The immediate ground of the accusation was his oration *De Philosophia Sinenstium Morali*, in which he speaks with approval of the morality of Confucius, besides which the basest insinuations were brought against him, derived from his doctrine of freedom, which, it was said, encouraged social anarchy. By a cabinet order of Frederick-William I., of date 15th November 1723, W. was deposed from his office, and

## WOLF.

commanded, under pain of death, to quit Halle in 24 hours, and the Prussian dominions in two days. He did so on the 23d November, and met with a favourable reception in Cassel, and was appointed to a chair in the university of Marburg. The dispute about his philosophical system now became general, and nearly the whole of Germany took part either for or against him. At the same time he received from abroad many marks of honour and advantageous proposals, which last, however, he declined. In the meantime the Prussian government had begun to regret the steps it had been led to take against him, and had appointed a commission to re-examine the matter. This resulted in his entire justification; and when Frederick II., who had a great esteem for him and had studied his system, ascended the throne (1740), W. was induced to return to Halle as Professor of the Law of Nature and Nations, and with the titles of Privy-councillor and Vice-chancellor. In 1743, he became Chancellor in the place of Ludwig, and was raised to the rank of Baron of the Empire by the Elector of Bavaria during the regency. W. died in 1754. Before his death, he saw his philosophy spread over the whole of Germany and a great part of Europe; he had, however, outlived his reputation as an academical teacher. That he did great service to philosophy, cannot be denied. If he did not enrich it by great and brilliant discoveries, he at least directed attention to systematic method; and by treating scientific subjects in the mother tongue, he did much to create that wide-spread taste for philosophical speculation which has since been characteristic of Germany. W. adopted Leibnitz's hypotheses and principles, which he endeavoured to carry out into a complete system and popularise. But although the Wolfian philosophy was a great improvement on the scholastic Aristotelianism that had previously prevailed, its dogmatism could not stand the criticism of Kant, and it is now a theory of the past. By his voluminous writings, written partly in the German language, and the immense number of his pupils, W. had a wide and beneficial influence on his age, more especially as counteracting pietism and mysticism, then rampant. He also did good service to the German language. The multitude and extent of his writings is truly marvellous, even if we look at nothing else than the mechanical labour of writing them. He treated mathematics and philosophy in a double set of works; the one in full in Latin, the other shorter as German school-books, of the most of which several editions have been published. Besides these, are a great number of treatises on single subjects in physics, mathematics, and philosophy. His systematic works on all the chief branches of philosophy alone, amount to 22 vols. in quarto.—See *Christian W.'s eigene Lebensbeschreibung* (Christian W.'s Autobiography), published by Wuttke (Leip. 1841); Ludovici, *Sammlung und Auszüge der Sämmtlichen Streitschriften wegen der Wolf'schen Philosophie, u. s. w.* (Collection and Extracts of the Controversies about the Wolfian Philosophy, &c., 2 vols. Leip. 1737); by the same author, *Ausführlicher Entwurf einer vollständigen Historie der Wolf'schen Philosophie* (3 vols. Leip. 1737).

WOLF (corresponds to Lat. *vulpes*, a fox), the name of a wild animal of the same genus with the dog, and of which it is indeed doubtful if it constitutes a distinct species; whilst, as to the different kinds of wolves found in different parts of the world, it must be deemed at present wholly uncertain whether they are to be regarded as species or varieties, although they have, provisionally, received specific names. There exists among them the same close resemblance as in the different kinds of dog,

with a similarly marked distinction of characters, which, however, it is difficult to state as specific characters are generally stated. The same difficulty, therefore, occurs in the natural history of wolves as in that of dogs, although the number of different forms is not so great. In their most important characters, and those which, as least subject to variation, are generally regarded as best marking specific distinction, they agree not only with each other, but with dogs. The opinion, that the W. is the parent of the dog, or of some of the kinds of dog, is favoured by the identity of the period of gestation, a point which seems to be pretty well established, and which, in such a question, is to be regarded as of great importance. Dogs and wolves, also, intermix, but it is not yet fully ascertained that the offspring will continue fertile among themselves. It is further observed that wild races of dogs, whether originally wild, or having become wild (*feral* races), resemble wolves in many respects, in their dull uniformity of colour, in their lengthened muzzle, lengthened limbs, lank form, and gaunt aspect, and even in the bushiness of the tail. It has been alleged, as a reason against supposing the W. and the dog to be really of the same species, that the W. is incapable of domestication and of attachment to man. This, however, is not the case. Both the Common W. of the Old World and the wolves of America have been found capable of domestication, when taken young, and instances are on record of their having displayed an attachment to their master like dogs.

The COMMON W. (*Canis lupus*) inhabits Europe and the northern parts of Asia, its range extending from the Arctic regions as far south as the northern parts of Africa and of India. It is of a yellowish or tawny-gray colour, with strong coarse hair,



Common Wolf (*Canis lupus*).

which is longest on the ears, neck, shoulders, and haunches, but particularly on the throat; the muzzle is black, the upper lip and chin white. The ears are erect and pointed, the muzzle sharp; the legs rather longer than those of the Shepherd's Dog; the tail bushy, but not curling; the eyes oblique, giving a peculiar vicious expression to the countenance. The W. is swift of foot, and hunts deer and other animals, packs of wolves associating for this purpose; it also often commits great ravages among sheep, and attacks calves, but seldom full-grown oxen. It seldom attacks man, unless hard pressed by hunger, when it becomes very dangerous. The hungry wolves which sometimes descend, in severe winters, from the forests of the Alps, Pyrenees, and other mountains, are much dreaded by the inhabitants of neighbouring regions; and terrible stories are told of travellers chased by packs of wolves in the

forest-covered plains of the east of Europe and in Spain. In general, the W. is cowardly and stealthy, approaching sheepfolds and farm-buildings by night, in search of prey, and readily scared by any demonstration of watchfulness, fleeing from dogs, and not readily exposing itself within range of shot. It defends itself, however, with great vigour, when compelled to do so. It is not easily trapped, being extremely cautious, and appearing to understand the nature and purpose of a trap almost as well as those by whom it is set. Wolves have often been known even to approach a trap so skilfully as to devour the bait without harm to themselves, getting at it from below.

Diversities appear in the wolves of different countries of Europe and Asia, but not very considerable. The French wolves are generally browner, and rather smaller, than those of Germany; the wolves of Russia are larger, and have longer hair; the wolves of the Alps are brownish-gray, and not of large size; in Italy and Turkey a tawny colour predominates. In some very northern regions, wolves become white in winter; and white wolves, probably albinos, sometimes occur in more southern regions. The Black W. is the most marked European variety. It is found in the Pyrenees and in Spain, and is very large and strong. Strings of mules are often followed by these wolves in the passes of the Pyrenees, after evening comes on, and they not unfrequently succeed, notwithstanding all the care of the muleteers, in capturing some of the animals.

Wolves are still very plentiful in some parts of Europe. An official report of the Russian government concerning the district of Livonia, for the year 1822, states that the wolves in that district of about 20,000 square miles, destroyed in that year 1841 horses, 1807 oxen, 733 calves, 15,182 sheep, 728 lambs, 2545 goats, 183 kids, 4502 swine and pigs, and 703 dogs, besides geese and fowls. The W. was formerly common in Britain, and the Anglo-Saxon name for January, *Wolf-month*, is significant of this fact. Places of refuge from wolves were erected for travellers in wild and unpeopled districts, as at Flixton in Yorkshire. King Edgar commuted the punishment of criminals on their producing a certain number of wolves' tongues. Lands in Derbyshire were held on condition of killing wolves. It is not easy to say at what date wolves ceased to exist in England; it was probably about the end of the 15th c., but they continued to commit serious ravages on flocks, in Scotland, in the end of the 16th c., and the last W. in Scotland is said to have been killed by Sir Ewen Cameron of Lochiel, in 1680. They existed in Ireland at least as late as 1710.

The American wolves are very similar to those of the Old World. They have been described as forming several distinct species, but are by some included in one, doubtfully distinguished from the Common W., and to which the name *Canis occidentalis* is given. The fur is thicker, and the form more robust than in the Common W., the muzzle is less pointed, and the profile not so straight, the legs and ears are shorter, and the tail is more bushy. The GRAY W. (*Canis occidentalis*, var. *griseo-albus*, or *C. griseus*) is abundant in the northern parts of North America, except in the long-settled districts, from which it has been expelled by man. It is the only kind found in Canada. A few still remain in the mountainous and wooded parts of New England. Packs of wolves hang around the herds of buffaloes (bisons) on the western prairies, not daring to attack strong animals, but ready to seize any sickly straggler that falls behind the rest. They hunt and run down deer. The Gray W. equals the European species in cunning, and has been known to bite off

the cord close to the trigger of a set gun, and afterwards to devour in safety the bait placed before the muzzle. It has also been known to haul up fishing-lines set in a hole of the ice, and to help itself to the fish. It is frequently taken by means of pitfalls. On the prairies, the Indians kill great numbers of wolves by enclosing them in a circle gradually reduced, but originally extending over many miles. A premium of 10 to 20 dollars a head was formerly paid, in some parts of America, for the destruction of wolves, partly by the state, and partly by the county or town, because of their ravages among sheep. The range of the Gray W. extends to the coldest northern regions, as Melville Island and Banks's Land. In the north-western states, the Gray W. gives place to the DUSKY W. (*Canis nubilus* of many naturalists); and in the south is the BLACK W. (*C. ater* or *Lycæon*); whilst on the upper parts of the Missouri, the WHITE W. appears, and the RUFOUS W. in Texas. They differ little in characters and habits from the Gray Wolf.—The PRAIRIE W. (*C. latrans*, or *Lycæus latrans*), the COYOTE of the Mexicans, is a very different animal, more resembling the jackal. It is found from Mexico northwards to the Saskatchewan, abounding on the vast plains of the Missouri. It is 36 to 40 inches long, with a tail of 16 or 18 inches; the muzzle sharp and fox-like, the ears very large and erect, four toes on each foot, and on the fore-feet a sharp claw on the inside, two inches above the ground, attached to the rudimentary thumb; the colour is usually dull yellowish gray, with black cloudings, the under parts dirty white. It hunts in packs. It is an extremely fleet quadruped, excelling every other in the countries which it inhabits, except the Prong-horn. Its voice is a kind of snapping bark. The true wolves never bark, the only sound they emit being a prolonged and dismal howl.

South America has numerous species of *Canis*, some of which are known as Aguana wolves, and are nearly allied to the Prairie Wolf.

WOLF-DOG, a kind of dog used for hunting the wolf, formerly abundant in Norway and Sweden, but now almost exclusively found in Spain, into which it is supposed to have been introduced by the Goths. It is of the same group with the Shepherd's Dog; and is of a large size, little inferior to the mastiff, with pointed nose, erect ears, long silky hair, and a very bushy tail curled over the back. In colour it is mostly white, with large clouds of tawny colour or brown.

WOLFE, THE REV. CHARLES, the son of a county gentleman of Kildare, was born on 14th December 1791, at Dublin. The family having come to England on the death of his father, which took place whilst he was yet quite young, the boy received his chief education at Winchester, where he shewed himself an apt scholar. Being transferred, in 1809, to the university of Dublin, he succeeded in securing a scholarship, and in 1814 his degree of Bachelor of Arts. During this period, he was actively employed as a tutor: at this time it was also that he composed the greater part of the poetry which he left as his legacy to the world. In 1817, his celebrated lines on *The Burial of Sir John Moore*, suggested by reading Southey's impressive account of it in the *Edinburgh Annual Register*, were written; and soon after, they found their way into the newspapers. So generally admired were they, that even whilst the name of their author remained unknown, they had won for themselves a secure place in the memory of the British people. As a singularly felicitous and touching poetical record of a noble and pathetic incident in our

national history, they are perhaps not likely to be forgotten whilst that history is patriotically read and remembered. W., after qualifying himself to take orders, became, in 1817, curate of Ballyclog, in the county of Tyrone, from which he was shortly transferred to the larger parish of Donoughmore. His devotion to his duties was extreme, and was repaid by the warm affection of all with whom they brought him in contact. But they seem somewhat to have overtaxed the strength of a constitution at no time robust; symptoms of consumption appeared; and a visit which he made to Edinburgh in May 1821, developed it. He tried in search of health, successively, England, the south of France, and finally the sheltered Cove of Cork, in which last place he died on 21st February 1823.

His literary *Remains*, consisting of sermons chiefly and poems, were given to the world, with a Memoir, in 1825, by the Rev. John A. Russell, M.A., archdeacon of Clogher, an attached friend of the deceased. The work, though containing some poetry of real merit, never made any great impression, and is now quite forgotten. The one beautiful piece which preserves for us the name of W., was attributed by guess, whilst he lived, to more than one of the most famous writers of the day—as, notably, Campbell and Byron. Since his death, several nefarious attempts have been made to filch from him the fame he continues to derive from it.

WOLFE, JAMES, the most famous English general of his time, was born at Westerham, in Kent, on 2d January 1727. His father was a lieutenant-colonel, afterwards General Wolfe, an officer of merit and distinction, who served under Marlborough and Prince Eugene. Along with his brother Edward, who was about a year younger, James received his first education at a small school in that neighbourhood. From the first, the boy had resolved to follow his father's profession of arms; and when little more than 13 years old, he started to accompany the colonel as a volunteer in the unfortunate Carthagen expedition. An attack of illness, however, made it necessary to put him ashore at Portsmouth just before the fleet sailed. In 1742, he received his commission as ensign in the 12th, or Colonel Duroure's Regiment of Foot, with which he was soon after embarked for service in Flanders. In the year following, he took part in the famous battle of Dettingen; and it is evidence of the capacity he already began to display, that we find him, though still the merest boy, acting in the responsible capacity of adjutant of his regiment. After the battle of Fontenoy in 1745—at which W., who had now become a captain in the 4th, or Barrell's Regiment of Foot, was, notwithstanding a current tradition to that effect, certainly not present—the British troops were withdrawn from Flanders to assist in the suppression of the rebellion at home. With the army in Scotland he served in the capacity of brigade-major, and was present at the battles of Falkirk and Culloden. In 1747, he was again abroad on service. At the battle of Laufeldt, he was wounded, though not seriously; and his conduct was so distinguished, that he was publicly thanked by his commander-in-chief, the Duke of Cumberland. In the beginning of the year 1749, he was appointed major of the 20th Foot, then stationed at Stirling, whither he proceeded. In the absence of the colonel, the command of the regiment devolved upon him. In this responsible position, which was rendered much more trying by the disaffection still prevalent, young as he was, W. conducted himself with admirable tact and discretion. With little interruption, he remained in Scotland till the end of 1753, when the regiment returned to England. From the tone

of his correspondence, it is evident he was not greatly delighted with Scotland or its inhabitants. In the mismanaged expedition against Rochefort in 1757, W. was appointed to act as quarter-master-general of the force. The total failure of the operations brought disgrace to nearly all concerned; but it became sufficiently known that, had W.'s prompt and daring counsels been followed, the result would have almost certainly been different; and his reputation, already a brilliant one, rose considerably in consequence. In particular, it appears that the attention of Pitt was now first decisively drawn to him as an officer of whom, in any enterprise intrusted to him, great things might be expected. As marking approval of his conduct, the full rank of colonel was conferred on him. The high opinion thus formed of him, was signally confirmed the year following, when he was intrusted with the command of a brigade in the expedition against Cape Breton, under General Amherst. A great success was obtained in the capture of Louisbourg; that it was mainly due to W.'s skill, boldness, and activity was quite clearly understood, and he became popularly known as 'the Hero of Louisbourg.' Presently came the opportunity which was to consummate his glory, in the instant of heroic death. Pitt was now organising his grand scheme for the expulsion of the French from Canada; it was his just boast that he 'sought for merit wherever it was to be found;' and the expedition, which had for its object the capture of Quebec, the enemy's capital, he confided to the care of W., allowing him, as far as possible, a *carte blanche* for the choice of his subordinate officers. On 17th February 1759, W., advanced to the rank of major-general, and commanding an army of between 8000 and 9000 men, set sail from England. At Louisbourg, he had news of the death of his father, the state of whose health had for some time been such as to prepare him for the event. On the 28th June, W. landed his forces on the Isle of Orleans, opposite Quebec, and proceeded to concert his plans for the attack upon it. This, of which he had shortly before written as likely to be found 'a very nice operation,' proved, on a closer examination, to be one of stupendous, and, indeed, nearly hopeless difficulty. The system of defence adopted by his adversary, the skilful and wary Montcalm, was such as to offer him no point of advantage. In all his attempts, though seconded most ably by Admiral Saunders, who commanded the fleet, he found himself completely foiled. The season wore fast away during which operations could be continued; and an abortive result seemed imminent of the expedition from which so much had been hoped. But at last, at day-dawn of the 13th September, he found himself at the head of his little army, on the Heights of Abraham, above the city, where Montcalm, sorely against his will, was forced to risk decision of the struggle by battle in the open field. Resolving to stake all on a final effort, W. had, during the night, succeeded in scaling the cliffs at a point insufficiently guarded—an operation of such frightful risk and difficulty, as in war has scarcely a parallel. Of victory he had no doubt; his little force, now—exclusive of detachments necessarily left behind—reduced to something like 5000 men, was indeed opposed to near 8000 of the enemy, besides Indian auxiliaries; but of these it was well known that only a part could be depended on as trained and veteran troops. The result justified his confidence; after a short struggle, the enemy was driven from the field in complete rout; the capitulation of Quebec followed some days after; and its fall decided the fate of Canada. But W. did not live to reap the fruits of his victory; he died in its very



hour. In person he led the right; twice wounded, he refused to leave the front; a third bullet prostrated him; and he was carried, plainly dying, to the rear. He lived only long enough to know that the battle was decisively won; then rallying his last strength to give one final order, and saying: 'Now God be praised! I die in peace,' he expired. The gallant Montcalm also fell, paying, with almost his last breath, the tribute of a true soldier to the valour of the troops who had beaten him: 'Since,' said he, 'it is my misfortune to be discomfited and mortally wounded, it is a great consolation to me, to have been vanquished by so brave an enemy. If I could survive, I would engage to beat three times the number of such forces as mine were, with a third of British troops.'

The news of the victory was received in England with a tumult of exultation, dashed with grief for the loss of the hero to whom the nation owed it. When parliament met in November, the House of Commons addressed the king, praying that his Majesty would order a monument to be erected to the memory of the dead soldier in Westminster Abbey; where, accordingly, an *effigies* of him may be seen, with allegorical adjuncts as tasteless and absurd as usual. He was buried beside his father, in the family vault under the parish church at Greenwich.

A single military achievement, however brilliant, cannot be made ground of a claim for the successful soldier to take rank as a great captain. But that W. had the true genius for command, which needed only time and farther opportunity to win for him a fame still more splendid, it is scarcely permitted us to doubt. Through the lower regimental grades he rose rapidly by sheer force of personal merit, at a time when the service was a mere hotbed of corruption; and on attaining to higher commands, he in every instance gave evidence of the higher military qualities which proved him eminently worthy of them. He had only reached the age of 33, when in his last, and properly his one great achievement, he died, seemingly cut off in the mere opening of a brilliant career. He was of warm affections, and frank and generous nature; though his temper was somewhat eager, impulsive, and irascible, few men have ever been more generally beloved; and not many men so famous have left behind them a memory in every way so pure and spotless.

Till lately, no memoir of him in the least adequate existed; but in *The Life of Major-general James Wolfe—founded on Original Documents, and illustrated by his Correspondence*, by Robert Wright (Lond. Chapman and Hall, 1864), the want is now competently supplied.

WOLFENBÜTTEL, a very old town of Brunswick, stands in a low marshy district on both banks of the Oker, 7 miles south of Brunswick by railway. Its old fortifications have been converted into promenades. There are several churches, schools, charities, and a college. In a handsome building formed after the model of the Pantheon at Rome, is the famous library placed here in 1644, of which Lessing was sometime librarian. It consists of nearly 270,000 volumes, and upwards of 10,000 manuscripts, and contains some of the finest missals in Europe, an immense collection of Bibles, including Luther's Bible with autograph notes. In the same institution are preserved the great Reformer's marriage-ring, spoon, drinking-glass, and portrait by Cranach. The cultivation of vegetables is carried on to a great extent, and there are manufactures of lacquered and japanned wares, paper-hangings, leather, tobacco, and liqueurs; a trade in corn, cattle, and linen-yarn. W. has five annual fairs. Pop. (1871) 10,457.

WOLFENBÜTTEL FRAGMENTS. See LESSING; REIMARUS.

WOLFFIAN BODIES, important organs in the vertebrate embryo, in which they serve only a temporary purpose, except in the lowest class (the fishes), where they remain permanently. In the development of the chick, these bodies may be seen as early as the fourth day, lying along either side of the vertebral canal, from the region of the heart downwards and backwards, and consisting of a series of caecal or blind appendages, corresponding with the so-called kidneys of fishes, which in reality are true persistent Wolffian bodies. On the fifth day, the appendages become convoluted, and the body which they collectively form increases in mass. The appendages are then seen to possess a secreting property, and the fluid which they secrete is conveyed by the duct of each side into the *allantois*, a sac which, at the same time, acts as a temporary respiratory organ, and is also used as a urinary bladder. Hence these organs may be regarded in the light



State of the Urinary and Genital Apparatus in the early embryo of the Bird: a, Corpora Wolffiana; b, b, their excretory ducts; c, kidneys; d, ureter; e, e, testes.

of temporary kidneys. In the chick, the true kidneys begin to form from the Wolffian bodies at the fifth or sixth day, and gradually increase in size as the temporary organs diminish; and at the end of foetal life, only a shrunken rudiment of them can be observed. In man, the process is very similar, the Wolffian bodies beginning to appear towards the end of the first month; while in the seventh week, the true kidneys first present themselves. From the beginning of the third month, the Wolffian bodies begin to decrease, the kidneys increasing in a corresponding ratio, and at the time of birth, scarcely any traces of the former can be seen. It was formerly believed that the essential parts of the generative apparatus—the testes in the male and the ovaria in the female—were also developed from these bodies; but this is not the case, as they have an independent origin in a special mass of blastema peculiar to themselves, in the immediate vicinity of the Wolffian bodies.—See Carpenter's *Principles of Human Physiology*, 6th ed., p. 810.

WOLFFIAN BOTTLES, the name given to a set of apparatus employed for the distillation of Hydrochloric Acid (q. v.). It consists of a retort, a, in which chloride of sodium (common salt) is submitted to the action of sulphuric acid, gradually added through the funnel b, and the vapour evolved passes out into the first bottle (which, in the accompanying figure, is represented as half full of water), and is absorbed by the water. This process continues till the power of absorption of the water in the first bottle ceases (or, in other words, till the water becomes saturated), when the vapour collects in the neck of the retort and in the tube c, till it acquires sufficient tension to force its way through the water, and enter the second bottle by the tube d. In turn, the water in the second bottle becomes saturated, after which the gas is forced to find its way into the third bottle through the other two by means of the connecting tube f. After the force of reaction in the retort has become weakened,

the evolution of the gas is quickened by the application of a flame, which requires to be gradually increased. Considerable heat being generated during absorption, it is desirable that the bottles should be immersed in cold water. The tubes, *e, e*, admit

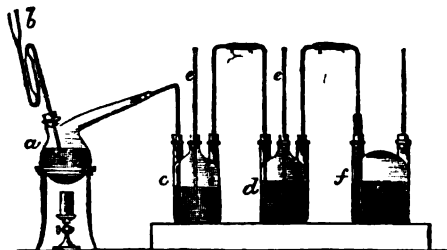

Wolfian Bottles.

atmospheric air to prevent the rarefaction in the retort tending to force the contents of the bottles back into it.

**WOLF-FISH** (*Anarrhichas*), a genus of fishes of the family *Blenniidae* (see **BLENNY**), having no ventral fins, the pectorals very large, a single dorsal fin extending from behind the head almost to the tail-fin, a long anal fin, the tail-fin rounded; the head round, smooth, and blunt; the teeth large and strong, not attached immediately to the jaws, but to bony processes connected with them by sutures.

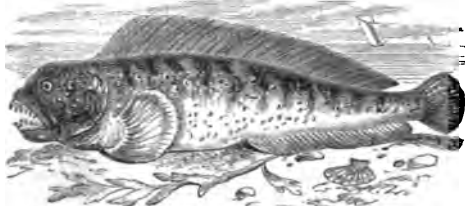
Wolf-fish (*Anarrhichas lupus*).

The jaws are powerful, the front teeth resemble the canine teeth of mammals, whilst the vomer and palate are furnished with teeth which have the form of rounded tubercles. One species, the **COMMON W.**, also called **CAT-FISH** and **SEA-CAT** (*A. lupus*), is found on the coasts of Britain, and is plentiful in more northern seas. It is frequent on the coasts of Scotland, particularly in the north, but is more rare on the English coasts. It is of a light gray colour, brownish on the back; the lower parts exhibiting ten or twelve dark transverse stripes. The skin is covered with much slime. It attains the length of six feet, and is a creature of formidable and even repulsive appearance: it bites savagely when caught, and fishermen therefore generally despatch it as soon as possible by knocking it on the head. It preys chiefly on molluscs and crustaceans, which its jaws easily crush. It is often very destructive to nets, being an active and powerful fish. Notwithstanding its ugliness, it is in esteem for the table, and it is often brought to the Edinburgh market. It is much used in Iceland, both fresh and salted; and a kind of shagreen, used for bags and pouches, is made of its thick skin. A very similar species, *A. vomerinus*, is found on the American coast from New York to Greenland, and is not only used fresh, but also split, salted, and smoked.

**WOLFRAM** is a native compound of tungstate of iron and manganese, from which the metal Tungsten (q. v.) is usually obtained.

**WOLF'S-BANE.** See **ACONITE**.

**WOLFGAST**, a commercial town and seaport of Prussia, in Pomerania, stands on the Peene, about 10 miles from its entrance into the Baltic, and 33 miles south-east of Stralsund. The shallowness of the water admits only the smaller class of sea-going vessels entering the harbour. There is a public dockyard and a school of navigation; and the inhabitants, who number (1871) 6202, are occupied in shipbuilding, seafaring, and in the manufacture of candles, soap, and tobacco. The larger ships discharge and take in cargoes at Ruden, a small island and pilot-station opposite the mouth of the Peene, known as the landing-place of Gustavus Adolphus in 1630. W. is a very old town; it was strongly fortified as early as the 12th c., and was once the residence of the Dukes of Pomerania-Wolgast; it was taken and retaken five times between 1628 and 1675; the Russians plundered and burned it in 1713, and the Swedes retook it in 1715.

**WOLLASTON, WILLIAM HYDE, M.D.**, a distinguished physicist, was the second son of the Rev. Francis Wollaston, of Chiselhurst, in Kent, and was born August 6, 1766. After the usual preliminary education, he was entered of Caius College, Cambridge, where he studied for the medical profession, and took the degree of M.D. in 1793, in which year, also, he was elected a Fellow of the Royal Society. After practising as a physician at Bury St Edmunds, he removed to London; but being beaten by Dr Pemberton in a competition for the post of physician to St George's Hospital, he determined thenceforth never to write a prescription, 'were it for his own father,' but to devote himself wholly to scientific investigation. This sudden resolution proved ultimately most beneficial, leading him rapidly to wealth and fame; for unlike many eminent investigators of nature's laws and phenomena, W. combined 'the genius of the philosopher with the skill of the artist,' and succeeded in making industrial application of several of his important discoveries. His researches were prosecuted over a wide field, but were pre-eminently fruitful in the sciences of chemistry and optics. To the facts of the former science he added the discovery of new compounds connected with the production of gouty and urinary concretions, such as phosphate of lime, ammonio-magnesian phosphate (a mixture of these two forming the 'fusible' calculus), oxalate of lime, and cystic oxide; the discovery in the ore of platinum of two new metals, palladium (1804) and rhodium (1805); and the determination (1809) of the identity of the supposed new metal tantalum with columbium. He also established the important doctrine of multiple combinations of chemical substances in a paper 'On Super-acid and Sub-acid Salts,' which was printed in the *Philosophical Transactions* for 1808; and by suggesting the construction of a synoptical scale of chemical equivalents, did much to establish in Britain the theory of definite proportions. By his ingenious discovery of a mode for making platinum malleable, he is said to have gained £30,000, and his mode of hardening steel, and some other discoveries of a practically useful nature, were also very lucrative. His contributions to optics were the celebrated 'Goniometer' (q. v.), a most valuable gift to mineralogists; an apparatus for ascertaining the refractive power of solid bodies; the 'Camera Lucida' (q. v.); the discovery of invisible rays outside the violet band of the spectrum; and an immensity of valuable and interesting observations on single and double refraction. To other sciences his contributions were also of importance, for he was the first to demonstrate the identity of

galvanism and common electricity, and explain the cause of the difference in the phenomena exhibited by each; he invented a 'cryophorus' for illustrating the theory of heat; constructed a most convenient kind of blowpipe; &c. W. was elected secretary of the Royal Society, November 30, 1806; and on November 30, 1828, he was awarded one of the Royal Medals for his discovery of the mode of making platinum malleable. He died of effusion of blood on the brain on December 22 of the same year. His most important Memoirs, 38 in number, will be found in the *Philosophical Transactions* (1800—1829).

WOLSEY, THOMAS, CARDINAL, was born in 1471 at Ipswich, in the county of Suffolk, and is reputed to have been the son of a butcher of that place. Though thus of humble origin, it is certain that by some means a good education was secured him, and, at an unusually early age, he was sent to Magdalen College, Oxford, of which he became a Fellow. It is said that while at Oxford, he was brought into somewhat intimate relations with the great Erasmus, unquestionably then in England. He afterwards acted as tutor to the sons of the Marquis of Dorset, through whose favour he became, in 1500, rector of Lymington, in Somersetshire. On one occasion, he appears to have got himself into difficulties. At a fair in the neighbourhood, it was his misfortune one day, it is said, to be found drunk and disorderly; and by a certain knight of the shire, by name Sir Amias Poulet, he was put in the stocks for the misdemeanour. That he figured in the stocks, is certain; that he did so on the score of drunkenness there is no adequate evidence. When the power to retaliate came to him, he took his revenge on Sir Amias by having him imprisoned for six years.

W., who was plainly one of the most insinuating of men, in Somersetshire became intimate with a Sir John Nafant, a man of considerable mark. Through the influence at court of this gentleman, he was appointed chaplain to Henry VII., with whom he speedily ingratiated himself. Being sent by the king on a special embassy to the continent, he acquitted himself so dexterously, that he rose still higher in favour; and in 1503, the deanery of Lincoln was conferred on him. The year after, Henry VIII. succeeded to the throne left vacant by the death of his father. Nearly from this time forward, the life of W., previously noted, indeed, as a rising man, yet of no special public importance, is in effect the history of the England of which he implicitly became the ruler. From Henry he enjoyed the most unbounded favour and confidence; and the influence which he thus exerted in the conduct of affairs was such as has seldom been exerted by a subject. The most valuable ecclesiastical preferments were showered upon him; and finally, in the same year (1515), he obtained the bishopric of Lincoln, and the archbishopric of York. The year following, the dignity of cardinal was conferred on him by the pope, who, not long after, appointed him also legate. Besides these ecclesiastical honours, he was made by the king, in 1515, his Prime Minister, and Lord High Chancellor of England. From this time, up to that of his forfeiture of the royal favour, W. was one of the most important men in Europe; and at home his power was almost without limit. The revenues derived from his various offices were of princely magnitude; and they were further enlarged by subsidies from foreign potentates, eager to conciliate his favour. He did not bear his honours meekly; in his way of life he affected a sumptuous magnificence, and a state only not royal, whilst in bearing he was arrogant and imperious. He openly aspired to be

pope; and there seemed more than once ground for supposing that this crowning object of his ambition was really within his reach. He was, however, disappointed; and it has been surmised that his resentment against Charles V., to whom he attributed his failure, determined, to a considerable extent, the foreign policy of the country.

Such a man could not fail to have many enemies, eager, as occasion might offer, to discredit him with his royal master; and an occasion at length came, of which they did not fail to take advantage. To the project on which the king had set his heart, of divorcing Queen Catharine, and marrying Anne Boleyn, W. shewed himself hostile; of the latter part of the scheme he was known to disapprove; and his negotiations with a view to securing the consent of the pope to the divorce were conducted, as it seemed to the king, in a dilatory and half-hearted manner. Henry, where his passions were interested, could little brook contumacy of this kind; his displeasure was carefully fanned, and the disgrace of W. was accomplished. In 1529, he was stripped of all his honours, and driven with ignominy from the court. Symptoms of relenting shewed themselves, however, next year in the mind of the monarch, and it seemed as if W. might again be taken into favour. The prospect, as it proved, was delusive. Being at the time in Yorkshire, the archbishopric having been restored to him, along with others of his minor preferments, he was arrested on a charge of high treason, and ordered to be conveyed to London for trial. On his journey, he was attacked with dysentery, and at the monastery of Leicester, in November 1530, he died.

The faults of W.'s character are obvious; but if his pride, ambition, and rapacity were inordinate, his luxury and ostentation somewhat unbecoming a successor of the primitive apostles, he was not without redeeming qualities. Haughty and insolent to his enemies, and those whose claims ran counter to his own, to his dependents and inferiors he was generous, affable, and humane; and not a few of them shewed their honourable sense of this by devotion to him in his misfortunes. Of learning, he was a most liberal and enlightened patron; and the endowment of Christ Church College, Oxford, survives as a monument to attest this. He was plainly a man of large and splendid capacity; and he seems, on the whole, to have been a diligent, faithful, conscientious, and salutary counsellor and servant of the monarch who so long and entirely trusted to him.

WOLUSPA—i. e., the prophecy of Wala—is the name of an old Norse poem, preserved in the older Edda, which principally contains the description of the creation and the destruction of the world. The Wala who delivers the utterances, whose name properly signifies *prophetess*, appears in it herself as a mythical being. According to Weinhold's explanation in Haupt's *Zeitschrift* (1847), the poem, as we have it now, was produced out of older popular songs by the hand of a later author at a time when Christianity had already penetrated into the north, somewhere in the first half of the 9th century. Besides being contained in the Edda, it has been separately published by Gräter (Leip. 1818), by Ettmüller (Leip. 1830), likewise by Bergmann in the *Poesmes Islandais* (Par. 1838), and by Dietrich in the old Norse *Lesebuch* (Leip. 1843).

WOLVERHAMPTON, a municipal and parliamentary borough of Staffordshire, a flourishing centre of the manufacture of iron, iron wares, and tin-plate goods, and the most populous and wealthy town of its county, 10 miles north-west of

## WOLVERINE—WOMB.

Birmingham, with which it is connected by railway. Besides Roman Catholic and other Nonconformist chapels, numbering in all 25, there are also within the municipal borough 10 churches, of which that of St Peter's is a stately edifice, with a lofty embattled and pinnacled tower. In the immediate suburbs there are (1867) 3 new churches and 4 Nonconformist chapels. Of these 13 churches and 29 chapels, 11 churches and two-thirds of the chapels have been erected since 1827. Its leading public schools are—a thriving grammar-school, founded 1714; an Orphan Asylum, instituted 1850, for orphans from all parts of the kingdom, with 100 scholars, and room for 200; and a School of Practical Art, opened 1854. Among its philanthropic institutions, a General Hospital and Dispensary, opened 1849, having 100 beds, and, like the Orphan Asylum, supported by voluntary contributions, is the chief. W. sent members to parliament first in 1832, and became a municipal borough in 1847. It has Quarter Sessions of its own, a spacious cattle-market, and a market-hall. A commodious and handsome town-hall has been erected; there is a system of deep sewerage; and its abundant water supply is in the hands of the corporation. There is a handsome bronze equestrian statue of Prince Albert standing in Queen Square. The town possesses an Exchange, where iron-masters and merchants assemble; and an Agricultural Hall, for the use of farmers and corn-dealers. W. stands upon the western edge of the extensive coal and iron-mining district of South Staffordshire, and is the metropolis of that district. On the south and east, the vicinity is covered with coal mines, iron-stone pits, blast-furnaces, forges, rolling-mills, and foundries; but on the north and west it is rural and picturesque. Its chief manufactures are tin-plate and japanned goods (14 manufactories), enamelled hollow wares, locks and keys, edge-tools, iron braziers and galvanised iron goods, gas and water tubes, cables and railway fastenings, iron-foundry goods, machinery, mills, cut nails, tips, cast hinges, electro-plate and papier-mâché goods, brass castings, and finished iron. Besides the establishments engaged in the hardware manufacture, there are several flour-mills and chemical and artificial manure works. The hardware goods manufactured at W. are remarkable for beauty of finish and genuineness of workmanship. The town enjoys unusual facilities for communication and transport. For a considerable time, it has commanded canal communication; and more recently, it has become the focus of a number of converging lines of railway, by means of which it is placed in direct relations with the important quarters of the country. Its market-day is Wednesday, under a charter by Henry III. (1258). The borough returns two members to the House of Commons. Pop. (1861) of parliamentary borough, 147,670; (1871) 156,978. Pop. (1861) of municipal borough, 60,360; (1871) 68,291.

W., a town of considerable antiquity, was originally called Hampton, and afterwards Wulfrune's Hampton (of which its present name is a corruption), from the circumstance that Wulfrune, the sister of King Edgar, founded here (996), the church and college of which St Peter's is the modern representative.

**WOLVERINE.** See GLUTTON.

**WOMB,** THE, professionally known as the *Uterus*, is a flattened, pear-shaped organ, whose position and various parts will be best understood by a

reference to fig. 1. It consists of a body (1), a base or fundus (2), a neck or cervix (3), and a mouth or *os uteri* (4). It lies in the line of the axis of the outlet of the Pelvis (q. v.), with base directed up-

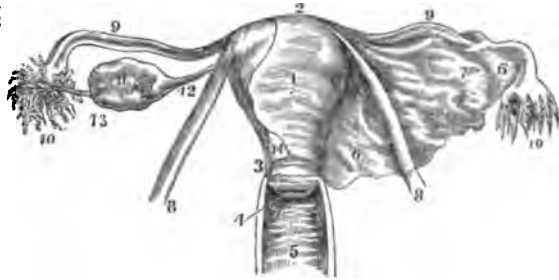

Fig. 1.—The Uterus and its appendages viewed on their anterior aspect:

- 1, the body of the uterus; 2, its fundus; 3, its cervix; 4, the os uteri; 5, the vagina laid open; 6, the broad ligaments of the uterus on left side; 7, a convexity of the broad ligament caused by the ovary; 8, 8, the round ligaments; 9, 9, the Fallopian tubes; 10, 10, their fimbriated extremities; 11, the right ovary; 12, the utero-ovarian ligament; 13, the Fallopio-ovarian ligament, on which some small fimbriae are continued for a short distance; 14, peritoneum of anterior surface of uterus. The membrane is removed on the right side to shew the parts embedded in its folds.—From Wilson's *Anatomist's Vade-Mecum*.

wards and forwards, and the neck directed slightly backwards. See fig. 2. In the unimpregnated condition, which we are now considering, it is about three inches in length, two in breadth, and one in thickness, and weighs about an ounce and a half. On laying it open, or exploring its interior by the introduction of an instrument through the *os uteri*,

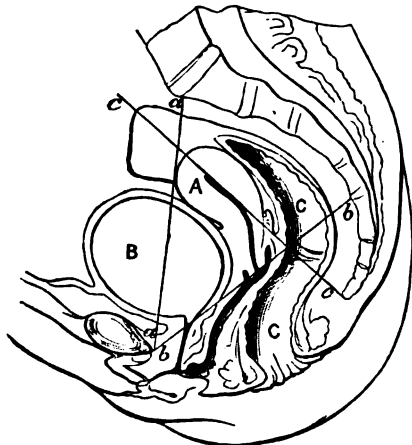

Fig. 2.—Section of Pelvic Viscera, with the parts in position:

- A, the uterus; B, the bladder; C, the rectum (the latter two being moderately distended); *aa* is a line from the lower border of the symphysis pubis to the promontory of the sacrum; *bb*, from the same spot to the lower margin of the fourth sacral vertebra; *cc*, the axis of the uterus. When prolonged, it runs three-quarters of an inch in front of promontory of sacrum, and hits the end of the coccyx.

its cavity is found to be very narrow, and to contain a little mucus. Its walls are nearly half an inch thick, and are mainly composed of muscle-cells and fibres running irregularly in all directions except round the *os*, where they make a partial sphincter. This muscular coat, which constitutes the bulk of the organ, is covered externally with a serous coat,

derived from the peritoneum, and is lined internally by a mucous coat continuous with that of the canal called the *vagina*, by which the interior of the womb communicates with the outer surface of the body. This mucous coat abounds in small mucous follicles, and is provided with ciliated Epithelium (q. v.). The neck or *cervix* of the womb is distinguished from the body by a well-marked constriction. The mouth, or *os*, projects slightly into the vagina (which is shewn as laid open anteriorly in the figure). This opening is nearly round in the virgin, and transverse after parturition. It is of considerable size, and is named the *orificium uteri externum*; it leads into a narrow canal which terminates at the upper end of the *cervix* in a smaller opening, the *orificium internum*, beyond which is the shallow triangular cavity of the womb, of which it forms the lower angle, while the two upper angles, which are funnel-shaped, constitute the beginning of the Fallopian Tubes (q. v.), whose apertures are so small as only to admit the passage of a fine bristle. The blood-vessels and nerves enlarge in a very remarkable way during pregnancy, so as to adapt themselves to the increased wants of the organ, which, at the ninth month of utero-gestation, weighs from two to four pounds. The term *appendages to the uterus* is given to the Fallopian Tubes and Ovaries (q. v.), which are enclosed by the lateral folds of the peritoneum called the broad ligaments. The womb is suspended in the pelvic cavity in such a way as, by its mobility, to escape rude shocks from without or disturbance from the varying conditions of the surrounding viscera, while at the same time to allow of its vastly increasing in bulk with comparatively little discomfort when pregnancy occurs. This is effected by several duplicatures of peritoneum, containing variable quantities of fibrous and muscular tissue, and known from their form or connection as the *broad*, the *round*, the *utero-sacral*, and the *utero-vesical* ligaments.

The uterus is an organ peculiar to the Mammalia, and in comparatively few of them (excepting the Apes and Cheiroptera) is it of the simple oval or triangular form which we have described. It is *two-horned* in the Ruminantia, Pachydermata, Solipedia, and Cetacea; and it is said to be *divided* where it has only a very short body, as in most of the Carnivora and Edentata, and some Rodentia, which speedily divides both externally and internally, and is continuous with the oviducts or Fallopian tubes. The uterus is actually *double* in some of the Edentata, and in most of the Rodentia, including the mouse and hare; in which each Fallopian tube passes into an intestiniform uterus, which has two completely distinct openings lying near to each other within the vagina. In the Marsupialia and Monotremata, the modifications of this organ are still more singular.

It is impossible to do more than name the chief offices or functions of the womb. They may be divided into those which relate to (1) Menstruation (q. v.), (2) Insemination, (3) Gestation, and (4) Parturition.—For a complete account of the anatomy, physiology, and pathology of the uterus and its appendages, we must refer to a masterly article by Dr Arthur Farre on that subject in the last volume of the *Cyclopaedia of Anatomy and Physiology*.

**WOMB, DISEASES AND DERANGEMENT OF THE.** In this article we shall not include the ailments of the pregnant or of the puerperal state, some of which, as *Phlegmasia Dolens* and *Puerperal Fever*, have been noticed in special articles. Many of the diseases, however, which we shall have occasion to notice may be traced to pregnancy, miscarriage, or severe delivery, that had occurred months previously. A

common result of inflammation that often succeeds miscarriage or a bad delivery is to check that process of involution by which the womb ought to be restored in a few weeks to the size and condition in which it existed previous to the occurrence of pregnancy. For a lucid description of the processes which act on the enlarged womb to restore it to its original state, we must refer to Dr West *On Diseases of Women*, 2d ed. p. 90. How inflammation acts in interrupting these processes, is not easily explained; but after it has passed away, its effects may remain in the enlarged size and altered structure of the womb, changes which render it likely to suffer from the alternation of activity and repose to which the female generative system is liable. In this condition, the enlarged and heavy uterus is very likely to become prolapsed, or to become a seat of permanent congestion or chronic inflammation; and excessive menstruation and a feeling of weight in the pelvis are almost always present. Besides this form of enlargement, there is a far less common form in which the enlargement of the womb takes place independently of previous pregnancy, and is the result of true hypertrophy. The symptoms are, according to West, 'a sense of weight in the pelvis, pain usually of a burning character, hæmorrhages having gradually come on, and forced themselves by their slowly increasing severity on the patient's notice.' The treatment is much the same in both these forms of enlargement—viz., the recumbent position on a hair or spring mattress, attention to the bowels, and local leeching every fortnight, to be continued for several months, together with the careful use of iron associated with small doses of iodide of potassium. Temporary separation from the husband's bed should also be insisted on. There is also a form of hypertrophy which is confined to the neck of the womb, which occasions great discomfort to the patient, and acts as a mechanical impediment to sexual union. In these cases, no relief can be afforded except by a surgical operation, which is described in West, *op. cit.*, p. 77.

From these results of 'simple errors of nutrition,' leading to increased growth of the organ, we pass on to the debatable and much-trodden ground of *inflammation of the womb*. *Acute inflammation* of the unimpregnated womb may arise from unaccustomed and excessive sexual intercourse, sudden suppression of the menstrual discharge, the extension of gonorrhoeal inflammation, &c.; but, as it is comparatively rare, and seldom dangerous to life, we shall at once pass on to an affection which by most practitioners is regarded as one of the commonest to which woman is liable—viz., *chronic inflammation and ulceration of the neck of the womb*. It is not forty years ago since a French physician, M. Recamier, invented an instrument—the speculum—for the application of local remedies to the neck of the womb in cancer; but the light which this instrument threw upon uterine conditions generally, led, amongst other results, to the conclusion, that leucorrhœal discharges (popularly known as *the whites*) were often derived from, and associated with, various morbid appearances of the mouth of the womb, and could often be removed by remedies directed to that part. Almost ever since the speculum began to get into general use, a large number of old-fashioned practitioners raised up a cry against its employment, on the grounds of its indelicacy, its intulity, &c., and denied the very existence of various morbid conditions, which the employers of the instrument declared they saw with its use. Hence two parties have arisen—one who believe in the speculum and its revelations; and another who reject the recent modes of investigating uterine diseases, who take small

account of the new facts regarding *local* disease which have been revealed, and who regard uterine ailments as resulting from constitutional derangements, and who therefore trust mainly to general treatment. Now, although the view that the local disease is everything, may not be universally true, the opposite view is certainly untenable; and Dr West and other writers on this subject have pointed out that there are reasons why the womb should more frequently than perhaps any other organ be the seat of certain forms of local ailment, and should consequently require the frequent employment of local treatment. It would be out of place in these pages to describe the characters of the ulcerations or abrasions of the mouth of the womb, which are so frequently revealed by the speculum, or to enter into any detail regarding the high pathological importance attached by some writers to them. The conclusion which Dr West draws from a prolonged investigation of this subject is, that 'the condition of so-called ulceration or abrasion of the os uteri is far from infrequent, even in cases where no uterine symptoms were complained of during life; but that it is usually unassociated with other important affections of the uterus, such as may be supposed to be the effects of inflammatory action; and, further, that such affections do not seem to be readily excited by causes acting on the neck of the womb, either when displaced, or when the organ is in its natural position.'—*Op. cit.* p. 120. Since uterine pain, disordered menstruation, and leucorrhœal discharges—the symptoms usually associated with ulceration of the mouth of the womb—are met with by impartial observers almost as frequently *without* as *with* ulceration, it may be fairly inferred that this ulceration is neither a general cause of uterine disease, nor a safe index of its progress; and although the local application of caustic to the os uteri is doubtless often successful in restoring the patient to health, it must not be considered as a general rule that the attempt, by local remedies, to remove this condition is the one and all-important point in the treatment of uterine disease. There is no doubt that, in the great majority of these cases (excepting a few of the more severe ones), temporary separation from the husband's bed, the recumbent position (which facilitates the return of blood from the womb and adjacent parts), due attention to the diet and state of the digestive organs, and the use of injections of nitrate of silver, which may be applied by the patient, are sufficient in a few weeks to effect a cure. Chronic uterine inflammation of a more general nature (as of the interior, or body of the womb), with very similar symptoms, is by no means rare. If the disease is met with in the acute form, leeches should be applied to the womb itself; in the chronic form, which is generally observed, the pain in the back is best relieved by a croton-oil liniment, composed, according to Dr West's directions, of one part of croton oil to ten of the camphor liniment (of the London Pharmacopœia), which should be applied (without rubbing it in) with a sponge twice a day on the back, at the seat of pain. Belladonna plaster or liniment also gives temporary relief. The irritability of the bladder, which is a common symptom, is usually associated with abundant phosphatic deposits in the urine, and is best relieved by a combination of ten or fifteen minims of dilute hydrochloric acid, half a drachm of tincture of henbane, and two ounces or more of decoction of Pareira-Brava (see *CISSAMPELOS*), three times a day; and the tepid hip-bath may be used with benefit. The same general rules as to rest, diet, &c. which have been already given, must be attended to. Under the best management, a tendency to

relapse is liable to occur at each monthly period, and after several such relapses, the womb is found (on surgical examination) to be enlarged and hardened, and less movable than natural. This condition is best removed by the careful and prolonged use of bichloride of mercury in small doses, which, as it is a deadly poison, must only be taken by professional advice; but the pain in the groin which usually accompanies this change, may be relieved or removed by the application of a small blister. The profuse discharge—both menstrual and leucorrhœal—is best relieved by chalybeate preparations, of which the following is a useful and favourite compound: Take of sulphate of iron, 6 grains; sulphate of magnesia (Epsom salts), 3 drachms; dilute sulphuric acid, half a drachm; syrup of orange peel, half an ounce; caraway water, sufficient to make a mixture of 6 ounces, of which 1 ounce may be taken thrice daily, after meals; or if there be much hæmorrhage, a mixture of alum and sulphate of iron (4 grains of the former to 1 of the latter, dissolved in a small tumbler of water) may be taken three times a day. A hip-bath, containing half a pound of alum to every gallon of water, is often very useful as an astringent. It should be taken in the morning before dressing, and the patient should remain in it at least a quarter of an hour. For the first time or two, the water may have the chill just taken off. The same importance is not at present attached to vaginal injections as when it was believed that the vagina (and not the womb) was the main source of leucorrhœal discharge. In a case of leucorrhœal discharge of long standing, an excellent astringent injection may be formed by dissolving two drachms of tannin and half an ounce of alum in a quart of water. Special forms of female or vaginal syringes are sold for this purpose. Of the application of caustics to the mouth of the womb, we say nothing, as that is a matter which must be left solely to the medical attendant.

From these remarks on the diseases of this important organ, we pass on to a very brief notice of its occasional *misplacements*. The singular mobility of the womb (without which pregnancy would be almost an impossibility) exposes it to the risk of displacement to such a degree as often to give rise to great personal discomfort. As all the causes which tend to produce displacement (such as increased weight of the organ during pregnancy, pressure of the superincumbent viscera, &c.) act in a downward direction, the obvious tendency of the womb is to be thrown downwards, or to suffer *Prolapsus* (q. v.), an affection which, in its extreme degree, when the organ is more or less protruded externally, is termed *Procidentia*. Causes sometimes come into play which incline the upper part of the uterus either backward or forward, giving rise to *retroversion* and *anteversion*, instead of mere prolapse. *Prolapsus* is sufficiently considered in the article bearing that title; and for a description of the symptoms and treatment of the two last-named misplacements, we must refer our readers to the standard works on the Diseases of Women.

The tendency of the womb to hypertrophy has been noticed at the beginning of this article; its individual tissues have a similar tendency to overgrowth, shewing itself at particular parts, and thus giving rise to tumours or outgrowths, which are more common in this than in any other organ. Under this head may be mentioned several varieties of *Polypus*, which differ essentially in structure, but all of which are invested by the mucous membrane which lines the uterus, and are liable to be the source of hæmorrhage. Their removal by surgical means is generally a matter of no difficulty. Much more important than these is the *Fibrous Tumour*,

which is frequent in its occurrence, serious in its effects, and very slightly amenable to treatment. These tumours are of a spherical form and firm texture, resembling that of the womb itself, and usually occur in groups; several being frequently present, while one or two are considerably larger than the others. The symptoms to which they give rise vary extremely according as the chief tumour lies on the outer part of the womb, and grows into the abdominal cavity, or is developed within the walls of the womb, or projects into the interior. They may be of almost any size, cases being on record in which they weighed from 70 to 80 lbs. In regard to the symptoms of this affection, it must be premised that sometimes these tumours exist without exciting any disturbance, and that growths on the outer surface give rise to comparatively unimportant derangements, compared with those which are imbedded in the walls, or occupy the cavity of the womb. It will be readily understood that women who have passed the change of life (as it is popularly called) suffer less from these tumours than younger women. The diagnosis of fibrous tumour is effected partly by manual and instrumental examination (into which we shall not enter), and partly by the symptoms—such as (1) hæmorrhage occurring in about 50 per cent. of cases independently of their nature; (2) disturbance of the menstrual discharge in 62 per cent. of cases, it most commonly being excessive, and often painful; (3) pain, usually constant, and occasionally only at the menstrual period, described by some patients as a burning sensation, by others as a sense of bearing down, and by a few as occurring in paroxysms of intense agony; (4) dysuria—pain in voiding urine, or difficulty in discharging it, or frequent desire to pass it. It is usually hæmorrhage, or inability to void the urine, that first directs the attention of the patient to her malady. Its tendency to excite abortion often leads the physician to suspect its presence. Although, as we previously mentioned, this is an affection little amenable to treatment, a woman with these symptoms should at once consult a physician (if possible, the physician-accoucheur to a large hospital), who, by his advice as to the general management of the case, especially during the menstrual period, may do much to palliate her sufferings. Iodine, bromine (and certain mineral waters containing these elements), and mercury have been vaunted as specifics, but nothing positive can be said regarding their successful action; and certain surgical operations have been recommended, which are accompanied with so much danger to the patient that it is needless to refer to them. But although the action of medicines on these growths is avowedly uncertain, nature in this as in many other cases not unfrequently strives towards a more or less complete cure. For example, if the tumour is pediculated, and lies in the uterine cavity, the pedicle may finally give way, and the tumour may be expelled; or certain changes may take place in the interior of a tumour, leading either to its disintegration and elimination, or to its conversion into a chalky mass, which, though not eliminated, induces no local disturbances. These spontaneous cures are by no means rare, although we can hardly lead the patient to expect them in any special case.

We shall conclude with a few words on a disease which is the most painful and hopeless of all the disorders to which humanity is liable—*cancer of the womb*. It is a disease whose leading features are thus graphically—we may almost say, painfully—described by Dr West: 'Pain, often exceeding in intensity all that can be imagined as most intolerable, attended by accidents which render the sufferer most loathsome to herself and to those whom

strong affection still gathers round her bed; the general health broken down by the action of the same poison as produces the local suffering, and all tending surely, swiftly, to a fatal issue, which skill cannot avert, from which it can scarcely take away its bitterest anguish.' The three most constant symptoms are pain, and hæmorrhage, and discharge. From an examination of 132 cases by the above-named physician, the first symptom was found to have been,

In 38 instances, or 43·9 per cent., hæmorrhage without pain.
" 26 " 19·6 " pain of various kinds.
" 18 " 13·6 " hæmorrhage with pain.
" 18 " 13·6 " leucorrhœa or other discharge without pain.
" 12 " 10·3 " pain and discharge sometimes offensive.

It is unnecessary to enter into further details regarding the symptoms of this disease, as cases of this nature must always be under medical superintendence, and for the same reason we need only say regarding the treatment, that it is divisible into the *palliative* and the *curative*, the former being directed towards the three great symptoms, and the general symptoms of the cancerous cachexia (or constitution), while in the latter are included the operation of extirpating the whole womb, or removing the neck of the womb by ligature or excision. It is difficult to speak with accuracy regarding the frequency of this disease. An approximate estimate may be formed from the fact that, in 1851, the mortality from cancer in England amounted to 1754 males and 4072 females; the excess in the latter case, amounting to 2318, must be due to cancer of the breast or womb; and according to Tanchou, a French pathologist, cancer of the womb is more frequent than that of the female breast in the rate of 26 to 10. Hence the yearly deaths from uterine cancer in England amount to about 1674. The last-named writer calculated, from ten years' observation of the French records of mortality, that this disease causes 16 per 1000 of all female deaths. The disease is very rare before the 25th year, and by far the most common period of its appearance is between the ages of 40 and 50 years. Its average duration is 16 or 17 months, but it may prove fatal in 3 or 4 months. On the subject of cancer of the womb, Walsh's *Cancer* may be consulted; and for further information on the subject of this article generally, the reader is referred to the standard works of Churchill, Lever, Simpson, West, &c.

WOMBAT (*Phascolumys*), a genus of marsupial quadrupeds, constituting a distinct family, *Phascologyde*, and of which only one species is known, *Phascolumys Wombat*, a native of Australia, abounding chiefly in mountainous districts of New South Wales, Victoria, South Australia, and Van Diemen's Land, and in the islands of Bass's Strait. In many of its characters, it resembles the *Rodentia*. The incisors are two in each jaw, long, and chisel-like; they are hollow at the base, and continue to grow as they are worn away; there are no canine teeth; and the molars are five on each side in both jaws. There is a wide gap between the incisors and the molars. The W. is an animal of clumsy form, having stout limbs and a blunt muzzle. It is 2 or 3 feet long, plump, with a thick coat of long, grayish brown, coarse, woolly hair; the head large, flat, broad, with small eyes and ears, the upper lip cleft; the feet five-toed, the claws long, except those of the inner toes of the hind feet; the tail very short. It is plantigrade, and the soles of the feet are broad and naked. It is nocturnal in its habits, slow in its motions; feeds on vegetable substances, and digs up roots with its claws; it makes its abode in holes among rocks, or in burrows dug by itself.

It produces three or four young at a birth. It is a creature of little intelligence, but gentle, and easily domesticated to a certain extent, not seeming to care much for any change of circumstances, so long



Wombat (*Phascolomys Wombat*).

as its wants are supplied. It shews considerable snappishness, however, if provoked. Its flesh is preferred to that of any other quadruped of Australia. It is generally fat, and in flavour resembles pork. Wombats have frequently been brought alive to Britain.—The remains of a fossil species have been found in the caves at Wellington Valley, Australia.

#### WOMEN'S RIGHTS. See SUPP., Vol. X.

WOOD, ANTHONY, of some note as an antiquary, was born at Oxford in the year 1632. His school education he received chiefly in the place of his birth, and in 1647, he was entered at Merton College as a gentleman commoner. In 1652, he took his degree as Bachelor, and in 1655, became Master of Arts. Deriving from his father an independence, he seems at first to have aimed at being a sort of Jack-of-all-trades, as not bound in penalties of hunger to follow out any particular one. He practised the fiddle assiduously, and is said to have attained considerable skill. Painting was also one of his innocent hobbies, but none of his pictures have been preserved to enable us to test his proficiency. In addition to these accomplishments, it was his whim to concern himself with heraldry and other antiquarian pursuits. He laboured much in the libraries, and presently came to be noted for his curious turn that way. In 1656, he came upon Dugdale's *Antiquities of Warwickshire*, shortly before published, the perusal of which greatly delighted him, and awoke in him the fire of emulation. He now worked still more assiduously; and went about among the tombs, copying old inscriptions. As the fruit of these learned labours, he gave to the world, in 1669, his *History and Antiquities of Oxford*. For the copyright of this work W. received £100 from the university; and Dr Fell, Dean of Christchurch, thought so highly of it that he employed one Peers, a student, to execute a Latin translation of it. The *Historia et Antiquitates Universitatis Oxoniensis* was published at Oxford in 1674.

Subsequently, in 1691, as result of his further investigations, W. published his *Athena Oxonienses*, containing a full and particular account of all the authors, bishops, &c., who had adorned that seat of learning from 1500 to 1690. In this work, he attacked the character of the great Lord Clarendon, deceased; a misdemeanour for which he was prosecuted at the court of the university, and expelled. He did not long survive this disgrace, dying 29th November 1695. His books, and a selection of his manu-

scripts, he left to the university of which he had ceased to be a member, and they are preserved in the Ashmolean Museum. His life may be found at large in the edition of his *Athena Oxonienses* issued by Dr Bliss in 1848.

**WOOD AND WOODY FIBRE.** The hard and compact or tough and fibrous parts of plants are composed chiefly of a peculiar kind of Vascular Tissue (q. v.), which, when compact, is *wood*. It exists chiefly in the stems, frequently in the roots, and also in the inner bark of exogenous plants, which yields many of the most valuable fibres used in the arts, and in the midrib and veins of leaves, some very useful fibres being obtained from the leaves of endogens. See **FIBRE**. Annual plants contain little or no woody fibre, being composed chiefly of Cellular Tissue (q. v.), which also forms great part of many herbaceous perennials, and of all plants in a very young state. Woody fibre consists of elongated cells tapering to both extremities, lying close together, and overlapping one another, sometimes much elongated into tubes. Wood is entirely made up of cells of this kind, permeated in exogenous plants by medullary rays. The cells of woody fibre have their walls thickened by successive layers of cellulose and lignine, deposited in their interior, so that they acquire strength. In the inner bark of exogens, woody fibre is mixed with laticiferous vessels (see **LATEX**) and cellular tissue.

Woody fibre has generally no definite markings on the walls of its cells; but these sometimes appear as simple discs, or as discs with smaller circles in the centre. These discs are formed by concavities on the outside of the walls of contiguous cells, closely applied to each other, so as to form lenticular cavities between them, as Mr Quekett proved in fossil pine-wood, in which he separated lenticular masses of solid matter from between the discs. When the smaller circle appears in the centre of the discs, the woody tissue is described as *Punctated*. This is especially the case in *Conifera*, but is not absolutely distinctive of them, the same character appearing also in some other plants, as in Winter's Bark. The small circle in the centre of the disc is formed by the mouth of a canal, often funnel-shaped. These canals or pores, connecting one cell with another, are supposed to give to the wood of the *Conifera* its peculiar fitness for making musical instruments.

Woody fibre is not properly formed unless the leaves of plants are well exposed to the light. There is no doubt that the Cambium (q. v.) performs an important part in the formation of wood. There has been much difference of opinion among vegetable physiologists, however, as to the mode of its formation. Two principal theories have long had and still have their advocates—the *Horizontal* and *Vertical* theories. According to the former—supported by Duhamel, Decandolle, Schleiden, Mirbel, Naudin, Henfrey, &c.—the wood of trees is formed by horizontal extension from the stem or from the bark, or from both, for there is much diversity of opinion as to these particulars. According to the latter—supported by Knight, Petit-Thouars, Gaudichaud, Lindley, &c.—the wood is developed in a vertical direction from the leaves, every bud being, as the elder Darwin long ago maintained, an embryo plant sending leaves upwards and roots downwards.

Wood is not only valuable as Timber (q. v.), but for fuel, being the chief fuel used in many parts of the world. To woody fibre we are indebted also for great part of our cordage and textile fabrics, including the very finest of them, as muslin and lace. Reduced to pulp, it is used for the manufacture of paper.

A kind of factitious or artificial wood, used for



making ornamental articles, has recently been invented in France. It is called *Bois duré*. It is formed of sawdust, heated to a high temperature, and subjected to very great pressure. Its compactness and hardness exceed those of wood itself. Another kind is made by mixing blood with sawdust, and compressing. Some kinds of costly wood are also imitated by mixing their sawdust with glue, and casting the mixture into the desired shape in moulds.

**WOODBINE.** See HONEYSUCKLE.

**WOODBRIDGE**, a market-town and river-port of Suffolk, on the right bank of the Deben, which here expands into an estuary, 11 miles from the sea, and 8 miles east-north-east of Ipswich. Vessels of 120 tons can reach the town. There are a custom-house, a bonding warehouse, and docks in which shipbuilding is carried on. The church is a striking edifice of black flint and freestone, with a magnificent tower. There is also a richly endowed charity which supports an excellent and well-conducted grammar-school, commodious and extensive almshouses, a public dispensary and library. Corn, flour, and malt are exported; coals imported. In 1875, 378 vessels, of an aggregate tonnage of 20,541 tons, entered the port, and 203, of 11,749 tons, cleared. W. is on the Great Eastern Railway. Pop. (1871) 4403.

**WOOD-CARVING** is probably the oldest branch of art. Apparently, the first weapon was a club, and the first attempt at decoration was some scratching or carving on it. Amongst the Egyptians, Greeks, and Romans it was much practised. As a branch of Christian art it was one of the earliest, and attained a high development in the 15th century. It greatly declined during the last century, but has again revived, and promises to attain great importance. The wood-carvers of Great Britain have shewn great capabilities, but hitherto have lavished too much care upon fineness of finish rather than on the artistic excellence of their designs.

**WOOD-CHARCOAL** is the most important, although not the purest, kind of charcoal. Wood consists of carbon, hydrogen, and oxygen, the last two being in the proportion to form water. When heated in the open air, it burns completely away, with the exception of a small white ash; but if the supply of air be limited, only the more volatile matters burn away, and most of the carbon remains. This is the principle of the process of charcoal-burning in countries where wood is abundant, as, for example, in the Harz Mountains. 'A number of billets of wood are built up vertically in two or three rows into a large conical heap, which is covered over with turf or moistened charcoal-ash, holes being left at the bottom for the air to get in. A hollow space is also left in the middle of the heap, to serve as a flue for the gaseous matters which are evolved. The heap is set on fire by throwing burning pieces of wood into the central opening, near the top of which, however, a kind of grate, made of billets of wood, is placed, to prevent the burning fuel from falling at once to the bottom. The combustion then proceeds gradually from the top to the bottom, and from the centre to the outside of the heap; and as the central portions burn away, fresh wood is continually thrown in at the top, so as to keep the heap quite full. The appearance of the smoke shews how the combustion is proceeding: when it is going on properly, the smoke is thick and white; if it becomes thin, and especially if a blue flame appears, it is a sign that the wood is burning away too fast, and the combustion must then be checked, by partially stopping up the holes at the bottom, or by heaping fresh ashes on the top and sides, and pressing them down well, so as to diminish

the draught. As soon as the combustion is completed, the heap is completely covered with turf or ashes, and left to cool for two or three days. It is then taken to pieces, and the portions still hot are cooled by throwing water or sand upon them. 100 parts of wood yield on the average from 61 to 65 parts by measure, or 24 parts by weight of charcoal.'—Watta's *Dictionary of Chemistry*, vol. i. p. 759. The charcoal thus prepared is the best suited for fuel. In England, a large quantity of charcoal is obtained in the dry distillation of wood in cast-iron cylinders, for the preparation of crude acetic acid. The charcoal thus prepared is preferable for making gunpowder, but is inferior for other purposes. A peculiar kind of charcoal of a reddish-brown colour, and hence termed *charbon roux*, is prepared in France for the manufacture of the gunpowder used for sporting purposes, by subjecting wood in iron cylinders to the action of superheated steam under a pressure of two atmospheres. Powder made with this charcoal absorbs moisture more rapidly than ordinary gunpowder.

The general properties of wood-charcoal are, that it is black and brittle, and retains the form of the wood from which it was derived; it is insoluble in water, infusible and non-volatile in the most intense heat; its power of condensing gases is noticed in the article on that subject; and from its power of destroying bad smells, it has been regarded as possessing considerable antiseptic properties. It is frequently stated that charcoal is a bad conductor of heat, but a good conductor of electricity: these properties depend upon the nature of the charcoal, the lighter wood, such as willow, yielding a porous charcoal, with little power of conducting heat or electricity; while boxwood yields a very compact charcoal, which is a good conductor of heat and electricity, and is admirably adapted for the exhibition of the electric light. Charcoal never consists entirely of pure carbon, the degree of purity varying directly with the temperature; thus, charcoal charred at 480° contains 65 per cent. of carbon, while that charred at 750° contains 80, and that charred at 2730° contains 96; but the loss of charcoal occasioned by these high temperatures is very great, the three percentages of charcoal corresponding to these temperatures being 50, 20, and 15.

The uses of wood-charcoal are numerous and extensive. It is very largely employed as a fuel, taking the same place in many countries that coal occupies here. From its being proof against all ordinary chemical agencies, 'a superficial charring is frequently resorted to, with the view to protect wood from decay, as in the case of piles which are driven into mud or into the beds of rivers to serve as foundations. For the same reason, it is a common practice to char the interior of tubs and casks destined to hold liquids.'—Miller's *Inorganic Chemistry*, 3d ed., p. 77. In a finely-divided state, it is commonly regarded, as has been already stated, as an antiseptic; and there is no doubt that the offensive effluvia from animal matter in an advanced stage of putrefaction disappear when the putrefying substance is covered with a layer of charcoal; but in reality the decay goes on, without the emission of any odour, till at length the whole of the carbon is dissipated as carbonic acid gas, and the hydrogen as water, while the nitrogen remains as nitric acid. For these explanations, we are indebted to Dr Steadhouse, who has shewn that the action consists in a rapid process of oxidation, dependent upon the power which finely-divided charcoal possesses of condensing oxygen. In a finely-divided state, charcoal not only condenses gases to a marvellous extent, but has the power of absorbing colouring matters, bitter principles, &c.; and hence it is of extensive use in

## WOODCHAT—WOODCOCK.

the laboratory. From the rapidity of its absorbing action, Stenhouse has proposed to use a respirator filled with charcoal to protect the mouth and nostrils in an infected atmosphere; and the employment of trays of powdered wood-charcoal in dissecting-rooms, in the wards of hospitals, and in situations where putrescent animal matter is present, is found to exert a most beneficial influence in sweetening the atmosphere, by absorbing and decomposing the offensive gases. These properties render charcoal a valuable material in the construction of filters, not only for decolorising purposes, but likewise for assisting in purifying water for domestic use. It is now also employed most successfully to prevent the escape of noxious vapours at the ventilating openings of the sewers, as it allows the free passage of air, but condenses the offensive effluvia in its pores, where they are destroyed by a process of oxidation.'—Miller, *op. cit.*, p. 78. Besides its employment in the manufacture of gunpowder, it has many applications in the arts. In Medicine, it is at present chiefly used to destroy fetor; for which purpose it is applied in the form of powder or poultice to gangrenous sores, phagedenic ulcers, &c.; it is also largely employed in tooth-powders, as by its mechanical action it removes incrustations, while by its chemical action it destroys fetor of the breath. In indigestion, accompanied by much flatulence, it may be given in doses of two or three tea-spoonfuls suspended in water, or may be administered in the form of charcoal-biscuits. Very finely divided poplar charcoal is regarded as the best for medicinal uses.

**WOODCHAT** (*Lanius rutilus*), a bird which, notwithstanding its name, is not a species of Chat, but of Shrike (q. v.). Its whole length is about seven inches and a half. The upper parts are mostly black, the under parts white; but there is a white spot on the wing when closed, and other small portions of the wing-feathers are white, as well as the outer tail-feathers, and there is a narrow streak of white above the base of the bill on each side; the crown of the head and nape of the neck are rich chestnut red. The W. is a rare bird in Britain, but is abundant in the southern parts of Europe. It may be regarded as an African bird, being found from the Mediterranean to the Cape of Good Hope. In Europe, it appears only as a summer visitant, but in Africa it occurs at all seasons of the year.

**WOODCHUCK** (*Arctomys monax*), a species of Marmot (q. v.), inhabiting North America, from



Woodchuck (*Arctomys monax*).

Hudson's Bay to South Carolina. It is from fifteen to eighteen inches long, blackish or grizzled above, chestnut red below; the form thick, the head broad

and flat, with almost no apparent neck, the legs short and thick, the feet large, the tail bushy. The hair is rather soft, the whiskers long and stout. This animal digs deep holes in fields, on the sides of hills, or under rocks in woods; its burrow slants upwards, so that water may not enter, and within are several compartments. It passes the winter in the burrow, in a lethargic state. The food of the W. is vegetable, and it is particularly destructive to crops of red clover. It is easily tamed, and may be fed on bread, milk, and vegetables. It fights successfully with a dog of equal size. The name of Ground Hog is sometimes popularly given to it. Its flesh is sometimes eaten, but is rank.

**WOODCOCK**, the popular name of certain birds commonly regarded as of the same genus with the Snipes (q. v.), but of more bulky form than the true snipes, and having shorter and stronger legs. The **COMMON W.** (*Scolopax rusticola*), well known as a



Woodcock (*Scolopax rusticola*).

game-bird in Britain, and highly esteemed as a delicacy for the table, is found also in all parts of Europe and the north of Asia. It is one of the birds of Japan. It is only a winter visitant of most parts of Britain, very rarely breeding in England, but it more frequently breeds in the northern parts of Scotland. Its summer haunts are chiefly the pine-forests of the northern parts of Europe and Asia; but in summer it inhabits higher and drier ground than in winter, when it is chiefly to be found in moist woods and swamps, seeking for worms, snails, and slugs as food, boring with its long bill in the soft ground. The quantity of food which it devours is very great; a single W. has been known to consume in a night more earth-worms than half-filled a garden-pot of moderate size. The W. is about thirteen inches in length; the upper parts varied with ruddy, yellowish, and ash colour, finely intermingled, and marked by large black spots; the lower parts yellowish red, with brown zigzag lines; the quills striped with red and black on the outer edge; the tail-feathers tipped with gray above and white below. The female is rather stouter and larger than the male, and sometimes attains a weight of fourteen or fifteen ounces. A W. of twenty-seven ounces is on record. The W. makes its nest in warm dry situations, on the ground, of dead leaves loosely laid together. It lays only three or four eggs of a pale yellowish or reddish brown colour. As woodcocks usually breed in very dry situations in the recesses of thick woods, the young ones would be left to starve but for the peculiar adaptation which enables the parent to transport them to moist feeding-grounds. It was long believed that the female W. used only her feet for carrying her young from place to place; but Mr Charles St John, in his *Natural History and Sport in Moray*, says, that from close observation he found 'the old woodcock carries her young, even when

larger than a snipe, not in her claws, which seem quite incapable of holding up any weight, but by clasping the little bird tightly between her thighs, and so holding it tight towards her own body.' The W. feeds chiefly by night. Great numbers sometimes appear in some parts of Britain, in their migrations. Besides falling to the gun of the sportsman, they are sometimes caught by nets placed in the tracks or open glades in woods, by

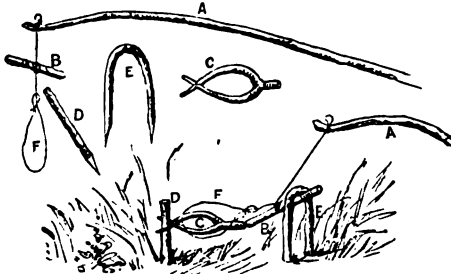

Woodcock Trap:

The upper portion of the fig. shews the separate parts; the lower portion their arrangement when set. The part C (being only supported in its position by the pressure of B) is displaced by the weight of the bird; this relieves the spring A, and the prisoner is caught by the legs in the running noose F.

(From St John's *Natural History and Sport in Moray*.)

which they proceed from their retreats to their feeding-grounds, and by nooses or springes set about the places which they frequent.—The AMERICAN W. (*Scelopax* or *Philohela minor*) is a smaller bird than the W. of Europe, being only about eleven inches long; very similar in plumage and habits. Three transverse black bands mark the hinder part of the head. It is found in all parts of North America, and is greatly esteemed for the table.

**WOOD-ENGRAVING, or XYLOGRAPHY,** the art of engraving designs on wood, differs from copper and steel plate engraving by having the parts intended to print on the paper, in relief. While plates are printed from the engraved lines by a laborious and necessarily slow process (see ENGRAVING), wood-engravings, having the object to be represented on the surface, in the manner of a type, may be printed along with the matter it is intended to illustrate in the ordinary printing-machine. This, of course, is an important point in the illustration of books, on the grounds of cheapness and expedition. Another advantage wood-engravings possess is, that they can be multiplied to any extent by means of the Stereotype (q. v.) and Electrotype (q. v.) processes.

The invention of wood-engraving, like that of gunpowder, has been claimed for the Chinese, whose books have certainly been printed from engraved wood-blocks for ages. It has indeed been asserted that the art of cutting figures in relief, and printing impressions of them on paper, was known and practised by that nation as early as the reign of the renowned Emperor Wu-Wang (1120 B.C.). There is no doubt that wood-stamps were used by the ancient Egyptians and Romans for stamping bricks and other articles of clay; and that wood and metal stamps of monograms, &c., were used in various European countries, for attesting deeds and other documents, at a very early period, when the

ability to write was an extraordinary accomplishment even for princes. It is not, however, until the beginning of the 15th c. that we find any evidence of the existence of wood-engraving, as we now understand it. It appears to have been used in Germany at that time for printing playing-cards and figures of saints. The earliest print of which any certain information can be obtained is in the collection of Earl Spencer. It was discovered in one of the most ancient convents of



Fig. 1.

Germany—the Chartreuse of Buxheim, near Memmingen in Bavaria—pasted within the cover of a Latin MS.; it represents St Christopher carrying the infant Saviour across the sea, and is dated 1423. Fig. 1. is a reduced fac-simile of this curious engraving.



Fig. 2.

ing. It is a work of some merit, notwithstanding its apparent roughness; the infant Saviour and the drapery of the saint being drawn with considerable skill and vigour. The inscription at the bottom has been thus translated: 'In whichever day thou seest the likeness of St Christopher, in that same day thou

wilt, at least, from death no evil blow incur.—1423.' Shortly afterwards, a series of books, printed entirely from wood-engravings, called block-books, were issued. They consisted principally of religious subjects, with short descriptions engraved on the same block. The most important of them were the *Apocalypsis*, *seu Historia Sancti Johannis*; the *Historia Virginis ex Cantico Canticorum*; and the *Biblia Pauperum*, the last containing representations of some of the principal passages of the Old and New Testaments, with explanatory texts. The illustrations, of which Mr Jackson, in his treatise on the *History and Practice of Wood-engraving*, gives an elaborate account and several specimens, seem to be drawn with a supreme contempt for perspective and proportion, but bear evidence of the draperies, and hands and faces, having been carefully studied. Fig. 2 is a copy of one of the cuts in the *Apocalypsis*. It represents St John preaching to three men and a woman, with the inscription: '*Conversi ab idolis, per predicationem beati Johannis, Drusiana et ceteri*' (By the preaching of St John, Drusiana and others are withdrawn from their idols). Fig. 3, from the *Biblia Pauperum*, is curious as shewing the general manner of representing the creation of Eve during the 15th c., the same subject frequently occurring previous to 1500. Both have the appearance of careful drawings 'spoiled in the engraving.' Previous to the invention of movable types, whole books of text were also engraved on wood, and the impressions had evidently been taken



Fig. 3.

by *rubbing* on the back of the paper, instead of steady pressure, as in the printing-press, the ink used being some kind of distemper colour.

The Psalter printed by Faust and Schöffer at Mentz in 1457 (see GUTENBERG), is illustrated with initial letters engraved on wood, and printed in two colours, blue and red, which Mr Jackson considers 'the most beautiful specimens of this kind of ornament which the united efforts of the wood-engraver and the pressman have produced. They have been imitated in modern times, but not excelled.' It is worthy of note, that although printed upwards of 400 years ago, the freshness and purity of the colours remain unimpaired.

As printing spread, the publication of illustrated books became general in Germany and Italy, and

reached England in 1476; in which year Caxton (q. v.) published the second edition of the *Game and Playe of the Chess*, with figures of the different pieces. They are very rude, compared with the earlier German works. Fig. 4 is a reduced copy of the 'Knight,' and is interesting as one of the first:



Fig. 4.

wood-engravings executed in this country: several works followed, all, however, in the same rude manner. The first attempt at something finer than simple lines appears in the frontispiece to the Latin edition of Breydenbach's *Travels*, printed at Mentz by Erhard Reuwich, 1486. It is by an unknown artist, and is an elaborate and really very beautiful specimen of the art. It is also remarkable as being the first engraving introducing *cross-hatching* to represent dark shadows. The *Hypnerotomachia Poliphili*, printed at Venice by Aldus, in 1499, is worthy of mention for the extreme beauty of the designs, which have been ascribed by some authorities to Raphael, and by others to Mantegna. About the beginning of the 16th c., a complete revolution in the art of wood-engraving was accomplished by the genius of Albert Dürer. His productions exhibit not only correct drawing, but a knowledge of composition and light and shade, and attention to the rules of perspective, which, with the judicious introduction of subordinate objects, elevated them to the rank of finished pictures. Dürer, however, in common with most of the German artists of his day, paid very little attention to the propriety of costume in his religious subjects; one of his drawings in the *History of the Virgin* (1511), for instance, representing the birth of the Virgin, shews the interior of a German burgomaster's house of his own day, with a number of gossips drinking from flagons, and otherwise enjoying themselves. There has been considerable discussion as to the probability of Dürer having also engraved his drawings. Most of the best authorities on the subject, including Bartsch, Jackson, and Firmin Didot, agree in the negative. Mr Jackson, who speaks with the experience of a practical engraver, says: 'In most of the wood-cuts supposed to have been engraved by Albert Dürer, we find cross-hatching freely introduced: the readiest mode of producing effect to an artist drawing on wood with a pen or a black-lead pencil, but which, to the wood-engraver, is attended with considerable labour. Had Albert Dürer engraved his own designs, I am inclined to think that he would have endeavoured to attain his object by means which were easier of execution.' The reader is referred to the article DÜRER for an account of

some of his numerous works. The best of Dürer's contemporary artists on wood were the painters, Hans Burgkmair (q. v.), Lucas Cranach (q. v.), and Hans Schiufflein. A series of works projected by the Emperor Maximilian, including *The Adventures of Sir Theurdank*, *The Wise King*, *The Triumphs of Maximilian*, &c., were illustrated by these artists; but they are not equal to those of Dürer.

During the first half of the 16th c., the publication of books illustrated with wood-engravings still increased, and prevailed to a greater extent than at any other time, with the exception of the present day. The superiority of talent, both in drawing and engraving, however, still remained with the Germans. In France, although their figure-subjects were inferior to those of their German neighbours, their ornamental borders in prayer-books, &c., of which a great number were printed at this time, were extremely beautiful. In Italy and England, the art was very far behind. The most remarkable work published at this time was the *Dance of Death* (q. v.), issued at Lyon in 1538. The original edition of this curious work contained 41 engravings, representing the struggle between Death, generally in the form of a skeleton, and different individuals, such as the Pope, the Emperor, a Judge, Monk, Doctor, Duchess, Old Man, &c. The drawings, which are characterised by great vigour and skill, are generally understood to have been executed by Hans Holbein (q. v.); but whether he also engraved them, as has been alleged, is more than doubtful. Towards the conclusion of the century, however, the art had made considerable progress in Italy, where some of the best productions of Germany were equalled, if not excelled. In England, it did not make much progress. John Daye published almost the only illustrated books of the time, notably Queen Elizabeth's Prayer-book, which contains a tolerably well executed portrait of Her Majesty. There is no certain knowledge about any of the artists or engravers, although John Daye is supposed to have engraved some of his cuts himself. At this time also, the practice of printing wood-engravings in colours from different blocks became somewhat common, although the attention of artists in that line was mostly confined to ornamental subjects. From the beginning of the 17th c., the decline of wood-engraving may be dated; Germany, the cradle of the art, being the first to forsake it; the only works worthy of notice were a series of blocks on various subjects—designed by Rubens, and engraved by Christopher Jegher of Antwerp, one of the best wood-engravers of that period—some of which are of great beauty. From this time, the art fell into a state of great neglect, not, apparently, for want of engravers, for wood-cuts of a certain kind were always produced, but for want of artists able, or willing, to make drawings worthy of preservation.

Nothing particularly deserving of notice occurred until 1766, when John Michael Papillon, an enthusiastic professor of the art in France, published an elaborate history of the subject in an unsuccessful attempt to restore it to its former importance. But it was not until the genius of Thomas Bewick (q. v.) was brought to bear on it, that wood-engraving received that impetus which has made it what it now is—one of the most important of the illustrative arts. Bewick's most important works are his *Histories of British Quadrupeds* (1790) and *British Birds* (1804); all the quadrupeds, and almost all the birds were drawn and engraved by himself. The birds, especially are executed with a truthfulness and skill which has rarely if ever been equalled. These works are also famous for their collection

of tailpieces, which display an infinite amount of humour and pathos. Fig. 5 is a reduced copy of one of them—a poor ewe, in the starvation of winter, picking at an old broom in front of a ruined cottage—a scene, trifling as it seems, which tells a woeful tale of suffering. He entirely abandoned the elaborate



Fig. 5.

system of 'cross-hatching' which prevailed so much in the works of the older engravers, and produced his light and shade by the simplest possible means. The above example affords an excellent specimen of a wonderful effect being produced by a few simple lines.

Since Bewick's time, wood-engraving has continued to flourish without interruption. He left behind him several pupils, the most successful of whom were Nesbet, Clennell (who engraved some of the tailpieces in the *British Birds*), and William Harvey. Harvey, however, forsook the burin for the pencil; and his drawings illustrating Milton's *Paradise Lost*, Thomson's *Seasons*, &c., especially such as were engraved by John Thomson (perhaps the most skillful engraver that ever lived, and a pupil of Robert Branston, a self-taught engraver), still retain a first-class place as specimens of wood-engraving. The establishment of the *Illustrated London News* (1842) tended greatly to familiarise the public with the beauties of wood-engraving. In the pages of that periodical appeared the first drawings on wood of Messrs John Gilbert and Birket Foster. The spirited figure-subjects of the former, and the exquisite landscapes of the latter, have done much to raise the art to the very high place it now occupies in England.

Of late years, the art has also made very great progress in France and Germany. The style of engraving, however, is quite different from the English, so much so, that a practised eye can distinguish a French wood-cut at a single glance. The professors of the arts of drawing and engraving on wood in the present day are so numerous, and their works generally so well known, that it would be needless, even if our space permitted, to attempt even to enumerate them.

*Practice of Wood-engraving.*—The wood used for engraving is boxwood, which has the closest grain of any wood hitherto discovered. It is principally imported from Turkey for the purpose, as the English box is too small to be of much use. It is cut across the grain in slices, which are dressed to the same height as type, for convenience in printing. Inferior kinds of wood, such as American rock maple, pear tree, plane-tree, &c., are used for coarser purposes; and for very large and coarse subjects, such as posting-bills, common deal is used, and cut on the side of the wood with chisels and gouges. When blocks—as the pieces of wood are termed—are required of a larger size than a few inches square, it is necessary to join two or more pieces together, as the amount of sound wood to be got out of even a large slice is extremely limited.

There is, however, for all practical purposes, no limit to the joining process, as blocks have been printed consisting of from 50 to 100 pieces. The wood having been made very smooth on the surface, and squared to the required size, is prepared for the artist by being covered with a preparation of white (commonly water-colour Chinese white); this gives a very good surface for the pencil to work on. The subject is then drawn in the ordinary way, the tints being generally washed in with India-ink, and the details filled in with pencil. When the drawing is finished, it is given to the engraver, who, previous to commencing, carefully covers the block with paper, fastened round the edges with bees-wax; this is necessary, to avoid rubbing the drawing out in the process. As the engraving proceeds, he gradually tears the paper off.

The tools or gravers necessary in wood-engraving are of three kinds—viz., gravers proper (fig. 6, a); tint-tools (fig. 6, b); and scoopers, or cutting-out tools for clearing out the larger pieces (fig. 6, c).

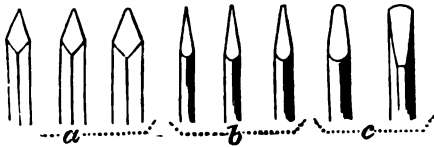

Fig. 6.

They are arranged in different sizes, to suit the different portions of the work. Fig. 7 represents the method of using the graver.

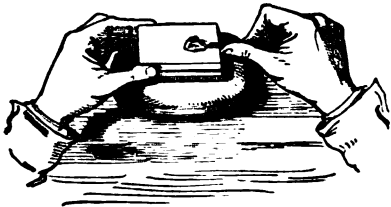

Fig. 7.

use a glass of slight magnifying power, more for the purpose of relieving the eyes from the strain of fixing both eyes closely on a small object, than for magnifying the work. When gas or other artificial light is used, a glass globe filled with water, slightly tinted with blue (to neutralise the reddish glare of the light), is placed between the flame and the work: this serves the double purpose of concentrating the light on the block, and keeping it out of the eyes. When the drawing is in outline, or mostly so, the engraving is very simple: the process consists of engraving a line along each side of the pencil lines, which are, of course, to be left in relief, and afterwards cutting out the pieces between. It will thus be understood that every part of a woodcut which prints on the paper is the surface of the wood left untouched, and that every white part is cut or hollowed out. Fig. 8 represents a little subject *outlined*; fig. 9 is the same subject *finished*. When it is complicated with much shading, trees, &c., it becomes much more difficult, and brings into play the artistic talents of the engraver to preserve the proper shades, or *colour*, as it is technically termed, and texture of the different objects. Some engravers of the present day are celebrated for their power of producing

beautiful pictures altogether by 'graver-work' from drawings made entirely with the brush. Skies and flat tints are engraved with tint-tools which, from



Fig. 8.



Fig. 9.

their shape, are best adapted for cutting straight lines; and by the judicious use of the different sizes, the lines are left wider or closer, thicker or thinner, as the tint is wanted darker or lighter. As already mentioned, the tools are arranged in sizes—i. e., those for light tints are broader at the points than those for dark tints, so as to cut out more white. Trees, foregrounds, &c., are cut with *gravers*, which, as they are like a lozenge in shape, give more scope for freedom of handling.

When the drawing is all engraved, a proof is taken by inking the surface gently with printing-ink on a dabber (a ball of cotton covered with silk), and, a piece of *India-paper* being laid on it, by rubbing the paper with an instrument called a *burnisher*, until it is all printed. The engraver then sees what touching up is required—a light part to be softened here, a hard dark part to be toned down there, &c.—before it is finished and ready for the printer.

When large blocks are to be engraved, the pieces of wood are joined with screw-bolts, and the drawing prepared in the usual manner; after which the pieces can be taken separate for convenience in engraving, and also for the purpose of getting it quicker finished, by having an engraver working at each piece—a matter of some consequence in many cases, as, for example, in the large engravings in the illustrated newspapers.

As wood-engraving, however, is at the best but a slow process, it is not surprising that many attempts have been made to introduce a substitute for it. The point aimed at is to produce by some process of etching (see ENGRAVING), or otherwise, an engraving in relief, directly from the drawing of the artist, without the intervention of the engraver at all. Many processes have been invented for this purpose. The only two which deserve mention are the *Graphotype Process* (q. v. in SUPP., Vol. X.), and *Leitch's Process*. In the former, the drawing is made on finely-prepared chalk, with silica; this hardens the lines drawn, and the soft parts are rubbed out with a brush, leaving the lines in relief. From this a stereotype is taken. In Leitch's process, the drawing is transferred to stone like an ordinary Lithograph (q. v.), and a proof—printed in ink capable of resisting acid—transferred to a plate of rolled zinc, and the white parts bitten out. The drawing may also be photographed directly on the zinc. In conjunction with photo-lithography, this process has been extensively applied to the reproduction of maps, &c., for surface printing.

See Jackson and Chatto's *History and Practice of Wood-engraving* (new ed., Lond. 1861); Papillon's *Traité de la Gravure en Bois* (Paris, 1766); Bartsch's

*Peintre-graveur*; Otley's *Inquiry into the History of Engraving on Copper and Wood*; Firmin Didot, *Essai sur l'Histoire de la Gravure sur Bois* (1863).

**WOOD-LOUSE** (*Oniscus*), a Linnæan genus of Crustacea, now forming the family *Oniscidae*, of the order *Isopoda*. The antennæ are four in number, but two of them are very short, consisting of two joints at most; the other two are long and slender. The tail is very short, but is composed of six segments. Wood-lice are terrestrial, and the respiratory organs are completely enfolded by plates developed from the abdominal members; the anterior plates being perforated by a row of small holes, through which the air has access to the gills. They frequent damp situations, and are generally found in dark and concealed places, under stones, in holes of walls, under the decaying bark of trees, &c. They feed on decaying animal and vegetable matter. They run with some celerity when apprehensive of danger, and sometimes also roll themselves up into a ball, so as to exhibit only the plates of the back. The eggs are enclosed in a peccoral pouch. The Common W.



Wood-louse  
(*Oniscus murarius*).

(*Oniscus murarius*) is very abundant in Britain, and is to be found in almost every locality suitable for it. It is popularly known in Scotland by the name of *Slater*.

**WOOD-OIL**, the name commonly given by Europeans in India to a balsamic fluid, not really an oil, obtained from the trunks of trees chiefly of the order *Dipteraceæ* (q. v.). The wood-oils of Indian commerce are generally named from the countries or places from which they are brought, and it is not yet known what trees yield particular kinds, although it is certain that most of them are produced by species of *Dipterocarpus*. The name *Gurgina Balsam*, or *Goorjun Balsam*, is frequently given to one of the most common kinds, the produce of the Goorjun tree, *Dipterocarpus turbinatus*, and other species of *Dipterocarpus*. Wood-oil is produced chiefly on the Burmese coast, and in the more southern and eastern regions. It is obtained by tapping the tree, and applying heat to the incision; or by felling the tree, cutting a hole in the trunk, and kindling a fire in it, a groove being made for the exuded fluid to flow into pots placed to receive it. The trees which produce it being often very large, a single tree sometimes yields seven tons of oil. Wood-oil is used in medicine as a substitute for Copaiva (q. v.), and in the arts as a varnish, often in combination with coloured pigments, and even as a substitute for tar in paying the seams of shipping. It is very effectual in preserving timber from the attacks of white ants. It is sometimes used in making lithographic inks. Wood-oil has a fine aromatic odour, resembling that of cedar. When allowed to remain at rest for some time, it separates into two layers, the upper consisting of a clear chestnut-coloured liquid balsam, and the lower a kind of resin in flakes. It is, of course, this resinous part only which remains when it is used as a varnish, and the varnish has dried.

**WOODPECKER** (*Picus*), a Linnæan genus of birds, now divided into a number of genera, and belonging to the family *Picidae*, of the order *Scansores*. The toes are in pairs, two before and two behind, with sharp strong claws; the bill is rather long, straight, and wedge-shaped, with a hard tip, the tip and sides compressed; the tail is usually

lengthened and rigid, although in some it is short and rounded; the vertebræ of the neck are greatly developed, and the last of the caudal vertebræ is very large, with a long ridge-like spinous process; the whole structure adapting these birds to run and climb with the greatest facility on the stems and branches of trees, in which they aid themselves by the tail, like Creepers (q. v.), and to seek their food, which consists chiefly of insects and their larvæ, by digging in the bark and wood of trees with their bill. In addition to the particulars already noticed, they have the tongue fitted to serve as an important instrument in obtaining their food; the branches of the hyoid bone being greatly elongated backwards, and in front moving as in a sheath; a peculiar arrangement and development of muscles enabling them to extend the tongue far beyond the bill; its tip being horny, and furnished with barbed filaments, whilst its surface is covered with a glutinous saliva, secreted by two large glands. Their powers of flight are very moderate, and the keel of the breast-bone is small. The Barbets (q. v.) and Wrynecks (q. v.) are referred to the family *Picidae*. Woodpeckers are diffused over almost all parts of the globe, but abound chiefly in warm countries. The species are very numerous. They are mostly solitary in their habits, and live in the depths of forests. They feed in part on fruits and seeds as well as on insects; but much of their time is spent



Green Woodpecker (*Picus viridis*).

in pursuit of these, and they may be heard at a considerable distance, tapping the wood of trees with their bill, to discover the place where an insect is lodged, and to get at it when discovered. The common notion, that they are very injurious to trees, is erroneous, as they do more good by preventing the ravages of insects than harm by their pecking. They strike out chips of wood with their strong bill, and in this way enlarge holes in decayed parts of trees for a roosting-place or a nest, carrying away the chips to a distance, especially in the case of a nest, as if for precaution that it may not be discovered. The nest consists of a mere hole in a tree, perhaps with a few chips in the bottom of it, but with no other lining. The plumage of woodpeckers is generally of strongly contrasted colours, black and white, or green and yellow, with red marks about the head. There are several well-marked groups of woodpeckers, differing in form, plumage, and habits, which also are of different geographic distribution, some of them being entirely, and some chiefly confined to particular parts of the world.

Only four species are found in Britain, and one of them, the GREAT BLACK W. (*Picus* or *Dryocopus martius*), is of rare occurrence. It is about sixteen inches long; black, with a red cap on the head. It is found in the pine-forests of many parts of Europe.—The GREAT SPOTTED W. (*P. major*), also called FRENCH PIE and WOOD PIE, is not uncommon in some parts of England, but is rare in Scotland. It is found on the continent of Europe from Norway to the Mediterranean. It is about nine inches and a half in length. The colour is black, varied with white, the under parts grayish white; the back of the head in the male bright scarlet. The LESSER SPOTTED W. (*P. minor*) is not uncommon in the south of England. Its whole length is about five inches and three-quarters. It is widely distributed in Europe and the north of Asia. Its colours are similar to those of the last species, but differently arranged. It is frequently to be seen searching for insects on the moss-covered branches of orchard trees.—The most plentiful of all the British species of W. is the GREEN W. (*Picus* or *Gecinus viridis*). It is found in the wooded parts of Scotland as well as in England, but is rare in Ireland. It is common on the continent of Europe from Scandinavia to the furthest south. It is about thirteen inches in length; and is mostly of a dark-green colour, tinged with yellow; the feathers over the nostrils and round the eye, black; the crown and back of the head, bright scarlet, a black moustache extending backwards and downwards from the base of the lower mandible, with a brilliant scarlet patch along the middle of it; the edges and tips of the wings spotted, black and white. It chiefly inhabits elm and ash trees, making its roosting-place and nest in them in the manner already described. Among its popular English names are *Woodspite*, *Yaffle*, *Whet-ile*, and *Woodwall*. The Green W. belongs to a group or section of woodpeckers entirely confined to the Old Continent, and which are more frequently to be seen seeking their food on the ground than the more typical species. The American species of W. are very numerous, and some of them, which want of space prevents us from describing, are amongst the best-known birds of the United States and Canada; as the Hairy W. (*Picus villosus*), which is to be found at all seasons in woods, orchards, fields, and even in the midst of cities, visiting farm-yards in winter to pick up grain—a lively, noisy, and active bird; the IVORY-BILLED W. (*Picus* or *Campelophilus principalis*), which inhabits the southern parts of the United States and Mexico; is called *Carpentero* by the Spaniards, from the great quantity of chips which it makes; and is valued by the Indians for its ivory-like bill and scarlet crest, which they use as ornaments. The RED-HEADED W. (*Picus* or *Melanerpes erythrocephalus*) is very common in most parts of North America, and feeds much upon fruits and upon young heads of Indian corn, so that a reward is given for killing it. The largest species in the northern parts of America is the BLACK W., or LOG-CKOCK (*Picus* or *Dryotomus pileatus*), which is about eighteen inches long, the general colour greenish black, with stripes of white from the eyes along the neck and sides.—The genus *Picumnus* is the type of a group of *Picidae* called *Piculets*, very small birds, with bill hard at the tip, broad rounded wings, and a short tail with broad rounded feathers, not used for support, departing from the typical characters of the family. They inhabit the warm parts of South America, India, and the Eastern Archipelago.

**WOOD-PRESERVING.** Several processes have been employed of late years for the purpose of preventing the decay of wood from damp, atmospheric

action, or the destructive operations of animals and parasitic plants. The principle in all has been the same—viz., the injection into the vessels of the wood of some mineral material, which, by combining with the albumen of the woody tissue, prevents its decomposition, or gives it a poisonous character. The chief of the methods in use are that called Kyanising (q. v.), creosoting, in which the preserving material is the so-called creosote, or crude carbolic acid of coal-tar, and the Boncherie process, chiefly used on the continent. In this last, a solution of sulphate of copper is used. Whilst the tree is still growing, the head of the tree is cut off, and the top of the bare stem is hollowed into the form of a bowl, which is then filled with the solution, which is afterwards supplied as required. The liquid penetrates downwards, killing the tree as it goes, but giving to the wood a most remarkable degree of durability, particularly when applied to such purposes as railway sleepers, &c.

**WOODRUFF** (*Asperula*), a genus of plants of the natural order *Rubiaceæ*, containing a number of annual and perennial species, with whorled leaves, natives of the northern parts of the Old World, and distinguished by a funnel-shaped or bell-shaped corolla, a bifid style, capitate stigma, and dry didymous fruit. The SWEET W. (*A. odorata*) is common in shady woods in Britain and all parts of Europe. It has a creeping root, a stem 5–10 inches long, weak and sub-erect, four or five whorls of lanceolate leaves, 6–8 in the whorl, rough at the edge and keel, and small white flowers. The plant, when dried, has a very agreeable fragrance, similar to that of *Anthoanthum odoratum* (see VERNAL GRASS) under similar circumstances. It forms an agreeable herb-tee, and enters into the composition of the popular *May-drink* of the Germans.—DYER'S W. (*A. tinctoria*) is a native of the continent of Europe and of Siberia, a perennial, with reclining stems about a foot in length, whorls of six or four linear leaves, the upper leaves opposite, the flowers whitish. The root is used in Dalmatia and elsewhere instead of madder; but the crop obtained from a field is inferior in quantity to that of madder.



Woodruff  
(*Asperula odorata*).

**WOODS AND FORESTS, AND LAND REVENUES, COMMISSIONERS OF.** In ancient times, the principal part of the royal revenues of England consisted of the rents and profits of the crown-lands, which were composed of numerous lordships and honours, with forests and chases. The demesne lands reserved to the crown at the Conquest were at one time very extensive; but while they were often added to by forfeitures, they were also so largely encroached on by grants to subjects, that from the 12th to the 14th c., parliament had often to interpose to compel the resumption of grants thus made. The confiscation of the property of the monasteries under Henry VIII, greatly



increased the real estate of the crown; and, notwithstanding alienations by that monarch and by Queen Elizabeth, who disposed of part of the royal domains, to avoid application to parliament for supplies, the crown, at the accession of James VI., owned very extensive estates all over England. The profusion, however, of James and his successors reduced the royal estates to insignificance, and no effectual restraint was imposed on their dilapidation until statute 1 Anne, c. 1, prohibiting all alienations of the crown-lands, except by leases not exceeding 31 years, or three lives. From the reign of Henry VIII. to that of George III., the crown revenues were subjected to repeated changes of management; and under George III., the system was first introduced of surrendering the greater part of them to be consolidated with the rest of the public revenue, out of which the royal civil list is paid. The modern administration of the land revenues of the crown is founded on a statute of 1810, establishing a Board of not less than two, or more than three Commissioners, called 'The Commissioners of his Majesty's Woods, Forests, and Land Revenue.' The law relating to the management of the crown-lands was consolidated by act 10 Geo. IV. c. 50, which, repealing a number of previous enactments on the subject, placed the whole hereditaments of the crown in England, Wales, and Ireland, except advowsons and vicarages, under the management of the Commissioners of Woods and Forests, with large power of selling and leasing them; and provided that the annual land revenues should, subject to certain deductions, be carried to the Consolidated Fund during the king's life. This transfer to the Consolidated Fund, the result of a special agreement terminating with the life of the sovereign, has been renewed with his successors. Act 2 and 3 Will. IV. c. 112, empowered the Treasury to transfer to the Commissioners of Woods and Forests the management of the crown-lands of Scotland.

A large addition was made to the duties of the Commissioners of Woods and Forests by 2 Will. IV. c. 1, which, abolishing the office of Surveyor-general of his Majesty's Public Works and Buildings, intrusted to them the management of the public works. This union, however, was afterwards considered inexpedient, and act 14 and 15 Vict. c. 42, removed the department of Public Works from the Woods and Forests, and placed it under separate control. The act, 29 and 30 Vict. c. 62, introduced various alterations in the details of management. The Commissioners of Woods and Forests act under the control of the Treasury, and are required to transmit annual accounts of the receipt and expenditure of their department, to be audited by the Commissioners for auditing Public Accounts. The yearly receipts from this source amount to about £375,000. See WORKS, BOARD OF.

#### WOOD-SORREL. See OXALIDÆ.

WOODSTOCK, a small town and parliamentary borough, Oxfordshire, 8 miles north-north-west of the city of Oxford. The pop. (1871) of the borough (which includes several adjacent villages and hamlets) is 7477, and is much larger than that of the town, which contains only 1200 inhabitants. The manufacture of fawn-skin gloves gives employment to about 1200 persons, residing in the town and neighbouring villages. W., or rather Old W., a little to the north of the present town, was a residence of the early English kings; but no remains of the ancient palace exist. Edward, the Black Prince, was born here; Elizabeth was held prisoner by her sister Mary; and Chaucer resided here for some time. W. is also famous in connection with Fair Rosamond, the

celebrated mistress of Henry II. It is now doubted, however, if the labyrinth or maze which Henry is said to have constructed for her behoof ever existed. In the immediate vicinity is Blenheim Park, the seat of the Duke of Marlborough. W. returns one member to the House of Commons.

WOOD-SWALLOW (*Artamus*), a genus of birds, resembling swallows in many of their habits, but differing in the structure of their bills and feet, and belonging to the family of *Ampelidæ*, or Chatterers (q. v.). The bill is very broad at the base, and arched; the upper mandible thick, but not ridged; the gape furnished with bristles; the nostrils wide apart, naked; the feet short and strong; the wings very long and pointed; the tail short. Their flight is rapid. Their food consists chiefly of seeds. They are natives of the East Indies and of Australia. An Australian species (*A. sordidus*) is sometimes seen in great numbers, and is remarkable for the habit of suspending itself in clusters on dead branches, like a swarm of bees, one bird clinging to another, so that as many thus hang together as would fill a bushel.

WOOL is a variety of Hair (q. v.). The term hair is applied, in ordinary language, to a smooth, straight-surfaced filament like human or horse hair, without serrations of any kind on its surface. Wool, on the other hand, is always more or less waved, as in fig. 1; besides which, externally each woolly filament is seen under the microscope to be covered with scales overlying each other, and projecting wherever a bend occurs in the fibre; fig. 2, in which one of the leading varieties of wool is shewn both in its



Fig. 1.

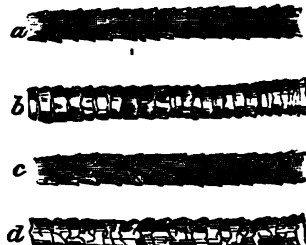

Fig. 2.

natural state (*a* in outline, and *b* complete) and after it has undergone the process of carding (*c* in outline, and *d* complete), in each condition both as a transparent and as an opaque object. Upon the minute points of difference here shewn, the value of wool chiefly depends, especially with regard to the great variety of its applications. If each fibre were straight and smooth, as in the case of hair, it would not retain the twisted state given to it by spinning, but would rapidly untwist when relieved from the force used in spinning; but the wavy condition causes the fibres to become entangled with each other, and the little projecting points of the scales hook into each other, and hold the fibres in close contact. Moreover, the deeper these scales fit into one another, the closer becomes the structure of the thread, and consequently of the cloth made of it. This gives to wool the quality of *Felting* (q. v.). By combing, or drawing the wool through combs with angular metal teeth, some of the scales are removed, and the points of many more are broken off, so that wool which has been combed has less of the felting property, and is consequently better adapted for light fabrics; and yarn made of such wool is called *worsted*, and the cloths made of it *worsted goods*. But such is the variety of wools obtained by careful breeding and selection, that these differences can be

got without combing, some wools being found to have naturally fewer serratures, and a less wavy structure, than others. These are consequently kept separate, and are called *combing-wools*; whilst those which are much waved, and have many serratures, are called *carding-wools*, from their being simply prepared for spinning by carding-machines. The serratures or points of the scales are exceedingly small, and require the aid of a good microscope to see them. They vary from 1200 up to 3000 to an inch.

Wool is the most important of all animal substances used in manufactures, and ranks next to cotton as a raw material for textile fabrics. Its use as a substance for clothing is almost universal in the temperate regions of the globe.

Previous to 1791, British woollen cloths were made almost wholly of native-grown wools. At that time, the whole supply of the country could not have much exceeded 100,000,000 lbs. The merino wool of Spain then began to displace them in the best kind of goods, and the imports from that country reached their maximum in 1805, being in that year 7,000,000 lbs. Before 1820, the German wool had begun to supersede the Spanish, and was imported largely till 1841. After that, the cheaper wool of the British colonies to a great extent took the place of the German, and the latter is now chiefly used for only the finest cloths.

Wool varies in character according to the peculiar breed of sheep which yields it, and also with the nature of the soil, food, shelter, and climate. In a wool of first-rate quality, the fibres are fine, soft, elastic, sound, of good colour, and free from deleterious or troublesome impurities: the commercial value of any sample depends, therefore, upon the extent to which it possesses these properties. If it be a combing wool, it will also depend upon its length of staple.

For technical purposes, shorn fleeces are divided into two classes, one called *hogs* or *tegs*, the other *weethers* or *ewes*. The former are the first fleeces shorn from the sheep, the latter are those of the second and succeeding years; but the meaning of these terms varies a little in different districts. The fleeces of yearlings are, as a rule, longer in the staple, and otherwise of superior quality to the wool of older animals. In the south of England, it is customary to clip lambs, and the wool so obtained is called *shorn lamb's wool*. Wool taken from the skins of slaughtered sheep is called *skin-wool* or *peit-wool*, and is of a more variable quality than fleece-wool, on account of its being obtained in all stages of growth.

As long-stapled wools are used for worsted goods, and short-stapled for woollen goods, the various breeds which yield these two leading kinds are naturally divided into the long-woolled and short-woolled classes of sheep. The Lincoln, the Leicester, and the Cotswold breeds are considered good types of the former; and the Down, the Welsh, and the Shetland breeds, of the latter.

The following brief notice of the characteristic properties of the various native wools, is founded upon the description given of them in the Jury Report of the International Exhibition of 1862, Class IV.

Of the 'long wools,' the *Lincoln* has greatly risen in value of late years. It is coarse, of great length, and silky in appearance, so that it is well adapted for 'lustre' goods, in imitation of alpaca fabrics. *Leicester* wool is highly esteemed for combing. It is rather finer in the hair, but not usually so soft and silky in the staple as the last. *Cotswold* wool is similar to the Leicester, but somewhat harsher. It is not suited for lustre goods. *Highland* wool is

long stapled, and of coarse quality, but known to be susceptible of great improvements. The practice of 'smearing' greatly depreciates its value. It is chiefly used for the coarsest kinds of woollen fabrics, as carpets, rugs, and similar articles. It is also used for Scotch blankets.

Of the 'short wools,' the different breeds of Downs partake very much of the same characters, but soil and climate so far affect them. The *South Down* is a short-stapled, small-haired wool, the longer qualities of which are put aside for combing purposes, and the shorter for the manufacture of light woollen goods, such as flannel. The *Hampshire Down* differs from it in being coarser, and in having the staple usually longer. The *Oxford Down*, again, exceeds the last in length and coarseness of staple. The *Norfolk Down*, on the other hand, when clean, is of a very fine and valuable character. The *Shropshire Down* is a breed increasing in importance, and is longer in the staple, and has more lustre than any of the other Down breeds. *Ryeland* wool is fine and short, but the breed is nearly extinct. The *Welsh* and *Shetland* wools have a hair-like texture, deficient in the spiral form, upon which depends the relative value of high-class wools. They are only suited for goods where the properties of shrinking and felting are not required. Shetland wool is obtained of various natural tints, which enables it to be used for producing different patterns without dyeing.

Of the intermediate wools, *Dorset* is clean, soft, and rather longer, and not quite so fine in the staple as the Down breeds. The *Cheviot* has increased very much of late years in public estimation. It is a small, fine-haired wool, of medium length, and is suitable for woollen and worsted purposes, for which it is largely used.

Some of the British colonies are very important wool-producing countries, Australia in this respect standing far in advance of all other countries whatever. The Australian wool has in general a beautiful, short, silky staple, well adapted for the manufacture of soft, pliable, and elastic fabrics. All the settled districts of this continent have been found well adapted to the growth of fine-woolled sheep, and the extraordinary increase in the flocks forms one of the most remarkable features of the colony. The breed has sprung from three merino rams and five ewes taken out by Captain M'Arthur in 1797. The alpaca wool grown in Australia since the creature was introduced some years ago is of inferior quality; but this is supposed to have arisen from rearing the animals too near the coast, and hopes are now entertained of succeeding better with it inland.

The wool of Cape Colony has of late years been greatly improved by the introduction of merinos, and, as will be seen from the table below, the exports from it are increasing very rapidly.

Among the imports from India, wool has of late become an important article, the quantity having risen from about 2,500,000 lbs. in 1840, to 19,000,000 lbs. in 1874; but the supply is rather fluctuating. A great deal of the Indian wool is coarse and hairy, and can only be used for low-class goods. We may state here that the most costly of all wools is obtained from the Tibetan goat, and is found next the skin, under the thick hair of the animal. From it, the far-famed Cashmere shawls are made. The highest price of any quality which is sold is from 6s. to 7s. per lb. in the native markets, but the Maharajah of Cashmere keeps a strict monopoly over the best kind.

Turning now to European countries, it is somewhat sad to think that Spain, the native country of the merino, which not so long ago sent all the wool

**WOOL—WOOLLEN AND WORSTED MANUFACTURES.**

for the best English cloths, has allowed its quality to degenerate, and its once large supply to dwindle away. The wool of Saxony, Silesia, and some parts of Austria, which is obtained from sheep of the merino breed, is the finest produced in any country; and notwithstanding the lower price and nearly equal quality of the Australian, German wool is still employed for the finest broadcloths, some kinds of ladies' shawls, and a few other purposes. Great attention is paid to the breeding and rearing of sheep in Germany, and large flocks are reared for their wool alone. In Austria, the number of sheep is estimated at 45,000,000, and the annual yield of wool at 100,000,000 lbs., most of it being of fine quality, and all of which is consumed in Austrian manufactures. France produces a large quantity both of fine and coarse wool. In Italy, the production of wool from mixed merino breeds has become a source of great wealth. Russia, as might be expected from its great extent, rears many qualities, from the finest merino to a very coarse kind. The wools of the remaining countries of Europe are of minor importance.

We must not omit to mention that the wools of South America are now attaining great importance, as will be seen by the table below, but it is necessary to state that besides the 10,562,874 lbs. imported in 1874, there were 4,182,867 lbs. of alpaca (including llama and vicuna) wool. See ALPACA. The wool of the alpaca is very fine, from 6 to 12 inches long, of various colours, and well suited for certain kinds of goods, which are noticed under WOOLLEN AND WORSTED MANUFACTURES. South American sheep's wool is of an inferior quality.

Much finer wool would be produced in Britain than is at present, if it were not that the demand for mutton, and the unfitness of the merino sheep for supplying that article of good quality, lead our farmers to choose breeds which are primarily mutton-producing.

The following table will shew at a glance the remarkable changes which have taken place in the sources from which Great Britain has derived its supplies of wool, and also the steady increase in the aggregate quantity imported :

**IMPORTS OF WOOL FROM THE PRINCIPAL COUNTRIES.**

Year.	Spain.	Germany.	Australia.	South Africa.	East Indies.	South America.
	lbs.	lbs.	lbs.	lbs.	lbs.	lbs.
1810	5,952,407	773,335	167	.....	.....	} Insignificant previous to 1833.
1816	2,968,607	2,816,655	13,611	9,623	.....	
1820	2,536,229	5,113,443	99,415	29,717	.....	
1830	1,643,515	26,073,332	1,967,279	33,407	.....	
1834	2,343,915	22,634,615	3,558,091	141,707	67,763	} 4,378,274 5,236,648 8,350,000 15,457,631 10,562,874
1840	1,286,905	21,512,099	9,731,243	751,741	2,441,370	
1850	440,751	9,166,731	39,018,221	5,708,529	3,473,251	
1860	1,000,000	9,392,000	59,166,000	16,574,000	20,214,000	
1870	25,282	4,912,600	175,081,427	32,785,271	11,143,148	
1874	100,178	7,158,319	225,383,631	42,232,672	19,116,772	

To get the total imports for each year, we would require to add the amounts from countries of lesser importance, which are not given; but in the annexed statement we give the total annual imports for the three years 1872, 1873, 1874: (1872) 302,500,925; (1873) 313,496,742; (1874) 340,288,032. For several years past, about one-third of the imported wool has been re-exported. The estimated produce of home-grown wool in 1871 and the three preceding years was as follows :

1871. Total of Animals slaughtered, 12,370,056,	lbs.	94,017,654
estimated at 2½ lbs. =		144,985,713
1870. Net Clip of Wool,		149,516,679
1869. " " "		155,591,096
1868. " " "		165,549,735

Independently of the vast amount of home and foreign grown wool which finds its way into our markets as wool that is in the condition fit for spinning and weaving, considerable quantities are retained on the skins, and made into rugs or mats for house and carriage use. For this purpose, skins of the very best quality are chosen, and it is necessary that the wool should be very long in the staple. After being carefully curried, the long silky locks of wool are dyed usually some bright colour, and combed. The skins are pared to shape, and form handsome rugs, which are not only in great favour in Britain, but are extensively imported. The chief seat of this trade is at Bermondsey, in London, but it is also carried on to a considerable extent in other parts of the kingdom. Large numbers of Astracan sheep and lamb skins, usually black, are also imported in the wool, and are dressed and used as furs, that is, for personal wear; and some of the Slink lambs' skins for this purpose fetch high prices.

With respect to the wool, or woolly hair, of animals other than the sheep, which we have not already mentioned, the only one of much importance is mohair, or the wool of the Angora Goat (q. v.). Of this material, there were about 7,000,000 lbs. imported in 1874. It is a white silky wool, with an average length of staple of from 5 to 6 inches. The demand for it is only of recent origin, and, as will be noticed in our next article, it is chiefly used for certain kinds of ladies' dresses. The hair of camels, bullocks, common goats, and several furs are also used to some extent for manufacturing purposes.

The grand total of wool, shoddy, and goats' hair employed in the woollen industries of Great Britain in 1874, cannot have been far short of 500,000,000 lbs. The total import of raw cotton in the same year was nearly 783,432,216 lbs.; but of this, more than 129,493,816 lbs. were re-exported.

**WOOLLEN AND WORSTED MANUFACTURES.** The spinning and weaving of wool was practised from an early period in Asia Minor, Greece, Italy, and some other countries. It is very probable that the first lessons which our ancestors received in this art were got from the Romans after the Conquest; but the origin of the manufacture as a great staple is generally supposed to date from the time of William the Conqueror, when some Flemish weavers came to England, and obtained the patronage of the queen. The trade, however, fell off during the troubles of succeeding reigns. In 1331, it revived again by another supply of Dutch weavers brought over by Edward III. In 1530, the introduction of the spinning-wheel gave a new impetus to the trade. French workmen, driven to England by the revocation of the Edict of Nantes in 1685, still further aided it by their skill in the making of fine cloth, and from that time to the

present it has steadily prospered. It is hardly necessary to state that the woollen trade has shared, in common with other leading textile manufactures, the great advancement they have received from the spinning-jenny, the mule, and the power-loom.

There are two great classes of manufactures using wool as a raw material: in the one where carded wool is employed, the goods are called 'woollen fabrics;' in the other, where combed wool is used, the goods are called 'worsted fabrics.' We shall first treat of the *Woollen Manufacture*.

As our articles on SPINNING and WEAVING are general, we shall here briefly state the chief stages in these processes, as applied to the manufacture of woollen cloth. A fleece of wool is first sorted by experienced sorters into several qualities, as first sort, or 'pick-locks;' second sort or quality; third sort or quality; and so on. Sometimes, it is only divided into three, sometimes into as many as six kinds. The 'scouring' is the next step, and consists in immersing the wool in an alkaline lye, which forms a soap with the natural grease of the fleece. This of course acts as a detergent, and cleans the wool thoroughly when it is washed in water. Upon the perfection with which the scouring is performed, depends in great part the beauty of the dye. It is often dyed at this stage, and is then said to be *wool-dyed*; if not dyed till it is woven, the cloth is said to be *piece-dyed*. For some purposes, it is dyed in the yarn.

Scoured wool, whether dyed or not, next undergoes the operation of 'willing.' The 'willy' is a machine used to cleanse the wool from dust and other loose impurities. In many cases, seeds with hooked scales like burs are so thickly entangled in the wool, that it requires to be passed through a 'burring'-machine, and afterwards examined by 'pickers.' This is especially the case with South American wool, including that of the alpaca. After this, the wool is sprinkled with olive oil, which renders the fibres soft, flexible, and better fitted for later operations. The next process consists in tearing open the matted portions, and separating the wool into small tufts by means of a machine called a *teaser*, *tucker*, or *devil*. It has a large cylinder studded over with iron pikes, which performs from 1000 to 2000 revolutions per minute, teasing the wool as it revolves, and throwing it out like flakes of snow.

The two next operations are called *scribbling* and *carding*, and are performed by two somewhat similar machines, the essential parts of which will be understood by referring to figs. 6, 7, and 8 in the article SPINNING. Each machine consists of a large cylinder surrounded by several small rollers, all covered with wire cards or brushes. These, acting like fine toothed combs, open out, mix, and blend the fibres into a uniform and continuous sheet or lap, in which state it leaves the *scribbler*; but in the *carder*, the sheet is at length converted into small rolls, say from a quarter to half an inch in diameter, which are afterwards joined together, and form the basis of the thread. In the next machine, called the *slubbing-billy*, these rolls are drawn out, slightly twisted, and, in short, half converted into yarn. The spindles upon which these *slubbs* or *slubbings* are wound pass them to the *spinning-mule*, where they are converted into finished yarn.

Comparatively recent improvements have made the operations of scribbling, carding, and slubbing continuous, mainly through the introduction of Apperly's patent feeder, and of a modification of the carding-machine called a *condenser*, which does away with the use of the slubbing-billy; so that what with the older machines is three separate pro-

cesses, with the newer may be said to be only one. Each of the foregoing operations occasions a certain amount of 'waste' wool, which is worked up again into inferior goods. It was, in fact, to such waste that the name *shoddy* was originally applied. In the spinning process, the warp yarns, having to bear the strain of the loom, are made in a different way from those for the weft, and they are besides hardened with size.

The difference between woollen and worsted fabrics is owing in great part to the way the yarn for each is spun. Yarn for woollen cloth is very slightly twisted, so as to leave the fibres as free as possible for the felting process; worsted yarn, on the contrary, is hard spun, and made into a much stronger thread. On account of the feebleness of woollen yarn, it is more difficult to weave it by power-looms than either worsted, cotton, linen, or silk.

Woollen cloth is now woven chiefly by power-looms. See LOOM and WEAVING. When the cloth is taken from the loom, it has a bare look, and is called the *raw thread*. It first requires to be *brayed* or *scoured*, to remove the oil added to the wool before spinning, and the size added to the warp. This is done by immersing it in some ammoniacal detergent liquid, such as urine and hog's dung, and squeezing it between rollers, or beating it in the fulling-stocks, and then rinsing it in clean water. The cloth then passes to the *burler*, who removes any knots or burls, and helps any imperfections. The next process to which it is subjected is the *milling* or *fulling*, and it is a very important one. In some mills, this is still done by beating the cloth in the *fulling-stocks*, which are heavy wooden mallets, raised by wheels with projecting cams; but a newer *fulling-machine* has come into use, in which the cloth is felted by passing it in a confined space between heavy rollers. With either machine, a thick solution of soap is used, and in the fulling-stocks an ordinary broadcloth will take 60 hours to mill, but a considerably shorter time suffices in the fulling-machine. The result of the operation is, that the fibres of wool become so interlocked—so thoroughly felted—as to leave no appearance of thread. The shrinkage of the cloth in the milling is sometimes nearly a half in the width, and about a fourth in the length. Another scouring follows the milling, and after that the nap or pile of the cloth is *raised* by Teasels (q. v.). These curious thistle-like heads are set in frames, which are arranged upon a large cylinder—the whole apparatus being called a *gig-mill*. As the cylinder revolves, the spines of the teasels raise the nap, which is afterwards cut by a process termed *shearing*. For this purpose, a cutting-machine with spiral blades arranged round an iron cylinder, is used; and when it revolves, the spiral cutters, acting against a straight steel blade, shear off the nap of the fabric like scissors. The cloth is then boiled, or 'scalded,' to impart a lustre to it, and to prevent spotting with rain. After this it is dyed (if this is not previously done in the wool), and finally it is pressed between polished iron plates in a powerful hydraulic press. With respect to the dyeing of black cloth, it may be as well to explain that the term *woaded colours*, so commonly used in the trade, originally meant that Woad (q. v.) was used in conjunction with indigo as the basis of the colour—a combination which produces the best and most durable colour. Of late years, however, the name has been applied to the colour of the fabric when indigo itself has been used as its basis. It is only the finest cloths that are now dyed in either of these ways—logwood, a salt of iron, and galls being much more generally employed to produce a black.

## WOOLLEN AND WORSTED MANUFACTURES.

Names are given to various kinds of woollen cloths according to the style in which they are finished, the special material of which they are made, and the purpose for which they are intended. *Broadcloths* are classed into 'superfines' running from 54 to 62 inches wide; 'mediums' from 54 to 58 inches; 'double milled' from 54 to 56 inches; and Venetians, which are twilled fabrics, from 54 to 58 inches. The general term broadcloth also includes the following varieties, which, for the most part, have less highly-finished surfaces—viz. meltons, beavers, pilots, cloakings, china striped cloths, India cloths, elastics, lustras, and union cloths which have cotton warps and woollen wefts. *Narrow cloths*, which average about 27 inches wide, include cassimeres, a thin, fine, twilled fabric; doeskin, also twilled, a strong, smooth-finished, sometimes treble-milled cloth, now usually dyed black for trouserings; Tweeds (q. v.), which have very much taken the place of fancy doeskins; and several other varieties. Then there are special kinds both broad and narrow—such as army cloths, rifle cloths, police cloth, upholstery cloth, carriage cloth, coffin cloths, and many more. Flannels, blankets, and some kinds of shawls, are also included among woollen goods.

The public taste has changed very much of late years with respect to the finish of woollen cloths. Formerly, a firm, close, and hard fabric, with a highly-dressed or glossy surface, was in demand; now, a softer and more pliable finish, without gloss, is in favour. Foreign manufacturers think, however, that a soft, rich, elastic cloth is apt to lose in strength what it gains in appearance, and do not finish so highly as the English. The desire for fancy woollens is another marked feature of the taste of the present day, and compels manufacturers to expend considerable sums in the preparation of designs and colours. It has also led to the enlargement of old, and the establishment of new art-schools in both the woollen and worsted centres in Yorkshire.

Of all the changes, however, which the present generation has witnessed in this trade, the most remarkable is doubtless the production of cheap cloths by the use of shoddy; although cotton warps have also done much in the same direction. Prepared shoddy is obtained, for the most part, by tearing up woollen rags by a *swif*, with ten or twelve thousand iron spikes upon it, revolving inside an iron cylinder. Shoddy now enters to a greater or less extent into the composition of all but the very finest woollen cloths. It began to be used about 60 years ago, but the prejudice against it is scarcely yet overcome. In spite of this feeling, it has become so necessary, that to stop the supply, would be to shut one-third of the woollen mills in the kingdom. The excellent finish now given to woollen cloths containing a large proportion of shoddy, and also cloths with cotton warps, is quite surprising; and, moreover, their cheapness has brought comfortable clothing within the reach of the humblest classes. Cloths with too large an amount of shoddy in them are easily torn; but if a judicious admixture of pure wool has been employed, they wear comparatively well. Formerly, the only use of woollen rags was to make flocks for wall-papers, for saddlers' stuffing, and some minor purposes—the greater part being used as manure.

In the British Islands, the various branches of the woollen manufacture are very extensively diffused. According to a factory return made in 1871, it was carried on in 22 counties of England, 12 of Wales, 27 of Scotland, and 16 of Ireland. The principal seat of the manufacture of superfine broadcloth is the west of England—Gloucestershire and

Wiltshire especially—where it has existed for centuries. But Yorkshire is the great seat of the woollen manufacture, if we take in all the kinds, Leeds and Huddersfield being the great centres. One-half of all the operatives in the woollen factories of the kingdom are employed in Yorkshire, and here, too, the trade has increased most rapidly, both in the last and in the present century, owing mainly, it is believed, to the success of the manufacturers in producing cheap goods. Blankets are made chiefly at Witney, in Oxfordshire; at Dewsbury, in Yorkshire; and some places in the south of Scotland. Halifax and the surrounding district is the chief centre for flannels, but they are also made largely in Wales. In Scotland, the woollen manufacture is a very extensive one, but it has, for the most part, been already described under **TWEEDS**.

The following statistics of the woollen industry of the United Kingdom are for the year 1875:

NUMBER AND EFFECTIVENESS OF WOOLLEN FACTORIES.

	Number of Factories.	Total Number of Spindles.	Total Number of Power-looms.
<b>England and Wales—</b>			
Factories employed in spinning,	490	563,512	....
Factories employed in weaving,	45	....	1,875
Factories employed in spinning and weaving,	771	2,248,551	43,150
Factories not included in either of the above descriptions, .	187	....	....
Total, . . . . .	1493	2,812,063	45,025
<b>Scotland—</b>			
Factories employed in spinning,	102	228,119	....
Factories employed in weaving,	40	....	7,235
Factories employed in spinning and weaving,	105	378,444	4,433
Factories not included in either of the above descriptions, .	10	....	....
Total, . . . . .	257	606,563	11,758
<b>Ireland—</b>			
Factories employed in spinning,	25	10,780	....
Factories employed in weaving,	....	....	....
Factories employed in spinning and weaving,	25	30,076	307
Factories not included in either of the above descriptions, .	....	....	....
Total, . . . . .	60	40,856	307
<b>Grand total of woollen } factories, . . . . .</b>	1800	3,459,423	57,090

NUMBER OF OPERATIVES EMPLOYED.

	England and Wales.	Scotland.	Ireland.	Total.
<b>Males—</b> under 15, . .	4,391	579	7	4,977
" 15 to 18, . .	10,726	2,770	194	13,690
" above 18, . .	39,002	8,467	581	48,050
Total, . . . . .	54,119	11,816	782	66,717
<b>Females—</b> under 15, . .	2,841	446	2	3,289
" above 15, . .	48,411	15,466	723	64,599
Total, . . . . .	51,252	15,912	725	67,889
<b>Total, Males and } Females, . . . . .</b>	105,371	27,728	1,506	134,605

This does not give a full idea of the vast number of persons to whom this great industry gives employment, but only those engaged in spinning and weaving. A very large number are occupied in sorting and stapling, and other operations before the wool goes to the mills and factories, and also in dyeing and scouring it, either as wool or as woollen yarn and cloth; and in many districts much work is done by hand-loom workers in their cottages.

WOOLLEN AND WORSTED MANUFACTURES.

None of these come under the operations of the Factory Act, and are consequently omitted in the returns.

The imports of woollen and worsted yarns (not distinguished in the returns) have increased from 1861 to 1874 as follows: In 1861, 1,577,000 lbs.; in

1874, 13,131,850 lbs. The value of woollen cloths imported in the years 1861 and 1870 were respectively £119,654 and £343,634. In the annexed table, the exports of woollen and worsted goods are given for 1872, 1873, and 1874, and shew the prosperous state of the trade:

	1872.	1873.	1874.
Woollen and worsted yarns (lbs.), . . . . .	39,734,924	34,744,507	34,981,008
Woollen and worsted cloths, coatings, &c. (yards), . . . . .	385,703,913	321,518,525	301,466,767
Flannels, blankets, carpets, &c. (yards), . . . . .	36,830,023	24,368,413	25,798,899
Total value, . . . . .	£37,028,628	£28,977,755	£26,987,753

Although steadily advancing, yet the progress of the woollen manufacture has been less rapid and extensive than that of other textile fabrics, which is believed to be owing to its processes being more numerous and complex, to the greater variety of machines and of workpeople required, and to the high price of the raw material.

**Worsted Manufacture.**—Worsted yarn, as has been already said, is spun in a different way from woollen yarn. In the former, the fibres are arranged as parallel as possible; in the latter, they are crossed in every direction, so as to assist the felting or milling of the cloth. For worsted, the wool is first combed, which is still done by hand as well as by machinery. When done by hand, the wool-comber performs his work with a pair of combs, each containing two or three rows of steel teeth (fig. 1), which he uses in a heated state. The wool, after being previously oiled, is stuck on one comb, and the teeth of the other are then drawn through it, till the second comb transfers most of the wool to itself. The process is alternately repeated with each comb until the fibres are quite parallel. The dressed wool is then withdrawn, and is called the *top*; but there remains in the teeth of the comb some short



Fig. 1.

wool, called the *noil*, which is sold to the woollen-cloth makers. In this first combing, the wool is in a heated state, and requires to be combed a second time at a lower temperature.

The introduction of machines for combing wool has formed quite an epoch in the worsted trade. Previous to 1846, all the machines invented for this purpose were imitations of the hand process, and had the defect of producing too much short and too little long wool. In that year, Heilmann patented in England an ingenious machine, which was not, however, introduced till 1849. Lister's machine, introduced in 1851, was an improvement upon it; but the close resemblance led to a protracted litigation, which ended in the latter purchasing Heilmann's patent for £30,000. With the aid of the annexed diagram (fig. 2), Heilmann's machine will be understood by a brief description. The prepared wool is supplied to it at W, and passes down till a pair of nippers seize it at N, leaving a portion of the wool hanging down. A revolving drum or cylinder, D, then moves round till that portion of it shewn with teeth enters the overhanging wool, and combs it. The plain portion of the cylinder follows, and as it reaches the drawing-rollers at R', turns them by friction. These rollers lay hold of the combed wool, and then the nippers open, and press the uncombed portion up into the teeth of combs at C, C'. The drawing-rollers, still holding the tuft of wool, then pass, by a peculiar arrangement, from their position

at R to a lower one at R. Here the partially-combed wool gets a second combing from the cylinder, and passes off by rollers at S in a continuous sliver, which is accomplished by making one

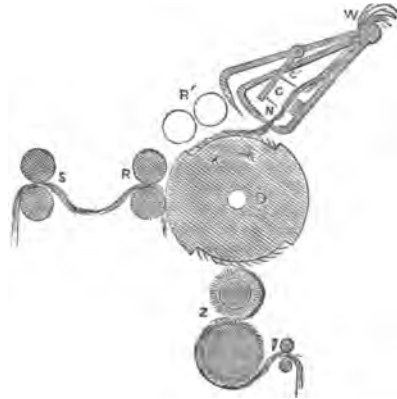

Fig. 2.

tuft of wool slightly overlap the one before it. Two card-rollers at Z remove the noils, or short wool, from the teeth of the cylinder.

Most of the later combing-machines are also patented, and descriptions of them will be found in the specifications of patents. We are not aware that a very decided preference has been given to any special one; and to describe them all, even in the briefest way, would lead us beyond our limits.

The remaining processes in worsted spinning closely resemble those for cotton, and are sufficiently described under SPINNING; but the following table, which merely enumerates the products of the various stages, may not be uninteresting: 1. Fleece (Lincoln wool). 2. Combed 'top.' 3. Noils, or short wool. 4. Sliver from first drawing-frame. 5, 6, 7, 8, 9, and 10. Slubbings from second, third, fourth, fifth, sixth, and seventh drawing-frames. 11. Roving from roving-frame. 12. Yarn No. 24 for the fancy trade, 10 7/8 drams per 560 yards. 13. Yarn No. 36 for de laines, &c., 7 1/8 drams per 560 yards. 14. Yarn for Coburgs, &c., 6 1/4 drams per 560 yards. Alpaca and mohair are combed and spun in a similar way to the worsted yarns from sheep's wool.

Those cloths manufactured from worsted yarns which are figured, are of course woven by various kinds of looms (see JACQUARD LOOM and LOOM); plain kinds are woven in looms similar to those used for woollens. When worsted goods leave the loom, they require only a superficial dressing, and in this respect differ much from woollen cloths, which we have seen require elaborate finishing processes.

Worsted stuffs are usually classified according to the materials of which they are composed, viz.: 1. Fabrics composed entirely of wool. 2. Fabrics

WOOLLETT—WOOLSACK.

composed of wool and cotton. 3. Fabrics composed of wool and silk. 4. Fabrics composed of wool, silk, and cotton. 5. Fabrics composed of alpaca and mohair mixed with cotton or silk. The first of these classes includes the fabrics so well known under the name of 'merinos,' and so called because they were first made of Spanish wool: for the 'double-twilled' kinds, the French still maintain their superiority; but for the 'single-twilled,' the Yorkshire makers are considered the best. This class also comprises shalloons, says, serges, lastings—all stout and heavy fabrics—besides durants, buntings, moreens, damasks, reps, Russells, camlets, and many others, both for dress and furniture. Mousseline de laine was, as its name implies, originally all wool, but it is now more generally mixed with cotton, and printed.

The second class includes two fabrics, of which the consumption for female dresses has been immense—viz., Coburg and Orleans cloths, the former being twilled, and the latter plain. Many of the names used in the all-wool class are retained in this, with the addition of the word 'union,' as union merino, union shalloon, union damask, &c. Winceys, now so popular for ladies' winter dresses, on account of their warmth, are made of wool and cotton, from yarns of a heavier and coarser kind than those used for cloths like Coburgs. Winceys are largely made at Aberdeen, Perth, Glasgow, and other places in Scotland, as well as in Yorkshire.

The third class includes the rich Poplins (q. v.) and Tabinets (q. v.), made chiefly in Dublin, and giving employment there to about 1200 hands. Paramatta or Henrietta cloth, Canton cloth, and others, are made both of silk and wool, and cotton and wool. Some Coburgs, Orleans, Russells, and Damasks are likewise made with silk warps.

The fourth class—viz., mixed goods, in which silk, wool, cotton, and sometimes linen are used—includes peculiar kinds of some of the fabrics named above, and also vestings, linings, cravats, shawls, scarfs, quiltings, boot and shoe cloths, barèges, &c.

The fifth class includes alpaca lustres and mixtures—plain, twilled, and figured; alpaca poplins, umbrellas and parasol cloth; mohair lustres, glacés, Verona serges, barèges, &c.

The term 'worsted' is said to have derived its origin from a village of that name in Norfolk, where this manufacture was first carried on. Up to the end of last century, worsted goods were a staple trade of Norwich; but the neglect of the factory system there led to its being transferred to Bradford, which has become renowned as the metropolis of the worsted manufacture. It is also extensively carried on at Halifax and other places in Yorkshire.

Like the woollen, some of the statistics of the worsted manufacture are not more recent than 1871, to which year the following tables apply:

NUMBER AND EFFECTIVENESS OF WORSTED FACTORIES.

Divisions.	Number of Factories.	Number of Spindles.	Number of Power-looms.
England and Wales— Yorkshire . . . . .	538	1,882,475	56,092
Other counties, . . .	61	176,401	7,151
Total, . . . . .	599	2,058,876	63,243
Scotland, . . . . .	28	71,556	1,201
Ireland, . . . . .	3	1,020	10
Total—United Kingdom, }	630	2,131,452	64,454

NUMBER OF OPERATIVES EMPLOYED.

	England and Wales.	Scotland.	Ireland.	United Kingdom.
Males—under 13, . . .	8,631	21	....	8,652
" 13 to 18, . . . . .	8,987	2,439	6	11,432
" above 18, . . . . .	22,841	6,055	24	28,920
Total, . . . . .	40,459	8,515	30	49,004
Females—under 13, . . .	9,608	40	....	9,648
" above 13, . . . . .	53,447	14,445	45	67,937
Total, . . . . .	63,055	14,485	45	77,585
Total, . . . . .	103,514	23,000	75	126,589

The same remarks apply here as in the case of the return of persons employed in the woollen manufactories, given under that head, and with still greater force, for there are a very great number of small trades connected with the worsted manufacture. As the numbers at the top of page 277 shew, the imports of both worsted and woollen yarns have greatly increased of late years, and is no doubt greatly owing to the ingenuity of the Belgians in spinning good yarns from cheap wools, Belgium being the country from which by far the greater portion comes. In 1874, woollen and worsted cloths to the value of about £4,000,000 were imported.

With respect to the exports, the following will shew the increase which has taken place from 1860 to 1874: 1860—Worsted yarn, 26,455,000 lbs. (£3,578,000); worsted stuffs, 148,685,000 yards (£7,013,000). 1865—Worsted yarn, 30,221,000 lbs. (£5,074,000); worsted stuffs, 233,078,000 yards (£13,361,000). 1874—Worsted yarn, 34,263,916 lbs. (£5,472,612); worsted stuffs, 261,135,081 yards (£11,888,072). For woven worsteds, the United States and France were our largest customers; Germany being also a large buyer.

The rapid increase of the worsted manufacture as compared with the woollen, is no doubt to be ascribed to the greater simplicity of the processes, to the recent introduction of combing-machines, but most of all to the introduction of cotton-warps in 1835, which not only cheapened the goods, but vastly increased their variety.

Information regarding such special branches of the woollen and worsted industries as carpets, shawls, hosiery, tartans, bonnets, &c. will be found under their separate heads. We may state here that the Scotch bonnet-trade, carried on at Kilmarnock and Stewarton, employs from 2000 to 3000 hands, and sends out about 500,000 bonnets annually.

WOOLLETT, WILLIAM, one of the most eminent of English engravers, was born in the year 1735 at Maidstone. He went early to London; studied his art under a practitioner of the name of Tinney, now only remembered as having taught him little or nothing; taught himself, however, a good deal, notwithstanding the aid of Tinney, and developing a manner of his own, soon became known as one of the most accomplished engravers of his time. In recognition of his merit, he was ere long appointed engraver to George III. As to his life, except as he is proved to have existed by his works, familiar at this day to every one, nothing is known. He died in London, in the year 1785, after a life of continuous and conscientious labour, as reward of which, a monument was erected to him in Westminster Abbey. His works, more especially in landscape, continue to be much prized by connoisseurs.

WOOLSACK, the name given to the seat of the Lord Chancellor of England in the House of Lords,

which is composed of a large square bag of wool without either back or arms, and covered with red cloth. The woolsack was first introduced in the House of Lords as the Chancellor's seat in the time of Elizabeth, as a memento of an act which was passed against the exportation of wool, that commodity being then the main source of the national wealth of England.

WOOLSTON, THOMAS, a heterodox divine of the English Church, equally remarkable for ingenuity and learning, and for the singularity of his opinions, was born at Northampton in 1669. He was educated at Sidney Sussex College, Cambridge; was elected a Fellow of his college; entered into holy orders, and in due course proceeded to the degree of Bachelor of Divinity. Gifted with a lively fancy, he became a diligent and appreciative student of the works of Origen, and by them seems to have been first imbued with a taste for the allegorical interpretation of the Scriptures. That he was disposed to carry this principle of interpretation much too far for his contemporaries, appeared at once from his first work, published in 1705. This was, *The Old Apology for the Truth of the Christian Religion against the Jews and Gentiles revived*. In this work, W. maintained that Moses was only an allegorical person, and all his history typical of that of Christ; that the miracles of the Pentateuch were allegorical, and the miracles attributed to Christ and the apostles pure allegory too; and he stigmatised as atheists and apostates all who received the Scripture narratives as literally, historically true. In subsequent publications, he went further in the same direction; also maintaining that the Quakers approached more nearly in doctrine and organisation to the primitive church than any other religious body; and denouncing clergymen, because they made a profession of the pastorate, as 'hiring priests,' worshippers of the Beast, and ministers of Antichrist. In 1721, he published *The Moderator between the Infidel and the Apostate*, dialogues tending to shew that the gospel miracles, by themselves, could not prove Christ to be the Messiah. This work occasioned great scandal: it abounded in expressions considered indecent and blasphemous; and it was only through the intervention of Whiston, who was friendly to him, and in favour of toleration in matters of opinion, that the author escaped a prosecution. Up to 1720, W. had continued to live in his college, leading a studious and blameless life, and shewing great kindness to the poor. In 1720, he went to live in London; and in 1721, his college, upon some pretext—really on account of the scandal made by his writings—deprived him of his Fellowship. The views set forth in the last-mentioned work, W. developed more fully in a series of six discourses during the years 1727, 1728, 1729, republished under the title *Discourses on the Miracles of Christ*. He maintained—representing himself, as in all his works, as the defender of true Christian doctrine—that Christ's miracles, in themselves, were open to the gravest doubts; that, in fact, the gospel narratives, if they were to be taken literally, were only a tissue of absurdities; and that the authority of the ancient church was against the literal, and in favour of an allegorical acceptance of them. These views were supported with a good deal of warmth, and mixed up with them were fierce denunciations of the order of clergy. The free-thinkers, both in England and on the continent, were now triumphantly quoting W. in their favour; and people who had previously been disposed to treat him as a maniac, whose rhapsodies were too wild to call for refutation, began to think it time to rescue the Christian faith from so dangerous and dubious a defender. No less than sixty answers were made to

the *Discourses*. Now, too—Whiston no longer intervening—an indictment, at the instance of the Attorney-general, was brought against W., on account of the blasphemous and irreligious character attributed to his works. He was tried before Chief-justice Raymond at Guildhall, found guilty, and sentenced to be imprisoned for a year, and to pay a fine of £100, and ordered to find securities to the amount of £2000 that he would not repeat his offence. He was imprisoned in the Queen's Bench Prison; and being unable to pay the fine, and both unable and unwilling to provide the requisite securities, the remainder of his life was spent within the rules of the prison. It was not long protracted. He died on the 27th January 1731. His death-bed scene has often been described as if it supported the supposition that W. was insane, but surely without good reason. It is stated that as he felt death approaching, he closed his eyes with his own fingers, saying to the turnkey who attended him, that he desired to die decently; and his last words were: 'This is a struggle which all men must go through, and which I bear not only patiently, but willingly.' His body was interred in the churchyard of St George's, Southwark.

WOOLWICH, a market-town and parish of Kent, the seat of the chief government arsenal of Great Britain, stands on the south bank of the Thames, about nine miles east of London. It stretches along the bank of the river for two miles, and reaches back from the river for half-a-mile, as far as the brow of the hill, where are the Royal Artillery Barracks and Hospital. The general appearance of the town has little to recommend it; but the southern suburbs are handsome and regular. There are numerous places of worship—established, Roman Catholic, and dissenting, and there are numerous schools, a theatre, &c. Its dockyard, its government manufacturing establishments for the production of matériel of war of every description (except gunpowder), and the fact that it is a great dépôt for naval and military stores, and also the headquarters of the great corps of Royal Artillery, combine to render W. a place of great importance. A royal dockyard existed here as early as 1515, and the *Henry Grace de Dieu*, which conveyed Henry VIII. to the Field of the Cloth of Gold, is said to have been built here, though this statement has been disputed. The *Royal George* (q. v.) was built here in 1751. The royal dockyard and ship-building establishment was, however, closed on the 1st October 1869. The yard comprised large dry docks, and a basin 400 feet long by 300 feet wide, and was furnished in every respect with the newest and most efficient apparatus. The Royal Arsenal, the largest in Britain, contains not only the largest stores of all kinds—shot, shells, cannon, &c.—which are required for our armies, navies, and forts, but it comprises also establishments for manufacturing them, and for constructing gun-carriages, and preparing ammunition for cannon and small-arms. These works are carried on in the three departments called respectively the Gun Factories, Carriage Department, and Laboratory. On the common, south of the town, is the Royal Military Academy, for the education of cadets destined for the Artillery and Engineers. Pop. of parish (1871), 35,557.

WOONSOCKET, a township of Rhode Island, U. S., on both sides of the Blackstone River, 16 miles north-by-west of Providence, on Providence and Worcester Railway, containing a central and several smaller villages, numerous cotton-mills, woollen-mills, machine-shops, iron-foundries, sash, blind, and planing mills, factories of thread, silk, gold pencil-cases, jewellery, musical instruments,



tin-ware, marble works, 7 churches, high school, and two newspapers. Pop. (1870) 11,527; (1875) 13,576.

**WOORALI POISON.** Since the original publication of the article *CURARI*, which is one of the synonyms of this substance, the physiological action of this fearful poison has been carefully studied by Drs Weir, Mitchell, and Hammond, of the United States; and the Essay in which their joint labours are recorded is published in Hammond's *Physiological Memoirs* (1863). This Essay is so valuable, and contains so much original matter regarding two other allied poisons whose native names are *Corroval* and *Vao*, that we shall give a brief abstract of its contents; premising that, for the best account of the history of this remarkable poison, the reader should consult Bernard's *Leçons sur les Effets des Substances Toxiques* (1857, p. 238). We shall notice the physical and chemical properties of this poison before describing its physiological action. The best of the earlier investigations of the poison is that of Roulin and Boussingault in 1823, who obtained from the crude 'woorala' an alcoholic extract, to which they gave the name of *curarin*. This curarin was a solid transparent mass, of an excessively bitter taste, and possessed in an eminent degree of all the virulence of the woorali. Heintz has subsequently examined the precipitate which tannic acid throws down from the watery solution of the



Woorali or Curari Plant (*Strychnos toxifera*).

poison, but only found that it contained no nitrogen, and was composed of apparently inert substances, as sugar, gum, resin, extractive matter, tannic and gallic acids, &c. He sought in vain for strychnine in it. Amongst the chief experimenters on the subject may be mentioned De la Condamine (*Mém. de l'Académie des Sciences*, 1745, t. 62, p. 391); Brocklesby (*Philosophical Transactions*, 1747, vol. xlv. p. 408); Herissant (*Philosophical Transactions*, 1751—1752, vol. xlvii. p. 75), who killed a bear with a poisoned arrow in less than five minutes; and nearly killed himself and a small boy who was evaporating an aqueous solution of the poison; both, however, recovered under the influence of fresh air, a pint of wine, and a quantity of sugar; Fontana (1781), who shewed that (notwithstanding the above experiment) the vapour is not deleterious, and that the state of the stomach at the time when the poison was inhaled modified the result, an animal with a full stomach being able to resist the action of a dose that would prove fatal to one of the same size when fasting; Brodie (*Philosophical Transactions*, 1811—1812); Virchow and Muntz (published in vol. i. of Schomburgk's *Reisen in Britisch Guiana*), who, inter

*alia*, shewed that the poison, even after being kept dry for five years, is still intensely active—that its physiological action corresponds with the result of analysis in shewing the absence of strychnine, and that it rather belongs to narcotic than to tetanic poisons—and that death takes place not from any direct result of the poison, but indirectly, by causing the cessation of the respiratory process; Bernard and Pelouze (*Compt. Rend.*, 1850, t. xxxi. p. 534); Vulpian (*Compt. Rend.*, 1854, t. i., 2d series, p. 73); and Kölliker (*Proceedings of the Royal Society*, 1857), who, amongst other important conclusions, arrives at the following: (1) That the *urari* (as he terms it) causes death very rapidly when injected into the blood or inserted into a wound; and that when introduced by way of the mucous membrane, its effects are slow, and require a large dose for their production; when applied to the skin of frogs, it is inoperative—(2) it acts through the blood, and destroys the excitability of the motor nerves, while the sensory nerves are hardly at all affected—(3) when artificial respiration is carried on in animals under its influence, many of the secretions are increased, owing to the paralysis of the vascular nerves, and the consequent dilatation of the vessels—(4) that in mammals, the poison causes death by the paralysis of the respiratory nerves and suppression of the respiration, which brings on convulsions as a collateral effect.

The late researches of Weir, Mitchell, and Hammond, on the two hitherto undescribed varieties of the poison, named *Woorara*, variety *Corroval*, and *Woorara*, variety *Vao*, lead to the following results. The *corroval*, which is asserted to be the strongest arrow-poison, but of whose mode of manufacture they could learn nothing, was in large lumps of a brownish black colour, resembling vegetable extracts of that tint. From its aqueous solution they obtained a substance possessing all the qualities of an alkaloid, and in an eminent degree the poisonous properties of the *corroval*, to which they assign the name *Corrovalia*. Hence it differs materially in its chemical composition from ordinary woorali. From a large number of experiments on living birds, mice, cats, frogs, and alligators, they find (1) that *corroval* differs essentially from any variety of woorali hitherto described in its physiological results; (2) that it acts primarily on the heart through the medium of the blood, producing an arrest of the heart's action; (3) that the annihilation of voluntary and reflex movements is a secondary result of its action, depending primarily on the cessation of the heart's action; (4) that it acts upon the nerves from the surface to the centre, and abolishes both the sensory and motor functions; (5) that it destroys muscular irritability; (6) that it paralyzes the sympathetic nerve, this being one of its primary effects; (7) that it is absorbed both from the intestinal canal and skin of frogs; and (8) that its poisonous effects are due to an alkaloid hitherto undescribed. The authors devote 42 pages to a history of their experiments on *Vao* or *Bao*; but as they are of opinion that *vao* is only a weaker variety of *corroval*, it is unnecessary to follow their researches in this direction. It is obvious that in *corroval* and *vao* we have a fearful poison, quite distinct from ordinary woorali; and we have entered into further detail on this subject than we should otherwise have done, because, so far as we know, they have not yet been noticed by any English author.

**WOOTZ** is a finely damasked hard cast steel, which is obtained from India. Faraday found aluminium in a sample which he analysed, and referred its peculiar properties to the presence of this metal; but other chemists have failed in finding aluminium in wootz.

## WORCESTERSHIRE—WOROESTER.

**WORCESTERSHIRE**, one of the west-midland counties of England. The conterminous counties are those of Warwick and Stafford on the N., Warwick and Oxford on the E., Gloucester on the S., and Hereford and Salop on the W. Area, 472,453 acres, whereof about 400,000 are cultivated. Its greatest length is 38 miles, and greatest breadth, 26. The surface is undulating, and there are depressed valleys and hilly ranges; two of the latter are of considerable extent, and adorn its eastern and western sides. On the west, the range terminates in the Malvern Hills, one of the highest points of which is the Worcestershire Beacon, about 1100 feet above the level of the sea. Its name is derived from its shape, a cone towering beacon-like above the lesser eminences of the chain; but the highest peak of the range is named the Herefordshire Beacon, which stands within the county of Hereford. The eastern range is the Bredon Hills, which form part of a chain extending from Bromsgrove Lickey, near Birmingham, to the Cotswold Hills, near Gloucester. The county is well watered, and finely timbered, especially with fruit-trees. The elm grows very luxuriantly, and indeed is so common in every corner as to have obtained the name of 'the weed of Worcestershire.' The oak, beech, and other timber trees thrive well, and of late the larch has been much planted. The principal rivers are the Severn, the Teme, and the Avon. Other streams there are, such as the Stour, the Salwarp, &c., but except in flood-times, these are mere brooks, and scarcely deserve the name of river. The Severn is navigable for vessel of 80 tons as high as Worcester, and for those of 60 tons to Stourport, 14 miles farther; and smaller boats can reach Shrewsbury, the river being navigable for 180 miles. There are three canals communicating with the Severn—viz. the Staffordshire and Worcestershire at Stourport; the Droitwich, a little way above Worcester; and the Birmingham and Worcester, in the immediate neighbourhood of the city. The W. portion of the Vale of Severn is about 30 miles long; the climate is mild and healthy; but the rainfall is comparatively small, and nearly the minimum of England. There are mineral springs at Malvern, Evesham, Dudley, and Kidderminster. Nearly the whole of the county is on the red sandstone formation, but the Malvern and Lickey Hills are of igneous origin. The soil consists of almost every variety suitable for vegetation, from strong deep clay and rich vegetable mould, to light friable sandy rye-land, with tracts of alluvial deposit, marl, and loam. The Vale of Evesham is dependent on the Avon for its fertility, which has long gained for it the reputation of being the garden of the mid-west. It produces abundance of table-fruit, and vegetables of the finest quality. The agriculture of W. has been greatly improved during the last thirty years, and high-farming is now much in vogue. Excellent crops of wheat and other grains, turnips, and potatoes are raised; a large portion of the land remains in the form of meadow, and much of it ancient pasture.

Hop-gardens are plentiful in the western division of the county, and their produce ranks, in the estimation of brewers, next to that of East Kent. W. is *par excellence* a perry county, as Herefordshire and Devonshire are cider counties. Its pear orchards are very beautiful in the time of blossom; and there is a splendid variety, called the 'black pear of Worcester,' which attains a great size, and is supposed to be the traditional pear blazoned on the county's shield of arms.

There is no distinctive local breed of stock, either cattle or sheep. The cattle in most favour are Herefords and Shorthorns; and among sheep, the favourite varieties are Shropshire Downs, Leicesters,

Cotswolds, and cross-breeds. Pigs are abundantly bred and fed. The markets are well supplied with butcher-meat, bred and fed in the county; and London, Birmingham, and the 'Black Country' draw large supplies from Worcestershire. Poultry are raised in considerable quantity, and the W. farmer's wives have deservedly obtained a good name for the condition and neatness in which they are sent to market. The county possesses great mineral wealth in coal, iron, salt, lime: the first three are found in the north-eastern quarter of W., but lime is very generally distributed. Coal and iron mines are largely worked in the neighbourhood of the populous borough of Dudley. Iron-works abound between it and Stourbridge, where glass manufactures of an ornamental character, on a large scale, have taken root; and there are abundance of coal-mines in the neighbourhood. Quarries of limestone are largely wrought near Evesham and Pershore.

The textile fabric manufactures are nearly confined to carpet-weaving, which has long been carried on successfully at Kidderminster; but the town has almost ceased to produce that description of goods known by its name, 'Brussels' and 'tapestry' being principally manufactured. At and in the neighbourhood of Worcester a considerable number of persons are engaged in glove-making. W. china, which has gained a world-wide reputation, is also produced upon a large scale in the capital city. At Redditch, the needle and fish-hook manufacture is carried on to a greater extent than in any other place in England; nail-making has been practised for centuries at Bromsgrove; and at Droitwich, about six miles from Worcester, salt has been manufactured for many centuries from an inexhaustible supply of brine. Pop. (1871) 338,837, of whom about 200,000 are connected with mines and manufactures, and the remainder are engaged in agriculture, or dependent on trade. The county is in the Oxford circuit, and in the district of the Birmingham court of bankruptcy. W. possesses a county regiment of militia, consisting of 850 officers and privates; also the Queen's Own Regiment of Worcestershire Yeomanry Cavalry, 700 sabres; and the Worcestershire Regiment of Rifle Volunteers, comprising two battalions, each about 800 strong. The county sends four knights of the shire to parliament, and six members for the boroughs of Evesham, Kidderminster, Droitwich, Dudley (one half of which is in Staffordshire), Bewdley (and Stourport united), besides two for the city—making a total of twelve members from Worcestershire.

**WOROESTER**, a city, capital and assize town of the county of the same name, and a county of itself, stands almost in the centre of the Severn Valley, and is situated principally on the eastern bank of the river, about 26 miles south-west from Birmingham. W. is of great antiquity; there are abundant traces of ancient iron-smelting works on the banks of the river, adjudged by antiquaries to belong to the times of the Roman occupation; and the frequent discovery of other remains proves that the city was a Roman station. The chief object of antiquity now existing is the cathedral, which is beautifully placed on a gentle elevation on the east bank of the river, and stands within its own precinct, but which, since the passing of the act abolishing the isolation of 'peculiars' and 'non-parochial places,' has been incorporated in the city parish of St Michael. A cathedral, dedicated to St Peter, was founded here as early as the 7th c. In 1084, Bishop Wulstan laid the foundation of a new cathedral, many portions of which remain in the present structure, such as the crypt (one of the oldest and most interesting in England), the bases of

and fragments in many of the walls, chapter-house, refectory, and cloisters. In the Civil Wars, much damage was done to the building, but none of its leading features were destroyed. It is now distinguished by the simplicity, if not plainness, of the exterior, but which is amply compensated by the fine perspective, the lofty roof, and generally charming effect of the interior. A thorough restoration, now practically completed, was commenced some years ago, and the works have cost nearly £60,000. The tombs of King John, and of Arthur, Prince of Wales (eldest son of Henry VII.), are the chief ancient monuments in the building. The Episcopal Palace in the city has been transformed into the Deanery; and the bishop of W., since the ecclesiastical commissioners assumed the management of the episcopal and capitular estates, has his residence at Hartlebury Castle. The bishop of W.'s revenue has been fixed by the ecclesiastical commissioners at £5000; and the livings in his gift are numerous and of considerable value. Worcester chapter consists of the dean, 4 canons, 24 honorary canons, and 4 minor canons, including the precentor. Besides 10 chorister boys, there are 40 other boys on the foundation at the College or Cathedral School, who receive gratuitous education, and about 60 non-foundation boys. There is also a city Grammar School, founded by Queen Elizabeth, and largely attended. The parish churches of the city, eleven in number, are poor specimens of architecture. The city does not shine in public buildings. Next to the cathedral, the most important are the Shire Hall, the Guildhall, and the county prison; but there are also the city library, the W. Museum, a corn-exchange, and music-hall. The battle of W., fought in 1651, is memorable in history, and Charles II., to commemorate the fidelity of the citizens to his cause, granted the motto to the city arms: 'Civitas in bello et in pace fidelis.' Pop. of the city (1871), 38,116. The people are employed in glove-making, including leather dressing and staining; in porcelain factories; iron-works, including locomotive-engine factories; tanning and currying, horse-hair weaving, vinegar, British wine and sauce making, and coach-building. Chemical manures and agricultural implements are also manufactured on a considerable scale. Glove-making is still considered the staple manufacture of the city; but one large factory has absorbed a large portion of the business, and now there are not above two dozen of master-glovers, great and little, whereas 40 years ago there were nearly 100 in the trade. There are two porcelain factories, and the number of hands employed by them in all departments is about 400. The Royal Porcelain Works are celebrated for fine taste in designing, and the beauty of execution of the highest class of productions; while the specialty of the other factory, Messrs Grainger & Co.'s, is utility, combined with purity of design and excellence in workmanship. They are celebrated for their semi-porcelain, which is so excellently glazed as to resist the strongest acids. The city is one of the chief stations on the Midland (Birmingham to Bristol), and Great Western (London to Birkenhead) Railways, and there are also branches to Hereford, South Wales, &c. W. sends two members to parliament, and is governed by a corporation consisting of a mayor, 12 aldermen, and 36 councillors. It has also a recorder and sheriff.

WORCESTER, a city of Massachusetts, U. S., the centre of a fine agricultural district, 45 miles west-south-west of Boston, with several diverging railways, in a valley surrounded by beautiful hills, with delightful sites for residences, broad shaded streets, and famed for its political and philanthropical conventions. Among its institutions

are, the American Antiquarian Society, with a library of 50,000 volumes, and cabinet; the State Lunatic Asylum, which, in 13 years, out of 2306 patients, discharged 1000 cured; Oread Institute, for young ladies; high, grammar, intermediate, and primary schools, considered the model-schools of New England; also, manufactories of cotton, woollen, carpets, hollow-ware, pistols, wire, paper, saddles, locks, musical instruments, &c. There are 30 churches, 12 periodicals, 3 daily. Pop. (1875) 49,265.

WORCESTER COLLEGE, OXFORD, was founded, like Trinity and St John's, on the site of an old monastic college. The ancient institution was known by the name of Gloucester College, because it belonged to the Benedictine Monks of that city. After the dissolution of the monasteries, it passed through various hands; and latterly, was a Hall attached to St John's College. In 1701, however, Sir Thomas Cookes left £10,000 for the purpose of endowing some existing College or Hall. This bequest led to the erection of Gloucester Hall into a College, for a provost, six fellows, and six scholars, by letters-patent of Queen Anne, 1714. Various fellowships and scholarships were afterwards added, until the number of fellows became 21, of scholars 16, but almost all restricted to certain counties, or to founders' kin. The Commissioners under 17 and 18 Vict. c. 81 reduced the number of fellowships to 15, open without restriction, except that candidates for a fellowship on the Eaton foundation must be sons of clergymen of the Church of England and Ireland, and must not be possessed of property or income exceeding £150 a year. The scholarships are now 16 in number—six on the foundation of Sir Thomas Cookes, for persons educated at Bromsgrove School; one on the foundation of Dr Finney, for natives of Staffordshire; five on the foundation of Mrs Sarah Eaton, for sons of clergymen of the Church of England; and three on the foundation of Dr Clarke, and one on the foundation of Robert Barnes, Esq., which are entirely open. Most of the scholarships are of the value of £75, tenable for five years. There are also seven exhibitions—four on the foundation of Sir Thomas Cookes, value £42 a year, for persons educated at Bromsgrove School. There are ten benefices in the gift of this College.

WORD, in time of peace, a signal notified in the orders of the day, in virtue of a knowledge of which a sentry will allow the utterer to pass. In the field, the officer commanding fixes daily upon a word and countersign (for which any arbitrary terms are taken), and communicates them to the sentries on guard, and to such other persons only as he may choose to permit to pass through the lines. Any person then approaching a sentry without knowing the word, has a fair chance of being shot; if he knows not the countersign, the sentry will take him into custody, and deliver him to the officer of the guard. Care has to be taken that the 'word' should not suggest the 'countersign.' Any arbitrary combination is therefore adopted.

WORDSWORTH, WILLIAM, a distinguished English poet, was born on the 7th April 1770, at Cockermouth, in Cumberland. He was the second son of John Wordsworth, attorney, and agent on the estates of the first Earl of Lonsdale. He was sent to school at Penrith, where his parents had gone to reside; and after the death of his mother in 1778, was transferred to Hawkshead, in Lancashire, at the public school of which his earlier education was completed. In 1783, his father died, leaving his family in some difficulty. By Lord Lonsdale, a considerable sum was due to them; but his Lordship, a man of most eccentric character, saw fit to

resist the claim, with all the vexatious impediments which the law so plentifully affords. Enough, however, remained, with some little assistance from relatives, to carry forward the education of the children. W. remained at Hawkshead till 1787, in which year he was entered at St John's College, Cambridge. Here he remained four years. In the studies proper to the place, his interest was slight; but in his own fashion he was a diligent student; and poetry became more and more his favourite pursuit. In January 1791, he left Cambridge, after taking his degree as Bachelor. During the autumn of the previous year, he had, along with a fellow-student, made a pedestrian tour through France, then in the early fervours of its great Revolution; and thither, after leaving college, he returned. His sympathy with the aims of the Revolution was passionate; and with the party of the Gironde he seems to have cultivated relations of a somewhat intimate kind, which, in the end, might have seriously compromised him, had not circumstances, probably of the pecuniary sort, determined his return to England some little time before his friends were sent in a body to the scaffold. The republican principles which at this time he held, he lived to renounce in favour of a reasoned conservatism; and opposed as he was, in its earlier stages, to the war waged against France, no one more patriotically urged it, when the struggle became in effect a life and death grapple on the part of England with the military despotism of Napoleon.

In 1793, W. came before the public as an author, in two poems, entitled *An Evening Walk, addressed to a Young Lady*; and *Descriptive Sketches, taken during a Pedestrian Tour among the Alps*. These pieces abound in touches of refined and original observation of nature, but otherwise are not in themselves specially remarkable; and they failed to make any impression, except on a few minds, such as that of Coleridge, then at Cambridge, who afterwards professed to have discerned in them the seeds of a great undeveloped genius. W. was now in a position of much perplexity; his little finances were almost entirely exhausted; for the church, which his friends would fain have had him enter, he had at this time an obstinate aversion; poetry had become with him a passion, to which he longed to wholly dedicate himself; and unhappily it appeared that his poetry would not in the least pay. As a poet cannot live like a singing-bird by pecking about the hedgerows, it became necessary for him to bethink himself of some means of support; and he was on the point of proceeding to London, to do liberal politics for the newspapers, when unexpected relief came to him in the shape of a legacy. The name of Raisley Calvert deserves to be remembered with that of Wordsworth. An intimate friend of the poet, he had formed a high opinion of his genius; and at his early death in 1796, he was found to have bequeathed to W. the sum of £900, expressly that leisure might for some years be allowed for the undisturbed development of his powers. Seldom has money been better bestowed; and small as the sum may seem, to a man of the poet's simple tastes and entire singleness of aim, it could suffice over a term of years. With his only sister, Dorothy, his attached companion through life, and always a devout believer in the brother, no little of whose genius she shared, he now settled himself at Racedown Lodge, in Dorsetshire, removing in 1797 to Alfoxden, in Somersetshire, in order to be near Coleridge, who had established himself some three miles off at Nether-Stowey. Out of the intimacy thus begun, came the famous *Lyrical Ballads*, published in 1798 by Cottle of Bristol, as a joint adventure of the two poets. The volume had

no success; but probably no man ever lived more serenely self-appreciative than W.; and he did not allow himself to be disheartened by the neglect meantime of the world. After a short tour in Germany, along with his sister and friend, he returned to his native Cumberland, which he never again permanently left. He settled himself first at Grasmere; in 1808, he removed to Allan Bank, in the vicinity; and in 1813, he transferred his household to Rydal Mount, the place which, of all others, remains specially associated with his memory. On the death of the old Lord Lonsdale, the justice of the claim of the Wordsworths against the estates was admitted; and in 1802, a sum of about £8000 was by his successor made over to the family. To W. and his sister, their moiety of the money may have been acceptable, as by this time, one should say, they must needs have been seeing pretty nigh to the end of Raisley Calvert's convenient £900. Henceforth, a modest competence was secure to them; and W. was wedded within the year to Mary Hutchinson, a cousin of his own, with whom he had been intimate from his childhood. In 1813, by the kindness of Lord Lonsdale, he was appointed Distributor of Stamps for the county of Westmoreland, a situation which brought him, without much to do for it, a salary of £500 a year. When, the year after, he published his great poem, *The Excursion*, he dedicated it to Lord Lonsdale, in a sonnet, expressive of 'high respect and gratitude sincere' for this comfortable increase to an income sufficient, perhaps, but certainly not excessive, for a man who had now a family growing up round him. Meantime, and pending the appearance of this elaborate work, the reputation of the poet had been surely, if slowly rising. In 1800, he had published, in two volumes, a second edition of the *Lyrical Ballads*, disjoining his own from those of Coleridge, and adding a quantity of new matter; and in 1802 and 1805, further editions had been issued. To these succeeded, in 1807, a new collection, under the title of *Poems, in Two Volumes*. In these earlier writings, there was a good deal which almost wilfully seemed to invite ridicule; and for a good while, W. was merely the laughing-stock of reviewers, more particularly of Jeffrey, who, as editor of the great *Edinburgh*, at this time figured as chief Aristarochus of the day. The more to popularise the ridicule, a nickname was invented; and 'the Lake School,' as it was called, which, with W., included Coleridge and Southey, who chanced to reside in the same district, passed current as an easy name of scorn. It could not be long concealed, however, that these volumes of W., despite an occasional eccentricity in the choice of mean and impracticable subjects, contained a large body of true poetry of a singularly fresh and original kind. A select circle of passionate admirers, including men like Leigh Hunt, De Quincey, and Wilson, eagerly pressed the true claims of the poet; and after the publication of the *Excursion*, a volume of high and serious verse, gravely defective in plan, and at times heavy and tedious, but with little or no trace in it of the earlier oddities of the writer, it came more and more to be felt that the laughers were getting the worst of it, and that W., however he might now and then indulge himself in whimsical tricks, was really a man of true and lofty genius, against whom ridicule could not permanently avail. Their occupation was not yet, indeed, quite gone; and the subsequent appearance, in 1819, of *Peter Bell*, a poem not without profound merits, but unhappily with a donkey for the hero of it, allowed them to resume their advantage a little. But, on the whole, the day of idle jeer was over; the tide of genuine

appreciation had set in, and it continued to flow steadily, till, long before his death, W. found himself recognised almost *nem. con.* at the head of the poetical literature of his country. His later days were passed serenely in honour. In 1839, the university of Oxford conferred on him its honorary degree of D.C.L. In 1842, a pension of £300 per annum was assigned him by government; on receipt of which he ceded, in favour of his son, his situation as Distributor of Stamps; and on the death of his friend Southey, in 1843, he succeeded to the vacant laureateship. On the 23d April 1850, he peacefully closed a life so pure, serene, and priest-like in its consecration to a lofty purpose, that we must go back to Milton in order to find its parallel. It remains only to enumerate the publications of W. not included above. In 1815, appeared *The White Doe of Rylstone*, which was followed by *The Waggoner*, and a series of *Sonnets on the River Duddon*. In 1822, he published a volume entitled *Memorials of a Tour on the Continent*; some years after, his *Ecclesiastical Sonnets*; and in 1835, *Yarrow Revisited, and Other Poems*, the fruit of a tour to Scotland, memorable by his mournful parting, at Abbotsford, with the dying Scott, which he records in a beautiful sonnet. In 1842, he issued a collected edition of his works, rearranged as we now have them, in a somewhat fanciful fashion of his own. Shortly after his death, a long autobiographical poem, in blank verse, was published, entitled *The Prelude*.

By remanding it to truth and simplicity of natural feeling as its basis, W. did more than perhaps any other writer of his time to forward the great revival of English poetry which distinguished the opening of the century. But he was scarcely the originator of the movement; the new influence was, so to speak, 'in the air;' already Cowper in England, as in Scotland Burns, had preluded to the melodious outburst which was to follow; and to the last of these more particularly, as his early guide and exemplar, W. has expressly recorded his obligations in a stanza which, so far as we are aware, has hitherto escaped quotation:

'I mourned with thousands, but as one  
More deeply grieved, for he was gone  
Whose light I hailed when first it shone,  
And shewed my youth  
How verse may build a princely throne  
On humble truth.'

With the charm of natural simplicity of manner, common to him with these his predecessors, W., however, combined a depth of philosophic meditation peculiarly his own; there was born with him, moreover, a passionate susceptibility to effects of beauty in the material world, such as few men can ever have been gifted with; and out of these blended elements arose that mystical communion with Nature which pervades the whole body of his poetry, and constitutes its truest claim to originality. By diffusion of this, and otherwise, his influence on our subsequent poetry has perhaps been as profound as any of the kind ever exercised, and it has been almost wholly beneficial. Yet we need not admire all we find in him. The early ridicule directed against him, though it sinned by excess and disproportion, was really to a great extent deserved. Had he gone on writing nothing but the 'Betty Foy's' and 'Alice Fells' which Jeffrey laughed at, we should not have had in this place to do a biography of him. It is despite of a good deal of this kind of perverse drivel, besides indifferent matter otherwise, and not in the least because of it, that he continues, and must long continue, to be remembered.—See *Memoirs of*

*William Wordsworth*, by Christ. Wordsworth, D.D.

**WORK.** To do work is to overcome resistance. If we try to lift a ton-weight, however we may fatigue ourselves, we cannot move it, and therefore we do no work. But we can lift with ease a hundred-weight, and then we do more work in proportion as we raise it higher. In lifting coals from a pit, the work done is evidently in proportion to the depth of the pit, and to the weight of the coals raised. This and numberless other instances are too well known to need further description. We may therefore at once define the work done by a force as the product of the force into the space through which it moves its point of application in its own direction, and it is usually measured by engineers and others who do not require absolute accuracy, in foot-pounds, the work required to raise a pound one foot high. If the motion of the point of application be in the opposite direction to that of the force, the work is done against the force. If the motion be perpendicular to the direction of the force, no work is done by or against the force. Thus, the work spent in projecting a curling-stone, in opening a massive gate, or in turning a large fly-wheel or grind-stone, has nothing whatever to do with the force of gravity—the body moved, in all these cases, is, as a whole, neither raised nor lowered as regards its distance above the earth's surface. If the direction of the force be oblique to the direction in which the point of application moves, we must resolve the force, by the law of the Parallelogram of Forces (see COMPOSITION OF FORCES), into two components, one in the direction of motion, the other perpendicular to it. The former is the working component; the latter, as we have just seen, does no work. A good illustration of this is found in the case of raising stones from a quarry by carting them up a series of inclined planes, as contrasted with hauling them up vertically. The work done in either case is measured by the product of the weight of the stones, and the height through which they have been raised; and thus, for the same load of stones, it will be the same whichever process is adopted. This is evident from the property of the inclined plane—viz., that the force required to support a body resting on the plane (which is the force that has to be overcome when we haul it up the plane) is to the weight of the body as the height of the plane to its length. Hence, this force, multiplied into the length of the plane, gives the same product as the whole weight into the height of the plane; and these are the two quantities of work we are comparing.

When work is done upon a body, there is always an increase of velocity, unless other forces act on the body, so that it does an equal amount of work against them. Thus, if we push a movable body, such as a cart, along a road, the velocity gradually increases, and would increase indefinitely were there no friction and no resistance of the air (forces against which work has to be done), and could we move fast enough to keep continually pushing it, however great its velocity may become. If, on the other hand, by means of a rope and pulley, we raise a stone, if once started, it will ascend uniformly, so long as we pull with a force just equal to its weight, because, then, as much work is done on the stone by the hand as it does against gravity. If we pull with a force greater than its weight, we do more work on the stone than it does against gravity, and the upward velocity increases; if with a force less than the weight, the stone has to do more work against gravity than is done on it by the rope, and its velocity upwards becomes less. The measure of the excess of work done on a body over that which

**WORK.**

it does against resistance is the increase of the product of half the mass into the square of the velocity—i. e., of what was formerly called the *Vis-viva* of the body, what is now called its *Actual*, or preferably, its *Kinetic Energy*. See FORCE. Hence, as it is evident that if a body, or system, be acted on by a set of forces which are in equilibrium, it will have no tendency to lose or to acquire velocity, its kinetic energy will remain unchanged, and therefore as much work must be done upon it by some of the applied forces, as it does against the rest, in any displacement so slight as not to change the circumstances of the particular arrangement. That is, when forces are in equilibrium on a body, if the body be slightly displaced, the sum of the products of each force by the effective component of the displacement of its point of application is zero—the product being positive when the force does work, negative when work is done against it. This is the celebrated principle of *Virtual Velocities*, the term virtual velocity having been, very inconveniently, applied to what we have called above the effective component of the displacement of the point of application of a force. It was often employed as the basis of the whole of Statics, and very curious attempts

have been made to give proofs of it (independent of the laws of composition of forces), especially by Lagrange. But the principle of Work, or Energy, of which that of Virtual Velocities is a mere particular case, and which is at once applicable to the whole range of Dynamical Science, is distinctly enunciated by Newton in a Scholium to his Third Law of Motion. See MOTION, LAWS OF. His words are memorable, and should be universally known—*Si aestimetur agentis actio ex ejus vi et velocitate conjunctim; et similiter resistentis reactio aestimetur conjunctim ex ejus partium singularum velocitatibus et viribus resistendi ab earum attritione, cohesione, pondere, et acceleratione oriundis; erunt actio et reactio, in omni instrumentorum usu, sibi invicem semper aequales*. Newton has defined what he means by the velocity of an agent—viz., the component of the velocity of its point of application which is in the direction of the agent. He has also shewn what is the measure of resistance arising from acceleration (see VELOCITY); so that, merely using modern terms instead of those employed by Newton, but in no wise altering the scope of the above remarkable passage, we have the following version of it: *Work done upon any system of bodies* (literally, *the parts of any*

DESCRIPTION OF WORK.	Weight raised.		Velocity per Second.		Units of Work per Second.		Length of Working Day.		Total Work in a Day.	
	Lbs.	Feet.	Lbs. x Feet.	Hours.	Lbs. x Feet.	Hours.	Lbs. x Feet.			
A man mounting an easy staircase, or an incline, without a load, his work consisting simply in moving the weight of his own body,	143	0.5	71.5	8	2,059,200					
A man raising weights by means of a cord and pulley, which renders necessary the return of the cord without a load,	39.6	0.66 {say 0.67	26.53	6	578,048					
A man raising weights by his hands,	44	0.56	24.64	6	832,224					
A man carrying a weight on his back up an easy incline, and returning without a load,	143	0.18	18.99	6	401,544					
A man raising materials by a wheel-barrow, on an incline of 1 in 12, returning unloaded,	132	0.066 {say 0.67	8.58	10	308,880					
A man throwing earth by a spade a height of 5 feet 4 inches,	5.94	0.66 {say 0.67	3.98	10	148,280					
A man working a pin-wheel or a drum—										
1st, at the level of the axle,	132	0.5	66	8	1,908,960					
2d, at bottom of wheel,	264	2.24	61.8	8	1,779,840					
A man walking and pushing, or drawing horizontally, in a continuous manner,	36.4	2	52.8	8	1,520,640					
A workman acting upon a winch,	17.6	2.5	44	8	1,267,200					
A workman pushing and pulling alternately in a vertical direction,	15.2	2.5	39	10	1,044,000					
A horse harnessed to a carriage going at a walking pace,	154	3	463	10	16,432,000					
" " " " " " " " " at a trot,	96.8	7.22	699	4.5	11,322,800					
A horse in a mill, at a walking pace,	99.0	3	297	8	8,558,600					
" " " " " " " " " at a trot,	66.0	6.56	433	4.5	7,014,600					
An ox in a mill, at a walking pace,	122	2	244	8	7,608,200					
Mule " " " " " " " " " " " "	66	3	198	8	5,702,400					
Donkey " " " " " " " " " " " "	30.8	2.67	82.24	8	2,368,612					

machine) has its equivalent in work done against friction, molecular forces, or gravity, if there be no acceleration; but if there be acceleration, part of the work is expended in overcoming the resistance to acceleration, and the additional kinetic energy developed is equivalent to the work so spent.

When work is expended in overcoming the resistance to acceleration, i. e., the *Inertia* of a body, we have its equivalent in additional kinetic energy. When it is expended against gravity, as in raising a weight or bending a spring, we have it stored up in a dormant form as *Potential Energy*. See FORCE. When it is expended in overcoming friction, there appears at first sight to be no equivalent—but the comparatively recent researches of Joule (q. v.) and others have satisfactorily accounted for its disappearance, by proving its quantitative transformation usually into heat, sometimes into other forms of molecular energy. But to pursue this point would lead us again to questions already treated at some length in the article FORCE. There is one remark, however, which it is important to make. In

compressing a gas, in the receiver of an air-gun for instance, we can never recover as useful effect all the work expended. The reason is, that a gas is heated by compression, so that part of the work spent is converted into this heat, conducted through the metal, and by the principle of *Dissipation of Energy* lost, at least in part, to man. Had we a gas which could not be heated by compression (take the imperfect analogy of a space filled with fine spiral springs), we should recover, by allowing it to expand, all the work expended in the compression.

One other remark remains to be made. It will be noticed that Newton speaks of the action of an agent as the product of the agent and the component velocity of its point of application. This is what we now call *Rate of doing Work*, or *Horse-power*. Watt estimated a horse-power at 33,000 foot-pounds per minute, or 550 foot-pounds per second. This is probably too high; but it is constantly employed in engineering calculations. A curious quantity, sometimes employed as regards

## WORK—WORKHOUSE.

steam-engines, especially those employed for pumping mines, is the *duty*, which is measured by the number of foot-pounds of work done by a hundred-weight of coals supplied to the furnace. A similar mode of comparison is now applied to steam-engines for agricultural purposes, &c.

The quantity of work which can be got out of any machine, human, animal, or other, depends in many cases on the rate at which it is done, or the horse-power actually exerted. An average man can easily work at the rate of a horse-power for a few minutes at a time; but if he were to work at no other rate, he would do very little work in a day. Various singular investigations have been made, both theoretically and experimentally, as to the most profitable rate of doing work, and their results are highly interesting. But to discuss them properly would require more space than we can afford. The table on preceding page, due to Poncelet, gives at least approximate notions of the horse-power employed, and the whole work done, in a working-day, by men and animals variously applying their exertions.

**WORKHOUSE**, the name given to municipal institutions, in England, in which paupers are supported and maintained. The earliest mention of them is to be found in stat. 13 and 14 Car. II. c. 12, authorising workhouses to be erected in the cities of London and Westminster, to which rogues and vagabonds might be committed, by any two members of the 'Workhouse Corporation,' a Board created by the act, with the view of restraining them from predatory habits, and compelling them to work for their living. The provisions of this act were, for the first time, carried into effect in the reign of William and Mary, when a corporation, headed by the Lord Mayor of London, fitted up a house in Bishopsgate Street as a workhouse, one part of which, called the Keeper's Side, was devoted to the purpose contemplated by the act of Charles II.—viz., the reception of vagrants and disorderly persons, committed by two governors; while, in the other part, called the Steward's Side, poor children were lodged, and taught various employments and branches of education. A very few workhouses were afterwards erected by local acts; but their general adoption throughout England was first provided for by act 9 Geo. I. c. 7, by which the churchwardens and overseers of the poor, in any parish or town, were empowered, with consent of the majority of the inhabitants, to establish a workhouse, where the poor were to be lodged and maintained. Two or more parishes might unite in having one workhouse, and one parish might contract for the maintenance of its poor in the workhouse of another. Under this statute, buildings began to be erected and hired all over the country, with great zeal for workhouses, in which the whole poor were housed, industrious and profligate alike. Out-door relief, which had been prohibited by the above statute, was reintroduced by 36 Geo. III. c. 23, and before long, became the rule under a variety of systems, by which assistance was carried so far as to be a bounty on indolence. The poor-rates rose immensely, and it became the subject of general complaint, that the able-bodied out-door pauper enjoyed a degree of comfort which destroyed all stimulus to exertion. The result was the passing of statute 4 and 5 Will. IV. c. 76, which has remodelled the whole administration of the poor-law, and greatly extended the workhouse system. The Commissioners appointed by that act, and the public Board substituted for these Commissioners in 1848, and made permanent in 1867, have been empowered, under certain restrictions as to consents, to order workhouses to be

built, altered, or enlarged as they see fit, and may make by-laws for their government, which the justices are to enforce. The various workhouse officers, including master, matron, schoolmaster, schoolmistress, nurse, porter, and superintendent of out-door labour, have all their proper functions assigned them. Persons having an order, either from the Board of Guardians, the relieving officers, or the overseers, are at all times entitled to admission; and in cases of necessity, applicants must be admitted without an order. If the house be full, the master is bound to refer the applicant to the relieving officer, whose duty it is to find him relief elsewhere. Casual poor wayfarers, admitted by the master or matron, are to be kept in a separate ward; and by 34 and 35 Vict. c. 108, the guardians of every union are bound to provide within their respective unions casual wards with such fittings as furniture as the Poor-Law Board, in their judgment—regard being had to the number of casual paupers likely to require relief—shall consider necessary. There are various statutory enactments regulating the discipline of workhouses. Refusal to work at any suitable employment, intoxication, or other misconduct, is punished with imprisonment and hard labour, not exceeding 41 days. A pauper absconding with clothes or other property belonging to a workhouse, is liable, under 7 Vict. c. 101, and 13 and 14 Vict. c. 101, to imprisonment and hard labour. The usual rule, in accordance with which man and wife are separated, is, by 10 and 11 Vict. c. 109, relaxed when they are above 60 years of age. By 11 and 12 Vict. c. 110, persons professing to be wayfarers or wanderers are to be searched on admission, and any money found on their persons is to be applied to the common fund of the union; and an applicant for relief concealing such money, is to be punished as a disorderly person. In every workhouse, a register is to be kept of young persons under 16 years of age who are hired as servants or bound apprentices, and the relieving officer is bound to visit them twice a year, and inquire into their food and treatment. By 31 and 32 Vict. c. 22, a register of religious creeds is to be kept in every workhouse. By 29 and 30 Vict. c. 113, the Poor-Law Board is empowered to direct the guardians to provide proper drainage, sewers, ventilation, fixtures, furniture, and medical and surgical appliances in every workhouse.

Workhouses are of various sizes. One of ordinary dimensions comprehends accommodation for 450 to 700 inmates of both sexes and different ages; others, in populous neighbourhoods, as near Manchester, will accommodate 1500 inmates. Classification as regards sex and age is an important particular, and is usually well attended to. In some situations, the able-bodied inmates work at field-labour within boundary walls. There is no going in and out at pleasure. A workhouse is a sort of prison under stern, though not unkind discipline, and the leading principle always held in view is, that the offer of being accommodated shall act as a terror to idly-disposed persons, who are inclined to seek parish relief. The establishment of a workhouse really has this salutary effect; where there is no workhouse, the pressure on the poor-rates is generally excessive. A half-empty workhouse is thought a proof of good poor-law management.

In Scotland, the name workhouse is sometimes given to institutions for the support of paupers, but their correct legal designation is **POORHOUSE**. Previous to act 8 and 9 Vict. c. 83, establishments for the reception of paupers had been erected in many of the larger towns of Scotland, and the expense connected with their maintenance was considered

a proper charge on the funds. Admission to these almshouses was granted, as a matter of favour, to the more deserving of the aged, infirm, and friendless poor. No system of discipline was enforced, as any improper conduct could at once be checked by expulsion of the delinquent.

Act 8 and 9 Vict. c. 83, which made a complete change in the poor-law system of Scotland, affords powers for the erection of new poorhouses, and for the enlargement and greater efficiency of those that previously existed. The classes of poor for whom they are designed are described as 'the aged and other friendless and impotent poor,' and 'those poor persons who, from weakness or facility of mind, or by reason of dissipated or improvident habits, are unable to take charge of their own affairs.' The Parochial Board of any parish, or combination of parishes, which contains above 5000 inhabitants, may erect a poorhouse as soon as a resolution to that effect has been approved by the Board of Supervision. Two or more contiguous parishes, with the concurrence of the Board of Supervision, may build a poorhouse for their common use; but no poorhouse can be built, nor any existing poorhouse enlarged or altered, until the plans have been approved by the Board of Supervision. The Parochial Boards of parishes, or combinations of parishes, in which there is a poorhouse, may receive poor persons from other parishes at rates approved by the Board of Supervision. When two or more parishes unite to build a joint poorhouse, the expense of its erection and maintenance is apportioned as determined by the parishes; and for the purpose of erecting, altering, or enlarging a poorhouse, power is given on certain conditions to borrow money on the security of the future assessments of the parish or combination.

Parochial Boards were empowered by the above act, under the sanction of the Board of Supervision, to frame regulations for the management and discipline of poorhouses. But the Board of Supervision has found it expedient, for the sake of greater efficiency and uniformity of management, to frame a general code of regulations, which, with a few modifications for peculiarly circumstanced parishes, now form the existing rules by which the Scottish poorhouses are administered. The management of each poorhouse is committed to a house-governor and a matron, subject to the orders of a committee of the Parochial Board or Boards of the parish or parishes to which the poorhouse belongs. There are minute provisions for the classification of inmates according to age and sex, the discipline, medical attendance, religious instruction, diet of the inmates, and the duties of the different officers. Each poorhouse is to be visited at least once a week by a committee of two or more members of the Parochial Board, who are to institute an inquiry regarding a number of specified particulars, the answers to which inquiries are to be submitted to the House Committee at each meeting. There are at present about 65 poorhouses in Scotland in connection with 400 parishes.

**WORKING-DRAWINGS** are the large plans prepared by engineers and architects to guide the workmen in executing the design. Many of these are on a large scale, all mouldings and ornamental work having to be drawn out of the actual size of the work.

**WORKING-PARTY**, a body of soldiers told off, by command, to perform certain work or labour foreign to their ordinary duties. A small extra pay, called 'working-pay,' is allowed, averaging about 4*d.* a day.

**WORKINGTON**, a market-town and seaport of

Cumberland, about a mile from the mouth of the Derwent, 7 miles direct north of Whitehaven, and the same distance by railway. Its harbour, furnished with a breakwater and several quays, is safe and commodious. To the coal-mines in the vicinity the town chiefly owes its prosperity—great quantities of coals being exported—but iron-foundries, malt-kilns, flour-mills, shipbuilding yards, rope and sail-cloth factories, breweries, and chemical works are in operation. Salmon fishery is carried on in the river. Railways run north, south, and east from W., establishing communication in all directions. In 1875, 235 vessels, of 23,036 tons, entered the port, and 605, of 76,077 tons, cleared. Besides coals, the exports are pig and malleable iron, and the imports timber, &c. Pop. (1861) 6467; (1871) 7979.

**WORKS, BOARD OF.** By 46 Geo. III. c. 142 (altered by 50 Geo. III. c. 52), the management and control of public works and buildings, of which the expenses are defrayed from the crown revenues or parliamentary grants, were intrusted to an officer called the Surveyor of his Majesty's Works and Public Buildings, whose duties included the superintendence of the erection and repair of royal palaces, and buildings used for the various branches of government, and the management of public museums and parks. In 1832, the duties of this officer were transferred to the Commissioners of Woods, Forests, and Land Revenues (see **WOODS AND FORESTS**); but this arrangement eventually resulted in a complaint that the crown revenue was applied too easily to the execution of public works and improvements, by which means the Exchequer was deprived of the funds which were due to it in exchange for the Civil List, and parliament was unable to exercise the proper control over an important branch of public expenditure. The department of Public Works was therefore again separated, in 1851, from that of the Woods and Forests, and placed under the management of a new Board, called the Board of Works and Public Buildings, composed of a First Commissioner, specially appointed, who is a political officer, and has a seat in the cabinet, together with the Secretaries of State, and the President and the Vice-president of the Board of Trade, who are *ex-officio* commissioners. In addition to the control over public works and buildings, possessed by the former united Board, the Board of Works has also the management of the parks in the metropolis, including the public parks formed under recent acts, and of Richmond, Greenwich, Bushy, Phoenix, and Holyrood Parks, and the public gardens at Kensington, Kew, and Hampton Court. Among the duties of the Board are, the providing of public walks, and access to the national buildings and collections—a branch of administration which has, of late years, assumed a prominence which it did not formerly possess. The Board is also charged with many arrangements and responsibilities connected with the making of new streets and roads, in London and elsewhere, and the erection and repair of public statues. The Board of Works is under control of the Treasury, to whose sanction all large estimates for public works must be submitted. The Treasury appoint the secretary, clerks, and other officers of the establishment; and with the sanction of the Treasury, the Commissioners appoint or employ such architects, surveyors, &c. as may be necessary. The salaries and expenses of the department, and the charges for all her Majesty's public works, are annually voted by parliament.

**WORKSHOP REGULATION ACT.** See **SUPP.**, Vol. X.

**WORM FEVER** is a popular name for the



affection more scientifically known as *Infantile Remittent Fever*. Although it is a disease which presents great differences in its course and symptoms, according to the circumstances which have given rise to it, its characteristic symptoms will be found to point (as Sir Henry Marsh, the eminent Dublin physician, long ago observed) to the mucous membrane as the original seat of morbid action. The disease seldom occurs during the first year of life; but from the second to the twelfth year, it is an affection often met with. Premonitory symptoms usually occur, and may last for some days. These symptoms are thus described by Dr. Evanson: The child looks ill, and loses his colour; he is languid or fretful; complains of pain in the head or belly, is drowsy, but rests badly, starting in his sleep, or grinding his teeth. The appetite fails, the tongue becomes loaded, and the breath offensive. Fever now sets in; or the attack may commence with high febrile symptoms, and be ushered in by a cold fit. When once established, the fever is remarkable for the distinctness of the exacerbations, the daily number of which varies in different cases. There is, however, usually one well-marked exacerbation, occurring in the evening, and lasting till morning, and followed by a profuse sweat. Three is a common number—namely, one in the morning, one in the afternoon, and a third at night. However cool and lively the child may at other times be, it becomes fretful, hot, and heavy, as the exacerbation approaches. During the febrile period, all the symptoms become aggravated. As the period of remission approaches, these symptoms gradually become less severe, and more or less perspiration appears. As the general disease declines, the intermissions become lengthened, while the exacerbations diminish in duration and in intensity. Worms are often present in remittent fever, and give rise to many of the above-named symptoms; but as the symptoms often remain after worms have ceased to be expelled, the latter cannot be regarded as being always the sole cause of this disease.

With regard to the treatment of remittent fever, the first point is to improve the condition of the intestinal canal, and to correct the morbid secretions poured into it. 'From the deranged state of the secretions,' says Dr. Evanson, 'the occasional use of a mercurial is often very beneficial; and it may be given combined with an aperient or a diaphoretic, according to the circumstances. The powder of jalap, simple or compound, is that which we prefer, and the addition of some ipecacuanha increases the effect.' He recommends the following formula: Powdered jalap, 30 grains; powdered ipecacuanha, 5 grains; calomel, 5 grains; white sugar, 10 grains. From 2 to 5 grains of this powder may be given every three hours, till the bowels are freely moved. He adds that, to give cold drinks, and keep the body cool by light clothing and the use of an airy apartment (while we enjoy quietness, and occasionally exclude the light), is essential to recovery. When the bowels are not irritable, a solution of crystals of tartar (bitartrate of potash) given cold, in the form of *Imperial* (see TARTARIC ACID), possesses many advantages, as it acts on the kidneys, while it allays thirst, and tends to keep the bowels open. In the more advanced stages, when debility sets in, we have found the mineral acids useful. They can be employed much sooner than quinine; but the latter may occasionally be prescribed at the close of the complaint. If there are decided signs of intestinal inflammation, leeches must be applied to the abdomen; when there is mere intestinal irritability, Dover's Powder and the warm bath will give relief.

If diarrhoea cannot be checked by other means, turpentine, in doses of one or two drops, rubbed up with gum-water, may be tried. In relation to diet, the great point is to avoid giving such food as leaves a bulky, indigestible residue. When convalescence begins, change of air often affords remarkable benefit.

WORM-GRASS. See SPIGELIA.

WORMS, or VERMES (COMPARATIVE ANATOMY). Most zoologists regard the worms as constituting a subdivision of the ARTICULATA; but one of our latest and best writers on classification, Professor Huxley, confines the synonymous terms ARTICULATA and ARTERIOPODA to the Insects, Myriapoda, Arachnida, and Crustaceans; and places the higher worms, or *Annelids*, with the above classes, in a primary division, or sub-kingdom, of ANNULOIDA; and the less highly organised worms, *Scolecids* (in which he includes the *Rotifera* or wheel-animalcules, the *Trematoda* or flukes, the *Tenias* or tapeworms, the *Nematodea* or thread-worms, the *Acanthocephala* and the *Gordiacea*), in a sub-kingdom, to which he applies the term ANNULOIDA. The main reasons of his placing the worms under two great subdivisions are—(1) that the Annelids resemble the Arthropoda in the arrangement of the nervous system, which constitutes a ganglionated double chain, traversed at one point by the œsophagus; (2) none of the Scolecids possess any characters in common with the Arthropoda generally, or the Annelida, other than those which they have in common with all animals. No scolecid has a definitely segmented body, or bilaterally disposed successive pairs of appendages, nor has it a longitudinal chain of ganglia. These grounds of difference outweigh, in his opinion, the many points of resemblance between the Annelids and the Scolecids—as (1) the resemblance between the ciliated larva in many cases; (2) the resemblance between the forms of the mature bodies of many Scolecids with that of one of the most familiar of Annelids, which is so close as to have acquired for the Scolecids the popular name of 'worms;' and (3) the fact, that in the Annelids we see the representatives of that singular system of vessels which attains a perfect development in the 'water-vascular' apparatus of many Scolecids. The final settlement of the classification of these animals must be decided by further investigation.

With regard to the general characters of worms, it is well known that they are usually of a very elongated form. In the higher groups, the division of the body into a number of segments is very distinct; while in some of the lower forms no segmentation can be detected. The segments, when present, are usually homonomous, or, in other words, are mere repetitions of one another. The soft and contractile body may be cylindrical or slightly compressed, or it may be flat and broad, and usually presents a distinct dorsal and abdominal surface. The lateral region is often provided, in the higher forms, with special appendages, resembling minute stumps, which take part in the respiratory process. Amongst the cuticular appendages must be mentioned the bristles (*setæ*), hairs, hooks, &c. which are often seen. The nervous system of the highest worms—the Annelids—has been already sufficiently described in our notice of Professor Huxley's views. From this condition it appears in the Scolecids to become more and more rudimentary, till in the parasitic worms it totally disappears. The mouth is absent in the lower forms, but in the higher lies in the mesial line of the abdominal surface, in close approximation to the chief nervous (pre-oral) ganglion, from which most of the organs of the senses derive their nerves, as the eye, the auditory apparatus,

and the organs of touch (especially the lips). Some of the parasitic worms, as the tapeworms, &c., are totally devoid of an intestinal canal; others, as the Turbellaria (with few exceptions), and the Trematoda, have an intestine, but no anal aperture; while the rest have an intestine provided with both mouth and anus. The latter, when present, lies on the posterior part of the body, and sometimes (as in many Turbellaria) on the dorsal surface. Except in the Gephyrea or Sipunculacea, the intestine, when present, is simple, and devoid of convolutions, but is often, as in the leech, provided with lateral blind sacs. The vascular system in the most highly organised worms consists of a closed system of arteries and veins, presenting modifications in different genera. A large vessel which runs beneath the dorsal integument may be seen under a microscope to contract and propel the blood forward, thus fulfilling the functions of a heart, and being the homologue of the dorsal veniform heart of insects; while a corresponding venous trunk conveys the blood in an opposite direction, and runs along the under surface of the body. These great trunks are united at each segment by transverse vessels, which carry the blood from the ventral vein to the dorsal artery. In the Nematelmia, or parasitic round-worms, the system is much simpler; and in the lowest worms, no trace of true blood-vessels is discernible. None but the Annelida (q. v.), or highest worms, possess special respiratory organs. These occur in various forms. Thus, in the leech and earthworm, a series of pores on each side of the body lead to as many simple sacculi formed by an inward folding of the integument. In the tubicolous Annelida, such as the *Serpula* (a common inhabitant in the aquarium), the respiratory organs are in the form of long flattened branchia, radiating from the head, and generally disposed in a spiral form. When not filled by the red circulating fluid, which the Annelids generally possess, they are often beautifully tinted with purple, green, and yellow colours, and form a gorgeous crown. In the *Arenicola piscatorum* (figured in the article ANNE-LIDA), the respiratory organs are seen lying as lateral tufts in the middle part of the body (fourteen or sixteen in number on each side). In the lower worms, there are no definite respiratory organs, the process being carried on partly by the surface of the skin generally, and partly by the water-canals noticed in the article TAPEWORM. As a general rule, the worms are hermaphrodites, only one of the five classes into which they are divided—viz., the *Nematelmia*, having the sexes separate. A large number of the lower kinds are parasitical; the others are inhabitants of sea and fresh water, mud, earth, &c.

The worms are arranged by V. Carus into the five following classes: (1.) *Annulata*, corresponding to the *Annelida* of Owen, and described in the article ANNE-LIDA. (2.) *Gephyrea*, including the Sipunculus and its allies. (The term is derived from the Greek *gephyra*, a bridge, because the animals included in it form a connecting link or bridge between the Echinoderms and the true articulate animals.) In the article SIPUNCULUS (q. v.), in which, according to the old view, that animal is regarded as an echinoderm, there is a figure of a British species, the *Sipunculus Bernhardus*. (3.) *Chaetognatha* (signifying *shaggy-jawed*, from the Greek *chaistis*, shaggy, and *gnathos*, a jaw), including the single genus *Sagitta*, which was formerly erroneously placed among the Nudico-branched Mollusca. As the *Sagitta* is not elsewhere described in this work, we may notice that it is a little fish-like animal with a distinct head, the mouth armed with several pairs of lateral hook-like jaws, with an

elongated body furnished with one or two pairs of fin-like organs, and with a broad and usually bilobed caudal fin. The sagitta (so called from its arrow-like appearance) is of small size, swims with great



Sagitta.

rapidity, and is common in the Mediterranean and in the North Sea. (4.) *Nematelmia* (from the Greek *nema*, a thread, and *helmine*, a worm), which are described in a special article. (5.) *Platyelmia* (from the Greek *platys*, flat, and *helmine*, a worm), or Flat-worms, which are divisible into the three orders: (1) *Turbellaria*, including the Planarias, &c.; (2) *Trematoda*, including the Flukes; and (3) *Cestodea*, including the Tapeworms. These orders are described in special articles.

For further information on the subject of this article, the reader is referred to the various works and Memoirs of Milne-Edwards, Grube, De Quatrefages (especially his *Rambles of a Naturalist*), Schmarida, Blanchard, Leuckart, Williams of Swansea (in the Reports of the British Association), &c. The British worms have not yet been fully described by any competent naturalist, although the labours of Williams of Swansea and Johnston of Berwick (both too early lost to science), are excellent as far as they go. Dr Johnston's *Catalogue of the British Non-parasitical Worms in the Collection of the British Museum* (Lond. 1865, pp. 366), with 20 plates, must be consulted by all who take an interest in this subject, although, in consequence of the delay in its publication, much of it is out of date. It is understood that Dr Mackintosh, one of the most distinguished of the younger generation of Scottish naturalists, is preparing a work on the British Worms for the Ray Society.

WORMS, AS A DISEASE OF INFANCY. AS we have elsewhere (see ASCARIS, ENTOMOZA, TAPEWORM, and VERMIFUGES) treated of the natural history of the worms infesting the human subject, and of the remedies to be employed for their expulsion, we shall mainly confine ourselves in this article to the symptoms which are usually considered to be indicative of the presence of worms in children. These symptoms are, however, in reality, only evidence of irritation of the mucous membrane of the intestinal canal, which may be due to other causes than worms, as, for instance, the presence of indigestible matter, unhealthy secretions, or the existence of a morbid condition of the membrane itself. 'Indeed, the latter,' says Dr Evanson, 'would seem necessary, in many instances, for the production of any symptoms, although worms were present; as they have been passed by children in perfect health, who experienced no inconvenience on their account. Even the evacuation of worms does not prove that the symptoms present were caused by them, though doubtless they are likely to have been aggravated thereby. The worm may have been but an accidental accompaniment—a morbid condition of the mucous membrane being the true source of the symptoms.'—*On the Diseases of Children*, 4th ed. p. 345. Although all the symptoms commonly referred to the presence of worms may exist without them, yet there is a group of symptoms which pretty certainly indicate their presence, and which, when occurring together, should, at all events, excite our suspicions. These symptoms are divisible into (1) those dependent directly on the presence of worms in the intestines; and (2) those connected with the

sympathetic relations of the digestive organs, and due to some form of reflex nervous action.

(1.) 'Worms,' says Dr. Evanson, 'may be suspected to be present when a child looks pale and grows emaciated, while his belly swells and becomes hard—a gnawing, pungent, or twisting pain being felt in the stomach or about the navel. The appetite is usually precarious, at times voracious; the breath is fetid; and the bowels often deranged, being alternately purged or costive, and much mucus passed in the stools. There is commonly picking of the nose, or irritation (often excessive itching) is felt in the lower part of the bowels; and when a child is old enough, he may complain of a sense of sinking or fainting, which seems to attend particularly on the irritation caused by worms. When symptoms are present, and cannot be accounted for by the existence of disease of the mucous membranes or of the mesenteric glands, we have good reason for believing that worms are their cause.'—*Op. cit.*, p. 347.

(2.) Amongst the most marked sympathetic symptoms are those of the head. The sleep becomes unquiet, and the little patient is liable to start up suddenly from slumber; grinding of the teeth is common; the pupils are often dilated, and there may be headache, and sometimes convulsions—symptoms painfully like those of Hydrocephalus (q. v.), but often disappearing on the expulsion of worms. A dry cough, unaccompanied by any signs of disease of the thoracic organs, is regarded as a sympathetic or reflex symptom of worms; and vomiting, hiccough, diarrhoea, tenesmus, and bloody stools often accompany their presence. The Round-worm (*Ascaris lumbricoides*) may be present in the small intestine (its ordinary seat) in large numbers without occasioning any disturbance; but when it does give rise to symptoms, the most prominent are sharp colicky pains about the navel, faintness, great emaciation, and voracious appetite. The Thread-worm (*Ascaris* or *Oxyuris vermicularis*) chiefly occurs in the rectum, where it often exists in large numbers, looking like bits of cut thread. In a recently voided stool, they are seen to be in rapid motion; hence they are called *Ascarides* (from the Greek *askaridzein*, to jump), and hence also, in all probability, the great distress which they occasion as compared with the quiet round-worms. The characteristic sign of the presence of these thread-worms is the itching and irritation felt in the rectum.

WORMS, an ancient and interesting but decayed town of Hesse-Darmstadt, in a highly fruitful district on the left bank of the Rhine, 20 miles south-east of the town of Darmstadt, and communicating with Mainz and Mannheim by railway. Pop. (1871) 14,484. Among its churches, the chief is the cathedral, a massive building in the Byzantine style, with four towers, founded in the 8th, and completed in the 12th century. On a hill near the church called the Liebfrauenkirche, a highly esteemed wine, called *Liebfrauenmûch*, is grown. The manufacture of polished leather employs 1200 hands; tobacco is also manufactured, and a trade in the wines and the agricultural produce of the vicinity is carried on. W. is one of the oldest cities of Germany, and is the scene of the *Nibelungen-Lied* (q. v.). It was occupied by the Romans, destroyed by Attila, and afterwards rebuilt by Clovis. It was frequently the residence of Charlemagne and his Carolingian successors, was the place of convocation of many German diets, and was erected into a free imperial city by the Emperor Henry V. The most famous diet held here was that at which Luther defended his position as a Reformer before Charles V. and the assembled princes and statesmen of the empire. See REFORMATION. The industry and commerce of W. were great during the

middle ages, and its pop., as far back as the time of the Hohenstaufens, averaged 60,000, and even amounted to 30,000 at the close of the Thirty Years' War, but it was almost wholly destroyed by the French in the destructive war of 1689; and though soon after it was rebuilt on a smaller scale, it has never recovered its former prosperity. The site of the old town is only partially occupied by the present one, the rest being laid out in gardens. Here, in 1743, an offensive and defensive alliance was entered into by Great Britain and Austria with Sardinia.

WORMS, an island with an area of about 36 sq. m., belonging to the Russian government of Esthonia, and lying to the east of Dagö. It is flat and generally well-wooded in the interior, and throws out numerous steep promontories, round which strong currents run, so that, often for months together, it is cut off from all intercourse with the neighbouring islands of Oesel, Dagö, Runö, &c., as well as with the mainland; and thus the inhabitants, who are of Swedish origin, have remained unmixed with foreign elements. A stranger is a rare and astonishing phenomenon on this island; and he, in his turn, is not less surprised at the peculiar old Swedish dialect, the architecture, and the manners and customs of this small, poor, but happy insular people.

WORM-SEED is the popular name for santonica, from which Santonin (q. v.) is extracted.

WORMWOOD is the popular name for *Artemisia absinthium*. It not only acts as an anthelmintic, as its name implies, but it likewise possesses tonic and stimulant properties, which



Wormwood (*Artemisia absinthium*).

prevent the reproduction of worms after their expulsion. An *Infusion of Wormwood*, made by pouring a pint of boiling water over an ounce and a half of the dried plant, letting it stand for an hour, and straining, taken in doses of a couple of ounces once or twice a day, is a very good domestic tonic, and may be prescribed with advantage even in cases where worms are not suspected.

WORSAAE, JENS JACOB ASMUSSEN, a distinguished Danish archaeologist, was born in 1821 at Veile, in Jutland, where his father held the post of *justitsraad*, or councillor of justice. W. received

the rudiments of his education at the Gymnasium of Horsens, from whence he proceeded, in 1833, to Copenhagen, with the intention of studying theology. Having, however, soon exchanged his theological studies for law, and again as speedily relinquished the latter, he turned his whole attention to the history and archæology of the north, which had from an early age presented special attractions to his mind; and in 1838 he obtained the place of assistant in the Royal Museum of Northern Antiquities at Copenhagen, which was then under the direction of the able Danish archæologist, C. J. Thomson, to whom this most valuable collection owes its origin and its present state of excellence. In 1844, appeared W.'s important work, entitled *Runamo og Bravalla Slaget*, in which he, with consummate skill and profound erudition, definitely settled the long-pending doubts as to the authenticity and character of the Bleking rock inscriptions, and satisfactorily shewed, that the supposed runes were no runes at all, but the mere weatherings of the rock; and consequently, that the interpretation given by the great Icelandic scholar, Finn Magnussen (q. v.), had no existence but in the mind of its author. This bold but conclusive solution of a long-pending problem, which, from the days of the great Danish historian, Saxo Grammaticus, had occupied the attention of the most learned men of the north, at once placed W. in the foremost rank of northern archæologists; and the numerous works and monographs which have appeared from his pen since then, have fully justified the high promise given by his early labours. During the ten years intervening between this period and his nomination in 1854 to the honorary rank of Professor in the university of Copenhagen, W. made repeated visits to the other Scandinavian lands, to Great Britain, Germany, France, and other parts of Central Europe, which retained traces of the former presence of the Northmen. The Danish government defrayed the expenses of several of these journeys, the results of which have been the publication of numerous works and papers of interest, among which we may instance his *Minder om de Danske og Nordmændene i England, Skotland og Irland* (Copenhagen, 1851); or *Memorials of the Danes and Norwegians in England, &c.*, of which an English translation appeared the following year; and his treatise *Om en forhistorisk aabaldet tysk Befolkning i Danmark* (Copen. 1849); &c. Some of the most important of his works on the archæology of his native country are his *Danmarks Oldtid oplyst ved Oldsager* (Copen. 1843); *Blekingeke Mindesmærker fra Hedenold*, 1846; *Danevirke*, 1848; and his *Afbildninger fra det Kongelige Museum for Nordiske Oldsager*, 1854. W. has always shewn himself a warm patriot, and a strenuous opponent of the spread of German tendencies in the duchies, and his views in this direction were forcibly enounced in his *Jylland's Danighed*, a treatise published in 1850, and especially directed against Jacob Grimm's exposition of the question of German national law. W.'s merits have been fully recognised by his countrymen; and the Danish government has constantly shewn its sense of the estimation in which he was held, by placing him at the head of all important commissions connected with the archæology of the country, appointing him to important posts in connection with the University and Antiquarian Museums, and bestowing upon him various other marks of confidence and respect.

**WORSTED.** Besides the application of this term, explained under **WOOL** and **WOOLLEN MANUFACTURES** (q. v.), it is also applied to the thick loose woollen yarn used for knitting stockings, &c., known in trade as fingering yarn.

**WORT.** See **BEER**.

**WORTHING**, a fashionable and rapidly-rising watering-place on the Sussex coast, ten miles west of Brighton. Pop. (1861) 5805; (1871) 7413. Its importance began with the century, as, prior to that date, it was merely a small unvisited fishing-village. The climate is much milder than that of Brighton, the town and its immediate neighbourhood being encircled on the north and north-east by almost an amphitheatre of hills, which greatly shelter it from northerly winds, and render it one of the best places for a winter resort on the south coast. The town has no noxious trades or manufactures, but is essentially a place of resort for pleasure-seekers and invalids. It has one of the finest and longest sea-parades in the kingdom, being nearly two miles in length. The town has recently undergone a costly system of drainage, and is well supplied with water; whilst its mortality tables bespeak its salubrity, having shewn for several years a rate of only 14.5 per 1000.—See Dr Barker *On the Climate of Worthing* (Churchill, London).

**WOUNDS** may be defined to be divisions of soft parts produced by external mechanical force. They have been classified by surgical writers in various ways, but the most useful arrangement is that which is adopted by Mr Paget, in his admirable Memoir on 'Wounds,' in Holmes's *System of Surgery*, and is based on their mode of infliction. They are thus divided, first, into *open* and *subcutaneous* wounds: the former including those in which the outer part of the wound is almost or quite as extensive as the deeper part; and the latter, all those in which the outer part of the wound is very much smaller than the deeper part. These wounds (especially those of the first kind) may be further divided into (1) *incised wounds*, such as cuts or incisions, including those which remove a portion of the body; (2) *punctured wounds*, such as stabs; (3) *contused wounds*, in which the divided parts are bruised or crushed; (4) *lacerated wounds*, in which there is tearing of the tissues; (5) *poisoned wounds*, in which some poison or venom is inserted; and to these may be added, as a special variety, (6) *gunshot wounds*.

*Simple, open, incised wounds* will be more fully noticed than any of the others, because they have been most fully studied, and in their surgical relations are the most important. In a clean cut, whether made accidentally or in a surgical operation, three things are chiefly to be observed—viz, the opening or gaping by the retraction of their edges, the bleeding, and the pain. The *gaping* of a wound is caused by the retraction of the various tissues which are divided. Of the various tissues, the skin exhibits the greatest degree of retraction, and then (in the order in which they stand) elastic tissue, cellular or connective tissue, arteries, muscles, fibrous tissues, nerves, and cartilages. In addition to the immediate gaping of fresh wounds, many wounds, if they be not prevented, will continue to retract for a long time. For example, in stumps that heal slowly, the limb terminates in a cone, in consequence of the prolonged retraction of the muscles. The *bleeding* from an incised wound depends chiefly on the size and number of the divided vessels, and on their connection with the surrounding parts, but to a certain extent on the previous condition of the wounded part, or on the peculiar constitution of the patient. Gradually, with or without surgical help, the vessels cease to bleed; and then, if the wound be left open, there is an oozing of blood-tinged serous fluid, succeeded gradually by a paler fluid, which collects like a whitish film on the surface, and contains an abundance of white or colourless blood-cells, imbedded in a fibrinous (and therefore

spontaneously coagulating) fluid. The nature of the pain cannot be made clear by any description to those who have not felt it; and it is more than probable that a similar wound inflicted on two or three persons would occasion different degrees of pain in each. There are also differences, as Mr Paget has pointed out, 'in both the kind and degree of pain, according to the place and manner of the wound. Thus, in regard to the skin, wounds of the face and of the extremities of the fingers and toes, seem to be amongst the most painful; those of the back amongst the least so; and wounds cut from within are less painful than those from without. The skin appears far more sensitive to wounds than any of the deeper structures, except the nerves of sensation themselves; but any part (as periosteum or tendons) may become, by disease or distention, highly sensitive.'—*Op. cit.*, p. 581. The local consequences of an incised wound are indicative of inflammation. In the course of an hour or more, the edges of the wound and the adjacent parts become swollen and abnormally sensitive, feel hot and aching; the sutures (if any have been inserted) become tighter, and the edges and intervening spaces gape in consequence of the swelling. These symptoms gradually subside in two or at least four days, unless there is some abiding source of irritation. Except in very severe wounds, no general consequences are apparent. In these exceptional cases, as in amputations, for example, a shock and subsequent reaction (both of which are described in the article SHOCK) are observed. The duration of this feverish reaction or traumatic fever does not seem to bear any fixed relation to the severity of the injury. Sometimes it subsides within twenty-four hours; more often, after large wounds, it does not subside for three or four days, when the pulse and breathing gradually return to their natural standard, and the skin becomes soft and cool. The beginning of suppuration often coincides with the subsidence of the fever. If the fever should last more than four or five days after the receipt of the injury, there is probably some persistent irritation or some morbid complication.

The healing of open incised wounds may be accomplished, according to the high surgical authority from whom we have already quoted, in five different ways, if we include those in which the process is assisted by treatment—viz. (1) by immediate union, or (in surgical language) by union by the first intention; (2) by primary adhesion, or union by the adhesive inflammation; (3) by granulation, or by the second intention; (4) by secondary adhesion, or the third intention—i. e., by the union of granulations; and (5) by scarring under a scab, the so-called subcutaneous cicatrisation. Healing by immediate union takes place when the wounded parts being placed and maintained in contact, first stick together, and then become continuous, without the formation of any new material as a connecting medium. For example, a flap of skin is raised by dissection in the removal of a tumour or a mammary gland, and is then replaced on the subjacent parts. In three days at most, the union may be complete, without any indication of inflammation, there being no evident efflux of blood, no exudation of reparative material, and no scar. In healing by primary adhesion, lymph exudes from both cut surfaces, becomes organised, gradually connects the cut surfaces, and at length forms between them a firm layer of connective tissue, covered with a thin shining cuticle. These steps are well seen after the operation for hare-lip, for example. In healing by granulation, the wound becomes coated over with the white film, containing colourless blood-cells, as already described. If these

glazed surfaces are brought and kept together, they will probably unite, the film becoming organised, and contributing to form a bond of union; but if the wound be left open, the film increases, and takes part in the formation of Granulations (q. v.). We cannot enter into the life-history of these granulations, and can only remark, that they are finally developed into a scar, consisting of fibro-cellular or connective tissue, with a superficial layer of epidermis. The completion of the healing is accomplished by the gradual improvement of the scar, in which the connective tissue becomes more perfect in its character, and the cuticle becomes thicker and more opaque. Healing by secondary adhesion, or by third intention, 'is accomplished by the union of two granulating surfaces (e. g., those of two flaps after amputation) placed and maintained in contact. In this state the two surfaces simply unite, or else new material, produced from either or both surfaces, adheres to both, is organised into continuity with both, and then unites them.'—Paget, *op. cit.*, p. 586. Healing by scabbing, or under a scab, is, according to the same authority, the most natural, and in some cases the best of all the healing processes. In animals, it is often observed that if a wound be left wide open, the blood and other exudations dry on its surface, and form an air-tight covering, under which scarring takes place, and which is cast off when the healing is complete. In man, this process is less frequent, because, in the first place, exudations seem to be more often produced under the scab, which detach it, and prevent the healing; and secondly, surgical interference seldom allows this method to have a fair trial.

Such are the several modes of healing of simple, incised, and all open wounds. We have now to consider the nature of the processes therein concerned. Every wound is followed by more or less tendency to an inflammatory process. This tendency may not proceed beyond an increased sensibility of the part and a slight efflux of blood, and there may be no inflammatory exudation; and this is the best condition for healing by immediate union in which no new material is required; or the inflammatory process may go on to the production of lymph, and then cease—a condition essential to healing by adhesion. In healing by granulation, a very low degree of inflammation (such as is requisite for the effusion of the first materials for granulation) is best; while for healing by secondary adhesion or by scabbing, inflammation must be altogether absent. The due understanding of these relations of inflammation and the healing processes of open wounds, affords important aid as to the mode of treatment. Nothing should be done to excite or increase inflammation. So much as may be necessary for some of the modes of healing, is sure to occur spontaneously, and more will only do harm; on the other hand, the inflammation excited by the wound does not require special treatment, except in the case of organs (such as the eye, the peritoneum, the lungs, the large joints, &c.) in which serious mischief may be very rapidly induced by inflammation. The position of the wounded part is a subject of considerable importance. 'When comfort has, as far as possible, been secured, the next object should be that the wounded part should be relaxed, so that the edges of the wound may come near or together; that no part, and especially no muscle, should be on the stretch, and that the direction of the wound may be such as will allow fluids to flow away from some part of it.' In the great majority of cases, healing by immediate union, or by primary adhesion, is most desirable, and should be aimed at—the exceptional cases being wounds through many structures, and exposing considerable surfaces of

deep-seated bones; deep wounds whose depth far exceeds their length; wounds of which the deeper portions of the sides cannot be kept in good contact; wounds through parts in a very inflamed or otherwise disordered state; and those which are likely to be troublesome from secondary hæmorrhage—in all of which there is a fear of the collection of blood and other fluids under the closed integuments. In attempting to induce healing by either of these modes, the points to be attended to are—the arrest of the bleeding, the cleaning of the wound, the exact apposition of its edges, and their maintenance in this position, and the exclusion of the whole wound from the air. If the bleeding arises from vessels of considerable size, they must be tied, twisted, and pressed (according to Simpson's plan) or crushed at their ends; but all these means, and especially ligature, should be avoided if possible, because they are impediments to exact union; and spontaneous closure of the vessels by the action of cold air or water, and pressure with dry lint, is preferable. The cleaning of the wound is best effected by allowing a gentle stream of water to flow over it. Soft sponges are sometimes useful for this purpose; but they must be used as dabbing (not as scrubbing) agents, and the greatest attention must be paid to their cleanness: the sponge used for the wounds or sores of one patient should never be applied to those of another. Apposition is effected by padding and bandaging, Sutures (q. v.), and adhesive plasters—the former being useful in deep wounds, while the latter two serve for more superficial wounds. Although a simple incised wound, after its sides have been thus brought into complete contact, may be left exposed to the air, some covering to exclude the air is deemed preferable. Whatever is used should be light, not adhesive, and not prone to decomposition—its object being to protect the wound probably from a deleterious action of the air, and more certainly from sudden change of temperature, friction, and dust. Nothing is better for this purpose than lint soaked in oil, or simple cerate on perforated linen. The following remarks on the dressing of wounds are condensed from Mr Paget's Memoir. No general rule can be laid down regarding the time at which any or the whole of the dressings should be removed. In small wounds about the face, union may be complete in two days; but it is not so firm as to be safe from probable accidents, and metallic sutures possess the advantage of exciting so little irritation, that they may be left in their places for any length of time, till union is perfectly secure. They should therefore not be removed for four days, or, in the case of large wounds, for a week, or longer. They should not all be removed at once, and those that are removed should be replaced by strips of adhesive plaster; the union or scar must be cleaned most gently, and protected from the plaster with oiled lint. If, on the first dressing, the union or adhesion of the wound is progressing favourably, then it will usually be sufficient to dress it subsequently on every second day; and if all goes well, the union of small wounds may be regarded as safe at the end of a week, and that of larger ones at the end of ten days or a fortnight.

The rules which we have here given for inducing healing by immediate union or by primary adhesion may, in an emergency, be carried out by any intelligent reader, and ought to be generally known. We do not enter upon the modes of inducing the forms of healing by granulation and by secondary adhesion, as they ought to be carried on under surgical superintendence; nor do we notice the last mode—that of healing under a scab—because it is simply leaving the wound to nature: the most that is required in

this case in the way of auxiliary treatment being to cover the scab with dry cotton-wool, to protect it and the subjacent surface from any causes that may excite inflammation.

Of the other varieties of wounds, it is sufficient to notice the most important points severally peculiar to each variety. Of *punctured wounds*, the most serious are those which are made with blunt-pointed instruments, such as nails, pitch-forks, iron spikes, &c., for by these the injured parts are not so divided as that they may retract, but are pressed aside with much bruising, and can close again as soon as the instrument is withdrawn; and in this lies the chief danger of these wounds, because blood or other fluids are likely to extravasate into them, and cannot readily escape. These fluids, by decomposing or by mere pressure, may excite inflammation, and thus cause deep and confirmed suppuration, and great destruction of tissues. Some of the worst forms of these wounds are those produced by sharp teeth, probably (as Mr Paget suggests) because of the force with which, as they tend to meet, the teeth crush the intervening parts. In *contused wounds*, the great question is, whether their union should or should not be attempted. If union is to be attempted, the rules given for the treatment of incised wounds must be followed, especial attention being paid to their careful cleaning, the removal of clots of blood, and their warm covering with some soft material, as cotton-wool. When it would be useless, from the extent of the bruises, &c., to attempt union, the following rules, as laid down by Mr Paget, should be adopted: 'The part should be kept at rest, and as nearly as possible at its natural temperature. For the latter purpose, and for protection, an excellent dressing is lint or cotton-wool thoroughly soaked in olive oil, and completely fitted to the part. Dry cotton-wool may be applied over this, or oiled-silk. Water-dressing may be similarly applied, or warm poultices, but they are generally less comfortable. Irrigation is, in some cases, very soothing, especially in ragged wounds, but it should be with tepid water. The methods of the dressing, after the first, may be almost the same as for incised wounds.'—*Op. cit.*, p. 598. The treatment of *lacerated wounds* is almost precisely the same as that of contused wounds. *Poisonous wounds* are sufficiently discussed in the article *VENOMOUS BITES*; and there is a special article on *GUN-SHOT WOUNDS*, which are, in reality, only an important variety of contused wounds.

In conclusion, it must be mentioned that various kinds of wounds are liable to certain complications, of which some are local, and others general or constitutional. Among the former are recurring or secondary bleeding, pain, spasmodic muscular movements, and the presence of foreign bodies; whilst the latter include defect or excess of reaction, traumatic delirium, fever, erysipelas, pyæmia, &c. Some of these complications are treated of in special articles of this work; and for the treatment of the remainder, we must refer to Mr Paget's Memoir, from which most of the details of the present article are borrowed.

WOUVERMANS, PHILIP, a Dutch painter of note, was born in 1620 at Haarlem. From his father, Paul Wouvermans, a historical painter, he inherited a taste for art. He studied first with his father, and afterwards with John Wynants. He passed his entire life at Haarlem in the assiduous practice of his art, and died in the year 1688. Though his pictures are now highly valued, he is said to have had little immediate success, and to have lived in poverty, pretty much in the hands of the picture-dealers. His pictures are, for the most part, landscapes of small size, with figures profusely

introduced, commonly in energetic action. His battle-pieces, in particular, are greatly admired for their spirit and vigour. He had two brothers, also painters, JOHN and ПЕТРЪ, who executed subjects somewhat similar, and whose works have not unfrequently been attributed to him; but though both artists of considerable merit, they are plainly much inferior to Philip.

**WRACK**, or **SEA-WRACK**, a name sometimes applied indiscriminately to many of the larger *Algae* of the sea-shores, but also employed to designate the species of the genus *Fucus* (see *ФУСАКЪ*), some of the most abundant of which are employed on the British shores for the manufacture of Kelp (q. v.), and are also much used as a manure. The genus *Fucus* has a leathery, dichotomous, generally flat, linear frond, usually furnished with large air-cells, which are included in the substance of the frond; the spores arranged in tubercles, imbedded in mucus, and collected in *receptacles*, through the pores of which they are finally discharged. *F. vesiculosus*, popularly known as *Sea-ware*, *Kelp-ware*, and in Scotland as *Black Tang*, is extremely abundant on all the rocky shores of Britain, growing between high and low water mark, and most plentifully near high-water mark, often struggling for existence on the very upper line, and even found among grass and moss in marshy ground occasionally overflowed by the tide. It is the species chiefly employed in the kelp manufacture, because it is more easily collected than any other. It is of a dark olive-green colour, sometimes two or three feet in length; the frond flat, entire on the margin, with a central rib; the air-cells spherical, in pairs, sometimes as large as hazel nuts; the receptacles solitary, terminal, turgid, compressed, mostly elliptical. Oxen, sheep, and deer eat it, and seek it on the sea-shore in winter when other food is scarce. In Gothland, it is boiled and mixed with a little coarse flour as food for hogs. It has been used medicinally in glandular affections, probably owing its value to the iodine which it contains.—*F. nodosus* is another very common British species, sometimes called **KNOBBED W.**, growing nearer to low-water mark than the last, and therefore not so often and easily accessible, but esteemed the very best species for the manufacture of kelp. It has veinless fronds, branched in a somewhat pinnated manner, with large solitary egg-shaped air-cells, in the central line of the frond. It sometimes attains a length of six feet.—*F. serratus* is also very common, and is easily distinguished by its serrated fronds, and the want of air-cells. It is sometimes called **BLACK WRACK**. It is less useful for kelp than the other species. In Norway, it is used as food for cattle, generally sprinkled with a little meal. It is preferred to other species for packing crabs and lobsters to be sent to market, as it keeps them moist, whilst having less mucus than the other species, it is less apt to ferment and putrefy. Some other species of *F.* are common British *Algae*, although much less abundant than these. The use of *W.* for manure is of great advantage to farmers on the sea-coast. This kind of manure is better adapted for light than for clay soils. The effect is beneficial for almost all kinds of crop. The *W.* ought not to be allowed to lie long in a heap, as it is injured by fermentation, but as quickly as possible applied to the land, and covered by the plough.

Some of the *Fuci*, as *F. vesiculosus* and *F. serratus*, on receiving injury by which any part of the frond is broken, throw out a cluster of young sprouts from the injured part.

**WRANGLER**, the name given at the university of Cambridge to those who have attained the first class

in the public mathematical honour examinations. These examinations extend over eight days, the *pass* in the papers of the first three entitling a student to the degree of Bachelor of Arts, with honours of the third, second, or even first class, according to the number of marks attained. The word wrangler is derived from the public disputations in which candidates for degrees were in former times required to exhibit their powers. The examination is confined to mathematics, pure and mixed; it is conducted by two moderators and two examiners. At the end of the three days, an alphabetical list of those who have attained sufficient marks to entitle them to a degree and honours in mathematics is published. All appearing in that list are entitled to appear at the following five days of examination. In the final list, which shews the number of marks obtained during the eight days, each candidate is placed in order of merit. The honour men who compose the mathematical *tripos* number usually from 120 to 150, and are divided into three classes—*wranglers*, *senior optimes*, and *junior optimes*. The head of the *tripos* is called the *senior wrangler*. The number of wranglers varies from year to year. It has rarely been under thirty-five, and has often been forty-five or upwards, the number not being limited otherwise than through the application of a certain high standard of excellence.

**WRASSE**, or **ROCK-FISH** (*Labrus*), a genus of fishes of the family *Labridæ* (q. v.), of the section having cycloid scales, *Cyclolabridæ* of Müller. They have spiny fins, large thin scales, and an uninterrupted



Ballan Wrasse (*Labrus bergylla*).

lateral line. The mouth is protrusible, with thick fleshy lips, folded so as to appear double. The teeth on the jaws are simple, in one or more rows; the lower pharyngeal bones are completely fused together, and have broad grinding teeth. The form is somewhat perch-like, with the back more straight. There is a single long dorsal fin, the spines of the anterior portion of which are surmounted by short membranous filaments, the posterior portion having short and split rays. The ventral fins are under the pectorals. The colours are generally very brilliant. The species are numerous, abounding in tropical seas, but several of them are found on the coasts of Britain. They chiefly frequent rocky shores, and are generally seen in small shoals, often hiding under sea-weeds. They feed on crustaceans, molluscs, and marine worms. They are often caught by bait intended for other fish, but their flesh is not much esteemed. The **BALLAN W.** (*L. bergylla*, or *maculatus*) is one of the most common British species. It attains a length of about 18 inches, and a weight of more than three pounds. It is bluish green, paler on the belly, all the scales margined more or less broadly with orange red, the blue prevailing in some specimens, and the orange in others.

The Cook W. (*L. mixtus* or *variegatus*) is not unfrequent on the southern shores of England. Its prevailing colour is orange, striped transversely with blue, particularly in the male, the colours of the sexes differing so much that the female has often been described as a distinct species, and is generally known as the RED WRASSE. There are several other British species of this and closely allied genera, as the CORKWING (*Crenilabrus melops*, or *tinea*), about six inches long, and of a greenish blue colour, varied with yellow. The colours quickly fade after the fish is taken out of the water.

**WREATH, WREATHED**, in Heraldry. A wreath is a twisted garland of silk of different colours, otherwise called a torse, on which it has, since the 14th c., been usual to place the crest. The side-view of a wreath thus drawn exhibits six divisions, which are generally tinted with the livery colours—that is, the principal metal and colour of the shield. Every crest is now understood to be placed upon a wreath, except when it is expressly stated to issue out of a chapeau or coronet. A wreath, when represented alone, shews its circular form. A Moor's head is sometimes encircled with a



Wreath.

heraldic wreath. A wreath is always understood to be the twisted garland of silk above explained, unless otherwise specified; but wreaths of laurel, oak, ivy, &c. sometimes occur, and savages used as supporters are often wreathed about the head and middle with laurel. Ordinaries are occasionally wreathed, otherwise called *tortills*, in which case they are represented as if composed of two colours, twisted as in the heraldic wreath; as in the coat of Carmichael, argent, a fess wreathed azure and gules.

**WREDE, KARL PHILIPP, PRINCE OF**, a Bavarian field-marshal, was born at Heidelberg, 29th April 1767. Belonging to a noble family, he early obtained official employment, and in 1792 was assessor to the high court of Heidelberg; in 1793, was elected 'civil commissary' in the Palatinate, and in this latter capacity accompanied for five years the armies of Wurmser, Duke Albert, and the Archduke Charles, in Italy and Germany; and frequently took a direct share in military operations. In 1799, his military career may be said to have commenced by his leading a body of Bavarian volunteers to join the Archduke Charles, and for his distinguished conduct in that campaign he obtained, 15th May 1800, the grade of major-general. After the peace of 1800, he devoted much time and labour to the organisation of the Bavarian army; and when war was renewed, found himself at the head of the Bavarian contingent, well disciplined and thoroughly equipped, fighting side by side with his former foes the French, and took a prominent part in most of the campaigns against the Austrians, Prussians, and Russians till 1813. But, after the retreat from Russia, offended at some real or fancied insults which had been offered to him, he returned to Munich, joined the anti-French party, which was headed by the queen and crown-prince; and though his intrigues were put a stop to by the victories of Lützen and Bautzen, he soon after succeeded in bringing about the treaty of 8th October 1813, by which Bavaria joined the coalition against France, and before the end of the same month, was at the head of 70,000 men. Attacked by Napoleon with an inferior force, he was, after a bloody and protracted contest, defeated at Hanau. He was chosen soon after to command the fourth corps of Schwarzenberg's army, and though unsuccessful in most of his petty conflicts, contributed consider-

ably to the successful advance on Paris. His services were rewarded by the dignities of field-marshal (7th March) and prince (9th June 1814), and by the gift of the domain of Ellingen. On the brief renewal of the contest during the 'Hundred Days,' W. was preparing to invade Lorraine, when the battle of Waterloo put an end to the strife. After this period, W. was employed on many important missions, and was charged with the pacification of Rhenish Bavaria during the revolution of 1830. He died at Ellingen, 12th December 1838.

**WREN, SIR CHRISTOPHER**, a renowned English architect, was born at East Knoyle, in Wiltshire, on the 20th of October 1632. His father, Dr C. Wren, was Dean of Windsor, and his uncle, Dr M. Wren, was Bishop successively of Hereford, Norwich, and Ely. At an early age, young W. was placed at Westminster School, under the celebrated Dr Busby, and while yet only in his fourteenth year, was entered a gentleman-commoner of Wadham College, Oxford. Here he made considerable progress in mathematical studies, and attracted the notice of the cultivators of physical science—whether resident at the university or visitors—by his inventions of certain mathematical instruments, and his general zeal and enthusiasm in the pursuit of experimental philosophy. In 1650, he took his degree of B.A., and in 1653, that of M.A., having been previously made Fellow of All Souls. He now also became a member of a society established at Oxford for the improvement of natural and experimental philosophy; and in 1654, is spoken of by Evelyn, in his *Diary*, as 'that miracle of a youth;' also, in his *Sculptura*, as 'that rare and early prodigy of universal science.' The acquaintance thus begun, ripened into a firm friendship between W. and Evelyn.

In 1655, W. greatly assisted in perfecting the barometer, then only recently invented. In 1657, he left Oxford for London, where he became Gresham Professor of Astronomy. In May 1661, however, he returned to Oxford, as Savilian Professor of Astronomy. The same year, he received the degree of D.C.L. Before leaving London, W. had, in conjunction with Lord Brouncker, the Hon. Robert Boyle, Mr Bruce, Dr Wilkins, Sir Robert Moray, and others, who used to meet together at Gresham College, laid the foundation of the future Royal Society. Before the Society was formally incorporated, the members felt much the absence of W. from their meetings, and one of their first proceedings was to get the king to lay his commands upon him to perfect a design he had in hand of a globe of the moon, and to 'proceed in drawing the shapes of little animals as they appear in the microscope.' The lunar globe was finished, much to the satisfaction of his Majesty, who placed it in his cabinet of rarities. He also summoned W. from Oxford to assist Sir John Denham with his advice on architectural subjects; the poet Denham having been appointed Surveyor-general of his Majesty's buildings, but possessing little or no knowledge of the subject.

The study of architecture was one to which W. had given great attention, while still a very young man, notwithstanding his devotion to mathematics, astronomy, chemistry, and even anatomy. In 1663, in his capacity of Assistant Surveyor-general, he was offered a large salary to go to Tangier, to survey and direct the works at the mole, harbour, and fortifications; but this commission he declined. In the same year, W. was engaged by the Dean and Chapter of St Paul's to make a survey of the cathedral, with a view to certain projected repairs in that vast fabric. He accordingly drew up a very careful and elaborate account of the state of the building, with suggestions for its improvement, and



accompanying drawings and designs. All of these were laid before the king; but before any further steps were taken for the restoration of St Paul's, that building was levelled to the ground by the memorable fire of 1666, and W. was destined to be the architect of the new cathedral, instead of the restorer of the old. The first work actually built from a design by W. was the chapel at Pembroke College, Cambridge, in 1663. But in the same year he designed the Sheldonian Theatre at Oxford, which was commenced in 1664, and finished in 1669. In 1664, W. also designed some valuable additions to the buildings at Trinity College, Cambridge; particularly the beautiful western quadrangle known as Nevile's Court. To this he added, in 1666, the Library of Trinity College, said by Gwilt to be 'one of his finest productions, and one with which he himself was well satisfied. It consists of two orders; a Doric arcade below, open to a basement supported by columns, which has a flat ceiling. . . . The principal story is decorated with three quarter columns of the Ionic order, well proportioned.'

In 1665, W. visited Paris, where he made the acquaintance of Bernini, architect of the Louvre, and of other distinguished men. In the following year, he returned, to find the Royal Society earnestly engaged in searching out the causes of the great plague, so soon to be succeeded by the great fire which laid London in ashes. This disaster at once opened a wide field for the exertion of W.'s genius. He formed a plan, and drew designs for the entire rebuilding of the metropolis, embracing wide streets, magnificent quays along the banks of the river, and other well-considered improvements. In rebuilding London, however, few of W.'s recommendations were adopted. He was certainly chosen to be the architect of new St Paul's, one of the finest non-Gothic cathedrals in the world; besides which, he designed more than fifty other churches in place of those destroyed by the fire. The great church of St Paul, built on the model of St Peter's at Rome, was begun in 1675, and completed in 1710, when the last stone was laid upon the lantern by the architect's son, Christopher. Besides the numerous churches mentioned, W. built the Royal Exchange, London, in 1667; Custom-house, London, in 1668; Temple Bar in 1670; the Monument in 1671—1677; the College of Physicians in 1674—1698; the Royal Observatory, Greenwich, in 1675; the Gateway Tower, Christchurch, Oxford, in 1681—1682; Chelsea Hospital, 1682—1690; Ashmolean Museum, Oxford, 1683; Hampton Court, 1690; Morden College, Blackheath, 1692; Greenwich Hospital, 1696; Buckingham House, 1703; Marlborough House, 1709; the towers at the west front of Westminster Abbey in 1713; besides the unfinished palace of Winchester, in 1683.

In 1672, W. received the honour of knighthood. In 1674, he married Faith, daughter of Sir John Coghill, by whom he had a son, Christopher, who survived him; and his wife dying, he married, in 1679, Jane, daughter of Viscount Fitzwilliam, by whom he had issue, a son and daughter. In 1680, W. was elected President of the Royal Society. In 1684, he was made comptroller of the works at Windsor Castle; and in 1685, he was elected Grand Master of the order of Freemasons. He was also elected a member of the House of Commons for New Windsor in 1689, and being unseated on petition, was immediately re-elected for the same place. In 1698, he was appointed Surveyor-general of the Works and Repairs at the Abbey of St Peter, Westminster; and in the same year, was again elected Grand Master of the Freemasons. W. died in his chair after dinner, on the 25th of February 1723, aged 90 years, and was buried in St Paul's

Cathedral, where the appropriate inscription of 'Si monumentum requiris, circumspice,' marks his tomb. During his declining years, he was treated with neglect, and even injustice, by the court of England; 'one Benson' was appointed by George I. to supersede him in the office of Surveyor-general; and some private individuals carped at his works in a most malevolent spirit. Steele, however, vindicated the fame of his friend in the *Tatler*, in which W. is introduced in the character of Nestor; and few have been found since that time hardy enough to call in question the well-merited reputation of Sir C. W. as a distinguished architect, mathematician, and scientific observer.

WREN (*Troglodytes*), a genus of birds of the Creeper family (*Certhiadae*), having a slender, slightly curved, and pointed bill, the edge of the mandibles entire; the wings very short and rounded; the tail short, and carried erect; the legs slender, and rather long. Their plumage is generally dull. They are natives chiefly of the northern hemisphere, and most of them are American. They live on or



Wren and Nest (*Troglodytes vulgaris*).

near the ground, seeking for insects and worms amongst low bushes, and in other similar situations. The COMMON or EUROPEAN W. (*T. vulgaris*) is found in all parts of Europe, and in the north of Asia. It is more abundant in the northern than in the central and southern parts of Europe, and is found even in the arctic regions. It is a very small bird, only about four inches long, reddish-brown above, with narrow transverse streaks of dark brown, yellowish white below, the greater wing-coverts with three or four small bead-like spots of white. From its peculiarity of form, and its active, lively habits, it is one of the most familiarly known of British birds. It frequents gardens, hedges, and thickets. Its flight is not long sustained; it merely flits from bush to bush, or from one stone to another, with very rapid motion of the wings. It sometimes ascends trees, nearly in the manner of creepers. The male has a loud sweet song. The nest is large for the size of the bird, oval, domed above, with an opening on the side, and is composed of hay or moss, lined with feathers, and generally of materials such that it resembles in colour the objects beside it, and is not easily discovered. It is often placed under the thatch of a building, under the turf of a turf-topped wall, against the side of a moss-covered tree, or under an impending bank, always so as to be sheltered from rain. The eggs are usually from seven to ten in number, and the male is assiduous in his attentions to the female in supplying her with food during incubation, and afterwards assists her in the care of the young. Two broods are

produced in the season. In severe winter weather, a number of wrens often take shelter together in an old nest, or in a hole of a wall; sometimes they roost in byres, to enjoy the warmth proceeding from the cattle. When driven from bushes, the W. is easily run down; and the hunting of wrens on St Stephen's Day is an old custom in the south of Ireland. In general, however, the W. is almost as much a popular favourite in Britain as the Red-breast. The name *Kitty Wren* is popularly given to it in many parts of the country.—The North American species of W. are numerous; some of them, however, have recently been placed in new genera.—The HOUSE W. (*T. adon*) is larger than the European W., being about five inches long. It is reddish-brown above, barred with dusky, and pale fulvous white below, with a light brownish tinge across the breast. It is abundant in the eastern parts of the United States. It is less shy than the European W., and often builds its nest near houses, and in boxes prepared for it. The nests are made to fill the boxes; and to effect this, a large mass of heterogeneous materials is sometimes collected. The song of the House W. is very sweet. The male is a very bold, pugnacious bird, readily attacking birds far larger than itself, as the blue-bird and swallows, and taking possession of the boxes which they have appropriated for their nests. It even attacks cats when they approach its nest.—The WINTER W. (*T. hyemalis*) is so similar to the European W., that it is not easy to state a specific difference. It is common throughout North America, from Labrador to Louisiana, and partially migratory. Several other species are common in North America, as the CAROLINA W. (*Troglodytes or Thyrophorus Ludovicus*) and the MARSH W. (*Troglodytes or Cistophorus palustris*), both of which are found chiefly in the vicinity of water. All of them agree very nearly in their habits with the Common Wren.

**WREXHAM**, a municipal and parliamentary borough in Denbighshire, and one of the most important towns in North Wales, 11 miles south-west of Chester, on an affluent of the Dee. The town is handsome and lively, and the church, a handsome edifice in Perpendicular, was built about the year 1470, though its tower, 135 feet in height, was not completed till 1500. This church contains a monument and two medallions by Roubilliac. In the vicinity are several collieries, which, together with lead-mines, iron-works, paper-mills, and breweries, give employment to the inhabitants. It is also of very considerable importance on account of its markets and fairs, one of which, in March, lasts for fourteen days, and is attended by traders of all descriptions, and from great distances. W. unites with Denbigh, Holt, and Ruthin in sending a member to parliament. It is a station on the Chester and Shrewsbury Railway. Pop. (1861) 7562; (1871) 8576.

**WRIGHT, THOMAS**, an English antiquary and historian, was born near Ludlow, in 1810, and was educated in the grammar-school of that town. From school, he proceeded to Trinity College, Cambridge, where he took his degree of B.A. in 1834, and subsequently that of M.A. At an early age, W. shewed considerable literary talent, and while still at the university, contributed to *Fraser's Magazine*, the *Gentleman's Magazine*, the *Literary Gazette*, and other periodicals. In 1836, he came to London, and at once commenced the career of a man of letters; and from that time till his death he was continually before the public in the capacity of author, editor, or translator. In 1837, he was elected a Fellow of the Society of

Antiquaries; and in the following year, published his first considerable work, entitled *Queen Elizabeth and her Times* (2 vols. 8vo). In this year also, he was one of the two founders of the Camden Society, for which he edited various works at different times, such as the *Latin Poems of Walter Mapes*, *Letters on the Dissolution of the Monasteries*, &c. He was also for some years Honorary Secretary of the Camden Society. In 1843, W., in conjunction with his friend, Mr Roach Smith, founded the British Archaeological Association. He also took an active part in the formation of the Percy and Shakspeare Societies, and for each of these, from time to time, edited volumes. Upon the death of the Earl of Munster in 1842, W. was elected to succeed him as Corresponding Member of the Institute of France, an honour never before attained by one so young. There were several candidates; but W. was chosen by a large majority, among whom were two ministers of state, M.M. Guizot and Villemain. W. was also a member of the Society of Antiquaries of France, of the Ethnological Society of Paris, of the Royal Society of Northern Antiquaries of Copenhagen, and of other learned societies on the continent and in America.

Of W.'s various works—said to exceed 100 volumes in number, including, of course, translations and works edited for Societies—the following may be regarded as the principal: *Biographia Britannica Literaria*, 2 vols., of which the Anglo-Saxon period appeared in 1842, and the Anglo-Norman in 1846; *Essays on Subjects connected with the Literature, Popular Superstitions, and History of England in the Middle Ages* (2 vols. 1846); *The Archaeological Album, or Museum of National Antiquities—the Illustrations by F. W. Fairholt* (1845); *England under the House of Hanover, Illustrated from the Caricatures of the Day* (2 vols. 1848); *Narratives of Sorcery and Magic* (2 vols. 1851); *History of Ludlow* (1852); *The Celts, the Roman, and the Saxon: a History of the Early Inhabitants of Britain down to the Conversion of the Anglo-Saxons to Christianity* (1852; 2d ed. 1861); *History of Ireland* (3 vols. 1854); *Wanderings of an Antiquary* (1854); *Cambridge University Transactions* (2 vols. 1854); *Dictionary of Obsolete and Provincial English* (2 vols. 1857); *History of France* (3 vols. 1856—1862); *Guide to the Ruins of the Roman City of Uriconium, at Wroxeter, near Shrewsbury* (1859); *Political Poems and Songs relating to English History composed during the Period from the Accession of Edward III. to that of Richard III.* (2 vols. 1859—1861). These volumes form part of the series of works published, under the direction of the Master of the Rolls, in illustration of the medieval history of England; *Les Cent Nouvelles Nouvelles* (2 vols. 1858), being a collection of medieval tales from the only known manuscript of the same, discovered by W. in the library of the Hunterian Museum, Glasgow; *Essays on Archaeological Subjects* (2 vols. 1861); *History of Domestic Manners and Sentiments in England during the Middle Ages, with Illustrations by F. W. Fairholt* (1861); *A History of Caricature and Grotesque in Literature and Art, with Illustrations by F. W. Fairholt* (1865). To these may be added his *Womankind in Western Europe* (1869); *Uriconium: a Historical Account of the Ancient Roman City* (1872); and his translations of Pauli's *King Alfred* and of Napoleon's *Julius Caesar*. He died 23d December 1877.

**WRIGHTIA**, a genus of plants of the natural order *Apocynacea*, containing some of the greatest twining shrubs of the East Indies, such as, attaching themselves in the first instance to trees for support, become themselves at last of tree-like thickness, as well as height, and kill the supporting trees by their

choking embrace. The corolla is salver-shaped, with scales in its throat: the fruit consists of two erect follicles. The leaves are simple, generally ovate, or nearly so. The timber of some species, as



*Wrightia tinctoria.*

*W. mollissima* and *W. coccinea*, is valuable. *W. antidysenterica*, a native of Ceylon, yields CONESSI BARK, a valuable astringent and febrifuge; *W. tinctoria*, common in many parts of India, yields excellent indigo, and was strongly recommended for cultivation on this account by Dr Roxburgh, the produce being large, and the plant less dependent on rain than the species of *Indigofera*.

WRIT is a general term much used in the law to denote a formal document proceeding in the Queen's name, or the name of a judge or other officer of the law. Such is a writ of summons commencing an action at law. In nearly all actions and proceedings, writs of various kinds are issued, which are named from the nature of the particular act to be done.

WRITER, a term vaguely applied in Scotland to a law practitioner or his clerk; in provincial towns more definitely to a law agent practising before the sheriff, and acting as factor in the management of private affairs.

WRITER TO THE SIGNET, or CLERK TO THE SIGNET, the name of an important body of legal practitioners in Edinburgh, who derive this designation from having been originally clerks in the office of the Secretary of State, where the different writs that passed under the king's signet were prepared. Act 1537, c. 39, establishing the College of Justice, mentions the Clerks to the Signet as a previously existing body; and though no charter of incorporation is extant, the society is considered entitled to all the privileges of a corporation. The Keeper of the Signet, an officer appointed by the crown, appoints one of the members of the Society of Writers to the Signet his deputy, who is in use to preside at meetings of the Society, and, along with certain other members named by him as commissioners, to manage its affairs. Admission to the Society must be preceded (1) by attendance during two different sessions, or two full winter courses of lectures on the faculty of Arts of a Scottish university; (2) by a five years' apprenticeship; (3) by attendance on four courses of law in the university. Previous to admission, the candidate is examined in scholarship and in law. The whole expense of admission to the Society, including the apprentice-fee of £200, is £410, 15s. 6d. The writers to the Signet have long

been the principal body of law agents practising before the supreme courts of Scotland; and the individual members of the body are also entitled to practise before the Sheriff Court in all matters which have been transferred by statute from the supreme courts to the Sheriff Court, as proceedings in bankruptcy. They possess the exclusive right of preparing the warrants of charters of land flowing from the crown, of signing summonses citing parties to appear in the Court of Session, and all other writs that pass the Signet, as diligences for affecting the person or estate of the debtor. A very considerable proportion of the conveyancing business of Scotland is in their hands, and they are largely employed as factors in the management of private affairs. Most of them are notaries-public. They possess a large and valuable library.

Act 36 and 37 Vict. c. 63 has transferred to a newly-created body, called 'Law Agents,' the exclusive right of practising before both the supreme and the inferior courts of Scotland. Admittance to this body must be preceded by a five years' apprenticeship, which, if entered on after 1873, must be under an indenture duly recorded and intimated to an officer, called the Registrar of Law Agents, within six months from its commencement. A three years' apprenticeship is to be held sufficient in the cases of a person who has been five years clerk to a law agent, is a graduate in law or arts, an advocate in Scotland or barrister in England, or an enrolled attorney or solicitor in England. The applicant is admitted by the Court of Session after an examination by examiners appointed by the court. Persons who, prior to February 1874, were members of the Society of Writers to the Signet, or of the Society of Solicitors before the Supreme Courts, or Procurators before the Inferior Courts, are entitled, on application, to be enrolled as law agents. For three years, from August 1873, the qualifications for admission are relaxed in favour of persons in course of qualifying as procurators, under the Procurators Act, 1865. Before being allowed to practise before the Court of Session, or any inferior court, a law agent must subscribe the roll of that court. Any law agent may, on application to the Court of Session, be admitted a notary-public.

WRITERS' CRAMP, or SCRIVENERS' PALSY, is a peculiar kind of local spasm, in which every attempt to write instantly calls forth uncontrollable movements in the thumb, the index and middle finger, so that the pen starts up and down on the paper, and instead of a legible handwriting, a mere scrawl results. 'The more,' says Romberg, 'the patient persists in his attempt, the more the difficulty of using his pen increases; and to the visible and sensible contractions of the muscles of the thumb, contractions of the forearm, and even of the upper arm, are often superadded. Abnormal sensations, especially of a sense of weight and constriction of the hand, or of pain extending from the upper arm to the back, are occasionally present. It is diagnostic of these attacks that they are instantly arrested when the individual ceases writing; and that the hand is capable of every other combination of movements and exertions.'—*The Nervous Diseases of Man*, vol. i. p. 320. The disease is chiefly confined to middle age, and scarcely ever occurs in women; and there can be no doubt that an occupation entailing much writing predisposes to it, the quality of the paper or of the pen having nothing to do with it. The treatment hitherto pursued, both local and general, has, according to Romberg, been 'invariably ineffectual.' This is, however, too strong a term, since he mentions a case in which Stromeyer applied the principle of division of the muscles to the cure of writers' cramp, and in one

case a brilliant result justified the antispasmodic reputation of tenotomy; the patient being perfectly able to write as early as the fourteenth day after the subcutaneous division of the tendon of the long flexor of the thumb.' The same operation was, however, several times performed by Dieffenbach without success. Mr Solly, in his recently published *Surgical Experiences*, describes several cases of this peculiar affection, in some of which judicious treatment, combined with entire cessation of writing for a considerable time, led to satisfactory results.

WRITING is the art of fixing thoughts in a palpable and lasting shape, so as to make them known to others. There are two principles employed in this process, either separately or jointly—viz., Ideographism and Phonetism. An ideograph is either a picture of the object the idea of which is to be conveyed, or, at a later stage, some symbol which stands, by common consent, for the object, in which case it is called Symbolism. Phonetism, on the other hand, is either Syllabism—i. e., a combination of consonants and vowels which form a word, or component parts of it—or Alphabetism, a system that further breaks up the syllables into their single component parts of vowels and consonants. All systems of writing seem to have originated in ideographism, and to have gradually arrived at phonetism. The pictorial mode of ideography gradually led, as indicated, to the symbolical mode. The former, also called kyriological (Gr. *kyrios*, principal, proper, the opposite of metaphorical or symbolical) writing, contents itself with representing only bodily things, either by fully or partly depicting them, or by merely indicating them by some special characteristic. The latter—the symbolical mode—represents abstract things in accordance with their similarity to corporeal subjects, as in the hieroglyphs of later Egyptian times. Examples of the real delineations of the subjects, or parts of them, which have been replaced by conventional signs, we find at an early period in Egypt, as well as with the Aztecs, with the primitive Assyrians, in ancient China, and in Guiana. Phonetism here no longer aims at a delineation of subjects or symbols, but of the sounds by which these objects are conveyed to the mind. The first step in phonetic writing is, as we said, the syllabic, which by degrees becomes alphabetical. Difficult though it be in many instances to fix accurately the original ideographic meaning of many of the letters now in use, there is yet absolutely no doubt as to their having once been mere pictures of certain things to which a meaning was attached, the sound of which was in some shape connected with the present value of the letter. Our knowledge of Phœnician, whence our alphabet is directly derived, and of its cognate dialects, enables us, in many instances, to trace them back to their primitive source. Thus, our *A* was originally depicted as the head of an ox, a likeness to which may still be traced in its Phœnician form, and its name (Aleph = ox) has still survived in Hebrew and Greek (Aleph or Alpha). This process of the gradual change of a picture into a character is most clearly traceable in the various stages of Egyptian hieroglyphics, which, when written more cursorily, assumed such different shapes (in hieratic and demotic respectively), that often there remains scarcely a likeness between different forms of the same characters. Among the ideographic methods, there are some, however, which scarcely seem to deserve the name of writing, in the ordinary sense. Such are the Peruvian quippos, or knots, which, by changes in colour, size, arrangement, and the rest, indicate a certain special sequence of ideas; further, the

'khernus' or sticks, which, before the introduction of their present alphabet, the Tartars used to circulate among their tribes, to indicate the number of men and horses to be used for some special expedition. Similar to the Peruvian quippos, was (according to the celebrated Chinese work, *I-king*) also the primitive Chinese mode of writing; while the Scandinavian and Germanic runes rather remind of the Tartar staves. Of a more advanced stage appears the Mexican Pichne-writing, a system by which single syllables or words were expressed by phonograms. The Chinese system appears to combine both the ideographic and phonetic characters; but there is scarcely a doubt that even the phonetic signs are derived from ideographic ones. The step to the alphabetic system, however, was never taken by the Chinese.

When and how our present alphabet was invented, has been matter of speculation from the earliest times. The myths of antiquity ascribed it to Thoth (q. v.) or to Kadmus, which only denotes their belief in its being brought from the East (Kedem), or being perhaps primeval. The Talmud ascribes it to a special revelation. It has been a question whether there were several original alphabetical systems, or whether one is to be assumed as having given rise to the various modes of writing now in use. Thus, three principal sources—Semitic, Chinese, Indian—are given by Klaproth. It is, however, now agreed on all hands that it is the Phœnician character, as we now know it, to which we directly owe our own. See PHŒNICIA. From it many streams have flowed out. The principal of these appear to have been—First, the Semitic, in which the values of the letters have remained almost identical with those of the original Phœnician, with exception, perhaps, of a few sounds added to them in Persian, for the purpose of expressing certain Indo-Germanic sounds not existing in Phœnician. This class has further been subdivided into Hebrew—Samaritan and Aramaic, the latter embracing the square or modern Hebrew, which is closely allied to the Palmyrene, the Estranghelo or Syriac, the Sabian, the Arabic in its different forms, the Mongol, the Pehlvi, Armenian, &c. The second or central division embraces the writing of Greece, Asia Minor, and Italy, from the Æolo-Doric, Etruscan, Umbrian, Oscan, and other but little known kinds, to the late Pompeian Graffiti. A further group would include the 'Indo-Homerite' characters, and seems to have originated in Central Arabia, whence it appears to have spread to Africa and India, where the Magadhi—the oldest variation the Phœnician assumed here—gave rise to the five families of Devanaghari, Pali, Dravidian, Oceanian, and Tibetan.

Yet, when we speak of the Phœnician as being the mother of all our known alphabets, we must not be understood finally to ascribe to the Phœnicians the original invention of it in the first instance. We shall only indicate here that the theory to that effect, held by Gesenius and others, will probably, sooner or later, have to give way to the more recent results of De Rouge's investigations, who, with great show of probability, believes it to have been borrowed, or rather adapted from certain archaic hieroglyphics of Egypt. It would appear as if at some very archaic period the Phœnicians had borrowed the hieratic signs then in use; as, indeed, the *Prisee Papyrus*, the oldest in existence, exhibits striking similarities with the Phœnician characters. Instead, however, of simultaneously taking the Egyptian names for these characters, they invented new ones according to their own fancy, and to the supposed similarity of the characters to some particular thing. The Egyptian origin of the Phœnician character, if confirmed by

further researches, would be a striking instance of the correctness of the tradition to that effect, which Tacitus has preserved (*Annal.* xi. 14).

We have in the course of this work treated at full length several points of this subject. See **HIEROGLYPHICS, CUNEIFORM, ALPHABET, &c.** We may therefore, for a fuller elucidation of the details, refer to those articles. We shall only add in this place that the manner of writing is very different with many nations. The Mexican picture-writing begins at the bottom; the Chinese and Japanese, as well as the Mongols, write in columns beginning from the top, and going from right to left. The Egyptian hieroglyphics have no fixed direction; but the hieratic and demotic, though the single letters are formed from right to left, always run from left to right; as is also the case in Ethiopic, Cuneiform, and Indo-Germanic languages generally. The Semitic languages have retained the Phœnician mode of writing from right to left—all but the numerals—a mode still retained in archaic Hellenic and Etruscan. By degrees, however, the writer, not wishing to return to the beginning of the line, and continuing right underneath the last word penned, a double mode was introduced, called the boustrophædon—as the ox ploughs. Finally, this too was abandoned, and the direction from left to right was followed. About the many various styles of modification our characters have undergone in the course of time, the punctuation of the words, and the rest, we refer to **ALPHABET**. The materials used for writing were of the most different kind, as were also the instruments employed for the purpose. See **PAPYRUS, PEN, &c.**

**WRITING FLUIDS.** See **INK.**

**WRONGDOER**, in English law, as well as popular parlance, is he who commits some wrong for which an action may be brought to recover damages.

**WRYNECK** (*Yunx*), a genus of birds of the Woodpecker family (*Picidae*), having a short, straight, conical beak; a long extensile tongue, with



Wryneck (*Yunx torquilla*).

a horny point; wings of moderate size; a rather short and rounded tail; the feet with two toes in front, and two behind. One species, the **COMMON W.** (*Y. torquilla*), is a summer visitant of Britain and the north of Europe. From its appearing at the same time with the cuckoo, it has acquired the name of *Cuckoo's Mate*. It is common in the south of England, but very rare in the northern parts of Britain. It is about seven inches long, of a rusty ash colour, irregularly spotted with brown and black. It feeds on caterpillars and insects, and is often seen on the ground near ant-hills, feeding on the ants and their 'eggs.' The construction of its

tongue resembles that of woodpeckers, and enables it to seize its insect prey with wonderful celerity; the tongue is darted out, and retracted, so that the eye can scarcely follow it; the two posterior branches of the bones of the tongue being much elongated, and muscles for its extension attached to them. There is also a long gland on each side of the lower jaw, which secretes a glutinous mucus, so that insects adhere to the horny tip of the tongue. The **W.** generally makes almost no nest, but deposits its eggs on fragments of decayed wood in the hole of a tree. The young birds are easily tamed, and are great favourites with boys. In France, it is common for boys to tie a string to one of the legs of the bird, and to allow it to climb trees in search of insects. It climbs readily on their clothes. The name **W.** is derived from the habit which the bird has of writhing its head and neck quickly in various directions, with an undulating snake-like motion, which it does particularly if found in its hole in a tree, making at the same time a hissing noise, so as to alarm the intruder; but on his drawing back, it suddenly darts out and escapes.

**WULSTAN**, or **WULFSTAN**, and sometimes **WOLSTAN**, a name of interest in connection with Anglo-Saxon history and literature. There are three individuals of the name especially noticeable.—1. A monk of Winchester in the 9th c., author of a poem, in Latin hexameters, on the Miracles of St Swithun, which is reputed the best Latin poem of that age produced in England.—2. An Archbishop of York, in 1003, author of two pastoral letters and several sermons in Anglo-Saxon, the most remarkable of which is printed in Hickeys's *Thesaurus*, vol. iii.—3. The well-known Bishop of Worcester, and a saint of the English calendar. He was born at Icentum, in Warwickshire, about 1007, and educated at Evesham and Peterborough. He became a priest, afterwards a monk and prior of the monastery of Worcester, and ultimately, in 1062, bishop of that see. He lived through the troubles of the Norman Conquest, and enjoyed the favour not only of the Conqueror, but of William Rufus, and died in 1095, at the age of 87. He is by some reputed the author of the portion of Anglo-Saxon Chronicle which extends from 1034 to the death of the Conqueror.

**WUPPERTHAL**, a celebrated valley of Rhenish Prussia (q. v.), derives its name from the river Wupper, or Wipper, a small affluent of the Rhine, which rises between the towns of Wipperfürth and Hückeswagen, 26 miles north-east of Cologne. Its course is first north, then north-west, past Barmen (q. v.) and Elberfeld (q. v.)—the chief town on its banks—then south-west to its junction with the Rhine between Wiesdorf and Rheindorf, 7 miles below Cologne, after a course of 50 miles. The waters of the Wupper are very abundant, and for the length of its course it supplies motive-power to an extraordinary number (about 400) of mills, of various kinds. It is navigable for small craft below Solingen (q. v.). The Valley of the Wupper is the most actively industrious and most densely peopled in all Germany. Coal is found in abundance.

**WURNO**, a town of the Hansa States, Central Africa, 18 miles north-east of Sôkoto, on the Sôkoto, a tributary of the Niger. It is extremely filthy—the small ravine which intersects the town forming a most disgusting spectacle. Barth expresses his astonishment at the quantity of cotton brought into the market, which shewed what the fine vales in the vicinity are capable of producing. The pop. is stated at from 12,000 to 13,000.

**WÜRTEMBERG**, THE KINGDOM OF, lies in 8° 15'—10° 30' E. long., and 47° 35'—49° 35'

## WÜRTEMBERG.

N. lat., is bounded on the W., S.-W., and N.-W. by the Grand Duchy of Baden; E., S.-E., and N.-E. by Bavaria; and S., for a few leagues, by the Lake of Constance and Vorarlberg. Hohenzollern makes a deep indentation into the land from the south, and the entire boundary is very irregular. Detached pieces of territory belonging to W. also lie in the adjacent countries. Its greatest length, from the village of Simmingen in the north, to the Lake of Constance in the south, is 139 miles; and greatest breadth, from the Katzenkopf, in the Black Forest, eastward to the castle of Duttstein in Nerstein, 105 miles. The following table gives the pop., according to the census taken December 1, 1871, and the area in sq. miles (pop. in 1875, 1,881,505):

Circles.	Area in Square Miles.	Population (1871).
The Neckar, . . . .	1285	548,750
" Black Forest, . . .	1843	448,160
" Jagst, . . . . .	1986	384,714
" Danube, . . . . .	2418	436,915
Total, . . . . .	7532	1,818,539

Since 1867, the population had increased, in the Neckar Circle, 47 per 1000; in the Danube Circle, 22 per 1000; and in each of the other two, 7 per 1000.

The capital of W. is Stuttgart (q. v.), and there are 3 other towns in the kingdom with a pop. above 17,000—viz., Ulm, Heilbronn, and Esslingen. The various districts have no natural capital, and Stuttgart has no rival as to pop. or importance.

*Physical Aspect.*—The surface of W. is composed of terraces of hill and dale, the lowest point being 420 feet above the sea. In the Black Forest Circle the mountains attain the highest elevation, the Hornsgrinde rising above 3700 feet. One point of the Swabian Alps is nearly 3000 feet high. The valleys and plains average 500 feet above the sea. Rich pastures, cultivated fields, orchards, gardens, hills covered with vines, and mountains with forests, give the most diversified scenery. In the southeast are extensive peat-lands.

*Rivers, Lakes, &c.*—The most important rivers are: the Neckar (q. v.), with its affluents; the Danube, which receives the Iller; and the Tauber, a tributary of the Maine. The Neckar and its streams drain 4200 sq. m.; the Danube, 2037; the rivers which fall into the Lake of Constance, 714; the Tauber, 315; and other water-courses, 168 sq. miles. The only lake in the interior is the Fedarsee, near Buchau, in the Danube Circle. There is much traffic both by steam and sailing ships on the Neckar, and from Friedrichshaven, on the Lake of Constance.

Railways have been constructed to the extent of 780 English miles, from Bruchsal to Ulm, Ulm to Friedrichshaven, Bietigheim to Hall, Cannstatt to the Bavarian lines, and from Plochingen by Tübingen and Rottweil into Baden and on to Schaffhausen. There were, in 1871, 445 post-offices, which forwarded 14,800,000 private letters, about 4,000,000 official letters, and near 21,000,000 newspapers. The postal income in 1875 was 4,919,400 marks, the expenditure about 200,000 marks less. Of telegraphs, there are 1500 miles in operation.

*Geology, Mineralogy, &c.*—The prevailing rocks are granite, gneiss, limestone, and various sandstones. Tourmaline, cobalt, bismuth, silver, malachite, chalcodony, gypsum, copper, rock-crystal, and iron occur. A great variety of fossils have been found. The peat-lands are extensive, and yield annually 450,000 florins. Fire-clay of excellent quality, earths for dyeing, and native sulphate of lime, are worked. Building materials, from the

granite of the Black Forest to the tufts of the Alb Valley, abound. Clay-band ironstone, yielding from 30 to 36 per cent. of iron, is worked in eleven different districts, and salt in five. The annual value of mineral products is about £200,000. In 1874, 10,816 tons of iron were produced, valued at £86,113. There are many springs of mineral water, those of Cannstatt and Stuttgart being much frequented.

The climate is mild and healthy, but in the highlands the winters are long and cold. When west winds prevail, the cold of winter and summer heat are less than in some countries in the same latitude. The greatest quantity of rain falls in summer. Of the total area about 25 per cent. is occupied by plains or level ground, 46 per cent. is hilly, and 29 per cent. mountain land. The soil is for the most part very fertile and well tilled. The vineyards are chiefly in the Neckar Circle and that of the Jagst. The forests, grain, and pasture lands are nearly equally distributed throughout all the circles. Wheat, oats, barley, rye, potatoes, beans, maize, turnips, mangold-wurzel, lucerne, &c., are the principal agricultural products. There are extensive orchards in all parts of the land. Cherries, damsons, walnuts, peaches, apricots, and the more common fruits, are largely grown. Timber is largely grown and exported, especially from the Black Forest regions. Large and small cattle are plentifully reared. Large cattle, which in W. are generally fed in the stall, constitute the principal export of W. to Switzerland and neighbouring lands. Forestry and the various branches of agricultural science are diligently promoted by numerous technical institutes.

*Manufactures, Industries, &c.*—The manufactures are chiefly linen, woollen, cotton, and silk fabrics. Wool and cotton spinning, bleaching, dyeing, printing, iron-founding, making machinery, cutlery, gold and silver articles, glass, porcelain, earthenware, tile, cabinet-work, sawing wood, carriage-building, grinding corn, book-printing, and the cognate trades are principal industries. There are many oil-mills, beer-breweries, and brandy distilleries. Water is to a large extent the motive-power employed in the manufactories and mills. In W., more than 215,500,000 bottles of beer, or 125 for each person, are consumed yearly, besides wine, brandy, and liqueurs. The total value of land, houses, railways, movables, &c., is reckoned at 2710 million florins, and the income of the people at 276,000,000—140,000,000 being from land produce, 131,000,000 from the industries, and 5,000,000 from interest on foreign funds. The exports are chiefly grain, cattle, wood, salt, oil, leather, woollen, cotton, and linen goods, beer, &c.

*Religion, Language, Education, &c.*—The population of Old Würtemberg is almost entirely Lutheran. The numbers of each denomination in 1871 will be seen in the subjoined table:

Circles.	Evangelical Lutherans.	Roman Catholics.	Other Christians.	Jews.
The Neckar, . . . .	497,826	44,389	2,280	4,227
" Black Forest, . . .	329,960	116,121	746	1,328
" Jagst, . . . . .	264,479	115,752	459	4,024
" Danube, . . . . .	156,595	277,280	372	2,666
Total, . . . . .	1,248,860	553,542	3,857	12,245

Of 1,793,160 marks set apart in the budget of 1875—1876 for 'Church and School,' a great part was expended on the support of the various religious bodies.

Several dialects of German are spoken, of which the Swabian and Franconian are the most general. W. has been the native country of many distinguished men, of whom a few may be mentioned. In poetry:

Schiller, Uhland, Wieland, Kerner; in theology and philosophy: Brentz, Ecolampadius, Bengel, Schelling, Hegel, Baur, Strauss, &c.; in science and art: Kepler, Stiefel, Tobias Mayer, the botanists Joseph and Karl Friedrich Gärtner, the chemist Schönbein, the painters Eberhard Wächter, Hetch, and the famed sculptor Dannecker.

Every child between 7 and 14 years must attend school. In a district having 30 or more families, is a public school, and a teacher for every 90 children. There are four Protestant theological seminaries, with a course of four years; gymnasia, grammar, trades, and high schools in all the principal towns. The university at Tübingen has 80 ordinary and extraordinary professors and tutors. The number of students varies from 700 to 850, of whom 200 to 300 are foreigners. At Hohenheim is an agricultural and botanical institution, in which farming, management of forests, and gardening are scientifically taught. Stuttgart has a polytechnic school, which is one of the best institutions of the kind in Germany. The government outlay on education amounts annually to nearly 1,000,000 marks.

*Revenue, Expenditure, &c.*—For the year 1875—1876, the revenue was 44,337,267 marks, which just covered the expenditure. The civil list and appanages amount to 2,101,783 marks; interest of the national debt, 15,892,766 marks. Of the income, 21,920,965 marks came from public property, and 20,003,240 marks from direct and other taxes. The railways yielded 12,520,000 marks, and the post-office 177,125 marks of clear revenue. The troops of W. form the 13th corps d'armée of the German empire.

*Government, &c.*—The crown is hereditary in the male line, and failing that, in the female. Freedom of the press and religion are enjoyed. The privy-council consists of a president, the six ministers of state, and members named by the king. The legislative body is composed of two chambers—the first being formed of princes of the royal family, nobles, and members appointed by the king, the last named not exceeding a third part of the whole; the second chamber is composed of 13 representatives of the knighthood, 6 Protestant general superintendents, the bishop and two others of the Catholic clergy, the chancellor of the university, 7 representatives from the cities Stuttgart, Tübingen, Ludwigsburg, Ellwangen, Ulm, Heilbronn, and Reutlingen, with a representative from each of the 64 bailiwicks. Members of the second chamber are not eligible as such before reaching their 30th year. The king has the power of proroguing or dissolving the chambers; but in the latter case, a new election must take place within six months. As a member of the re-constituted German empire (1871), W. has 4 votes in the Federal Council, and 17 representatives in the Diet of the empire.

*History.*—The earliest inhabitants of W. were probably Celts; but when the Romans came first to know the country, it was held by the Suevi, who were succeeded by the Alemanni and the Franks. In 1090, Conrad, Count of Württemberg, possessed a castle near Cannstatt, and limited territories, which were largely added to by Ulric I. from 1246 to 1265. Other extensions were gained by Eberhard I. between 1279—1325; by Ulric II., who, though a man of peace, added Tübingen; Eberhard II., who secured Teck, Gutenberg, Kirchheim, Herrenberg, and other places. By the marriage of Eberhard IV. with the Countess of Montbéliard, that county became connected with Württemberg. At his death, the possessions were divided between his two sons, each of whom enlarged his portion; and a few years after their death, Eberhard V. secured a reunion, and the land advanced rapidly in power

and importance. In 1495, the Emperor Maximilian raised Eberhard to the rank of Duke, with the title of Eberhard I. In 1519, Duke Ulrich having offended the Swabian League by some arbitrary acts of oppression exercised upon the imperial free city of Reutlingen, he was forcibly ejected from W., and did not reconquer his estates till 1534. While Eberhard III. was Duke (1628—1674), W. suffered much in consequence of the Thirty Years' War. Ludwig Eugene (1793—1795) having taken part in the war against the French Republic, a French army attacked and compelled him to resign Montbéliard, and pay 8,000,000 francs.

With Duke Frederick II., who succeeded his father in 1797, the most important period in the history of W. begins. In 1800, compelled by the French to flee from his dukedom, he got back, by the Peace of Lunéville, all his territories except Montbéliard, and instead, had others granted, with the rank of Elector. Having aided Napoleon in the war against Austria, at the Peace of Presburg (26th December 1805), W. was further enlarged, and made a kingdom. After the battle of Leipzig, Frederick abandoned the cause of Napoleon, and concluded a treaty with Austria, in which his lands were guaranteed. His reign was arbitrary; and internal troubles were thickening around him, when he died (30th October 1816), and was succeeded by his son, William I., who was born at Lubin, in Silesia, 27th September 1781. He was cordially welcomed to the throne, and the expectations of his subjects were realised. His first acts were to reduce the expenditure, and introduce other reforms, prominent among which was the liberal constitution of 1819. In 1848—1850, a strong agitation was kept up with the view of obtaining some permanent modifications in this constitution, but without success. For nearly 50 years, he reigned over a people steadily increasing in prosperity, and died 25th June 1864, at Rosenstein Castle. His son, Charles Frederick Alexander, now Charles I., born March 6, 1823, succeeded him. See GERMANY, in SUPP., Vol. X.

WÜRZBURG, a former sovereign bishopric or ecclesiastical principality of the German Empire, was founded in 741 (according to other accounts, 742 or 746), and received endowments from the Frankish kings, which were afterwards increased by the German emperors. The first bishop was Burkhardt, who was consecrated by Boniface. The patron saint was Kilian (q. v.), who is said to have preached the gospel here as early as 688. By good management and economy, the bishops were able to acquire numerous possessions of the neighbouring Frankish proprietors; and out of these was gradually formed the extensive sovereign bishopric of W., ruled over by the prince-bishop as Duke of Franconia. The ducal title and authority were first conceded about 1120. In spiritual matters, the bishops were under the Archbishop of Mainz. The area of the bishopric was as much as 1827 sq. m., with a pop. of 250,000, and a yearly revenue of 500,000 gulden. At the Peace of Lunéville (1801), the bishopric of W., like the other spiritual principalities of Germany, was secularised; and in 1803, the greater part of it was conferred on the Elector of Bavaria as a secular principality. The last prince-bishop received a pension, and died at Bamberg in 1808. At the Peace of Presburg (1805), Bavaria gave up W. to the Grand Duke Ferdinand of Tuscany, and the principality was raised to the dignity of an electorate. In 1806, the Elector Ferdinand joined the Confederation of the Rhine, and from that time took the title of Grand Duke of Würzburg. By a decree of the Vienna Congress, the grand duke received his hereditary state of Tuscany, and W. reverted to Bavaria. At present, the greater

part of the bishopric belongs to the circle of Lower Franconia.

WÜRZBURG, capital of the former principality of Würzburg, now of the Bavarian circle of Lower Franconia, is situated in a beautiful valley on both sides of the Maine, over which there is a stone bridge 600 feet long, of eight arches. The number of inhabitants amounts to (1871) 41,008, of whom 6200 are Protestants. Among the public buildings, the most distinguished are the Episcopal Palace or Residence, rebuilt in 1720—1744, one of the most magnificent royal residences in the world; and the spacious and excellently fitted-up Julius Hospital, established in 1576. Of the numerous churches, the most worthy of notice are the richly-decorated cathedral, which was rebuilt in the 11th and following centuries; the Marien-kapelle, one of the most beautiful monuments of old German art, with 14 statues of the 15th c. by Tilmann Riemenschneider; and the Neumünster Church, containing the bones of St Kilian. The streets adjoining the Palace Square are wide and straight, but most of the others are narrow and crooked. In front of the Julius Hospital there is a bronze statue of the founder, Bishop Julius, by Wiedemann, founded in bronze by Miller; a monument of Walther von der Vogelweide (q. v.) stands in a niche outside the Neumünster Kirche.

The university of W. was founded in 1582 by Bishop Julius, who also founded the hospital above mentioned. The endowments for both institutions were taken from the possessions of the convents that were destroyed during the Peasant War (q. v.). In order to promote the study of medicine, the hospital was put in connection with the university, the professors of medicine being made physicians and surgeons to the hospital; this connection has all along kept the medical faculty in high reputation, and promoted the prosperity of the university as a whole. The present medical staff includes several names of European reputation, among others, Kölliker (q. v.). All the professors of the theological faculty are thoroughgoing Infallibilists. There is also a faculty of political economy. In the summer session 1875, there were 951 matriculated students. The library contains above 100,000 vols. In the Musical Institute, any one can receive instruction gratis in singing or in playing on any instrument; and twice a week there are great musical pieces performed. In W., besides the university, there is a gymnasium, a Latin school, a district agricultural and trade school, a seminary for Catholic priests, and a seminary for training teachers, an orthopedic institution, a veterinary school, a school for midwifery, a swimming school, a society for the improvement of the arts and manufactures, and a female society for the encouragement of skill in arts and handicrafts among women. Besides the Julius Hospital, there are asylums for the deaf and dumb and for the blind, and other charitable institutions. The manufactures are woollen stuffs and cloth, mirror-glass, leather, tobacco, railway carriages, and sparkling wines. The fortress of Marienberg, built on the site where Drusus founded a castle, is situated on a hill 400 feet high, on the left bank of the Maine, outside the town. The campaign of the Prussian army of the Maine ended with an action fought before W., 27th July 1866. The fortifications have been demolished. The industry of W. has greatly prospered during the last ten years.

WÜRZEN, a small walled town of Saxony, 15½ miles east of Leipzig, picturesquely situated and surrounded by romantic valleys, on the Mulde, here crossed by two bridges. Pop. (1871) 7850,

employed in brewing, bleaching, weaving, and hosiery-work. It is a station on the Leipzig and Dresden Railway.

WYANDOTS, a tribe of North American Indians, of the Iroquois family, the Hurons of the French writers, who called themselves Wendats or Yendats, first known at Montreal, where, in the middle of the 17th c., they became Roman Catholics under the instructions of the French missionaries. Having, as allies of other tribes, become involved in a war with the Iroquois, they were nearly exterminated, and the remnant emigrated to the country around Lake Superior; then gathered at Mackinaw, 1670, under the care of Father Marquette, thence came to Detroit, where they furnished 400 warriors to the English in 1812. In 1829, they were settled, to the number of 600, on the head-waters of the Sandusky River in Ohio; and in 1832, by a treaty with the United States government, removed to Kansas, where the few remaining have acquired the rights of citizenship, each having of their divided lands a farm of 40 acres.

WYATT, RICHARD JOHN, an English sculptor of great eminence, was born in Oxford Street, London, on the 3d of May 1795. He belonged to a collateral branch of the family which made the name of Wyatt famous during two centuries in connection with architecture and sculpture, sharing their descent from a stock of yeomen long settled at Weeford in Staffordshire. Having the bias of his family towards art, he became an articulated pupil of Charles Rossi, R.A., sculptor, and afterwards a student of the Royal Academy, whose medal was twice awarded to him during his pupillage. He afterwards passed some time in Paris, studying under Bosio; and from Paris, in 1821, he went to Rome, and entered the studio of Canova, where he had Gibson for a fellow-pupil. The remainder of his life was spent in Rome, in complete devotion to the prosecution of his art; and he died at Rome on the 29th of May 1850. His youth had shewn great promise, in the estimation of painters like Lawrence and sculptors like Canova; and the works which he produced in rapid succession, early placed him in the front rank of English sculptors. Several of his works were shewn at the Great Exhibition of 1851, and the medal for sculpture was awarded to him, though he had died in the previous year. Living only for his art, he laboured at it incessantly—often, it is said, from dawn till after midnight; and the number of his works is very great. Elegance and refinement, singularly combined with animation and finish of workmanship, are his characteristic merits, but his works also disclose a lively and graceful invention. His favourite subjects were classical and poetical. His most admired productions are in England, and casts from several of them are to be seen at the Crystal Palace. He was not admitted to the honours of the Academy, a by-law of that institution confining its membership to artists resident in England.

WYATT, SIR THOMAS, was born in 1503, at Allington Castle in Kent. His father, Sir Henry Wyatt, of a family originally of Yorkshire, stood high in favour with Henry VII.; and not less so with Henry VIII., who succeeded him. In 1515, the young W. was entered at St John's College, Cambridge, where in due time he took his degrees of Bachelor and Master of Arts. Whilst still very young, he was married to Elizabeth Brook, daughter of Lord Cobham. Through his father's influence, a career at court was open to him. In this sphere he was thoroughly well qualified to succeed; he was one of the most accomplished men of his day; of a noble presence and fine manners, and withal dexterous and subtle in the management of affairs,



though of unimpeached honour and integrity. In 1536, he received at the hands of the king the honour of knighthood; and the next year he was made high sheriff of Kent. Though necessarily involved in much perilous court intrigue, he continued—though once or twice in some hazard of losing it—to retain the favour of the king, and was frequently employed by him in positions of trust and importance. His chief service was rendered, as English ambassador at the court of Charles V., in which capacity he acquitted himself with much diplomatic tact and skill. In 1542, in token of the king's appreciation of his services, he received a grant of lands, at Lambeth; and the year after, he was named high steward of the king's manor at Maidstone. He had now very much withdrawn himself from public life, and lived for the most part retired at Allington. On the 11th of October 1542, he died at Sherborne, of a fever contracted, it is said, on an overhasty journey caused by a sudden summons to attend the king.

Among the other accomplishments of W. was that of verse, which he seems to have begun to cultivate early, and continued through life to practise. During his life, he had acquired considerable reputation as a poet; and in 1557, his poems, along with those of the celebrated Surrey, were published in London. As marking a stage in the progress of our early literature, they hold a permanent place. His love poetry is somewhat overrun with conceits derived from the study of Italian models; but some of the shorter pieces are models of grace and elegance. His satires also possess very considerable merit. More lately, in 1815, an edition of his works, in two volumes, was published in London.

WYATT, SIR THOMAS, surnamed 'the Younger,' to distinguish him from the preceding, of whom he was the only son, was born about 1520. After a wild and riotous youth, he raised a body of men at his own expense, and did good service at the siege of Landrecies (1544), displaying considerable military talent; and continued in honourable service on the continent till 1550. In 1554, when the Spanish match was in agitation, W. joined the insurrection, and led the Kentish men to Southwark, after gaining considerable successes over the royalists; but failing to capture Ludgate, he became separated from the main body of his followers, and was taken prisoner, and soon after executed, 11th April 1554.

WYCHERLEY, WILLIAM, a comic dramatist of the period of the Restoration, was born at Clive, near Shrewsbury, in 1640. His father, a cavalier squire of £800 a year, sent his son to France at the age of 15; and during his residence on the banks of the Charente, the youth was a favourite at the court of the governor of Angoulême, whose accomplished wife, the Madama Rambouillet of Voiture, converted him to the creed of the Church of Rome. On his return to England in 1660, W. studied a short time at Oxford, where he was reconciled to the Anglican Church, and he was entered of the Middle Temple. His first comedy, *Love in a Wood*, was acted with great applause, and published in 1672, and it was followed by three other successful comedies, *The Gentleman Dancing-master*, 1673; *The Country Wife*, 1675; and *The Plain Dealer* (his best work), 1677. About 1680, the dramatist was married to a young and rich widow, the Countess of Drogheda, whom he had met at Tunbridge. The lady was distractedly jealous of him, kept him from frequenting the court, which lost him the favour of the king, and watched him closely wherever he went. She did not live long, and she left him the whole of her fortune; but his succession to the estate

was disputed, and an expensive lawsuit ensued, the costs of which, added to personal debts, fairly broke down the unlucky dramatist. He was committed to the Fleet, and suffered to languish there neglected for seven years. He was partly relieved by the bounty of James II.—probably because he returned to the communion of the Church of Rome—and he succeeded to the patrimonial estate in Shropshire by the death of his father. This did not, however, much relieve him, as the estate was heavily mortgaged, and strictly entailed. He was on bad terms with the heir-at-law, his nephew; and on purpose to injure this relative, W., at the age of 75, married a young girl, on whom he settled a jointure; and eleven days after this transaction—the last and perhaps the most scandalous act of his life, as Macaulay describes it—the old dramatist died. His death took place in December 1715, and he was interred in St Paul's Church, Covent Garden. Besides his comedies, W. published a volume of wretched *Miscellany Poems*, 1704; and another volume, partly consisting of 'moral reflections,' was published after his death. The comedies of W., on which his fame rests, reflect the literary taste, the manners, and vices of the times in which he lived. They are, in truth, grossly immoral and profligate. They have, however, some literary excellence. The language is clear and forcible, the dialogues often witty and lively, some of the characters vigorously drawn, and the observations and maxims scattered throughout the different scenes are shrewd and sensible, and expressed in a terse sententious style. W. was the founder of that school of artificial comedy which Congreve, Farquhar, and Sheridan carried to its highest perfection, imparting to it an airy grace and brilliancy far above the reach of its first master.

WY'COMBE, CHIPPING OR HIGH, a municipal and parliamentary borough in Bucks, surrounded by beech-clad hills, 23 miles west-north-west of London, on the Wye, a small affluent of the Thames. The church of All Saints is a large and handsome building, erected in 1273; it is in the Norman and early English style of architecture, and consists of a body and two aisles, and, with the chancel, is 180 feet long. The tower is 96 feet high, and was built in 1522. There are corn and paper mills on the Wye; beech-wood chairs are made here, and lace-making is carried on. At two miles' distance is the village of West Wycombe. Since 1867, the borough returns one member to parliament. It is connected with the Great Western Railway. Pop. (1871) of municipal borough, 4811; of par. b. (which includes Chipping Wycombe townships), 10,492.

WYE, a river of England, of great picturesque beauty and considerable importance, an affluent of the Severn, has its origin in two copious springs which issue from the south-east side of Plinlimmon, not two miles from the head-water of the Severn (q. v.). It flows in a south-east direction through Montgomeryshire and Radnorshire, forming the south-west and south boundary of the latter, east-south-east to the middle of Herefordshire, and then south, dividing in its lower course the county of Monmouth from that of Gloucester, and entering the estuary of the Severn below Chepstow. Length of course 130 miles, for 70 miles of which to Hereford it is navigable for barges, though large vessels cannot ascend above Chepstow Bridge. At Chepstow (q. v.), the tide rises higher than at almost any other place in Great Britain. The chief affluents of the W. are the Lug and Ithon on the left, and the Monnow, the Caerwen, and Irfon on the right. The part of the river which separates Monmouth from Gloucester is that chiefly visited for its singular beauty.

**WYKEHAM, WILLIAM DE**, was born at Wickham, in Hampshire, in 1324. He was educated at Winchester. On October 8, 1366, by the king's recommendation, he was elected Bishop of Winchester. He was consecrated October 10 of the year following. Meanwhile, he had been appointed Lord High Chancellor of England; in which office he was confirmed September 17, 1367. He resigned on March 14, 1371, on a petition being presented to the king against the government remaining too long in the hands of men connected with the church. He now devoted himself to various objects of lasting usefulness. His preparatory college or school at Winchester was opened for teaching in 1373; but the building of the college was not begun till 1387. It was finished in 1393. In the college which he instituted at Oxford, teaching had also begun in 1373; but the building of 'St Mary's College of Winchester in Oxford' was not begun till 1380; it was finished in 1393. He began the rebuilding of Winchester Cathedral in 1395, and just lived to see it finished. Meanwhile, he had become the object of resentment to the Duke of Lancaster and party, at whose instance he was indicted for pecuniary defalcation, and other crimes alleged to have been committed by him as Keeper of the Privy Seal and Lord Chancellor. He was heard in 1376 before a commission of peers, bishops, and privy councillors, declared guilty, and a severe sentence was passed upon him. It was, however, ultimately commuted into a fine, which was remitted on the accession of Richard II. in 1377. He was one of the council of 14 appointed to the king in 1386, and in May 1389 he was again made Lord Chancellor. He continued in office till September 27, 1391, when he resigned; and from this date he appears to have taken little active part in public affairs. He was present in the parliament held on September 30, 1399, when Richard II. was deposed. He was also present in the first parliament of Henry IV. He died at South Waltham, September 27, 1404.—See *Life* by Dr (afterwards Bishop) Lowth (Lond. 1754). W. of Wykeham was one of the most munificent benefactors of the English Church; but he was not a fanatic. He loved learning, order, civilisation, and purity of manners; and as Bishop of Winchester, signalled himself by his rigorous reformation of ecclesiastical abuses; but he had not the slightest tendency towards *Protestantism*, affording, in this respect, a most striking contrast to his great contemporary Wicliffe (q. v.). W. of Wykeham may be taken as the type of a class of English Churchmen both before and after the Reformation—men who are destitute of zeal on questions of doctrine, but zealous for the dignity, culture, and practical efficiency of the church.

**WYNTOUN, ANDREW**, an old rhyming Scottish chronicler, lived in the beginning of the 15th century. Except that he was prior of the monastery of St Serf on Loch Leven, and wrote *The Orygynale Cronykil of Scotland*, well known and valued by students of that kind of curious literature, almost no information regarding him has been preserved. Though with the usual proportion of extravagant fable, his work is not without considerable historical importance; while philologically it has very distinct value, as a specimen of the old Scotch, then as nearly as might be identical with the contemporary dialect of England. *The Orygynale Cronykil* consists of nine books or cantos, of which only the last four are devoted to Scottish history; the first five giving a fragmentary outline of the history and geography of the ancient world. From his quotations, W. seems to have been a well-read scholar for his time.

His style is not essentially different from Barbour's, and his versification is the same—the pleasant octosyllabic. In 1795, a splendid edition of this work was published by Mr D. Macpherson; and this edition has been revised and enlarged by D. Laing, LL.D. (2 vols. 1872; vol. 3 has not yet appeared).

**WYO'MING**, a territory of the United States, formed in 1868, with an area of 97,883 square miles, lies between 41° and 45° N. lat., and 104° and 110° W. long. Its boundaries are—N., Montana; E., Dakota and Nebraska; S., Colorado; S.W., Utah; W., Idaho. It is a very mountainous region, elevated from 2500 to 3000 feet above the sea-level. The chief ranges are the Wind River range of the Rocky Mountains, in the W.; the Big Horn Mountains, near the centre; and the Black Mountains, in the N.E. The Missouri, Columbia, and Colorado have their sources within this territory; and other important rivers are the Green River in the south-west, a fork of the Platte in the south-east, and in the north-west the Yellowstone (q. v.). The Laramie Plains in the S. form a tableland of 7000 square miles in extent. The soil of the valleys is moderately fertile, and there is good pasturage. W. is rich in minerals, which embrace iron, copper, lead, coal, silver, and gold. Mineral springs abound. Population (1870) 9118. Cheyenne, the chief city, is connected by railway with Denver. The Union Pacific Railway traverses the S. of W.

**WYO'MING VALLEY**, a beautiful, fertile valley on the Susquehanna River, in Pennsylvania, U. S., 21 miles long by 3 wide, surrounded by mountains 1000 feet high, its name supposed to be a corruption of the Indian *Maughwauwame*—large plains. It was purchased about 1765 by a Connecticut company from the Delaware Indians; but the settlers were soon dispersed by hostile savages. In 1769, 40 families came from Connecticut, but found a party of Pennsylvanians in possession, and for several years there were continual contests of the settlers with the Indians, and with each other. The Connecticut colony finally succeeded, and their town of Westmoreland had 2000 inhabitants. In 1776 they armed for their own defence against the English and their Indian allies; but in 1778, most of their troops were called to join the army under Washington. June 30, a force of 400 British provincials, or 'Tories,' and 700 Seneca Indians, led by Colonel John Butler, entered the valley, and were opposed by 300 men, under Colonel Zebulon Butler. On July 3, the settlers were driven to the shelter of Fort Forty, with the loss of two-thirds of their number, many soldiers and inhabitants being murdered; a half-breed Indian woman, called Queen Esther, having, in revenge for her son's death, tomahawked fourteen with her own hand. On the 5th, the remnant of the troops surrendered, and they and the inhabitants were either massacred or driven from the valley, which was left a smoking solitude. Campbell's *Gertrude of Wyoming*, founded upon the stories of this disaster, contains exaggerations and misstatements, notably that of attributing the leadership to Brandt, who was not in the expedition. The disputes between the Connecticut and Pennsylvanian settlers were not finally settled till the commencement of this century. The valley is now one of the most flourishing districts in the state.

**WY'VERN**, a fictitious monster of the middle ages, frequently occurring in heraldry. It resembles a dragon, but has only two legs and feet, which are like those of the eagle.



Wyvern.

# X



THE last letter of the proper Latin alphabet, and the last but two of the English. It is in reality a superfluous character, being equivalent in English, as it was in Latin, to *ks* or *gs*. In form, it corresponds to the Greek  $\chi$ , but in power to Greek  $\xi$ . It was a later addition to the Latin alphabet, having been introduced, according to Corssen, between the time of the Decemvirate and the fall of Veii. Some Roman scholars did not acknowledge the character, but wrote *cs*, *gs* instead; and this substitution frequently occurs in inscriptions (e. g. *ucsovi*, for *uzovi*). At one period of Roman literature, *xs* was often written for *x*; e. g., *saxsum*, *lexs*. In the popular pronunciation, the guttural element of the character gradually disappeared, until, in the later period of the Empire, *x* was undistinguishable from *ss* or *s*; thus, inscriptions shew *visit* for *visit*, *miles* for *miles*. This change survives in modern Italian, which substitutes *ss* or *s* for the Latin *x*, as *sasso* = *saxum*; *straneo* = *extraneum*; and uses *x* only in foreign words. In Spanish, in the beginning of words, *x* has a guttural sound, something between *ch* and *y*. In German, the use of *x* is mostly confined to foreign words; in native words the sound is usually represented by *ch*, as *wachsen*, to wax or grow, though some write, e. g., *axe* for *achse*.—In Algebra, *x* is the usual symbol for the unknown quantity which is to be determined.

**XANTHEINE AND XANTHINE OF FLOWERS.** The colouring matters of various flowers have been carefully examined by Fremy and Cloez, who believe that the various tints may be referred to three distinct substances, of which one is of a blue or rose colour, while the other two are yellow. These pigments have received the names of *Cyanine*, *Xanthine*, and *Xantheine*; the first being derived from the Greek *kyanos*, sky-blue; and the last two from *xanthos*, yellow. None of these substances have, however, been extracted in a pure condition, and hence nothing definite can be stated regarding their composition or properties.

**XANTHINE, OR XANTHIC OXIDE** ( $C_{10}H_8N_4O_6$ ), was first described by Dr Marcet, who regarded it as a very rare constituent of urinary calculi, and from its composition he gave it the name of *uric oxide*. During the last ten years, it has been proved to be a normal ingredient (although to a very small amount) of human urine, and has been found in the brain, the spleen, the pancreas, and the liver of the ox; in the thymus gland of the calf; and in the muscular tissue of the horse, the ox, and of fishes; as well as in the liver of various animals. Calculi composed of this substance are extremely rare, the total known number obtained from the human subject being less than half a dozen. They are of a light-brown cinnamon colour, assume a waxy appearance when rubbed, and consist of concentric layers easily separable from one another. *Xanthine* occurs in such very minute

quantities in the various tissues, and is so rare an ingredient of calculi, that it is unnecessary for us to enter into any description of its properties, further than to state that, when dried, it exists as a yellowish white powder, which assumes a glistening appearance when rubbed, and exhibits no signs of crystallisation under the microscope; moreover, the chemical difficulties of detecting traces of this substance are so great, that we shall not attempt to describe its tests. It seems to be intermediate to uric acid and hypoxanthine, both in a chemical and a physiological point of view. The composition of uric acid is represented by the formula  $C_{10}H_4N_4O_6$ , that of xanthine by  $C_{10}H_8N_4O_6$ , and that of hypoxanthine by  $C_{10}H_8N_4O_5$ . The former two occur simultaneously, not only in the urine, but in the spleen, the liver, and the brain; while xanthine is not only invariably accompanied by larger or smaller quantities of hypoxanthine, but the latter can be made by the oxidising action of nitric acid to yield a product from which xanthine (in place of hypoxanthine) may be obtained by a process of reduction. Xanthine must be regarded as a higher stage of oxidation of hypoxanthine, and a product of the regressive metamorphosis of the tissues, which, in the ordinary condition of the system, is excreted in a more highly oxidised form of urea, uric acid, &c.

This substance is stated to have been found by Gûbel in some oriental bezoars, extracted from the intestines of certain ruminating animals. It is most probable that the supposed bezoars were in reality urinary calculi.

**XANTHI'PPÉ**, the wife of Socrates, has acquired the reputation of having been an arch-termagant, doubtless not without some foundation. It ought, however, to be remembered that her naturally infirm temper must have been not a little tried by the small concern manifested by Socrates in the regulation of his domestic affairs, which appears occasionally to have made it difficult for X. to 'make both ends meet.' Socrates himself, it is known, had completely mastered his naturally strong appetites and passions, and had acquired a temper of perfect serenity. It is quite natural, then, that contrast-lovers and story-mongers should, as a foil, match so great a practical philosopher with a woman of such an ungovernable temper as X. is said to have been. She herself, if we can trust Plato, appears to have really loved her husband, and he at his death committed her tenderly to the care of his friends. Many stories are told of her, as of every other notable character in history, to illustrate her peculiar tendency, but it is difficult to say how much credit ought to be given them.

**XANTHORRHÆA.** See GRASS TREE.

**XANTHOXYLUM**, a genus of trees and shrubs, the type of the natural order *Xanthoxylaceæ*, an order closely allied to *Rutaceæ*, and chiefly distinguished from it by unisexual flowers, including more than 100 known species of trees and shrubs, having opposite simple or pinnate leaves with

pellucid dots, and no stipules, chiefly natives of warm climates, and more particularly of the warm parts of America. The order is generally characterised by pungent and aromatic qualities, which are strongly developed in the genus *X.* itself. *X. fraxineum*, a North American species, a very low, deciduous tree, with leaves somewhat like those of the ash, common from Canada to Virginia, is called **TOOTHACHE TREE**, from the use made of the hot acrid bark and capsules for the relief of toothache. It is also in high repute in the United States as a remedy for chronic rheumatism, for which it is administered in the form of a powder,



*Xanthoxylum fraxineum.*

in doses of from ten grains to half a drachm three times a day. Some of the species are popularly called **PEPPERS** in their native countries, as in India and Japan, where they are used as a substitute for pepper. The bark of *X. fraxineum* is a powerful sudorific and diuretic, and other species possess similar qualities; some are febrifugal, and the seeds and unripe capsules of some are gratefully aromatic.—To the order *Xanthoxyloaceæ* belong the **ATLANTO** (q. v.) and the **WHITE IRON-WOOD** (*Vepri undulata*) of the Cape of Good Hope, the wood of which is very hard and tough, and is much used for agricultural implements.

**XANTHUS**, the name of the capital of the ancient Lycia, anciently called Arina, a city of the Tramilæ, or Solymi, the primitive inhabitants. It lies at the south-west corner of Asia Minor, and near the village of Kounik. From the earliest historic times to that of Croesus, the Lycians appear to have been independent under native rulers; but after the fall of Sardis and the capture of Croesus, the Persian conqueror Cyrus sent an army for the conquest of Lycia, led by Harpagus, in 546 B.C. The most desperate resistance was made by the Lycians, and the people of X. burned themselves in their citadel, rather than surrender to the conqueror, only 80 families surviving the catastrophe. Reduced to a Persian satrapy, they sent 50 ships to the expedition of Xerxes against Greece, and contributed to the revenues of Persia. Little is known of the history of this town till the days of Alexander the Great. Alexander took X., which is said to have made as determined a resistance as it did on the former occasion. In the war which ensued amongst the successors of Alexander, Ptolemy took X. from the garrison of Antigonus; and the city subsequently passed into the possession of the Ptolemies and

Selencida. After the defeat of Antiochus, it was ceded by the Romans to Rhodes, but subsequently had its liberties restored. In the civil war between Brutus and the Triumvirs (43 B.C.), X. was taken by Brutus. The inhabitants a third time destroyed themselves and their families, and few survived the capture. From that time, X. belonged to the Roman Empire, and suffered in the earthquake in the reign of Tiberius; but Lycia did not lose all its freedom till the time of Claudius, who reduced it to a province. X. was situated 70 stadia, or 9 miles, from the sea, on the left bank of the Sibes or Sibrus, the Greek Xanthus, or Yellow River, on a plateau of elevated ground, of nearly rectangular shape, the elevated parts close to the river rising 200 feet. The most remarkable edifices in the city and its vicinity, according to ancient authors, were the Serpedonion, or Temple of Serpedon; that of the Lycian Apollo; and Letoon, or Temple of Leto. On the elevated ground, or Acropolis, stood the so-called Harpy Tomb, and an ancient theatre of Greek workmanship; while in the other part of the city which lay to the east was a mixture of Greek and Roman buildings. The whole city and its environs contained numerous temples and tombs. The discoveries of Sir C. Fellows in 1838 revealed the city of X., its temples and its monuments, and they appear to fall into the following classes: 1. The sepulchres of the early inhabitants, placed inside the wall in shape of square columns, with step-shaped bases, and sepulchral chamber on the summit. The most remarkable of these is the Harpy Tomb, so called from the subject of the bas-reliefs being the Harpies bearing off the daughters of Pandarus, king of Lycia—executed in a style resembling the earliest efforts of oriental Greek art. Another, with a frieze of lions and hunters in Persian style, and the inscribed obelisk, with long Lycian inscription and some Greek verses, apparently of the time of Artaxerxes Longimanus, and made about 466 B.C. 2. The tombs of the age of the Persian subjection, with roof-shaped tops and ridges, and imitation of woodwork, the sepulchral chamber for the principal dead being at the summit, the others in the middle and base, the sides ornamented with reliefs of a later style of art. Of a later style, but of more beautiful art, was the Ionic peristyle temple or monument of 14 columns, with a solid cella, placed on a base or pedestal, both temple and base ornamented with friezes, supposed to represent the conquest of Lycia by Harpagus, and with figures between the columns. The friezes represent hunts and feasts, the combats of Lycians and Persians, and taking of the city of X. by the latter—the whole treated in a style not unlike the school of Phidias and his successors. These sculptures have been supposed to represent the exploits of Harpagus, or the suppression of the revolt of the Cilicians by a Lycian satrap, and to have been made between 450 and 387 B.C. This temple was discovered by Sir C. Fellows in 1840—1844.

The language found on the monuments of Lycia, written in an alphabet of 26 letters, is an Aryan dialect, distinguished by a prevalence of vowels. The letters, with two exceptions, are archaic Greek, and borrowed from by no means the oldest form of that language. The syntax and inflections are Aryan or Indo-European, but many of the roots are different from the languages of that family, although certain words may be referred to well-known equivalents—as *goda*, 'lord,' to the Persian; *tedeeme*, 'son,' to the Slavonic; and *ladé*, 'wife,' to the Anglo-Saxon. Some words, too, resemble the Zend. The presence of many Greek words barbarously transcribed can also be well recognised in the different inscriptions, and some few

derived from their Persian conquerors—as *gesatrape*, or 'satrap.' The inscriptions are generally short and sepulchral, and follow the well-known formula commonly used under the Roman Empire, and are sometimes accompanied by Greek versions or translations, helping to explain the Lycian. One inscription alone, recording the exploits of one of the family of the Harpagi after the battle of Eurymedon (466 B.C.), on the so-called obelisk of X., is of any length. The language seems to have lasted from about the 5th c. B.C. to the 1st c. A.D.—Rawlinson, *Herodotus*, vol. i. pp. 311, 673; *Synopsis of the Contents of the British Museum*, 1856, p. 105; Fellows, *Asia Minor* (Lond. 1839); *Discoveries in Lycia* (1841); Birch in the *Archæologia*, vol. xxx. pp. 176—204.

XAVIER, ST FRANCIS, a celebrated missionary of the Roman Catholic Church, was born of a noble family at Xavier, in Navarre, April 7, 1506. Having received his early education at home, he was sent, when in his 18th year, to the college of Sainte Barbe, at Paris, where he formed the acquaintance of Ignatius de Loyola (q. v.), with whom he ultimately became associated in the foundation of the Jesuit Society. Under that head will be found detailed so much of his history as regards the first establishment of the order, and the early labours of its founders in Rome. It was while he was engaged in these early labours of the society in Rome, that X. attracted the notice of the representative of John III. of Portugal at Rome, Gouvea, who suggested to the king the idea of sending out members of the new order as missionaries to the Portuguese colonies in the East. X. was chosen for this purpose in the place of Bobadilla, who had been originally appointed, but was prevented by sickness from going on the expedition. Having sailed from Lisbon, April 7, 1541, and wintered at Mozambique, he arrived at Goa, May 6, 1542, and presented to the bishop his letters of authorisation from the Pope Paul III. X.'s first proceeding, on finding the excessively depraved condition of the European Christians settled in India, was to endeavour, by stirring up among them a spirit of penance and religious fervour, to remove the great obstacle to the efficacy of his preaching to the native population, which was presented by the evil example of the professing Christians of the colony. His efforts in this preliminary reformation were eminently successful, and he was equally blessed in his labours among the pearl-fishing population of the coast, from Cape Comorin to the island of Manaar. After a stay of more than a year in this region, he returned to Goa, and with a fresh staff of assistants, visited the kingdom of Travancore, where, in the space of a single month, he baptised 10,000 natives. Passing thence to Malacca, where he was reinforced by three other Jesuit missionaries, sent by Ignatius de Loyola in compliance with X.'s earnest solicitations, and having achieved great success among the residents of the coast, he proceeded, in 1546, to the Banda Islands, to Amboyna, and the Moluccas. In all these places his success was extraordinary. Having thus effected a first establishment of the Gospel in many places, he resolved to retrace his steps, and revisit the several scenes of his preaching. He arrived at Malacca in 1547, and thence by Manassar, near Cape Comorin, where he stayed for some time, he passed to the island of Ceylon, where he converted the king of Kandy, with many of his people. In May 1548, he returned a second time to Goa. His great object now was to carry out a project for the conversion of the Japanese Empire, which had been suggested to him by a Japanese of high rank, whom he had attached to himself at Malacca, and who accompanied him to Goa. This

Japanese, whom, with two of his domestics, he converted and baptised, became a most valuable auxiliary. Through his aid, X. was enabled during the voyage to acquire so much of the Japanese language as enabled him to translate into Japanese and explain the Apostles' Creed; and although his success in the first island which he visited was very insignificant, yet at Firando, and afterwards at Miako, his preaching was attended with extraordinary fruits. At the latter place, he had failed signally upon his first visit, which was made in a very poor and humble guise; but having returned with a more imposing train, and under circumstances of greater outward distinction, he obtained a ready and favourable hearing, and made so lasting an impression that the mission which he founded continued to flourish for above 100 years, until the final expulsion of Christianity from the Japanese Empire. His mission to Japan occupied about two and a half years; and in November 1551, he sailed from Amanguchi for the purpose of returning to Goa to organise a mission to China. Touching at Malacca, upon his voyage, he endeavoured to concert with the governor an embassy in the name of the king of Portugal, to China, under cover of which he hoped to effect an entrance for his missionary enterprise, but on his return from Goa to Malacca, he found a new governor, who was opposed to any such attempt; and he was obliged to adopt the expedient of sailing in a merchant-ship to the island of Sancian, near Macao, which was at that time the trading dépot of the Chinese with the merchants of Portugal. From Sancian, X., having procured a Chinese interpreter, hoped to induce one of the native merchants to land him secretly on the coast; but in this hope also he was baffled by the fears of the Portuguese, who dreaded for themselves the vengeance of the Chinese authorities upon this infraction of the law. This disappointment, coupled with the privations and labours to which he had been exposed, brought on a violent fever, and under the combined weight of mental depression and physical sickness, this Christian hero sunk upon the very threshold of what he had looked to as the great enterprise of his life, in the island of Sancian on the 22d December 1552. His remains were conveyed to Malacca, and thence with great solemnity to Goa, March 15, 1554. Many miracles, attested by numerous witnesses, were reported of X. in almost all the stages of his career. Among these, there have been some who reckoned the miraculous gift of tongues. The evidence of these miracles was submitted to the usual process of inquiry at Rome, and many miracles having been established by the ordinary canonical process, X. was 'beatified' by Paul V. in 1619, and 'canonised' by Gregory XV. in 1622, his festival being fixed upon the 3d December. His only literary remains are, a collection of Letters, in 5 books, 8vo (Paris, 1631), and a Catechism, with some short ascetic treatises. His Life, by Père Bouhours, was translated into English by Dryden. There is also a Latin Life by Tursellino (Rome, 1594); and several in Italian, by Bartoli, Maffei, and others. The most recent English contribution to this interesting subject is that of Mr Venn.

XEBEC, an armed vessel of great speed, formerly used by the Algerine corsairs. It carried three masts, on which square or lateen sails could be set. The bow and stern were remarkable for the small angle they made with the water. The sides were low, and the upper deck of great convexity, that the water might readily flow off through the scuppers. As this rendered them inconvenient for walking on, gratings were laid at the sides of the deck, to avoid the convexity. The crew walked dry

on these gratings, while the water flowed out underneath. Xebecs carried from 16 to 24 guns.



Xebec.

A few of these vessels—unarmed—still sail the Mediterranean as carriers of perishable goods.

**XENIA**, a handsome and flourishing town in Ohio, U. S., and important railway junction, on the Little Miami River, 65 miles north-east of Cincinnati, the centre of a rich and populous agricultural district; it has a large court-house, jail, 3 newspapers, several churches, a college, and a theological seminary. Pop. (1870) 6337.

**XENOCRATES**, an ancient philosopher, was born at Chalcedon 396 B. C., and died 314. At an early age, he attached himself to Plato, and in course of time, was so much esteemed for his proficiency in philosophy and high moral character, that he was thought worthy of succeeding Speusippus, Plato's successor, in the presidency of the Academy. This post he filled most creditably for 25 years. He wrote numerous treatises upon dialectics, physics, and ethics, and drew with unusual precision the boundaries between these three departments of philosophy. Of these works, merely the titles have been preserved; and what is known of his doctrines is gathered only from notices of them contained in various authors. He introduced into the Academy, to a greater degree than before, the mystic Pythagorean doctrine of numbers, in connection with the *ideas* of Plato. Zeus, the father, ruling in heaven, he called Unity, as being uneven number and spirit; the World-soul, which operates through all things liable to motion and change, he styled Duality. This divine world-soul dwells in the heavenly bodies, the Olympic gods, the elements of nature, and also in terrestrial demons, whom he regarded as intermediate between gods and men. In his ethical teaching, he aimed at making the Platonic doctrines more directly applicable to ordinary life in individual cases, and pitched his standard of excellence very high. He held that virtue is in itself valuable, while other things are only so conditionally, and that it extended to thoughts as well as actions. He was himself of irreproachable character, of a well-balanced mind, and temperate in his habits without cynicism. His conversion of the youthful debauchee Polemo into an earnest, virtuous man, and his disregard for wealth, as shewn by his refusal of the offers of Philip and Alexander, are the best known incidents in his long, useful, and virtuous career.

**XENOPHANES**, founder of the Eleatic School of Philosophy, was born at Colophon, in Asia Minor, about 580 B. C., or, according to others, about 40 years earlier. He spent the greater part of a life which

was prolonged beyond his 90th year, in banishment. He passed many years in Sicily, and resided for some time at Elea (whence adj. *Eleatic*), in Lucania. He composed many poems, historical, didactic, and elegiac, which have all perished, except a few fragments. He employed his poetry as the instrument for disseminating his philosophical tenets. He was the first to maintain the Eleatic doctrine of the oneness of the universe; and recognising clearly the unity and perfection of the deity, he attacked the prevalent mythology and the practice of attributing to the godhead a human form and human weaknesses. He was thoroughly in earnest, but his logic was confused and contradictory. While he held the existent to be identical with the deity, and regarded it as the basis of phenomena, he also maintained that the divine essence was neither finite nor infinite, neither moved nor unmoved: not finite, for then it must be limited by another, whereas God is one; nor, on the other hand, infinite, for only non-being is infinite, as having neither beginning, middle, nor end. The distinguishing tenet of X. is his Monotheism; and as a philosophical rhapsodist, he sought to inculcate it, though he failed to express it in a clear and systematic manner. His speculations are sceptical in their tendency, and appear to have had great influence upon succeeding philosophers. His explanations of physical phenomena were crude; but one is recorded in which he has anticipated modern geology. From the shells and marine petrifications found on mountains and in quarries, he inferred that the surface of the earth had risen gradually out of the sea. In the 18th c., Voltaire could give no better explanation of the fact of sea-shells being found on the mountains of Spain, than the supposition that they were the scallop-shells dropped by pilgrims journeying to and from the shrine of St James.

**XENOPHON**, celebrated as a general, historian, and philosopher, was born at Athens 445 B. C. At an early age, he became a pupil of Socrates, and is said to have been saved from death by that philosopher at the battle of Delium. At the age of 40 or thereabouts, he joined the expedition of the younger Cyrus against his elder brother, Artaxerxes Mnemon, king of Persia. After the battle of Cunaxa, and the treacherous massacre of the Greek generals, X. played an important part in the adventurous retreat known in history as the Retreat of the Ten Thousand; and it was his courage and conduct that contributed mainly to its success. After having returned to Asia Minor, X. led a portion of his forces upon a pillaging expedition, and amassed wealth enough to enable him to live the life of a country gentleman. Before retiring, he served under Agesilaus, the Spartan general, against the Persians; and at Coronea fought against his own countrymen. Sentence of banishment had been previously passed upon him at Athens, probably for his share in the Cyrean expedition. His sympathies were entirely Spartan. He soon afterwards settled at Scillus, a small town near Olympia, in Elis, under Spartan protection, where he lived upwards of 20 years, occupying himself with hunting, agriculture, and writing. He is not mentioned as having ever returned to Athens, though his sentence of banishment was repealed, and his two sons were in the Athenian division which aided the Spartans at Mantinea. At last, X. was driven from his retreat at Scillus by the Eleans, and took refuge in Corinth, where he probably died, 359 B. C. His works are numerous, and to judge by their titles and number, all extant. His style is simple, elegant, but rather monotonous and deficient in vigour. As a philosopher, he holds no very high rank. He possessed excellent practical talents, was a humane, sensible,

religious man, but seems to have had neither genius nor taste for speculative philosophy. His principal works are the *Anabasis*, or narrative of Cyrus's expedition, and the *Retreat of the Ten Thousand*; a *History of Greece* in continuation of Thucydides; the *Cyropædia*, or education of Cyrus the Elder—a sort of political romance, in which Cyrus is drawn as the model of a wise and good ruler. In the latter work, X. clearly shews his preference of a well-regulated monarchy to the democracy of his native country. He wrote besides, the *Reminiscences (Memorabilia)* of Socrates, a series of dialogues intended to refute the charges upon which that philosopher was executed; also treatises on Hunting, on the Horse, the Revenues of Athens, and Domestic Economy.

**XERXES I.** (the name is perhaps akin to Sanscrit *kshatra*, king), king of Persia, was the eldest son of Darius and his second wife Atossa, and was appointed successor by his father, in preference to Artabazanes, his eldest son by his first wife whose children were all born before Darius became king. Darius died in the beginning of the year 485 B. C., in the midst of his preparations for a third expedition against Greece. X., after having subdued the rebellious Egyptians, and appointed his brother Achæmenes governor, gave his whole attention to the completion of the preparations begun by his father, which occupied nearly four years. Immense hordes of men were gathered together from all parts of the vast Persian Empire, from the steppes of Central Asia, from the banks of the Indus and its tributaries, and from the interior of Africa; an enormous fleet was furnished by the Phœnicians and other maritime nations subject to Persia; stores of provisions sufficient to support the immense army were collected at different points along the intended route of march. A bridge of boats, an English mile in length, under the superintendence of Egyptians and Phœnicians, was built across the Hellespont. The bridge, however, was destroyed by a storm, on which (according to the Greek historians) X. ordered the heads of the engineers to be cut off, and was so enraged at the rebellious and disrespectful sea, that he ordered 300 lashes to be administered to it, and a set of fetters to be cast into it. Another bridge, consisting of a double line of boats, was built; and a canal was cut through Mount Athos, at the point of the peninsula of Acte in Macedonia, on which the fleet of Mardonius had been wrecked in 492 B. C. The preparations were completed in 481 B. C., and in the autumn of that year, X. arrived at Sardis, where he wintered. In the spring of the following year, the vast assemblage began to march towards the Hellespont; and, according to Herodotus, it took seven days and nights to march across the bridge. After crossing the Hellespont, the march was continued along the Thracian coast towards Doriscus on the Hebrus, where a halt was made on a large plain, and the army numbered. The fleet drew up near to Doriscus. According to Herodotus, the whole number of fighting-men, military and naval, amounted to nearly 2,500,000, and the fleet consisted of 1207 ships of war, besides 3000 smaller vessels. These numbers were considerably increased during the march between Doriscus and Thermopylæ by the Thracians, Macedonians, Magnesiensians, and other nations through whose territories X. passed on his way to Greece. Herodotus supposes that the number of camp-followers, exclusive of eunuchs and women, would amount to more than that of the fighting-men; so that, according to him, the whole number of people assembled on this occasion would be considerably over 6,000,000, a number greater than the entire population of Ireland. This number is doubtless greatly exaggerated; still,

it cannot be doubted that this was one of the greatest multitudes ever brought together for any purpose under the sun. Grote, who discredits the immense numbers given by Herodotus, nevertheless says: 'We may well believe that the numbers of Xerxes were greater than were ever assembled in ancient times, or perhaps at any known epoch of history.' This immense force moved on without resistance through submissive nations till it reached Thermopylæ (q. v.), where it was brought to a stand by the army of Leonidas (q. v.). Although the Greeks were entirely defeated and slain, it was not without heavy loss to the Persians. On the same day, and on the third day after, the Persian fleet, which had previously suffered severely from a storm, was defeated with heavy loss by the Greeks off Cape Artemisium in Eubœa. X. continued his march on to Athens through Phocis, which he laid waste, and Bœotia, whose inhabitants joined him, with the exception of those of Plataea and Thespia, which cities he burned. A detachment which he sent to attack Delphi met with a signal defeat. When X. arrived at Athens (in the summer of 480, three months after crossing the Hellespont), he found the city deserted, the Athenians having sent their families to Trezen, Egina, and Salamis. Athens was destroyed. Meantime the two fleets had sailed round from Eubœa and taken up their positions in the narrow strait between Salamis and the Attic coast, where the famous naval battle of Salamis took place (September 480 B. C.). See SALAMIS. X. witnessed the fight from a lofty throne which he had caused to be erected on one of the slopes of Mount Ægaleus,

'The rocky brow  
Which looks o'er sea-born Salamis.'

X. was apparently confounded at the unexpected and inglorious result of all his mighty preparations for the overwhelming of Greece, and becoming alarmed for his personal safety, fled, under an escort of 60,000 men, with all haste towards the Hellespont, which he reached in 45 days. The bridge of boats having been again destroyed by a storm, he crossed over to the Asiatic coast in a vessel. Mardonius was left with 300,000 men to carry on operations in Greece. In 479 B. C., the Greeks defeated Mardonius in the famous battle of Plataea (q. v.), and on the same day gained another victory over the Persians at Mycale in Ionia. Next year (478 B. C.), the Persians lost their last possession in Europe by the capture of Sestos on the Hellespont. The war was continued for a few years longer, though the struggle was now virtually at an end. Little more is known of the personal history of X., except that, in 465 B. C., he was murdered by Artabanus, who aspired to the throne, and was succeeded by his son Artaxerxes. From all that is known of X., he appears to have been utterly ignoble in character, vain-glorious, licentious, cruel, cowardly—the very *beau-ideal*, in short, of the worst kind of eastern potentate. His history would be scarcely worth recording were it not for his connection with Greek history. His famous invasion was undertaken apparently for no other purpose than to gratify a weak-minded vanity, which was delighted with the idea of being able to assemble at one time 'ships by thousands' and 'men in nations,' who were at the mercy of his unprincipled caprice.

**XIMENES, FRANCOIS DE CISNEROS**, by which latter name he is commonly called in Spain, the well-known statesman, archbishop, and cardinal, was born of a humble family at Torrelaguna, in Castile, in 1437. He was educated at Alcalá de Henares, Salamanca, and finally Rome, where he obtained from the pope a provisional or prospective nomination to a prebend in the cathedral of Toledo.

The archbishop, resisting the papal claim of 'provisor,' refused to admit X.; and on his persisting in his claim, put him in prison, where he was detained for a long period. On his release, he was named Vicar-general of Cardinal Mendoza at Sigüenza; but he gave up this preferment, and entered the Franciscan order in 1482. His reputation for piety and learning, led the queen, Isabella, to choose him, in 1492, for her confessor; and three years afterwards, to name him Archbishop of Toledo—a dignity which he refused to accept until he received an express command from the pope. Having yielded in the end, he continued as archbishop the life of mortification and austerity which he had practised in his monastery; and he applied to purposes of religion, charity, and public utility the whole of the princely revenues of his see. As confessor and confidential adviser of the queen, X., during the lifetime of Isabella, was the guiding spirit of Spanish affairs; and on her death in 1504, he held the balance between the parties of Ferdinand and Philip of Burgundy, husband of Joanna, the heiress of the crown. On the death of Philip in 1506, X. was appointed Regent, in consequence of the incapacity of Joanna and the absence of Ferdinand, and conducted the affairs of the kingdom through a most critical time with consummate skill and success. In 1507, he was created Cardinal; and in the following year, he organised, at his own expense, and himself accompanied as commander, the celebrated expedition, consisting of 10,000 foot and 4000 horse, for the conquest of Oran, on the African coast. Ferdinand died in January 1516, and on his deathbed named X. Regent of Spain till the arrival of his grandson Charles; and although the grandees had organised an opposition as well to himself as to the royal authority, X., by his prompt and able dispositions, overawed them into submission; and subsequently, by the same exercise of vigour and determination, quelled the incipient revolt of Navarre. In order to the better consolidation of the royal authority in Spain, X. urged very strongly the speedy visit of Charles, who still lingered in his Flemish principality; but it was not till after the lapse of a year and a half, that the king decided on his journey; and meanwhile, the enemies of X. had so worked upon his jealousy and pride, that he took the ungracious and ungrateful course of dismissing his faithful, but, as he feared, too powerful servant. X. had set out to meet the king, and although labouring under great infirmities, continued to prosecute his journey, when he was seized with a mortal illness at Branguillas, near Aranda de Duero, where he died, November 6, 1517.

As a statesman and administrator, the reputation of Cardinal X. is deservedly of the very highest. The social and political revolution which he effected in breaking down the feudal power of the nobles, has often been compared with the analogous change wrought in France by Richelieu. But the revolution of X. was, at least in its results, rather in the interest of the people than, like that of Cardinal Richelieu, of the crown; and while it freed the sovereign from the unworthy position of dependence on the nobility, it established

the municipalities and the communal representatives in the enjoyment of certain well-defined and undoubtedly substantial privileges and immunities. His munificence as a patron of religion, of letters, and of art, has been the theme of praise in every history of his time. The university of Alcalá de Henares, which he planned, organised, erected, and endowed, was a marvel of enlightened munificence in such an age, and may compare advantageously with even the most princely foundations of the most enlightened times. His Complutensian Polyglot (q. v.), besides being the first of its class, was, considering the resources of the period, perhaps the grandest in conception among the projects of its own order; and the perseverance with which, during the long period of fifteen years devoted to its preparation, he watched and directed its progress, is an evidence that it originated from a genuine love of sacred learning, rather than a passing impulse of literary enthusiasm. The cost of this gigantic undertaking amounted, on the whole, to 80,000 ducats. His expenditure on churches, hospitals, schools, convents, and other works of religion and benevolence, was on a scale of corresponding munificence. He maintained thirty poor persons daily at his own cost, and he regularly set apart one half of his income to the uses of charity.—See *Hefele's Der Cardinal Ximenes und die kirchlichen Zustände Spaniens am Ende des 15. und Anfange des 16. Jahrhunderts* (Tübingen, 1851).

XYLOIDIN is a substance which is precipitated in the form of a white powder, insoluble in water, alcohol, and ether, when water is freely added to a solution of starch in cold nitric acid. Its composition is not determined with positive certainty, but it is probably starch,  $C_{12}H_{10}O_{10}$ , in which either one or two atoms of hydrogen are replaced by a corresponding number of atoms of peroxide of nitrogen,  $NO_2$ . According to Professor Miller, there is a substitution of two atoms, so that the formula representing xyloidin is  $C_{12}H_8(NO_2)_2O_{10}$ . It explodes when sharply struck, and burns with violence at 356°. By the action of reducing agents, it is again converted into starch.

XYLOL (Gr. *xylon*, wood) is an oily aromatic fluid with a strong refractive power, and boiling at about 263°. Its composition is represented by the formula  $C_{10}H_{10}$ , and it is regarded as the hydride of a non-isolated radical,  $C_{10}H_9$ , to which the name *Xylol* is given. Xylol, mixed with toluol, cumol, and cymol, is found amongst the oils which are separated from crude wood-spirit by the addition of water.

XYLOPHAGA (Gr. wood-eaters), a family of *Coleoptera*, of the section *Tetramera*, nearly resembling weevils, but differing from them in the want of a beak. They have short antennae, thickened towards the tips, and sometimes leafy from the base. The species are numerous, and are arranged in many genera. They mostly live in wood, on which they feed, both in their perfect and larval states. Some of them are very destructive to trees and timber. See BARK BEETLE and SCOLYTUS. Some of the X. live in fungi, and feed on them.



# Y



THE last letter but one of the English alphabet, is derived from the Greek  $\tau$  ( $\upsilon$ ). It had no place in the earlier Latin alphabet, and only came into use by Roman writers in the time of Cicero in spelling words borrowed from the Greek. In the Greek of the classical age,  $\upsilon$  ( $\tau$ ) no longer retained its pristine power (Ital.  $u$  or Eng.  $oo$ ), but had degenerated into a sound like the French  $u$ , or even nearer to  $i$  ( $ee$ ); it could not therefore be represented by the Roman  $u$  or  $v$ , which had remained (and remains yet in modern Italian) undegenerated, and thus was appended to the Roman alphabet as a new character. Its use in native Latin words, as *sylva* for *silva*, *satyra* for *satira*, is an error of modern editors. Italian has no  $y$ , but uses  $i$  instead, as *sinfonia*, symphony. The other modern languages of Europe have not only retained it in spelling words of Greek origin, but some of them substitute it for  $i$  in native words, generally in a very capricious manner. German orthography has recently been purged of this abuse; and in Dutch, where it had always the sound of English  $i$  ( $ai$ ), the double character  $ij$  is now written. In English, it is used to represent the semi-consonantal power of  $i$  or  $j$  (see I and J) in the beginning of a word and before another vowel, as *yoke* = Lat. *iugum* or *jugum* = Ang.-Sax. *iuc*; *young* = Ang.-Sax. *iong* = Ger. *jung*. It has been suggested that the practice of writing  $y$  at the end of a word instead of  $i$ , while we replace it by  $i$  on adding a syllable (e. g., *lovely*, *lovelier*), may have arisen like the habit of giving a tail to the last unit of the Roman numerals (e. g.,  $ij$ ,  $iiij$ ), in the wish to give a kind of finish to the word and please the eye. The would-be antique spelling  $y$ ,  $y'$ , for *the*, *that*, is a blunder, arising from mistaking the Ang.-Sax.  $\beta$  (=  $\theta$ ) for a  $y$ .

**YABLONOI' MOUNTAINS**, a name that has long had a place in the geography of the north-east of Asia, designating a range of mountains which are found to have no existence, the locality in which they were supposed to be placed being an undulating plateau.

**YACHT** is a small vessel constructed so as best to insure strength, elegance, and speed, and exclusively employed for pleasure-sailing. Vessels of this sort were first constructed in this country in 1604, at which date a yacht was built by the king's master-shipwright for Henry, eldest son of James I. of England; the idea of such a vessel being taken from the Dutch, among whom they had been employed for some time previous. From this time, yachting, steadily patronised by royalty, became a favourite pastime of the nobility and gentry, and there are now about 50 yacht clubs in the United Kingdom, possessing, according to the *Yacht List* of 1876, 3164 yachts. This amusement is encouraged by government, mainly because it supplies an excellent training for seamen, who in time of war become available for the royal navy, while in time of peace they are no burden on the

national treasury; and accordingly, yachts are allowed to bear the ensign of the royal navy, supplemented by the special flag granted by the Admiralty to each club, and to refit and revictual in the royal dockyards. The oldest yacht club in the United Kingdom is the *Royal Cork*, which, under the title of the 'Water Club of Cork,' is known to have existed as early as 1720; and the next in order of seniority is the *Royal Yacht Squadron*, founded in June 1815, and having its headquarters at Cowes, Isle of Wight. The club which stands first as to the number of its members and yachts is the *Royal Thames Yacht Club*, which was founded in 1823, and has its head-quarters in London. Of the other clubs, 6 are Scotch (4 on the Clyde and 2 on the Forth), 3 Irish (2 at Queenstown, 2 at Kingstown, 1 at Dublin, 1 at Belfast, 1 at Carlingford Loch, and 1 at Loch Erne), and the rest English, being mostly located on the Thames, the channels between Southampton and the Isle of Wight, or the N. coast of Wales, from Liverpool to Holyhead. More than half of these clubs have been founded since 1840. Yachting is gaining ground in foreign countries and in the British possessions, the United States ranking next to Great Britain and Ireland in the number and importance of her yacht clubs (the chief of which is the New York Yacht Club); and Holland, Belgium, France, Australia, Bermuda, Canada, and Russia have similar associations.

The principles adopted in the construction of yachts have fluctuated greatly, from the simple unpretending rig, small tonnage, and clumsy build of the early yachts of the Royal Cork Club, to the immense canvas area, larger size, and long narrow build of the yacht of the present time. The yacht of the early part of the century was built with a fine run aft, and a bluff bow; but about 20 years ago, this style was supplanted by increased sharpness of bows and stern, a raking (slanting upwards and backwards) stern-post, more depth, the draught aft double of that forward, great fineness of the water-line, narrow beam, and immense sails. The effect of these changes was a great increase of speed, attended, however, with certain defects: one of which was that the diminished breadth of beam injuriously affected buoyancy, and the yachts consequently were more liable to be wetted in a heavy sea. In 1851, the hollow manner in which the crack yachts of the principal clubs in England were beaten by the yacht *America* of the New York Yachting Club, shewed their owners and builders that they had still much to learn in the way of improvement; and with few exceptions, they wisely took the lesson. The *America* had great breadth of beam, comparatively little depth inside, an upright stern-post, extremely sharp entrance, and fine water-lines, and (the most remarkable feature) her maximum breadth considerably abaft the centre. With the exception of the great breadth of beam, and little depth inside, all the other characteristic points of the American yacht were adopted by the builders of yachts in this country; the difference between the

draught aft and forward was diminished; and the result of these changes has shewn that they were great improvements.

The materials used in the building of yachts are wood, iron, and steel; wood alone, wood and iron together, iron alone, and steel alone, being the various ways in which the materials are employed. Yachts built of wood, or of wood and iron, are generally coppered, to protect the planking, and secure the smoothness of surface essential to speed. The considerations which determine the relative length, breadth, depth, &c., are treated of under SHIP-BUILDING. Considerable stimulus is given to improvements in construction by the numerous prizes which are offered for competition by the various yacht clubs, and which amounted in 1875 to £14,000, besides cups. These small, but powerfully built and thoroughly sea-worthy vessels have traversed every sea on the globe; numbers make trips to Norway and the Mediterranean; a few visit America and the Indian and Southern Oceans; and one or two have circumnavigated the globe. Some of the most remarkable performances of yachts are the voyage from New York to Liverpool of the *Charter Oak*, 23 tons, in 36 days; that of the *Sylvie*, 205 tons, from Halifax to Havre, in 16½ days; those of the *Inca*, *Katinka*, and *Vivid*, 25 tons each, from England to Australia; and the great Atlantic yacht-race from New York to Cowes, in December 1866, which was won by the *Henrietta*, 205 tons, after a voyage of 14 days. Yachts may be divided, according to the style of their rig, into Cutters (q. v.), fore-and-aft and square topsail Schooners (q. v.), and Yawls (q. v.). The tonnage of these vessels is very variable, ranging from 3 to 420 tons in Britain, the average tonnage being 30—50 tons. Steam-yachts (screws) are now exceedingly common, their independence of wind making them very popular. The *Victoria* and *Albert* and the *Fairy*, both belonging to her Majesty, are specimens of this class.

YAJNAVALKYA is the reputed author of the *S'atapatha-Brahman'a* (see *Yajurveda*, under VEDA), and of a *Dharmas'astra*, or law-book (see SANSKRIT LITERATURE, sec. Law). His name points to his being a descendant of Yajnavalka; and, according to tradition, he was also a descendant of *Visudmitra* (q. v.), and belonged to a branch of the *Kus'ikas*. He seems to have occupied an influential position at the court of King Janaka of Videha. Nothing certain, however, is as yet known regarding the age at which he lived.

YAK (*Bos grunniens*), a species of ox found in Tibet, and domesticated there. It is ranked by Colonel Hamilton Smith in the genus *Bison*, along with the Bison, Gaur, and Gayal, and by Mr Gray in the new genus *Poëphagus*. The wild yak of Central Asia is the largest native animal of Tibet, and is found only near the limits of perpetual snow, descending into the higher wooded valleys in winter, and ascending in summer to the pastures of short grass and *carices*, some of which are at an elevation of 17,000 feet above the sea. It is hunted by large dogs, and is very fierce, falling upon an adversary not only with its horns but with its chest, and crushing him by its weight. It is generally black. The yak has been domesticated from time immemorial, and forms great part of the wealth of the inhabitants of the highest and coldest regions of Central Asia. The domesticated yak is about the height of an English ox, which it much resembles also in figure of body, head, and legs. It is covered all over, however, with a thick coat of long silky hair, hanging down like the fleece of a sheep. The head is rather short; the eyes large and beautiful; the horns not very large, spreading,

tapering from the base, a little turned back at the tips, a space between them on the forehead covered with a mass of curling hair; the nose is smooth and convex, the nostrils small. The neck is short; the withers high and arched; the rump is low; the legs are short. Over the shoulders there appears a bunch somewhat like that of the zebu, but it consists only of long hair. The hair of the whole ridge of the back is long and erect, but not harsh. The tail is covered with a prodigious quantity of long flowing hair, descending to the hock, and has much



Yak (*Bos grunniens*).

the appearance of a large bunch of hair artificially attached. Not a joint of it is visible. From the chest, between the fore-legs, issues a large pointed tuft of long hair. The hair of the shoulders, rump, and upper parts of the body is comparatively thick and short; but that of the lower parts is long and straight, hanging below the knee, and sometimes even to the ground. Yaks exhibit great variety of colours; but black and white are the most prevalent. It is not uncommon to see the long hair on the ridge of the back, the tail, the tuft on the chest, and the legs below the knee white, whilst all the rest is jet black. The great quantity of hair, evidently a protection against the cold of the climate for which it is destined, gives the yak an apparent size far beyond the reality.

The yak does not low like an ox, but utters a short grunting sound like a pig, as the expression either of uneasiness or of satisfaction.

It delights in steep and rocky places. Hooker, in his *Himalayan Journal*, describes the calves as 'the drollest of animals, like ass-colts in their antics, kicking up their short hind-legs, whisking their bushy tails in the air, rushing up and down the grassy alopes, and climbing like cats to the top of the rocks.' The yak is capable of becoming very tame. The Tibetan girls call the yak cows by a peculiar cry to be milked.

The milk of the yak is very rich, and the curd made of it is much used by the Tibetans, both fresh and dried, often powdered into a kind of meal. The butter made from yak-milk is excellent, and is preserved for a long time in the dry and cold climate of Tibet in bladders. It is an important article of Tibetan commerce. The flesh of the yak is of the finest quality; that of the calves is much superior to ordinary veal. Yak flesh is often dried in the sun by the Tibetans, and eaten raw. The yak is never used for tillage or draught, but is very much employed as a beast of burden, and travels at a slow pace twenty miles a day, where no other beast of burden could well be employed. The lazy and luxurious lamas of Tibet often ride upon it, an attendant leading the animal. The hair is spun into ropes, and made into coverings for tents. The soft fur on the hump and shoulders is made into a

fine and strong cloth. Caps, jackets, cloaks, and blankets are made of the skin with the hair on. The tails are the *chowries*, or fly-flappers, used in all parts of India, and which are to be seen particularly on all occasions of state and parade, and sometimes in the hands of the meanest of grooms, sometimes of the highest officers of state.

There is much reason to think that the yak deserves a degree of attention which it has not yet received. It is still confined to its native region, whereas it is probably adapted to increase the productiveness and wealth of many parts of the world. It seems extremely suitable to Norway, Iceland, and other northern countries, and perhaps might be advantageously introduced into the Highlands of Scotland. Its hair is probably fit for other textile purposes than those to which it has been applied by the rude Tibetans.

YAKSHA is, in later Hindu Mythology, the name of a kind of demigods, who especially attend on Kuvera, the god of riches, and are employed in the care of his garden and treasures. According to the Vishn'u-Purân'a, they were produced by the god Brahman, as beings emaciate with hunger, of hideous aspect, and with long beards; but Brahmanic poetry generally represents them as inoffensive, and in the Meghadâta of Kâlidâsa (q. v.), it is a Yaksha banished from his wife who utters the most poetical thoughts, and is capable of the tenderest feelings. The Buddhists, on the contrary, describe them in some of their legends as cruel demons, who feast on serpents and human corpses, and when filled with the flesh they have devoured, indulge in fierce combats; but in others, again, as beings who also delight in dances, songs, and amusements, and sometimes even enter the paths that lead to *nirvân'a*. In Buddhist legends, they also possess the power of raising storms, and altogether occupy a far more prominent position than is allowed them in the Brahmanic pantheon.—See E. Burnouf, *Introduction à l'Histoire du Bouddhisme Indien* (Paris, 1844); the same author's translation of *Le Lotus de la Bonne Loi* (Paris, 1852); and Spence Hardy's *Manual of Buddhism* (Lond. 1853).—The Yakshas of the Brahmanic mythology have wives, Yakshis, who sometimes appear in the train of Umâ (q. v.).

YAKUTSK. See JAKUTSK.

YALE COLLEGE, an institution of learning in New Haven, Connecticut, U. S., founded in 1700 as the collegiate school of the colony of Connecticut, under the trusteeship of the ten principal ministers of the colony, who each contributed a gift of books. It was first established at Saybrook, and in 1716 removed to New Haven. Among its early patrons were Governor Yale, whose name it bears, and Bishop Berkeley. Of its four faculties, the medical was organised in 1812, the theological in 1822, the legal in 1824, and the philosophical in 1847. Its government consists of the governor and lieutenant-governor of the state, six fellows, its president, and ten ministers. The library has about 80,000 vols. There is a geological and mineralogical cabinet of 30,000 specimens, and the college has the historical pictures and portraits of Trumbull. It has 100 instructors and about 800 students, and has had about 10,000 graduates.

YAM (*Dioscorea*), a genus of plants of the natural order *Dioscoreaceæ*, distinguished by an inferior ovary and membranous winged fruit. The species are mostly tropical, natives of the East and West Indies, &c. They have tuberous roots and herbaceous twining stems. The great fleshy roots of some of them are very much used as an article of food, in the same way that potatoes are in more temperate climates. They contain much starch, and

generally become somewhat mealy and pleasant to the taste when boiled. This, however, is not the case with all: the roots of *D. triphylla*, *D. demourensis*, *D. virosa*, and several other species with ternate leaves are very nauseous even when boiled, and are poisonous. The tubers of all the yams contain an acrid substance, which, however, is dissipated by boiling, except in the species with compound leaves. The WINGED YAM (*D. alata*) is an article of food in daily use in the South Sea Islands. The roots are 1½–3 feet long, and often 30 lbs. in weight, with a brownish or black skin, juicy and reddish within. They vary exceedingly in form. The stem, which is winged, twines up tall poles which are provided for it by the cultivator; the leaves are between heart-shaped and arrow-shaped. Two or three small tubers are generally found in the axils of the leaves. It is supposed that this species may be the original of most, or perhaps all, of the yams cultivated in the tropical parts of Asia, Africa, and America—as the Common Yam of the West Indies (*D. sativa*),



Common Yam (*Dioscorea sativa*).

which has a round stem and heart-shaped leaves; *D. bulbifera*, in which the tubers in the axils of the leaves attain the size of apples; the Prickly Yam (*D. aculeata*), which has a prickly stem, and a fasciculated, tuberous root; *D. globosa*, the most esteemed yam of India, which has very fragrant flowers, and roots white internally; *D. rubella*, another Indian kind, with tubers sometimes 3 feet long, tinged with red below the skin; &c. The species are not well ascertained. Yams are propagated by means of their tubers; the small axillary tubers, or the small tubers produced at the base of the stem around the neck of the large tuber, being used for this purpose.—A species of yam (*D. Batatas*) has recently been brought from the temperate parts of China, where it appears to have been long in cultivation, and is found to succeed well in France. It is hardy enough to endure the climate even of Scotland without injury; but the heat of the summer is not sufficiently great and long-continued for its profitable growth, so that, in general, the plant merely lives, without producing a large tuber. The root is of very fine quality, and attains a very considerable size. The stem requires the support of a pole, round which it twines; the leaves are more elongated and acuminate than those of the West Indian yams; the root strikes perpendicularly down into the ground, and forms its tuber often at a very considerable depth, which is sometimes

inconvenient to the cultivator; but this is prevented by putting a slate under it.

YAMA, the Hindu god, who, at the epic and Purānic period of Hinduism (see INDIA, sec. Religion), is the sovereign of the Manes, and the judge of the dead, is, in the hymns of the R'igveda, a son of *Vivasvat* and *Saran'yā*, and a twin-brother of *Yamī*, whose desire to become his wife he resists. His father is sometimes also called the *Gandharva*; and he is further represented there as possessing two four-eyed dogs, which guard the road to his abode (see J. Muir, 'Yama and the Doctrine of a Future Life, according to the R'ig-, Yajur-, and Atharva-vedas,' in the *Journal of the Royal Asiatic Society*, New Series, 1865, vol. i. p. 287, ff.). The idea represented by these mysterious deities has been differently understood. Professor Roth takes *Vivasvat* for the light of heaven, *Saran'yā* for the dark storming cloud, and Y. and *Yamī* as representing the first human pair—the originators of the race, or the Vedic Adam and Eve produced by the union of the damp vapour of the cloud and the heavenly light. The Vedic hymns, however, do not afford the slightest ground for such a fantastical interpretation of these names; and as regards that of Y. and *Yamī*, they discountenance it even distinctly by describing Y. as resisting the sexual



Yama.

alliance with his sister. Professor Max Müller understands *Vivasvat* to represent the sky; *Saran'yā*, the dawn; Y., the day; and *Yamī*, the night (*Lectures on the Science of Language*, 2d Series, Lond. 1864, p. 509, ff.). But this interpretation, too, is open to the strongest doubts, inasmuch as there is no valid ground for identifying the luminous deity *Vivasvat* with the sky, or *Saran'yā* (from *saran'a*, going, moving) with the dawn. It seems more probable that the phenomena symbolised by this myth are not of a luminous, but of an aërial character; the kindred myth of a luminous character being that of the *Aswins*, who are likewise the twin progeny of *Vivasvat* and *Saran'yā*, or rather of *Vivasvat* and 'a form similar to that of *Saran'yā*,' and who represent the transition from darkness to light, and the inseparable duality produced by the intermingling of both (see J. Muir, 'Contributions to a Knowledge of the Vedic Theogony and Mythology, No. 2,' in the *Journal of the Royal Asiatic Society*, vol. ii. 1866). For as *Vivasvat*, 'the expanding,' probably implies the firmament 'expanding' to the sight through the approaching light, *Gandharva*, as usual, the solar fire, and *Saran'yā*, the dark and cool 'air' (the

moving element), Y. and *Yamī* seem to represent the current of air produced by the effect of the solar heat emanating from the firmament on the cool air of the night, when the antagonism between the warm and cold air of which this current consists would be Y. repelling the union with his sister *Yamī*, though, at the same time, they are 'husband and wife while yet in the womb' (of the night-air). And since this phenomenon extends over the whole atmosphere, the two four-eyed watch-dogs of Y. are probably the eight or twice-four regions of the compass, either each couple of them taken together with their intermediate regions—whence both dogs are called spotted—or the four regions and the intermediate four taken separately—whence one dog is also called *dark*, and the other *spotted*. Y. being produced by the solar heat, it becomes then intelligible why it is said of Agni, the (solar) fire, that he is born as Y., and Y. being a phenomenon of the air, why he is also identified with *Vāyu*, the wind, and why the intermediate space between heaven and earth is assigned to him as his domicile. It is probably a later conception of the Vedic period which describes this abode as having been made for him by the spirits or *Manes*, and Y. as having been the first who found his way to it; and a still later one, which represents him as the first of *mortals* who went to that world, for in passages where these ideas are expressed, there is an association between the moving air and departed life which is foreign to the oldest notions of the Vedas. It led to the position which subsequently Y. assumed as a luminous king who dwells together with the *Manes*, and as the lord of Death—death then becoming his messenger. Yet in the R'igveda, he has not yet the office of judge of the dead which is assigned to him in the later mythology of the epic poems and Purānas, and probably already in some of the Upanishads. At the epic and Purānic period, Y. entirely loses his cosmical character, though he is still called the son of *Vivasvat*. He then marries 13 daughters of the patriarch *Dakṣa*, is installed as the king of the *Manes*, becomes the regent of the South, and resides in *Yamapura*, a town of the infernal regions, where he sits in judgment over the souls of the departed which are brought before him. They are generally fetched by his messengers, who draw them with nooses out of the bodies which they animated; but in the case of very pious persons, he assumes himself the function of separating the soul from the body. After the soul has been brought before him, he orders his recorder, *Chitragupta* or *Chandragupta*, to read to him an account of all the good and bad actions it had done during its life, and which are kept registered in a book called *Agrasandhānt*; and according to their merit or demerit, it is sent to heaven or the infernal regions. The precise knowledge which the Purānas pretend to possess of all these proceedings, also extends to the description they give of this recorder, and to their enumeration of the assessors who co-operate with Y. at his court.—Y.'s sister is *Yamunā* (q. v.). Amongst his other names, *Dharma* ('justice'), *Dharmarāja* ('king of justice'), *Antaka* ('the ender'), *Kāla* ('time'), and *S'rāddhadeva* ('the god of the S'rāddha,' q. v.), are of usual occurrence.—When represented, he is of grim aspect; his colour is green, his garments red, and he rides on a buffalo with a crown on his head, in one hand holding a club, and in another the noose.

YAMBU, or YEMBO (*Iambia* of Ptolemy), a maritime town of Arabia, on the coast of the Red Sea, about 130 miles south-west of Medina, stands on the edge of a barren plain that extends between the mountains and the sea, fronting the northern extremity of a narrow winding creek. It shares

with other places the title of 'Gate of the Holy City,' and is the third quarter of the caravan road from Cairo to Mecca, and is thus a place of considerable importance. Y. being the port of Medina, is supported by a considerable transport-trade and extensive imports from the western coasts of the Red Sea. The harbour is good and well sheltered. It is surrounded by walls with turrets, outside of which are a few domes and tombs. The streets are wide, the houses stand at a considerable distance from each other, are built of limestone and coralline, and have huge hanging windows. There is a large market-place, a custom-house, some white-washed mosques of a very simple form, and a few caravanserais. According to Burton, 'there is an independent bearing about the people, strange in the East; they are proud without insolence, and look manly without blustering. Moreover, the population has a healthy appearance.' Pop. between 6000 and 7000. See Burton's *Pilgrimage to El-Medinah and Meccah* (1855).

YAMUNĀ, the modern Jumna, is one of the sacred rivers of the Hindus, mentioned as such as early as in the hymns of the *R'igveda*. Bathing in it, especially where it falls into the Ganges, at Allahabad, was at a later period, and is now, supposed to have the efficacy of removing sin, because at Allahabad the god Brahman is said to have performed a great horse-sacrifice—whence this place is termed *Prayāga*, literally, 'sacrifice,' or *Bhat'a-prayāga*, literally, 'the best sacrifice.' (Though Allahabad, which is a celebrated place of pilgrimage, is the *Prayāga*, this term is also applied to other places where two sacred rivers meet, four of which, situated at the confluence of the Ganges with the Alakanandā, Pindar, Mandākinī, and Bhāgrathi, are, besides Allahabad, held in especial sanctity, and severally called *Nanda*-, *Karnā*-, *Rudra*-, and *Devā-Prayāga*.) In the Purānic mythology, the Y.—in Sanscrit, a word in the feminine gender—is called a sister of the god *Yama* (q. v.); and a legend is also told in regard to her, according to which Balarāma, the brother of Kṛishn'a (see *VISHN'U*, the 8th Avatāra), once ordered the river to come to him, and as she disobeyed his bidding, plunged his ploughshare into her banks, and dragged her to him. Y., the legend continues, was thus compelled to quit her ordinary course, and to follow Balarāma whithersoever he went. At last, however, appeased by her entreaties, he let her go, after she had watered all the country. Professor Wilson appends to this legend, where occurring in his translation of the *Vishn'u-Purān'a*, the following remark: 'The legend probably alludes to the construction of canals from the Jumna, for the purposes of irrigation; and the works of the Mohammedans in this way, which are well known, were no doubt preceded by similar canals dug by order of Hindu princes.'—*Vishn'u-Purān'a* (Lond. 1840, p. 572).

YANG-TZE-KIANG, 'son of the great river' or 'sea,' the principal river of Asia, the 'girdle of China,' connecting together all the central provinces of that empire situated between Tibet and Kokonor on the west and the Pacific Ocean on the east. Its entire length through all its numerous windings, under its various names, can hardly be less, but rather more than 3000 miles. If regard be had to its tributaries and to the cities to which its waters give access, to the richness of the soil, and the variety of the products along its banks, and above all to the vast population scattered far and wide over the valleys, and plains, and hill-sides drained by it and its confluents, the Y. has no equal on the globe. It takes its rise in the same elevated regions of Central Asia which give birth to the Brahmaputra,

Makiang or Mekong, Salween, and Hwang-ho or Yellow River. Its course at first is southward, winding its way through an apparently level country, and bearing the name *Muru Ussi*, or Tortuous Waters. The magnitude of the stream must be considerable even in these upper regions, for it was here, beyond the Bayan Khara Mountains, that the missionary traveller, M. Huo, in the winter of 1845, saw a herd of wild oxen that had perished, having got frozen up in the ice while attempting to cross the river. Leaving these upper regions, after traversing the wide territory of Kokonor, the Tortuous Waters run southward, and enter the province of Yun-nan at about 28° N. lat. The river then flows in a south-east direction through this province, and at about 26° N. lat. and 103° E. long, it turns north, forming part of the boundary between the provinces of Yun-nan and Sze-chuan. After entering the latter province, it flows in a north-east direction under the name of *Kin-sha-kiang* (River of Golden Sands), receiving at this part of its course many tributaries. On the south, the tributaries of the provinces of Yun-nan and Kwei-chow are numerous, but not large; the principal one, the Oo or Woo, flows through the latter. On the north, the tributaries are numerous and large, the principal being the Ya-loong, the Min or Wen, and the Kia-ling, which force their way through narrow passes, rolling over lofty precipices, and carrying with them large masses of ice. Two of these rivers are each more than 1000 miles in length. It enters the province of Hu-pe at about 110° E. long, shortly before which it receives the name of *Ya-kiang* (Great River). The Great River next runs east-by-north through the entire length of the province of Hu-pe, receiving in its progress the waters of many lakes and rivers, the principal being the *Han-kiang*, from which the most illustrious dynasty takes its name, which in turn gave to Chinamen the name of which they are most proud—Sons of Han. The two provinces Hu-pe and Hu-nan—i. e., 'North of the Lakes' and 'South of the Lakes'—contribute, by natural or artificial channels, to augment the main stream. One of these lakes, the Tung-ting-hu, is the largest in China, having an area of 300 sq. miles. After receiving the waters of these lakes, the river proceeds in a north-eastern course through the province of Ngan-hwui, in which part are situated the cities forming the great mart Han-kow. Skirting the north of the province of Keang-se, it receives the waters of the Po-yang Lake, which receives nearly the whole of the waters of the province of Keang-se, and, like the Tung-ting-hu, pours all its contents into the Great River. Thence moving in a north-east direction, it becomes broader and deeper as it traverses the province of Ngan-hwui, receiving tributaries from both banks. Entering Keang-su, and passing Nankin, it travels southwards, intersecting the 'Transport River,' or Yun-ho—i. e., the Grand Canal. Through the whole of this province it receives tributaries, helping to swell the flood of waters, till in one broad expanse, several miles in extent from north to south, they disembogue into the Yellow Sea. To name the cities on the banks and tributaries of this rival of the Mississippi, would be to enumerate a large portion of the cities of the empire. It is navigable by ships of the largest class to 900 miles from its mouth, and for smaller vessels to upwards of 1500 miles. There is a large steam traffic on it up to Han-kow, nearly 700 miles from its mouth. By the treaty of Tien-tain, the Y. was opened to foreign commerce as far as Han-kow; and speedily English and American steamers were found plying between Shang-hae and Han-kow.—Dr Bridgman in the *North China Herald*.

YANINA. See JANINA.

**YANKEE, YANKEE DOODLE.** Yankee, the popular name for a New Englander in America, and in Great Britain often applied indiscriminately to the whole population of the United States, was in its origin a corruption of the word English as pronounced by the Indians (Yenghies, Yanghies, Yankies). It seems to have been first applied about 1775 by the British soldiers as a term of reproach to the New Englanders, who themselves afterwards adopted it.—Since the War of Secession, the Southern population apply it to the Northern people generally.

The air known as *Yankee Doodle* was originally *Nankes Doodle*, and is as old as the time of Cromwell, to whom, under that name, the doggerel words belonging to it seem to have had a reference. It was known in New England before the Revolution; and one account of its appropriation in America, as a national air, is that after the battle of Lexington, the brigade under Lord Percy marched out of Boston, playing it in derisive allusion to the then popular nickname of the New Englanders; and that afterwards the New Englanders, saying that the British troops had been made to dance to *Yankee Doodle*, adopted the air as they had adopted the nickname. The citizens of the United States do not now recognise *Yankee Doodle*, but *Hail, Columbia*, as their national air.

**YAPOOK** (*Cheironectes palmatus*), a marsupial quadruped of the Opossum family, *Didelphida*, the only known species of its genus. It differs from the opossums in having only five molars on each side of each jaw, in its aquatic habits, and its incapacity for climbing trees. The muzzle is rather sharp; the ears naked and rounded; the tail long, scaly,



Yapook (*Cheironectes palmatus*).

and prehensile; the feet webbed; the hind-feet with an opposable thumb. The Y. inhabits Brasil and Guiana. It is rather larger than a rat. It is of a brown colour, with three transverse gray bands, white on the under parts. It feeds on crustaceans, fishes, &c. It has cheek-pouches, in which it stows away its food.

**YAR, or YARE**, a river of the county of Norfolk, rises about the middle of the county, flows east past Norwich, and, receiving the Waveney, widens into the estuary of Breydon Water, is joined by the river Bure at Great Yarmouth, 2½ miles below which it enters the North Sea, after a course of about 30 miles.

**YARD** (A.-S. *geard*, *gyrd*, Ger. *gerte*, a rod or wand), the British standard measure of linear dimension (see WEIGHTS AND MEASURES), is subdivided into feet and inches. The yard contains 3 feet, and each foot 12 inches. The terms 'yard' and 'ell' (the ell being, however, equivalent to 1½ yards) are frequently (*commonly*, according to Recorder) used synonymously by old authors.

**YARD**, in the rigging of a ship, is a timber which, when in its normal position, is borne horizontally

at right angles to the ship's length at one of several heights on a mast, for the purpose of sustaining and spreading a square sail. It is upheld by the 'lifts,' and trimmed out of its right angle to suit the wind by the 'braces.' The lower sails or courses are upheld by the main, fore, or mizzen yards. Above these are the topseil-yards, the topgallant-sail-yards, and the royal-yards.

**YARKAND**, the commercial capital of Eastern Turkestan (pop. not less than 155,000), is situated in 38° 24' N. lat. and 77° 14' E. long., near a river of the same name. Until Y. was visited by Mr Shaw, in 1868, we had little reliable information concerning it. He found it to contain long streets, covered in against the rays of the sun, with rows of fine shops, in which goods of every sort, and from every country, were exhibited. He found the bread excellent; the supply of vegetables varied and abundant; the butchers' shops well provided with horse-flesh, camel beef, and mutton—the last two least prized, selling at 1d. a pound. The population seemed industrious, orderly, well skilled in many of the arts of civilised life, and in the enjoyment of security for life and property.—See Shaw's *High Tartary, Yarkand, and Cashgar* (1871); and Dr G. Henderson's *Lahore to Yarkand* (1878).

**YARMOUTH, GREAT**, a municipal and, until 1867 when it was disfranchised for corruption, a parliamentary borough returning two members to parliament, an important seaport, and fishing and sea-bathing town, on the east coast of Norfolk, 19 miles directly east of Norwich, and 20½ by railway. It stands about 2½ miles above the mouth of the river Yare, on a slip of land about a mile and a half broad, washed on the west by the Yare, and on the east by the North Sea. Between the town and the suburb of Southtown, or Little Yarmouth, on the right bank of the Yare, in Suffolk, communication is established by means of a bridge. Connected with Southtown is the village of Gorleston, near the mouth of the river. The principal streets of Y. run parallel to the river, and are intersected by 156 cross lanes or 'rows,' which, as a rule, are so narrow as to be impassable for ordinary wheel-carriages, being generally not more than from 5 to 8 feet wide. The vehicles by means of which traffic is carried on in the rows, are called 'Yarmouth carts.' They are low, narrow, and well suited for conveying heavy goods. A quay of nearly two miles runs along the river, and here are the town-hall, the council-chamber, and several other handsome buildings—the finest houses, however, being those built along the esplanade on the beach. There are many churches, schools, and other public buildings, including a sailor's home, fisherman's hospital, and military asylum, the principal church being that of St Nicholas, founded in the 12th c., a handsome cruciform building with a tower and spire 168 feet high. The town also contains a monumental column 144 feet high, to the memory of Nelson. On the coast are several batteries, three piers, besides two at the harbour mouth, several public gardens, and a marine drive and promenade 2 miles long. Vessels of over 200 tons can enter the harbour, which is formed by the Yare. Y. is the principal seat of the English herring-fishery, which employs 250 luggers and over 3000 hands; deep-sea fishing, the produce of which is forwarded daily to London, is also carried on, and employs many hands. The curing of fish, especially of herrings, is important, there being consumed for this purpose about 10,000 tons of salt annually; and the 'Yarmouth bloater' is highly esteemed in London and throughout the country. The quantity of fish sent from Y. by railway in the year 1864 was 34,432 tons. An

extensive export trade in agricultural produce, herrings, and malt is carried on. Coals, timber, wines, and salt are imported. Ship-building is carried on, and a manufacture of crape and silk goods. In 1875, 1306 vessels, of 152,886 tons, entered the port, and 666, of 79,441 tons, cleared. The coast is dangerous, but Yarmouth Roads, which extend between the coast and a line of sandbanks a short distance off shore, are a safe anchorage. Pop. (1871) 41,819.

**YARN.** The name applied to the thread spun for the purpose of weaving cloths of various kinds. It varies not only in the materials of which it is made, but also in the fineness to which it is spun. This latter quality is of great importance, as upon it depends entirely the evenness and quality of the manufacture. In order that uniformity may be insured, a pound of the material is taken as the standard, and this is divided into *hanks* or *cuts*. Thus, with linen yarn, a hank or cut consists of 300 yards; and if it takes 25 of these hanks to make a pound, the yarn is called 25s; and if 40, 40s; and so on. A hank of wool or cotton consists of 840 yards. No material admits of such fine spinning as cotton. Messrs Thomas Houldsworth & Co. of Manchester have probably produced the finest—that is the thinnest—cotton yarn ever seen; they have produced 700s, of which maulin has been made, and this is the finest ever woven; but to test the wonderful perfection of their machinery, they have produced yarn too fine to be exactly estimated, but believed to be No. 8000 or No. 10,000; or 10,000 hanks, each 840 yards, from one pound of cotton—or over 4000 miles in length.

**YAROSLAV.** See JAROSLAV.

**YARROW.** See ACHILLEA.

**YARROW**, a Scottish stream, rendered famous by song and ballad, rises a little over a mile east of Loch Skene, at the place where the counties of Dumfries, Peebles, and Selkirk meet. It flows in a general north-east direction through Selkirkshire, and joins the Etrick about two miles above the town of Selkirk, after a course of 25 miles. About 3½ miles from its source, it expands into the Loch of the Lowes, which is a mile long, and a quarter of a mile broad. Leaving the Loch of the Lowes, the small stream enters St Mary's Loch, separated by a narrow neck of land, on which stands St Mary's Cottage (Tibby Shields'), from the other and smaller lake. St Mary's Loch is 3½ miles long, and nowhere broader than 7 furlongs. The peaceful grassy hills which surround the loch slope downwards to the water's brink, uninterrupted by trees, and compose a scene of great quietude, over which broods the spirit of 'pastoral melancholy.' The prevailing calmness of the waters is pictured by Wordsworth in the lines:

'Let  
The swan on still St Mary's Lake  
Float double, swan and shadow.'

**YASKA.** See NIRUKTA.

**YAW**, in the motion of a ship or boat, is the term for describing an irregular deviation in the course steered. A very chopping wind or sea may produce this effect, but the helmsman would usually have the credit of bad steering.

**YAWL**, a decked boat having two masts, on the first of which is a lugsail and topsail; and on the aftermost, which rises almost from the sternmost, a driver or fore-and-aft sail. It is a very easily managed rig.

**YAWNING** may be either the simple result of deficient aëration, or may be brought on by the mere sight of the act in another person, and is a modification of the ordinary movements of respira-

tion, in which the inspiration is deeper than usual, and is accompanied by a kind of spasmodic contraction of the muscles which depress the lower jaw, and by a great elevation of the ribs and to some degree of the shoulder-blades. 'The purely involuntary character of the movement,' says Dr Carpenter, 'is sometimes seen in a remarkable manner in cases of palsy, in which the patient cannot raise his shoulder by an effort of the will, but does so in the act of yawning. Nevertheless, this act may be performed by the will, though not completely; and it is one that is particularly excited by an involuntary tendency to imitation, as every one must have experienced who has ever been in company with a set of yawners.'—*Principles of Human Physiology*, 8th ed., p. 280.

**YAWS**, known scientifically as *Frambesia*, is a cutaneous eruption of a very peculiar nature, which commonly attacks negroes, but has been noticed in Europeans. The disease is preceded by languor and pain in the limbs, and shivering, succeeded by heat and restlessness, and is more severe in children than in adults. After a few weeks, the pure glossy-black colour of the skin gives place to a dirty dull tint; and the patients often not only loath food, but take to eating coals, chalk, earth, &c. The skin is then covered for a few days with a white mealy scurf, as if it had been dusted with flour, after which pimples like pin-heads appear on the forehead, face, neck, groins, &c., which increase for a week or more, growing into crusted pustules, which enlarge until the base attains the size of a sixpence, or even a shilling. If the crust is removed, a foul sloughing sore is exposed. The pustules may, however, burst spontaneously, and discharge a thick viscid matter, which hardens to a scab on the surface. In the larger pustules, this surface at length becomes elevated into a red granulated excrescence, not unlike a wild raspberry (*Frambesia*), which is the true and characteristic yaw. In size, it may vary from that of a pea to that of a mulberry, and in colour it varies with the general health of the patient from a red to a pale white tint. It has very slight sensibility, and never properly suppurates, but discharges a glutinous fluid, which communicates the disease by inoculation. When the yaw has remained for some time, it diminishes in size, and as the pustule heals, is finally covered with skin, leaving little or no mark. When the pustule seems to have reached its height, one pustule becomes much larger than any of the others, and instead of being elevated, is depressed. This is termed the master or mother yaw, and requires much care. When the mulberry-like excrescences appear on the soles of the feet, the resistance of the thick epidermis excites great pain. They are then termed by the negroes *Tubba*, or crab yaws. This disease is endemic among certain tribes of native Africans, and is common among the negroes of the West Indies and of North and South America. It is contagious, and cannot be communicated except by the actual contact of yaw-matter to the abraded skin, or by inoculation, which is sometimes effected by means of a large fly called the yaw-fly. The interval between the reception of the poison and the formation of the eruption varies from seven to ten weeks. The disease scarcely ever attacks the same individual more than once. 'Yaws,' says Dr Craigie, in his learned work on *The Practice of Physic*, 'are liable to be confounded with the secondary [tertiary?] or cutaneous symptoms of syphilis, with sivvens,\* with the Arabian leprosy, with

\* As Sivvens or Sibbens, and Radesyga, are diseases not much known to the general public, and not noticed in this work, we may mention that sibbens is a tuber-

radesyge, pellagra, and the red leprosy of Cayenne.' Several writers of eminence regard yaws as the same with the disease described in Leviticus, chap. xiii., as the Jewish leprosy, but the description of the symptoms there given is not sufficiently precise to furnish sufficient evidence regarding their identity. With regard to treatment, mercury does more harm than good, and all that can be done with advantage is to render the progress of the morbid processes as little painful as possible. The most important remedial agent is the warm bath; and blood-purifying drinks, such as decoction of sarsaparilla, &c., may be prescribed. The Africans have their own native remedies in the bark of trees called *Yaffo* and *Bullanta*, taken in infusion or decoction; and to destroy the mother yaw, they adopt the following barbarous process: Iron is boiled in lime-juice with a quantity of the common black ants and of Malaguetta pepper, and the liquid thus prepared is applied hot to the yaw.

**YAZOO**, a river of Mississippi, U. S., formed by the union of the Tallahatchie and Yallobuaha, runs south and south-by-west in a very serpentine course, in a deep, narrow, sluggish channel, between fertile cotton plantations, and empties into the Mississippi River, 12 miles above Vicksburg; it is 290 miles long, and navigable at all seasons.

**YEAR**, a division of time containing a complete course of the seasons, and depending upon the revolution of the Earth (q. v.) round the sun. Its duration was variously determined by the nations of antiquity, the earliest method being the conventional one of making it include a certain number of lunar months; the lunar month being, after the day, the first period of time which was fixed. Twelve lunar months, giving a year of 354 days, were first taken as a near approach to a course of the seasons. This, though a pretty close approximation to the true value of a year, was yet so incorrect (being defective by more than 11 days) that it was soon found to be necessary to intercalate these 11 days, in order to preserve the year in a constant relative position to the seasons. The intercalation was variously effected: thus, the Egyptians, who knew the year of 365 days previous to 1500 B.C., divided it into three seasons ('Winter,' 'Summer,' and 'the Nile,' i. e., the inundation of the Nile) of four months each, made each month contain 30 days, and introduced five intercalary days at the end of the 12th month; the Greeks, who generally retained the lunar year of 354 days, added 3 months in the course of every eight years, giving an additional month to the third, fifth, and eighth year of each cycle; the Romans also added additional days, but their system of intercalation was continually changed, not always for the better, till Julius Cæsar caused the adoption of the solar year. The Romans likewise abolished, in Asia, Egypt, and all the other countries under their sway, the old method of reckoning by lunar years, and compelled the adoption of the Julian calendar, according to which the year was assumed to contain 365 days 6 hours. The substitution of the Gregorian Calendar in the 16th c. introduced for the average length of the solar year, 365 days 5

hours 49 minutes, which differs only by a few seconds from its true value; and this small annual error, as well as the excess of the true year over the year of 365 days, is compensated for by means of a succession of *Leap-years* (q. v.).

The time at which the year began varied much among different nations. The Carthaginians, Egyptians, Persians, Syrians, and other eastern peoples commenced their year at the autumnal equinox, at which time the civil year of the Jews also began, though their sacred year was reckoned from the vernal equinox. The commencement of the Greek year was at the winter solstice before Meton's time, and was then changed to the summer solstice. The Romans were the first to adopt the 1st day of January as the first of the year, but their example was not followed by subsequent European nations for some time. In France, the commencement was 1st March under the Merovingians, 25th March under the Carolingians, Easter under the Capetians, and 1st January from 1564. The ecclesiastical year in Europe generally commenced on 25th March (see DATE). The ancient northern nations reckoned their year from the winter solstice; the Russians, till Peter the Great's time, from 1st September, and the same reckoning, known as the Byzantine era, was in use in the Eastern Empire. Of necessity, the commencement of the year among Mohammedan nations has no fixed position in relation to the sun's course or the seasons, it being invariably a lunar year. In Astronomy, there are several kinds of years depending upon the various configurations of the earth in its orbit, and consequently varying in length. First, there is the *tropical*, or (as it is sometimes incorrectly called) *solar* year, which, from its being recognised in legislation and history, and commonly applied in the measure of time, has also received the name of *civil* year. This year is defined as the time which elapses from the sun's appearance on one of the tropics to its return to the same, and has a mean length of 365-24222414 mean solar days, or 365 days 5 hours 48 minutes 49-7 seconds (see PRECESSION). Next is the *sidereal* year, which is the period required by the sun to move from a given star to the same star again, and this year, affected as it is by Nutation (q. v.) only, is one of the most invariable quantities which nature presents us with, and has a mean value of 365-2563612 mean solar days, or 365 days 6 hours 9 minutes 9-6 seconds. The time which elapses between the earth's arrival at its Perihelion (q. v.) and its return to the same position, is known as the *anomaliatic* year, and is equivalent to 365-2595981 mean solar days, or 365 days 6 hours 13 minutes 49-3 seconds. The sidereal and anomaliatic years have a merely astronomical importance.

**YEAST**. In the process of fermentation of saccharine fluids containing albuminous matter, as in brewing or wine-making, the originally clear fluid becomes turbid, carbonic acid is evolved, and the substance causing the turbidity gradually separates in a grayish foaming mass of a bitter taste and an acid reaction. This is yeast; and on examining it under the microscope, it is found essentially to consist of aggregations of small oval cells of a vegetable nature, known as the yeast-cells, yeast-plant, or *Torula cerevisia* (q. v.). Yeast, as is well known, has the property of setting up fermentation in saccharine solutions; and beer-yeast, the kind with which we are specially acquainted, possesses, according to Professor Miller, this power in the highest degree, as may be shewn by dissolving 4 parts of pure cane-sugar in 20 parts of water, and adding 1 part of fresh yeast: if this mixture be exposed to a temperature of about 80°, in less than

cular affection of the skin, often extending to the deeper tissues, very infectious, and said to be endemic in Dumfriesshire, Ayrshire, and Galloway, first described about a century ago by Dr Ebenezer Gilchrist; while the Radesyge, Spedalshed, Spedalska, Liktraa, Northern Leprosy, or Marsh Sickness, is endemic in various parts of Scandinavia, consisting in its fully developed form of 'an eruption of pimples, scales, patches, and tubercular pustules on the skin, terminating in puriform discharge, with or without ulceration.'—Craigie, *op. cit.*, vol. 1. p. 690.



an hour, fermentation will have commenced. The investigations of Mitscherlich have led chemists to distinguish two varieties of yeast—viz., the *Ober-hefe*, or surface-yeast, and the *Unter-hefe*, or sediment-yeast, the former collecting on the surface of the fermenting fluid, and the latter forming a sediment. Surface-yeast is propagated by buds (see *TORULA CEREVISIÆ*) and sediment yeast by spores; and each variety produces specific results upon the fermenting fluid. The fermentation induced by the surface-yeast is rapid and irregular; while that produced by the sediment-yeast is slow and quiet. The surface-yeast is formed when the saccharine fluid ferments at a temperature of from 65° to 77°; while the sediment-yeast is chiefly produced when fermentation takes place at the lower temperature of from 32° to 45°. In their chemical relations, the two varieties present no apparent difference. On treating yeast with a solution of potash, a cellulose-like substance remains, while an albuminate is dissolved. The action of yeast is destroyed by exposing it to a temperature of 212° by alcohol, by the strong mineral acids, chlorine, iodine, and bromine, oxide of manganese, creasote, &c.; on the other hand, it may be dried at a low temperature, or by pressure, and may be preserved in this state without losing its activity. The part which the globules of yeast play in exciting the conversion of sugar into alcohol and carbonic acid, is very obscure; but an experiment of Mitscherlich seems to shew that the sugar ferments only in those points which are in actual contact with the globules. Pasteur's experiments render it probable that the process of fermentation is connected with the assimilation of the sugar by the yeast-plant during the development of the yeast-globules, or, in other words, that 'the essential condition of fermentation is the conversion of albuminoid matter into organised globules.'

According to Mitscherlich's analysis, the cells of ordinary washed yeast in a condition to excite fermentation contain (the ashes being deducted): carbon, 47.0; hydrogen, 6.6; nitrogen, 10.0; sulphur, 0.6; oxygen, 35.8; while spent yeast (after fermentation had ceased) contained only 5 of nitrogen. The inorganic matter amounted to 7.3 per cent. of the dried yeast, and consisted entirely of phosphates.

The economic uses of yeast in bread-making, brewing, &c. are noticed in other articles. Beer-yeast (*Cerevisia fermentum*) is an article of the British Pharmacopœia. It is employed as a stimulant in the advanced stages of low fevers, and is especially serviceable in cases where, in consequence of inflammatory symptoms, wine is inadmissible. Neligan has found it of great service in intense tympanitis following parturition. The dose is two table-spoonfuls every three hours, and it may be given in camphor mixture or peppermint water. Yeast-poultice forms an excellent stimulating application to foul and irritable sores. It is composed as follows: Take of yeast, six fluid ounces; flour, fourteen ounces; water heated to 100°, six fluid ounces. Mix the yeast with the water, and stir in the flour. Place the mass near the fire till it rises. This poultice should be renewed every six or eight hours. Its special efficacy depends upon the carbonic acid gas which it evolves.

If surface-yeast or under-yeast be collected and placed on a cloth to drain, and then pressed until nearly dry, it can be kept with care for several months, and in that state is what is called GERMAN YEAST, for which a large trade has sprung up within the last few years; the imports to Britain from the continent having amounted, in the year ending 31st December 1875, to 163,521 cwts., or about 8176 tons. It is chiefly imported from Holland and Hamburg, and is obtained

mostly from the great continental distilleries. Nearly the whole of this large quantity is consumed by the bakers. PATENT YEAST is exactly similar, but is raised from a wort made purposely from malt and hops. ARTIFICIAL YEAST is a dough of wheat or other flour, mixed with a small quantity of common yeast, and made into small cakes, which are dried. If kept free from damp, it long retains its fermentive power.

YEDO ('River Door'), since 1868 called *To-Kio* ('Eastern Capital'), the chief city of Japan, is situated in the east of the island of Nipon, at the head of the bay of the same name, in lat. 35° 40' N. and long. 139° 40' E. The river O-gava, or Great River, divides it into two parts, an eastern called Hondjo, and a western or Y. proper. The former is, strictly speaking, an island about 7½ sq. m. in extent, the boundaries of which are: on the south, the bay of Y.; on the west, the O-gava; on the north, a large canal; and on the east, a river running parallel to the O-gava. It is traversed by several canals, which divide it into eight principal districts, containing upwards of sixty temples, of which the most notable are the *Yoiaka Lakan* (or temple of 500 images), and the temple of *Hadesma*, the Japanese 'God of War'; numerous palaces of the once-formidable daimios, now rapidly undergoing demolition; and various government stores. Hondjo is connected with Y. proper by four bridges, of which the largest, O-bassi or Great Bridge, is 350 yards in length. Under the Tycoon, Y. proper was divided into three parts—(1) Siro, or the castle; (2) Soto-Siro, or outside the castle; and (3) Midzi, town and suburbs. The first of these contains what was the residence of the deposed emperor, with numerous palaces, once occupied by the higher daimios. The second, which engirdles the first, and reaches to the river O-gava, is partly occupied with palaces and temples, the more eastern part intersected by the Tocaïdo or great high-road of Nipon, forming the mercantile quarter of the city. One of its numberless bridges is called the Nipon-bass or 'bridge of Japan,' and is considered the centre of the empire, all geographical distances being reckoned from it. Of the temples in the second division of Y. proper, the chief are those of Mouzeki, the greatest of the Buddhist temples, and Sanno, the greatest devoted to the old or primitive religion of Japan. The third division is rather vague, and is, or was, used to comprehend all of Y. not included in Siro and Soto-Siro. It forms the exterior part of the city, and contains, among others, the temples of Quanon, one of the most beautiful, venerated, and frequented in all Japan; of Amida; of Confucius, which also forms the native university of Y.; and of Kanda, the tutelary deity of the city, which is remarkable for the vast extent of its outworks. Here also is the *Yosiwara*, or Court of Public Women, a district of considerable size, and occupied exclusively by the class indicated by the name.

The temple of Quanon perhaps merits a special description. Before one arrives at the long avenue which leads to it in a straight line, he passes through a large portico, the pillars of which are beautifully varnished with red. This varnish, though exposed to all the changes of the air for so many years, has lost nothing of its brilliancy. In the middle of the portico is suspended an enormous lantern, the largest, one may say, that ever was made. The avenue leading to the temple is lined with shops, in which are exposed all sorts of articles, religious and profane, to be sold to the numberless pilgrims who every year visit this sacred spot. The building is elevated about 20 feet from the ground. A grand flight of steps gives access to the interior. The arrangement of this, like that of almost all other Buddhist temples in

## YEDO—YELLOW COLOURS.

Japan, resembles very much that of the interior of Catholic churches. First, you have the chief altar at the extreme end of the temple, with side chapels at its right and left; next, a great number of wooden images, with the 'glory' round their heads, like the images of Catholic saints; then there is generally seated at the door of the temple a man selling rosaries and holy pictures. In the side chapel, at the left of the chief altar, may be seen a well-sketched picture, representing some of the prostitutes of Y. who have been celebrated for their beauty.

The population of Y. has been set down by various writers on Japan at from 1,500,000 to 3,000,000, but according to Her Majesty's vice-consul at Y., even the lowest of these estimates is a great exaggeration. In his Report, dated February 15, 1872, he states, on the authority of the Tokai-Fu, or municipal government of the city, that, 'according to the last census taken since the restoration (i. e., of the Mikado in 1871), the population consisted of 780,321 souls in all.' The area covered by the capital, however, is about 28 sq. m.; and therefore Y., in point of extent, is after London the largest city in the world. Its site is no doubt one of peculiar beauty. The broad valley in which it lies slopes gradually to the waters of the bay, and for leagues around are wooded hills, smiling valleys, and an ever-luxuriant vegetation, evergreen oaks, cryptogamia, conifera, in great variety; the cypress, the palm, and the bamboo. In the official quarter, parks with magnificent trees, temple gardens, and broad green slopes gladden the eye; while in the suburbs are hedgerows and shady lanes, clothed for the most part with evergreen vegetation. But the abolition of the feudal system has produced, and is still producing, important changes in the general aspect of the city. The palaces of the ex-daimios are being, as has been said, gradually demolished, and their grounds, so far as not required by the new government of the Mikado, are being used as vegetable gardens, and as mulberry plantations. From this decay, even the late imperial castle itself, and the magnificent mausoleums of the Tycoons, are not exempted. The Report from which we have already quoted says: 'Thus that portion of the palace called the citadel threatens soon to become a mass of ruins. Already the imposing and numerous gateways and bridges leading to it are left to take care of themselves, and a foreigner, who a few years back hardly dared look at this wonderful stronghold, may now freely ascend its towers, overlooking the residence of the Mikado, without meeting even a gate-keeper. . . . The ex-daimios, since they became dispossessed of their estates, have hastened to part with what they no longer considered necessary to their dignity. Thus all the costly articles of furniture and ancient arms which once adorned their princely dwellings, may now be seen in the shops of dealers in antiquities, and may be bought for a mere trifle. Many of these nobles have availed themselves of the leave given to them by the Mikado to travel abroad.' In regard to their style of building, the vice-consul states that the Japanese have made little progress. Although there are large fireproof depots, protected by a thick coating of stucco, and rising high above the ordinary shops, and although patrols march constantly through each ward night and day, to give timely alarm of fire; 'yet fires have been as frequent during the winter (1871—1872) as ever, and thousands of wooden dwellings thus destroyed are being rebuilt of the same inflammable material, and in the same shabby style.' A strong desire for education is springing up among the people of Yedo. Schools for instruction in English, French, and German have been established; and great progress is

also being made under European teachers in medical science. The native garrison, which is really the Japanese army, is equipped and drilled after the French fashion, and is armed with chassepots. The imperial navy is also being organised after the model of the British, and numbers several iron-clads. Telegraphic wires are in use throughout the city. As yet no definite statistics can be got of the trade of Y., but from the consular report of 1872, it seems to embrace most of the products of European industry, while it largely exports silk, silkworms' eggs, copper, lacquer-work, mats, timber, &c. Most of the goods pass through the port of Yokohama (q. v.), with which Y. is connected by railway.

Sir Rutherford Alcock's *Capital of the Tycoon* (Lond. 1863); Oliphant's *Narrative of the Earl of Elgin's Mission to China, 1857, 1858, and 1859* (Lond. 1860); *Yeddo and Peking*, by Robert Fortune (Lond. 1863); *The Treaty Ports of China and Japan* (1867); the *Consular Reports for 1870—1873*; and *Mossman's New Japan* (1873).

**YEDO, BAY** or, an inlet of the North Pacific, on the south-east coast of the island of Nipon, Japan, lying between 35° and 35° 40' N. lat., and intersected by the 140th meridian of E. long. The city of Yedo is situated at its north-western extremity. The depth of water, nowhere great, decreases all along the banks, towards the town, which, at low water, cannot be approached within a mile even by a boat. Solid batteries of granite, well kept, and in general aspect not unlike those of Cronstadt, have been erected midway between the anchorage and the shore.

**YEKATERINBURG.** See **EKATERINBURG.**

**YELATOM.** See **JELATOM.**

**YELL**, one of the Shetland Islands (q. v.), and, after Unst, the furthest north of that group, is separated from Mainland by Yell Sound, and from Unst by Blue Mull Sound. It is 17 miles in length, 5½ miles in average breadth. Area, 94 sq. m.; pop. (1871) 2732. The west coast is rocky and precipitous, but on the whole the surface is tame, and consists largely of moorlands—the greatest elevations being no more than 400 feet above sea-level. Agriculture is in an unusually backward state, and, though the surrounding seas are generally stormy, fishing is the chief employment.

**YELLOW BERRIES.** See **FRENCH BERRIES.**

**YELLOW-BIRD** (*Chrysomitris tristis*), a bird of the Finch family (*Fringillidae*), a native of North America, where it is very widely distributed. It is rather more than five inches in entire length; the male in summer plumage of a bright yellow colour, with black crown, wings, and tail, the upper and under tail-coverts white. The female is yellowish brown above, and ashy brown below, and the male assumes a very similar plumage in winter. Yellow-birds are often seen in large numbers, feeding on seeds of thistles and other plants, and seldom alighting on the ground. The nest is made of lichens fastened together with saliva, and lined with soft substances. The song of the Yellow-bird is very pleasing; and it is a sprightly and attractive cage-bird, easily tamed, and capable of being taught tricks. Several allied species are found in the western parts of America.

**YELLOW COLOURS.** The yellow pigments employed by painters are: 1. The varieties of chrome prepared from chromate of lead. See **CHROMIUM.** 2. Several colours technically called *pinks*—as *Brown Pink*, prepared as a lake from a decoction of French berries and fustic; and *English Pink* and *Dutch Pink*, both lakes, prepared by different processes from French or yellow

berries and turmeric. 3. *Naples Yellow*, a mixture of metallic antimony, red-lead, and oxide of zinc calcined, added to a small quantity of lime, then fused, and afterwards ground to powder. 4. *King's Yellow* is a tersulphuret of arsenic. 5. *Patent Yellow* consists of 28 parts of chloride of lead and 27 parts of carbonate of lead well mixed in powder, and then fused together. 6. *Weld Yellow* is prepared from a decoction of Weld (*Reseda luteola*), or dyer's weed, with alum, and is, in fact, another yellow lake. It is much used in paper-staining. 7. *Gamboge*, which constitutes the chief yellow colour used in water-colour painting.

**YELLOW FEVER** is a disease endemic in low districts near the sea, but under certain circumstances sporadic in other places, never appearing beyond 48° of north latitude, nor without a temperature of at least 72° F., nor above the elevation of 2500 feet above the level of the sea, depending in part on causes not yet known, but in circumstances favourable to its production, capable of being propagated by contagion. It usually commences suddenly (generally in the night or early morning) with a sense of coldness, a rigor, or actual shivering, followed by vascular reaction, as shewn by the heat and dryness of the skin, headache, especially over the eyes, and pain of the eyeballs, which are suffused, and have a strange drunk-like aspect. The limbs and loins are painful; the tongue is loaded, and its edges are red. There is a peculiar and characteristic flush or suffusion of the face, occupying a zone of about an inch above and below the eyes. Nausea, gastric uneasiness, and a tendency to vomit soon supervene. These symptoms may gradually lessen, and the patient will then regain his ordinary health in 24 or 36 hours; but if the symptoms persist, they soon become more aggravated, and the stomach ejects at first a clear fluid, which soon becomes of a dirty-brown tint, and is finally succeeded by the true *black vomit*. A yellow tint on the conjunctiva is observed, which extends to the skin of the face; and as the disease advances, the whole body becomes of a yellow colour, varying in intensity from a pale lemon to a deep orange tint. The anxious countenance indicates the distress of the patient, who appears to be agitated by fearful apprehensions or incipient delirium. The skin feels constricted, and is of a pungent heat. The bowels are constipated, and the red, clean, and tremulous state of the tongue indicates the presence of intestinal irritation, and consequently the increase of danger. The urine and other excretions are more or less suppressed. Eructations, hiccoughing, and vomiting increase the distress and weakness. The disease in fatal cases usually terminates on the second or third day. The above train of symptoms is by no means constant. Sometimes, when everything seems favourable, black vomit suddenly appears, and the patient immediately succumbs. In other cases, patients experience no symptoms except severe pains in the legs and suppression of urine, and die without taking to their beds. In all cases terminating fatally, albumen appears in the urine on the second or third day. In females, the catamenial discharge is sure to appear, whether due or not. The discharges from the bowels, towards the close of the disease, may be black or dark green, and these dark evacuations are succeeded by what is termed the 'caddy-stool,' resembling dark sandy mud. As yellow fever is not a disease of this country, we shall not enter more fully into its symptoms. According to Dr Jackson, who has written an excellent treatise on this disease, the usual course of yellow fever in its most concentrated form consists of 12 hours of forming period, 36 or 48 of formed or proper fever, and 24 or 36 of declining or concluding

period. When the symptoms are less intense, the patient may survive to the 14th day. In the milder modifications of this disease, the morbid symptoms are prolonged to a considerable extent. Death may occur at any period of the disease, and the mode in which it occurs is by syncope (fainting), uræmia (or poisoning of the blood by the accumulation of urea), apoplexy, or asphyxia or suffocation. When the black vomit is plentiful, and the urine free, the intelligence remains unaffected, but the skin becomes cold and damp, the pulse small, and finally imperceptible at the wrist, and death ensues from gradual exhaustion and syncope. When the black vomit is scanty, and the urine is suppressed, the poisoned blood acts upon the brain, and the patient exhibits wild delirium, followed by coma, convulsions, and death. The ratio of deaths to cases in the disease is always very high. From Tulloch's statistical Reports on the Diseases of Soldiers, it appears that in the Windward and Leeward command, the ratio was 1 to 2½ (or 3 in every 7 cases died), in the Jamaica command it was 1 to 1½ (or 3 in every 4 cases died), while in Gibraltar it was 1 to 1½ (or 3 in every 5 cases died).

There are great differences of opinion as to the proper treatment of this disease. Dr Blair, one of the highest authorities on yellow fever, holds that the disease may be cut short or aborted by prescribing '20 grains of calomel added to 24 grains of quinine, afterwards followed by two drachms of carbonate of magnesia, and two ounces of sulphate of magnesia in eight ounces of peppermint water.' These abortive doses were repeated at intervals of four or six hours, one dose being generally efficient, but four have been given before the quinine induced its special symptoms of cinchonism. Many physicians who have had much experience of this disease, have no belief in the abortive treatment; and some treat their cases with antiphlogistic or lowering remedies, and others with stimulants. It is probable that there is no one mode of treatment suitable for all cases, and that each should be treated according to its special symptoms. The extreme heat of the surface (a temperature of 107° has been observed in the arm-pit) may be relieved by the frequent application of the wet sheet; cupping or leeches often relieve the head-symptoms; and a blister to the gastric region may relieve the irritation of the stomach. If there is no suppression of urine, and if that fluid is free from albumen, morphia is of great service, but it must be given with great caution. The food should be of the mildest form, such as chicken-tea, arrowroot, sago, and barley-water, and these should be taken frequently in very small doses, in consequence of the state of the stomach. Similarly, with regard to all drinks, which are most likely to be retained if sucked through a tube or given by tea-spoonfuls. Tea usually disagrees, but cold infusion of oatmeal, and very dilute brandy and water, are usually relished. Our highest authority on Tropical Diseases, Sir J. Randal Martin, states that, whenever the disease breaks out, 'the most speedy means of prevention [of its spreading] in respect to towns and garrisons, will always be found in the removal of both the sick and the healthy to a locality where the temperature is sufficiently low, such as a neighbouring range, or dry ventilated ground.' In all ships on service on the west coast of Africa and other unhealthy stations, the following rules (which we borrow from Dr Aitken's *Handbook of the Science and Practice of Medicine*) should be strictly attended to. A prophylactic dose of quinine (five grains) should be administered to the men daily (a precaution that should be taken in all malarious regions, independently of yellow fever). Whenever the fever appears on board, the ship should at

once put out to sea, and should proceed to the coolest atmosphere within reach. The most immediate measures of prevention should be, to obviate direct solar exposure, to prevent fatigue, and to check any excesses in the use of spirits. Seamen should be kept as remote from unhealthy coasts as is consistent with duty, anchoring every evening a few miles from the shore, if possible. Duties in boats should as much as possible be conducted during the mornings and evenings, the noon-day heats and the deadly nocturnal emanations being to be equally avoided. When men are landed, they should be encamped on high and dry ground. Meals should be regularly served and carefully cooked, and coffee should be given early in the morning, and after unusual fatigue or exposure, and no work should be commenced till the coffee has been taken. Holds of ships should not be cleaned on the spots where the fever has originated, or during its prevalence, but the process should be deferred till the vessel is in a colder latitude. Lastly, green wood should not be placed on board ship in hot climates, but the wood should be barked and partly charred.

Dr Craigie, in his learned *Practice of Physic*, gives the following extensive list of synonyms of Yellow Fever: '*Febriß flama, Typhus eterodes, Sauvages and Cullen; La Maladie de Siam, La Fèvre Maitlotte, Vomito Prieto, Chapotonada, Febre Amarilla Hispanorum et Hispano-Americanorum; New Distemper of 1691; Kendal's Fever, Pestilential Fever, Bilious Fever of Gamble; Endemial Causus or Burning Fever of Moseley; Malignant Pestilential Fever of Chisholm; Remittent and Bilious Remittent of Hunter; Concentrated Endemic Fever of Jackson; Tropical Continued Fever of Lempriere.*' We shall conclude with a short notice of the history of this disorder. Long before the arrival of Cortes in Mexico, an extremely fatal epidemic disease used to prevail amongst the native Mexicans. Epidemics of special severity occurred in 1545, 1576, 1736—1737, and 1761—1762. Although Humboldt thinks that the elevation of the table-land of Mexico (7200 to 7800 feet above the level of the sea) is sufficient to exclude any idea of the identity of this disease, known as *Mallazahual*, with yellow fever, there can be little doubt, from the similarity of the symptoms, that the two diseases are really the same. The Europeans visiting the shores of America soon became painfully familiar with the disease; and it is almost certain that 'the plague' which so often destroyed the English and Spanish troops at the end of the 15th and the beginning of the 16th centuries was in reality yellow fever. A disease bearing the character of yellow fever appeared in 1618 among the Indians in certain parts of Massachusetts, and prevailed with much severity till 1622, and it committed great havoc among the emigrants to Virginia. When the expedition against Hispaniola in 1655, under Venables, returned to Jamaica, they met there 'an enemy (the plague) more severe than the Spaniards, which in a little time reduced the army, originally 7000, to fewer than 2000 men.' There can be little doubt that this plague was yellow fever. In 1691, it was very fatal in Barbadoes, where it was known as the *New Distemper*. From about this date, yellow fever has been endemic in the West Indies. It was unknown at Carthagens and along the coast till 1729, when it committed dreadful havoc; the Spanish galleons never remaining any time without interring one-half, or at least one-third of their men. In 1740, it first appeared at Guayaquil, since which time it has often occurred; and in all the towns on the coast of the American continent and islands between 45° N. lat. and 10° S. lat., it appeared in proportion as Europeans began to visit them. 'In this manner,' says Dr Craigie,

'Vera Cruz, Cumaná, Havana, Acapulco, and La Guayra have successively become its endemic abodes; and its appearance in these towns is as uniform and certain as the arrival of the sun at the tropic of Cancer. Of these places, Vera Cruz and Havana may be regarded as the nursery of yellow fever; and from the month of March to that of September or October, the disease rages like a pestilence among the recently arrived Europeans, and these natives who descend from the elevated table-lands of the interior.' Until the year 1793, the disease was regarded as having a spontaneous origin, and being due to tropical peculiarities operating on European and unseasoned constitutions; but that year the doctrine of infection suddenly started. In that year the disease appeared with great virulence in the island of Granada, and rapidly spread over the Antilles to Philadelphia, and many parts of the state of Pennsylvania, to Massachusetts, New York, Caroline county Maryland, Alexandria in Virginia, several counties in North Carolina, and Caraccas in Venezuela. This outbreak was preceded by a few days by the arrival of a vessel from Bulam, on the West African coast, at a harbour in St Granada, in which vessel, when stationed off Bulam, fever had prevailed about five months before to a great and fatal extent. This disease was at the time termed the Bulam Fever, but soon turned out to be ordinary yellow fever. Since 1763, yellow fever has very often appeared as an epidemic in the West India Islands and various parts of the American states, and has even been endemic in various parts of the south of Europe, especially Gibraltar and Malaga. From the testimony of many medical writers, it is certain that a disease essentially identical with yellow fever prevails endemically along the west coast of Africa, at Senegal, Sierra Leone, Cape Coast Castle, and the island of Fernando Po. Fortunately for this country, this fell disease, which has repeatedly been brought to our shores (Swansea, Southampton, &c.), is at once nipped out by our climatic conditions. When, in 1866, it was imported into Swansea, Dr Buchanan, who was at once sent down by the government to watch the disease, and take the necessary measures to prevent it from spreading, recorded 12 instances in which, with filth, bad ventilation, and every other condition favouring the fever, it failed in every case to spread beyond the original victim. Altogether there were 20 cases, of which 15 were fatal. The disease then disappeared.

A disease closely resembling, but apparently not quite identical with yellow fever, committed great ravages in Mauritius in 1867.

**YELLOW-HAMMER, or YELLOW-BUNTING** (*Emberiza citrinella*), a species of Bunting (q. v.), which is one of the most common of small birds in Britain, distributed over all parts of the country, and is common also in most parts of the continent of Europe, from Norway and Sweden to the Mediterranean. It is about seven inches in entire length, and the male is a bird of brilliant plumage, although there is something in the short thick form of the bird, and in the tints and distribution of its plumage, which prevents it from being greatly admired for beauty. It is, perhaps, also the less regarded because it is so common; and in many parts of Britain there is a prejudice against it, so that boys who would think it wrong to rob any other bird's nest, esteem it a kind of duty to rob that of the yellow-hammer. In the summer plumage of the male, the head, cheeks, ear-coverts, and nape of the neck are bright lemon yellow, with a few dusky black patches; the upper part of the back and wings are reddish brown, tinged with yellow; the wing-primaries are dusky black, with

narrow external edges of bright yellow; the secondaries, tertials, and wing-coverts dusky black, broadly margined with rich chestnut brown; the upper tail-coverts reddish chestnut, edged with yellow; the tail-feathers dusky black, the central pair edged with chestnut, and tinged with yellow; the chin, throat, and whole under surface, bright lemon yellow, clouded on the breast and flanks with reddish brown. The tail is slightly forked, and is shorter than that of the Common Bunting. The knob in the palate is also less conspicuous. The female has much less yellow about the head than the male, and her plumage is altogether much less vivid. The Y. frequents hedges and low trees, and is often to be seen, especially in winter, in the vicinity of houses, in flocks, with sparrows, chaffinches, &c. It generally makes its nest on the



Yellow-hammer (*Emberiza citrinella*), with Nest and Eggs.

ground, under shelter of a bush or a tuft of grass, forming it of moss, roots, and hair. The song of the male is very sweet, and consists of few notes, which have been jocularly set to music with the words, 'A little bit of bread, but no-o cheese.' He is remarkably attentive to his mate, and takes his turn in incubation. In Italy, great numbers of yellow-hammers are caught, and fattened like ortolans for the table. It is a curious and noteworthy circumstance, that this bird is rare in insular situations; in the islands of the Mediterranean, as well as the Orkneys. The name Yellow-hammer is a corruption of Yellow-ammer; *Ammar*, in German, signifying Bunting. In Scotland, the Y. is known as the Yoldrin or Yite.

**YELLOW RIVER.** See HWANG-HO.

**YELLOW SEA.** See WANG-HAI.

**YELLOWSTONE**, a river of the U. S., rises in a beautiful lake of the same name high up in the Rocky Mountains, and receiving numerous branches from the south, flows north-easterly through the territory of Montana, and empties into the Missouri River, in the north-west part of Dakota Territory, lat. 48° 5' N., long. 104° W. It is 800 yards wide at its mouth, 1000 miles long, and navigable 700 or 800 miles.

The region of the Y. and its source was for the first time explored by parties from the United States in 1870 and 1871, and seems to be one of the most wonderful spots in the earth. Making their way up the river through the grand scenery of the Rocky Mountains, the explorers came to a district of a square mile in area, filled with hot springs in active operation, which cover the hillsides with snowy white deposit like a frozen cascade. Three or four miles around were occupied by springs which have ceased to flow. They are about 6000 feet above the sea, and are already resorted to by

invalids. This was but the beginning of the wonders. Next they came to a terrific rift, 2000 feet in depth, with a river rolling in its depths, 'a grand, gloomy, terrible place.' At the head of this cañon are the Tower Falls, with a sheer descent of 400 feet. The Grand Cañon, however, throws this into the shade. This fearful abyss is 3000 feet in perpendicular height, and to one looking up from the bottom, stars are visible in broad daylight. The ravine is full of hot springs of sulphur, sulphate of copper, alum, steam jets in endless variety, some of most peculiar form. The grandeur of the cañon is at once heightened and diversified by the Upper and Lower Falls; the latter one unbroken symmetrical expanse, 360 feet in height. Between this fall and the lake lies a region full of boiling springs and craters, with two hills 300 feet high, formed wholly of the sinter thrown from the springs, one of which is 70 feet long by 40 broad. Still further on they came to a valley containing about 1500 geysers, some throwing up immense columns of water to the height of more than 200 feet—a stupendous spectacle! The lake from which the river issues is about 300 square miles in area, is situated 7427 feet above the level of the sea, and is described as 'the gem to which all the other wonders form the setting.'

**YEMEN**, in a wide sense, includes the whole south and south-west of Arabia; but, more strictly, is the name only of the south-western corner of the peninsula, bounded on the N. by Hedjaz and Nedjed; on the E., by Hadramaut and the Dahna, or Great Arabian Desert; on the S., by the Gulf of Aden; and on the W. by the Red Sea. It was known to the ancients as *Arabia Felix* (*Felix* being a mistranslation on the part of Ptolemy of *Yemen*, which does not mean 'happy,' but the land to the 'right' of Mecca), and they obtained from it much frankincense, myrrh, and other costly balsamic substances, in which it abounds more than any other part of the world; they obtained also from its ports the products of India, and other eastern regions, with which its inhabitants maintained a constant trade. The history of Y. reaches back to the highest antiquity. The Joktanides, descendants of Joktan or Kahtan, are its first possessors of whom we have any record; and from them it seems to have passed, about 2400 B. C., into the hands of the Himyarites, or Homerites. The Himyarite states and cities of Saba, Thaphar, and Athana or Aden, attained at an early period a high degree of prosperity, carrying on a great commerce both by sea and land, and they extended their dominion over a large part of Asia and the north-west of Africa. See **SABAEANS** and **ADEN**. The persecution of the Christians by the last Himyarite princes led to the overthrow of the Himyarite power by the Abyssinians, 529 A. D. From this date till 601, Y. was ruled by Abyssinian governors; then for a short time by the Persians, under Khoeru (*Cheroes*) II. The followers of Mohammed did not succeed in subduing Y. till they had for a considerable time been masters of the rest of Arabia. Under all the califs, and even under Saladin, Himyarite princes retained a partial independence, which they reacquired when the Turks, who conquered the country in the 16th c., were expelled in the century following. For more than two centuries afterwards, the country remained under the dominion of a number of Himyarite princes or sheiks, the most powerful of them being for a time the Imám of Saaná (q. v.). In 1871—1873 it was reconquered by Turkey.

The people of Y. differ considerably in physical characteristics, dress, and manners from the inhabitants of the other parts of Arabia, and their

## YENIKALE STRAIT—YETHOLM.

language gives evidence of a different origin. See **SARZANS**.

Our geographical knowledge of Y. has been much increased by recent explorations, and charts of its coasts have been laid down by officers in the service of the East India Company. Throughout the whole length of the country, at a distance of from 10 to 30 miles from the coast, a chain of mountains extends, between which and the sea is a tract of low ground, the *Tehama*, generally sandy and desolate, but in some places very fertile, and clothed with tropical vegetation. Inland from the mountain chain is a fertile table-land, at a general elevation of about 4000 feet, yielding the productions of warm temperate rather than of tropical regions. Some of the mountains rise to a height of about 8000 feet. The slopes even of the more lofty mountains are covered with luxuriant forests, and the mountain valleys are of unsurpassed fertility. The principal exports are coffee, dates, senna, gums and gum-resins, wax, ivory, and goat-skin morocco. Some grain is also exported. There are no rivers; but good harbours are formed in some places by natural openings in the coral reefs which line the coast. The principal ports are Mocha (q. v.), famous for the coffee which it exports; Aboo Arish, or Gasim; Hodeida; Shehr; and Aden (q. v.), which is now in the hands of the British. Sanaa, the capital, or nominal capital, is situated on the table-land. Damar, Taas, Loheia, Beit-el-Fakih, and Zebeed are among the other principal towns.

**YENIKALE STRAIT**, sometimes also called **STRAIT OF KERCH**, connects the Sea of Azov with the Black Sea, forming a sea-passage between the Crimea on the west and the Caucasus on the east. It is over 20 miles in length, and at its narrowest is less than 2 miles, and so shallow and interrupted by shoals, that cautious sailing and steering are necessary even for small steamers.

**YENISEI'**, one of the largest rivers of Siberia, formed by the junction of the Oulou-Keme and the Bey-Keme, which rise in the mountains on the southern border of Siberia. It flows north through the centre of Siberia into the Arctic Ocean, forming at its mouth a long estuary. In the earlier part of its course, it is interrupted by falls and rapids; but afterwards flows through a great plain or steppe, receiving many tributaries, of which the principal are the Upper Tunguska or Angara, from Lake Baikal; the Lower Tunguska, from the Baikal Mountains; and the Turoukhau. Its length is 3406 miles, and it drains a basin of upwards of 1,000,000 sq. miles. A great part of the Y. is navigable, and is now regularly traversed by steamers.

**YENISEI'SK**, a town in the government of the same name in Siberia, 850 miles east of Tobolsk, lat. 58° 27' N., long. 92° 16' E., on the Yenisei. Pop. (1867) 6644. Y. was founded in 1618, and is one of the most important towns of Siberia, the chief article of trade being furs, which are bartered by the native nomad tribes. It is three miles in circumference, and has a custom-house and arsenal.

**YEO'MAN** (Ang.-Sax. *gemen*, common), a term which seems, in early English history, to have been applied to a common menial servant, but after the 15th c. came to denote a class of small freeholders, farming the next grade below gentlemen. The term yeoman is sometimes considered identical with the forty shillings freeholder, possessed of the elective franchise.

**YEO'MANRY**, a volunteer force of cavalry in Great Britain, numbering in 1875, 15,130 of all ranks, and costing the country annually about £80,000. It was formed during the wars of the French Revolution, and then comprised infantry as well as

cavalry; but the whole of the infantry corps, and many of the cavalry, were disbanded after the peace of 1814. The organisation of the corps is by counties, under the lords-lieutenant. The men provide their own horses and uniform; in consideration of which they receive annually a clothing and contingent allowance of £2 a man, are exempt from taxation in respect to the horses employed on yeomanry duty, and draw during the annual training 2s. a day for forage, besides a subsistence allowance of 7s. a day. If called out for permanent duty, they receive cavalry pay, with forage allowance. The yeomanry are available in aid of the civil power; and in time of invasion, or apprehended invasion, the sovereign may embody them for service in any part of Great Britain, under the provisions of the Mutiny Act and Articles of War.

**YEOMEN OF THE GUARD**, a veteran company, consisting of 100 old soldiers of stately presence, employed on grand occasions, in conjunction with the gentlemen-at-arms, as the body-guard of the sovereign. These Yeomen were constituted a corps, in 1485, by King Henry VII., and they still wear the costume of that period. Armed with partisans, and in the quaint uniform, the men present a curious sight in the 19th century. The officers of the corps are a captain (ordinarily a peer), a lieutenant, and an ensign. There is also a 'Clerk of the Cheque and Adjutant.' All these appointments are held by old officers, and are considered as important prizes. The whole charge is borne by the sovereign's civil list. The headquarters of the corps is at the Tower of London, where the men are popularly known as *Beef-eaters* (q. v.).

**YEO'VIL**, a small municipal borough of Somersetshire, 20 miles south of Wells, on the borders of Dorsetshire, a busy, handsome place, built of red brick and yellow Hamhill (a neighbouring quarry) stone, and situated in a pleasing district on a hill-side sloping to the Yeo. The church of St John, a structure of the 15th c., is much admired. The height of the side aisles, and large size of the windows, give it grace and lightness, and hence it has been called the 'Lantern of the West.' There are several other churches, besides schools, almshouses, and other charities. Kid and other gloves are here more extensively manufactured than in any other town in England. There are about 20 manufactories, in which are produced about 10,000 dozen pairs of gloves per week. The number of males alone employed in this manufacture is about 2000; the females, who sew the gloves, all work at home, and are mostly the wives and daughters of agricultural labourers, inhabitants of the surrounding country, and amounting probably to about 10,000. Woollen manufactures and leather-dressing are also carried on. It has received its charter of incorporation since 1851. Pop. (1871) 8527.

**YER'CURUM**, another East Indian name of the plants called Mudar (q. v.), and of the fibre which they yield.

**YESSO**, or **JESSO**, the most northerly of the four principal islands which compose the empire of Japan, lies north of the central island of Nippon, from which it is separated by the Sangar or Tsugar Strait. It is about 350 miles in length from east to west, and is 250 miles in extreme breadth. Area estimated at 62,500 sq. m.; pop. unknown. The surface is mountainous, and the island is rich in minerals and timber. Bears and deer abound in all parts of Yesso. The largest town, Matamai, on the south coast, is said to contain 50,000 inhabitants. To the N.E. of it lies the treaty port of Hakodadi (q. v.).

**YETHOLM**, a parish of Scotland, in the

north-east of Roxburghshire, bordering on England, on the east and north-east, 15 miles east-north-east of Jedburgh. The Beaumont Water runs through the parish, and on either side of this stream are the villages of Kirk-Yetholm and Town-Yetholm, the former being the head-quarters of the gipsies in Scotland. According to the census of Scotland for 1871, the village of Yetholm contained 796 inhabitants.

YEW (*Taxus*), a genus of trees of the natural order *Taxaceæ*, which is very generally regarded as a sub-order of *Coniferae*, and is characterised by solitary and terminal fertile flowers, with a solitary ovule sessile in the centre of a fleshy disc, forming a sort of drupe when in fruit, and by dicotyledonous seeds. The genus *Taxus* is distinguished by a solitary terminal seed, surrounded by a succulent cup. The species are diffused over the whole northern parts of the world, and are large and beautiful evergreen trees, with narrow lanceolate or linear leaves. The COMMON YEW (*T. baccata*), a tree



Yew (*Taxus baccata*).

of 30—40 feet, and a trunk sometimes of great thickness, branching a few feet above the ground, and forming a large and dense head, is a native of the middle and south of Europe and of Siberia. Noble specimens of it are to be seen in many parts of Britain. It attains a great age, at least 300 or 400 years. Its wood has been much used from very early times for making bows, for which it is preferred to every other kind of wood. It is very hard, and reckoned almost equal to boxwood for fine work. The heart-wood is of an orange-red or deep-brown colour. The fruit is red, and was long reputed poisonous, but the pulpy part is not so; the seed, however, is a dangerous poison. The leaves also are a powerful narcotic; and although they are sometimes given as a vermifuge, their use is attended with danger.—The IRISH YEW (*T. fastigiata* of Lindley; *T. Hibernica* of Hooker), originally discovered in Ireland, and now very common in pleasure-grounds, is by many supposed to be a mere variety of the common species, with upright fastigiate habit, but it differs also in having the leaves scattered, whilst those of the Common Yew are in two rows.—The NORTH AMERICAN YEW (*T. Canadensis*) is of humbler growth.—The name JAPAN YEW is sometimes given to *Podocarpus macrophyllus*, a tree of a genus nearly allied to *Taxus*, and recently separated from it. It is a large and stout tree, a native of Japan; its wood much valued for cabinet-work. Other species of *Podocarpus* are natives of

the warmer parts of Asia, of Chili, New Holland, &c. *P. nucifer* is a lofty tree of the northern provinces of Japan and mountains of Nepal, from the seed of which an oil is extracted, fit for culinary purposes, although the seed itself is too astringent to be eaten. To the order or sub-order *Taxaceæ* belongs also the genus *Salisburia* (see GINGKO), the genus *Dacrydium* (q. v.), and *Phyllocladus*, a genus in which the foliage, as in *Salisburia*, has a remarkable resemblance to the fronds of ferns. *P. trichomanoides* is a large New Zealand tree.

YEZD, a considerable city of Western Persia, situated on the south-west of the great desert of Khorasan, in lat. 32° 10' N., long. 54° 50' E. It is the great emporium of the internal commerce of the empire. Manufactures of silk stuffs, velvets, cotton and woollen fabrics, arms, and loaf-sugar are carried on, and the bazaars are spacious and well supplied. Pop. 40,000. This includes about 4000 Guebres (q. v.). The latter are exempt from military service, and are now said to be well treated, both by the authorities and inhabitants. They complain, however, of grievances, of which complaint was made to the Shah when in London, by their kindred and co-religionists, the Parsees of Bombay, in June 1873. See Report by Mr Ronald Thomson, Persian Secretary of Legation, on the Population, &c. of Persia, 1868, and *Times* of June 28 and July 16, 1873.

YGGDRASIL, the name given in Scandinavian Mythology to a tree, the greatest and most sacred of all trees, which was conceived as binding together heaven, earth, and hell. It is an ash, whose branches spread over all the world, and reach above the heavens. It sends out three roots in three different directions: one to the Aas-gods in heaven, another to the Frost-giants, the third to the under-world. Under each root springs a wonderful fountain, endowed with marvellous virtues. From the tree itself drops a honey-dew. Among its branches and roots, several animals sit or run about: an eagle, a squirrel, four stags, a serpent, all having their own proper names. The serpent, Nithhöggr, lies at the under-world fountain and gnaws the root of Y.; the squirrel, Ratatöskr, runs up and down, and tries to breed strife between the serpent and the eagle, which sits aloft.

Of this old-world myth too imperfect an account has survived to enable us to read its meaning. Some writers in the middle ages bring it into connection with the Cross. It is striking to find Virgil (*Georg.* ii. 291) describing the ash as sending its branches as high into the air as it sends its roots into the earth—

*Æsculus in primis, que quantum vortice ad auras  
Ætherias, tantum radice in tartara tendit.*

Remarkable coincidences, although of a fragmentary kind, are also found in eastern traditions.

Jacob Grimm sees an intimate connection between the world-tree Y. and the *Irmensäule*, of which numerous traces are to be found in the records of German antiquity. This is described by Rudolf of Fuld as a great trunk of a tree set upright, and worshipped in the open air; the name *Irmensäule*, he explains as meaning the universal or all-sustaining pillar (Ger. *Säule*, pillar). Such a tree-idol was destroyed by Charles the Great in his conquest of the Saxons in 772, at a place called Heresburg, in Westphalia, which was a chief seat of the pagan religion of the Saxons. The word *irmis*, Ang.-Sax. *cornes*, was frequently compounded with other words in the earlier stages of the Teutonic languages, in the sense of universal, greatest of all. As the primitive nature-worship tended more and more to the personification of particular powers, these trunk-idols were associated with particular divinities, and perhaps

had an image set upon them, or were cut into some rude resemblance, as in the case of the Greek pillar-images called *hermes* (see HERMES). The coincidence of the names *irmis* and *hermes*, which may, however, be casual, has not failed to be remarked. The Christmas tree of modern Germany may be some kind of offshoot of the old notion of Yggdrasil.

Y-MOTH (*Plusia gamma*), a beautiful species of Moth (q. v.), common in Britain and throughout great part of Europe, about an inch in entire length, without reckoning the antennæ, which are not quite half an inch. The colour is lilac, variegated with brown, the upper wings beautifully marbled, with a shining mark nearly in the form of the letter Y, or of the Greek  $\gamma$  (Gamma), whence the name. The lower wings are dirty white, with a broad smoky border, and a white fringe, spotted with black. This moth flies about during the day in summer and autumn. It is very swift of flight. It lays its eggs on the under side of leaves. The caterpillar is slightly hairy, green with a yellow line along each side, and five white ones down the back. It feeds on the leaves of a great variety of plants, as peas, beans, turnips, cabbages, hemp, clover, oats, and other grasses. It sometimes ravages gardens, but more in France than in Britain.

YOGA (from the Sanscrit *yuj*, join; kindred to the Lat. *jung*-, Gr. *zeug*-, Gothic, *jiuk*; hence *junction*, and figuratively, 'concentration, religious or abstract contemplation') is the name of one of the two divisions of the Sāṅkhya philosophy of the Hindus. See SĀṆKHYA. While the first of these divisions, the Sāṅkhya proper, is chiefly concerned in teaching the *tattvas*, or principles of creation, and the successive development of the latter, the main object of the Yoga is to establish the doctrine of a Supreme Being, and to teach the means by which the human soul may become permanently united with it; and since the Sāṅkhya proper is silent on the creation of the world by a Supreme Being—whence it was charged, though unjustly, by its opponents, with being atheistical—the Yoga, which is called theistical, is considered to be its complement. According to *Patanjali*, the reputed author of this system, the term *Yoga* means 'the hindering of the modifications of thinking;' and by such modifications, which, he says, may be accompanied with afflictions, or be free from them, he understands 'the three kinds of evidence—viz., perception, inference, and testimony—misconception or incorrect ascertainment, fancy, sleep, and recollection.' The 'hindering of these modifications' is, according to him, effected either by a repeated effort to keep the mind in its unmodified state, or by dispassion, which is the consciousness of having overcome all desires for objects that are seen (on earth) or are heard of (in Scripture). Dispassion is conducive to meditation; this, again, is of different kinds, and is attained either 'impetuously'—in adopting various transcendent methods—or 'by a devoted reliance on *Īśwara*, the Lord.' This Lord, or Supreme Being, *Patanjali* then defines as 'a particular *Puruṣa*, or spirit, who is untouched by afflictions, works, the result of works, or deserts; in whom the germ of omniscience reaches its extreme limit; who is the preceptor of even the first, because he is not limited by time; and whose appellation is *Om*, the term of glory.' This word is to be muttered, and its sense is to be reflected upon, for 'from

it comes the knowledge of *Īśwara* and the prevention of 'the obstacles' which impede Yoga. These obstacles, *Patanjali* says, are 'illness, apathy, doubt, listlessness about the accomplishment of meditation, want of exertion, attachment to worldly objects,

erroneous perception, failure to attain any stage of meditation, or inability to continue in the state of meditation when it has been reached.' There are several other methods to prevent these obstacles from distracting the mind, and impeding its steadiness. One, for instance, consists in pondering over one single accepted truth; another in 'practising benevolence, tenderness, complacency, and disregard towards all objects in possession of happiness or grief, virtue or vice;' another, in 'forcibly expelling or retaining the breath;' another, in 'dwelling on knowledge that presents itself in dream or asleep;' &c. When all these modifications have disappeared, the mind becomes free from 'the tingeing' of the exterior world, as the pure crystal is free from the colour that seems to belong to it, when a coloured substance is seen athwart it. After having described the various modes in which the mind may appear changed into the likeness of what it ponders, the author of this system then proceeds to explain the practical Yoga, by which 'concentration' may be attained. It comprises, according to him, mortification, the muttering of certain hymns, and a devoted reliance on the Lord. Through it, meditation is established, and afflictions are got rid of. By afflictions, again, he understands ignorance, egotism, affection, aversion, and tenacity of life; which terms are then the subject of an especial investigation into the nature of what is to be got rid of, of what is not desired to be got rid of, of what is constituted by the cause, and of what is the constitutive cause.—There are eight means or stages subservient to the attainment of concentration—viz., forbearance (*yama*), religious observance (*niyama*), postures (*āsana*), regulation of the breath (*prāṇāyāma*), restraint of the senses (*pratyāhāra*), steadying of the mind (*dhāraṇā*), contemplation (*dhyāna*), and profound meditation (*samādhi*).—The first stage, *forbearance (yama)*, consists in not doing injury to living beings, veracity, avoidance of theft, chastity, and non-acceptance of gifts; they are the universal great duty.—The second stage, *religious observance (niyama)*, comprises purity—external as well as internal—contentment, austerities, muttering of the Vedic hymns, and devoted reliance on the Lord.—The third stage of Yoga, *postures (āsana)*, is defined by *Patanjali* as 'that which is steady and comfortable' at the same time. The commentators mention several varieties of such postures. According to an interesting treatise on the Yoga philosophy by *Navinachandrapāla*, one of these, called *Siddhasāna*, is practised by placing the left heel under the anus, and the right heel in front of the genitals, by fixing the sight upon the space between the eyebrows, and, while in this motionless attitude, meditating upon the mysterious syllable *Om* (q. v.). Of the posture called *Padmāsana* the same treatise says, that it consists in placing the left foot upon the right thigh, and the right foot upon the left thigh, in holding with the right hand the right great toe, and with the left hand the left great toe, the hands coming from behind the back and crossing each other; while the chin rests on the interclavicular space, and the sight is fixed on the tip of the nose. When the command of such postures is attained, *Patanjali* says, the Yogin does not suffer either from cold or heat, hunger or thirst, or similar afflictions.—The fourth stage, *regulation of the breath (prāṇāyāma)* is threefold, according as it concerns exhalation or inhalation, or becomes tantamount to suspension of the breath, the latter also being termed *kumbhaka* (from *kumbha*, a jar), because 'the vital spirits then are as motionless as water is in a jar.' Through such a regulation of the breath, the obscuration of the pure quality of the mind is removed, and the



latter becomes fit for acts of attention. Navinachandrapála describes different processes of the Prán'yama as selected from different authorities. One, for instance, consists, according to him, in the act of inhaling through the left nostril for 7-6788 seconds, suspending the breath for 30-7152 seconds, and exhaling through the right nostril for 15-3576 seconds; then inhaling through the right nostril for 30-7152 seconds, exhaling through the right nostril for 7-6788 seconds, suspending the breath for 30-7152 seconds, and exhaling through the left nostril for 15-3576 seconds; lastly, inhaling through the left nostril for 7-6788 seconds, suspending the breath for 30-7152 seconds, and exhaling through the right nostril for 15-3576 seconds. To the *kumbhaka*, of which there are eight varieties, the same author observes, two processes are indispensable: sitting in one of the postures described; and, by means of an incision in the frænum linguae, and milking, as it were, the tongue, causing it gradually to become so lengthened as to allow the rima glottidis to be shut by pressing back the epiglottis with the point of the retroverted tongue. Such *kumbhakas*, it is supposed, produce the most wonderful effects: some of them cure diseases of the head and lungs, dropsy, &c.; others make proof against all sorts of inflammation and fever; the eighth or last variety of the *kumbhaka*, especially, cures all diseases, purges from all sins, promotes longevity, enlightens the mind, and awakens the soul.—The fifth stage of Yoga, the *restraint of the senses (pratyáhára)*, means the withholding of the senses from their respective objects, and the accommodating them entirely to the nature of the mind. According to an authority quoted by Navinachandrapála, a Yogin's senses are suspended when he can suspend the respiratory movements for 10 minutes and 48 seconds.—This stage is preparatory to the sixth, or the *steadying of the mind (dharaná)*, which means the freeing of the mind from any sensual disturbance, by fixing the thoughts on some part of the body, for instance, on the navel or the tip of the nose. This stage, it is supposed, can be accomplished when the Yogin is able to suspend his respiratory movements for 21 minutes and 36 seconds; and, according to Navinachandrapála, it is effected by different processes—muttering the syllable *Om* 144,000 times, fixing the eyes upon the tip of the nose, or the space between the eyebrows, for two hours, swallowing the tongue for two hours, &c.—*Contemplation (dhyána)*, the seventh stage of Yoga, is the fixing of the mind on the one object of knowledge, the Supreme Spirit, so as to exclude all other thoughts. It is practised in consequence of the 'steadying of the mind,' as defined before; and, according to the authority quoted by Navinachandrapála, a man can accomplish it when he is able to suspend his respiratory movements for 43 minutes and 12 seconds.—The eighth and last stage of Yoga, *profound meditation (samádhi)*, is the perfect absorption of thought into the one object of meditation, the Supreme Spirit; it is devoid, as it were, of any definite character, which would suggest a term as applicable to it. In such a state, Navinachandrapála says, 'a Yogin is insensible to heat and cold, to pleasure and pain: he is insensible to blows and wounds, to the effects of fire; he is the same in prosperity and adversity; he enjoys an ecstatic condition. He is free from lust, fear, and anger; he is disengaged from all works. He is not affected by honour and dishonour. He looks upon gold, iron, and stones with the same unconcerned eyes. He is the same in love and in hatred; he is the same amongst friends and enemies.' And according to the authority he quotes, such a state may be

attained by a man who can suspend his respiratory movements for 1 hour, 26 minutes, and 24 seconds.—The last three stages are also comprised under one distinctive name, *Sam'yama*, or 'restraining,' because it is chiefly on the perfection attained in these three collectively that depend the wonderful results which are promised to a Yogin when he applies them to the contemplation of special objects. Such results are, for instance, a knowledge of the past and future, a knowledge of the sounds of all animals, of all that happened in one's former births, of the thoughts of others, of the time of one's own death, a knowledge of all that exists in the different worlds, of stars and planets, of the structure of one's own body, &c. There are especially, however, eight great powers which a Yogin will acquire when properly regulating and applying the *sam'yama*—viz. the power of shrinking into the form of the minutest atom; that of assuming a gigantic body; that of becoming extremely light; that of becoming extremely heavy; that of unlimited reach of the organs (as touching the moon with the tip of a finger); that of irresistible will; that of obtaining perfect dominion over the inner organs of the body; and that of acquiring mastery over everything. If the Yogin applies *sam'yama* to the contemplation of the smallest divisions of time, and the successive order in which such divisions occur, he obtains a discrimination which enables him to understand the subtle elements, and to see all objects at once. When his intellect has become free from all considerations of self, and his spirit is no longer subject to the result of acts performed, and when both have thus attained the same degree of purity, the Yogin obtains eternal liberation.—In the last chapter of his work, Patanjali then shews that these perfections are not always obtained by Yogins in one birth, but that *Prabódhi*, or nature (see ΣΑΝΚΗΥΑ), generally in a succession of births, brings to maturity the result obtained in a prior birth. He thus makes nature, not actions, the cause of each effect; meritorious actions merely serving, according to him, to remove the obstructions which, from bad actions, would arise to its regular progress, just as water would take its natural course after the husbandman, who would want to lead it from field to field, had removed the obstructions that lay in its path. After having then taught that the result of actions, in successive births, consists in the recollection of a prior state, and in the obtainment of a special (existence, a special duration of life, and special enjoyments); and after having discussed the different influences to which the mind may become subject in its union to different objects, Patanjali winds up with describing the mode in which final liberation gradually takes place. First, he says, when a person has obtained the discrimination conveyed by the Yoga doctrine, all ideas of self—such as, I am different from another—cease. In consequence, thought is turned inward, and this is the commencement of liberation. But, as still recollections, derived from former existences, sometimes prevail in his mind, they must be abandoned by him in the same way as he has to overcome the afflictions, above specified. When he has succeeded in this, his knowledge will have become so infinite, that but little will remain for him to be known. Then the cosimical *gun'as*, or qualities, too (see ΣΑΝΚΗΥΑ), having accomplished the main object of spirit, will have gradually arrived at the end of their functions, and, as a consequence, matter will become separated from spirit. This is *káivalya*, or true liberation, for the mere power of the mind to retain its nature after dissolution has taken place, is not yet true liberation.—The practical part of the Yoga was admitted into the later Vedánta (q. v.). Its ethical

portion is especially dwelt upon in the celebrated episode of the Mahābhārata (q. v.), the *Bhagavadgītā*. But the great power it has at all periods exercised on the Hindu mind, is less derived from its philosophical speculations or its moral injunctions, than from the wonderful effects which the Yoga practices are supposed to produce, and from the countenance they give to the favourite tendency of orthodox Hinduism, the performance of austerities. It is needless, however, to say that frequently these practices were and are merely a cloak for imposture and hypocrisy, and that the professional Yogins (q. v.), numbers of whom are met with throughout India, are often nothing but lazy mendicants or jugglers, who, by impressing the vulgar with a belief in their supernatural powers, convert it into a source of an easy livelihood. Such followers of the Yoga pretend, for instance, to foretell future events; they deal in palmistry, and profess to cure diseases. There are instances, too, where, for a handsome consideration, they allow themselves to be buried for a certain time, so as to exhibit the power of the Yoga. Two such cases are related as authentic in the treatise of Navinachandrapāla; and it would appear from them, that a human being, after having undergone certain preparations, such as the Yoga prescribes them, may be shut up in a box without either food or drink, for the space of a month, or even forty days and nights, and yet remain alive. The author of the treatise endeavours, indeed, to shew that the rules laid down by the Yoga regarding the mode of respiration, the postures, and the diet of a Yogin, may have been founded on a careful observation of the nature and habits of hibernating animals; and in support of this view, he enters into a detailed investigation of the effect of the Yoga practices on animal life. If, as it seems, his statements are correct, much of what otherwise would be incredible in the accounts given of the performances of Yogins, could be received as true, because admitting of explanation. The system of *Patanjali* was taught by him in a little work called *Yogasūtra*, which consists of four Pādas, or chapters, each comprising a number of Sūtras (q. v.). The oldest commentary on it is ascribed to a *Vyāsa* (q. v.); and this was commented on by *Vachaspathi-Miśra*. Of other commentaries, those by *Vijnānabhikṣu*, *Bhojadeva*, and *Nāgajībhātā* are the most approved.—For a fuller enumeration of works on the Yoga, see *A Contribution towards an Index to the Bibliography of the Indian Philosophical Systems*, by Fitzedward Hall (Calcutta, 1859). The first two chapters of the Sūtras have been translated, with annotations, founded on the commentary of Bhojadeva, by the late J. R. Ballantyne (Allahabad, 1853); and a paraphrase, but somewhat too free, of the same commentary is contained in the 4th vol. of William Ward's *View of the History, Literature, and Religion of the Hindus*, &c., 4 vols. (London, 1817—1820). For a brief account of the system, see also the 1st vol. of H. T. Colebrooke's *Miscellaneous Essays*, 2 vols. (London, 1837); and for the practice of the Yoga, *A Treatise on the Yoga Philosophy*—that referred to above—by N. C. Paul (i. e., Navinachandrapāla), (Benares, 1851).

YOGIN, a follower of the Yoga system of Hindu philosophy (see YOGA), but in popular acceptance a term generally denoting a Hindu ascetic or devotee, a man who has entered the fourth stage of religious life as described in the Sūtras. A large class of such persons forms a division of the votaries of Śiva. See ŚAIVAS.

YOKOHAMA (Japanese for 'Cross Shore'), a town of Japan, in the island of Nipon, and the

port for the foreign trade of Yedo. It is situated on the south side of a bight of the bay of Yedo, about 17 miles from Yedo, and opposite to Kanagawa. In 1864, it was only a small fishing village, but after it supplanted Kanagawa as the treaty port of Yedo in 1859, it rapidly increased. The Japanese government built at a great outlay solid granite piers and landing-places, a large custom-house, official residences, and shops for Japanese traders; besides houses and godowns for the foreign community and merchants. It now extends along the sea-shore for about a mile and a half, and is two or three streets deep. The pop. exceeds 20,000. The custom-house is nearly in the centre of the town; and east and west of it, lie respectively the foreign and native quarters. The shops are filled with goods to suit the foreign taste—such as lacquered ware of rare quality and bronze-work, baskets and porcelain, fancy silks and embroidery, curiosities and articles of vertu. Since the recent changes in the policy of the Japanese government, great improvements have taken place in the native quarter. Broad and cleanly streets are rapidly superseding the former dirty and narrow thoroughfares. A canal is drawn as a cordon around the settlement on the land-side, and in 1871 the Japanese government widened and deepened it very considerably. Other important undertakings have recently been carried out, the chief of which is a railway from Y. to Yedo. Gas was introduced in 1872.

In 1874, the total value of the imports (principally cotton, yarns, shirtings, woollen goods, and sugar) amounted to 16,016,316 dollars; and of the exports (principally silk and tea) to 12,578,573 dollars.

YONGE, CHARLOTTE MARY, a novelist of considerable merit and popularity, was born in the year 1823. She is a daughter of the late William Crawley Yonge, Esq. of Otterbourne, Hampshire, sometime an officer in the 82d Regiment. The work by which she is best known is *The Heir of Redclyffe*, which had great success, and has gone through several editions. Besides this, she is the author of *Heart's Ease*, *Dynceor Terrace*, *The Daisy Chain*, *The Lances of Lynwood*, *The Little Duke*, &c. These works exhibit much literary accomplishment, and have secured for Miss Y. a public of her own. The spirit which pervades them is pure, amiable, and pious; and commonly the stories are more or less contrived as vehicles of the High-Church opinions to which the writer is warmly attached. Considerable sums accruing from the sale of her writings she is said to have devoted to the aid of religious missions in New Zealand. In addition to the fictions by which she is chiefly known, Miss Y. has published a work *On Christian Names, their History and Derivation*, in which much curious erudition is displayed; *Life of Bishop Pattenon* (1873); some small historical works, &c.

YO'NKERS, a city of New York, U. S., on the E. bank of the Hudson River, 16 miles N. of New York City Hall. In 1872 the town of Y. was divided, the northern part being constituted the city of Y.; the southern portion became part of New York City in 1874. Pop. (1875) 17,269.

YONNE, a department in the north-east of France, bounded on the N. by the department of Seine-et-Marne, on the E. by Aube and Côte-d'Or, on the S. by Nièvre, and on the W. by Loiret. Area, 2868 sq. m.; pop. (1872) 363,608. The department is watered by the river Yonne, which flows across it in a north-east direction. The surface is hilly, many of the hills being covered with fruitful vineyards, the intervening valleys being beautiful and fertile. The vineyards yield annually upwards of 22,000,000 gallons of wine.

There are some fine forests in the department. The climate is generally healthy, except in the south-west, where the marshes often give rise to fever. The soil produces abundance of grain, but the cultivation of the vine is of the greatest importance, the best wines produced here being those of Chablis, Joigny, Auxerre, and Tonnerre. The chief mineral products are red granite, marble, lithographic stones, pavement, red and yellow ochre, iron. There are manufactures of cottons, woollens, beet-root sugar, bricks, tiles, &c. The chief exports are timber, corn, and wine. It is divided into five *arrondissements*—viz., Auxerre, Avallon, Joigny, Sens, Tonnerre. The railway from Paris to Lyon passes through the department. The capital is Auxerre; the other chief towns are Avallon, Joigny, Sens, and Tonnerre.

**YORK, HENRY BENEDICT MARY, DUKE OF,** Cardinal, and Bishop of Frascati, the last male descendant of the royal House of Stuart, was the second son of James (III. of England), commonly known as the Pretender. He was born at Rome, March 26, 1725; and after the failure of the attempt of his elder brother, Charles Edward, in 1745, resolved to enter the church. He was admitted to tonsure and minor orders by Benedict XIV., and created Cardinal in 1747. Clement XIII. consecrated him Bishop of Corinth *in partibus infidelium*, and afterwards of the suburban see of Frascati, where he took up his residence. He also enjoyed, through the favour of the crown of France, the revenues of two abbeys, which he held in *commendam*, as well as a pension from the Spanish court; and the liberal charity with which he dispensed his income among the poor, and for the other charitable and religious necessities of his diocese, endeared him to his flock. These resources were lost at the Revolution; but, nevertheless, in the distresses of the holy see which ensued, Cardinal Y. sold his family jewels for the purpose of relieving Pius VI. in his necessities. On the occupation of Rome, he withdrew to Venice; but he returned in 1801, on the restoration of the papal authority under Pius VII. George III., having become aware of the failure of his former means of income, granted him a pension of £4000 a year, which he accepted, and enjoyed till his death. Those to whom a printed record of the 'Last of the Stuarts' may be interesting, will find a small collection of his 'Pastoral Letters,' in a 4to volume published in Rome, and entitled *Appendix ad Tusulanam Synodum a Celsitudine Regia Eminentissimi Henrici Episcopi Tusulanani* (Rome, 1764). He was appointed by Pius VII. Dean of the Sacred College, and held several other dignities, and was much respected, as well by the Italians as by foreigners visiting Rome. He died at Frascati, July 17, 1817, at the advanced age of ninety-two. His last will, which is a very interesting document, is printed by Artaud in his *Vie de Pie VII.* His monument, by Canova, in St Peter's, was erected by order of the Prince Regent, afterwards George IV.

**YORK, HOUSE OF.** See PLANTAGENET.

**YORK,** the capital of Yorkshire, is situated at the junction of the rivers Ouse and Foss, the three Ridings of the county meeting at the same place, and is nearly equidistant from London and Edinburgh. It is the seat of an archbishopric, a county in itself, and a municipal and parliamentary borough. The government is vested in 12 aldermen and 36 councillors, of whom one, as in the case of London, is Lord Mayor. It returns two members to parliament. The pop. in 1871 was 43,796, being an increase from 1861 of 3363 persons, and 904 inhabited houses. In the registration district of which Y. is the centre, there are 83 parishes, with an

area of 82,545 statute acres, and a pop. in 1871 of 64,909.

Y. is amongst the most ancient of British cities. Before the Roman invasion, it was one of the chief towns of the Brigantes, the most numerous and powerful of the British tribes. It was constituted a Roman station, under the name of *Eboracum*, by Agricola about 79 A.D., and was very soon the principal seat of Roman power in the north, perhaps in Britain. While the Roman dominion existed in the island, Y. was a city of the first importance. Here Hadrian lived and Severus died. Here, too, died Constantine Chlorus, the father of Constantine the Great, and here, as many believe, his greater son was born. When the emperors visited the province, Y. was their chosen residence, and it was the abode of the imperial legates when the emperors were absent. Little is known of the city for a century after the departure of the Romans, about 409 A.D., but it certainly suffered much during the long conflict between the Britons and the Picts, against whose incursions Y. was a material defence. It afterwards became the capital of Northumbria. The first metropolitan church in England was built here by Edwin, the Northumbrian king whom Paulinus baptised; and here also Edgar, the first sole monarch of England, held, in the year 966, the Witenagemot. William the Conqueror was long unable to overcome this stronghold of the north, notwithstanding his coronation by its archbishop, Aldred. One Norman garrison, numbering 3000 men, was put to the sword in 1069; but William exacted a terrible vengeance in the following year, when he laid waste the whole country between Y. and Durham.

The first English parliament was held at Y. in 1160 by Henry II., and for 500 years afterwards parliaments continued to be summoned occasionally to the ancient city. Under Henry III., the courts of King's Bench and Exchequer sat at Y. for seven years; and for a few months, Richard II. removed thither the courts of King's Bench and Chancery. During the insurrections consequent upon the dissolution of the monasteries by Henry VIII., Y. was seized by the insurgents of the 'Pilgrimage of Grace'; and in its immediate neighbourhood, Fairfax, in 1644, conquered Prince Rupert on Marston Moor. Typical of a very different time and order of things is the fact that the British Association for the Advancement of Science was first organised at Y. in 1831.

A city so ancient necessarily presents many interesting memorials of antiquity. There are remains or memorials of Roman towers and temples, and of the earliest British churches. One of the most magnificent of the Anglo-Saxon churches was erected at Y. in the 8th c., and this, destroyed by fire, rebuilt, enlarged, and changed from time to time, is now known as York Minster. A portion of the original church was disinterred during the excavations which followed the latest burning of the minster, in 1829. The present structure takes rank with the finest specimens of Gothic architecture in the world. It was mainly built in the 13th and 14th centuries. Its length, from base to base of the buttresses, is 524 feet, and its extreme breadth 250 feet, being 24 feet longer than St Paul's Cathedral, and 149 feet longer than Westminster Abbey. The magnificent east window is 75 feet high and 32 feet broad, and contains about 200 compartments, each a yard square, representing scriptural subjects. War and fire have conspired to deform or destroy this splendid cathedral. Twice it has been burned down, once in 1069, and again in 1137, each time to rise more beautiful than before. During the times of the Commonwealth, much damage was done by

war and wantonness, and several of its older monuments were mutilated or broken up. In 1829, it was set on fire by Jonathan Martin, a maniac; and the roof of the choir, 222 feet long, with all the woodwork on each side, was destroyed. While this disaster was being repaired, a workman's candle was carelessly left burning, one night in 1840, and again a terrible fire broke out, destroying the south-western tower, with its splendid peal of bells, and the roof of the nave. The cost of the repairs exceeded £100,000.

A monastery of Benedictine monks was built, or rather completed, at Y. in the time of William Rufus, which was in great part reconstructed about the end of the 13th century. Its abbot had a mitre and a seat in parliament. Some portions of the original building yet remain. Thirteen seceders from this monastery established, in 1131, the neighbouring Abbey of Rountains, near Ripon, under Cistercian rule. On the site of the Benedictine monastery now stand the museum and gardens of the Yorkshire Philosophical Society. The same order had a priory dedicated to the Holy Trinity in Micklethorp, and a nunnery outside the walls at Clementhorp. Besides these, the Dominicans, Franciscans, Augustinians, and Carmelites had each a monastery, and the Gilbertines a priory, within the city. In the immediate neighbourhood were 16 hospitals. At the Reformation, Y. contained 41 parish churches, 17 chapels, 16 hospitals, and 10 religious houses. Twenty-two of the churches yet remain, and several new churches and chapels of ease have been built in or near the city. The Roman Catholics have two chapels, and the various bodies of dissenters, 14.

The educational institutions of Y. are numerous and useful. Notable among them are St Peter's School, founded in 1557; Archbishop Holgate's Free School, dating from Henry VIII.; the Blue Coat School for boys, and the Gray Coat for girls, supported chiefly by annual subscriptions; the York Collegiate School (proprietary); the York and Ripon Diocesan Training-school for Masters; and the Yorkshire School for the Blind, dedicated to the memory of William Wilberforce, and conducted in a palace originally built for the Lord President of the Council of the North.

The Yorkshire Philosophical Society was formed in 1822, and possesses a handsome building and gardens on the site of the ruined St Mary's Abbey, with a museum, rich in antiquarian relics and specimens illustrative of natural history. Among other public institutions are the County Hospital, the first established in England north of the Trent; the Lunatic Asylum; the Dispensary; the Friends' Retreat; and very many charitable foundations for the benefit of poor persons. The ancient castle, with the exception of its imposing Clifford's Tower, is superseded by the modern and commodious assize courts. The Guildhall, a fine Gothic building, was erected in 1446. There are also convenient assembly and concert rooms, and a creditable theatre.

Whatever the trade of York may have been in ancient times—and old writers speak of it in glowing terms—it counts for little now. The making of leathern gloves, combs, glass, &c., supplies employment to many; some find employment in iron-foundries, in flax-spinning, and the manufacture of linen; and of late, the construction of railway carriages has become part of the city industry.—See Drake's *Eboracum*; Browne's *History of the Metropolitan Church of St Peter's, York*; Britton's *Cathedral Antiquities—York*; Hargrave's *History of York*; Gent's *York*; Wellbeloved's *Eboracum, or York under the Romans*.

YORK, a shire-town of Pennsylvania, on Codorus Creek, 10 miles south-west of the Susquehanna

River, 28 miles south-south-east of Harrisburg, at the intersection of several railways. It has a spacious granite court-house, numerous churches, handsome residences, six banks, seven newspapers. Pop. in 1870, 11,003.

YORK, a river of Virginia, formed by the union of the Pamunkey and Mattaponi, flowing south-east to the Chesapeake Bay, nearly opposite Cape Charles. It is 40 miles long, and from one to three miles wide. Yorktown, an ancient but decayed port, on the right bank, eleven miles from its mouth, was the scene of Lord Cornwallis's surrender, October 19, 1781.

YORKSHIRE, which is larger in territorial extent than any other two counties in England, is situated nearly in the centre of Great Britain, about midway between London and Edinburgh. 'Its extreme points,' says Allen, in his *History of the county*, 'lie between the parallels of 53° 18'—54° 40' N. lat., and between 2° 40' of W.—0° 10' of E. long. from Greenwich. On the N. side, it is separated, in its whole extent, from the county palatine of Durham by the river Tees; from the mouth of the same river to the entrance of the Humber, the whole E. side is bounded by the German Ocean; on the S. side it is divided from Lincolnshire by the rivers Humber and Trent. The boundaries between Y. and the counties of Nottingham, Derby, Cheshire, Lancashire, and Westmoreland are merely conventional, being indicated by no natural feature of the country.' The longest diagonal of the county, north-west to south-east, extends about 130 miles; the shortest, south-west to north-east, about 90. It contains about 6095 square miles, or 3,882,851 statute acres. It is divided into three Ridings, North, East, and West, and a small district not included in any of the three, the Ainsty of York. The Ridings (a corruption of tri-thing or thirding) date back to Saxon times, and are peculiar to Yorkshire. Each has a separate military and civil jurisdiction, and each its own lord-lieutenant and public buildings. The North Riding contains 11 wapentakes; the East, 6; the West, 9; in the whole county, besides the archiepiscopal city, there are 59 market-towns, and 1639 parishes, townships, and places. The North Riding (including for Parliamentary purposes the Ainsty and City of York) returns 2 county and 12 city and borough members; the East Riding, 2 county and 2 borough members; the West Riding, 6 county members (2 for the Eastern Division, 2 for the Northern, and 2 for the southern) and 16 borough members. According to the census of 1871, the population was 2,436,355. Three-fourths of the whole number were resident in the West Riding. Since the first census in 1801, the population had increased by 1,577,222 persons, or 184 per cent.

The history of the county in early times may be mainly read in that of its chief city. Apart from the events which transpired at, and in connection with York, there is little to be recorded. It was originally occupied by the Brigantes, and was subjected by the Romans under Agricola about 71 A.D. When the Roman occupation ceased, it was long and greatly troubled, first by Pictish, and then by Saxon incursions. Under Saxon rule, the traces of Brigantian occupancy were soon obliterated, only the rivers, mountains, and a few remarkable natural curiosities retaining their British names, while all things else received Saxon designations. The county formed part of the kingdom of Northumbria, taking the name of Deira (the Country of Deer), when that kingdom was divided. In the troublous times which preceded the Conquest, many battles were fought against invading Danes, and generally with success.

At Stamford Brig, a few miles from York, Harold, the last of the Anglo-Saxon kings, defeated the united Danish and Norwegian armies, three weeks before he fell before the Normans on the fatal field of Hastings. Among the more notable events of later history, may be named the battle of Wakefield, where the Duke of York was defeated by Queen Margaret in 1460; the battle of Towton Field, near Tadcaster, fought on Palm Sunday in 1461, the most sanguinary conflict of the bitter war between the rival Roses; and that of Marston Moor, which gave the final blow to the falling fortunes of Charles I. Since that time, with slight exceptions, the history of Y. has been one of peace and prosperity.

The surface of the county is greatly diversified. On its north-western border runs a range of lofty hills, many of them containing extensive caverns, and giving birth to wild and romantic streams. Here is Ingleborough, 2361 feet above the sea-level, with its marvellous cave, half a mile long, full of beautiful stalactites; Wharfedale, 2384 feet high, with its subterranean cataract of 75 feet in Weathercote Cavern; and the vast mass of Mickel Fell, 2600 feet, which overlooks the waters of the Tees and Lune. Eastward, far away, rise the Hambleton and Cleveland Hills. Lower down are the Wolds, a line of chalk hills stretching from Flamborough Head to Ferriby on the Humber. The hills and dales of Craven, which cover a large tract of country in the west, abound in natural beauty. Right down the centre of the county, from the Tees to the Humber, runs the great Vale of York. Across its northern border flows the Tees. Coming southward, we find the dales of the Swale, the Ure, the Nidd, the Wharfe, the Aire, the Calder, and the Don, all on the western side of the county, each sending a river to the central vale, where the united waters, with the Derwent and a few smaller tributaries from the east, form the Ouse; while the Ouse, after uniting with the Trent, becomes the Humber estuary, which rolls eight-tenths of the Y. waters to the sea. The Ribbles, rising in Craven, passes by Preston, and falls into the Irish Channel, and is the only Y. river which finds a western outlet. The Esk joins the German Ocean at Whitby, and the Tees between Redcar and Hartlepool.

Geologically, Y. is too large a subject for us to do more than touch. The Vale of Y., rarely more than 100 feet above the sea, has on its western side the long low elevations which culminate in the Pennine chain, while on the east rise the lower but more sudden eminences of the Wolds and the high grounds of Hambleton and Cleveland. On the west are the millstone grit and mountain limestone, the two coming together in lofty opposing eminences in many parts of Craven, where, along the line of what is called by geologists the 'Craven Fault,' the limestone rises into magnificent cliffs many hundreds of feet in height, and nearly 2000 above the level of the sea. The limestone is in many places very rich in lead-ore. On the east lie the Chalk Wolds, and the Oolitic and Lias formations, with the Kimmeridge Clay of the Vale of Pickering, and the accumulations of sand, gravel, and other sediments which make up Holderness. In the south-western district is a splendid coal-field, intermixed with ironstone, extending over 600 sq. miles. Valuable deposits of iron ore have also been discovered recently in Cleveland, in the north-eastern part of the county.

In the north-west, the lower parts of the North Riding, Craven, and the East Riding, the land mainly supplies occupation to the inhabitants. Craven is almost purely a grazing district, and so are most of the upper lands and dales in the county. Excellent corn is grown in the vales of York and

Cleveland, and the East Riding has many large and excellent farms. The horses of Y., both for the race-course and for use, are too well known to need eulogy. The manufactures of the county are immense. Leeds is the centre of the woollen, as Bradford is of the worsted trade. Sheffield is the principal seat of the cutlery manufacture; while the Cleveland district is rapidly rising into importance for mineral wealth and enterprise. The large iron-works of Low Moor, Bowling, and Rotherham, and the flax and linen manufactures of Leeds and Barnsley, merit a passing notice, with the blankets and cloths of the Huddersfield district, and the new llama and alpaca industry introduced at Saltaire near Bingley, by Mr Titus Salt. Harrogate, Ilkley, Aakern, and Croft are the principal inland health-resorts of the county; Scarborough, Fliley, Bridlington, and Whitby take the lead on the coast.

The public works of Y. rank with the finest in the kingdom. Among them are the Aire and Calder Navigation, 15 miles long; the Calder and Hebble Navigation; the navigation of the Don and Sheffield region, 40 miles; and the Huddersfield Canal, one of the most surprising engineering works in England. This canal is 20 miles in length, and rises between Huddersfield and Marsden by 42 locks to the height of 656 feet. At this elevation, the highest canal-level in the country, it passes by a tunnel more than three miles long under Standedge, a range of hills between Marsden and Saddleworth. The canal terminates near Dukinfield. Add to these the Leeds and Liverpool Canal—which cost 46 years of labour, and is 129 miles long—besides many smaller, but very costly undertakings, and some idea may be formed of the activity of Y. in this direction. Its railway communications are excellent, and grow in number and completeness every year. On these lines, in consequence of the mountainous districts through which many of them pass, are to be found some of the longest and most difficult tunnels, viaducts, bridges, embankments, and cuttings which have yet been attempted by engineers in England.

A very brief reference to the antiquities and natural curiosities of the county must suffice. Traces of great Roman roads are found in many places, as well as of Roman, Saxon, and Danish encampments. In the Wolds are many tumuli; and it is supposed by some that the singular and imposing mass of rocks called Brimham Crags, which overlook Niddersdale, about four miles from Pateley Bridge, was once a Druidical temple. The ruins of ancient abbeys and priories are numerous and beautiful. Few can rival the glories of Fountains and Rievaulx, and the scenery which encompasses Bolton Priory is delightful. Besides these, there are the ruins of Kirkstall, Roche, and Selby in the West Riding; St Mary's at York; Jervaux, Byland, and Whitby in the North Riding; and many others. Of castles, we may name in the West Riding, Conisborough Castle, near Doncaster, one of the oldest and most interesting ruins known to antiquaries; Knaresborough, Pontefract, and Skipton, the last still used as a residence; in the North Riding, Richmond, with its unrivalled Norman keep; Middleham Castle, where the king-maker, Warwick, lived, and where Edward IV. was immured; and Bolton Castle, the prison for a time of Mary Queen of Scots; in the East Riding, Wressle Castle, once the home of the Percies. Of old York Castle, nothing now remains but its massive Clifford's Tower.

The lover of the picturesque will find the Y. scenery full of charms. The rapid of Caldron Snout, on the Tees, 200 feet in descent; High Force, on the same river, a perpendicular fall of 69 feet over a cliff of greenstone marble; Aygarth

Force and Hardraw Force, on the Ure; the Strid, immortalised by Wordsworth, in Bolton Woods on Wharfe; the magnificent Gordale Scar and Malham Cove, each nearly 300 feet in height, on the upper waters of the Aire; and the uncounted glens and streams among its myriad hills, are sufficient to indicate the attractions of its river and mountain aspects. It would require a volume to do them justice.—See Allen's *History of the County of York*; Whitaker's *Histories of Richmondshire, Craven, and Leeds*; Hunter's *Hallamshire*; Gent's *York, Ripon, &c.*; Phillips's *Geology of Yorkshire, and Rivers, Mountains, and Sea-coasts of Yorkshire*.

YO-SEMITE. See SUPP., Vol. X.

YOU'GHAL, a seaport, parliamentary, and municipal borough of the barony of Innakilly, county of Cork, Munster, Ireland, situated in lat. 51° 57' N., long. 7° 52' W., on the estuary of the Blackwater, 157 miles south-west from Dublin. The pop., which, in 1851, was 7410, and in 1861, 6328, was, in 1871, 6081, of whom 5346 were Roman Catholics, 584 Protestant Episcopalians, and the rest of other denominations. The town has some structures of interest—the parish church, which is formed of the nave and aisles of the ancient collegiate church, built by the Earl of Desmond in 1464; the 'clock-gate;' and Sir Walter Raleigh's house, which remains nearly in its original state. There is a handsome Roman Catholic church, as also churches of the several other denominations; two convents; several schools; a fever hospital, a lying-in hospital, and several other benevolent institutions. The trade of Y. is considerable, but lies chiefly in the export of agricultural produce. The harbour, which is obstructed by a bar, does not admit vessels of more than 400 or 500 tons burden; the fisheries are extensive and valuable, and employ a considerable number of hands. There are several remains of buildings, civil, ecclesiastical, and military; and, according to the local tradition, the potato was first planted at Y. by Sir Walter Raleigh. Y. returns one member to the imperial parliament. The constituency in 1873 was 293. Its municipal affairs are managed by commissioners, 21 in number. The rateable value of property is £2637.

YOUNG, ARTHUR, an eminent writer on agriculture, was born September 7, 1741, and educated at Lavenham in Suffolk. In 1768, he was apprenticed by his father, a doctor of divinity and clergyman of the Church of England, to a mercantile house in Lynn. But Y. had no liking for business, and devoted much of his attention to literature. On his father's death, in 1769, he undertook the management of a small farm, of which his mother had a lease. Six years afterwards, he became a farmer on his own account in Essex. He seems, at the same time, to have acted as a parliamentary reporter; and as he only saw his farm from Saturday till Monday, it need not be wondered that he found it unprofitable. At the end of five years, he gave £100 to a practical farmer to take the lease off his hands. In the meantime, however, he had made notes of the results of numerous experiments on his farm, which he afterwards published, under the title of *A Course of Experimental Agriculture*. His first successful book was, *A Tour through the Southern Counties of England*, which was followed by other works describing the state of agriculture in various parts of England, and in Ireland. The enthusiasm of Y., and his lively style, made his writings popular, and by them the knowledge of many judicious practices, confined to one locality, was spread throughout the whole empire. In 1784, Y. began the publication of the *Annals of*

*Agriculture*, of which 45 vols. 8vo were published. Three years later, he was invited by Count de la Rochefoucauld to make a tour in the south of France. What he saw, induced him to undertake a series of tours in France, through a great part of which he travelled leisurely on horseback. The result was his most important work, *The Agricultural Survey of France*. The author did not confine his attention to agriculture, but described the social and political condition of the people in a lively and truthful manner, and his work has become, in consequence, the most reliable source of information regarding the state of France just before the Revolution. In 1801, the French Directory shewed the value attached to the writings of Y., by ordering the whole of his agricultural works to be translated into French. They were published at Paris, in 20 vols. 8vo, under the title of *Le Cultivateur Anglois*. In 1808, Y. received a gold medal from the English Board of Agriculture, 'for long and faithful services in agriculture.' He died April 12, 1820.

YOUNG, BRIGHAM, American Mormon leader, was born at Whittingham, Vermont, June 1, 1801, and was the son of a small farmer proprietor. In 1832, having become converted to Mormonism, he was made an elder of the Church of the Latter-day Saints, and began to preach at the Mormon settlement at Kirtland, Ohio. In 1835, he was appointed one of the twelve apostles of the Church, and sent as a missionary to the New England States, where he was very successful in making converts. After the Mormons had been driven from Kirtland to Missouri, and from the latter to Illinois, and the murder of Joseph Smith by a mob (1844), Y. was chosen President in his place. The year following, the charter of Nauvoo was repealed by the legislature of Illinois; and after a cannonade of three days, the Mormons were driven from their capital and temple, and led by President Y. to Utah, where they arrived, after a toilsome journey, July 24, 1847. Next year, the great body of Mormons arrived and founded Salt Lake City; and in 1850, President Fillmore appointed Brigham Y. governor of the territory for four years. In 1854, in consequence of the Mormons setting the Federal laws at defiance, by having in 1852 proclaimed polygamy as the 'celestial law of marriage,' Colonel Steptoe was appointed governor in Y.'s place; but on visiting Utah, he thought it an unsafe residence, and resigned. The Mormon President exercised supreme authority, and said: 'I am and will be governor, and no power can hinder it until the Lord Almighty says: "Brigham, you need not be governor any longer."' In 1857, a new governor, Cumming, was appointed, and sent with a force of 2500 United States troops to protect him and the Federal officers; but Y. forbade them to enter the territory, and cut off the supply-trains. A compromise was, however, effected, the Mormons pardoned, and the troops remained until 1860. The determination of the United States to abolish polygamy, and the appointment, in 1869, of a new U.S. governor, contributed somewhat to reduce Y.'s authority. In 1874 his fifteenth wife petitioned the U.S. courts for a divorce, and separated from him. Y. died August 29, 1877, leaving a fortune of two million dollars to 17 wives and 56 children. See MORMONS, SALT LAKE CITY, and UTAH.

YOUNG, EDWARD, the author of the well-known *Night Thoughts*, was born in the year 1684, at Upham, in Hampshire, of which parish his father was at that time rector. He was educated at Winchester School, and afterwards, in 1703, went to Oxford. In 1708, a law fellowship in All Souls

College was conferred on him by Archbishop Tenison. With law, however, he seems pretty much to have declined to meddle, occupying himself, by preference, with poetry and religious studies. In 1714, he obtained his degree of B.C.L.; and that of D.C.L. followed in 1719. Meantime, he had come before the world as a poet, by publishing, in 1713, an *Epistle to George, Lord Lansdowne*, on his being created a peer. For Y., who continued through life one of the most persevering and audacious toadies that ever flattered a patron, this was a characteristic beginning. In the same year, he also published two other poems of some length, entitled respectively *The Last Day*, and *The Force of Religion, or Vanquished Love*; the year following, he again flowed forth in *A Poem on the Death of Queen Anne*. These performances procured him some amount of immediate reputation. In 1719, he ventured on the more ambitious effort of a tragedy, which, under the title of *Busiris*, was brought out at Drury Lane. The piece had a fair success, through which means it probably was that he attracted the notice of the strange and eccentric Duke of Wharton, with whom, in the end of that year, he was induced to go for a short time abroad. The duke seems to have entertained for him a real kindness, and to have treated him with much liberality. At the duke's death, Y. set forth certain claims against his estates, which he succeeded in making good to the extent of an annuity of £200. The details of the case are perplexed, and need not here be entered into. They involve nothing dishonourable to Y., yet convey a somewhat unpleasing impression that the pious author of the *Night Thoughts*, in his extreme solicitude about the next world, contrived to keep a pretty sharp eye to his little pocket-interests in the present one. In 1721, was produced his tragedy, *The Revenge*, which, though unsuccessful at the time, has since had greater acceptance, and is the only one of his pieces still occasionally acted. His third and last attempt in this field, *The Brothers*, was produced in 1753. Between 1725 and 1728, appeared in succession his satires, under the title of *The Love of Fame, the Universal Passion*. These had a great success, and brought to their fortunate author money as well as fame. They abound with wit and vivacious observation, and even now will very well repay perusal. Of *The Instalment*, a poem, issued in 1726, and addressed to Sir Robert Walpole on his being made a Knight of the Garter, it seems enough to say, that inasmuch as we incidentally hear from Swift of a pension granted him, we may surmise that this was the service to the public by which he had contrived to earn it. In 1727, Y., having taken holy orders for the purpose, was appointed one of the royal chaplains; and in 1730, he became rector of Welwyn, in Hertfordshire. The year after, he married Lady Elizabeth Lee, daughter of the Earl of Lichfield, and widow of Colonel Lee. He is supposed to have been very happy with her, as he exhibited great grief on her death in 1741. It is believed that from his solemn meditations on the event, he got the suggestion of the *Night Thoughts*, begun shortly after, and published 1742—1746. By this work almost solely it is that he has continued to be remembered. His mind retained its activity to the last. He published various other works, now so entirely forgotten, that it would be waste of time to enumerate them; and in 1762, superintended a collected edition of his works, in 4 vols. 12mo, from which he had the grace to exclude certain of the most fulsome of his dedications, probably as having served their turn, and not likely to be of further use. His death took place on April 12, 1765. Since that time, his *Night Thoughts* has

passed through editions innumerable, and is more or less familiar to every reader. It displays much gloomy force of pious reflection; and has passages of fine imagination, frequently somewhat marred by an epigrammatic mannerism of expression. Certain of its sententious lines have passed into common use, and become in a manner proverbial. Though now somewhat declined from the estimation in which he was long held, Y. must continue, on the strength of it, to hold a distinct and even high place in that interval in our literature which divides the artificial and so-called classical school of Pope from the return to a simpler and more natural manner, heralded some time afterward by Cowper. If we except his one great weakness of character—an inordinate appetite for preferment and worldly honours, which sought its gratification in ways somewhat servile and unworthy—there seems every reason to believe that Y. was, on the whole, a very excellent and worthy man, and sincerely devout Christian.

YOUNG, THOMAS, M.D., one of the most ingenious and original philosophers of this century, and almost as eminent for his scholarship and his linguistic discoveries, as for his contributions to science, was born at Milverton, in Somersetshire, on the 13th of June 1773. His parents, Thomas and Sarah Young, were Quakers of the strictest sect; and Y. had the impression that the peculiar doctrines of the Quakers had a favourable influence upon his character and career. In particular, he connected with the Quaker doctrine of divine suggestion the perseverance with which he followed up any pursuit in which he engaged, to which he, like Buffon, was disposed to attribute all the discoveries which his genius enabled him to make. Wonderful stories of his youthful precocity have been recorded, and they seem to have more truth in them than such stories usually have. In 1780, he was sent to a boarding-school at Stapleton, near Bristol, where he remained two years; he was afterwards put to a school at Compton, in Dorsetshire, kept by a Mr Thompson, who appears to have been an able and judicious teacher. When he left Compton, in his 14th year, besides having a great knowledge, for his age, of Greek and Latin and of Mathematics, he had learned French and Italian, and, without any tuition, had made considerable progress in Hebrew, Persian, and Arabic. In 1787, he went to live with Mr David Barclay of Youngbury, near Ware, in Hertfordshire, an eminent member of the Society of Friends, partly as the fellow-pupil, partly as the tutor of that gentleman's grandson, Hudson Gurney. A Mr Hodgkin was called in to assist the studies of the two lads, but Y. soon proved to be superior in acquirements to his instructor, and virtually the three became fellow-students. Mr Hodgkin published in 1793 a work entitled *Calligraphia Græca*, which he dedicated to Young. Y. continued to live with Mr Barclay till 1792, spending the summer months in Hertfordshire, and the winter in London, studying Greek and Latin, the modern languages, the Oriental as well as the European, the higher mathematics, and natural philosophy, and, by way of amusement, botany and zoology. He taught himself to write Latin with fluency and elegance, and to write Greek verses, which received the commendation of some of the best judges of the time. During the winters of 1790 and 1791, he attended lectures on chemistry in London. It may be remarked, that neither then nor at any subsequent time did he shew much disposition towards experimenting; his bias seems to have been towards the pure rather than the observational sciences.

Towards the end of 1792, under the advice of Dr Brocklesby, an eminent London physician, his

mother's uncle, who had been greatly impressed by his abilities and attainments, he began to study medicine; and he attended medical lectures for two years in the schools of London, and afterwards for a year at the University of Edinburgh. After going to Edinburgh, Y. gave up the Quaker dress and the more inconvenient of the Quaker customs; he took lessons in music and dancing, mixed freely in society, and occasionally went to the theatre. These changes, though not intended to go further, eventually led to his complete estrangement from the Society of Friends. From Edinburgh he went to the German university of Göttingen, from which, after nine months' residence, he got the degree of Doctor of Medicine. He continued upwards of a year longer in Germany, and visited various medical schools, returning to England in February 1797. At that time, the membership of the College of Physicians was restricted to graduates of Oxford and Cambridge; and to qualify himself for it, Y., on his return, entered as a fellow-commoner at Emmanuel College, Cambridge, at which he remained until he took his degree in 1799. In the year 1800, having become a member of the College of Physicians, he took up his residence in London, and began to practise as a physician. He took the degree of M.B. at Cambridge in 1803, and that of M.D. in 1807. His uncle, Brocklesby, who died in 1797, had left him £10,000, besides his house in London, with his furniture, library, and collection of pictures, so that he was in possession of a moderate competency.

In 1801, he was appointed Professor of Natural Philosophy in the Royal Institution, then newly established, and he began to deliver lectures early in the following year. As a lecturer, he was not popular, his style being too condensed, and the matter of his lectures unsuited to the miscellaneous audiences of the Royal Institution. He published in 1802 a *Syllabus of a Course of Lectures on Natural and Experimental Philosophy*, in which, among other things, he first announced his great discovery of the law of the Interference of Light (see INTERFERENCE), which by itself, as Sir John Herschel has remarked, would have procured him a scientific immortality. It was this discovery which first fairly turned the balance of evidence in favour of the undulatory as against the molecular theory of light (see UNDULATORY THEORY OF LIGHT). It is Y.'s most important contribution to science. He had been elected a Fellow of the Royal Society as soon as he was 21; in 1802, he became its foreign secretary, a post which he retained till the end of his life. He resigned his professorship on his marriage, in 1804, fearing that his filling a chair of science might interfere with his success as a physician. The lectures which he delivered as professor were the foundation of the *Course of Lectures on Natural and Mechanical Philosophy* which he published in 1807—a great work, embodying a complete system of natural and mechanical philosophy, on which he was engaged for nearly five years. A new edition of these Lectures was published in 1845, edited by Professor Kelland of Edinburgh. Y.'s doctrine of Interference was at first unfavourably received by scientific men in England: it was attacked and ridiculed in the *Edinburgh Review*; and so little interest was taken in the subject, that of a pamphlet which Y. published in answer to the *Edinburgh Review*, only a single copy was sold. As has often happened, the first recognition of the importance and ingenuity of this and others of Y.'s speculations came from the scientific men of the continent.

Y. was admitted a Fellow of the College of Physicians in 1808, and was elected one of the physicians of St George's Hospital in 1810. He afterwards published several medical works, which, though

they were little more than compilations, and are now forgotten, shew that he was thoroughly versed in the history of diseases and of medical opinion. His hospital practice, too, is said to have been successful; but he had but little success in getting patients. He retired from practice—retaining, however, his connection with St George's Hospital—in 1818, on his appointment to be Secretary of the Board of Longitude. On the dissolution of the Board of Longitude, he became the sole conductor of the *Nautical Almanac*; and afterwards, when the system of life insurance began to be popular, he held, along with this post, the office of scientific adviser of a life insurance company. During the last years of his life, he was a member of a council appointed to advise the Admiralty in scientific matters.

Y.'s greatest achievement, after his great discovery of the law of Interference, was made in connection with the subject of Hieroglyphics (q. v.). He was the first to hit upon the process of investigation by means of which the received interpretation of hieroglyphics has been arrived at. His discovery, originally published in papers written for the Society of Literature, and afterwards in the *Encyclopædia Britannica*, was given to the world in a book in 1823. In his later years, much of his attention was given to this and cognate subjects. He was engaged on an Egyptian Dictionary at the time of his death. His miscellaneous writings, contributions to the Transactions of learned and scientific bodies, to Reviews, and to the *Encyclopædia Britannica*, were very numerous. Three volumes of them, two consisting of Scientific Papers, edited by Dean Peacock, the third of Hieroglyphical Essays and Correspondence, edited by John Leitch, were published in 1855.

He died, after several months of failing health, and a short period of severe illness, on the 10th May 1829. His character seems to have been singularly amiable, and to have endeared him to a multitude of friends, by one of whom, Dr Peacock, Dean of Ely, an ample biography of him was published in 1855. Y. was, two years before his death, elected a foreign Associate of the Academy of Sciences at Paris, succeeding to the illustrious Volta.

YPRES, or YPEREN, a town of Belgium, formerly fortified, in the province of West Flanders, is situated in a fertile plain on both sides of the Yperlee, about 29 miles south-south-west of Bruges (53 by railway). The marshes around the town at one time rendered it very unhealthy, but considerable improvement has been effected in this respect by drainage. Y. was at one time one of the most important manufacturing towns in Flanders, the number of inhabitants in the 14th c. being 200,000, and the number of looms 4000. Its staple manufacture consisted of the cloth called, according to some, after the name of the town, Diaper. The only remnant of its once flourishing manufacture is the Cloth-hall (*Les Halles*), standing in the great market-place, a building of prodigious size, in the form of a trapezium, in a rich style of Gothic architecture, and surmounted by a stately square tower or belfry, with a clock and chimies. It was begun in 1230, and continued till 1342; the east end, supported on pillars, being added in 1730. One of the wings is now used as the *hôtel-de-ville*, and other parts are occupied by different public establishments and concert-rooms. The cathedral of St Martin is a fine Gothic edifice, with an altar of Carrara marble, a richly carved pulpit, and a picture doubtfully attributed to Van Eyck. Other buildings are the churches of St Peter, St James, and St Nicolas, the old castle-ward, two colleges, several hospitals, barracks, numerous boarding and day



schools, &c. The chief modern manufactures are thread, lace, linens, woollens, cottons, silk, ribbons, leather, oil, soap, tobacco. There are many tanneries, oil-mills, salt-works, dye-works, breweries. The town is connected with the Yser by canal, and is a station on the West Flanders Railway. Pop. (1870) about 16,300.

Y. is a very old town, its origin dating from the 9th and 10th centuries. In 1688, it was strongly fortified by Louis XIV., and in the great European wars was frequently subject to sieges.

**YPSILANTI**, a Fanariot family, which falsely pretends to be descended from the imperial stock of the Comneni, has furnished various champions of the Christian population under Turkish rule. The first of these, **PRINCE CONSTANTINE Y.**, was born in 1760 at Constantinople, and for his translation of the works of Vauban, was raised to high official rank by Sultan Selim III., and was subsequently appointed hospodar of Moldavia in 1799, and of Walachia in 1802. His administration of the government of these provinces was marked by wisdom and energy; but his ill-concealed sympathies with Russia led (1806) to his dismissal and flight to Transylvania. Re-established in the government of Walachia by the Russians, he showed his hatred for the Porte by inciting (1807) the Servians to insurrection; but finding soon after that his allies, the Russians, had views and aims quite inconsistent with his, and unable to strive with both Russians and Turks, he took the oath of allegiance to the czar, and retired to Kiev, where he died 28th July 1816. He has left numerous works, composed in Italian, French, and Turkish.

His three sons, Alexander, Demetrius, and Nicolas, followed up the same course of policy. The eldest, **ALEXANDER**, born in 1783, served for some time in the Russian army, and was chosen by the 'Hetairists' as their chief in 1820. In promotion of the cause of Rouman independence, he collected a large sum by subscription in Russia, and afterwards invading Moldavia, succeeded in raising an insurrection in both principalities. But, little suited by natural gifts to guide the movement he had originated, he was attacked by the Turks near Galatz, totally defeated, and forced to take refuge in Austria, where he was arrested and imprisoned. Released after a time, but broken in spirit by ohagin and privations, he retired to Vienna, where he died 31st January 1828.—His younger brother, **DEMETRIUS**, who was born 25th December 1793, also commenced his career in the Russian army, and joined his brother in his schemes for emancipating from servitude the Christian population of Turkey. Sent to Greece, armed with powers from his brother, he took a glorious part in the capture of Tripolitza (October 1820), but was less successful in the following year in his attack on Eubosa. His gallant defence of Argos against the Turks, stopped the victorious march of the latter, and gained (1823) for him the honorary titles of President of Argos, Prince of the Peloponnesus, President of the Legislative Council, and Senator. His stubborn resistance (1825) to the victorious Ibrahim at Napoli was another valuable service to Greece. In 1827, the grateful Hellenes made him commander-in-chief of their forces; but some difference arising between him and the President, Capo d'Istria, he resigned his post in January 1830. He died at Napoli di Romania, 16th August 1832. Y. was insignificant in appearance, but had the soul of a hero; and was as deaf to the allurements of pleasure as to the promptings of ambition.

**Y'SSEL** or **IJSSEL**, a river of the Netherlands, formed by the junction at Doesburg, in Gueldres, of

the Oude (*Old*) Yssel from Westphalia and the New Yssel, an offset of the Rhine, cut by Drusus. After this it flows north and latterly north-west past Zutphen and Deventer, forming part of the boundary between Gueldres and Oberyssel, and, passing Kampen, falls into the Zuider Zee, after a course of about 80 miles, forming at its mouth a delta, which is gradually increasing. The principal affluents are the Borket, the Schipbeek, and the Griff.—There is another river of the same name, a branch of the Rhine, in the province of Utrecht.

**Y'STAD**, a seaport town in the extreme south of Sweden, on the Baltic, in the laen of Malmöhus, and about 30 miles south-east of Malmö. The town is well built, and has a handsome market-place, two churches, a town-house, barracks, &c. There is a good harbour, and a brisk and improving trade is carried on, steamers plying to Stockholm, Lübeck, Kalmar, Stettin, Stralsund, and Copenhagen putting in here. It has manufactures of tobacco and snuff, chicory, soap, woollen cloths, and leather; there is also some shipbuilding. Pop. about 6000.

**Y'TTRIUM** is a very rare metal, whose oxide is the earth *Ytria*, which is found in the Scandinavian mineral *Gadenolite* (a silicate of yttria, glucina, and an oxide of cerium and iron), in *Ytrotantalite*, and in one or two other very scarce minerals. Neither the metal, the oxide, nor the salts of the oxide are of any practical importance. According to Mosander, three bases have been confounded under the single name of yttria; to the most abundant of these he gives the name *yttria*, while he distinguishes the others as *erbia* and *terbia*.

**YUCATA'N**. See MEXICO.

**YU'CCA**, a genus of plants of the natural order *Liliaceae*, natives of North and South America, and some of which are often cultivated in gardens on account of the singularity and splendour of their appearance. *Y. gloriosa* is a native of Virginia and of more southern parts of North America, but quite hardy in England. It has a stem about two or three feet high, the upper part of which produces a great tuft or crown of large sword-shaped evergreen leaves, each terminating in a sharp black spine. From the centre of this crown of leaves arises the flower-stalk, of three feet or upwards in height, branching out on every side so as to form a great panicle. The flowers are bell-shaped and drooping, white with a purple stripe on the outside of each segment of the perianth. The fibres of the leaves are used by the American Indians to make a sort of cloth and cordage.—The other species have a general resemblance to this in habit and appearance. The fibre of the *Yuccas* is similar to that of the *Agaves* and *Bromelias*, and probably is often included under the name *Pita Flax* or *Pita Fibre*.

**YUDHISHT'HIRA**. See PÂN'D'AVAS.



*Yucca gloriosa.*

YUGA (from the Sanscrit *yug*, join; kindred to the Lat. *jung*, the Gr. *zeug*-, Gothic, *juk*; hence, literally, junction) denotes, in Hindu mythology and astronomy, a long mundane period of years, which is preceded by a period called *Sandhyā*, 'twilight,' and followed by a similar period called *Sandhyātm'sā*, 'portion of twilight.' Manu, the Mahābhārata, and the Purānas name four such periods, three of which have already elapsed—viz., the *Kṛitā*, *Tretā*, and *Dvāpara-Yuga*; while the fourth, or *Kali-Yuga*, is that in which we live. The *Kṛitā-Yuga*, according to these works, consists of 4000 divine years, its *Sandhyā* of 400, and its *Sandhyātm'sā* likewise of 400 divine years. The *Tretā-Yuga* consists of 3000, and its *Sandhyā* and *Sandhyātm'sā* of 300 divine years each; the *Dvāpara-Yuga* of 2000 divine years, with 200 such years to its *Sandhyā*, and 200 to its *Sandhyātm'sā*; and the *Kali-Yuga* of 1000 divine years, with 100 such years to its *Sandhyā*, and 100 to its *Sandhyātm'sā*. And since a divine year comprises 360 solar years of mortals, a year of men being a day of the gods, these Yugas, with their *Sandhyās* and *Sandhyātm'sās*, would severally represent 1,728,000, 1,296,000, 864,000, and 432,000, or in the aggregate, 4,320,000 solar years of mortals—a period called *Mahāyuga*, or 'a great Yuga;' 4,320,000,000 years being a day and night of Brahmā. See *KALPA*. The notion on which the theory of these Yugas and their *Sandhyās* and *Sandhyātm'sās* is based, as may be easily inferred from the foregoing statement, is that of a descending progression, 4, 3, 2, 1, each of these units multiplied by 1000, and in the case of the periods preceding and following the Yuga, by 100 years. The deteriorating process thus indicated in the succession of these Yugas, is also supposed to characterise the relative physical and moral worth of these mundane ages. 'In the *Kṛitā-Yuga*,' Manu says, 'men are free from disease, attain all the objects of their desires, and live 400 years; but in the *Tretā* and the succeeding Yugas, their life is lessened gradually by one quarter.' . . . 'In the *Kṛitā-Yuga*, devotion is declared to be the highest object of men; in the *Tretā*, spiritual knowledge; in the *Dvāpara*, sacrifice; in the *Kali*, liberality alone.' See also for other passages the article *KALIYUGA*. The present or *Kaliyuga* of the world commenced in the year 3101 B.C., when in the year 1867, therefore, 4968 years of the *Kaliyuga* would have expired.—The term *Yuga* is sometimes also applied to other divisions of time. The *Vishṇu-Purāna*, for instance, mentions, besides the Yugas above named, a *Yuga* which consists of a cycle of five years, called *Samvatsara*, *Parivatsara*, *Idvatsara*, *Anuvatsara*, and *Vatsara* (see Wilson's translation of this *Purāna*, 2d ed., by Fitzedward Hall, vol. i. p. 49, ff.; vol. ii. p. 254, ff.); and a *Yuga*, or cycle of five years, is, as Colebrooke states (*Miscellaneous Essays*, vol. i. p. 106, ff.), likewise the cycle described in the astronomical treatises connected with the Vedas. The use of the term *Yuga*, however, in such a special sense is not frequent, whereas its application to the four mundane ages is that which generally prevails in the classical and mediæval Sanscrit literature.—For other works, besides those already referred to, which afford information on these and other divisions of Hindu time, see *Kala Sankalita*, a *Collection of Memoirs on the various Modes according to which the Nations of the Southern Parts of India divide Time*, &c., by

John Warren (Madras, 1825); and *Carnatic Chronology, the Hindu and Mohammedan Methods of reckoning Time explained*, &c., by Charles Philip Brown (Lond. 1863).

YULE, the old name (still in provincial popular use) for Christmas. It points to heathen times, and to the annual festival held by the northern nations at the winter solstice as a part of their system of sun or nature worship. In the Edda, the sun is styled *fagrahel* (fair or shining wheel); and a remnant of his worship, under the image of a fire-wheel, survived in Europe as late as 1823. The inhabitants of the village of Konz, on the Moselle, were in the habit, on St John's Eve, of taking a great wheel wrapped in straw to the top of a neighbouring eminence, and making it roll down the hill, flaming all the way: if it reached the Moselle before being extinct, a good vintage was anticipated. A similar usage existed at Trier (see Grimm, *Deutsche Mythologie*, p. 586). The old Norse *hvel*, A.-S. *hveol*, have developed into Icel. *hiol*, Swed. and Dan. *hjul*, Eng. *wheel*; but from the same root would seem to have sprung old Norse *jól*, Swed. and Dan. *jul*, A.-S. *geol*, Eng. *Yule*,\* applied as the name of the winter solstice, either in reference to the conception of the sun himself as a wheel, or, more probably, to his wheeling or turning back at that time in his path in the heavens. Goth. *hveila*, Eng. *while*, denote time as wheeling or revolving. The general nature of the festival, and the way in which the observances were overlaid, or transformed and masked by the Christian institution, are noticed under the head of *CHRISTMAS*. In the greenery with which we still deck our houses and temples of worship, and in the Christmas trees laden with gifts, we perhaps see a relic of the symbols by which our heathen forefathers signified their faith in the power of the returning sun to clothe the earth again with green, and hang new fruit on the trees; and the furnety still or lately eaten on Christmas eve or morning in many parts of England (in Scotland, the preparation of oatmeal called *sovans*, is used), seems to be a lingering memory of the offerings paid to Hulda or Berchta (q. v.), the divine mother, the northern Ceres, or personification of fruitfulness, to whom they looked for new stores of grain. The burning of the *Yule-log* (or *Yule-clog*) testifies to the use of fire in the worship of the sun (see *ΒΕΛΤΗΝ*).

YVETOT, an old town of France, in the dep. of Seine-Inférieure, is situated on an elevated and fertile plain, 32 miles north-east from Havre, and 23 north-west from Rouen by railway. The houses are mostly of wood, roofed with slates, the principal street being upwards of two miles long; there is a well-planted promenade, but the town contains few objects of interest. There are manufactures of linen, cotton, calico, and velvet, and a considerable trade in cattle and agricultural produce. Pop. (1872) 7904. The Lord of Y. is styled 'Roi d'Yvetot' in old chronicles, and antiquaries have been much puzzled to account for the origin of the title. There is a tradition that Clotaire, son of Clovis, having slain one Gauthier, Lord of Y., before the high altar of Soissons, endeavoured to make atonement for the sacrilegious deed by conferring the title of king on the heirs of Gauthier.

\* In one of the Frisian dialects, *jule* or *jole* is used to signify a wheel.

# Z



THE last letter of the English and other West European alphabets, had no place in the original Latin alphabet, but was adopted in the time of Cicero from the Greek along with *y* (*z*), and thus stood last. In Greek, it had the sixth place, and had the power of a double consonant, being equivalent to *ds* or *sd*; in Latin, its use was confined to words of Greek origin. In High-Ger., in which it is pronounced like *ts*, it corresponds to *t* in the Low-Germanic and the Scandinavian tongues, e. g., *zeit* = Eng. *tide* (time). In Ital. *z* or *zz* mostly takes the place of the Lat. *ti*, as in *negozio* = *negotium*, *palazzo* = *palatium*, and is pronounced *ts*, or, preceded by *n*, *ds*. In Eng. and in Fr., it represents the flat sibilant sound of which *s* is the sharp. But in Eng., as in the vast majority of cases *s* has always been employed to represent the flat sibilant sound as well as the sharp (e. g., in almost all plurals, as *bones*, *cards*, in words like *revise*, &c.), there is a tendency to drop the use of *z*, except in a few individual words, such as *size*, *prize*. Many maintain the use of *z* in words derived from the Greek, especially from verbs in *izo*, as *baptize*, and also in words formed on the analogy of these, as *legalize*; but even the advocates of this rule do not act on it consistently, and the mere English scholar is fairly puzzled. This is one of the points of English orthography most urgently calling for reform.

**ZAANDA'M**, or **SAARDAM**, a town in N. Holland, is situated on both banks of the Zaan, at its entrance into the Ij (a deep and narrow bay of the Zuider Zee), now converted into land intersected by canals, bearing rich crops. *Z.* lies 5 miles north-west of Amsterdam on the other side of the bay. In former times, shipbuilding was largely carried on, but has nearly ceased. The whale-fishing, which, in 1701, employed 35 ships, has been abandoned. There is still a considerable shipping-trade. The principal industries are sawing wood, preparing vegetable oil—chiefly from colza—manufacturing paper, grinding grain, mustard, dye-stuffs, snuff, &c., making starch, rope-spinning, and iron-founding. At a distance, the town looks like a forest of windmills. *Z.* is a pleasant place, and many of the inhabitants are reputed to be wealthy. In 1697, Peter the Great worked in one of the ship-building yards as a carpenter, and the house in which he lived is carefully preserved. It was visited in 1814 by the Emperor Alexander of Russia, and is now enclosed with another building, to prevent exposure to the weather. There are two Dutch Reformed churches, one Lutheran, two Baptist, and two Roman Catholic churches, a Jewish synagogue, and several institutions for orphans and old people. Two public schools, a school of design, and two poor schools are maintained by the town. Pop. (1873) 12,026; (1875) 12,346.

**ZABERN** (the Roman *Zaberna*, tavern) is the name of three German towns on the west side of the Upper Rhine, one of which was French till 1870.

The first two are in the Palatinate (Rhenish Bavaria)—viz., Berg-Zabern, a town of about 3000 inhabitants, on the Erlenbach, occupied chiefly by agriculture and some small manufactures; and Rhein-Zabern, about four miles further east, on the same stream, with little more than 2000 inhabitants, noted for the two battles fought there and at the village of Jokgrin, about two miles further south, between the Austrians and the French, 29th June and 20th August 1793.

The other, which, to distinguish it from these, is called Alsace-Zabern (French *Saverne*), till the war of 1870 in the French dep. Bas Rhin, is now capital of a circle in the German imperial territory Alsace-Lorraine. It is situated on the Zorn, which flows into the Rhine, on the Paris and Strasburg Railway and highway, and also on the Marne and Rhine Canal. The town contains a palace and college, and had (1871) 5895 inhabitants, employed in making cloth, pottery, leather, and hardware, and in the transport of wood from the Vosges Mountains. It belonged in the 12th c. to the bishops of Metz, and afterwards to those of Strasbourg. There are still some Roman antiquities in the college. In 1696, the fortifications were razed. The stately palace was rebuilt by Cardinal Louis de Rohan, famous in the story of the Diamond Necklace (q. v.); it served in 1817 and 1818 as barracks for the Austrian army of occupation; in 1852 it became a home for the widows and daughters of the members of the Legion of Honour; and now it is again a barrack. The surrounding scenery is rich in ruins and picturesque effects. A spiral walk, called the Zabern Path, about nine miles long, leads, with many windings and 17 covered bridges, to the top of the Vosges, from which the spectator looks down on Alsace as a garden. The Pass of Zabern, or Saverne, which divides the Upper and Lower Vosges, is only 1325 feet high. The railway, the canal, the Zorn, and highway, all run side by side along the charming valley; and there is a constant succession of bridges, embankments, viaducts, and tunnels throughout the 45 minutes' journey from *Z.* to Saarbourg.

**ZA'BISM**. In the article on **SABÆANS** (q. v.), we spoke chiefly of certain inhabitants of Arabia Felix, the 'Sabaioi' of the Greeks, or 'Sabæi' of the Romans. It appears that this name was, in the 4th c. A. D., superseded by that of Himyarites, and belonged to many tribes, that derived their descent from one Sabâ ('a descendant of Eber, or descendant of Noah'), who also was called Abd Shemesh—Servant of the Sun. These Sabæans, who considered themselves pure autochthons, in contradistinction to the immigrated tribes, have often been confounded with a number of other peoples of antiquity, and with professors of many forms of religious belief and speculation; in fact, the confusion that has sprung out of the unwieldy mass of information found respecting these many varieties, and which has been hopelessly mixed up by many generations of orientalist and theologians, is almost without parallel. We shall not here survey the manifold systems and theories that have been evolved from

time to time, and handed down carefully, but we shall rather—in the main following Dr Chwolson—enumerate the principal stages of Z. as it appears, considered as a religious phase of mankind. We must premise that we exclude at once those imaginary Zabians who were taken by the mediæval Arabic, Jewish, and Persian writers to be identical with heathen or star worshippers, as well as those who, like the ancient Chaldeans, the ante-Zoroastrian Persians, the Buddhists, &c., were vaguely called by that name by Mohammedan and other writers of the 12th c. These writers all start from the notion that idolatry, star-worship, and Sabesism were identical, and they called nearly all those who were neither Jews or Christians, nor Mohammedans or Magians, heathens or Sabseans. Z. had then become, like Hellenism, from being a *nomen gentile*, an appellative. Confining ourselves to historical Z., we have to distinguish (1) the Chaldean Zabians of the Koran. These are the 'Parsified' Chaldee heathens or non-Christian Gnostics—the ancestors of the present Mandaites, or so-called Joannes Christians, who live not far from the Persian Gulf, and speak a corrupt kind of Chaldee-Aramaic; and (2) the Pseudo-Zabians, or Syrian Zabians (in Harran, Edessa, Rakkah, Bagdad), or, since 830—831 A.D., remnants of the ancient Syrian but Hellenised heathens. These disappear (as Zabians) since the 12th c., but perhaps still exist, under some other name, in Mesopotamia. It is those Pseudo-Zabians who spoke the most refined Syro-Aramaean dialect. They form the chief representatives of Z. emphatically deserving of the name. The first named, or Chaldean (Babylonian) Zabians, who transferred that name to the Harranic Zabians, and were of great influence upon the development of these latter's peculiar speculations, are the people meant under that designation by the Koran, and by the Mohammedans of this day. They are, as we said, also known as Christians of St John, or Mandaites. Among the Nabathean heathens of the north-east of Arabia and the extreme south of Mesopotamia, near Wasith and Bassara, there arose, in the last decennium of the 1st c. A.D. a man named Elxai (Elchasai = Scythianus), born in the north-east of Parthia (probably an adherent of Zoroastrianism, perhaps also acquainted with Buddhism), and spread among them Parsee ideas and Parsee religious rites and customs. They called themselves Mandaites—i. e., Gnostics. Many of their religious legends and tales they adopted at a later period from their Jewish and Mohammedan neighbours—chiefly, it is presumed, with a view of making themselves less hated by the ruling Mohammedan powers. They received the name of Saabiin from their constant washings, and purifications and baptisms. Their Arabic neighbours occasionally translated this word into the Arabic *Al-Mogtasilah*, 'those who wash themselves.' About a hundred years after the foundation of this sect by Elchasai, Manes was born of Mandaites parents, and was brought up among the Mandaites. He remained faithful to this creed up to his 24th year, at which period he founded the new sect of Manicheans (q. v.), which did not at first depart so considerably from Mandaitism as it did at a later period (see MANICHEANS). To these aboriginal Zabians there succeeded, in 830 A.D., a totally different kind of sect under the same name—viz., the Harranian Syrians. They themselves derived their denomination from one Zabl, who is variously called a son of Seth, son of Adam, or a son of Enoch or Idris, or a son of Methuselah, or of some fictitious Badi or Mari, a supposed companion of Abraham; while the Mohammedan writers, who, like the Greeks, endeavour to derive everything from their native tongue, either declare it to be

derived from *saaba*, 'to turn, to move,' because they turned to the paths of untruth, instead of that of the true religion—i. e., Islam; or, as the Zabians themselves sometimes explain it, 'because they have turned to the proper faith.' Another Arabic derivation makes them take their name, still more absurdly, from a root *saabas* = to fall away from the proper religion, or to turn one's head heavenwards—i. e., for the purpose of worshipping the angels and the stars, &c. European scholars have for the most part followed either Brooke or Scaliger, who variously hold the name to have sprung either from an Arabic root, which would point to their having come from the 'east,' or, again, from the Hebrew word for 'Host,' viz., of heaven, which they were supposed to worship. The real state of the case, however, is that, whatever the derivation of the name, it did not originally belong to the Harranians, as we have stated already, but was assumed by them, for the purpose of evading the Mohammedan persecutions, from the people mentioned in the Koran.

But it is by no means easy to say who these so-disguised Harranians really were, and what, since it was neither Judaism, nor Christianity, nor Mohammedanism, nor Magism, their religion really consisted of. Former investigators mostly took them to have been a distinct race and people, and their religion to have been composed of Chaldaism, Parsism, Judaism, Christianity, Neo-Platonism, Gnosticism, and Cabbalistic speculations. This, however, is far from being the fact. Broadly speaking, they might perhaps best be described as Syrians, who, partly descended from Greek colonists, had been subject so long to Syrian influences that they became in a manner Syrianised. Their religion was heathenism, the old heathenism of their Syrian fathers, which had, with incredible obstinacy, resisted not only Christianity, but rendered even Mohammedan ill-will harmless by stratagem. There can, however, be no doubt about certain foreign non-pagan elements having crept into it during the early Christian centuries. Eclecticism prevailed at that period, and it was not only Greeks and Romans that found the influence of foreign, chiefly eastern, metaphysical speculation irresistible. But apart from that peculiar syncretism, we find many other new additions to Harran idolatry in the shape of Zabism. There are, first of all, a certain number of legends about biblical personages from whom they pretend to be descendants—legends which, it may be presumed, they only, for the nonce, permitted to belong to their sacred traditions. There are further a number of laws of purity and impurity, and of sacrifices, which strongly remind of Judaism. Again, names of Greek and Roman gods, such as Helios, Ares, and Kronos, occur, a circumstance that perhaps may be explained from the prevailing tendency of the period of exchanging the names of native divinities for Greek and Roman names. Besides these foreign elements, there are certain metaphysical and physical views incorporated in their creed which are distinctly traceable to Aristotle, and finally, the theurgico-Neo-Platonic religious philosophy of heathenism, such as it is found in Porphyry, Proclus, Iamblichus, and the rest. All these apparently incongruous elements, however, infused into it by the circumstances of the period, do not prevent Z. from being in reality heathenism. Were further proof needed, we should find it in the words of a celebrated Zabian, Thabit ben Korra, quoted by Barhebræus, in the shape of a panegyric on the town of Harran and its heathenism, uttered, as Barhebræus says, in his 'purblind obstinacy.' After speaking of Christianity—not to its advantage—for some time, Thabit rejoices over the

## ZABISM.

blessings that still belong to his native place, Harran, through its having kept itself utterly unshaken by that faith. 'We,' he continues (the Zabians or Harranians), 'are the heirs and progenitors of heathenism, which has once been gloriously spread over this globe. Blessed is he who bears his burden for heathenism's sake, with firm hopes. Who has civilised the world and built its cities, but the nobles and the kings of heathenism? Who has constructed the harbours and has made the rivers navigable? Who has taught the hidden science? To whom else has the deity revealed itself, given oracles, and told the things of the future, but to the most celebrated men among the heathen? . . . Heathens have done all these things. They have brought to light the healing of souls; they have taught their salvation; they have also made manifest the art of healing the body; they have filled the world with institutions of government and with wisdom, which is the highest good. Without heathenism, the world would be empty and poverty-stricken, and swallowed up by great misery.'

Without entering into a detailed account of the many sources whence our information is derived with regard to the creed itself, we shall briefly indicate that they are written in Arabic, in Hebrew, and in Greek. The former are the most copious; those in Hebrew are chiefly represented by Maimonides; and the Greek are ascribed to various pseudonymous writers, among whom figure Aristotle and Hermes Trismegistus. From their various, and, to a great extent, contradictory statements, we owe the following indications regarding the principal points of this creed. The Creator, it teaches, is in his essence, primitivity, originality, eternity, One; but in his many manifestations in bodily figures, manifold. He is chiefly personified by the seven leading planets, and by the good, knowing, excellent, earthly bodies. But his unity is not thereby disturbed. It is, the Zabians say, 'as if the seven planets were his seven limbs, and as if our seven limbs were his seven spheres, in which he manifests himself, so that he speaks with our tongue, sees with our eyes, hears with our ears, touches with our hands, comes and goes with our feet, and acts through our members.' Nothing, we are told, is more foreign to Z. than—what holds good of the creed of the Sabæans only—rude star-worship. Z., according to the authority of Sharastani, expresses the idea that God is too great and too sublime to occupy himself directly with the affairs of this world; that he therefore has handed over the ruling of it to the gods, and that he himself only takes the most important things under his special care; that, further, man is too weak to address himself directly to the Highest, that he therefore is obliged to direct prayers and sacrifices to the intermediate deities to whom the rule of this world is intrusted. Thus the veneration shewn to planets, and even the worshipping of idols, is nothing but a symbolical act, the consequence of that original idea. There are many gods and goddesses in Z. of this intermediate stamp. It is not the planets themselves, but the spirits that direct and guide them and deliver them which are taken as deities of this kind—deities that stand to the spheres in the relation of soul to body. Apart from these, there are those gods who cause or represent every action in this world. Every universal natural deed or effect emanates from a universal deity, every partial one from a partial deity that presides over part of nature. Everything that appears in the air, which is formed near the sky or arises from the earth, always is the product of certain gods, that preside over these manifestations, in such a manner that the rain in general, as well as every special

drop of it, has a presiding numen. These spirits also mould and shape everything bodily from one form into the other, and gradually bring all created things to the state of their highest possible perfection, and communicate their powers to all substances, beings, and things. By the movement and guidance of these spiritual beings, the different elements and natural compositions are influenced in such a way that the tenderest plant may pierce the hardest cliff. He who guides this world is called the first spirit. These gods know our most secret thoughts, and all our future is open to them. The female deities seem to have been conceived as the feeling or passive principle. These gods or intelligences emanate directly from God without his will, as rays do from the sun. They are, further, of abstract forms, free of all matter, and neither made of any substance nor material. They consist chiefly of a light in which there is no darkness, which the senses cannot conceive, by reason of its immense clearness, which the understanding cannot comprehend, by reason of its extreme delicacy, and which fancy and imagination cannot fathom. Their nature is free from all animal desires, and they themselves are created for love and harmony, and for friendship and unity. They are not subject to local or temporal changes, and they rule the heavenly bodies, without finding the motion of the most heavy too heavy, or that of the lightest too light. Their existence is full of the highest bliss, through their being near to the Most High, whom day and night they praise, without ever feeling fatigue or lassitude, to whom they are never disobedient, but whose will they always fulfil with supreme delight. They have a free choice, and always incline to the good. 'These spiritual beings, our lords and gods, are our intermediators and advocates with the Lord of lords and God of gods.' All substances and types of the bodily world emanate from the spiritual world, which is the one from which everything flows, and to which everything returns, and which is full of light, sublime and pure. These two worlds correspond to each other, and are to each other like light and shadow. The way to approach these gods, and, through them, the highest essence, is by purifying our souls from all passions, by keeping a strict guard over our words and deeds, by fasting, heartfelt prayer, invocations, sacrifices, fumigations, and incantations. By steadfastly persevering in these and similar acts of devotion, man may reach so high a step of perfection that he may communicate even directly with the Supreme Power. The planets, as the principal representative and intermediate gods, are to be carefully observed, especially as regards—1, the houses and stations of the planets; 2, their rising and setting; 3, their respective conjunctions and oppositions; 4, the knowledge of the special times and seasons, the hours and days of the ruling of special planets; 5, the division of the different figures, forms, climates, and countries, according to their dominant stars—the prevailing notion of the Zabians being, like that of the Chaldees and the sect of the so-called Mathematicians (according to Sextus Empiricus), as well as of the Neo-Platonists in general, that everything below heaven was subject, in a manner, to the influence of stars, or the spirits that inhabit and rule them. Every substance and every action, every country and every hour, has its special planetary deity. It is therefore well to study carefully the special conjunctions and figures, as well as the special mixtures of incense, which might cause the individual numen to be propitious. Thus, e. g., according to the Zabian belief, the first hour of Saturday stands under Saturnus, and it is therefore right and advisable to select at that time such

prayers, seals, amulets, dresses, and fumigations as might be supposed to be particularly pleasing to that planetary god.

In order to address themselves to *visible* mediators, some of the Zabians are supposed to have directed their devotions to the stars themselves. But they soon found how futile a worship it was that addressed itself to things that appeared and disappeared in turn. They therefore manufactured permanent representatives of them in the shape of idols—idols wrought in as complete accordance as possible with the theurgical rules derived from the nature of the deity to be represented. They were of gold, to represent the sun; of silver, to indicate the moon. The very temples in which they were placed were of as many corners as were supposed to correspond to the form of certain stars.

We know but little with regard to the cosmogonical notions of the Zabians. Sharastani, one of our principal authorities, only quotes 'Agathodæmon' as his authority for their assuming five primeval principles, viz.: the Creator, Reason, the Soul, Space, the Vacuum. Out of these, all things are composed. According to another source (Kathibi), however, the Zabians assumed two living and active principles—viz., God and the Soul; further, a passive one, Matter; finally, two which are neither living nor passive—viz., Time and Space. Matter seems to have been held by them to be primeval and everlasting, and to it alone the existence of evil is attributable. God created the spheres only, and the heavenly bodies therein. It is these spheres (fathers) which carry the types or ideas to the elementary substances (mothers), and out of the combination, conjunction, and motion of these spheres and elements, the varying earthly things (children) are produced. Matter is, as we said, because of its defective nature, the source of evil, of ignorance, of folly; whilst the form is the source and fountainhead of the good, the right, the knowledge, and the understanding. Z. further assumes a renewal of this world after each great 'world-year'—a space of 36,425 ordinary years. At the end of these periods, the plants, the animals, and the men that had existed within it, cease to propagate themselves, and a generation of each of them, different from all previous ones, springs into life. How far this theory is identical with the Babylonian, Egyptian, and Indian theories on the same subject, we cannot here investigate; suffice it to call attention to the striking likeness apparent in them all.

Man, the Zabians teach, is composed of contradictory elements, which make him the vaocillating, struggling creature he is. Passions and desires rule him, and lower him to the level of brute creation, and he would utterly lose himself, were it not for such religious rites as purifications, sacrifices, and other means of grace, by which he may be enabled to approach the great gods once more, and to attempt to become like unto them. There are different kinds of souls; or rather man's soul partakes partly of the nature of the animal soul and partly of that of the angelic soul. The soul never dies, and punishments and rewards will affect only it, but not everlastingly. But rewards and punishments will not be wrought in any other future world, but in this, only at different epochs of existence. Thus, all our present joys are rewards for good deeds done by us in former epochs; and the sorrows and griefs we endure, spring in the same manner from evil actions we committed at former stages. As to the nature of the general (world-) soul itself, they say that it is primitive, for if it were not so, it would be material, as every newly-created being partakes of the material nature. Yet a material soul would be an impossibility. 'The soul, which is thus an immaterial

thing,' says Kathibi, 'and exists from eternity, is the involuntary reason of the first types, as God is the first cause of the intelligences. The soul once beheld matter, and loved it. Glowing with the desire of assuming a bodily shape, it would not again separate itself from that matter of which means the world was created. Since that time, the soul forgot itself, its everlasting existence, its original abode, and knew nothing more of what it had known before. But God, who turns all things to the best, united it to matter, which it loved, and out of this union the heavens, the elements, and other composite things arose. In order that the soul might not wholly periah within matter, he endowed it with intelligence, whereby it conceived its high origin, the spiritual world, and itself. It further conceived through it that it was but a stranger in this world, that it was subject to many sufferings in it, and that even the joys of this world are but the sources of new sufferings. As soon as the soul had perceived all this, it began to yearn again for its spiritual home, as a man who is away from his birthplace pines for his homestead. It then also learned that, in order to return to its primitive state, it had to free itself from the fetters of sensuous desires, and from all materialistic tendencies. Free from them all, it would regain its heavenly sphere again, and enjoy the bliss of the spiritual world.'

From all this, it will be seen, as we stated at the outset—that the Zabians, about whom so much has been theorised and fabled, were simply heathens who had to a certain extent adopted and modified Neo-Platonic ideas, such as floated in the mental atmosphere of the early Christian centuries. It would be needless to enter into a discussion about the semi-fabulous personages to whom they ascribe the foundation of their creed, such as Agathodæmon, Arani, Hermes, and the rest; or some of those mentioned by other writers, such as Zerdusht, Nawassib, Orpheus, and the rest.

The life of this sect was but short. After having first been on terms of great friendship with the ruling powers of Mohammedanism as well as with Christians and Jews, and having filled many of the highest and most responsible posts at the courts of the kalifs, they were by degrees made the butt of fanaticism and rapacity. Muled, persecuted, banished at different periods, they disappear from history since the middle of the 11th century. Some obscure remnants of them seem to have survived in remote corners of Mesopotamia, but they, too, no longer adhere to the original creed, but are mixed up with the Mendaites, mentioned above, and the Shemsijeh, or sun-worshippers. Thus obscurely ended a sect which, for 200 years, had produced a host of men pre-eminent in every branch of learning and literature, in philosophy, astronomy, history, natural history, poetry, medicine, and the rest. Many of these men, whose name and fame reached Europe, were confounded with their Mohammedan contemporaries, chiefly because they lived in Bagdad, at that time the centre of learning, the seat of the kalifs and the high dignitaries of state. The Mohammedans, however, had so high an appreciation of Zabian learning, that it became proverbial amongst them, and they could explain it only by tracing it to a supernatural source, notably to Hermes (Trismegistus), the father of the Zabi, mentioned above.

We have in our sketch mainly followed Chwolson, who, aided by profound learning and acumen, has been the first to clear up the nature of Z., this terrible stumbling-block of many generations of investigators.—For detailed information on it and all the many other points connected with it, we

must refer our readers to the large work in which he has embodied the results of his investigations, *Die Scabier und der Scabismus* (2 vols. St Petersburg, 1856). See also NEO-PLATONISM, Gnostics.

**ZACATECAS**, capital of the Mexican state of that name, is situated in the windings of a deep valley or ravine, between high hills, about 320 miles north-west of Mexico. It is built over a vein of silver, which has been deeply explored. The streets are narrow and crooked, but it has a fine appearance from a distance, owing to the size and massiveness of its churches, and the elegance of some of its residences. There are also a college, a gunpowder mill, and a mint. Pop. 30,000.

**ZACHARIAS**, a Roman pontiff, successor of Gregory III in 741, who is noticeable as one of the series of Greek prelates by whom the destinies of Rome and Italy were much influenced in the 7th and 8th centuries. The name of Z., moreover, deserves honourable mention in connection with a work of benevolence and charity, which the Roman Church afterwards consecrated by intrusting it to a special religious order—viz., the redemption of captives from the pagan masters by whom they had been held in slavery. During the troubles arising out of the Lombard invasion, Z., by his interposition in more than one instance in favour of the city of Rome with the Lombard kings, contributed to that prestige of the Roman see, which eventually led to its obtaining the leadership of Italy, and in the end the temporal sovereignty of Rome and the adjoining territory. Z. died at Rome on the 14th March 752.

**ZADO'NSK**, a town of Russia, in the government of Voronej, 50 miles north of the town of that name, and about 230 south of Moscow, on the left bank of the river Don. Pop. (1867) 7209. The trade of the town is not extensive, owing to the close neighbourhood of the commercial towns Eletz and Voronej. The manufactures are insignificant. Z. possesses a renowned cloister.

**ZAFARA'N-BO'LI**, a town of Asia Minor, in Anatolia, about 190 miles east-north-east of Soutari, at the junction of two small affluents of the Chati-su. It has four handsome mosques, a church, large baths and khans, and extensive suburbs. It has a considerable trade in saffron (whence its name), which is cultivated extensively in the surrounding country. Pop. supposed to be about 15,000.

**ZAFFRE**, crude oxide of cobalt, made by roasting cobalt ore and reducing it to powder, with the addition of about three parts of the finest white sand used by glass-makers. It is extensively prepared in Saxony, and is often imported into Britain. When fused into a glass, it is intensely blue, and is much used by enamellers and porcelain manufacturers as a blue colour.

**ZÄHRINGEN**, a small village near Freiburg, in Baden, in the Breisgau, formerly a province of Austria, but annexed to Baden in 1805. It is historically noteworthy for the ruined castle from which the Dukes of Zähringen took their name, the ancestors of the reigning House of Baden (q. v.). The Hapsburgs (q. v.) are traced to the same stock. Guntram or Gunthrun the Rich, Count of Breisgau—son of the famous Erchanger, who raised himself to the dignity of Duke of Swabia and was beheaded for treason in 917—is assumed as the founder of the House of Zähringen. The Zährings claim to be descended from his eldest son, Gebhard; the Hapsburgs, from the younger, Langelin. After the death of Duke Berthold I., 1077, the House was divided into two lines—the ducal or Zähring line, which became extinct in the male line in 1218, with Berthold V., the founder of Bern; and the markgraf

or Baden line, from which the present House of Baden is descended. The ducal Zährings exercised a beneficent sway over a great part of Switzerland.

**ZAIRE**. See CONGO.

**ZAMA**, a city and fortress in Numidia, about 300 miles south-west of Carthage, near which Hannibal was defeated by the Younger Scipio, 201 B.C. The flower of Hannibal's forces consisted of a small veteran army, that had shared his fortunes for many years; most of the rest were of inferior quality, of many races, variously organised, and of suspicious fidelity. But his greatest deficiency was in cavalry, an arm with which he had repeatedly decided the victory in former battles. In Scipio's army, on the other hand, Numidians, under Masinissa, were present in overwhelming numbers. The onset of Hannibal's elephants, of which he had 80, was defeated and made worse than useless by the wise precautions of Scipio; the cavalry on his flanks were scattered by the furious charge of Masinissa and Lælius; his front line of mercenaries beaten back by the more numerous and better-disciplined Romans. His veteran infantry, hemmed in on all sides, fought with the courage of despair, and were cut to pieces. Hannibal having done everything, both before and during the battle, which could secure the victory, escaped with a few horsemen. Of the Carthaginians, 20,000 were left dead on the field, and an equal number taken prisoners. Of the victors, 2000 fell in the action.

**ZAMBESI RIVER AND REGION**. The extensive region in South-east Africa, known to medieval geographers under the general name of the empire of Monomotapa, is shewn on old maps as drained by a river called Zambese, or Zambere, on the banks of which appear large towns, of which the mythical 'Vigita Magna' was supposed to be the most famous. The course of the stream, which is the modern Z., is, however, pretty correctly delineated, and even a small lake is shewn in connection with it, not far from the real position of Lake N'gami, whose existence we only became aware of a few years ago, and which we now know may be considered one of the most southern collections of inland waters which communicate with the Z. River and the more eastern lakes. The Nyassa or Maravi, as well as the more northern lakes, Victoria N'yanza and Tanganyika (the latter in connection with the Nile basin), are also given with such a degree of accuracy that it plainly shews, that in compiling these early maps, the distinctive features of the region must have been well known—principally, it is supposed, from Arab sources, various settlements of that people inhabiting the east and south-east coast of Africa from the Red Sea to Sofala.

Although the lower region of the Z., for a distance of at least 300 miles from its mouth, has been in possession nominally of the Portuguese since the beginning of the 16th c., forming the captaincies of Rios di Senna, Tete, and Quilimane, yet it is only within the last few years, through the indefatigable exertions of Dr Livingstone (1851—1856, and 1858—1864), Mr Oswell, Dr Kirk, Mr T. Baines, Mr James Chapman, Charles Andersson, and other intrepid African explorers, that we have got anything like an accurate or scientific idea of this vast region, which extends from 8° to 21° of S. lat., and from 14° to 37° of E. long.; and the total length of what may be considered the main stream (called Leambe in its upper course), from its mouth to the point shewn on Dr Livingstone's map, where the Leaba River, which proceeds from Lake Dilolo—on the summit of the watershed which divides the rivers running north-west into the Atlantic from those running

## ZAMBESI RIVER AND REGION—ZAMIA.

south-east into the Indian Ocean—joins it, cannot be less than 1200 miles.\*

The river-basin of the Z. presents some interesting physical features. On the north, it is coterminous, in all probability, with a portion of the Nile river-system; on the south and west, an obscurely marked water-shed, crossing the Kalihari Desert, separates it from the Orange River basin and the rivers that run through Ovampo Land into the Atlantic; on the north-west, its head-waters probably rise close to the tributaries of the great Congo River; while on the south-east, a well-defined mountain-range divides the rivers flowing into the Z. from those which form the Limpopo River, which, it is now nearly certain, enters the sea under the name of the Sabia. It thus forms, as it were, a central link between the waters of the Cape Colony and those of Egypt, connecting, as it were, the regions round the Cape of Storms with those of the Mediterranean.

The name of Z. is preserved from the mouth of the river, or rather a short distance above it, to the junction of the main stream with the Chobe, in lat. 17° 31' S., long. 25° 13' E., which connects it with the sluggish inoculating streams of the N'gami region; from thence it is called Leambye; and its course has been only laid down with any pretension to accuracy as far as its junction with the Leeba (lat. 14° 10' S., long. 23° 35' E.), when it appears to turn suddenly to the north-east, forming a vast network of streams, which anastomose with one another, and appear to form several other connections with the main stream, far to the eastward, through the Kafue, Loangwa, and other branches, at least if native reports can be trusted. Of the more remote sources of the main stream, except Lake Dilolo, we know nothing; the explorations in which Dr Livingstone was engaged till shortly before his death were expected to throw light on this point.

This part of Central South Africa may be considered as an extensive plateau or table-land, from 3000—4000 feet above the sea-level, with an outer fringe or border of basaltic rocks, cutting through which, the Z. River forms one of the most striking scenes in the physical geography of the universe—namely, the Victoria Falls of Livingstone, or Mosio-tunga, or 'Smoke sounds there,' of the natives. Here, a few miles to the east of where the Chobe joins the Z., the latter—a stream of 1000 yards in width—plunges down into a chasm more than 100 feet deep, forming an immense crack in the basaltic rock, at right angles to its course, and is carried along in a narrow channel some 30 miles in the same direction, between steep basaltic rocks, scarce 100 feet apart from each other. The pictorial illustrations of Mr T. Baines will give a far more vivid idea of this wonderful fall than any verbal description.

The whole of this vast country, both north-east and west of the upper course of the river, is very imperfectly known; but it is ascertained that the Okavango of Andersson, formerly supposed to be one of the branches of Cuanene River, is connected with the Z. basin. As we descend the river to the ocean, it runs in a south-east course, varying in width from 500 yards to two miles and more, in the rainy seasons. From the Portuguese town of Tete downwards, it is navigable, although with difficulty in the dry season; and it passes through one or two narrow rocky gorges in the Lupata Mountains, which

\* Lake Dilolo appears to have an outlet both to the north and south. The northern outlet probably joins the system of lakes west of Tanganyika. If these lakes communicate with the Albert Nyanza, then Lake Dilolo stands on the watershed between the Z. and the Nile; or between the Z. and the Congo, if the lakes have their outlet towards the latter river.

form ugly rapids, except when the river is in full flood. About 80 miles from the mouth, it receives from the north the waters of the Shire, which runs out of Lake Nyassa, the Maravi of old geographers, an extensive sheet of water about 230 miles long, and 50 miles across at its widest part, extending between lat. 11°—14° 30' S., and it enters the low country about 50 miles from the ocean, where it divides into many branches, forming a large delta, of a very unhealthy character. The most northern stream is called the Kwaka, or Kilimane, or Quilimane River; and the most southern and deepest channel, the Luabo. At Kilimane, or Quilimane, about 18 miles from the sea, is the residence of the Portuguese governor of the region; but there are various other entrances used by slavers and contrabandists, which are not very accurately laid down in our charts; and it is both difficult and dangerous to enter the river without a competent pilot.

The Victoria Falls are estimated to be 2500 feet above the sea-level. Tete is considered to be 400 feet; and the rapids of Lake Nyassa, where the Shire issues from it, are 1552 feet above the same; while Lake Shirwa, a smaller lake, south-east of Nyassa, is 2000 feet.

The natives inhabiting the coast region drained by the Z. must be considered of the pure negro type; while the Makololo, who are found in the central and upper country, belong to the Betjuana family, or rather, are a sort of link between it and the negro. They are, however, to be regarded as conquerors of the original tribes, called Makalaka, who may be classed as negroes, and are still numerous. The Zulu tribe of Amatabele, under Mosilakatsa, who inhabit the high region dividing the Limpopo from the Z. basin, have overrun and conquered nearly all the tribes south of them. The slave-trade is actively carried on in the countries nominally claimed by the Portuguese; and the lamentable failure of our late attempts to plant an episcopate and civilise the natives through missionary influence, must be fresh in the memory of our readers. The native population may be considered large, as compared with that of the Cape Colony or Betjuana Country.

All the usual tropical productions are found, but owing to the disturbed state of the native tribes, are but little cultivated. The animal kingdom is very similar to that of the adjacent regions of South Africa; and an immense quantity of ivory is exported both from the west and east coasts. The prevalence of the Tsetse (q. v.) makes travelling difficult in the interior. Extensive coal-fields exist, and gold is found in the neighbourhood of Tete and Senna.—Vide the *Travels of Livingstone*, 1st and 2d parts; T. Baines's *Explorations*, Andersson's *Okavango*, and various articles in *Journal of Royal Geographical Society*; *The Victoria Falls* (1866), and to the *Victoria Falls of the Zambesi*, by Ed. Mohr (London, 1876).

ZAMIA, a genus of plants of the natural order *Cycadaceæ*, of which the species are found in the tropical parts of the world. They have a tree-like stem, with a single terminal bud and pinnate leaves. The wood consists of concentric circles, with very loose cellular zones between them. The male and female flowers are on separate plants, in tessellated catkins, the scales of which differ in form in the male and female plants. The central part of the stem contains much starch, especially in old plants, and a kind of sago or arrowroot is made from some of them. The central part of the stem of the Bread-tree (*Z. cycadis*), of South Africa, which is about six or seven feet high, with a scaly stem, is much used as an article of food by the Kafirs and Hottentots, who prepare it by wrapping it in a skin well rubbed with grease, burying it in the ground until it



coasting-trade. The chief manufactures are rosoglio, maraschino, leather, silk and linen fabrics. Pop. (1869) 8014, Italians by descent, and speaking the Italian language. Anciently, Z. was the capital of Liburnia, in Illyricum; and under Augustus it was made a Roman colony.

**ZARAGOZA.** See SUPPLEMENT.

**ZARAI'SK**, a Russian town, in the government of Riazan, 32 miles north-west of the town of Riazan, and 80 south-east of Moscow, a few miles from the right bank of the Oka, a tributary of the Volga. The town was founded in the 13th c.; and in 1531, Ivan the Terrible erected on the site of the old fortifications a strong fortress, which thrice resisted the assaults of the Tartars, and which still exists. Another noteworthy object is the Cathedral of St Nicolas, which dates from 1631. There are manufactures of soap and candles, as also several tanneries and breweries; these, however, produce only sufficient to meet the wants of the inhabitants. The commerce of the town has greatly declined since 1847, when the new road of Riazan was opened, leaving Z. out of the way. Pop. (1867) 5165.

**ZE'A** (ancient *Ceos*), an island of the Grecian Archipelago, one of the Cyclades, 13 miles east of Cape Colonna; 14 miles in length, and 8 in greatest breadth. It is somewhat egg-shaped. Its surface rises from the coast in terraces, culminating in the centre in Mount St Elias, whose lat. is 37° 37' N., and long. 24° 21' E. The climate is healthy, and the soil fertile. The products are wine, fruit, barley, cotton, and silk. Attention is paid to the rearing of cattle and silkworms. Pop. 4000. Pliny says that Z. was once united to Eubœa, but that four-fifths of it were carried away by the sea. Z. was the birthplace of the lyric poets Simonides and Bacchylides. The island once possessed four towns, but there is now only one, *Zea*, situated on the north-west slope of the hill, about 3 miles from the coast, on the site of the ancient *Iulis*, of which the most important remain is a colossal lion, about 20 feet in length, lying a short distance east of the town. A few remains are also still to be found on the sites of the other three ancient towns. The harbour of Z., Port St Nicholas, about 3 miles from the town, admits the largest vessels, and is well frequented.

**ZE'A.** See MAIZE.

**ZEBI'D**, a town of Arabia, district of Yemen, on the river Zebid, 15 miles from its mouth, 115 miles south-west of Sanaa, and 60 north of Mocha. The town is of great antiquity, on account of which and of the dark colour of the bricks of which it is built, it has a somewhat gloomy appearance. Z. is strongly fortified, being surrounded by high walls, said to be a league in circuit, flanked with numerous towers. It possesses a large mosque, with an elegant octagonal tower. Z. was formerly a place of much commercial importance, but it has declined into comparative insignificance, owing to the accumulation of sand in the mouth of the river. Pop. 7000.

**ZE'BRA**, a name sometimes given to all the striped *Equida*, all of which are natives of South Africa, and thus including the *Dauw* (q. v.) and *Quagga* (q. v.); but also, in a more restricted use, designating a single species, *Equus* or *Asinus Zebra*, a native of the mountainous districts of South Africa. In the whole group, the characters more resemble those of the ass than of the horse; the tail is furnished with long hairs only towards the tip, and the hind-legs are without warts; the neck is full and arched, the mane stands erect. The Z. is about 12 hands high at the shoulder. It is of a light and graceful form, with slender limbs and narrow hoofs; the head light, the ears rather long

and open; the ground colour white, or slightly tinged with yellow; the head, neck, body, and legs striped with black, the neck and body transversely, but not regularly; the head with bands in various directions, the legs with irregular cross stripes. The Z. lives in small herds, inhabiting the most secluded spots. Its senses of sight, smell, and hearing are very acute, and the least alarm is sufficient to make a whole herd scamper off, with pricked ears and whisking tails, to inaccessible retreats



*Zebra (Asinus Zebra).*

among the mountains. When attacked, however, and compelled to defend themselves, zebras do it vigorously, the herd forming in a compact body, with their heads towards the centre, and their heels towards the enemy, repelling even the lion and leopard by their kicks. The Z. has been domesticated, and used as a beast of burden, but generally shews a vicious and untractable disposition. The flesh is eaten by the natives and hunters of South Africa. A hybrid has been produced between the Z. and the ass.

**ZEBU'**, one of the Philippine Islands (q. v.).

**ZEBU, INDIAN OX, or BRAHMIN OX**, a kind of ox, very nearly allied to the common ox, of which naturalists generally regard it as a mere variety, although some think it a distinct species (*Bos Indicus*). The most conspicuous distinctive character is a large fatty hump on the back, above the shoulders. The legs are also rather more slender and delicate than in the European ox. The hump attains a very great size in animals plentifully



*Zebu or Indian Ox.*

supplied with food, and not compelled to work; in those which are ill fed or hard worked, it is comparatively small. It is alleged that intermixture takes place freely with the common ox, and that there is no difference of anatomical structure, but these statements require verification. Mr Vasey found the number of caudal vertebrae in the Z. to

be only 18, whilst in the common ox it is 21. The period of gestation in the Z. is also said to be 300 days, whilst in the common ox it is 270. The Z. is diffused over India, China, the Asiatic Islands, Madagascar, and the east coast of Africa. There are many breeds, differing very much in size; the largest being larger than any oxen of Europe, whilst the smallest are not much larger than a large mastiff. The hump of the largest breeds is said to be sometimes 50 lbs. in weight. English residents in India esteem the hump as delicious for the table. There are hornless breeds; but most of the breeds have short horns. There is a breed with two fatty humps, one placed immediately behind the other, which is common in the vicinity of Surat. The voice of the Z. resembles the grunting of the yak, almost as nearly as the lowing of the ox. The Z. is used in India both as a beast of draught and of burden. It is yoked in the plough. It is occasionally used for riding. It can travel from 20 to 30 miles a day. It is very gentle and docile.

The Brahminy or sacred bulls of the Hindus, consecrated to Siva, are all of this kind of ox. They are caressed and pampered by the people, and to feed them is deemed a meritorious act of religion. The Brahminy bull may go where he pleases; it is not lawful to beat him, even if he be eating a valuable crop, or if he enter a shop and devour the articles exposed for sale. He soon learns to despise shouting, which is the ordinary expedient to drive him away, and makes himself at home everywhere.

#### ZECCHINO. See DUCAT.

**ZECHARIAH**, called in the book of prophecy which goes under his name, 'the son of Berechiah, the son of Iddo,' but in Ezra, 'the son of Iddo,' was born in Babylonia during the captivity, and accompanied the first band of exiles on their return to Palestine under Zerubbabel and Joshua. Very little is known of his personal history, but enough to assure us that he was a man of influence and a leader among his countrymen. He combined in himself the offices of priest and prophet. Ezra expressly ascribes to Haggai and him the merit of stirring up, by their prophetic inspiration, the patriotic enthusiasm of the Jews to complete the rebuilding of the Temple. Later traditions, which are probably more or less in the line of historic fact, state that he assisted in providing for the service of the Temple (various of the liturgical psalms being ascribed to him), and that he was a member of the great Synagogue (q. v.).

The prophecies of Z. may be divided into three parts: the first (chapters i.—viii.) consists mainly of a series of visions relating to the building of the Temple, the glory of the city, the removal of all abominations out of the land, &c., and winds up with a prediction that Jerusalem will become, as it were, a centre of religious worship to all the world. The second (chapters ix.—xi.) threatens Damascus and Phœnicia, and the cities of the Philistines with ruin; predicts that Judah will be greater than Javan (Greece), that Israel and Judah will be reunited—though almost immediately he symbolically shews the impossibility of this—and that both Assyria and Egypt will be humbled. The third part sets forth that dark times for Judah are drawing nigh, which shall be as an ordeal for the nation. After sore trial, it shall come forth thoroughly purged from iniquity, and then the Lord will appear in his glory on Mount Olivet, fight victoriously against the hosts of heathendom, and compel all who are not destroyed by his wrath to worship Him at Jerusalem. A millennium of holiness will then begin: 'In that day shall there be upon the bells of the horses, "Holiness unto the Lord" . . . yea, every pot in Jerusalem and

in Judah shall be holiness unto the Lord of hosts' (xiv. 20, 21).

Numerous biblical critics, both in Germany and England, consider the first part only to be the work of Z., and it cannot be denied that the internal evidence strongly favours this supposition. There is a unity, consistency, and sequence in the visionary predictions, and a harmony both of style and matter—the imagery bearing very distinctly the impress of those two master-spirits of the exile, Ezekiel and Daniel—that no candid critic can overlook, while the remaining chapters are totally unconnected in subject with what precede; contain no allusion to the post-exilian age, and speak of idols and false prophets in a way that would be utterly meaningless if applied to the times subsequent to the return from the captivity. The style also is quite different; is softer, richer, more poetical. The spirit of Ezekiel is exchanged for that of Jeremiah or the younger Isaiah. Whether these chapters are the work of one or two authors, has also been elaborately discussed, the evidence being, on the whole, in favour of the latter view.

**ZECHSTEIN** (Ger. mine-stone), a deposit of calcareous rock which covers the Kupfer-schiefer, and which received this name because it must be cut through before reaching the mineral-bearing beds beneath. It is the equivalent in Thuringia of the fossiliferous limestones of Permian age of the north of England.

**ZEDEKI'AH**, originally **MATTANIAH**, the last king of Judah, son of the 'good Josiah' by his wife Hamutal, succeeded his nephew Jehoiachin. The latter having rebelled against his master, Nebuchadnezzar, king of Babylon, was besieged in Jerusalem, and taken prisoner, after a brief reign of three months. Nebuchadnezzar bestowed the vacant throne on Z., doubtless in the expectation of securing a faithful liegeman. If so, he was mistaken. Z. was a weak unwise ruler, probably incapable of political fidelity: in the phraseology of the Jewish historian, 'he did that which was evil in the sight of the Lord.' Forgetting his obligations to the Babylonish monarch, he lent a ready ear to the foolish braggadocio of the nobles and princes of Judah, and in spite of the earnest and reiterated remonstrances and warnings of Jeremiah, finally consummated his perfidy by forming an alliance with Egypt, the hereditary enemy of Assyria and Chaldaea. Swift destruction overtook the traitor. A Babylonish army invaded and ravaged the country, besieged Jerusalem, and after inflicting a crushing defeat on an Egyptian force that was marching to the relief of the city, reduced the inhabitants to such horrible extremities, that they could no longer hold out. Z., accompanied by his wives and children, fled in the darkness of night towards the Jordan, but was overtaken and made prisoner near Jericho. The monarch and his sons were sent to Riblah, at the north end of the valley of Lebanon, where Nebuchadnezzar then abode. The conqueror, with customary Asiatic cruelty, ordered the sons to be slain before their father's face, and then deprived the wretched parent of his eyesight. Thus maimed, and bound with fetters of brass, he was conveyed to Babylon (588 B.C.), where he probably died. The Temple and city were destroyed, the inhabitants carried off into captivity, and the kingdom of David and Solomon ceased to have a place on the earth.

**ZEDOARY** (Arab. *Jedwar*), the name of certain species of *Curcuma* (see **TURMERIC**), natives of the East Indies, the root-stocks (*rhizomes*) of which are aromatic, bitter, pungent, and tonic, and are used for similar purposes with ginger. They are

ZEELAND—ZEITHUN.

more used in the East than in Europe, but are imported in small quantities, and sold under the name of Zedoary. The ROUND Z. of the shops is the produce of *Curcuma zedoaria*, a native both of India and China, having palmate root-stocks, straw-coloured within. LONG Z. is produced by *C. zerumbet*, a native of various parts of the East Indies, having long palmate root-stocks, yellow within. Z. is a powerful sudorific.

ZEE'LAND, a province of the Netherlands, consists of the islands Walcheren, North Beveland, South Beveland, Schouwen, Duiveland, Tholen, West Flanders, and East Flanders. It lies between 51° 20'—51° 45' N. lat., and 3° 21'—4° 15' 54" E. long., and has an area of 665 sq. miles. The boundaries are: South Holland on the N., the Easter Scheldt on the E., Belgium on the S., and the North Sea on the W. Pop. (January 1, 1875) 184,215. In 1874, births, 7693; deaths, 2865; marriages, 1527. Nearly three-fourths are Protestants, having 138 churches; the remainder, except 670 Jews, with 4 synagogues, are Roman Catholics, who have 36 places of worship. The provincial capital is Middelburg. Other important towns are Flushing; Goes (pron. *Huse*), in South Beveland; and Zierikzee, in Schouwen. The greatest part of the soil, which is a rich clay, has been redeemed from the sea; and almost in the centre of Walcheren, South Beveland, and Schouwen, there are seen still the high mounds of earth called 'hills of refuge,' which the early inhabitants formed as places of safety for themselves and cattle when a high tide burst over the newly acquired lands. The number of Polders (q. v.), or drained districts, in the province amounts to about 400. It is almost entirely arable, and produces the finest crops of wheat, barley, oats, rye, peas, beans, colza, beet, flax, hemp, canary-seed, mangolds, &c. Potatoes are extensively planted; and madder for the manufacture of dyeing material forms a valuable agricultural product. Horses, horned cattle, sheep, swine, and goats, are the stock. In many districts of Z., extensive orchards beautify the farms.

The neighbouring seas abound with fish, and in Schouwen, many eggs are collected, myriads of water-fowls resorting thither to form their nests. The principal industries, apart from agriculture, are the preparing of madder for the market, weaving calicos, rope-spinning, ship-building, beer-brewing, soap-boiling, making vinegar, salt, starch, tobacco, tile and brick, tanning leather, grinding corn, sawing wood, &c. The people of Z. are kind and hospitable, and in the country parishes, are much attached to their fairs, meetings for merry-making, and other old customs, which might with advantage be given up. Few marriages take place among the agricultural portion of the population till absolutely necessary, but a case of desertion rarely occurs, as it would utterly disgrace the young man who did so.

On the 15th of October 1866, a fine ship-canal through the island of South Beveland was opened, and takes the place of the Easter Scheldt. A railway from Flushing, through Walcheren and S. Beveland, communicates with the main Belgian lines at Roosendaal, and by Breda leads to Rotterdam, Amsterdam, or Germany.

ZEITHUN, a town and district in the highlands of Cilicia, lying in 37°—38° N. lat., and 34°—35° E. long., inhabited by a community of Armenian Christians, virtually independent of the Turkish government, and forming in fact an Asiatic republic. Z. lies in the upper basin of the Jyhun or Pyramus, where that river crosses the Taurus Mountains in descending from the table-land of Asia Minor to the low plain of Cilicia, which sur-

rounds the north-eastern corner of the Mediterranean Sea. It is surrounded on all sides by inaccessible crags, except on the east, where it is bounded by the deep channel of the Pyramus. The hills are covered with magnificent pines, plane trees, and evergreen oaks. Springs and brooks, never dried up during the summer, irrigate the meadows in all directions; but the soil, although abounding in patches of great fertility, does not produce grain in sufficient quantity to supply the wants of the inhabitants. The mulberry trees are, however, numerous in the orchards, and give constant occupation to the women in feeding silk-worms. The men are chiefly engaged in smelting and manufacturing the iron supplied by the mountains into ploughshares, horse-shoes, nails, &c., which they exchange for corn and other articles at Marash and Kaisariyeh. The language of Z. is a rude dialect of Armenian, in which the only literature consists of popular songs not committed to writing. Education is much neglected among children, who, except when intended for the priesthood, are not sent to school after the age of 10 or 12. The inhabitants, like the kindred race in Armenia, are free from Asiatic vices. They resemble Europeans in their respect for women. Crime is not frequent. No prisons exist, and it is asserted that murder has never been committed in the country for the sake of gain. There may be exaggeration in these statements, but the Zeithumli are certainly open-hearted mountaineers. They have, however, shewn the greatest jealousy of foreigners; and until 1854, when their country was visited by M. Léon Paul, a French Protestant clergyman, we only knew of them from the statements of Armenian priests, and articles in the Armenian newspapers of Constantinople. Even now, our information about them is rather scanty. The government seems to be patriarchal, vested in elders of the people, with some prerogatives in the priesthood. When a grievance is felt, complaint is made to the priests, who meet in council, and refer the complaint to the elders assembled as a senate: they decide on the course to be taken. All offices are conferred by popular election, the executive power being placed in the hands of four princes. There are 20 villages in the district, and the chief town, Z., is said to contain 20,000 inhabitants. The Zeithumli can muster an army of from 7000 to 8000 men to defend the mountains against the Turkish pashas; and they are in alliance with a neighbouring Turcoman chief, also independent of the Turks, who brings 10,000 men into the field. Z. is a relic of the Armenian kingdom of Cilicia, founded in the 11th, and destroyed in the 14th century. Since that period, the native populations have been gradually assimilating to the Turks, a change much favoured by the extreme facility with which the Turkish language is acquired. It was not till after the Crimean War that the massacres in the East called special attention to the existence of Z. and other Christian communities in the East, which had some claim to European sympathy. An attempt by the Turks to settle Circassians near Z., gave Aziz Pasha of Marash an opportunity of attacking the Christians, and the atrocities committed remind one of the worst excesses of Cawnpore. The inhabitants defended themselves, however, with the greatest gallantry, twice defeating in the field large Turkish forces; and the struggle was at length terminated by the interference of the French and English governments at Constantinople, and the recall of the pasha. Unfortunately, the Turks were allowed to suppress the Armenian newspaper which acquainted the European public with what is taking place at Z., and we have ceased to receive recent information regarding it. An interesting account of the massacres and the defence of Z. will be found

in the *Revue des deux Mondes* of February 1863. See also *Spectator* of 26th August 1865.

**ZEITZ**, a walled town of Prussian Saxony, in the government of Merseburg, 23 miles south-west of Leipzig, lies in a pleasant and fruitful district, on a steep slope, on the right bank of the White Elster, over which there is a stone bridge. The town is very old, and has some good old public buildings; a cathedral, and four other churches; a good library, containing 12,000 volumes, besides MSS.; asylums for orphans and lunatics, an old and new castle, &c. There are manufactures of cotton, earthenware, leather, calicoes, hosiery, gloves, &c.; several print-fields, breweries, and distilleries. In the neighbourhood are extensive mineral-oil works. Pop. (1871) 15,417. It is a station on the Thuringian Railway.

**ZELA'YA**, a town of Mexico, in the state of Guanajuato, about 120 miles north-north-east of the town of Mexico, on the right bank of the Rio Grande de Santiago, which is here crossed by a handsome bridge. It has a fine cathedral, of mixed architecture, with Corinthian and Ionic columns, and numerous other churches and convents, which are rich in works of art. There are manufactures of cotton and saddlery. Horses and mules are bred to a considerable extent in the vicinity. Pop. 14,000.

**ZELKOU'A** (*Planera Richardi*), a tree of the natural order *Ulmaceae*, with a straight and erect trunk of 75—80 feet high, one-third of which height is without a branch, a large head, elliptical leaves of 1—3 inches long, and small flowers with bell-shaped perianth, and small roundish dry 2-celled fruit, the cells 1-seeded. It is a native of Georgia, the north of Persia, &c., and is sometimes planted in England. The timber is valuable, the sapwood elastic, the heartwood very hard.—*P. Gmelini* is a low tree, a native of Kentucky, and of some of the more southern states of America.

**ZEMINDAR**, the name given to the governors of districts or large towns in India, under the Mogul rule. Many of the zemindars occupied in India a position almost similar to the dukes and counts of Western Europe in the middle ages; they received from their superiors, the nabobs or provincial governors, fiefs of more or less extent, for which they paid a certain due annually, being then exempted from all other imposts whatsoever. The dues paid by the zemindars were of course exacted, with additions, from the ryots or cultivators, and constituted a large part of the imperial revenue. Under the British government, the same system of tax-collection is continued in Bengal, the zemindars in that presidency being looked upon as the hereditary lords or proprietors of their respective districts. The zemindars of the Coromandel district were formerly called *polyphars*. Under the zemindars were the *havildars*, or heads of villages, whose duty it was to collect their share of the tax imposed by the zemindar, and as, like their chief, they took care to collect an additional proportion for themselves, the most atrocious oppression was commonly practised; the 'nabob' pillaging the 'zemindars, the 'zemindar' in turn plundering his 'havildars,' while the 'havildar' more than reimbursed himself at the expense of the Hindu villagers.

**ZEND**,\* the language in which are composed the

\* Much uncertainty prevails as to the real meaning of the word Zend. The name *Zend-Avesta* (q. v.) is, by the native scholars, understood to mean commentary (*pehlevi*) and text, an opinion supported by the most eminent Zend scholar of our day, Dr Haug. The opinion of Max Müller to the effect that Zend is identical with the Sanscrit *chhandas*—a name given to the Vedic hymns—and *Avesta* = *avasthāna*, a word which, if it occurred in Sanscrit, would mean settled text, requires further confirmation.

ancient sacred books of Zoroaster, first became known through Anquetil-Duperron (q. v.). Many scholars of eminence, like William Jones, Meiner, Henning, W. Erskine, and others, warmly contested the age of these writings. They held that the idiom in which they were couched had never been spoken in any part of Persia, but was a Sanscrit dialect which had been introduced from India for sacred use. The so-called Zoroastrian writings, they said, dated from the time of Ardeshir-Babegan, the first Sassanian, in 280 a.c., or had at least been rewritten and redacted at that time. The first who endeavoured to lay the foundations for a real grammatical knowledge of Zend was Rask, the Dane, who, in 1816, undertook a journey to India and Persia, in order to make researches into the origin and nature of this language on the spot. Although he did not live to make known all the results of his investigations, he yet proved irrefutably that the sacred language of the Parsees was closely connected with that of the Brahmans; or, in other words, that Zend was akin to Sanscrit, and that, like the latter, it had retained some of the earliest formations of the Aryan dialects. Eugène Burnouf followed in his steps. He was indeed the real founder of Zend studies in modern Europe. By the aid of his knowledge of Sanscrit and comparative grammar, he proceeded to decipher, for the first time, the sacred writings of Zoroaster in the original; while Anquetil-Duperron, who first made the *Zend-Avesta* known in a European garb, composed his translation only from a modern Persian translation. Both he and Bopp contended for the independent and ancient existence of Zend, holding that Sanscrit, being a new language which came from the north, was more likely to be derived from the Zend than the latter from Sanscrit. The opinion of Haug, the latest, and by far the most successful investigator of Zend language and literature, is, that Zend is almost identical with the most primitive—the Vedic—form of Sanscrit. We shall give in the following sketch the results of his studies, which unfortunately have as yet appeared only in the preparatory shape of essays.

The Zend idiom, in its widest sense, embraces two so-called 'Bactrian' dialects, which, together with the 'West Iranian' languages, i. e., those of ancient Media and Persia, form the stock of Iranian tongues. These tongues were once spoken in what the *Zend-Avesta* calls the 'Aryan countries' (*Airyō danāvō*). The former, the 'East Iranian' or 'Bactrian' branch, has survived, in its two dialects, in the scanty fragments of the Parsee Scriptures only. The more ancient of them is called the 'Gāthā dialect,' because the largest and most important pieces preserved in this peculiar idiom are the Gāthas, or songs; the younger or 'ancient Bactrian,' also 'classical Zend language,' is the one in which the greater part of the *Zend-Avesta* (q. v.) itself is written. Both dialects seem to have died out in the 3d c. a. c., leaving no linguistic progeny. The general character of Zend, in its widest sense, is that of a highly-developed idiom, inasmuch as it is as rich in inflections (there are no less than three numbers and eight cases) as is the Vedic Sanscrit, and is richer even than the Latin in the variety of forms inherent in its verbs and nouns. There are numbers of compound words in it; and the whole syntax bears the stamp of an advanced stage of linguistic progress. A genuine sister of Sanscrit, Greek, Latin, and Gothic, it is yet only known to us, much as is the Hebrew, in its declining phase. The forms are no longer accurately kept distinct, and a return to the originally uninflected state is noticeable, principally in the verbs. It may be that the Bactrian grammar had never been properly

fixed by rules, and that, in the absence of that tender care which the Brahmans took of the preservation of the Sanscrit texts and idiom, many corruptions and abbreviations gradually crept from the colloquial into the classical language of Zend, and were thus perpetuated in the surviving remnants. As soon as the language of the Zoroastrian books died out from daily use, these books were mechanically copied, time after time; and any number of blunders, unchecked by an understanding of the structure or the details of the language, crept in unheeded. The oldest copies are the best, comparatively speaking: the more modern the copy, the oftener the terminations are found as separate words; vowels are inserted according to the faulty pronunciation of the writer; and a number of other faults, of omission or commission, are patent at first sight, solely due to carelessness and ignorance. Before indicating the general character of Zend, we shall briefly observe that its two dialects differ both phonetically and grammatically; and the phonetical differences are so great, that, at first sight, it would almost appear as if they were caused by different localities rather than ages, but, on closer inspection, it is found that the singing of the Gâthas, whereby certain vowels were lengthened out, has caused many of these striking peculiarities. Grammatically, the Gâtha dialect shews many deviations from Zend, traceable to the more primitive state of the Bactrian language which it represents. But the differences between the two are not so great as between the Vedic and the classical Sanscrit, and between the Greek of Homer and the Attic dialect. At most, the Gâtha may be reckoned to be one or two hundred years older than that classical Zend which formed the classical language of the ancient Iranian Empire, as depicted in the earlier parts of the *Shâh Nâmah*.

There are twelve simple vowels and about fourteen diphthongs in Zend, for each of which there are special characters. Of vowels peculiar to this idiom, may be mentioned the *â* (long, with a nasal sound), used chiefly in the genitive plural termination; further, the *z*, which, in the Gâtha dialect, often replaces the final *ô* of the usual Zend, and which, by the frequency with which writers confound it with *t*, would also prove itself closely allied to that sound. There is, further, an initial *a* to be observed, which probably crept into the Zend texts when they were transcribed into their present characters, which, no doubt, are borrowed from the Syriac. This *a* corresponds to the Aleph prosthetic of the Semitic idioms. Again, the short vowels are always lengthened at the end of a word in the Gâtha dialect: owing most probably to the circumstance that the Gâtha literature—the most sacred hymns—were sung, and the singer's voice resting upon the final vowel, whether long or short, had the effect of lengthening it even in the MSS., written mostly from memory. Of consonants, there are 6 gutturals, 2 palatals, 4 dentals, 3 labials, 4 semivowels, 5 sibilants, 5 nasals. The roots are mostly monosyllabic, consisting occasionally of one vowel only, or being a combination of a vowel with a simple or double consonant, or of two consonants with a vowel between them; e. g., *i*, to go; *dâ*, to give; *gâ*, to go; *mere*, to die; *as*, to be; &c. Additional sounds added to the simple roots, enlarge and otherwise change the meaning of a word—*dâ*, to make, becomes, by the addition of *th*, *dath*, to place; from *mere*, to die, is derived *meretch*, to kill. Three chief modifications are to be noticed in the verbal roots, irrespective of tense and mood—viz., the 'causal form,' expressing the idea of 'to make,' 'to get made,' which is formed by lengthening the vowel of the root, and adding the syllable *aya*, as

in Sanscrit. Next stands the desiderative form, expressing the wish of obtaining anything, which is formed by the reduplication of the first syllable, and the addition of *s* to the crude form before the terminations. The last or intensive form, used to render the verb more emphatic, was originally produced by a simple reduplication of the root and the termination; afterwards, only the vowel of the first part was lengthened, and the consonants following were omitted. Three voices—the active, middle or reflective (Lat. deponent), and the passive—obtain in Zend, as in Greek and Sanscrit; and there are four chief moods, which may be used in all these three voices—the indicative, subjunctive, potential, and imperative. The subjunctive is of a double nature, the one expressing the 'might, would, or should,' the other the 'may'—a feature lost in classical Sanscrit, and only to be met with in the ancient language of the Vedas. The potential, too, is of two kinds, corresponding to the Sanscrit 'potential' and 'precativ.' There are as many tenses in Zend as there are in Sanscrit, though fewer than in Greek, which is, in this respect, the richest of the Aryan stock. There may be distinguished one formation for the present, four for the past, and two for the future.

The general scheme of the (active) present and imperfect is as follows:

PRESENT.		IMPERFECT.	
Active Voice.		Active Voice.	
Sing. 1. ml.	2. hl.	Sing. 1. m.	2. a, ô.
3. tl.		3. t.	
Dual 1. vahl.		Dual 1. âva.	2. (ost.)
2. (ost.)	3. tô, thô.	3. tem.	
Plur. 1. mahl.	2. tha, dôm.	Plur. 1. ma.	2. ta.
3. fiti.		3. cu, añ.	

The division of the 'crude' forms into ten classes, in use with the grammarians of Sanscrit, is also fully applicable to the Zend. Additions and reduplication make up the distinguishing features. The past tenses are likewise formed, as in the sister tongues, by augmentation, reduplication, or composition. Apart from those forms which are identical with those employed in Sanscrit, Greek and Lithuanian, Latin, and the ancient Teutonic languages, we find the use of two kinds of subjunctives. Equal richness of forms is found in the participle and the infinitive, whilst there are fewer gerundial forms than in Sanscrit. Nouns are formed out of roots by the addition of suffixes, which generally correspond to those of the cognate languages. There are three genders in Zend—masculine, feminine, and neuter. The comparative and superlative are formed very nearly as in Sanscrit and Greek. The number of compound nouns in Zend is somewhat less than in the Sanscrit and Greek, on account of its standing nearer the more simple Vedic idiom. There are three numbers and eight cases of inflection for singular and plural of nouns; while there are no less than five cases in the dual, no other Aryan language having retained more than three. The terminations of the cases (in words ending with a consonant) are somewhat according to the following scheme:

	SING.	DUAL	PLURAL
Nom.	a.	fa.	ô (ag).
Accus.	em.	fa.	ô, âa.
Instr.	a.	bya.	bia.
Dat.	ê.	bya.	byô (byaç).
Ablat.	at.	fo.	brô.
Gen.	ô (aç).	fo.	am.
Locat.	i.	yô.	aeshu, aeshva, hva.
Voc.	= Nom.	"	"

There are only pronouns of the first and second persons to be found in Zend, the third being made

up by a demonstrative pronoun. There are some older forms to be found in the Gátha dialect only. Most of the pronouns resemble closely the Sanscrit forms. The relative is sometimes used as a demonstrative. The numerals from one to ten are : *asva*, *dva* (va, *duḡé*, *ayé*), *thri*, *chathware*, *poñcha* (*meñda*), *kahvas* (*kshvidem*), *hapta*, *asta*, *nava*, *daça*. The following numbers are formed by the addition of the single cardinal numbers to the ten or *daça* : 20 = *viçaiti*, 100 = *çatem*, 200 = *duye çaité*, 1000 = *hazanra*, 10,000 = *baçvare*, 100,000 = *ahòkhsta*. The ordinals are : *paoirya*, first ; *bitya*, second ; *thritya*, third ; *khtúryah*, fourth ; *pukhdha*, fifth ; &c. 'Multiplication numerals' are formed by addition of *keret* and *vat*—e. g., *bakeret*, once ; *bishvat*, twice ; *thrizhvat*, thrice ; &c. Particles and prepositions are often identical with those of Sanscrit. The latter may be separated from the verb, if forming part of it, as is the case in the Vedic and Homeric languages, but not in classic Sanscrit or Greek.

We have started with the now fully proved assertion that Zend is closely allied to Sanscrit, more especially to the ancient Vedic dialect. To the latter it bears about the same affinity which the different Greek dialects (Æolic, Doric, Ionic, Attic) bear to one another. The ancient Brahmans and the Parsees are but two tribes of the nation which is called Aryas both in the *Veda* and *Zend-Avesta*, the former somewhat to be compared to the Ionians, the latter to the Dorians. But in comparing Zend with Sanscrit, it is noticeable that it resembles more the primitive Vedic than the classical Sanscrit. In verbal forms, chiefly moods and tenses, the classical Sanscrit is much poorer than it is in its primitive Vedic phase, having lost various forms of the subjunctive mood, most tenses of all other moods, except indicative, the manifold forms expressing the infinitive mood, while all these are found completely preserved in the *Vedas*, *Zend-Avesta*, and Homeric Greek. From these and many other signs, it would indeed follow as if the classical Sanscrit had been formed long after the separation of the Iranians from the Hindus. The differences between the Vedic, Sanscrit, and Zend are very minute in grammar, but important both phonetically and lexicographically, like the difference between German and Dutch. But the philologist can easily transform, by slight phonetic changes, the Zend word into the Sanscrit one. As a striking proof of the original identity of grammatical forms between the two, the circumstance may be cited of their both exhibiting certain identical irregularities.

For *Zend Literature*, we may refer both to our articles on PERSIAN LANGUAGE AND LITERATURE and to ZEND-AVESTA. We confine ourselves here to a brief mention of the principal items. At the head stand the five Gáthas, which may safely be ascribed to Zoroaster and his disciples themselves. There is no doubt that what now survives is but a scanty fragment of what once existed of this literature. Probably they but represent a selection of verses considered most efficacious for putting down evil influences, and for increasing the welfare of the Zarathustrians. The Gáthas, as they now stand, may be compared to the Sámaveda, which contains selections from the Rigveda, used at the Soma sacrifices. Next in order stand the Yasna, or seven chapters, containing songs and prayers, which dates from a much later period ; and here again the first portion, or 'Younger Yasna,' is of still later date ; and on the same line stands the Visparad, the collection of prayers called 'All Heads,' in 23 chapters. The Vendidad, on the other hand, represents conversations held by Zoroaster with Ahuramazda on religious topics, and is most likely the work of the high-priests of the Iranian community of later

periods. The Yashts, or songs and conversations, are the latest. The age of the different works mentioned is fixed by Haug in the following manner : The Gáthas about 900 or 1200 B.C. ; the larger portion of the Vendidad at about 900 or 1000 B.C. ; the younger Yasna, about 700—800 B.C. ; the latest part of the Vendidad (the Pazend) being written as late as 500 B.C., when the collection of the different parts also seems to have taken place. This computation would give the Zend, or rather the famed Parsee literature, a range of about 800 years, or from 1200—400 B.C. Cf. Haug's *Essays on the Religion of the Parsees* (Bombay, 1862).—See PERSIAN LANGUAGE AND LITERATURE, ZEND-AVESTA, ZOROASTER.

ZEND-AVESTA, or rather (as the Pehlvi books have it), AVESTA-ZEND, is the name of the sacred writings of the Parsees (q. v.). The word *Avesta* (*avasthá*) means text, scripture ; Zend, or Zand, translation or commentary and paraphrase. According to the last researches in this province, it would seem as if only a small portion of the entire collection now extant were formed by *Avesta*, or text, the rest being made up of *Zend*, or commentary, without text. The term *Zend* has indeed changed its meaning repeatedly. From an authoritative interpretation, emanating from the highest source, in time becoming embodied in the text itself, it came to denote, later, a translation into the native idiom of Persia (the Pehlvi), made by the Zoroastrian priests during the Sassanian period. There is further a special 'Zend doctrine' to be noticed, which differs considerably from that contained in the *Avesta*. A still further explanation of that *Zend* doctrine is the *Pázend*, a word often to be met with in connection with *Avesta* and *Zend*. Of this we shall further have occasion to speak.

But before proceeding with an elucidation of the contents and purport of these *Zend* writings, we must devote a brief space to a sketch of their history, or rather of the different phases the acquaintance with them on the part of the West has undergone. The doctrine of the 'Magi,' as the ancient world was wont to call the priests of Zoroastrianism, as well as those of India, Persia, and Babylonia, is first alluded to in Jeremiah, where the chief of the Magi is mentioned among Nebuchadnezzar's retainers. In the New Testament (Mat. ii. 1), Magi come to worship Jesus at Bethlehem. The earliest account among Greek writers is furnished by Herodotus, who, on the whole, seems well enough informed for his time. Besides him, we hear of accounts by Ctesias, the Greek physician of Artaxerxes II., by Deinon, Theopompos, and Herimippos. But only fragments from their writings have survived, embedded chiefly in Plutarch and Diogenes Laertius. Pliny, Strabo, Pausanias, Dion Chrysostomus further enlarged the stores of knowledge, which, more or less trustworthy, may be gathered from independent sources. Omitting later Greek writers, such as Damascius, Theodorus of Mopuestia, &c. we turn to Armenian writers of the 5th Christian century. Among them we find Eznik and Elizæus, from whose records we may gather that the Zoroastrians at their time were split into two parties, the one called *Mog*, the other *Zendik* ; the former inhabiting chiefly the western parts—Media and Persia principally acknowledging the *Avesta* ; while the latter, living principally in the east (in Bactria), followed the traditional explanations, or *Zend* proper. To the Arabic writer Masudi (950 A.D.) we owe a comparatively correct account of the sacred book ; while Sharastani (1153 A.D.) is perhaps the first among his countrymen who ranks the Zoroastrians with those other professors of Semitic creeds, the Mohammedans, Jews, and Christians, and not among the idolaters

and pagans. In his time, they were already split into many sects, those who believed in the transmigration of souls, like the Brahmans, Buddhists, &c. As a successfully carried out piece of deception, it is to be noticed that Mohammedan writers, for the most part, seem to countenance the fable palmed upon them during the times of persecution by the Magi, that Zoroaster was identical with Abraham—in which there is not one atom of truth. The nations of modern Europe came into contact with the adherents of Zoroastrianism in the western parts of India, and in the 17th c., some MSS. of their sacred books were brought to England. But no one was able to read them; and Hyde himself, the celebrated Oxford scholar, was unable to make any use of them when, in 1700, he wrote his learned work on the Persian Religion. A sort of romantic freak first put Europe into the possession of the key to this book, the language of which had been lost for above a thousand years. A young Frenchman, Anquetil-Duperron, happened to see a few pages that had been copied from a Zend MS. in the Bodleian Library, and he instantly resolved to betake himself to India in quest of the original Zend writings. To achieve this purpose, he, being without means, had to go as a sailor on board a ship belonging to the French India Company, bound for Bombay, in 1754. The French government, however, stepped in shortly afterwards, and furnished him both with money to purchase MSS., and with a pension, that he might pursue his studies with greater ease. He prevailed upon several of the dasturs, or learned priests, to introduce him into the mysteries of the holy language and rites, and further to sell him some of the most valuable works couched in it. When he considered himself sufficiently competent in Pehlvi and Zend, he commenced a translation of the whole Zend-Avesta in French, in 1759. Two years later, he returned to Europe; and having convinced himself, by a comparison with the Oxford MSS., that those he had acquired of the sacred writings were genuine, he went to Paris, where he deposited his treasures—180 MSS. in different oriental languages; and published, ten years after leaving India (1771), the first European translation of the Zend-Avesta, to which was added a great deal of supplementary matter, bearing more or less on the subject. The work created a profound sensation throughout Europe; but, after a while, voices began to be heard by no means so favourable as had been anticipated by the bold and persevering discoverer. Apart from the objections raised against the new book by Immanuel Kant the philosopher, on the score of its not containing any traces of philosophy, a much graver question was ventilated in England—viz., that of its authenticity. It was not that Anquetil was charged with forgery, but the priests, it was said, had found in him a ready dupe. It was principally Sir William Jones, who, in a trenchant letter addressed to Anquetil-Duperron (in French, being, as Sir William Jones said, the only language which Anquetil understood—a little), tried to prove the utter untrustworthiness of the whole work. He was aided therein by Richardson, the Persian lexicographer, who, from four reasons—neither of which, however, is valid—came to the conclusion that the book was a spurious fabrication. While in France there was but one opinion on the subject—viz., that English scholars were trying to run down the work out of sheer spite and jealousy—the opinions of Germany were rather divided. Some, like Meiners and Tyohsen, fully acceded to the proofs arrayed against it; but there arose another renowned German scholar, Klenker, who, in token of his complete and unreserved trust in the genuineness, set about translating Anquetil's

French translation into German, adding several appendices, &c., and principally pointing out the now generally recognised agreement between the more important heads of the doctrines as contained in the book and in the classical writers. Thus matters stood for a long while. In Germany, Anquetil's translation, as rendered by Klenker, became the standard work even for the theologians; in England, none any longer thought about it, it having been fully agreed upon by the highest authorities that it was nothing but a clumsy forgery. More than fifty years had elapsed from the appearance of that work, when a Dane, Rask, undertook to look into the matter. Having himself acquired many Zend and Pehlvi MSS. in Bombay for the Copenhagen library, he wrote (1826) a pamphlet, in which he first shewed not only the close affinity between the language of the Zend-Avesta and Sanscrit—which had been pointed out by Erskine and others before—and further proved it to be, not a corruption of Sanscrit, but a distinct language. He also proved that modern Persian was derived from Zend, as Italian from Latin—a step which at once removed all doubts about the genuineness of the work, and confirming, however, how, to a certain extent, Anquetil, to whom all praise was due for having been the first pioneer, had, through the absence of the requisite philological aids, been occasionally misled in his version in the most woeful manner. The learned dastur himself—with whom Anquetil communicated only in Persian—though well acquainted with the Parsee traditions, and favouring mostly the general sense of the passages, yet possessed no grammatical knowledge whatsoever of the language he pretended to teach. Rask had pointed out the way; Eugène Burnouf followed it. He indeed may be called the founder of Zend philology. For more than twenty years, this eminent scholar devoted all his energies to elucidating, commenting, and discussing this language and the sacred writings couched in it, and in publishing texts and translations. In Germany, Olshausen, Bopp, Müller, Brockhaus, Spiegel, Haug; in Copenhagen, Westergaard, have been busy ever since in editing and translating either portions of or the entire Zend-Avesta; and though the rediscovery of the language is by no means an accomplished task, yet, thanks to their indefatigable labours in this field, we are certain that, sooner or later, we shall be in the full possession of all the facts connected with the language and its sacred depository, the Zend-Avesta.

We now address ourselves to the book itself. We know, both from the Parsee traditions and from independent classical witnesses, that the Zend-Avesta was originally of very vast extent, incomparably vaster than the work that now exists under that name. Pliny speaks of 2,000,000 verses composed by Zoroaster; and an Arabic writer, Attavari, mentions the number of 12,000 cowkins (parchments) of which Zoroaster's writings consisted. No doubt these are but round Eastern figures; but it may safely be assumed that the sacred literature in question must once have been of very great extent. The Parsees ascribe its loss to Alexander the Great, but it is more likely that their traditions in that respect refer to the Mohammedan conquests. Yet even then, the greater part of the sacred literature was already lost, and the date of Alexander may in so far be correct, that the Greek ideas that followed in his wake turned the believing minds from the primitive faith, and carried a gradual neglect and loss of the documents in which it was contained, with it. For 600 years—from the Macedonian conquest, 335 B.C. to the accession of the Sassanians to the throne of Iran, 235 A.D.—the Zoroastrian religion was not supported by any kings, and decayed in

consequence. But when the Sassanians assumed the rule, their principal endeavours were directed to the revival of the ancient faith; and their unceasing researches after the ancient fragments of the Zoroastrian gospel have resulted in the small collection which we now possess. Yet the names and the summaries at least of all or most of the lost portions have survived. The whole scripture is reported to have consisted once of 21 nooks, or parts, each containing Avesta and Zend—that is, text and commentary on it. The number 21 was to correspond to the 21 words of which the most sacred prayer of the Zoroastrians (the *Honovar*) was composed. The first of these sections comprised 33 chapters, containing the praise and worship of angels; the second (22 chapters) contained prayers and instructions to men about good actions; the third (22 chapters), an explanation of religious duties and commandments, and the way to avoid hell and acquire paradise; the fourth (22 chapters), knowledge of both this and the future worlds and their inhabitants, revelations concerning heaven, earth, water, trees, fire, men, and beasts, the resurrection of the dead, and the passing of the bridge *Chinvat*; the sixth (35 chapters) treated of astronomy, geography, astrology; the seventh (22 chapters), of food, lawful and forbidden; the eighth (50 chapters, of which, at the time of Alexander, only 13 were extant) treated of the different heads or chiefs in the creation; and the ninth (in 60 chapters) contained a code of laws for kings, governors, &c.—also a portion about the sin of lying; the tenth (60 chapters) treated of metaphysics, natural philosophy, divinity, &c.; the eleventh (60 chapters) treated of the reign of King *Gustasp*, and his conversion to the religion, and its propagation by him through the world; &c. Of all the 21 nooks, however, one only, the twentieth (in 22 chapters), called the *Vendidad*, has survived complete. This treats of the removal of uncleanness of every description, from which great evils arise in the world. Some fragments of the other parts only, chiefly the fourth and eleventh, have survived. But there are now in sacred use among the *Parsees* other books either not included in the foregoing list, or but imperfectly indicated in it. Of the former are the *Yazna* (*Izeshne*) and the *Visparad* (*Visporatu*). To the latter class belong 24 sections called *Yashts*, and some small prayers of different kinds, such as *Afrigan*, *Nijayish*, *Gâhs*, and *Sirozak*, or *Calendar*. Before speaking of these books, we shall say something about their authorship, for which point we further refer to *ZOROASTER* (q. v.). By the unanimous consent of both classical writers and the Persians, the whole bulk of the sacred literature is ascribed to Zoroaster himself. They were supposed to be the substance, or, as was held afterwards, the very words of divine revelations from God to the prophet, in the form of conversations. These revelations do not at first appear to have been committed to writing, but to have been orally preserved by his disciples and adherents, and to have been handed down by them to posterity. Surprising as this may seem at the sight of what has remained, as the infinitely larger bulk even of what has perished, it must be borne in mind that, e. g., the Vedas, the Talmud, and the *Sunnah* have been preserved equally faithfully in the mouths of many generations. The name Zoroaster or Zarathustra—in as far as to him is ascribed the authorship of the whole of the sacred writings—is to be taken collectively rather than individually, i. e., as indicating a school of successors and high-priests of the founder, who is designated Zarathustra *Spitamâ*; while the chief divines who took his place in after-times were only called

Zarathustra. That their decisions and sayings were afterwards 'hedged in' with the same reverence as those of the founder himself, need not be argued at length. All that can really be held to emanate from the prophet himself are the five *Gâthas*, which form part of the *Yazna* (Sansc. *yajna*, sacrifice). This *Yazna* consists principally of prayers to be recited at the sacrificial rites—such as the consecration of the *Zôthra*, or holy water; of the *Barepona*, or bundle of twigs of a particular tree; the preparation of the sacred juice of a plant called *homa*—the Indian *SOMA* (q. v.)—taken to be an emblem of immortality; the offering of certain cakes; &c. The whole of the *Yazna* now comprises 72 chapters, probably corresponding to the (twelve times six) 'seasons' during which *Ahuramazda* created the world. It consists apparently of two parts belonging to different periods. The older is written in what Haug calls the *Gâtha* dialect (see *ZEND*), and was considered sacred even at the time when the other books of the *Zend-Avesta* were composed. This 'older *Yazna*' was divided again into the *Gâthas* and some minor pieces. The former, five in number, are small collections of (metrical) sacred prayers, songs, and hymns, exhibiting philosophical and abstract thoughts about metaphysical subjects. The name itself signifies 'song.' Their metre resembles chiefly that of the *Vedic* hymns. They are without rhymes, and only the syllables are counted. The first bears the heading (which is also intended for the other four), 'The Revealed Thought, the Revealed Word, the Revealed Deed of Zarathustra the Holy; the Archangels first sang the *Gâthas*.' They are all more or less devoted to exhortations on the part of the prophet to forsake polytheism (the *devas*, or gods), and to bow only before *Ahuramazda*. The difference between monotheism and idolatry is pointed out in the respective sources whence they flow—viz., 'existence' and 'non-existence.' The mission, activity, and teaching of Zoroaster are dwelt upon more or less in all *Gâthas*, but chiefly in the second. To the other portion belongs further the '*Yazna* of seven chapters,' which seems to have been composed by early disciples, and which consists of prayers in prose, addressed to *Ahuramazda*, the angels, the fire, the earth, the waters, and other spiritual beings—genii presiding over the different parts of the good creation; further, over devotion, speech, &c. There is further a chapter containing a formula by which the ancient Iranians were received into the new religious community. The so-called younger *Yazna*, written in the common *Zend* language, is of more varied contents, such as, an invitation to *Ahuramazda* and all the good spirits to be present at the sacrifice; further, pieces referring to the preparation and drinking of the *homa* juice; next, the praises of the genius *Seroash*, and a commentary on the most sacred prayers. The *Visparad*, which forms the next most important part of the *Zend-Avesta*, contains a collection of prayers, composed of 23 chapters, written in *Zend* (not *Gâtha*), and resembling the younger *Yazna*. They refer to the same ceremonies—the preparation of the sacred water, consecration of certain offerings, &c. Next are to be considered the *Yashts*, in 24 divisions. *Yasht* (*yésti*) means worship by prayers and sacrifices, and in the *Avesta* indicates certain laudations of sacred persons and objects—*yazatas* (*izad*) = angels; and in so far different in nature from the invocations in the *Yazna* and *Visparad*, that, while in the latter the divine beings are invited promiscuously, the single *Yashts* are addressed to individual numina, such as the archangels, the sun, the heavenly water, the star *Tisfrya*, &c. In these songs—the work of Median bards, probably—are also found the primary



sources of the legends contained in the *Sháh-námeh* (q. v.). Before speaking of the *Vendidad*, the 'Pentateuch' of the Zoroastrian 'canon,' we shall yet briefly mention some smaller pieces, which are now used as common prayers by the Parsees, such as the five *Niyáyahs*, or praises, addressed to the sun, the moon, the water, and the fire; the *Afrigáns*, or blessings to be recited over a certain meal prepared for an angel or a deceased person; the five *Gáhs*, or prayers to the angels set over the five different times of the day and night; and finally, the *Sirozah*, or thirty days, being a calendar, or rather an enumeration of the thirty divine beings that preside over each of the days. It is chiefly recited on the thirtieth day after the death of a man. The *Vendidad*, to which we now turn, is the code of religious, civil, and criminal laws of the ancient Iranians. It consists of 22 chapters or fargards = sections. It seems to have survived in a fragmentary state only, and is evidently the work of many hands and many centuries. It appears as if, starting from old sayings in the *Avesta*, the Iranian high-priests in various periods had interpreted them often at variance with each other: these their interpretations (*Zend*) were made the theme of further interpretations (*Pázend*), and the three phases of interpretation were received in the course of time as equally authoritative among the faithful. There are three parts to be distinguished in the *Vendidad*. The first is introductory, containing an enumeration of 16 Aryan countries over which the Zoroastrian religion was spread; further, legends of King Yuria, and recommendations of agriculture. The second part (chaps. 4—17) forms, as it were, the groundwork of the *Vendidad*, treating of laws, ceremonies, and observances. The third part is a kind of appendix, treating of various subjects, chiefly of a medical kind, such as spells against diseases, &c. Here also ought to be mentioned the *Bundahesh*, written entirely in Pehlvi, which seems a compilation of several extracts and fragments of partly ancient, partly recent Zoroastrian writings, forming a sort of compendium or dogmatic handbook of Zoroastrianism. For an account of the latter, we refer to GUBREES, PARSEES, and ZOROASTER.—Burnouf, *Vendidad-Sadé*; Olshausen, *Vendidad Zend-Avesta*—French translation by Anquetil-Duperron, German by Klenker; Spiegel (the German text, with Spiegel's commentary, retranslated into English by Bleek); Rask, *Alter und Aechtheit der Zendsprache*; Haug, *Essays*; &c.

ZENG-G, SEN J, or SEGNIA, an important fortified seaport town of Austria, in Military Croatia, on the Adriatic, 71 miles south-east of Trieste, at the termination of the Josephine Road, opposite the island of Veglia. Z. is the see of a Roman Catholic bishop, has a tolerably large and elegant cathedral, an upper gymnasium, a seminary for priests, an academy, and school of navigation; a small harbour (free), somewhat unsafe; and some trade in grain, honey, wax, wine, salt, tobacco, wood, fish, and cattle. Pop. (1869) 3496.

ZENITH, a word, like *Nadir* (q. v.), borrowed from the Arabic, is the name given to that point of the heavens which is directly overhead, i. e., in line with the spectator's position and the centre of the earth. It is thus the upper pole of the spectator's horizon, as the nadir is the under pole. The word would seem to be connected with the Arabic *san*, a 'point.'

ZENJA'N, a populous and thriving town of Persia, in the province of Irak-Ajemi, about 170 miles north-west of Teheran, and 70 miles south-south-west of the Caspian Sea, on the table-land of Azerbaijan, at the junction of the roads from Hamadan

and Teheran to Tabriz, on a tributary of the Kizil-Ouzen, which flows into the Caspian. It is surrounded by orchards, has old walls, a palace, a mosque, bazaars, and a trade in carpets, woollen cloths, arms, lead, and gunpowder. Pop. estimated at 15,000.

ZENO, a philosopher of Elea, a town of Lucania, in Italy, was a favourite disciple of Parmenides. He visited Athens, and the illustrious Pericles was one of his pupils. According to the account usually given, on his return to Elea, he joined a conspiracy to deliver his native town from the tyrant Nearchus, and on the failure of his plot, was captured, and put to the torture. On being interrogated as to his accomplices, he named the principal courtiers, and is said to have bit his tongue off, and spat it in the tyrant's face. However, the historical evidence for this account is unsatisfactory; and whether Z. perished in his attempt or survived the tyrant, is uncertain. He held the usual doctrines of the Eleatic school respecting the unity and the immutability of all things, distrust in knowledge acquired through the senses, and reliance on pure reason. He did not deny that there were phenomena or appearances, but he maintained that these were not real existences. In this he anticipated the Berkeleyan theory. But he is chiefly remarkable for having been the first to employ the style of argument known by the name of Dialectics, in which error is refuted, and truth sought to be established, by the *reductio ad absurdum*—a method so skillfully employed afterwards by Socrates and Plato. He devoted his great powers of argumentation to enforce the doctrines first broached by Xenophanes, and more systematically developed by Parmenides. His works were in prose, but only small fragments have been preserved.

ZENO, founder of the Stoic philosophy, was born at Citium, in Cyprus. The dates of his birth and death are uncertain. He flourished in the early part of the 3d c. B.C., and was a contemporary of Epicurus. His father was a merchant, and on his trading voyages brought home with him from Athens some writings of the Socratic school. By these, Z. is said to have been attracted to the study of philosophy. At the age of 30, he was shipwrecked off the coast of Athens, and having lost his property, he willingly adopted the Cynic doctrines, in which contempt for riches is conspicuously taught. He attached himself first to Crates, but soon became dissatisfied with the coarse, ostentatious disregard for established usages, and the indifference to speculative inquiry, which characterise the Cynic sect. He next joined the school of the Megaric Stilpo, and there became a proficient in the art of disputation. Still unsatisfied, he betook himself to Polemo the Academician. Having thus made himself master of the tenets of the various schools, he proceeded to open a school for himself, wherein he might shew forth the result of all his inquiry, and develop his own peculiar system. See STOIC. He selected for the purpose the 'Painted Porch' (*Stoa Poikile*), from which his sect has got its name, and there, till his 98th year, as is said, continued to teach those doctrines, which, in spite of serious drawbacks, inculcate that manly energy and simplicity, fortitude under suffering, and reverence for moral worth, which made disciples of so many of the noblest characters among the Romans. As a man, Z. deserved and gained the highest respect. The Athenians honoured him with a gold crown and a public burial, and his countrymen erected a monumental pillar to his honour. Of his numerous writings, scarcely anything remains save the titles.

ZENO'BIA, queen of Palmyra, succeeded (267 A.D.) her husband Odenatus, who had been acknow-

ledged by Gallienus as his colleague in the Roman Empire. Nearly the whole of the eastern provinces submitted to her sway. When Aurelian assumed the purple, he marched against her with a large army, and after defeating her in several battles, besieged her in Palmyra. Her hopes of being relieved by the Persians and Arabians being disappointed, she attempted to escape by flight, but was captured, 273 A.D. Before the conqueror, her courage failed, and she saved her own life by imputing the blame of the war to her counsellors, especially the celebrated Longinus, who was accordingly put to death. Z. was led in triumphal procession at Rome, decked with splendid jewels, and almost fainting under the weight of gold chains. She was presented by her conqueror with large possessions near Tivoli, where, in the society of her two sons, Heronnius and Timolaus, she passed the rest of her life in comfort and even splendour. She was a woman of great courage, high spirit, and strikingly beautiful. With purity of morals in private life, she combined prudence, justice, and liberality in her administration. Her literary acquirements were considerable; she spoke Latin and Greek, as well as the oriental languages, with fluency. The balance of authority is said to be in favour of the belief that she was attached to the Jewish faith.

**ZENTA**, or **SZENTA**, a town of Hungary, in the county of Bacsa, on the right bank near the Theiss, 120 miles south-south-east of Pesth, in a beautiful plain. Cattle-breeding is carried on. Pop. (1869) 19,938. It is celebrated for the victory of Prince Eugene over the Turks in 1696.

**ZEOLITE** (Gr. *zeo*, to boil), the common name of a large group of minerals, often called the Zeolitic family. They receive this name from their melting before the blowpipe. They are all soluble in acids, and most of them gelatinise in acids in consequence of silica being set free. They are hydrated silicates of alkalies or alkaline earths, most of them containing alumina. Magnesia is rarely present in them. Their composition, however, is very various. They are generally found in amygdaloidal cavities, or in fissures of trap and other Plutonic rocks, as granite and gneiss, apparently as deposits from water percolating through the rock. They sometimes, but rarely, occur in veins. They are found either in crystals or of crystalline structure, often in plates or fine scales, often in needles or fibrous. Among them are *Analcime*, *Natrolite* or *Mesotype*, *Scolecite* or *Needle-stone* (*Needle Zeolite*), *Stilbite*, *Heulandite*, *Brewsterite*, *Apophyllite*, *Chabasite*, *Harmotome* or *Cross-stone*, and *Laumonite*. The number of species and varieties which have been described and have received distinct names, is very large.

**ZEPHANIAH** (the name probably signifies a 'watcher of the Lord'), a Hebrew prophet who flourished during the reign of Josiah, in the latter part of the 7th c. B.C. The subject-matter of his brief 'prophecy' is the temporary desolation of Judæa ('I will utterly consume all things from off the land,' i. 2), on account of the infidelity and worldliness of the inhabitants, Jerusalem being specially assailed by the author for her filth and pollution; the tyranny and the rapacity of her rulers, and the violence and treachery of her priests and prophets. At the same time the prophet predicts the destruction of the surrounding heathen nations, the Philistines, the Moabites, Ammonites, Ethiopia, and Assyria. The close, in which he declares that God will leave a righteous remnant in Israel, and for their sakes will ultimately bless the land with permanent peace, is couched in a strain of tender exultation.

**ZERBST**, capital of the former duchy of Anhalt-Zerbst (See ANHALT), a town of North Germany, in the duchy of Anhalt, 10 miles north-west of the town of Dessau, and 68 south-west of Berlin, is situated on a level sandy spot on the river Nuthe, a tributary of the Elbe. In place of the ancient walls, promenades now encircle the town. Close by is a beautiful large palace, the ducal residence. The town has four Protestant churches, a Roman Catholic one, and a synagogue. The church of St Nicholas is a beautiful specimen of Gothic architecture. The town is the seat of a court of justice; has a high school, called the Francisceum; female, industrial, and other schools; a house of correction, and orphan asylum, hospitals, and a workhouse. The chief manufactures are articles in gold and silver, silk, wax, soap, stone-ware, carriages. There are many breweries, whose produce is exported in large quantities. The vegetable products are considerable, and the culture of hops is carried on. Handsome baths have been erected over a mineral spring recently discovered here. Pop. (1871) 11,995.

**ZEULENRODA**, a town of the German empire, in the principality of Reuss-älterer-Linie, 10 miles west of the town of Greiz, and 51 south-south-west of Leipzig, stands on a high plateau, in a wooded hilly district. Z. has suffered severely at various times from conflagrations, and is now regularly built, consisting of a handsome town and four suburbs. It has a spacious market-place with a beautiful court-house, two churches, a burgher and free school, and a hospital. Besides some bleach-works and a trade in cattle, there are manufactures of woollen goods, especially hosiery, the fineness of which is famous. Pop. (1871) 6892.

**ZEUS** (Sansc. *div*, light, *djau*, heaven, *devas*, god; Lat. *Ju-piter* and *Dies-piter*, i. e., Father Zeus; Ang.-Sax. *Tiu*, whence Tuesday) was the greatest of the national deities of Greece. According to the most received mythology, he was the son of Cronos and Rhea, brother of Poseidon and Hera, the latter of whom was also his wife. He expelled his father and the older dynasty of the Titans; assumed the sovereignty of the world, and successfully resisted the attacks of the giants and the conspiracies of the gods. In the allotment of the world, after the dethronement of the Titans, Z. gained the rule of heaven and air, Hades of the infernal regions, and Poseidon of the sea; while the earth was left subject to the influence of all three, though Z. was regarded as having the supremacy throughout all departments. Crete, Dodona, and Arcadia were the places where the worship of Z. was most cultivated; and although originally the inhabitants of these places may not have looked upon themselves as worshippers of the same god, yet, in process of time, all the local gods revered under the name of Z. were at last merged in one great Hellenic divinity; a process which was carried still further out when he was identified with the Jupiter of the Romans and the Ammon of Libya.

Besides the epithets of Z. from the seats of his worship, he had many titles applied to him from his various powers and functions, moral and physical. He was the father and king of gods and men; the protector of kings, of law and order; the avenger of broken oaths and of other offences; he watched over the state, the assembly, the family, over strangers and suppliants; his hand wielded the lightning and guided the stars; he ordained the changes of the seasons, and, in short, regulated the whole course of nature. All prophecy, too, was supposed to originate in him, and it was from him the prophetic god Phœbus received his oracular

gift. He dispensed, as it pleased him, both weal and woe to mortals; but whether he could control the Fates themselves, is a point about which the ancients disagreed, as men have done in all ages where the question of free-will and fate is concerned. Of the many epithets applied to Z., perhaps the best known is the Olympian, from that Olympus in Thessaly whose summit was believed to be his residence as well as that of the other gods. His most celebrated festival was the Olympic, held at Olympia, in Elis, after the end of every fourth year.

Combined with such exalted conceptions of the majesty and power of Z., we find many stories current respecting his amours with mortals and immortals; he is represented as acting with caprice, anger, deceit. Probably, in many cases, an ancient Greek of average position and capacity did not view such matters with any very strong feeling of disapprobation. Others, again, as Xenophanes (q. v.), protested against the transference to the gods of human passions and failings; or, as Pindar, maintained that they would believe nothing of the gods that was discreditable to them; or, as Euripides, argued that such tales were sufficient to disprove their divinity; or, as Euhemerus, held that the local worship of Z., like that of other deities, was owing to the fact, that divine honours were paid to deified men at the place of their burial, and that of course it was no wonder to find human actions assigned to gods who had once been human. In modern times, the various myths were at one time explained as symbolical of various celestial and terrestrial phenomena, such as the apparent motion of the sun, the alternation of day and night, the changes of the seasons, and so forth. The most rational explanation is as follows: In early times, men thought and spoke of natural objects as if they were personal agents, employing names for them which were literally, not symbolically significant. But from lapse of time, and the departure of various tribes from their original seats, in many countries the meaning of these words became obscured, and though men still used them, their real significance was forgotten, and terms which originally had expressed some process of nature, were conceived to narrate some incident in the history of a person. For example, the expression that the sun follows the dawn, was misunderstood, and gave rise to the myth of Phoebus pursuing the nymph Daphne, because the word Daphne was no longer understood. Such misconceptions were then, by successive ages, elaborated into myths, more or less fanciful, and even revolting. In this respect, Z. has fared no better, or rather much worse, than the other deities. In the same way as the Greek war-god Ares is a personage much inferior to the Latin Mars, so the serious and unimaginative Roman's conception of his majestic Jupiter Optimus Maximus (the best, the greatest), was more elevated than that conceived of Z. by the sensuous Greek. But this might be expected from the different character of the two peoples. Except in the grander attributes of omnipotence and fatherly care of the universe, we can trace little in common; for the Jupiter of the Latin poets, as portrayed in Virgil and Ovid, is drawn entirely from Greek sources, and is merely the Z. of Greek mythology with an altered name.

ZEUXIS, the celebrated painter, was born at Heraclea, probably the city of that name in Lucania. He is also styled of Ephesus, which means that he belonged to the Ionian school of painters. He flourished in the latter part of the 5th c. B. C., and was at Athens about the beginning of the Peloponnesian war. He excelled in the treatment of light and shade, in accuracy of imitation of natural objects, and in expressing the perfection of human,

and particularly female beauty. This last he effected by selecting the finest models he could find for each separate part. His most famous pictures were 'Zeus enthroned, with the Gods standing round;' 'Helen;' 'The Infant Hercules strangling the Serpents;' 'The Female Hippocentaur.' By the exercise of his art, he attained to great riches and fame, and like his rival Parrhasius, was exceedingly conscious of his pre-eminence. He repeatedly presented rather than sold pictures to cities that were anxious to possess them, because he thought no money-price could pay for them. Greece was plundered of many of his masterpieces by her Roman conquerors; and one of the noblest, the 'Hippocentaur,' was lost on the passage to Rome. Designs on vases, sarcophagi, and other works of antiquity exist adorned with representations of the same subjects as Z. painted, and probably were imitated from his productions.

ZEYST, a large village in the Netherlands, province of Utrecht, is surrounded by beautiful well-wooded estates and country-seats, the summer residences of many of the first families of Amsterdam. The industries are making soap, candles, and vinegar, brass and zinc founding, &c. On a rising ground, and surrounded by fine old trees, stands the Dutch Reformed church, built in 1180. There is also a Roman Catholic church. In 1746, a society of Moravian Brethren settled at Z., where they have built a separate quarter, consisting of public and private buildings, erected along the sides of two large grassy squares, called the Easter Plain and the Wester. Besides the church, there is an excellent day and boarding-school, which is resorted to by children of parents belonging to various Protestant communions. The unmarried members live, the males in the Brothers' House, the females in the Sisters' House. Another building is set apart for widows. There are also family residences, workshops, and warehouses. In 1870, the pop. of Z. numbered 5440; in 1875, 5547.

ZIERIKZEE, an old and important town in the Netherlands, province of Zeeland, is situated in the south-east of the island of Schouwen. It was fortified before the beginning of the 11th c., and owed its rise and prosperity to the shipping-trade and fishing. The walls have been levelled, planted with trees, and formed into shady walks. Z. has two havens, the old and the new, two Dutch Reformed churches, a Lutheran, a Roman Catholic, a small dissenting church, and a Jewish synagogue. There are a grammar-school, school of design, and other excellent public schools maintained by the town. The principal means of living are trade in agricultural produce, shipping, ship-building, fishing, weaving calicos, beer-brewing, drying madder, sawing wood, grinding corn, &c.

Z. suffered severely in the contests between Flanders and Holland for the possession of Zeeland. In 1303, the Flemings besieged it with a large army, but were compelled, by Count William of Holland, to retire, on the 10th of August 1304. In the long war of independence, after an obstinate defence, the Spaniards took Z. on the 2d of July 1576. Pop. (1870) 7834; in 1875, 8043.

ZIGZAG, in Military Science, a trench of approach against a fortress; so constructed that the line of trench may not be enfiladed by the defenders. See SIEGE.

ZIGZAG, a decoration characteristic of the Norman style of architecture. It consists of one or more mouldings running in zigzag lines, and is used with great effect. The zigzags are employed in great profusion, and are sometimes undercut so as to be detached from the mouldings.

**ZILLEH** (ancient *Zela*), a town in Asiatic Turkey, in the pashalic of Sivas, about 30 miles west-south-west of Tokat. It is built on a height, with a small flat conical hill in the centre of the town, which is evidently the mound or road, of which another portion is still seen at Thyana, the construction of which was attributed to Semiramia. Scarcely any remains of antiquity are to be found here; an ugly fortress of the middle ages having usurped the place of its beautiful temple. This was the field of Julius Cæsar's battle with Pharnaces, of which he wrote 'Veni, vidi, vici.' There are several large khans, and manufactures of coarse cottons. Its annual fair, of 15 or 20 days, from the middle of November, is often frequented by 40,000 or 50,000 persons from the commercial towns of Asiatic Turkey. There are about 2000 houses, the population being almost entirely Turkish.

**ZILLERTHAL**, one of the principal valleys in the Tyrol, traversed by the Ziller, is about 50 miles long. Towards the south and south-west, it is bounded by lofty glaciers; but towards the north, where it opens into the valley of the Inn, it is tolerably fertile. Among the eight secondary valleys are the Duxerthal—famous for its precipitous glaciers, 1200 feet high—and the Zemthal, both remarkable for several great waterfalls. The inhabitants of the Z., who number about 14,000, are celebrated even in the Tyrol for their handsome, well-built figures; and their fine Alpine songs are well known and appreciated in London and Paris. The chief wealth of the Z. is derived from the rearing of cattle. About 5000 head of cattle are exported yearly; but, notwithstanding, the valley is not able to support its numerous population. Many of the men hire themselves out as servants for the summer, while others go about as pedlars, selling essences of herbs and gloves, of which 10,000 pair are made yearly. The principal town is Zell. For some years, the valley has been much visited by artists, chiefly from Munich.

In recent times, the inhabitants of Z. acquired considerable notoriety by a part of them leaving the Roman Catholic Church, and emigrating. For a considerable time, they had been in the habit of reading the Bible, and were on friendly terms with the Protestant Church, although still attending the Roman Catholic service; but when, in 1826, the Catholic clergy began to enforce auricular confession with greater strictness, a number of them thought seriously of going over to the Protestant Church. Ere long, they not only objected to the confessional, but to the worship of the saints, absolutions, masses for the soul, purgatory, &c. In 1830, they began to leave the church; and by 1832, the number of dissenters had amounted to 240. The Emperor Francis, to whom, on his visit to Innsbruck in 1832, they addressed a petition regarding their religion, promised them toleration; but after considerable delay, they were told (1834) that they must either return to the Catholic faith or remove to Transylvania, where there were Protestant congregations. As the Zillerthalers could not agree to this, they formed the resolution, as the Protestants of Salzburg had once done, of seeking a refuge in Prussia. This was granted; and the Zillerthalers, who had been allowed by the Austrian government to sell their property, set out, August 1837, for Prussia. In all, 399 men, women, and children arrived, 2d October, at Schmiedeberg, in Silesia, where they were to stay until the arrangements for their reception in Ermannsdorf were completed. The king gave them 22,500 thalers (£3375) on their settlement, and (1839) made them a further grant of 12,500 thalers (£1875) for a church and school. The colony

received the name of Z., and is divided into Upper, Middle, and Lower Zillerthal.—See *Geschichte der Zillerthaler Protestanten* (Nürnb. 1838); Rheinwald, *Die Evangelischgesinnten in Zillerthal* (4 Aufl., Berl. 1838).

**ZIMB**, a dipterous insect, exceedingly destructive to cattle in Abyssinia, as the *Tæte* (q. v.) is in more southern parts of Africa. It probably belongs to the same family, but this has not yet been ascertained. It is supposed to be the *Zebub* of the Hebrew Scriptures (Is. vii. 18). Bruce describes it as very little larger than a bee, but thicker in proportion; the wings broader, and without colour or spot; the head large; the upper lip sharp, having at the end of it a strong pointed hair, a quarter of an inch long; the lower lip with two similar bristles. The flight of the insect re-



Zimb.

sembles that of the gaddy, and is attended with a peculiar buzzing. The Z. is found only where the soil consists of a rich black loam; but all the inhabitants of the sea-coast, along the southern shores of the Red Sea, and southwards beyond Cape Guardafui, are compelled to remove their cattle in the rainy season to the nearest sands, in order to prevent their destruction by this pest, as well as those of more inland districts from the mountains of Abyssinia northwards to the confluence of the Astaboras and the Nile. 'As soon as this plague appears, and their buzzing is heard,' Bruce says, 'all the cattle forsake their food, and run wildly about the plain till they die, worn out with fatigue, fright, and hunger.' The camel, the elephant, and the rhinoceros are liable to the attacks of the Z., as well as the ox; but the elephant and rhinoceros protect themselves by rolling in mud, which, when dry, coats them as a kind of armour.

**ZIMMERMAN**, JOHANN GEORG, a native of the town of Brugg, in the Swiss canton of Bern, in which his father was a senator, was born on the 8th December 1728. He was educated at home, in the first instance, and afterwards at Bern, preparatory to his going to the university of Göttingen to study medicine. This he did in the year 1747. By his countryman, the celebrated Haller, he was kindly welcomed; he became an inmate of his house, and had the advantage of his valuable aid in the prosecution of his studies. In these he displayed the utmost ardour, not content to confine himself to medicine, but aiming at a large and liberal culture. In his specialty, so great was the proficiency attained, that on his taking his degree of Doctor in 1751, he published a work entitled *Dissertatio Physiologica de Irritabilitate*, which not only at the time attracted attention by its originality of view, but even now is held to be not without value. In 1752, he began to practise as a physician at Bern with every prospect of success; but shortly after, the post of public physician falling vacant in Brugg, his native place, he was induced to transfer himself thither. About this time, he was married to a relation of his friend and preceptor, Haller. Despite the extensive practice he speedily acquired, with such a reputation for skill as brought patients from a great distance to consult him, he continued to cultivate other pursuits; and in 1756, he published a miscellany of prose and verse, remarkable as containing the first sketch of

his treatise *On Solitude*, which afterwards became so famous. In 1758 appeared his work on *National Pride*, an ingenious and able dissertation, which immediately became popular, and carried the name of the writer, by translation, into nearly every country in Europe. That he did not, however, neglect his special department of study was proved in 1763 by the appearance of an elaborate work on Experience in Medicine (*Von der Erfahrung in der Arzneikunst*; Zürich, 2 vols. 8vo). Of this, the great value was instantly recognised, and it still continues to enjoy some portion of its first reputation. Z. was now a man of European note; and among other advantageous offers made to him was that of the post of Physician to the king of Britain at Hanover, with the title of Aulic Councillor attached to it. This he accepted; and to Hanover he accordingly went in 1768. His repute as a physician continued here to increase, and from all quarters came flocks of people to have the benefit of his advice. In 1770, he had the misfortune to lose his wife; and this distress was complicated by an attack of an internal malady, which soon after obliged him to go to Berlin to undergo a perilous operation. This was successfully performed, but did not preclude a return of the complaint some time after. His only daughter now died; and a son who survived sunk under the influence of disease into something like entire idiocy. Z., who had almost from his very boyhood had to struggle against a constitutional melancholy, became now, as it almost seemed, a confirmed and hopeless hypochondriac. From this deplorable state he was rescued for a time by a second marriage, into which his friends persuaded him; and as fruit of his revived interest in life, he gave to the world, in 1784, his celebrated work *On Solitude* (*Ueber die Einsamkeit*; Leipzig, 4 vols. 8vo), a book which speedily became a popular favourite throughout Europe. In 1786, he was invited by Frederick the Great, then in his last illness, to attend him at Potsdam. On going thither, he found that the case of the king was beyond the reach of his art. He remained, however, for some time; and as the result of his sojourn, he published in 1788 and 1790, two works on Frederick the Great, the manifold indiscretions contained in which involved him in much painful and acrimonious controversy. In excuse of much in the books not easily to be defended, everything seems to shew that they were merely the first indications of a return of his constitutional malady in an aggravated, and, as it proved, a finally intractable and hopeless form. His melancholy hallucinations continued to grow upon him, till he was at length little better than a mere maniac; and on the 7th of October 1795, he died at Hanover. During these last sad years, he had continued at intervals to write and publish; but in everything thus produced there was evident the wreck of his once brilliant faculties. As a physician, a philosopher, a man of general accomplishment, and a writer of singular power and felicity, Z. was unquestionably one of the most remarkable figures of his time. Of Zimmerman on *Solitude* every one must needs have heard: it no longer retains the immense popularity it once had; but along with his more expressly medical treatises, which are of interest—if not very much now otherwise—in relation to the history and development of his profession, it must still continue for a time to perpetuate the name of its writer.—See *Z.'s Eigene Lebensbeschreibung* (Autobiography, Han. 1791); Tissot, *Vie de Z.* (Lausanne, 1797); Wichmann, *Z.'s Krankengeschichte* (Han. 1786).

ZINC (Zn, eq. 32.5—new system, 65—sp. gr. 6.8), or *Spelter*, as it is often called in commerce, is a hard bluish-white metal, lustrous externally, and when

broken, exhibits a foliaceous crystalline fracture. At ordinary temperatures, it is somewhat brittle; but when heated to above 212°, it becomes perfectly ductile and malleable, and may be drawn out into wire or beaten into thin plates. At about 400°, it again becomes so brittle that it may be easily pulverised. It fuses at 773°, and at a white heat may be volatilised; and if the vapour be exposed to the air, it burns very brilliantly, and is converted into oxide of zinc, which is deposited in copious white flakes. The temperature of its boiling-point is estimated by Deville at 1904°. On exposure to the air, zinc soon loses its metallic lustre, and assumes a gray appearance, in consequence of its surface becoming oxidised, while the metal beneath is thus protected from further change—a property which renders this metal especially useful for many economical purposes. It has no action on water at ordinary temperatures, but if a mineral acid be present, it readily decomposes water, and is employed to decompose the water of dilute sulphuric acid, when hydrogen is required. Moreover, a hot solution of potash acts on zinc, hydrogen being liberated, while oxide of zinc is formed and dissolved in the alkaline solution. Zinc precipitates from their solutions most of the electro-positive or basylous metals less oxidisable than itself.

This metal is never found in the native state; the chief ores from which it is extracted are noticed below.

The commercial zinc obtained by the ordinary methods of extraction usually contains a small quantity of lead, iron, and carbon, with occasional traces of arsenic and copper. In order to obtain it in a chemically pure state, a stream of sulphuretted hydrogen is passed through a slightly acidulated solution of sulphate of zinc, and after the removal of any precipitate that may be found, the solution is boiled so as to expel the gas, after which the zinc is precipitated in the form of carbonate, by the addition of carbonate of soda. The carbonate is converted by ignition into oxide of zinc, which must be distilled in a porcelain retort with the purest available form of carbon, as, for example, charcoal prepared from loaf-sugar.

Zinc is commonly regarded as forming only one compound with oxygen—namely, the *protoxide of zinc* (ZnO), although it has been suggested that the film which is formed upon the surface of metallic zinc by exposure is a sub-oxide. Protoxide of zinc is obtained by heating the metal in the air, the white oxide thus obtained being formerly known as *Lava philosophica*, from its woolly appearance; while it was known as *Flores zinci*, or *Flowers of Zinc*, in pharmacy. The process of manufacturing this oxide, when it is required as a pigment, consists, as Professor Miller remarks, 'in distilling zinc from clay retorts into chambers through which a current of air is maintained. The volatilised metal burns at the high temperature to which it is exposed under these circumstances; and the oxide is deposited in a series of condensing chambers.'—*Inorganic Chemistry*, 3d ed. p. 545. The pigment thus obtained is known as *Zinc White*. The impure oxide of zinc, commonly known as *Tutty*, is obtained from the flues of furnaces in which brass is melted. A hydrated oxide of zinc (Zn.HO) is precipitated in a white gelatinous mass from the solution of the salts of zinc by the addition of potash or soda, but redissolves in an excess of the alkali. Oxide of zinc is readily soluble in acids, and is capable of being reduced by charcoal, but not by hydrogen. The most important salts formed by oxide of zinc are the sulphate and carbonate. *Sulphate of Zinc*, or *White Vitriol* (ZnO.SO<sub>4</sub> + 7Aq), occurs in large transparent, glistening, four-sided

prismatic crystals, resembling those of Epsom salts. At a temperature a little below  $212^{\circ}$ , the crystals lose six equivalents of their water of crystallisation, and at a somewhat greater heat, they lose their last equivalent, and previously to losing their water of crystallisation, they fuse in it. This salt is readily soluble in water, requiring  $2\frac{1}{2}$  parts of the latter for its solution at  $60^{\circ}$ . It is obtained in considerable quantity as a residue in the process of obtaining hydrogen from dilute sulphuric acid and zinc; and it is prepared on the large scale by roasting and lixiviating zinc-blende or sulphide of zinc, which, when heated in the presence of air, is oxidised into the sulphate. *Carbonate of Zinc* ( $\text{ZnO}, \text{CO}_2$ ) constitutes one of the most important of the zinc-ores—viz., the common or rhomboidal variety of *calamine*, a name which is derived from the property which this substance possesses of adhering after fusion in the form of reeds to the base of the furnace. Carbonate of zinc may be artificially prepared by precipitating a salt of oxide of zinc with carbonate of soda, when the required salt falls as a white precipitate; this is, however, not simple neutral carbonate, but a basic carbonate, having the composition expressed by the formula  $2(\text{ZnO}, \text{CO}_2), 3(\text{ZnO}, \text{HO})$ . Of the haloid salts, the *Chloride of Zinc* ( $\text{ZnCl}$ ), formerly known as *Butter of Zinc*, is the only one requiring notice. This salt is obtained in the anhydrous form by burning zinc in chlorine gas, and in the hydrated state by dissolving zinc in hydrochloric acid, and evaporating the solution, chloride of zinc being thus formed, while hydrogen escapes in the gaseous form. In the anhydrous state, it forms a whitish-gray, semi-transparent mass, which fuses readily, and sublimes at a high temperature. When exposed to the air, it soon deliquesces, and is soluble in water in all proportions. The watery solution has a burning and nauseous taste, and in a concentrated state acts as a powerful caustic. It may be crystallised with 1 equivalent of water from its aqueous solution; and it is soluble in alcohol. It forms double salts with the chlorides of sodium, potassium, and ammonium; and a concentrated solution of the double chloride of zinc and ammonium ( $\text{H}_2\text{NCl} + \text{ZnCl}$ ) is much used for the purpose of removing the film of oxide from the surface of metals, such as zinc, iron, or copper, which are to be united by the operation of soldering.—Miller's *Inorganic Chemistry*, 3d ed. p. 546. With sulphur, zinc forms only one combination—viz., *sulphide of zinc*, or *blende* ( $\text{ZnS}$ ), which is one of the most abundant of the zinc minerals. Blende, when pure, is of a pale brown colour, but it is commonly blackish from admixture with sulphide of iron. It usually occurs crystallised in rhombic dodecahedra, or allied forms, but sometimes is found in the massive state. Sulphide of zinc may be obtained artificially as a white precipitate, which, on drying, becomes yellow, by the addition of sulphide of ammonium to a solution of a zinc-salt. Zinc forms several important alloys, amongst which *brass* (consisting of 2 parts of copper to 1 of zinc) and *German Silver* (q. v.) may be specially noticed. Professor Miller sums up the characters of the salts of zinc as follows: 'The salts of zinc are colourless; their solutions have an astringent, metallic taste, and act rapidly as emetics. They are distinguished by giving no precipitate in acid solutions with *sulphuretted hydrogen*, but they yield a white hydrated sulphide of zinc with sulphide of ammonium.'

*Manufacture*.—That the Romans were acquainted with the art of making brass—an alloy of copper and zinc—is proved by the analysis of some of their coins struck soon after the commencement of the Christian era. Yet zinc itself was not known in Europe as a distinct metal until Para-

celsus described its distinctive properties in the 16th century. Probably the Roman brass was produced by smelting ores containing both zinc and copper, some of which are at the present day smelted in Sweden. Zinc, however, was brought from the East by the Portuguese long before it became an article of commerce in Europe, and is supposed to have been known and made into articles of use and ornament both in India and China from an early period.

There are several ores of zinc, but only two of much importance—viz., blende and calamine. Blende, black-jack, or sulphuret of zinc, contains, when pure, about 67 per cent. of zinc, but, like most ores, it is rarely found pure. The usual composition of English blende is zinc 61, iron 4, and sulphur 33. It occurs in all the older geological formations, and is often associated with the ores of copper and tin, but most frequently with lead ore—occurring, of course, like these in veins. Blende crystallises in the form of the rhomboidal dodecahedron. The crystals have considerable brilliancy, but their lustre is waxy rather than metallic. In this country, it is usually of a dark colour, from the sulphuret of iron which it contains—hence the miners' name of *black-jack*. Sometimes it is sufficiently argentiferous to allow of the profitable extraction of the silver. Blende is found in Wales, Isle of Man, Cornwall, and Derbyshire. It is also found in a good many localities on the continent—Sweden, in particular, being rich in this ore.

Calamine, or carbonate of zinc, contains, when pure, 52 per cent. of zinc, but it varies much in the proportion of metal which it contains on account of impurities. Its primitive crystalline form is the rhombohedron, but calamine as well as blende occurs more frequently massive than in crystals. It is usually either of a dull yellow or reddish-brown colour. Like some other useful substances, calamine was formerly exported from England as ballast, through ignorance of its value. It was at one time raised to a considerable extent in Somersetshire, Derbyshire, and Cumberland, but it is chiefly the last county which produces it now. Belgium, Silesia, and Carinthia are well-known continental localities; and quite recently, most extensive deposits of it have been discovered on the north coast of Spain, which are estimated to last for ages.

Red oxide of zinc is found in New Jersey, U. S., where it is smelted. This is an oxide of zinc with a small quantity of oxide of manganese, which gives it its red colour. Silicate of zinc, or electric calamine, is another rare ore, generally associated when found with calamine. It is said to be smelted in the United States, and to yield very pure zinc.

There are several distinct processes for the extraction of zinc from its ores, and of these the English, the Belgian, and the Silesian are the most important. The English process is as follows: The zinc ore (blende or calamine) is crushed between rollers to the size of hazel-nuts, and then roasted for about twelve hours, with occasional stirring, in a calcining furnace. The furnace in which the roasted ore is reduced very much resembles a glass-furnace. It is either circular or octagonal in form, and usually contains six pots or crucibles, made of Stourbridge fireclay, about 3 feet high by  $2\frac{1}{2}$  feet in their widest diameter. In the bottom of each pot there is an opening, from which a sheet-iron tube, in two pieces, descends about 8 feet, and under its open end there is a sheet-iron vessel to receive the condensed zinc. Fig. 1 gives a sectional view of this furnace, and fig. 2 a view of one of the pots with its appendages on a larger scale. Zinc being volatile at high temperatures, is smelted by distillation, and in the English

process it is called distillation *per descensum*. An entire charge—that is, a charge for the whole six

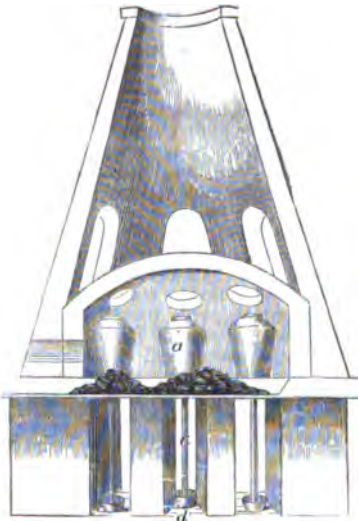

Fig. 1.

pots (a)—consists of one ton of calcined ore mixed with a proper quantity of ground coke. When the pots are charged, their covers are fixed and luted on, the conical portion of the descending pipe (b) being previously securely fixed and lined with fireclay. The hole in the bottom of the pot is plugged with wood, which becomes converted into charcoal by the heat, and is then sufficiently porous to allow the zinc vapour to pass down, while at the same time it stops the descent of the coke or ore. The heat of the furnace is gradually raised, and soon produces



Fig. 2.

is going on, as any leakage usually causes much loss of zinc. The *rough zinc*, as it is called, is removed from the pans, where it accumulates in lumps, and melted in cast-iron pots. It is then well stirred and skimmed, and finally cast into ingots or cakes of the ordinary commercial size—the skimmings being worked over again with a new charge of ore.

The Belgian furnace differs greatly in its construction from the English. It consists of from 60 to 80 small fireclay retorts, *a, a, a*, each about 3 feet 6 inches long, by 8 inches in diameter, and set

vapour of zinc in the pots, which condenses as it descends the pipes (c), and drops into trays (d) placed at the bottom of each pipe. Sometimes a tube becomes stopped by a lump of zinc, and when this happens, the furnace-man melts it with a bar of red-hot iron. It takes nearly three days to work off the above charge, which yields about 8 cwts. of zinc, and requires about 25 tons of coals for its distillation. It is necessary to watch the pots with great care while the process

in a series of rectangular compartments, filling up an arched chamber. Fig. 3 shows a transverse section of this furnace. There is a clay nozzle or condenser, *b, b, b*, attached to the front of each retort, and on the end of this nozzle there is a sheet-iron receiver, *c, c, c*, for the condensed zinc. The fireplace is shown at *d*, and *e* is the pit to collect the residue from the retorts. The retorts are charged with ground and roasted calamine, mixed with small-coal free from sulphur. As the upper retorts receive less heat than the lower ones, they are not so heavily charged, and they are, moreover, supplied with less pure ores. At the end of every six hours, the receivers are emptied of their melted zinc. In this process, a ton of ore can be smelted in 24 hours, and the yield from it is about 40 per cent of metallic zinc.

In the Silesian furnace, fireclay retorts, about 4 feet long by 1 foot 6 inches in diameter, are arranged in two rows, back to back, and placed horizontally on a flat furnace-bed, with a fireplace on a lower level running along between the backs of the retorts. A condensing apparatus comes away with a curve from the upper part of the front of each retort, and descends some 2 feet below it. From this, the zinc, on condensing, drops on the ground, or into a tray placed to receive it.

With regard to the comparative merits of these three processes of smelting zinc, no very decided opinion appears to be yet arrived at by those who have the best means of judging. The Belgian process consumes the least fuel, but requires the greatest amount of labour; the English, on the

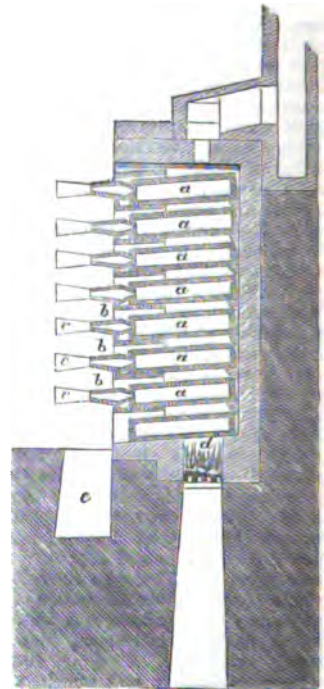

Fig. 3.

other hand, is worked with the least amount of labour, but requires the most fuel; whilst the Silesian holds a sort of middle position between those extremes. Each, however, has minor advantages and disadvantages which the others have not. All three processes are in use in England.

## ZINC.

Zinc, at ordinary temperatures, is a comparatively brittle metal; but about the beginning of the present century, it was discovered that, if heated to between 200° and 300° F., its malleability and ductility were so increased that it could be rolled with facility into thin sheets, or drawn into fine wire. Since this was known, the uses of the metal, which formerly was only employed along with copper to make brass, have become greatly extended. In sheets, it is used for roofing, baths, water-tanks, spouting, and the like; also for covering ships' bottoms instead of copper. A considerable quantity is consumed for name-plates, for engraving upon, and for galvanic batteries. Perforated sheets with various ornamental patterns are manufactured for screens, blinds, light fences, and similar objects. As a material for casting artistic works, zinc possesses the desirable properties of having a low melting-point, and of taking a sharp impression from the mould, so as to require but little labour from the chaser; it has also considerable hardness. It has, in consequence, become a favourite material on the continent for making casts of statues, statuettes, and different kinds of ornaments.

Of late years, zinc has been applied with great success to the coating of sheet-iron for roofing and other purposes, and also for coating various kinds of iron wire, especially telegraphic wire. See GALVANISED IRON.

We may remark here, that when zinc is exposed to a moist atmosphere, its surface becomes coated with a thin compact film of oxide or rust, which protects the metal beneath from further oxidation, whereas the rust of iron appears rather to penetrate the body of the metal with greater ease when it has once begun. Hence the value of zinc as a material for roofing, and also for protecting the surface of iron roofs.

The average annual produce of the zinc mines of the United Kingdom, for several years past, may be taken, in round numbers, at 15,000 tons of ore, yielding about 4000 tons of zinc, of the value of from £80,000 to £100,000, according to the market price of the metal, which has varied considerably. Our imports, in like manner, have amounted to about 15,000 tons annually of metallic zinc, the greater part of which came from Prussia, Belgium, and Holland.

Oxide of zinc is now employed to a large extent as a white pigment. It is of a purer colour than white lead, does not tarnish and blacken like it with sulphuretted hydrogen, and is much healthier for operative painters, but unfortunately it is deficient in body. It is also used as an ingredient in pottery colours. An impure sulphate of zinc, known as *white vitriol*, is also employed in various arts.

**Medical Uses.**—In its purely metallic state, zinc produces no effect upon the animal economy, but several of its compounds are very active medicines. As a matter of convenience, we shall consider these compounds alphabetically, beginning with *acetate of zinc*, a salt not considered in the article on the chemistry of this metal. It is obtained by dissolving, with the aid of heat, carbonate of zinc in a mixture of acetic acid and distilled water, filtering the liquid while still hot, and setting it aside to crystallise. In this process, the carbonic acid of the carbonate of zinc is displaced by the acetic acid, and escapes with effervescence. The salt is obtained in thin, translucent, and colourless crystalline plates of a pearly lustre, with a sharp unpleasant taste, soluble in water, from which it may be precipitated, pure white, by sulphuretted hydrogen, and evolves acetic acid when decomposed by sulphuric acid. The crystals contain 3 equivalents of water, and their composition is

represented by the formula,  $ZnO, O, H_2O, + 3Aq$ . Acetate of zinc is not much employed internally, but it is one of the most valuable local astringents, and is especially useful (in the form of solution of from 3 to 5 grains in an ounce of water) in the treatment of skin-diseases attended with much discharge, such as eczema, impetigo, &c., when the first inflammatory symptoms have subsided; and it forms a useful astringent in the milder form of ophthalmia. It was the active ingredient in Sir Astley Cooper's celebrated injection for gonorrhoea in the third week—six grains of sulphate of zinc mixed with four fluid ounces of dilute solution of subacetate of lead, when sulphate of lead is precipitated, and acetate of zinc is held in solution. When employed as an ointment in skin diseases, from 4 to 10 grains finely powdered may be rubbed up with cold cream or simple ointment. *Carbonate of Zinc* is obtained for pharmaceutical purposes by the decomposition of sulphate of zinc in solution and carbonate of soda, when the carbonate of zinc is precipitated as a white, tasteless, inodorous powder, insoluble in water, but soluble with effervescence and without residue in dilute sulphuric acid. This preparation has been introduced as a substitute for *native calamine*, which formerly had a high reputation, but was so frequently adulterated as to render an official salt of known composition very desirable. Either in powder, or in the form of ointment, it forms an excellent astringent application for the treatment of intertrigo (or chafing of the skin), excoriations, and chronic skin diseases attended with much discharge. *Turner's Cerate*, although not in the Pharmacopoeia, is in general use as a drying and healing ointment, and is one of the most popular remedies for superficial burns and sores. It is made by taking prepared calamine (or carbonate of zinc) and wax,  $7\frac{1}{2}$  ounces of each, and olive oil 1 pint. Melt the wax, and mix the oil with it, then remove them from the fire, and when the mixture begins to thicken, add the calamine, and stir constantly till they cool. *Chloride of Zinc*, in the form of colourless opaque rods, obtained by pouring the concentrated solution into proper moulds, is used in surgery as a powerful caustic in cases of cancer, fungous growths, &c. In toothache caused by caries, a minute portion of chloride of zinc introduced into the cavity of the tooth after the removal of the diseased parts, affords almost immediate relief. In consequence of its powerfully destructive properties, it should never be applied except by the surgeon. The solution of this salt, commonly known as *Burnett's Disinfectant Fluid*, is of much use in the sick-room or hospital ward as a deodorizing agent; as, however, it possesses strong caustic properties, great care must be taken that it is not administered internally in mistake for some other medicine. Few years pass without several fatal cases of this kind being recorded. *Oxide of Zinc* is characterised in the Pharmacopoeia as 'a soft, white, tasteless, and inodorous powder, becoming pale yellow when heated, and forming with diluted sulphuric acid a solution which gives a white precipitate with hydrosulphide of ammonia.' It is employed internally with much success as a tonic in chorea and epilepsy, in which it must be given for a considerable period, and in gradually increasing doses till a scruple is taken daily. In doses of one or two grains combined with extract of henbane, it forms an admirable night-pill to check the perspiration in pulmonary consumption. Employed externally, either in the form of powder or ointment it forms a good astringent in cases of excoriation, sore nipples, intertrigo, slight ulcerations, &c. The official ointment containing 80 grains to an ounce of simple ointment, is too strong for ordinary cases,



and is apt to *cake* upon the surface: these defects may, however, be removed by the addition of glycerine. Sulphate of Zinc is employed as an astringent, a caustic, an emetic, and a tonic. As an astringent, it is given internally in small doses (of from half a grain to two grains, made into a pill with conserve of roses), in cases of chronic diarrhoea, chronic bronchitis, and long-standing leucorrhoea; while it is used topically as a lotion in old ulcers (from 5 to 20 grains to an ounce of water), as a collyrium in chronic ophthalmia, and as an injection in the abortive treatment of gonorrhoea (i. e., when we wish to cut short the disease before inflammatory symptoms appear). As a caustic, this salt, in its anhydrous state, and finely levigated, was strongly recommended by the late Sir James Simpson. He applied it in the form of powder; of a paste made with glycerine in the proportion of a drachm of the latter to an ounce of the powder; or of an ointment consisting of two drachms of prepared lard, rubbed up with an ounce of the powder. It has also been successfully used in the Dublin hospitals. Sulphate of zinc may be given in the same doses as the oxide as a tonic in cases of nervous palsy, and in the exhaustion dependent upon sexual excesses. In large doses, as from 15 to 30 grains, it operates as a safe and speedy emetic, and is preferable to all other emetics in cases of poisoning. In toxicological researches—as in Marsh's *Test for Arsenic*—great care must be taken to see that the zinc which is employed is perfectly free from arsenic, which is a not uncommon impurity.

ZINCOGRAPHY is essentially the same art as Lithography (q. v.), zinc-plates being substituted for those of stone. One form of the art is described under the name of Anastatic Printing (see PRINTING). A style of it, called Pencilography, brought forward by Gillot of Paris for the purpose of reproducing, by lithographic, autographic, or typographic proof, any drawing with crayon or stump, or any engraving from wood or copper, is thus described: A plate of zinc finely polished is prepared, and if an original drawing is to be copied, it is done by the artist in lithographic crayon on this plate; autographic writing done with the crayon, lithographs, and fresh proofs of wood or copper-plate engravings, must be transferred in the usual way to the surface of the plate; and whilst still wet, an ink-roller is passed over, so as to give a deeper impression. Rosin very finely powdered is then sifted over, which adheres to the wet ink, and becomes consolidated, so that the superfluous powder is easily brushed off from the parts not covered with ink. The plate is next placed with its face upwards in a shallow trough containing dilute sulphuric or hydrochloric acid sufficient to slightly cover it; the trough is then gently rocked, so as to make the acid flow backwards and forwards over the plate, and if this be continued for some time—an hour or upwards—all the parts of the plate not covered with the ink and rosin are etched deep enough to be used as a relief-plate for printing from. In impressions where there are large interspaces, it is usual to saw them out; and in some cases, where it is found that the relief is not sufficiently high, the raised parts are re-inked, and again covered with the rosin, and submitted a second time to the action of the acid. Old engravings may be transferred by laying them to become damp on a board wetted with acidulated water, and then applying the ink-roller to the face of the engraving; the ink only acts upon the ink-lines of the engraving, and is repelled by the acid moisture which has been imbibed by the uncovered white spaces. A slight pressure will then easily produce a copy on the polished zinc-plate, which is perfected by the subsequent operations.

ZINGEL (*Aspro*), a genus of fishes of the perch family, remarkable for the elongated form of the body, and for having the mouth situated under the projecting and rounded snout, also for the roughness of their scales. The dorsal fins are widely separated, and the ventral fins are large. Only two species are known: of which one, the Z of the

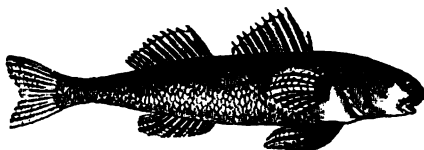

Zingel (*Aspro vulgaris*).

Danube (*A. zingel*), inhabits that river and its tributaries, attains a length of fifteen inches, and a weight of two or three pounds; the other (*A. vulgaris*) is found in the Rhone and its tributaries, and also in more eastern rivers, although unknown in those of the west of France, and is only six or seven inches long. Both are esteemed for the table.

ZINGIBERA'CEÆ. See SCITAMINÆ.

ZINZENDORF, NICOLAUS LUDWIG, COUNT VON, the founder of the existing sect of the Moravian Brethren, or Herrnhuters, was born at Dresden, 26th May 1700. His father, a Saxon state minister, dying while Z. was a child, the latter was educated by his grandmother, a learned and pious lady, the Baroness von Gersdorf. Spener, the head of the Pietists, was a frequent visitor at her house, and his conversation, and the devotional exercises in which Z. took part, influenced his character while a mere child. In 1710, he went to Halle, where he spent six years, under the special care of Francke, the philanthropist. Z. founded among his fellow-pupils a religious society, to which he gave the name of the 'Order of the Grain of Mustard-seed.' In 1716, he was sent by his relatives to Wittenberg, where Pietism was in less repute than at Halle; but he adhered to his early religious impressions. Two years afterwards, he travelled through Holland and France, everywhere endeavouring to convert the distinguished persons whom he met to his own religious views. On his return to Dresden, he was appointed a member of the Saxon state council, and married the sister of the Count Reuss von Ebersdorf. But political life was little to his mind, and he returned to his country-seat in Upper Lusatia. While residing there, he accidentally met a wandering carpenter, named Christian David, a member of the old sect of Moravian Brethren, of whom some still remained in Moravia, professing the doctrines taught by John Huss. David described the persecutions to which the sect were exposed; and Z. invited him and his friends to settle on his estate. They accepted the proposal, and the colony received the name of 'Herrnhut.' Z. acted with great liberality to the settlers, and their success attracted much attention. In 1734, Z. went under a feigned name to Stralsund to pass an examination in theology, and was ordained a minister of the Lutheran Church. In 1736, he was banished from Saxony, on a charge of introducing dangerous novelties in religion. He repaired to Holland, where he founded a Moravian colony, and afterwards to Esthonia and Livonia, where he also founded colonies. In 1737, at the request of King Frederick-William I. of Prussia, he was ordained Bishop of the Moravians. In the same year, he went to London, where he was received with much consideration by Wesley. In 1741, he went to North America, accompanied by his daughter, and

founded the celebrated Moravian colony of Bethlehem. The Herrnhuters, in the meanwhile, by their good conduct and industry, had won the respect of all classes in Saxony, and in 1747, Z. was allowed to return to Herrnhut. Having received authority by act of parliament to establish Moravian settlements in the English colonies of North America, he returned thither to do so. He finally settled at Herrnhut; and his first wife being dead, married Anne Nitschmann, one of the earliest colonists from Moravia. He died on 9th May 1760. Thirty-two preachers, from all parts of the globe, accompanied the coffin to the grave. Z. was the author of more than 100 works in verse and prose. His hymns, used in worship by the Moravians, are objectionable on account of their pious indecency. The same may be said of his sermons, especially of those which refer to the Holy Ghost as a spiritual mother. His writings are often incoherent or mystical, but they abound with passages in which deep and original thought is expressed with great clearness and beauty.—A Life of Z. has been written by Varnhagen von Ense, published in his *Biographische Denkmale* (Berlin, 1830).

**ZION.** Mount Z. is the name of the hill on which the south-west part of Jerusalem, the City of David, or Upper City, with the citadel of David, stood. At the present day, only the north half belongs to the city, the city wall running obliquely over the hill. On the west, and still more on the south side, it descends steeply into the Vale of Hinnom, to a depth of 300 feet. Mount Z. is 2537 feet above the level of the Mediterranean Sea. With the prophets and poets of the Old Testament, Z. often stands for the whole of Jerusalem (also called 'Daughter of Zion'), particularly in reference to the Temple. See JERUSALEM.

**ZIRCONIUM** (symb. Zr, equiv. 44.8—new sya. 89.6) is the metallic constituent of the earth *zirconia*, which is found in association with silica in the minerals *zircon* and *hyacinth*. The composition of zirconia is usually represented by the formula  $Zr_2O_3$ , but Swanberg regards zirconia not as a pure earth, but as a mixture of three; and to one of the metals, whose earths he thinks that he has isolated, he gives the name of *Norium*. The sources from which zirconium is derived are so few (it being found only in Ceylon, one district of the Ural, and Southern Norway), that it is unnecessary to enter into any details regarding it.

**ZIRKNITZ, or CZIRKNITZ, LAKE** (Ger. *Czirknitzersee, Lacus Lugens* of Strabo), a small lake of Austria, in Carniola, about 20 miles south-south-west of Laibach, and 30 miles east-north-east of Trieste, is situated in a deep valley to the south of Mount Javornik, and to the north-east of Mount Slivnza. The lake is about 5 miles long, and between 2 and 3 broad, is surrounded with numerous villages, chapels, and castles, contains four small islands—on the largest of which is built the hamlet of Ottok—and has no surface outlet. It is about 56 feet deep in the deepest part, and is very irregular in shape. It is worthy of notice only on account of the very remarkable phenomenon of the occasional disappearance of its waters for several weeks, and even months, during which the bottom is often covered with luxuriant herbage, which the peasants make into hay; sometimes also they manage even to sow and reap a small crop of buckwheat in its deserted bed. The waters, however, are not perfectly regular in their disappearance—indeed, sometimes for five or six years together they have not retired at all—but generally they drain off in the end of August, and return, if the season be wet, in five or six weeks. It takes between 20 and 25 days to

empty the lake, but the return of the waters is sudden and unexpected, its basin being refilled sometimes in 24 hours. The phenomenon is accounted for by the nature of the bed of the lake. It is composed of limestone, and, like all the Carniolic plateau, is full of deep fissures and caverns, through which the waters disappear at irregular intervals, returning when the rain sets in. Some of these openings are 50 feet deep, and the chief ones are known to the peasantry by particular names. They communicate with subterranean reservoirs, penetrating the interior of the surrounding mountains, through which the waters are replenished or drawn off. There are 12 of these openings which discharge water into the lake as well as draw it off, and 28 which draw it off only. Through the former of these the water pours in after rainy weather as from a spout. When the surface of the lake reaches the caverns of Velka-Karlanza and Malka-Karlanza, the waters are discharged by these into the valley of St Canzian, and, after disappearing several times, fall into the Unz, above Planina. Sometimes, however, the volume of water is so great that these caverns prove insufficient to carry it off, when the lake overflows and covers the neighbouring country, sometimes submerging villages. In 1834, the lake was drained in January, and remained perfectly dry till the end of February 1835, a circumstance without parallel since the time that any records of its history have been kept. The lake is pretty well stocked with fish, and at certain times is the resort of great numbers of waterfowl, which afford both sport and profit.—There is a small village of the same name on a small stream that falls into the north side of the lake.

**ZISKA,\* or ZIZKA, JOHN**, of Trocznov, the famous leader of the Hussites, was born at Trocznov, in the circle of Budweis, Bohemia, about 1360. His family being noble, he became a page to King Wenceslas of Bohemia, but his gloomy and thoughtful temperament unfitted him, while yet a mere boy, for the frivolous occupations about court; so, embracing the career of arms, he served as a volunteer in the English army in France, and afterwards joined King Ladislas of Poland with a body of Bohemian and Moravian auxiliaries, and greatly distinguished himself in the war against the Teutonic Knights, deciding the dreadful battle of Tannenberg (in which the Grand Master and 40,000 knights were left dead on the field) by desperate charges at the head of his contingent. High honours were heaped upon him by the king; but the war (in which Z. had lost his right eye) being now over, his restless spirit led him to join the Austrians against the Turks, and subsequently the English against the French; and returning to Bohemia soon after the murder of John Hus (q. v.), he became chamberlain to King Wenceslas. Z. was an adherent of the Hussite doctrine; and the tragical fate of its apostles, and the tyrannical cruelties exercised by the imperial and papal officers on its adherents, excited in his mind the liveliest indignation and resentment. A widespread sentiment of a similar kind, originating as much from patriotic as from religious feelings, existed in the kingdom; and a powerful party was soon formed, which urged upon the king a policy of resistance to the decisions of the Council of Constance. Z. soon became prominent among the leaders of this party, and his personal influence with the king gained for it the latter's sanction to offer

\* It is often stated that John of Trocznov was called Z. on account of his being 'one-eyed,' but this is erroneous; Z. was the name of the family for generations before his time, nor does it signify 'one-eyed' in either the Bohemian or the Polish language.

resistance, though the king's vacillating disposition incapacitated him from giving effect to his own honest convictions, and taking open part with his subjects against their oppressors. After the outbreak at Prague (30th July 1419), in which the violent behaviour of the Catholics was avenged by the precipitation of 13 magistrates from the council windows, Z. was unanimously chosen leader of the Hussites, and the first great religious conflict of Germany was commenced in earnest. The shock produced by news of this outbreak was fatal to Wenceslas, and his death gave more of a political character to the contest, as when his brother, the Emperor Sigismund (the same who had allowed his safe-conduct to Huss to be violated), attempted, by advancing an army of 40,000 men into the country, to obtain the throne, his project was frustrated for a time by the Hussites, who insisted on their religious and political liberties being secured, and totally defeated his army with a hastily levied force of not more than 4000. On the retirement of the imperialists, Z. completed his conquest of Bohemia by the capture of the castle of Prague in 1421 (the town had been taken in the spring of 1420), and secured his hold of the country by the erection of fortresses, chief of which was that of Tabor, whence his party derived its name of *Taborites* (q. v.). The varied experience acquired by Z. in foreign warfare was now of immense service to his party; his followers were armed with small firearms (then little known); and his almost total deficiency in cavalry was compensated for by the introduction of the *Wagenburg* (or 'cart-fort,' constructed of the baggage-wagons), to protect his little army from the charges of the mail-clad knights. Numerous other inventions and ingenious contrivances mark Z.'s brief career as leader of the Hussites, and shew his eminent qualities as an engineer and a general. In 1421, he lost his remaining eye at the siege of the castle of Rabi; but though now totally blind, he continued to lead on his troops to a succession of victories almost unexampled in history—the list of 13 pitched battles fought by him, always with much inferior force, including only one defeat, and that so much resembling a drawn battle, that his opponents dared not molest his retreat. His greatest achievements were the rout (18th January 1422) of Sigismund's second invading army, which was driven into Moravia, and 2000 men of it drowned in attempting to escape across the frozen Iglau; and his great victory at Aussig, over the German crusading army, commanded by Frederick the Warlike of Saxony, and the Elector of Brandenburg. In the latter conflict, the furious onset of Z.'s troops was steadily sustained by the Saxons, who were choice troops, and the fanatic Hussites recoiled in astonishment at a successful resistance which they had never before encountered. Z., apprised of the circumstances, approached on his cart, thanked his men for their past services, adding, 'and if you have now done your utmost, let us retire.' Thus stimulated, they made a second charge still more furious than before, broke the Saxon array, and left 9000 of it dead on the field. Sigismund was now convinced that the conquest of Bohemia was impossible, and after a time proposed an arrangement with the Hussites, by which full religious liberty was allowed; and Z., who had an interview with the emperor on the footing of an independent chief, was to be appointed governor of Bohemia and her dependencies. But the war-worn old chief did not live long enough to complete the treaty, for, while besieging the castle of Przbialav, he was seized with the plague, and died, 12th October 1424. He was buried in a church at Csaalav, and his iron war-club was hung up over his tomb. A foolish story was long current that, in

accordance with Z.'s express injunctions, his skin was flayed off, tanned, and used as a cover for a drum, which was afterwards employed in the Hussite army; in order that even when dead he might be a terror to his enemies.

The only accusation which can with justice be made against Z. is on the ground of excessive cruelty, the victims being the monks and priests who fell into his hands. It would have been extremely curious if Z. had not laid himself open to such a reproach, for the burning alive of the propagators of the faith to which he adhered, the atrocious cruelties practised on such Hussite priests as fell into the hands of the imperialists, and the seduction of his own favourite sister by a monk, were events ill calculated to induce him to moderate the hatred entertained by himself and his followers against their opponents. The war was carried on mercilessly by both parties, and it was unreasonable to expect that the party assailed, and the one numerically weaker, should first set an example of moderation.

**ZITTAU**, a town of Saxony, 48 miles east-south-east of Dresden, and 69 by railway, is situated near the Bohemian frontier, close to the junction of the Neisse and Mandau. The town is well built, and is surrounded by a double wall; has many churches, the most notable of which is the Byzantine Church of St John, finished in 1836; a splendid court-house, one of the finest in Saxony, erected 1844; a good library of 12,000 vols.; a gymnasium, a normal, a free, an industrial, a Catholic, an infant, and other schools; several charitable institutions—as a work-house, infirmary, asylum for orphans, &c. Z. is the centre of the linen and damask manufacture of Saxony. There are also woollen manufactures, bleachfields, dye-works, paper, oil, and saw mills, and iron-foundries. Its position on the railway into Bohemia led the Prussians to make it a centre of operations during the war of 1866. Pop. (1875) 20,417.

**ZLATOU'ST**, or **KLIUCHI** (Golden Mouth), a town of Russia, in the government of Orenburg, among the Ural Mountains, about 150 miles north-east of Ufa, on the river Ufa. It consists chiefly of wooden houses, and the inhabitants are mostly miners. It is the centre of the iron and gold mines of the district. There is an extensive manufactory of sword-blades, which are considered the best in the empire; other articles of inlaid and embossed steel are also manufactured. Pop. 15,000.

**ZMEINOGO'RSK**, or **ZMIEF**, a town of Siberia, in a mountainous district of the government of Tomsk, upwards of 350 miles south-west of the town of Tomsk, on the river Smievka. The town is situated in the vicinity of one of the most productive silver-mines in Siberia, which was discovered in 1736, and belonged to the Demidoff family till 1745, when it became crown property. Since its discovery, it has yielded nearly a half of all the silver produced by the Siberian mines. Pop. 5990.

**ZOAR**, a village in Ohio, U. S., on the Ohio Canal, 90 miles E.N.E. of Columbus, settled in 1817, by a German community, 'The Society of Separatists of Z,' who hold in common 9000 acres of land; they have a woollen factory, mills, a store, church, school, and other social and industrial establishments, all managed by trustees, elected by popular vote. Pop. in 1870, 328.

**ZO'BO**, a hybrid between the Yak (q. v.) and the common ox of India. It is not very unlike an English ox. It is common in the western parts of the Himalaya, and is valued as a beast of burden, as well as for its milk and its flesh.

**ZO'CLE**, or **SOCLE**, a square plain plinth under the base of a column.

ZODIAC (Gr. *zodiakos*, commonly derived from *zōon*, an animal), the name given by the ancients to an imaginary band extending round the celestial sphere, having as its medial line the ecliptic or apparent path of the sun. It was fixed at about 16° in width, for the purpose of comprehending the paths of the sun and of the five planets (Mercury, Venus, Mars, Jupiter, and Saturn) which were then known; and as, of these planets, Mercury has by far the greatest inclination of orbit to the ecliptic, and the value of that element in his case is only 7° 0' 9", the width given to the zodiac was amply sufficient for the required purpose. But when the career of planetary discovery commenced in the beginning of the 19th c., the first three which were discovered (Ceres, Pallas, and Juno) at once destroyed the idea which had been long seated in men's minds, that no planets existed beyond the limits of the zodiac, by exhibiting orbits inclined to the ecliptic at no less angles than 10° 36¼', 34° 42¾', and 13° 34'; and a large number since observed have been found to wander from 0° to 18° beyond the zodiac, from which circumstance they have, along with the three above mentioned, been denominated *ultra-zodiacal* planets. The stars in the zodiac were grouped into 12 constellations, to each of which 30° or ¼th of the whole circle, was assigned, though it often did not fill up that space, but was only situated in it; and this equable division into *signs* was of great advantage in defining the positions of the sun and planets at any epoch.

The constellations, with the appropriate symbols of the corresponding signs, are as follow :

Aries ( <i>Ram</i> ) ♈	Libra ( <i>Balance</i> ) ♎
Taurus ( <i>Bull</i> ) ♉	Scorpio ( <i>Scorpion</i> ) ♏
Gemini ( <i>Twins</i> ) ♊	Sagittarius ( <i>Archer</i> ) ♐
Cancer ( <i>Crab</i> ) ♋	Capricornus ( <i>Goat</i> ) ♑
Leo ( <i>Lion</i> ) ♌	Aquarius ( <i>Water-bearer</i> ) ♒
Virgo ( <i>Virgin</i> ) ♍	Pisces ( <i>Fishes</i> ) ♓

As one half of the ecliptic is to the north, and the other to the south of the equator, the line of intersection of their planes is a diameter of each, and the two points in which this line meets the celestial sphere are known as the equinoctial points. The comparative immobility, with respect to the ecliptic, of these points, suggested at once the employment of one or other of them as a point from which to reckon, and accordingly that point at which the sun crosses the equinoctial from south to north was fixed upon, and called the first point (or commencement) of Aries. After the sun had advanced eastward through this sign—i. e., 30° along the ecliptic—he entered the sign of Taurus, continuing his course onward through the others in the order in which they are given above, again crossing the equinoctial southwards at the point where he emerged from Virgo, and entered Libra. This was the case with the sun during the time of Hipparchus (q. v.), but though the equinoctial points move very slowly, yet they do so with great uniformity, and the westerly motion of 50" annually which they describe along the ecliptic, has at the present time separated the sign Aries from the constellation Aries, and caused the former to correspond almost to the constellation Pisces. This gradual retrogression of the signs through the constellations of the zodiac will continue till they accomplish, in about 25,868 years, a complete circuit; after which period the sign and constellation of Aries will coincide, as they did in the time of Hipparchus. Neither the zodiac nor its constellations are of much use now in astronomy, except as, like the other constellations, affording an easy though somewhat fantastic nomenclature for the stars, and a rude, but sometimes convenient mode of reference to their positions.

The porticos of the temples of Denderah and Esne in Egypt, have representations of the zodiacal constellations, which are of great antiquity, and have formed a fruitful theme of discussion. M. Dupuis, in his *Origine des Cultes*, has, from a careful investigation of the position of these signs, and calculating precession at its usual rate, arrived at the conclusion that the earliest of them dates from 4000 a.c. This conclusion is controverted by M. Fourier, in his *Recherches sur les Sciences, &c. de l'Egypte*, who makes the representations at Esne 1800 years older than the other; but his hypothesis has been in turn overthrown by MM. Ideler and Biot. The truth seems to be that nothing is as yet definitely known respecting these ancient representations; for the manner in which the investigations have been mixed up with the Biblical question of the antiquity of man, has prevented any truly scientific research. The Greeks would seem to have borrowed their constellations from the Egyptians and Babylonians, and this is corroborated, to some extent, by occasional remarks in Greek writers as to the positions of various constellations at certain times, which positions are inconsistent with the supposition of the observer being in Greece. The zodiacal figures of the Hindus, ancient Persians, Chinese, and Japanese have such a remarkable resemblance to those of the Egyptians, that there can be little doubt as to their common origin.

ZODIACAL LIGHT is the name given to a singular appearance seen after sunset or before sunrise, at all seasons of the year in low latitudes, but rarely in this country, except in March, April, and May in the evenings, and six months later in the mornings. It is obviously due to illuminated (partly, perhaps, self-luminous) matter surrounding the sun in a very flat, lenticular form, nearly coinciding with the plane of the ecliptic, or rather with the sun's equator, and extending to a distance from the sun greater than that of the earth, since its apex is often seen more than 90° from the sun. It seems to have been first distinctly pointed out by Cassini, and was long regarded as the sun's atmosphere. This idea, however, is totally irreconcilable with mechanical principles; since, to assume so flat a form, in spite of the enormous attraction of the sun, and its own elasticity, an atmosphere would have to revolve with a velocity so great as to dissipate it into space. The only conceivable explanation of the phenomenon is, therefore, to be found in supposing it to consist (like the rings of Saturn) of an immense assemblage of small coamical masses, rocks, stones, and pieces of metal, such as are continually encountering the earth in the form of aërolites or meteorites. For the dynamical stability of such a system, it is only necessary that each fragment should separately describe its elliptic orbit about the sun. The mutual perturbations of the system, on account of the enormous mass of the sun, will be exceedingly small, except in the case of actual collision; but some of the planets will have a considerable effect upon it. That this is the true explanation of the phenomenon, is now generally believed. Some very curious recent observations on the August and November meteorites of 1866 (see METEORS in SUPP., Vol. X.) have shewn that these bodies move in orbits almost exactly the same as those of two known comets. The comet, then, is merely that portion of the ring of small masses, revolving all nearly in the same orbit, where the greatest number are, for the time, collected: and it is possible that to the collisions, which must most frequently occur where the separate particles are most numerously grouped, are due the spectral phenomena of incandescent gases which have been observed in the heads of comets by Huggins and

others. Such speculations, were this the place to pursue them, might easily be extended to the sudden production, and changes of form, of the tails of comets which occur near perihelion, for there the separate masses must necessarily be much more crowded together, and their impacts must be increased both in number and violence.

**ZOETROPE.** See SUPP., Vol. X.

**ZOILUS**, a grammarian, born at Amphipolis. Authorities vary respecting the age in which he lived, and the manner of his death. The usual account is that he lived in the time of Ptolemy Philadelphus, and that he solicited, but without success, the patronage of that monarch. He gained notoriety for the bitterness with which he attacked Homer, whence he was surnamed *Homeromastic*, Homer's Scourge. His name is used proverbially for an austere and malignant critic, as Aristarchus is for one candid and intelligent. All his works are lost.

**ZOLLVEREIN** (Ger. meaning 'customs-union'), a union of different independent German states, under the leadership of Prussia, so as to enable them, in their commercial relations with other countries, to act as one state. When, after the war of liberation in 1815, the political union, destroyed by the downfall of 'the holy Roman Empire,' had been restored to a certain degree in the German 'Bund' (see GERMANY), internal commerce was felt to be trammelled and depressed by the collection of revenue at the frontiers of every petty state; nor was it possible, without united action, to carry out the policy in regard to foreign commerce which might be thought best for protecting and developing the native trade and manufactures. The first suggestion of such a union came from Prussia; but it took many years before an actual beginning was made, and still longer before it reached its ultimate extent, as the plan was opposed for a long time by the jealousies and special interests of many of the states.

From 1819 to 1828, only some of the minor principalities enclosed within the Prussian territories had been got to conform to the Prussian commercial system; but in 1828, Hesse-Darmstadt, and in 1831, Hesse-Cassel, gave in. This was followed, in 1833, by the accession of Bavaria, Wurtemberg, the kingdom of Saxony, the principality of the same name, Schwarzburg, and Reuss; and in 1835—1836, by that of Baden, Nassau, and Frankfurt-on-the-Main. The adhesion of Hanover did not take place till 1851, of Oldenburg till 1852. When in 1868 Lübeck and the two duchies of Mecklenburg had joined the Z., its territory extended over the whole of what subsequently became the German empire, with the exception of Hamburg, Bremen, and a small part of Baden near Schaffhausen. The Reichsland of Alsace-Lorraine was incorporated in 1871. The imperial constitution of April 16, 1871, recognises and ratifies the privilege of the free ports so to remain until 'they themselves demand admittance within the common customs-boundary.'

The principle of the Z.'s action was this: The whole territory embraced by the Union formed commercially (in regard, at least, to countries beyond its limits) one state. The duties on exports, imports, and through-transports were collected at all the frontiers of the Union according to a uniform tariff (subject to some concessions, made on special grounds, to individual states); and the proceeds, after paying the expenses of collection, were divided among the members of the Union in proportion to their several populations. In regard to the internal trade of the Union, as the duties on articles manufactured for home consumption were different in the different states, a complicated system of drawbacks came

into play, in order to put the commerce of all on an equal footing.

The treaty of union was agreed upon for a definite period of years, and was renewed from time to time; as in 1842, 1853, 1865, 1867. In the latter year, much was done to simplify the relations of the various states to one another in respect of internal trade; and the administration of the Z. was so modified as to give to the various members of the Union votes in its council and parliament proportionate to the number of inhabitants in each state.

Since the establishment of the German empire, the Z. has no longer a separate constitution of its own. Its council (representing governments) is merged in the Federal Council of the empire; its parliament (representing populations) in the Reichstag. Affairs are managed on the principles adopted by the Z. in 1867, by permanent committees of the Federal Council—viz., those for customs and taxes, for trade and commerce, and for finance.

The net income of the Z., which in 1834 amounted only to 12,178,761 thalers, had risen in 1871, the last year in which the Z. had separate accounts, to 28,000,002 thalers (above £4,000,000).

**ZOMBOR**, a royal free town of Hungary, on a plain about 120 miles south of Pesth, capital of the district of Bacs, near the Francis Canal. It has handsome county buildings, Greek and R. C. churches, gymnasium, barracks, town-house, &c. There is a brisk trade in grain and cattle. Pop. (1869) 24,309.

**ZONURIDÆ**, a family of saurian reptiles, having the head covered with regular polygonal shields, the body and tail with large scales; the sides furnished with a longitudinal fold of the skin, covered with small scales; the tongue flat, nicked at

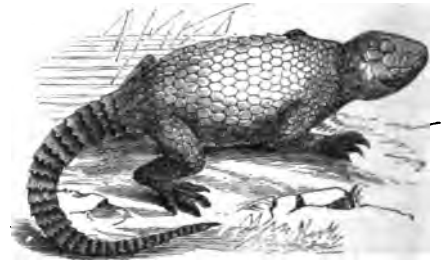

Zonurus.

the tip, the eyes with two valvular lids. The species are numerous, natives of warm climates. The form of some is rather short and thick, others are long and serpent-like. In some also, the limbs are well developed, in others they are merely rudimentary, and in some the very rudiments of them are entirely concealed under the skin.

**ZOOLOGY** (Gr. *zōon*, an animal, and *logos*, a discourse), the science which has for its subject the Animal Kingdom (q. v.). This science, itself a branch of Natural History (q. v.), is divided into a number of branches, which are often pursued as distinct sciences, the subject being too large to be thoroughly studied except in this manner; although it is also necessary that the results of investigation in particular departments should be brought together, so that the animal kingdom may be viewed as a whole, and the relations of the most widely different groups of animals to each other determined. The number of species of animals is far greater than that of plants, and the diversity among them is also greater, so that a division of the science of Z. into branches relating to different groups, very naturally takes place. Thus, the branch of Z. which has the

*Mammalia* for its subject has been called *Mazology* (Gr. *mazon*, a teat), an unhappily chosen and essentially incorrect term, which has not come into general use; and it is a curious circumstance that this, which may be called the highest branch of Z., has no popularly received name. It is otherwise with the branches of Z. relating to the inferior classes of *Vertebrata*; that which has *Birds* for its subject is universally known as *Ornithology* (q. v.); that which relates to *Reptiles* is *Herpetology* (q. v.), and the subordinate branch relating to serpents is sometimes called *Ophiology*; that which relates to *Fishes* is *Ichthyology* (q. v.). Among *Invertebrate animals*, the great group of *Mollusca* is the subject of the science of *Malacology* (q. v.), although this term is not in such general use as some of those already mentioned; and when shells rather than the animals which bear them are considered, the term *Conchology* (q. v.) is employed. No particular term is commonly applied to the branches of Z. which treat of the *Crustacea*, *Arachnida*, &c.; but that which relates to *Insects* is universally known as *Entomology* (q. v.), and the term *Helminthology* (q. v.) is employed to designate that which has *Worms* for its subject. No similar terms are used for the branches of this science which relate to other groups of *Invertebrata*.

The science of Z., however, divides itself into distinct sciences, not only in accordance with the divisions of the animal kingdom, but also with regard to particular branches of the subject which may be studied either in relation to animals generally, or to any particular species. Thus, *Anatomy* (q. v.) may be regarded as a branch of Z., when the term Z. is taken in its largest sense, as including man along with the inferior animals, and *Ethnology* (q. v.) must in like manner be considered as belonging to it. The anatomy of the inferior animals is sometimes called *Zootomy*, and the term *Comparative Anatomy* is employed when their structure is studied in relation to that of man, and the structure of one division of the animal kingdom in relation to that of the others. *Physiology* (q. v.) is one of the most important branches of Z.; and with it that branch of chemistry which treats of animal substances is closely connected. A very interesting branch of Z. is that which relates to the habits and instincts of animals. It can hardly be said to have been constituted into a separate science, but has received much attention from those naturalists who have devoted themselves to the study of particular groups of animals.

We have no evidence that the study of Z. was prosecuted to any considerable extent before the time of Aristotle. In his hands it became at once a science, and the foundations of a system of classification were laid. No artificial system of classification has ever been proposed in Z., like the sexual system of Linnæus in botany; but from the very first to the present day, a natural grouping of animals has always been attempted. To this, the widely marked distinctions between the principal groups almost unavoidably led. Aristotle brought to bear upon the subject the highest powers both of observation and of generalisation, and some of the groups established by him still retain their place in the most modern systems. Aristotle divided the whole animal kingdom into two great sections, the highest, *Enaima*, consisting of animals having blood (i. e., red blood), and the lower, *Anaima*, of animals having a colourless fluid instead of blood, the former corresponding to the *Vertebrata*, and the latter to the *Invertebrata* of modern zoologists.

No other ancient writer deserves much notice in a historic sketch of zoology. Ælian and Pliny shew no capacity for the scientific treatment of the subject, and in their writings, facts are largely mingled with fables. During the middle ages, Z., like other

kindred sciences, was almost completely neglected. For many centuries, the only name worth mentioning, in connection with the history of the science, is that of Albert, Count of Bollstädt, commonly called Albertus Magnus; whose knowledge, however, was entirely derived from Aristotle and other ancient authors, and all he did was merely to call attention to the forgotten science, without making any contribution to its advancement. From his time, in the first half of the 13th c., to the beginning of the 16th, Z. was again almost completely neglected; but the new activity of mind which then displayed itself soon sought this as well as other directions, and an impulse was more especially given to Z. as well as to some other branches of science, by the progress of geographical discovery; curiosity being awakened with regard to the strange productions of the New World, and of the eastern and southern regions, till then equally unknown. The names of Belon (q. v.) and Rondelet (see SUPPLEMENT) are the two greatest in this department at this period, and by them Z. was enriched with many new facts, while attempts were also made at a more perfect classification. Aldrovandi (see SUPPLEMENT) and Gesner (q. v.) soon followed them, besides others who began to direct their attention more specially to particular branches of Z., some of whom greatly extended the science by their observations on the animals of newly discovered countries. It was not till after the middle of the 17th c., however, that any real progress was made in classification, founded upon a philosophical study and comparison of animals. The works of Ray (q. v.) are described by Cuvier as 'the foundation of modern zoology.' The materials, however, were in great part prepared, and the first outline of a system sketched by Willughby, the friend of Ray, whom Ray long survived, and whose works he edited. From the days of Aristotle, Z. had never been prosecuted with such acuteness of observation, accuracy of description, and breadth of philosophical generalisation as it was by Willughby and Ray. The progress of the science now became very rapid. Buffon won for it, by his interesting descriptions and brilliant style, the general attention of the educated portion of society, not only in his own but in other countries, and was almost immediately followed by Linnæus, who, extending his studies from botany to Z., not only extended the science by his own observations and discoveries, but rendered it far greater service by gathering together the facts ascertained by others, and by the improvement which he effected in classification. Some of the larger groups established by Linnæus have been retained by all subsequent naturalists without essential modification of their characters, and even his smallest groups—genera—have been very generally retained, although now regarded as constituting tribes or families. According to the Linnæan system, the animal kingdom is divided into six great classes, which are further brought together in groups of two each, as follows:

Heart bilocular, with two auricles, blood warm, red,	Viviparous.	1. Mammalia.
	Oviparous.	2. Birds.
Heart unilocular, with one auricle, blood cold, red,	With lungs.	3. Amphibia.
	With gills.	4. Fishes.
Heart unilocular, with one auricle, circulating fluid (sanies) cold, white,	With antennæ.	5. Insects.
	With tentacula.	6. Vermes.

The orders into which Linnæus divided these classes have, in the most important instances, been already noticed, either under the classes, or separately. It was, however, in constituting and defining the genera that Linnæus shewed in the highest degree his powers both of observation and arrangement. His labours in the lower departments of the animal kingdom were much less perfect than in the higher;

ZOOLOGY.

but others speedily entered upon the field, and whilst new species of animals and their habits continued to be described, the study of comparative anatomy was also diligently prosecuted, and thus preparation was made for a more complete and philosophical system of zoology. The names of Pallas, Hunter, and Blumenbach are particularly worthy to be noticed; but more than any other, the name of Cuvier, who, like Linnaeus, took a comprehensive view of the whole subject of Z., and carried forward the work of minute observation as well as of generalisation. His system of classification is rather an improvement of that of Linnaeus than one fundamentally new, and it has formed a new starting-point for all further progress. The divisions, the classes, and many of the orders of Cuvier's system have already been noticed under their proper heads, so that it may be enough here to give the most general outline of the system, shewing Cuvier's four great divisions of the animal kingdom, and the classes which he arranges under them.

- DIV. I. VERTEBRATA.** Class I. *Mammalia*.  
 " II. *Aves* (Birds).  
 " III. *Reptilia* (Reptiles).  
 " IV. *Pisces* (Fishes).  
**DIV. II. MOLLUSCA.** Class I. *Cephalopoda*.  
 " II. *Pteropoda*.  
 " III. *Gasteropoda*.  
 " IV. *Acephala*.  
 " V. *Brachiopoda*.  
 " VI. *Cirrhopoda*.  
**DIV. III. ARTICULATA.** Class I. *Insecta* (Insects).  
 " II. *Crustacea*.  
 " III. *Arachnida*.  
 " IV. *Annelida*.  
**DIV. IV. RADIATA.** Class I. *Echinodermata*.  
 " II. *Entozoa*.  
 " III. *Acalepha*.  
 " IV. *Polyp.*  
 " V. *Infusoria*.

The system of Cuvier has been modified by Lamarck, Virey, Duméril, De Blainville, F. Cuvier, and others; and in consequence of the progress of scientific discovery, more considerable changes have recently been proposed by eminent naturalists, some of them amounting almost to a reconstruction of the greater part of the system; whilst in particular departments, and especially those which contain the lower forms of animal life, Cuvier's arrangement, regarded by himself as merely provisional, may be said to have already become completely antiquated.

A complete system of the animal kingdom has been proposed by Agassiz. He adopts the four great divisions of Cuvier, but makes much change in the subdivisions, acknowledging, however, that much is still uncertain, and that a satisfactory arrangement must depend upon anatomical and embryological researches yet to be made. The following is an outline of his system:

**DIVISION I.—RADIATA.**

- Class I. *Polyp.*, Order 1. *Actinoides*.  
 " 2. *Halcyonoides*.  
 " II. *Acalepha*, Order 1. *Hydroidea* (including *Siphonophora*).  
 " 2. *Discophora*.  
 " 3. *Ctenophora*.  
 " III. *Echinodermata*, Order 1. *Crinoidea*.  
 " 2. *Asteroides*.  
 " 3. *Steleroidea*.  
 " 4. *Holothurida*.

**DIVISION II.—MOLLUSCA.**

- Class I. *Acephala*, Order 1. *Bryozoa* (including the *Vorticellida*).  
 " 2. *Brachiopoda*.  
 " 3. *Tunicata*.  
 " 4. *Lamellibranchiata*.

- Class II. *Gasteropoda*, Order 1. *Pteropoda*.  
 " 2. *Heteropoda*.  
 " 3. *Gasteropoda* proper.  
 " III. *Cephalopoda*, Order 1. *Tetrabranchiata*.  
 " 2. *Dibranchiata*.

**DIVISION III.—ARTICULATA.**

- Class I. *Vermes*, Order 1. *Trematoides* (including *Cestoides*, *Planaria*, and *Firudinida*).  
 " 2. *Nematoides* (including *Acanthocephali* and *Gordiaceae*).  
 " 3. *Annelida*.  
 " II. *Crustacea*, Order 1. *Rotifera*.  
 " 2. *Entomostraca* (including *Cirrhopoda*).  
 " 3. *Tetracephala*.  
 " 4. *Decapoda*.  
 " III. *Insecta*, Order 1. *Myriapoda*.  
 " 2. *Arachnida*.  
 " 3. *Insecta* proper.

**DIVISION IV.—VERTEBRATA.**

- Class I. *Myzozoa*, Order 1. *Myzozoides*.  
 " 2. *Cyclostomata*.  
 " II. *Pisces* (Fishes proper), Order 1. *Ctenoides*.  
 " 2. *Cycloidea*.  
 " III. *Ganoidea*, Order 1. *Calacanthia*.  
 " 2. *Accipenseroides*.  
 " 3. *Sauroides*.  
 " 4. *Siluroidea*.  
 " 5. *Plectognathes*.  
 " 6. *Lophobranchia*.  
 " IV. *Selachia*, Order 1. *Chimæra*.  
 " 2. *Galeodes*.  
 " 3. *Batides*.  
 " V. *Amphibia*, Order 1. *Cecilia*.  
 " 2. *Ichthyoidi*.  
 " 3. *Anura*.  
 " VI. *Reptilia*, Order 1. *Serpentes*.  
 " 2. *Saurii*.  
 " 3. *Rhizodontes*.  
 " 4. *Tetradactylata*.  
 " VII. *Aves*, Order 1. *Natares*.  
 " 2. *Gralla*.  
 " 3. *Rasores*.  
 " 4. *Insectores* (including *Scansores* and *Accipitres*).  
 " VIII. *Mammalia*, Order 1. *Marsupialia*.  
 " 2. *Herbivora*.  
 " 3. *Carnivora*.

The three Cuvierian divisions of *Vertebrata*, *Mollusca*, and *Articulata* have been very generally retained by systematic zoologists, without much change as to the classes or even orders of animals included in each, although it is now generally admitted that the *Cirrhopoda* are not to be ranked among the *Mollusca*, but, as *Crustaceans*, among the *Articulata*; and the *Polypozoa* or *Bryozoa*, formerly placed with other 'zoophytes' among the *Radiata*, have been removed by many naturalists to a place among the *Mollusca*. Amongst the *Radiata* of Cuvier, great changes have been made; and it may be well to indicate here some of the chief of the new groups which have been proposed, and pretty generally accepted by naturalists, although their proper order and their relations to each other cannot be so well set forth as in those departments of the animal kingdom which have been more thoroughly studied. Greater importance has been assigned by recent naturalists than by their predecessors to the nervous system as a basis of classification. The lowest animals, those in which no

trace of a nervous system has been discovered, have been formed into a separate division of the animal kingdom, under the names *Acrita* and *Protozoa* (q. v.), the latter of which has obtained general preference. Higher in organisation than the *Protozoa* are the *Nematoneura* of Owen, having a nervous system distinctly traceable in a filamentary form, and including all the higher orders of Cuvier's *Radiata*. Some groups, as *Anthozoa* (see ZOOPLHYTE), still occupy a doubtful intermediate place between *Protozoa* and *Nematoneura*. To the *Articulata*, Owen has, with regard to their nervous system, given the name *Homogangliata* (q. v.), and to the *Mollusca* the name *Heterogangliata* (q. v.). In like manner, he has recently introduced in his classification of the Vertebrata the terms *Hemathermal* and *Hematoeryal*, these being merely words formed from the Greek, and signifying respectively *Warm-blooded* and *Cold-blooded*, the former including *Mammalia* and *Birds*, the latter, *Reptiles* and *Fishes*. Further information about the recent classification of some of the lower groups of animals, will be found in the article WORMS.

In the study of Z., far more attention has been paid recently than formerly to the relation which each part of the animal organisation bears to the whole, as the Respiratory System to the Circulatory System, the Digestive System, the Nervous System, &c. The study of the science has thus become more philosophical, and the view obtained of nature more complete; and if the difficulty of classification is found greater than when characters derived from particular parts of the organisation were more exclusively regarded, the result, when fairly wrought out, is a system at once more perfect and more natural.

ZOOPLHYTE (derived from the Greek *zōon*, an animal, and *phylon*, a plant, and signifying an animal-plant) is a term which was employed by Cuvier in the same sense as he employed *Radiata*—viz., to designate the lowest primary division of the animal kingdom, which includes many animal organisms that are fixed to a definite spot of rock, shell, &c., and have the form of plants. His zoophytes included the anomalous groups of *Infusoria*, *Entozoa*, and *Radiaria*,\* the latter of which was subdivided into the *Hydrozoa*, *Anthozoa*, *Acalepha*, *Echinodermata*, and *Bryozoa*.\* Subsequent writers excluded the *Infusoria* and *Entozoa* from the zoophytes, and left only those constructed on the radiated type. These were afterwards found to present extreme differences of structure, and it became obvious that the lower forms of *Hydrozoa* and *Anthozoa* could not be associated with the *Bryozoa*, which approximate closely to the lower mollusca. The term is now never employed by scientific naturalists.

ZOOOSPORE (Gr. *zōos*, living, and *spora*, a seed), in Botany, the name given to those Spores (q. v.), or seeds of acotyledonous plants, which being furnished with cilia, move spontaneously for a short time after being discharged from the spore-case of the parent plant. The motions of their cilia resemble those of the cilia on the Epithelium (q. v.) of the higher animals, and on the external surface of some of the lower tribes, as *Acalepha* (q. v.). In these cases in the animal kingdom, as in this case in the vegetable kingdom, there is no appearance of volition, the motion being probably owing to changes of hygro-metric or of electric condition, or of both. The purpose served by the ciliary motion in zoospores, is evidently the wider diffusion of seeds; and the

cessation of the motion after a certain time permits the seed to become fixed, in order to germination. Zoospores are found in *Characeae*, *Algae*, *Fungi*, and *Lichens*. They have often been mistaken by observers with the microscope for animalcules. Similar to them, in the property of locomotion, simulating that of animals, is another class of bodies, also connected with the reproduction of acotyledonous plants, called *Phytozoa* (q. v.).

ZO'RNDORF, a village four English miles north of Küstrin, was the scene of the bloodiest of the many desperate conflicts of the *Seven Years' War* (q. v.). The Russians having for the second time been ordered by the Czarina Elizabeth to invade Prussia, advanced towards Berlin, committing frightful devastations, while Frederick the Great, with the bulk of his forces, was engaged with the Austrians in Silesia and Saxony. The Russians, under Fermor, were 50,000 strong, and easily drove before them Dohna's little Prussian army of 15,000; but Frederick being speedily apprised of this new invasion, hastened northwards with such a reinforcement as raised the army to 30,000; and after taking care, by the breaking down of bridges, &c. to cut off their retreat, engaged the invaders. The battle, which commenced at eight in the morning of August 25, 1758, and lasted till evening, consisted mainly in a succession of furious charges, accompanied with a tremendous artillery-fire, and was not decided till Seidlitz, by an able movement, turned the Russian flank. The Russians, now discovering that they were nearly surrounded, fought with the utmost desperation, and ultimately both armies bivouacked on the field of battle. In the morning, however, Fermor drew off his forces, diminished by 20,000 men, 103 cannon, and 27 standards; having inflicted on the Prussians a loss of 13,000 men, 26 cannon, and a few standards. Generals Soltikof, Czernitshof, and Prince Sulkowski were made prisoners by the Prussians on this occasion; and, oddly enough, the first named was the conqueror of Frederick II. in the next great battle between the two northern powers, at Kunersdorf (q. v.).

ZOROASTER, or rather ZARATHUSTRA (which in Greek and Latin was corrupted into ZARASTRADES and ZOROASTRES; while the Persians and Parsees altered it into ZERDURET), is the name of the founder of what is now known as the Parsee religion. The original meaning of the word is uncertain, and though there have been many conjectures formed about it, yet not one of them seems to be borne out by recent investigations. Most probably, it only indicates the notion of 'Chief,' 'Senior,' 'High-priest,' and was a common designation of a spiritual guide and head of a district or province. Indeed, the founder of Zoroastrianism is hardly ever mentioned without his family name—viz., Spitama. He seems to have been born in Bactria. The terms he applied to himself are either Manthran, i. e., a reciter of Manthras; a messenger sent by Ahuramazda; a speaker; one who listens to the voice of oracles given by the spirit of nature; one who receives sacred words from Ahuramazda through the flames. His life is completely shrouded in darkness. Both the Greek and Roman, and most of the Zend accounts about his life and works are legendary and utterly unhistorical. In the latter, he is to a great extent represented, not as a historical, but as a dogmatical personality, vested with superhuman, or rather divine powers, standing next to God, above the archangels themselves. His temptations by the devil, whose empire is threatened by him, form the subject of many traditional reports and legends.

\* These terms have been introduced since the time of Cuvier—the former, we believe, by Owen; and the latter by Farre.



He is represented as the abyss of all wisdom and truth, and the master of the whole living creation. 'We worship'—so runs one of the prayers in the Fravardin Yasht—'the rule and the guardian angel of Zarathustra Spitama, who first thought good thoughts, who first spoke good words, who first performed good actions, who was the first priest, the first warrior, the first cultivator of soil, the first prophet, the first who was inspired, the first who has given to mankind nature, and reality, and word, and hearing of word, and wealth, and all good things created by Mazda, which embellish reality; who first caused the wheel to turn among gods and men, who first praised the purity of the living creation and destroyed idolatry, who confessed the Zarathustrian belief in Ahuramazda, the religion of the living God against the devils. . . . Through whom the whole true and revealed word was heard, which is the life and guidance of the world. . . . Through his knowledge and speech, the waters and trees become desirous of growing; through his knowledge and speech, all beings created by the Holy Spirit are uttering words of happiness.'

In the old Yazna (see ZEND-AVESTA) alone, he appears like a living reality, a man acting a great and prominent part both in the history of his country and that of mankind. His father's name seems to have been Pourushâspa, and that of his daughter, the only one mentioned of his children, Pouruchista. Very obscure, however, remains, even by this account, the time when he lived. The dates generally given are as follows. Xanthos of Lydia places him about 600 years before the Trojan war; Aristotle and Eudoxus place him 6000 years before Plato; others, again, 5000 years before the Trojan war. Berosus, a Babylonian historian, makes him a Babylonian king, and the founder of a dynasty which reigned between 2200 and 2000 B.C. over Babylon. The Parsees place him at the time of Hystaspes, Darius's father, whom they identify with a king mentioned in the Shâh-Nâmeh (q. v.), from whom, however, Hystaspes is totally distinct. This account would place him at about 550 B.C. Yet there is scarcely a doubt that he must be considered to belong to a much earlier age, not later than 1000 B.C.; possibly, he was a contemporary of Moses. It is almost certain that Z. was one of the Soshyantôs, or fire-priests, with whom the religious reform, which he carried out boldly, first arose. These were probably at first identical with the Vedic Atharvans (fire-priests), as indeed Zoroastrianism is merely an advanced stage of Brahmanism. The former creed, that of Ahura, by way of eminence, transformed, after the outbreak of the schism, the good beings of the latter into devils or devas; e. g., the purely Brahmanic Indra, Sharva, Nâsatya, &c.—unless it promoted them into saints and angels (yagatas). The conflict that led to this schism between the Iranians and those Aryan tribes which immigrated into Hindustan Proper, and whose leaders became afterwards founders of Brahmanism, sprung from many social, political, and religious causes. The Aryans seem to have originally led a nomad life, until some of them, reaching, in the course of their migrations, lands fit for permanent settlements, settled down into agriculturists. Bactria and the parts between the Oxus and Jaxartes seem to have attracted them most. The Iranians became gradually estranged from their brother tribes, who adhered to their ancient nomad life; and by degrees, the whilom affection having turned into hatred, considered those peaceful settlements a fit prey for their depredations and inroads. The hatred thus nourished, by further degrees included all and everything belonging to these devastators; even their religion, originally identical with that of the

settlers. The 'Deva religion' became, in their eyes, the source of all evil. Moulded into a new form, styled the 'Ahura' religion, the old elements were much more changed than was the case when Judaism became Christianity. Generation after generation further added and took away, until Zarathustra, with the energy and the clear eye that belongs to exalted leaders and founders of religions, gave to that which had originally been a mere reaction and spite against the primitive 'Brahmanic' faith, a new and independent life, and for ever fixed its dogmas, not a few of which have sprung from his own brains.

It is, as we said in the article on the ZEND-AVESTA, chiefly from the Gâthas that Zarathustra's real theology, unmitigated by later ages, can be learned. His leading idea was monotheism. Whatever may have caused the establishment of the dualism of gods, the good and the evil, in the Persian religion—a dualism so clearly marked at the time of Isaiah, that he found it necessary to protest emphatically against it—it was not Z. who proclaimed it. His dualism is of a totally different nature. It was merely the principle of his speculative philosophy—a supposition of two primeval causes of the real and the intellectual world. His moral philosophy, on the other hand, moved in a triad—thought, word, and deed. There is no complete system of Zoroastrian philosophy to be found in the Zend-Avesta, any more than there is a developed Platonic system laid down explicitly in the Platonic writings; but from what is to be gathered in the documents referred to, it cannot be doubted that Z. was a deep and great thinker, far above his contemporaries, and even many of the most enlightened men of subsequent ages. If proof were needed for the high appreciation in which he was held in antiquity, it might be found in the circumstance, that even the Greeks and Romans, not particularly given to overrating foreign learning and wisdom, held him in the very highest estimation, as may be seen by their reiterated praises of the wisdom of him whose name they scarcely knew how to pronounce.

With regard, then, to the first point, his monotheism, it suffices to mention, that while the fire-priests before him, the Soshyantôs, worshipped a plurality of good spirits called Ahuras, as opposed to the Indian devas, he reduced this plurality to a unity. This one supreme being he called Ahurô Mazdaô (that Ahura which is Mazdaô), or the creator of the universe—the Auramazda of the cuneiform inscriptions of the Achemenidian kings, the Ahurmazd of Sassanian times, and the Hormazd or Ormazd of modern Parsees. This supreme god is by Z. conceived to be 'the creator of the earthly and spiritual life, the lord of the whole universe, at whose hands are all the creatures.' The following extract from the Gâthas (Ustavaiti) will leave no doubt on that much-contested point: 'Blessed is he, blessed are all men to whom the living wise God of his own command should grant those two everlasting powers (viz., immortality and wholeness). . . . I believe Thee, O God, to be the best thing of all, the source of light for the world. Everybody shall choose Thee as the source of light, Thee, Thee, holiest spirit Mazda! Thou createst all good things by means of the power of Thy good mind at any time, and promisest us, who believe in Thee, a long life. I believe Thee to be the powerful holy god Mazda! for Thou givest with Thy hand, filled with helps, good to the pious man, as well as to the impious, by means of the warmth of the fire strengthening the good things. From this reason, the vigour of the good mind has fallen to my lot. . . . Who was in the beginning the father and the creator of truth? Who shewed to the sun and the

stars their way? Who causes the moon to increase and wane, if not Thou? . . . Who is holding the earth and the skies above it? Who made the waters and the trees of the field? Who is in the winds and in the storms that they so quickly run? Who is the creator of the good-minded beings, Thou wise? Who made the lights of good effect and the darkness? Who made the sleep of good effect and the activity? Who made morning, noon, and night? Ahuramazda is thus to Z. the light and the source of light. He is wisdom and intellect; he possesses all good things, temporal and spiritual, among them the good mind, immortality, wholesomeness, the best truth, devotion, piety, and abundance of all earthly good. All these gifts he grants to the pious man who is pure in thought, word, and deed. He rewards the good, and punishes the wicked; and all that is created, good or evil, fortune or misfortune, is his work alone.

We spoke of Z.'s philosophical dualism, and of its having often been confounded with theological dualism, which it is certainly very far from being. Nothing was further from Z.'s mind than to assume anything but one supreme being, one and indivisible. But that everlasting problem of all thinking minds—viz. the origin of evil, and its incompatibility with God's goodness, holiness, and justice—he attempted to solve by assuming two primeval causes, which, though different, were united, and produced the world of the material things as well as that of the spirit. The one who produced the *reality* (*gaya*) is called *Vohu Mano*, the good mind; the other, through whom the non-reality (*ajyâiti*) originated, is the *Akem Manô*, the naught mind. To the first belong all good, true, and perfect things; to the second, all that is delusive, bad, wicked. These two aboriginal moving causes of the universe are called twins. They are spread everywhere, in God as in men. When united in Ahuramazda, they are called *Opentô Mainyus*, and *Angrô Mainyus*—i. e., white or holy; and dark spirit. It is only in later writings that these two are supposed to be opposed to each other, not within Ahuramazda, but without—to stand, in fact, in the relation of God and Devil to each other. The inscriptions of Darius know but one god, without any adversary whatsoever. But while the one side within him produced all that was bright and shining, all that is good and useful in nature, the other side produced all that is dark and apparently noxious. Both are inseparable as day and night, and though opposed to each other, are indispensable for the preservation of creation. The bright spirit appears in the blazing flame, the presence of the dark is marked by the wood converted into charcoal. The one has created the light of the day, the other the darkness of night; the former awakens men to their duty, the other lulls them to sleep. Life is produced by the one, and extinguished by the other, who also, by releasing the soul from the fetters of the body, enables her to go up to immortality and everlasting life.

We have said already that the original monotheism of Z. did not last long. False interpretations, misunderstandings, changes, and corruptions crept in, and dualism was established in theology. The two principles then for the first time became two powers, hostile to each other, each ruling over a realm of his own, and constantly endeavouring to overthrow the other. This doctrine, which appears first fully developed in the *Vendidad*, once accepted by some of the most influential leaders, it soon followed that, like terrestrial rulers, each of the two powers must have a council and a court of his own. The number of councillors was six, each having to rule over some special province of creation; but Ahuramazda,

who at first merely presided over this council, came gradually to be included in their number, and we then read of seven instead of the usual six Amehaspentas, or Immortal Saints. These six supreme councillors, who have also found their way into the Jewish tradition embodied in the Talmud, are both by etymology and the sense of the passages in which they figure, distinctly seen to be but abstract nouns or ideas, representing the gifts which God grants to all those who worship with a pure heart, who speak the truth, and perform good actions. The first of these angels or principles (*Vohu Mano*) is the vital faculty in all living beings of the good creation. He is the *son* of Ahuramazda, and penetrates the whole living good creation. By him are wrought all good deeds and words of men. The second (*Ardibehešt*) represents the blazing flame of fire, the light in luminaries, and brightness and splendour of any and every kind. He represents, as the light, the all-pervading, all-penetrating Ahuramazda's omnipresence. He is the preserver of the vitality of all life and all that is good. He thus represents Providence. The third presides over metals, and is the giver of wealth. His name is *Sharavar*, which means possession, wealth. The fourth (*Issandarmat* = Devotion) represents the earth. It is a symbol of the pious and obedient heart of the true Ahuramazda worshipper, who serves God with his body and soul. The two last (*Khordâd* and *Amerdât*) preside over vegetation, and produce all kinds of fruit. But apart from the celestial council stands *Sraosha* (*Serost*) the archangel, vested with very high powers. He alone seems to have been considered a personality. He stands between God and man, the great teacher of the prophet himself. He shows the way to heaven, and pronounces judgment upon human action after death. He is, in the *Yazna*, styled the Sincere, the Beautiful, the Victorious, who protects our territories, the True, the Master of Truth. 'For his splendour and beauty, for his power and victory,' he is to be worshipped and invoked. 'He first sang the five *Gâthas* of Zarathustra *Spitamâ*;' that is, he is the bearer and representative of the sacred tradition, including the sacrificial rites and the prayers. He is the protector of all creation, for 'he slays the demon of Destruction, who prevents the growth of nature, and murders its life. He never slumbers, but is always awake. He guards with his drawn sword the whole world against the attacks of the demons, endowed with bodies after sunset. He has a palace of 1000 pillars, erected on the highest summit of the mountain *Alborj*. It has its own light from inside, and from outside it is decorated with stars. . . . He walks teaching religion round about the world.' In men who do not honour him by prayer, the bad mind becomes powerful, and impregnates them with sin and crime, and they shall become utterly distressed both in this life and in the life to come.

In the same manner as Ahuramazda, his counterpart, *Angrômainyus*, was in later times endowed with a council, imitated from the one just mentioned, and consisting of six devas, or devils, headed by *Angrômainyus* himself, who is then styled *Devânem Devo* = arch-devil. The first after him is called *Ako Mano*, or Naught Mind, the original 'non-reality,' or evil principle of Zoroaster. He produces all bad thoughts, makes man utter bad words, and commit sin. The second place is taken by the Indian god *Indra*; the third, by *Shiva* or *Shaurva*; the fourth, by *Naonhaitya*—the collective name of the Indian *Ashuras* or *Dioecuri*; the fifth and sixth, by the two personifications of 'Darkness' and 'Poison.' There are many devas, or devils, besides to be found in the *Zend-Avesta*, mostly allegorical or symbolical names of evils of all kinds. While the

heavenly council is always taking measures for promoting life, the infernal council is always endeavouring to destroy it. They endeavour to spread lies and falsehoods, and altogether coincide together with their great chief, with the devil and the infernal hierarchy of the New Testament.

Thus Monotheism was in later times broken up and superseded by Dualism. But a small party, represented by the Magi, remained steadfast to the old doctrine, as opposed to that of the followers of the false interpretation or Zend, the Zendika. In order to prove their own interpretation of Zoroaster's doctrines, they had recourse to a false and ungrammatical explanation of the term Zervana Akarana, which, merely meaning time without bounds, was by them pressed into an identity with the Supreme Being; whilst the passages on which the present Desturs, or Parsee priests, still rest their faulty interpretation, simply indicate that God created in the boundless time, i. e., that He is from eternity, self-existing, neither born nor created. Two intellects and two lives are further mentioned in the Zend-Avesta. By the former are to be understood the heavenly, spiritual wisdom, and the earthly wisdom, i. e., that which is learned by ordinary teaching and experience. The two lives are in the same manner distinguished as the bodily and the mental, i. e., body and soul. From these two lives, however, are to be distinguished the 'first' and 'last' lives, terms which refer to this life and the life to come. The belief in the latter, and in immortality, was one of the principal dogmas of Z., and it is held by many that it was not through Persian influence that it became a Jewish and a Christian dogma. Heaven is called the 'House of Hymns,' a place where angels praise God incessantly in song. It is also called the 'Best Life,' or Paradise. 'Hell' is called the House of Destruction. It is the abode chiefly of the priests of the bad (deva) religion. The modern Persians call the former Behebt; the latter, Duzak. Between heaven and hell, there is the bridge of the gatherer or Judge, over which the soul of the pious passes unharmed, while the wicked is precipitated from it into hell. The resurrection of the body is clearly and emphatically indicated in the Zend-Avesta; and it belongs, in all probability, to Z.'s original doctrine—not, as has been held by some, to later times, when it was imported into his religion by other religions. A detailed description of the resurrection and last judgment is contained in the Bundehesh. The same argument—the almightiness of the Creator—which is now employed to shew the possibility of the elements, dissolved and scattered as they may be, being all brought back again, and made once more to form the body to which they once belonged, is made use of there to prove the Resurrection. There is still an important element to be noticed—viz., the Messiah, or Sosiosh, from whom the Jewish and Christian notions of a Messiah are held, by many, to have been derived. He is to awaken the dead bodies, to restore all life destroyed by death, and to hold the last judgment. Here, again, a later period introduced a plurality, notably a Trinity. Three great prophets are also to appear when the end of the world draws nigh, respectively bearing the names of Moon of Happy Rule, Aurora of Happy Rule, and Sosiosh, who is supposed to be the son of Zarathustra, begotten in a supernatural way; and he will bring with him a new portion of Zend-Avesta, hitherto hidden from man. Even a superficial glance at this sketch will shew our readers what very close parallels between Jewish and Christian notions on the one hand, and the Zoroastrian on the other, are to be drawn; but, as we have noticed under PARSEES (q. v.), an attentive reading of the Zend-Avesta

reveals new and striking points of contact almost on every page.

We have in the foregoing sketch mainly followed Haug, the *facile princeps* of Zend studies in these days; but we have also taken into account the views of Windischmann, Spiegel, and other prominent investigators, and principally by quoting the words of the sacred sources themselves, when feasible, put our readers in a position to judge on the main points for themselves. We cannot, however, do better than thus briefly summarise, in conclusion, the principal doctrines of Z., as drawn from a certain speech (contained in the Gáthas), which, in all probability, emanates from Z. himself.

'1. Everywhere in the world, a duality is to be perceived, such as the Good and the Evil, light and darkness; this life and that life, human wisdom and divine wisdom. 2. Only this life becomes a prey of death, but not that hereafter, over which the destructive spirit has no power. 3. In the universe, there are from the beginning two spirits at work, the one making life, the other destroying it. 4. Both these spirits are accompanied by intellectual powers, representing the ideas of the Platonic system on which the whole moral world rests. They cause the struggle between good and evil, and all the conflicts in the world, which end in the final victory of the good principle. 5. The principal duty of man in this life is to obey the word and commandments of God. 6. Disobedience is punished with the death of the sinner. 7. Ahuramazda created the idea of the good, but is not identical with it. This idea produced the good mind, the Divine Spirit, working in man and nature, and devotion—the obedient heart. 8. The Divine Spirit cannot be resisted. 9. Those who obey the word of God will be free from all defects, and immortal. 10. God exercises his rule in the world through the works prompted by the Divine Spirit, who is working in man and nature. 11. Men should pray to God and worship Him. He hears the prayers of the good. 12. All men live solely through the bounty of God. 13. The soul of the pure will hereafter enjoy everlasting life; that of the wicked will have to undergo everlasting punishment—i. e., as modern Parsee theologians explain, to the day of the resurrection. 14. All creatures are Ahuramazda's. 15. He is the reality of the good mind, word, and deed.' See PARSEES, GUERRAS, ZEND, ZEND-AVESTA, &c.

ZOSIMUS, of Constantinople, a Greek historian, who lived in the 5th c. A.D. He wrote the History of the Roman Emperors, in six books, from Augustus to 410 A.D. His style is concise, clear, and interesting. He seeks to unfold the causes of the decline of the empire, and being himself a pagan, he adduces as the chief, the neglect of the pagan religion which attended the progress of Christianity. The unsparing severity with which he assails various Christian emperors, especially Constantine, has been considered by some (e.g. Bentley) to detract from his credibility as a historian. From his own point of view, he shews a considerable degree of acuteness in his remarks. Nothing is known of his personal history.

ZOSIMUS, POPE, and successor of Innocent I., requires a brief notice on account of his connection with the history of the heresiarch Pelagius (q. v.). Z. was a Greek by birth, and was elected Bishop of Rome, March 1, 417. The African bishops had condemned the opinions of Pelagius, and this judgment had been ratified by Pope Innocent. In the interval, however, Pelagius appealed to the pope; and his disciple, Celestius, came in person to Rome, where he presented a confession of faith in his own justification. Z., having convened a council of bishops and submitted this to them, was

induced by the specious explanations of Celestius to suspend the judgment, and even to write to the African bishops, recommending a reconsideration of the case. This apparent conflict of Z. with his predecessor, although it has been used by the Gallican as well as Protestant controversialists as an argument against papal infallibility, was nevertheless only temporary. On further examination of Celestius, Z. became sensible that he had been deceived; and even before the reply of the African bishops, confirmed and renewed their original condemnation of the Pelagian doctrine. He died December 26, 418. His Letters, which are curious and interesting, are found in Constant's *Epistola Romanorum Pontificum*.

ZOUAVES (Arab. *Zwaswa*), a body of troops in the French army, which derives its name from a tribe of Kabyles, inhabiting the mountains of Jurjura, in the Algerian province of Constantine. Long previous to the invasion of Algiers by the French, these Kabyles had been employed as hired mercenaries in the service of the rulers of Tripoli, Tunisia, and Algiers; and after the conquest of the last-named country in 1830, the French, in the hope of establishing a friendly feeling between the natives and their conquerors, took the late Dey's mercenaries into their service, giving them a new organization. Accordingly, General Clausel created, in 1830, two battalions of Z., in which each company consisted of French and Kabyles in certain proportions, officers, subalterns, and soldiers being selected from either race; the Z., though retaining their Moorish dress, were armed and disciplined after the European fashion; and the battalions were recruited by voluntary enlistment. As it was soon found, however, that the system of commingling the two races did not effect the object intended, the French and Kabyles were formed into separate companies; and in 1837, they were divided into three battalions, and put under the command of a colonel. Their first colonel was Lamoricière, who mainly effected their reorganization, and under whom, as well as his successor, Cavaignac (q. v.), they distinguished themselves in many a bloody conflict with the Arabs of the south. Gradually, however, the native element was eliminated, and since 1840, they may be considered as French troops in a Moorish dress. In 1852—1855, their numbers were greatly augmented, and they now amount to upwards of 10,000 men, divided into four regiments of four battalions each. They are recruited from the veterans of the ordinary infantry regiments who are distinguished for their fine 'physique' and tried courage and hardihood; clad in a loose jacket and waistcoat of dark-blue cloth ornamented with yellow braid, loose madder-coloured trousers, brown cloak, madder-coloured Fex cap with a yellow tassel, surrounded by a green turban, a light blue sash of wool, yellow leather leggings, and white gaiters; and armed with a carbine and sword-bayonet. The uniform of the officers and subalterns is the same as that of the hussars.

When the French and the African elements of the original Zouave battalions were separated, the Africans were constituted into a separate body, under the name of Algerian Tirailleurs, a force still recruited in Algiers to form a part (three regiments) of the regular French army. They are better known as *Turcos*.

ZSCHOKKE, JOHANN HEINRICH DANIEL, one of the most eminent German authors of this century, was born at Magdeburg on March 22, 1771. On leaving school at the age of 17, he joined a company of players in the capacity of a dramatic author. He travelled with them for some time, after which

he returned to his family, and entered the university of Frankfurt. There he seems to have studied all subjects from divinity to administration (*Kameralwissenschaften*). He at the same time acted as a private teacher, and published plays which brought him some reputation, but no pay. In 1795, he was disappointed in obtaining the post of Ordinary Professor, for which he applied, and set out on a tour through Germany and France. He settled finally at Reichenau, in the Grisons, where he opened a boarding-school. So much pleased were the governing bodies of the canton with his establishment, that they presented him with the citizenship. In return for this favour, he wrote a History of the Grisons, published at Zürich in 1798 (*Geschichte des Freistaats der drei Bünde in Rhätien*). In the same year, however, Z. became unpopular in the canton by advocating its annexation to the Helvetic Republic established by the French, and his school was in consequence closed. He removed to Aarau, then the seat of government, where he was employed as a commissioner to settle the affairs of Unterwalden, Uri, Schwyz, and Zug, a trust which he discharged with the utmost ability and good temper. The benevolent interest, indeed, which he manifested in the sufferings of the population has made his name memorable as a national benefactor. It would be tedious to enumerate the political and administrative affairs in which Z. was actively engaged after this period; we find him at one time protesting against the arbitrary proceedings of the French, and at another pointing out the prudence of concession, but always taking a course marked by practical sagacity and wisdom. In 1804, he was presented with the citizenship of Aargau and appointed Inspector of Woods and Mines. In the same year, he founded the Swiss Messenger (*Schweizerboten*), a publication which rapidly became popular. It was followed by the Miscellany of the Latest News (*Miscellen für die neueste Weltkunde*), which was continued down to 1813. In 1811, he added a monthly periodical, the *Erheiterungen*, to these publications. He died at Aarau, June 27, 1848. Z.'s works are very numerous, and are always characterized by sound information, good sense, and a vigorous and effective eloquence. The most important of his historical works, not mentioned above, are *History of the Forest Cantons*, a *History of Bavaria*, a *Popular History of Switzerland*. His novels or tales are more numerous and better known; among the best are *The Creole*, *Alamontade*, *Jonathan Frock*, *Clementine*, *Oswald*, and *Meister Jordan*. As a poet and play-writer, Z. has less merit. The most popular of all his writings was the *Hours of Devotion*, a Sunday periodical: it supplied a complete exposition of modern rationalism, and yet displayed such zeal and eloquence in the cause of sound morality, that it met with approbation from persons of all creeds. It has gone through 40 German editions, and, with many other works of Z., has been translated into English. A collected edition of works of Z. (Aarau, 1825). See *Life of Zschokke*, by Munch (Haag, 1831); and *Autobiography*, Eng. tran. (1845).

ZSCHOPPAU, a town of Saxony, in the circle of Zwickau, and about 26 miles east of the town of that name, on the river Zschoppau. It has a castle and two churches; manufactures of hosiery, cloth, lace, &c.; weaving, wool-spinning, dyeworks, bleach-fields. Pop. (1871) 7877.

ZUG, the smallest of the Swiss cantons, is about 14 miles in length by 10 in width. It had, in 1870, a pop. of 20,993. The south-eastern part of the canton borders on the Alpine region, and is hilly and pastoral; the north-western part, sloping to the plain of Switzerland, and enclosing a great part

of the Lake of Zug, is a rich and beautiful country of corn-fields and orchards. The chief exports of Z. are dried fruit, cattle, and the products of the dairy. Z. is a representative democracy, all citizens above 19 enjoying the franchise. There are two councils, one consisting of 67 members, which discharges legislative functions, and another consisting of 11 members, which conducts the administration. The inhabitants speak Swiss-German, and are Roman Catholic. The battle of Morgarten, which founded the independence of Switzerland, was fought on the frontier of this canton in 1315; but it was not till 1352 that Z. joined the Swiss Confederation.—Zug, the capital of the canton, has a pop. of about 4300.

ZUIDER ZEE, a large gulf penetrating deep into the Netherlands, between 52° 26'—53° 20' N. lat., is about 60 miles in length, and 210 miles in circumference. The islands Texel, Vlieland, Ter Schelling, Ameland, and Schiermonnikoog, reaching in a chain from the most northern point of Holland, are the remains of the former line of coast, which form a breakwater against the North Sea. From Dunkirk in French Flanders to the north of Holland, the interior is defended from the sea by sand-hills or downs. Here, as at the mouth of the Scheldt, the sand-barrier was broken, and the waters overflowing the low lands, separated the province of Friesland from the peninsula of North Holland, and, having united with the small inner lake Flevo, formed the present Zuider Zee. The decisive inundation occurred in 1282.

In the Z. Z., lie the islands Wieringen, Urk, Schokland, and Marken, with a pop. of about 5000 souls. Fishing is the principal industry. The light-tower, on the east point of Marken, stands in 52° 27' 37" N. lat.; and the inhabitants are a hardy, industrious, and independent people, who live by fishing and exporting meadow-hay. They cling tenaciously to their old customs, and never marry except among themselves. The houses are built on artificial mounds, or 'hills of refuge;' and the island being liable to frequent and heavy floods, few cows or sheep are kept, no gardens or trees planted, the necessaries of life being almost all brought from the mainland.

From the south-east of the Z. Z., a long narrow arm, called the Y (pronounced *I*), formerly ran nearly due west, through the peninsula of Holland. A strong sea-dyke and locks have been constructed to cut off the Z. Z. from the Y, through which a broad ship-canal has been made between Amsterdam and the North Sea, on which a new harbour is approaching completion. On both sides of the new canal, the Y has been drained and turned into about 12,000 acres of rich land. The new water-way was formally opened by the king in 1876. It is proposed to make a dyke from the mouth of the Yssel to Enkhuizen, and drain the central part of the Z. Z., making room for 200,000 inhabitants, and adding nearly 500,000 acres to the arable land of the Netherlands.

ZU'LU, or AMAZULU, is the name of that portion of the Kaffir race who inhabit Natal and the region north-east of it, until they gradually merge into the mere negro of the east coast, north of the Zambesi. The Kaffir organisation appears to hold an intermediate place between that of the negro and a higher type; and as we go south and west, from the swamps and malaria of Delagoa Bay and Sofala to the more healthy and bracing regions of Natal and Independent Kaffraria, the Kaffir features appear, as it were, to grow more refined—the mouth protrudes less, the lips are less thick, and the nose assimilates more to that of the

European, although the distinguishing type of woolly hair may still continue.

The Z. Kaffir is a far more amiable savage than his brother the Amakosa of the Cape frontier districts. He is less warlike and predatory, more industrious, and far more willing to act in the capacity of a farm-labourer or domestic servant. In language, customs, habits, &c., although certain tribal and local differences occur, yet they may be called common to all the nation, as a Z. Kaffir has no difficulty in understanding a native of British Kaffraria; and his views of a future state, purchase of wives, &c., are pretty similar. The Z. is by nature social, light of heart, and cheerful; his affections are gentle, steady, and enduring; his passions are, however, strong, and called out when in a state of war. He is comparatively chaste; crimes which stain European or Eastern civilisation are unknown to him. He is hospitable and honest, yet greedy and stingy; he is kind to his own family, yet cruel to dumb animals; and whatever the better nature of his impulses may be, yet when his great chief commands war, he is converted into a demon. He is proud, and very easily can distinguish between an English gentleman and the loafing tribe with which too many of our colonies are afflicted. The writer of this article, by the exercise of a little kindness and firmness, has experienced the most utter devotion from individuals of the Kaffir race generally. Their reasoning powers are good, and with an improved education, a Z. rationalist might not disgrace a chair in the Sorbonne.

It is from the Z. country, however, that those terrible tyrants who so long devastated South-eastern Africa, the chiefs Chaka, Dingaan, Moselikatze, &c. issued. The training of their subjects to a peculiar mode of warfare spread desolation and havoc for many years amongst the Betjuana and other tribes of the interior, until eventually these mighty chiefs with their thousands of followers, fighting, like Homer's heroes, hand to hand, armed with stabbing assegais and shields of ox-hide, the colours of which distinguished the different regiments they were formed into, melted away with broken power into comparative insignificance before the terrible rifles of a few hundred emigrant Dutch Boers, who, in their turn, gave way to the energetic action of the British authorities (see NATAL). The Zulus, although they have very often serious intestine wars amongst themselves, yet live on very friendly terms with the Natal colonists, amongst whom a considerable number of refugees from the country east of the Umtingela dwell in peace and safety, and are, in many cases, fast acquiring a comparative independence.

A number of missionary societies of the Wesleyan, American, Norwegian, and Episcopal churches labour amongst these tribes; and considerable interest has lately been felt with regard to Bishop Colenso's peculiar views for the evangelising these heathens, and his Z. is becoming almost as famous as Macaulay's New Zealander.

The Amatengu tribe, now settled along the Cape frontier, are a broken tribe of Zulus, driven far to the south-west by Chaka or Dingaan, then reduced to slavery by the Amakosa Kaffirs, and freed by Sir B. Durban in the Kaffir war of 1834—1835. The principal Z. tribes are the Amazulu, the Amahute, Amazwazi, and Amatabela. The last, under the chief Moselikatze, have emigrated far to the north, where, amongst the mountains which separate the valley of the Limpopo from the basin of the Zambesi, they still issue forth, and carry their depredations as far north as the Lake Nyassa, where they were found by Dr Livingstone eight or nine years ago. It is almost impossible to give an accurate idea

of the number of those tribes inhabiting south-east Africa: it has been variously estimated from half a million to two millions or more. Of the language spoken by the Z. and other Kaffir tribes, it must be observed that that in use by the Natal and Zululand Kaffirs is much more pure than that spoken by the Kaffirs on the Cape frontier, where Hotentot clicks and vulgar colonial Dutch words have got very much mixed up with it.

**ZULULAND.** The country lying north-east of the colony of Natal, between its east boundary, the Umtugela and Umzimyati rivers, lat.  $29^{\circ} 10' E.$ , and Delagoa Bay, lat.  $26^{\circ} S.$ , long.  $32^{\circ} 40' E.$ , is generally known under the name of Z., or the Zulu country, inhabited by independent tribes of Zulu Kaffirs, those living in the immediate vicinity of the Natal colony being subjects of the paramount chief Umpanda, and his son Ketchwayo, the successor of the tyrants Chaka and Dingaan. The great coast chain of mountains, which form in the Cape Colony the Stormbergen, and further to the north-east the Kahlamba and Drachenbergen, still continue well defined to the north-east, running parallel to the coast, but 120 miles distant from it, separating the coast region of Z. from the higher plateaux inhabited by the Dutch Boers of the Transvaal Republic, and rising to an average height of 6000 or 7000 feet. East of the Umtugela River, the country spreads out into large, undulating, grassy plains, but sparsely wooded; while towards the foot of the mountains the kloofs afford some excellent timber. The principal rivers are the Umvoluzi or St Lucia River, which enters the sea about 80 miles north-east of the Natal frontier; and the Mapoota and its branches, which drain the north part of the region, and fall into Delagoa Bay. The country along the coast between the St Lucia River and Delagoa Bay is very flat, marshy, and unhealthy. A considerable range of mountains, called the Lebombo, run from the Umvoluzi River almost in a northerly direction to beyond Delagoa Bay, about half way between the coast and the first range we have mentioned, forming a supporting buttress to a plateau of high level, similar to those so common in the Cape Colony and Natal.

This is generally a fertile region, and, as far as the coast-line, is healthy. Sugar, cotton, and other tropical products can be grown as advantageously as in the Natal colony, to which it forms, as it were, an intermediary link between the fever-regions of the east coast and the more healthy climate of Natal and the Cape Colony. The St Lucia River marks the boundary-line beyond which, to the north-east, Europeans cannot live. Although our traders have tolerably well explored the Zulu country, yet no good map of the region exists, and we know very little of its geology or mineral productions. None of the rivers are available for inland navigation, although a large lagoon inside the mouth of the St Lucia River can be ascended for a few miles. The rivers which flow into Delagoa Bay from the north are sluggish streams, often with no perceptible current, and can be ascended a considerable distance. A large quantity of ivory, rhinoceros' horns, hides, &c. are collected in this region by traders from Natal; and cattle, Indian corn, &c. thrive well in the country before the swampy region commences. The principal tribes are all of the Zulu race—the Amazulu inhabiting the region bordering on Natal; the Amahute, Amazwazi, &c. the country in the neighbourhood of Delagoa Bay. The Portuguese have a very decayed fort and settlement on Delagoa Bay, garrisoned by a few mulatto soldiers, and carrying on some trade with the natives and Dutch Boers in gunpowder, muskets, calico, &c., in exchange for ivory, horns,

and other native produce; and a contraband one in slaves is also, we fear, winked at by the authorities, as captures are often made along the coast by our cruisers. The Dutch emigrant Boers, who very much require a port on the sea-board of South-east Africa, would long since have seized on Delagoa Bay, if it were not from a wholesome dread of the very unhealthy climate, which appears to affect those stalwart sons of the highlands of South-east Africa more even than it does Europeans or North Americans.

**ZUMALA-CARREGUY, DON TOMAS**, the most distinguished of the generals who supported the cause of Don Carlos during the Spanish Civil War of 1833—1840, was born in 1789 at Ormaiztegui, in the Biscayan province of Guipuzcoa. Of an aristocratic, though not wealthy family, he was deeply imbued from infancy with royalist sentiments, which gathered strength with increasing years, till they led him, like the Vendean leaders, to sacrifice fortune and life for a prince wholly unworthy of such devotion. At the time of the invasion of the Peninsula by Napoleon, Z. was a student of law at Pampeluna, and like many of the Spanish youth, he deserted his studies to take up arms against the invader, serving in Mina's corps till the close of the war. He afterwards served under Quesada in the 'Army of the Faith;' and on the re-establishment of absolutism, was raised to the rank of colonel, and appointed governor of Ferrol. He displayed excellent administrative qualities; but his decided leaning to the party of the Carlists (though he repelled indignantly all proposals to proclaim Don Carlos king during the life of Ferdinand VII.) becoming known, he was tried by a council of war, and acquitted. In 1832, when the army was purged of all officers suspected of Carlism, Z. was dismissed, and retired to Pampeluna, where he lived in retirement till the death of Ferdinand and the rising of the Basque population called him to head the Carlist insurrection (October 11, 1833). His motley army was without uniform, ill fed, and ill paid; yet the profound esteem in which 'el Tio Tomas' was held by his followers enabled him to maintain an effective discipline. The overwhelming superiority in number of the Christinos, however, forced him to adopt a defensive system of tactics; so, holding the command of Biscay and Navarre, and the strongholds of Fuenterrabia and Irun, to assure his retreat into France, if necessary, he kept his opponents at bay, defeated Rodil in the valley of Amescos (August 1, 1834), routed another force of Christinos at Viana (September 7), gained a second victory in the Amescos Valley in the following spring, completely defeating Valdez, after a battle of four days, and routed Iriarte near Guernica. These brilliant successes of his skilful and devoted partisan flattered the too sanguine and somewhat weak-minded Don Carlos with the hope of speedily seating himself on the throne, rendered him less willing than formerly to be guided by the counsels of Z., and led him to interfere with the latter's schemes, to his own detriment. Accordingly, after another year's successful fighting with the Christinos, Z. was ordered to lay siege to Bilbao; but on June 15, 1835, he received a gun-shot wound so severe that he died ten days afterwards. With Z.'s death, all hope of success for the Carlists was extinguished; and though the war dragged on desultorily for some years longer, the result was never doubtful. Z. was distinguished for generosity and disinterestedness as for fidelity; and so much had he impoverished himself by liberality to his soldiers, that neither his wardrobe nor his treasury supplied the means for his decent interment.—See Henningens's *Twelve Months Campaign*

with *Zumala-Carreyuy in Navarre and the Basque Provinces* (2 vols., Lond. 1836).

ZÜRICH, a canton on the north-eastern frontier of Switzerland, is drained by the Rhine and its tributaries. Its pop., in 1870, was 284,786. It is traversed by ridges of lofty hills, running north-west and south-east, between which lie three valleys, forming almost its whole surface—those of the Toos, the Glatt, and the Limmat. The Lake of Zürich penetrates Z. for a distance of 26 miles, and connects it with the cantons of Schwyz and St Gall. Z. has not a fertile soil, but it is carefully cultivated. A considerable quantity of corn is raised in the canton, though not enough to supply the wants of the population. Vineyards and orchards are numerous; but the pasture-lands are of much greater importance, and cattle form the chief wealth of the agricultural population. Z. was one of the earliest seats of the cotton manufacture in Europe, and the spinning and weaving of cotton are still prosecuted with great success. The silk manufactures are nearly as important; and more recently, the progress made in the manufacture of railway locomotives and other machinery, has been a cause of some alarm to English engineers. The mechanics of Z. divide their attention between agriculture and manufacturing industry, and are among the most prosperous and best educated working-men in Europe. The government of the canton is a representative democracy—all adult citizens of 20 enjoying the franchise. The great council of Z. is elected chiefly by the citizens, but partly also by its own members. It appoints for four years an executive council of nine members. A desire to give a yet more thoroughly democratic character to the constitution led to the appointment in 1868 of a committee to consider its revision; and now the real decision as to laws, taxes, &c., lies with the people. Z. returns 14 members to the national council. The pop. of the canton (663 sq. m.) is German-speaking and Protestant.

ZÜRICH, the capital of the canton of the same name, is situated at the point where the Limmat issues from the Lake of Zürich, and unites with its tributary, the Sihl. Its pop. in 1870 was 21,199. It is one of the most prosperous manufacturing and commercial towns of Switzerland; yet the narrow streets and lofty houses of its older quarters, on the high ground east of the river, give it the quaint appearance of a medieval city. There are many interesting old buildings—the most remarkable being the cathedral, erected in the 11th century. The university, the gymnasium, and the school of industry have long enjoyed a high reputation. The town library is extensive; and numerous museums of natural history, &c., indicate the intelligence and cultivated tastes of the population.

ZURUMA, or ZARUMA, a town of Ecuador, South America, on the west slope of the Andes, about 30 miles from the west coast, and 90 south of Guayaquil. It is situated in a mining district—its gold and silver mines having rendered it formerly very populous, but its importance has greatly declined. Pop. about 6000.

ZUTPHEN, a fortified town in the Netherlands, province of Gelderland, is beautifully situated on the right bank of the Yssel, where that river is joined by the Berkel, in a picturesque district of country, chiefly under cultivation, and variegated with abundance of wood. It is one of the oldest towns in the kingdom, but has many elegant modern buildings. The fortifications are promenades, from many points of which lovely prospects are obtained.

Z. is a station of the State Railway from Arnheim to Friesland, and has an extensive trade in wood,

bark, and grain. There are factories for weaving and spinning, grain, wool, oil, and paper mills, many tanneries, a soap-boiling establishment, and a large carpet-manufacture. The principal building is the Great Church, supposed to have been founded in 1103; it and the Broedrenkerk (Church of the Brethren) belong to the Reformed Communion; the Roman Catholics, Lutherans, and Baptists have each a church, and the Jews a synagogue. Besides good schools for the ordinary branches of education, there are a grammar-school, school of design, a theatre, and a concert-hall. The town has several charitable institutions for the sick, orphans, and old people; also the provincial lunatic asylum, which can receive 220 patients. Pop. (Jan. 1, 1875) 14,421.

At Ryselt, a village near Z., is a reformatory, called the Netherlands Mettray, in which about 150 boys are educated, and taught farm-labour, and various handicrafts. It was founded in 1851, and has done much good. Nearly one-half of the boys have been withdrawn by their parents. The others obtain situations through the directors. The largest number have taken to farm-labour and gardening, for which the reformatory specially prepares them. Many have become soldiers and sailors; others smiths, house-painters, shoemakers, tailors, bakers, bricklayers, house-servants, &c. The institution is maintained by annual contributions, legacies, and a small charge for each boy. The receipts are about £3500 annually, of which, on an average, a half is from legacies and contributions. The expenditure is about the same.

ZVENIGORODKA, an old town of Russia, government of Kiev, on the Tikritsch, a tributary of the Bug, about 98 miles south of the town of Kiev. Pop. 11,200. The trade and manufactures are not worthy of notice.

ZVORNİK, a town of European Turkey, in the province of Bosnia, on a narrow strip of land on the left bank of the Drina, about 60 miles north-east of Bosna-Seral. The town is strongly fortified, standing on the face of a steep hill, at the summit of which is a strong fortress commanding the valley of the Drina. It has several mosques, Greek and Roman Catholic churches, lead mines, and a considerable trade in timber. Pop. about 12,000.

ZWEI BRÜCKEN. See DEUX-PONTS.

ZWICKAU, a picturesque, irregularly-built, ancient-looking town of Saxony, in a pleasant valley on the left bank of the Mulde, 60 miles south-west of Dresden. The river is crossed here by three bridges. The town is the capital of the circle of Zwickau, and is the seat of a district court, court of appeal, and other public offices. Of its churches, the most noteworthy is that of St Mary, the finest Gothic edifice in the Erzgebirge, dating from 1453, distinguished by its tall tower, from which an extensive view can be obtained; it contains a very fine altar-piece by the old German master Wohlgemuth, and other interesting works of art. There are also a splendid court-house and exchange; a cloth hall, a district infirmary; a gymnasium, with a library of 20,000 vols.; a burgher, Catholic, trade, and other schools; an old castle, which has been converted into a workhouse. The town is prosperous, and the population increasing. There are cloth manufactories, breweries, dye-works, chemical works, tanneries, oil and saw mills. The chief source of its wealth, however, and that of the neighbouring villages, are the rich beds of coal in the surrounding district. There are also large iron-works in the neighbourhood. The town is connected by railway with Leipzig, Dresden, and other important places, and has a considerable transit trade. Pop. (1875) 31,491.

ZWINGLI, ULRICH, one of the most important of the reformers, was born 1st January 1484, at Wildhaus, in the canton of St Gall, Switzerland, and was one of eight sons of the amtmann of that place. He studied first at Bern; then at the university of Vienna, where he devoted himself to philosophy; and afterwards at Basel, where, under Wytttenbach, he directed his attention to theology. He became pastor in 1506 in Glarus. At this time, his studies were chiefly directed to the Latin classics and the church Fathers; but having begun to learn Greek in 1513, he from that time devoted himself to the New Testament. He wrote out the Epistles of Paul in the original language, and learned them by heart, which was of great service to him afterwards in his disputations. In the capacity of army chaplain, he attended the campaigns in Lombardy of the inhabitants of Glarus for the pope against the French, in 1512, 1513, and 1515, for which service he received a pension from the pope till 1517. In 1516, the liberal-minded administrator, Geroldseck, invited him to be preacher in the convent of Maria-Einsiedeln, famous for its pilgrimages. Here Z. began to preach against many abuses prevailing in the church; he also called on the bishops of Sitten and Constance to bestir themselves for the improvement of the church under the guidance of the Word of God. So little was he then suspected, that the papal legate, Antonio Pulci, conferred on him, in 1518, the diploma of chaplain to the Holy See. He was soon afterwards called to Zürich; and he entered on his office as pastor in the great cathedral there, 1st January 1519, with a discourse, in which he declared himself for the pure gospel unfettered by glosses. In this office, to which was joined in 1521 that of canon in the cathedral, he laid the foundation of his subsequent work as reformer. The same cause that had stirred Luther into activity gave the impulse to Zwingli. In 1518, Bernardin Samson, a Franciscan from Milan, came to Switzerland for the purpose of selling indulgences for the benefit of the papal court. Z., who was still in Einsiedeln on Samson's first appearance, opposed him both there and afterwards in Zürich with the whole force of his pulpit eloquence, and succeeded so well that Samson was not allowed to enter the town of Zürich. From this time, Z., although attacked by the monks and many of his brother canons, advanced with rapid steps in his reforming career; for the magistracy of Zürich supported his measures to such a degree that, as early as 1520, they issued an order throughout their jurisdiction that the Word of God should be taught without human additions. In 1522, the Reformation was formally established in Zürich. At this time, Z. wrote his first book against the fasts of the Roman Church; he also began to study the Hebrew language. The offers of high promotion made to him by Adrian VI. could not make him waver. In January 1523, the government of Zürich invited all theologians disposed to enter the lists with Z. to a conference at Zürich, which was attended by 600 clergy and laity. Z. had arranged the articles of faith, to the number of 67, which were to be the subject of the conference, and defended them so ably against the attacks of the celebrated Joh. Faber, afterwards Bishop of Vienna, that the council of Zürich declared in favour of Z.'s doctrines, and upheld him and his assistants in adhering to them. The second disputation, October 1523, at which Z., before more than 900 people, spoke against the worship of images and the mass, was the cause of the removal of all pictures and statues from the churches of the city of Zürich and its jurisdiction; and this was followed, in 1524, by the abolition of the mass. In the same year, Z. entered into the

married state with Anna Rheinhard, aged 43, the widow of a nobleman of the name of Meyer von Knonow. In the following year, he published his creed, *Von der wahren und falschen Religion* (Of the True and False Religion). He had thus, in a few years, placed the work of reformation in his native land on a solid footing. He now pressed zealously forward in the same course; while the magistracy of Zürich, who all along actively supported him, abolished the begging friars, brought matters relating to marriage before the secular courts, and instituted a better management of church property. On a great many points, Z. was at one with Luther and the other German reformers; only, in regard to liturgical matters, he carried out his reform more radically according to the Bible, and rejected the dogma of the presence of Christ in the Lord's Supper. In order to heal the breach that had, as early as 1524, broken out between the two parties of the new religion on the latter point, a meeting between the Saxon and Swiss reformers was brought about by Philip, Landgrave of Hesse, at Marburg in 1529. The conference lasted for three days, but little progress was made towards unity of opinion. See SACRAMENTARIAN. In 1531, open war broke out between Zürich on the one side, and the Catholic cantons of Lucerne, Schwyz, Uri, Unterwalden, and Zug on the other; and Z., by command of the council of Zürich, had to take the field with the banner of the canton, which had always been borne by a priest. On the 11th October came the conflict; and as their opponents were more than double in number, and also better led, the Zürichers were beaten, and Z. was among the fallen. His collected works were published in Zürich in 1545, in 4 vols.; a selection, in two vols., appeared in 1819—1821, edited by Usteri and Vögelin.—See Rotermund, *Z.'s Leben* (Brem. 1818); Hottinger, *Huldr. Z. und Seine Zeit* (Zür. 1842).

Of all the reformers, there is none more fitted to excite our love and respect than Zwingli. Fearlessly honest in purpose; with a clear head and eye for the truth; less violent, if less eloquent than Luther; more candid and open-minded, if less systematic and penetrating in spiritual insight than Calvin; he stands before us quite as original, if not as prominent as these reformers. His work was not so great as theirs, his influence not so extended; but his character was quite as genuine, and his labour, in some respects, quite as enduring.

ZWOLLE, the capital of the Netherlands province of Overijssel, is situated on the Zwart Water, and by the canal called the Willemsvaart has connection with the Yssel. It is one of the finest towns in the kingdom, having many beautiful private and public buildings. Both within and without the gates are pleasant promenades and drives, shaded by large trees. The surrounding country consists of rich meadows and cultivated fields, adorned by pretty country-seats. Z. has three extensive suburbs—Diezenpoorten, Kamperpoorten, and Sassenpoorten. It is most favourably situated for commerce, having, by navigable waters and railways, communication with the provinces around the Zuider Zee, Hanover, England, and other maritime nations. The trade in farm-produce and stock is very great. Principal industries are shipbuilding, tanning leather, rope-spinning, beer-brewing, soap-boiling, weaving calicos and stockings, book and plate printing, making salt, cooperage, and refining sugar. The most important buildings are the Town House, Palace of Justice, and Great Church. There are many excellent charitable institutions; and besides those for the ordinary branches of education, a flourishing grammar-school, in which Pope Adrian VI. was partly educated, and a school of design. Z. has



a cabinet of natural history, a literary and a musical society. Here the poet Rhynvis Feith (1753—1824) was born, and Thomas à Kempis lived during 71 years. Between 1815 and 1875, the pop. increased from 12,870 to 21,310.

ZYGODACTYLA (Gr. yoke-footed), a name given by some naturalists to a section of *Pachydermata*, distinguished by having two principal hoofs upon which the animals walk, so that the foot resembles that of the *Ruminantia*. This section includes only one family, the *Suidæ*.—The term ZYGODACTYLOUS BIRDS is often applied, in Ornithology, to those birds which have the toes in pairs, two before and two behind, as most of the *Scansores*, or Climbers (q. v.).

ZYGOPHYLLA CÆÆ, a natural order of exogenous plants, allied to *Rubiaceæ*, and containing about one hundred known species; herbaceous plants, shrubs, and trees, chiefly natives of subtropical countries. They have opposite, generally pinnated leaves, without stipules. The flowers are solitary, or two or three together; the calyx 4—5-parted; the petals alternate with the calyxine segments, and clawed; the stamens twice as many as the petals, generally rising from the back of small hypogynous scales; the ovary simple, 2—5-celled, with two or more ovules in each cell. The fruit is capsular, rarely somewhat fleshy, with four or five angles or wings. The most important genus is *Guaiacum* (q. v.). The abundance of species of *Zygophyllum* and some other genera constitutes one of the most striking features of North African and Arabian deserts. The flowers of *Z. sabago* are employed as a substitute for capers, under the name of *Bean-capers*. Those of *Melanthus major*, a native of the Cape of Good Hope, abound so much in honey, that it is obtained from them for use by merely shaking the branches. The Turks use the seeds of *Peganum harmala* both as a spice and for dyeing red.

ZYMOTIC DISEASES have been already referred to, and the most important of them are mentioned in the article NOSOLOGY. The class of diseases to which Dr FARR has assigned this now generally accepted term, comprises those which are epidemic, endemic, and contagious, as, for example, fever, small-pox, plague, influenza, cholera, hooping-cough, &c. As Dr FARR observes: 'The diseases of this class distinguish one country from another, or one year from another; they have formed epochs in chronology; and as Niebuhr has shewn, have influenced not only the fate of cities, such as Athens and Florence, but of empires; they decimate armies and disable fleets; they take the lives of criminals that justice has not condemned; they redouble the dangers of crowded hospitals; they infest the habitations of the poor, and strike the artisan in his strength down from comfort into helpless poverty; they carry away the infant from the mother's

breast, and the old man at the end of life; but their direct eruptions are excessively fatal to men in the prime and vigour of age. They are emphatically called the *morbis populares*.' It must not be assumed, as the origin of the word (*zymé*, the Gr. for a ferment) might lead the reader to infer, that all the so-called zymotic diseases are true fermentations, for the class is intended to comprehend all the principal diseases which have prevailed as epidemics or endemics, and all those which are communicable either by human contact or by animals in a state of disease, as well as the diseases that result from the scarcity and the deterioration of the necessary kinds of food, or from parasitic animals. The diseases of this class thus arrange themselves into the four orders of Miasmatic, Æthetic, Dietic, and Parasitic disorders, of which fever, syphilis, scurvy, and worms may be regarded as the types.

Dr Carpenter, in a Memoir on *The Predisposing Causes of Epidemics*, shews that the conditions which give rise to zymotic diseases may be referred to the three following categories: (1.) Conditions which tend to introduce into the system decomposing matter that has been generated in some external source, as, for example, putrescent food, water contaminated by sewage, or other decomposing matters, and air charged with miasmatic emanations. (2.) Conditions which occasion an increased production of decomposing matter in the system itself. The best example of this class of conditions is afforded in the puerperal state (or childbed), in which the tissue of the womb is undergoing rapid disintegration, and the decomposing matters which would be harmless at other times, are now able to act upon the blood of the woman, so as to induce that most fatal of all the zymotic diseases, puerperal fever. (3.) Conditions which obstruct the elimination of the decomposing matter normally or excessively generated within the system, or abnormally introduced into it from without. For example, any obstacle to the elimination of urea or uric acid, carbonic acid, biliary matters, lactic acid, &c., gives rise to as true poisoning as if these substances had been injected into the blood-vessels. The most important of the laws by which zymotic poisons are governed, are noticed in the article VIRUS.

The average annual rate of mortality in this country at the present time is nearly 22 per 1000, or 1 in 45 of the population; and the deaths from zymotic diseases vary from 21 to 26 per cent. (or amount to nearly one-fourth) of the total number of deaths. Taken in order of their greatest fatality they would be thus arranged: cholera, typhus and other forms of continued fever, scarlatina, hooping-cough, measles, croup, small-pox, dysentery, and erysipelas—the other diseases being less fatal.—For further information on the subject of this article, the reader is referred to Aitken's *Science and Practice of Medicine*.

# SUPPLEMENT.



**ABBEVILLE**, a fortified town of France, in the dep. of Somme, stands on the river Somme, about 12 miles from its mouth, and 90 miles N.-by-W. of Paris. It is built partly on an island, and partly on the banks of the river; the streets are narrow and ill paved, and the houses built mostly of brick and wood.

The building most worthy of notice is the Church of St Wolfran, commenced in the reign of Louis XII., whose façade is a splendid example of the Flamboyant style, being pierced by three deep portals, and surmounted by three high Gothic towers. The chief manufactures of A. are velvets, serges, cottons, linens, sacking, hosiery, jewellery, soap, glass-ware, glue, paper, &c. It is a station on the Railway du Nord, and is connected by canals with Amiens, Paris, Lille, and Belgium. Vessels of between 150 and 200 tons can sail up the Somme as far as Abbeville. Pop. (1872) 16,753.

**ABBLIA'TÉ-GRASSO**, a town of Italy, in the province of Milan, 14 miles west-south-west from Milan city, on the Canal di Bereguardo. It has silk manufactures. Pop. 5200.

**ABEOKUTA**, a city, or rather collection of small towns or villages, capital of the territory of Egba, in the Yoruba country, on the west coast of Africa. A. is about 80 miles, by the river Ogun, north of Lagos (on the Bight of Benin), and 240 miles west of the Lower Niger. It is situated 567 feet above the sea-level, on an undulating plain, fantastically broken by masses of gray granite, and covered with bush. Looking down on the city from a height, Burton says: 'The scene before me wants neither grandeur nor beauty; there is a gorgeous growth around—hill, water, forest, and homestead all are present. . . . The primeval forest has been cleared away around the town, yet there is not a vestige of cultivation; and if you ask for the farms, you are told that they are distant some 5 to 20 miles. The reason is that, if placed within reach, nothing could defend them from the depredations of robbers and cattle.' A. is surrounded by a wall of hardened mud, from 18 to 20 miles in circumference, between 5 and 6 feet high, without embrasure, and pierced here and there 'with an aperture by way of loophole.' The town itself, Burton found to measure 4 miles by 2. The houses are square, and built of mud, with tall roofs of thatch; the streets are narrow and irregular, and the only scavengers are the sun, the vulture, and the pig. There are a few European traders and missionaries; the success of the latter, according to Burton, not having been extraordinary. There is a trade in palm-oil and grain. Pop. estimated at 150,000.—For further interesting details, see R. F. Burton's *Abeokuta and the Camaroons Mountains* (1863).

**ABERAVON**, or **PORT TALBOT**, a parliamentary and municipal borough on the south coast of Wales, in Glamorganshire, near the mouth of the Avon, about 30 miles west of Cardiff. It is beauti-

fully situated near the valley of Cwm Avon, in which are extensive mining-works belonging to the Bank of England. The town has a good harbour and docks, is a station on the South Wales Railway, and communicates regularly with Bristol by steamers. The valley of the Avon is shut in by lofty hills, while every available space is occupied by copper and iron works. There is a stone bridge of one arch over the river. A. imports ore from Cornwall; and exports copper, tin, and coal. Along with Swansea, Neath, &c., it returns one member to parliament. Pop. of municipal borough (1871), 3574; of parliamentary borough, 11,906.

**ABERGAVENNY** (the Roman *Gobanium*), a market-town of England, in Monmouthshire, 13 miles west of Monmouth, is beautifully situated in the valley of the Usk (the garden of Wales), at the junction of the Usk and Gavenny, and is surrounded on every side by high mountains and thick woods. The town is regularly and compactly built, and many improvements have of late years been made. St Mary's Church, which was once a fine cruciform structure, and contains many interesting monuments, has been spoiled by alterations. The castle, which is very ancient, is now a ruin. The principal modern building is the lunatic asylum. There are collieries and iron-works in the neighbourhood. The Hereford and Tredegar Railway passes near the town. Pop. (1871) 4803.

**A'BINGTON**, a township of Massachusetts, U. S., 20 miles south-east of Boston, with a population, in 1870, of 9308, engaged in the manufacture of boots, shoes, and nails.

**ABOMEY**. See **DAHOMEY**.

**ABORTION** is the term used in Medicine to denote the expulsion of the product of conception (the impregnated ovum) from the womb before the sixth month of pregnancy. If the expulsion takes place after that date, and before the proper time, it is termed a *premature labour* or *miscarriage*. In law, no such distinction is made. The frequency of abortion as compared with normal pregnancy is very differently estimated by different writers; but the best evidence leads us to the belief that abortion is of far more common occurrence than is generally supposed, and that it takes place on an average in one out of every three or four cases of pregnancy. The following are amongst the *causes predisposing* to this accident: (1) A diseased condition of either parent, and especially a syphilitic taint. (2) A peculiar temperament on the part of the mother. Those women who present a strongly-marked nervous or sanguine temperament seem to abort with singular facility; and the same tendency is observed in those in whom the catamenial or monthly discharge is abundant or excessive. Again, very fat women, while they have a tendency to sterility, are liable to abort when pregnancy does occur. Any cause interfering with the normal oxidation of the blood—as, for instance, the constant breathing of impure air, may provoke abortion—a fact excellently illustrated by the experiments of Brown-Sequard on pregnant

animals (rabbits), when he shewed that the application of a ligature to the windpipe excited uterine contractions, ending, if the experiment were continued long enough, in abortion, but ceasing if air was freely readmitted into the lungs. Change of climate, as from India to England, certainly predisposes to this accident; and it has been observed by various writers that great political events, the horrors of war, and famine, exert a similar action. The marvellous events that occurred in Paris in 1848 were speedily followed by an extraordinary number of abortions and of still-born children; and a similar fact had been previously noticed by the elder Nagele and Hoffmann during the famine of 1816 and during the siege of Leyden. Nor can there be a doubt that, amongst the causes predisposing to abortion, must be included the employment of such corsets and other garments as by their tightness interfere with the circulation of the blood, and alter the natural position of the womb and of the abdominal viscera. Many diseases supervening during the course of pregnancy, especially the eruptive fevers (as small-pox, scarlatina, &c.), almost invariably lead to abortion of a very dangerous character; and it has been known from the time of Hippocrates that intermittent fevers have this effect. Amongst the *direct causes* of abortion may be placed blows on the abdomen, falls, any violent muscular efforts, too long a walk or ride on horseback (indeed, women with a tendency to abort should avoid horseback during pregnancy), a severe mental shock, &c. Moreover, the death of the fetus from any cause is sure to occasion abortion.

The *symptoms* of abortion vary according to the stage of pregnancy at which it is threatened, and according to the exciting cause. Many of these resemble those of congestion of the womb, such as a sensation of weight or painful pressure in the region of the loins or sacrum, extending to the bladder and rectum (with or without Teneamus, q. v.); these symptoms being aggravated by standing or walking, and being accompanied by chills, accelerated pulse, loss of appetite, and a general feeling of discomfort. A discharge of serous fluid, sometimes slightly tinged with blood, is then observed. The feeling of weight is replaced by pains, leading to the expulsion of the ovum, which, during the first two months, is so small as commonly to escape detection. In more advanced stages of pregnancy, the pains are more severe, the discharge is more abundant, and consists chiefly of blood; and after more or less time, the product of conception escapes either in whole or in part. In the former case, the patient has little further trouble; in the latter, hæmorrhage will probably continue, and the parts retained may putrefy, and give rise to serious symptoms. After about the commencement of the fourth month, the symptoms gradually approximate to those presented in ordinary parturition.

In the *treatment* of abortion, prophylactics (or the guarding against causes likely to lead to it) hold the first place. Women liable to this affection should, on the slightest threatening, assume as much as possible the horizontal position, avoiding all bodily exertion or mental excitement. They should use non-stimulating foods and drinks, and keep the bowels open by gentle aperients—such as manna and castor-oil, and carefully avoid aloe and other medicines irritating the lower bowel. Moreover, a separate bedroom must be insisted on by the physician. We shall only enter into the curative treatment so far as to state that if it is deemed necessary to check hæmorrhage before professional aid can be called in, cloths soaked in cold water may be applied locally (care being taken to change them before they grow warm), and iced water containing

an astringent, such as a little alum, may be given internally. Further proceedings must be left to the medical attendant.

There are occasional cases (as where the outlet of the pelvis is very contracted) in which it is necessary to induce abortion by professional means, but it would be out of place to enter into this subject in these pages. It cannot be too generally known, that all attempts at procuring criminal abortion, either by the administration of powerful drugs, or the application of instruments, are accompanied with extreme danger to the pregnant woman.

ABOUT, EDMOND FRANÇOIS VALENTIN, a French littérateur of great and rising reputation, was born at Dieuze, on the 14th February 1828. He studied first at the Lycée Charlemagne, where he greatly distinguished himself; and afterwards at the Ecole Normale. In the beginning of 1852, he received an appointment to the French School at Athens, an institution supported by the French government, with no very definite object, but with the hope that the members, who are selected on account of their attainments and promise in scholarship, and left perfectly free to choose their own studies, should be able to make contributions to the history or the archæology of Greece. A. remained at Athens for about two years. He wrote, as required by the terms of his appointment, a Memoir for the Academy of Inscriptions, entitled *L'Île d'Égine*; but it was as the satirist of modern Greece, not as the investigator of Grecian antiquities, that his name first became familiar to the public. On his return to France, towards the end of 1853, he published *La Grèce Contemporaine*, a work which at once attained to great popularity, and was in course of the following year translated into several foreign languages. This work, full of lively and pointed sketches, abounding in shrewd and witty observation, its censures, very severe as they were, scarcely seeming offensive, from the ease and perfect good-humour with which they were conveyed, at once made its author be regarded as among the most promising writers of the day. It unquestionably affected European opinion as to the character and the capabilities of the modern Greeks; the truthfulness of its portraiture being confirmed by all who had special knowledge of this people. It gave earnest of the qualities which go to making a brilliant novelist; and A. did not long delay to come before the public as a novelist. His first novel, *Tolla*, appeared in the *Revue des Deux Mondes*, and was republished early in 1855. It did not disappoint the high expectations formed of it; but the author had laid himself open to a charge which, whenever it can be colourably sustained, is certain to be disastrous. He had taken many of his leading incidents from an Italian work, *Vittoria Savorelli*, published in 1841, and soon after withdrawn, the incidents contained in which were well known as actual occurrences; and though something of this was hinted in the book, there was no distinct acknowledgment of it. A hue and cry of plagiarism was got up against A., from which his reputation took some time to recover. His comedy, *Guillery*, brought out in February 1856 at the Théâtre Français, did not make his peace with the Parisians; it was a complete failure, so far as the theatre-going public was concerned, and had to be withdrawn after two representations. A set of stories which he now began to contribute to the *Moniteur*, however—*Les Mariages de Paris*—had a success which more than made up for the savage criticism which he had had to endure; they placed him high in public favour; and since then, his career has been a series of successes. *Les Mariages de Paris* was followed by *Le Roi des Montagnes* (1856), *Germaine* (1857), *Les Echasses de Maître Pierre*

(1857), and *Trente et Quarante* (1858)—all novels originally contributed to the *Moniteur*.

In 1859, after a tour in Italy, of a portion of which he contributed a description to the *Moniteur*, A. published a political pamphlet—*La Question Romaine*—which, displaying the same qualities as his early work on Greece, but matured, and wielded for a definite object, and being, moreover, regarded as written with the approval of the Emperor of the French, created a sensation throughout Europe. His object was to expose the abuses of the ecclesiastical government at Rome; and numerous answers to his work were made by friends of the papacy. In the following year, he published two political pamphlets, *La Nouvelle Carte d'Europe*, and *La Prusse en 1860*; both of which, being taken as indicative of the Emperor Napoleon's leanings, underwent criticism in all parts of Europe. A second work on Rome—*Rome Contemporaine*—appeared in 1861. M. A. was decorated with the Legion of Honour in 1858.

Of late years, he has been producing novels with unabated popularity; and he has also written several slight dramatic pieces, which have been favourably received. It is unnecessary to put down a catalogue of works which are perfectly familiar to those who are interested in French contemporary fiction. In 1864, he published *Le Progrès*, a work of considerable pretensions, in which he discussed at great length, but with his usual liveliness of style, the existing state of society, especially in France, and the methods of improving it. His conclusion was that in France there were needed for progress the liberty of association (for the purposes of production and trade), an amendment of the land-system, a proper distribution of population as between country and town, the absence of police interference in the affairs of private persons, freedom of religious worship, and other similar conditions. In 1868, A. became a leading contributor to the *Gaulois* newspaper. At the outbreak of the Franco-German war in 1870, he accompanied the army of MacMahon to Alsace as special correspondent of the *Soir*, and in 1872 he became editor of *Le XIX<sup>me</sup> Siècle*. He published *Alsace* in 1872. In the same year he suffered a week's imprisonment, for some abusive newspaper articles, from the German authorities, who chose to consider him as a German subject from his being a native of Lorraine.

ABU', a mountain of India, in the territory of Serolie, in Rajpootana, rising far above any other of the Aravulli ridge, and said to be about 5000 feet above the sea. The base is broad, its circuit being estimated at forty or fifty miles; the summit is very irregular, and divided into many peaks. It is a celebrated place of pilgrimage, especially for the Jains, who have a magnificent group of four temples at Dilwara, about the middle of the mountain, one of which is described as 'the most superb of all the temples in India.' Before it, is an equestrian statue of the founder, Bimul Sah, a Jain merchant of Anhulwara. All the temples exhibit symptoms of decay. The summit of A. is about 40 miles north-east from the British cantonment of Deesa, and it has lately begun to be used as a sanatorium.

ACARUS FOLLICULORUM is the most generally accepted name for a microscopic parasite residing in the sebaceous sacs and hair-follicles of the human skin. It is also known as the *Demodex folliculorum*, the generic name being derived from the Greek words *demos*, lard, and *dax*, a boring worm. It was first described by Dr Simon of Berlin in 1842, under the title of *Acarus folliculorum*, which was suggested by the eminent zoologist, Erichsen of Berlin. In the following year, Mr

Erasmus Wilson made it the subject of an elaborate memoir which appeared in the *Philosophical Transactions*, in which, as there are doubts as to its exact zoological position, he simply terms it the *Entozoon folliculorum*. According to Professor Owen, who gave it the name of *Demodex*, it represents the lowest form of the class *Arachnida*, and makes a transition from the *annelids* to the higher *articulata*. As regards the size and form of these animals, there is much variety; they pass their whole existence in the fatty matter of the sebaceous cells, moulting repeatedly during their growth, and being finally expelled from the follicles with the secretions of these organs. Their presence has no reference, according to Mr Wilson, to disease of the skin or of the follicles. They are met with in almost every person, but are most numerous in those in whom the skin is torpid, in invalids, and in the sick. They vary in length from  $\frac{1}{16}$ th to  $\frac{1}{8}$ th of an inch, and the accompanying figure represents the magnified parasite. Their number is various; in some persons not more than two or three can be found in a follicle, while in others Mr Wilson has seen upwards of fifteen. The head is always directed inwards, and when a number are present they seem to be collected into a conical bundle, the larger end of the cone being formed by their heads. The situation in which they are most commonly found is the skin of the face, and particularly that of the nose, but they have also been met with in the follicles of the back, the breast, and the abdomen. As far as we know, they are never found on the limbs.

A reference to the figure shows that the animal possesses eight thoracic appendages (c, c) of the simplest and most rudimentary kind, each of which is terminated by three short setae. The integument of the abdomen is very finely annulated. The mouth is suctorial or probosciform, consisting of two small spine-shaped maxillae (b), and an extensive labium capable of being elongated or retracted; it is provided on each side with a short, thick, maxillary palp (a, a), consisting of two joints with a narrow, triangular labrum above. The sexes are distinct, but the differences between the male and female are not well recognised. Ova are frequently seen, both in the body of the female and in detached discharged masses. Any of our readers may readily observe their own *acarri* by collecting between two pieces of thin glass the expressed fatty matter from a nasal follicle, and moistening it with a drop of olive oil. Very similar if not identical animals have been found in the contents of the pustules of mangy dogs.



*Acarus folliculorum* magnified.

ACAYUCAN, a town of Mexico, a military port, about 100 miles south-south-east of Vera Cruz, having trade in cochineal. Pop. 6000.

ACCRINGTON, a manufacturing town of England, in Lancashire, which has recently increased much in size and importance, lies in a deep valley, surrounded by hills, about 34 miles north-east of Liverpool, and 13 miles east of Preston, on the banks of the Hindburn. Pop., including Old A. (1861), 17,688; (1871) 21,788. Christ Church is a fine Gothic building, erected in 1838. The inhabitants are mostly employed in cotton factories, weaving, and calico-printing. A. is considered the centre of the cotton-printing business. There are coal-mines in the neighbourhood, in which many of the inhabitants find employment.—OLD A. is an adjacent chapelry, also with cotton manufactures.

**ACERRA** (anc. *Acerra*), a town in South Italy, in the province of Caserta, nine miles north-east of Naples, with which it is connected by railway. It was once fortified, but the walls are now crumbling into ruins. It has a cathedral and seminary. The country around is fertile, but extremely unhealthy, being afflicted with malaria, caused partly by the sluggish artificial channels called the Regi Lagni, the representatives of the *Clanias non equus Acerris* of Virgil; and partly by the flax-grounds, where the stalks are left to macerate. Pop. nearly 12,000.

**ACETAL** ( $C_{12}H_{14}O_4$ ) is a colourless liquid, of an agreeable odour, and a flavour said to resemble that of the hazel-nut. It is one of the products of the slow oxidation of alcohol under the influence of finely-divided platinum, or of chlorine, or of dilute sulphuric acid and peroxide of manganese. Its specific gravity is 0.821, and it boils at 221°. It yields various reactions and products of interest in organic chemistry.

**ACETIFICATION.** Since the article **ACETIC ACID** was originally written, a totally new view has been adopted regarding the process by which wine, beer, cider, and alcoholic fluids generally become converted into acetic acid, when they are exposed to the action of the air, and especially in hot weather. The views held by Liebig regarding the part that wood-shavings, sand, ash, &c. play in condensing oxygen, and transmitting it to the alcohol, are now supplanted by those of Pasteur, who maintains that the true acetifying matter is a very minute mycoderma—a special vegetable organised being. It is impossible to conceive a more simple form of vegetation, consisting of extremely minute spores arranged in chains; each spore having a mean diameter not exceeding  $\frac{1}{1000}$ th of an inch, and the length being about twice as great. The rapidity of the development of these spores, under favourable circumstances, is almost inconceivable; and the power which they possess in fixing the oxygen of the air, and of transmitting it to the alcohol, and of establishing an incomplete combustion of the latter, is no less wonderful. A surface of a square yard covered with this plant, is able, in the course of 24 hours, to fix the oxygen of more than 1000 quarts of air. The temperature of the surface of the fluid at which this slow combustion is proceeding is considerably raised, and often remains for several days at 21° or 25° above that of the surrounding air. The process which has just been described bears a very close analogy to the respiratory process, the oxygen of the air being in one case fixed by minute vegetable cells, and in the other by the blood corpuscles.

**ACETYL** ( $C_2H_3O_2$ ), known also under the names *Acetoyl* and *Oilyl*, is an organic radical not yet isolated, but which is supposed to exist in acetic acid and its derivatives; the rational formula for acetic acid being on this hypothesis  $C_2H_3O_2 \left. \begin{matrix} \\ H \\ \end{matrix} \right\} O_2$ .

See **TYPES, CHEMICAL.** The reason for assuming the existence of this radical in the acetic compounds is, that the formula to which it leads affords the simplest explanation of the most important reactions of acetic acid. Thus, when acetic acid is treated with a metallic oxide or hydrate, the basic atom of hydrogen is replaced by a metal, and an acetate of the metal  $C_2H_3O_2 \left. \begin{matrix} \\ M \\ \end{matrix} \right\} O_2$  is produced.

The term *acetyl* was formerly applied to the radical  $C_2H_3$ , and the anhydrous acid was regarded as a binoxide of this radical. Hence the two other names for the subject of this article—the former suggested by Kolbe, and the latter (an abbreviation of oxygen-ethyl) by Williamson.

**ACHALGA'NJ**, a town of British India, in the south part of the chief-commissionership of Oude, four miles north-east from the Ganges, in N. lat. 26° 25', and E. long. 80° 35'. Pop. 5000, of whom 500 are Mohammedans, and the rest Hindus.

**A'CHORÉS** are one of the forms of pustules—viz, that in which the pustules are very small, but have large inflamed bases. They are most common on the faces of children, and their secretion forms those large, thick, irregular scabs, resembling dried honey, which are so common on children's chins. They seem to be inflamed hair sacs or sebaceous follicles. Their treatment is the same as that for Impetigo (q. v.).

**A'ONÉ** (probably from Gr. *akme*, an efflorescence) is an important skin disease. It is placed by some dermatologists in the order *Pustula*, and by others in the order *Tubercula*, which includes solid, hard elevations of the skin, much larger than *Papula*. The sebaceous follicles of the Skin (q. v.) are the primary seat of the affection. Their natural secretion accumulates in their interior, and there is, at the same time, a tendency to inflammation of the follicle and surrounding tissue. It is by no means rare to find on the face and shoulders of young persons about or above the age of puberty a number of black spots, each of which is placed on a slightly-raised pale base. These black points are called *comedones*. Pressure at the base occasions the expulsion of a little, elongated, spiral, white mass, with a black point or anterior end, commonly but erroneously regarded as a worm.\* Interspersed are other spots, with the base more raised and inflamed, which become more or less perfect pustules, each of which rests on a comparatively large red base. In some of the inflamed follicles, coagulated lymph (to use the old phraseology) is thrown out, and a small hardened mass is the result. According as one or other of these appearances preponderates, we have different varieties of this disease. When the pustule is the most striking feature, the affection is called *Acne simplex* or *vulgaris*; when the black points abound, it is *Acne punctata*; and when there is decided induration, it is *Acne indurata*. We have already mentioned the age at which this affection commonly occurs: it is never seen in children, and is rare in aged persons.

As long as there is no inflammation, the treatment simply aims at favouring the escape of the contents of the sebaceous follicles, by rubbing the face and other affected parts with cold cream at bedtime, washing on the next morning with soap and water, and gentle subsequent friction with a soft towel. When acute inflammation is present, and the pustules are very tender, there is no better application than tepid water, with or without a little gelatine in solution; and subsequently the ointment of the hypochlorite of sulphur has been found useful by Wilson and others. *Acne indurata*, which is the least tractable of the three forms, is sometimes benefited by the application of fly-blisters. In all these cases, the state of the digestive organs must be carefully attended to.

*Acne Rosacea* is, according to some writers, a much more grave variety of acne; while others regard it as a special disease, to which they assign the name of *Rosacea*, under which term it is described in this work.

**ACQUAVIVA**, a town of South Italy, in the province of Bari, 16 miles south of the town of Bari, in a healthy situation at the foot of the Apennines. It is surrounded with walls and ditches, has a

\* In the midst of the white mass of sebaceous matter, a parasite, *Acarus folliculorum* (q. v. in SUPPLEMENTS), is, however, often found.

handsome parish church, several convents, two hospitals, &c. Pop. 7600.

A'CRI, a town of South Italy, in the province of Cosenza, 13 miles north-east of the town of Cosenza, in a beautiful and healthy situation, with a fertile country around. Pop. 9500.

ACRITOCRO'MACY (Gr. *akritos* and *chromatia*, which, when associated, imply 'inability to discriminate between colours') is a term which seems likely to supersede *Colour Blindness*, *Daltonism*, *Achromatopsia*, &c.

A'CROLEIN ( $C_8H_{10}O_2$ ) is a colourless, limpid, strongly refracting liquid, lighter than water, and having its boiling-point at about 125°. It constitutes the acrid principle produced by the destructive distillation of fatty bodies, and is in part due to the decomposition of glycerine. It is best prepared by distilling a mixture of glycerine and anhydrous phosphoric acid, the object of the latter being to effect the removal of the element of four atoms of water from the glycerine ( $C_3H_5O_3$ ), which contains the elements of acrolein ( $C_2H_3O_2$ ) + those of four atoms of water ( $H_2O_4$ ). In its state of vapour, it is extremely irritating to the eyes, nostrils, and respiratory organs—a property to which it owes its name. The pungent smell given off by the smouldering wick of a candle just blown out is due to the presence of acrolein. When mixed with a solution of potash or soda, the irritating odour disappears, and is replaced by one of cinnamon; while a brown resinous substance is formed; and certain oxidising agents, as oxide of silver, convert it into *acrylic acid* ( $C_3H_3O_2$ ).

A'CU'PRESSURE, a mode of arresting hæmorrhage from cut arteries. It is based on the principle of temporary metallic compression, and was first suggested to the scientific world by Sir James Y. Simpson, Bart., in a paper read before the Royal Society of Edinburgh, December 1859. The simplest mode of practising it may be thus described: The needle is passed through the flaps or sides of the wound, so as to cross over and compress the orifice of the bleeding artery, just as in putting a flower in the lapel of one's coat, one crosses over and compresses the flower-stalk with a pin pushed twice through the lapel. The middle portion of the needle—the only part of it which is in immediate contact with the fresh surface of the wound—bridges over and compresses the artery at its bleeding orifice, or perhaps a line or two more on its cardiac side. The head and point of the needle are

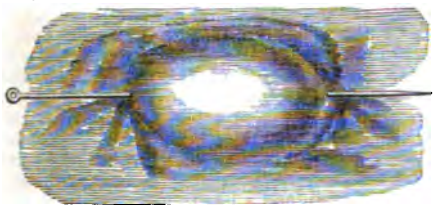

First Method.

exposed externally on the cutaneous surface of the flap or side of the wound. 'When passing the needle in this method,' says Sir J. Y. Simpson, 'the surgeon usually places the point of his left forefinger or of his thumb upon the mouth of the bleeding vessel, and with his right hand introduces the needle from the cutaneous surface, and passes it right through the whole thickness of the flap till its point projects for a couple of lines or so from the surface of the wound, a little to the right side of the tube of the vessel. Then, by forcibly inclining the head of the

needle towards his right, he brings the projecting portion of its point firmly down upon the site of the vessel; and after seeing that it thus quite shuts the artery, he makes it re-enter the flap as near as possible to the left side of the vessel, and pushes on the needle till its point comes out again at the cutaneous surface. In this mode, we use the cutaneous walls and component substance of the flap as a resisting medium, against which we compress and close the arterial tube. But in some wounds, a neighbouring bone or other firm unyielding texture forms the best and readiest point of resistance against which to pin and compress the artery by the acupressure needle.'

This is the first and simplest mode of applying acupressure. Six other methods, however, have been suggested; and as each of them has its peculiar appropriateness as a hæmostatic agent, it will be proper to enumerate and describe them. The appliances which these other methods require are—a pin with a glass head, to admit of sufficient pressure for introduction; a needle threaded with iron wire; and a loop of inelastic iron wire, 5 or 6 inches in length. The pins and needles should be of various sizes, and they should also be bayonet-pointed; the latter form being superior to the spear-pointed, as facilitating introduction, and as being less apt to cut the tissues.

Second mode: The needle is inserted in the fresh surface at a little distance from the vessel; it is pushed on, causing its point to rise up as near the artery as possible; it then bridges over and compresses the artery; then its point is made to dip into the raw surface of the wound on the other side of the vessel; finally, it is forced on until it emerges a second time on the wound. The passive or elastic iron wire with which it is threaded enables it to be easily withdrawn. Third mode: The needle is entered on

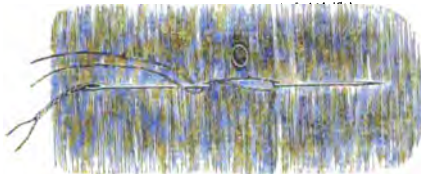

Third Method.

one side of the artery; is pushed behind so that its point emerges on the opposite side of the vessel; a loop of inelastic wire is then passed over its point, so as to bring the wire over the track of the artery and behind the stem of the eye-end of the needle; finally, the wire is drawn sufficiently to close the vessel, and is fixed by a twist or half a twist round the needle. The needle may again be withdrawn by the wire which threads it. Fourth mode: This differs from the third only in substituting a long pin with a glass head for the acupressure needle threaded with iron wire. The pin is preferred to the wire-threaded needle, as avoiding entanglement with the wire, and consequent pain in withdrawing the needle. Fifth mode: This, which, from its inventor, Dr Knowles, formerly house-surgeon of the Aberdeen Hospital, is also called the Aberdeen mode, has two varieties, which differ from each other only in the extent of the rotation given to the instrument by which the twist is effected. In the former variety, the instrument undergoes a half; in the latter, it undergoes a quarter, rotation of a circle. In either case, a threaded needle only, or a long pin only, is required. In the former, the instrument is inserted some lines to one side of the bleeding artery, and passed behind it; its point is then made

to emerge on the surface of the wound a few lines on the other side of the vessel. Then the needle (or pin) is twisted half a rotation, so as to bring its head to the side where its point was before making the twist—the instrument being now above instead of below the artery, and pressed well down upon it. Finally, the point of the instrument is pushed into the tissues beyond the artery, so as to secure it in the proper position, and retain the twist. The latter (and preferable) variety requires only a quarter-rotation to be given to the acupressing instrument. First, the needle (or pin) is entered on one side of the bleeding artery; then pressed onward a few lines in the same direction as the length of the vessel, so that its point emerges on the surface of the wound. Secondly, a quarter-rotation is given to it, so as to place it above the artery; and it is well pressed down against the small portion of tissues between the instrument and the vessel. Thirdly, the instrument is secured, and the twist retained by sending the point into the tissues beyond the artery. Sixth mode: This was devised by Dr Keith of Aberdeen, and requires a long pin with a duplicature of passive iron wire. The point of the pin is inserted a few lines from the artery; passed below or by the side of it; and afterwards pushed on so as to make the point emerge a few lines beyond the bleeding mouth. The duplicature of iron wire is then thrown over the point of the pin; then the two ends are crossed behind the stem of the pin, so as to take the bleeding mouth between them. The ends of the wire are then pulled tightly enough to stop the hæmorrhage; then brought forward by the sides of the pin (one on each side), and finally fixed by a half-twist in front of the pin, and close down upon it. Seventh mode: In this, a long needle is passed through the cutaneous surface pretty deep into the

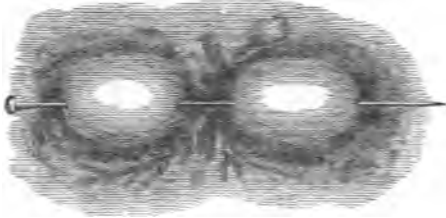

Seventh Method.

soft tissues, at some distance from the vessel to be compressed; then it is made to emerge near the vessel; then it bridges over and compresses the artery; then it is dipped into the soft parts on the opposite side of the vessel; and finally, its point is brought out a second time through the common integument.

The advantages of acupressure as a hæmostatic agent (though not universally recognised, and indeed strongly denied by some practitioners) have seemed to many eminent surgeons to be these: first, it is not only the easiest of application, but it is the quickest mode yet devised for arresting hæmorrhage; second, this abridgment of the time required for arresting hæmorrhage, lessens the risk of suppuration, and other effects of the higher grades of inflammation in the stump; third, it causes no condition which must be followed by suppuration, whereas the use of the ligature has never been known to obtain immediate union, or union by primary adhesion, without the formation of pus; fourth, it has never been followed by pyæmia—a constant and distressing result in the case of the ligature; fifth, the presence of a foreign body in the wound—always a source of irritation—is of much

shorter duration in the case of the needle than of the ligature, while the former does not divide and strangle the arterial coats, like the latter; sixth, the patient on whom acupressure has been practised is comforted by the assurance, that in a very few hours after the operation, all foreign matter will be removed from the wound—a consolation which he never enjoyed with the ligature.—*Proceedings of the Royal Society of Edinburgh*, vol. iv. p. 249; *Edinburgh Medical Journal*, January 1860; *Medical Times and Gazette*, February 11, 1860; *Acupressure*, 1 vol. 8vo, by Sir J. Y. Simpson (1865); and *A Practical Treatise on Acupressure*, by Mr Pirrie and Dr Keith (1867). [Few surgeons now use A.]

ADA, a town of the Austrian empire, in Hungary, eight miles south of Zenta. Pop. (1869) 9344.

ADAFUDIA, a town of the Felattah country, West Africa, about 400 miles south-east from Timbuktu, in about 13° 6' N. lat., and 1° 3' E. long. It is situated in a dry, healthy, and fertile plain, and is surrounded by a mud wall. Pop. supposed to be about 24,000. A large trade is carried on, and slaves form a principal part of the merchandise.

ADAMNAN, SAINT, a member of the early Irish Church, to whom the world is deeply indebted for the information about that remarkable community which he left to posterity. His name was properly Adam, of which Adamnan is a diminutive. It is one of the peculiarities of that early church that the genealogies of its eminent members have been preserved with a minuteness scarcely rivalled in the days of peerages. He was born in the county of Donegal about the year 625. In the words of Dr Reeves: 'His father, Ronan, was sixth in descent from Connal Gulban, the head of one of the two great races of the Northern Hy Neill, and in virtue of his birth, claimed kin to St Columba and many of the sovereigns of Ireland. The father of Ronan was Tinne, from whom came the patronymic *Ua Tinne*, or grandson of Tinne, an appellative which is occasionally found coupled with A.'s name. Ronnat, the mother of A., was descended from Eana, a son of Niall, whose race, the Cincl Enna, possessed themselves of the tract lying between the channels of the Foyle and Swilly, which was called the Tir Enna, or land of Enna, and answers to the modern barony of Raphoe. He was, like many of the eminent Irish clergy, a statesman as well as an ecclesiastic, and we hear of his being sent on missions from his own people to Alfred, king of Northumbria. In the year 679, he was elected Abbot of Iona. His rule over that community was not, however, destined to be peaceful and fortunate. The views held by the Irish Church about the holding of Easter and the form of the tonsure are now pretty well known as a chapter in the history of the church. However little their own importance might be, they are significant as the object of a bitter contest in which that church resisted the rules promulgated from Rome. In his intercourse with the Saxon Church, A. had adopted the Romish or orthodox views, as they are termed, and endeavoured to put them in practice in his own community. He was thwarted in this object, and it is said that mortification at the failure caused his death. He died in the year 704, on the 23d of September, which is the day of his translation in the calendar. He left behind him an account of the Holy Land, containing matters which he says were communicated by Arculfus, a French ecclesiastic who had lived in Jerusalem. It is valuable as the earliest information we possess of Palestine in the early ages of Christianity. But far more valuable is his *Vita Sancti Columbae*, his Life of St Columba, the converter of the Picts, and founder of Iona. Along with miracles and many

other stories palpably incredible, this book reveals a great deal of distinct and minute matter concerning the remarkable body to which both the author and his hero belonged. The standard edition of the book is that of Dr Reeves, edited in 1857 for the Bannatyne Society of Edinburgh, and the Irish Archaeological Society, which (with an English translation) forms the 6th vol. (1875) of *Scottish Historians*. Nearly all the information to be had about the early Scotch-Irish Church is comprised in that volume.

ADENITIS AND ANGIOLEUCITIS are the terms employed in medicine to indicate inflammation of the lymphatic glands and inflammation of the lymphatic vessels respectively. In most instances of inflammation in the absorbent or lymphatic system, the vessels and glands are simultaneously involved. Although there is plenty of evidence, from the examination of the dead body, that inflammation of the lymphatics may occur internally, it is only observed in the living subject in connection with the skin or an ulcerated surface. The disease usually originates in an open wound of almost any form, as a puncture, a cut, or a blister. This wound is directly infected by some morbid matter, as, for example, some local inflammatory product, such as the putrid secretion of a sore; but more commonly by some irritating or poisonous matter from without, or some gaseous matter. The inflammation that is thus set up in the lymphatics always extends upwards from the wound, and may be traced by lines of redness following the course of these vessels, and not of the veins, and terminating where the inflamed vessels enter a gland. In the arm, for example, they never pass the armpit, in which the axillary glands lie. The tenderness along these inflamed tracts is excessive, and extends to the next gland, which appears to arrest the further progress of the poisoned lymph, by becoming itself inflamed. The degree of inflammation of the gland may vary from slight enlargement with tenderness on pressure, to profuse suppuration. The suppuration may not take place till a week or more after the inflammation of the vessels has subsided, and may excite no rigors or other constitutional symptoms; and a patient may be quite unconscious that there is anything serious the matter with him, when half a pint or more of matter may be collecting in and around a gland in the armpit. The constitutional symptoms attending an attack of acute inflammation of the lymphatic vessels (*angioleucitis*) are often severe, and are thus summed up by Mr Moore in his essay 'On Diseases of the Absorbent System' in Holmes's *System of Surgery*: 'Rigors, nausea, and vomiting, heat of skin, thirst, dryness and coating of the tongue, with constipation, sleeplessness, and a feeling of languor, are usually the severest accompaniments of the disease. If the fever be typhoid, if there be profuse fetid sweats, severe muscular pains, high excitement, or dry burning heat of the skin, and marked delirium, the poison is no longer limited within the lymphatic channels, but has infiltrated the cellular tissues, and has tainted the blood. As the inflammation subsides, a cutaneous eruption or fetid discharge from the bowels comes on, and the general symptoms become those of exhaustion.'

The following observations on the treatment of inflamed absorbents are mainly taken from Mr Moore's essay. Many of the ordinary duties of life perpetually expose manual labourers and others to this painful affection. In the way of prevention, the practice of smearing the hands with oil or grease before touching noxious fluids, is found to prevent the mischief which might arise from absorption by a cut or sore, and is a useful precaution in dissection and in post-mortem examinations; and there can be no doubt that the timely application

of a layer of collodion or of court-plaster might avert many attacks of inflamed absorbents. When symptoms of this form of inflammation supervene, the wound should be thoroughly cleaned, by being laid more open, if all its parts are not freely exposed, and then put under a stream of water, syringed, or soaked in a hot bath, as may seem most suitable. If recent or punctured, it should be sucked, and then freely touched with a pencil of nitrate of silver. If flabby, it should be treated with a stimulating lotion of sulphate of zinc or of copper; if fetid, it should be wrapped in a solution of Condy's Fluid, or in chlorinated lotions; and if sloughy, it should be covered with Peruvian balsam and a poultice of linseed meal, charcoal, or yeast. A warm poultice of one of these kinds, frequently changed, is usually the most soothing application. At the same time, nitrate of silver should be two or three times drawn along the red tender lines indicating the course of the lymphatics, after which the arm should be enveloped in cotton-wool; and perfect rest in a comfortable position enjoined. Due attention must at the same time be paid to the general condition of the system, and especially to the condition of the intestinal secretions.

ADENOCELE (Gr. *adens*, a gland, and *cella*, a tumour) is the term now employed in surgery to indicate a kind of new growth in the female breast, the tissue of which closely resembles the breast-tissue itself. It is synonymous with the terms 'Chronic Mammary Tumour,' 'Pancreatic Sarcoma,' 'Mammary Glandular Tumour,' 'Hydatid Disease of the Breast,' 'Serocystic Sarcoma,' &c. The diversity of names indicates the diversity of the outward forms seen in these growths. A full account of these tumours, and of the treatment to be adopted (which consists in excision), is given in Mr Birkett's article, 'On Diseases of the Breast,' in Holmes's *System of Surgery*.

ADERNO (ancient *Adranum*), a town of Sicily, 17 miles north-west from Catania. It is situated at the base of Mount Etna, close to the Simeto, on which are some remarkable cascades near the town. It is surrounded by walls, is a very clean town, and is full of convents and nunneries, mostly founded by the Normans, so that bare walls of lava and grated windows appear everywhere, and the sound of bells is almost incessantly heard. Pop. 14,600.

ADIPIC ACID ( $C_{12}H_{10}O_6 \cdot 2HO$ ) is a dibasic acid of the oxalic series, having the general formula  $C_nH_{2n-2}O_6$ ; and is obtained in the form of white, opaque, hemispherical nodules (which are probably aggregations of small crystals), by the oxidising action of nitric acid on oleic acid, suet, spermaceti, and other fatty bodies. The name is derived from the Latin *adeps*, fat, and must not be confounded with that of a similar acid of the same group, known as *Sebacic Acid*.

ADJYGURH, a town of British India, in the North-West Provinces, province of Allahabad, 69 miles west-north-west from Rewah. It has a fortress, situated on a very steep hill, and accessible only by well-defended paths. The hill, which is of granite, is isolated, and separated from the north-western edge of a plateau by a very deep and impassable ravine. Within the walls of the fort are two great masses of ruins of temples, resembling in architectural character those of Southern India, and covered with the most elaborate sculptures. A was for a short time the capital of a small Mahratta state, was taken by the British under Lieutenant-colonel Martindale, in 1809, after an obstinate resistance, and restored to its previous possessors, who were Rajputs. The native line of rajahs became extinct in 1855. Except the summit of the hill,



occupied by the fort, which is healthy, A. is very subject to malaria. The fort is 860 feet above the town, which is 480 feet above the sea. Pop. about 5000.

**ADOWA**, a town of Abyssinia, the capital of Tigré, 145 miles north-east from Gondar. It is situated partly on the slope and partly at the base of a hill, on the left bank of the Hasam, a feeder of the Atbara, which is a large branch of the Nile. The houses are of the conical form common in Abyssinia, regularly disposed in streets, and mingled with gardens and trees. A. is the chief entrepôt of trade between the interior of Tigré and the coast. It has an extensive transit trade, in which gold, ivory, and slaves are articles of importance. It has also manufactures of cotton fabrics, and iron and brass wares. Pop. estimated at about 8000.

**ADRA** (ancient *Abdera*), a seaport town of Spain, in the province of Granada, and 49 miles south-east from Granada. It is situated on the shore of the Mediterranean, at the mouth of the Adra. The ancient Abdera, founded by the Phœnicians, was on a hill, at the base of which the modern town stands, in a situation unhealthy on account of swamps. The port is not good, being much exposed to the west. The houses are generally of one story. There is one tolerably wide street, the rest are narrow and ill paved. From the watch-tower of A., in former times, a tocsin sounded the alarm on the approach of African pirates. Lead mines in the neighbourhood give employment to many of the inhabitants, and trade to the port. Among the other exports are grapes, wheat, and sugar. Fishing and the distillation of brandy are carried on. Pop. 9000.

**ADU'LLAMITES**. An attempt, in the year 1866, by the government of Earl Russell and Mr Gladstone, to carry a measure which would have brought about a sweeping reduction of the elective franchise, gave occasion to a large number of the more moderate Liberals to secede from the Whig leaders, and vote with the Conservatives. The designation of *Adullamites* was fastened on the new party, in consequence of Mr Bright having, in the course of debate, likened them to the political outlaws who took refuge with David in the cave of Adullam (1 Samuel, xxii. 1, 2); a comparison taken up by Lord Elcho, who humorously replied, that the band congregated in the cave was hourly increasing, and would succeed in delivering the house from the tyranny of Saul (Mr Gladstone) and his armour-bearer (Mr Bright).

**AFFRIQUE, SAINT**, a town of the dep. of Aveyron, France, on the Sorgue, a tributary of the Tarn, 31 miles south-south-east from Rhodéz. It is situated in a beautiful valley, between two mountains, and is surrounded by meadows, orchards, and vineyards. The streets are broad, but the houses are mostly old and mean. It has woollen and cotton manufactories and tanneries. There is a considerable trade in wool; and a principal article of trade is the celebrated *Roquefort Cheese*, made from ewe-milk, chiefly in the mountain pastures around the neighbouring village of Roquefort. About 10,000 cheeses are made annually. They are kept in cellars by the cheesemongers to ripen. This kind of cheese was sent to ancient Rome, and is highly praised by Pliny. Pop. (1872) 5071.

**AFIUM-KARA-HISSAR** (*Opium Black Castle*), a city of Asia Minor, in the pashalic of Anatolia, 170 miles east-by-north from Smyrna. It stands near the Akar, partly on level ground, and partly on a rising ground among rocks. Above the city, towers an isolated rock of 300—400 feet in height, almost

precipitous on most sides, and very steep on that by which alone it is accessible. The summit has in former times been fortified. The streets of the city are very narrow. Most of the houses are of stone, and well built. A great trade is carried on, the city being an entrepôt between Smyrna and Europe on the one hand, and Armenia, the countries on the Euphrates, and Persia on the other. The products both of Europe and the East are to be found in its markets. A principal article of trade is opium, produced in the neighbourhood, and from it the city derives its name. There are here and in the neighbourhood manufactures of felts, carpets, arms, and saddlery. The saddlery of A. was formerly in request throughout the whole Turkish Empire, but the demand for it has greatly fallen off. The pop. is supposed to be about 60,000.

**AGALA'CTIA** (Gr. *α*, not, and *galacté*, milk), a want of the due secretion of milk. It may depend either on organic imperfection of the mammary gland, or upon constitutional causes. In the latter case, the secretion may often be excited by warmth and moisture, by the stimulus of the act of suckling, and if this fail, by the application of the leaves of the castor-oil plant to the breast.

**A'GATA DE GOTI, SANTA**, a town of South Italy, in the province of Benevento, 14 miles east from Capua. It is situated on a hill of volcanic rock, surrounded by the Isclero, an affluent of the Volturno. It is an episcopal seat, and has a cathedral, seven other churches, and an abbey. Pop. 5000.

**AGHMA'T**, or **AGHMET**, a fortified town of Morocco, the capital of a province, on the left bank of the Enfis, a tributary of the Tensift, on the north-western slope of Mount Atlas, 24 miles south from Morocco. Pop. 6000, of whom about 1000 are Jews. A. is said to have been at one time the residence of the Moorish emperor.

**AGNO'NÉ**, a town of South Italy, in the province of Campobasso, and 22 miles north-west from the town of Campobasso. It stands on a hill, and is said to occupy the site of the ancient *Aquilonia*. It is celebrated for its copper-works. Pop. 7500.

**AGO'STA**, or **AUGUSTA**, a fortified city of Sicily, in the province of Syracuse, 12 miles north of that city. It stands on a peninsula projecting into the Mediterranean. It is said to occupy the site of the *Megara Hyblæa* of the ancients, but contains no ancient remains. The present city was founded by the Emperor Frederick II. in 1229. It was the last place in Sicily to hold out against Charles of Anjou, but was betrayed into the hands of William L'Estendard, one of his barons, in 1268, when it was sacked, and its inhabitants mercilessly butchered. It remained desolate for years, but having been re-peopled, and begun again to prosper, it was burned and razed to the ground in 1360 in another Sicilian war; and again was taken and burned by the Turks in 1551. Finally, in 1663, it was destroyed by an earthquake, when one-third of the inhabitants perished. It has three long parallel streets. The houses are generally of one story. The port is spacious, but of rather difficult access. Salt is the chief article of export. Oil, wine, cheese, fruit, honey, and sardines are also exported. Pop. 9800.

**AGUILAR DE LA FRONTERA**, a town of Andalusia, Spain, in the province of Cordova, occupying the summits and slopes of several low hills on the left bank of the Cabra, 26 miles south-south-east from Cordova. Many of the houses are of three stories, and the town is remarkable for the whiteness of its houses and the cleanness of its streets. It

has three fine squares, and a dismantled Moorish castle. The chief trade is in corn and wine. Many of the inhabitants are employed in agriculture, and in the breeding of oxen, horses, and mules. Pop. 12,000.

AGUR, a town of India, in the territory of Gwalior, the possessions of Scindia's family, on the route from Oojein to Kota, 41 miles north-east from Kota. It stands in an open plain, 1598 feet above the sea, is surrounded by a rampart of stone, and has on one side of it a large and fine tank. Pop. about 30,000.

AHMEDNU'GGUR, or EDUR, a Rajpoot state of Guzerat, in the Mahi Kanta agency, politically connected with the presidency of Bombay. It is under the rule of the Rajah of Edur, subject to British sovereignty. The population is estimated (1872) at 217,000.—The principal town is Ahmednuggur, on the banks of the Haut Mati, a branch of the Sabarmati, in an extensive plain, 92 miles north-north-west from Baroda. It is surrounded by a fine old stone wall. Pop. 9000.

AHMEDPUR, a town of India, in the native state of Bhawalpur, and 25 miles south-west from Bhawalpur. The houses are mostly built of mud; but there is a large and lofty mosque, with four tall minarets. There are manufactures of matchlocks, gunpowder, cotton, and silk. The pop. has been estimated at 30,000, but other estimates make it much less.

AIDAN, SAINT, one of those distinguished monks of the early Scotch-Irish Church, who were received into the calendar of saints by a sort of acclamation, and without the ceremony of canonisation. His period is the middle of the 7th century. He was the first efficient missionary who propagated Christianity in the north of England. Oswald, the celebrated king of Northumbria, requested the community of Iona to send to his court one of their brethren who would teach the Christian religion to his people. As the history has come down to us, the first person sent was a certain Cormac, who was too dogmatic and intolerant to be a successful missionary. On his returning after a failure, A., who possessed the patience, geniality, and popular manners fitted for the task, was successful. He left a great reputation, and, as the earliest promulgator of Christianity in the northern districts, is generally counted the first in the lists of the bishops of Durham.

AIDONÉ, a town of Sicily, in the province of Caltanissetta, 20 miles east-by-south from Caltanissetta. It crowns the summit of a lofty height, commanding a view of the great plain of Catania. It was one of the settlements of the Lombards, who accompanied Roger the Norman in his conquest of Sicily. The road which leads to the town is very rugged, bordered by luxuriant prickly pears. Pop. 5920.

AIN-TA'B, a town of Syria, near the source of the Kowek, an affluent of the Euphrates, 59 miles north-north-east from Aleppo. It is tolerably well built: the houses are mostly of stone. It is well supplied with water, pure streams of which flow constantly through the streets. It has a castle built upon a mound, resting on rock, and of very striking appearance. The chief trade is in hides and leather; but cotton, sheep's and goat's wool, wax, wheat, and rice are also of commercial importance, being chief articles of produce in the surrounding district. A. is supposed by some to be the ancient *Antiochia ad Taurum*. Pop. 20,000, composed of Turks, Greeks, and Armenians.

AIRE, or AIRE-SUR-L'ADOUR (anc. *Vicus Julius*), a town of the dep. of Landes, France, on

the left bank of the Adour, 76 miles south from Bordeaux. It is a bishop's seat; and its cathedral, which has been often destroyed and rebuilt, is one of the most ancient in France. A. has been a place of consequence from the days of the Roman conquest of Gaul, and was the capital of the Visigoths under Alaric, but is now much decayed, and diminishing in population. It has hat manufactories and tanneries. Pop. 2576 in 1872.

AIRE, or AIRE-SUR-LE-LYS, a town of the dep. of Pas-de-Calais, France, on the Lys, 30 miles south-east from Calais. It is a fortress of the third class; the town wall built, but its situation low and marshy. The barracks are capable of containing 6000 men. There are manufactures of woollen stuffs, linen yarn, thread, hats, starch, Dutch tiles, and soap; also some trade in grain. Osier-work is carried on to some extent. Pop. (1872) 4380.

AJURUO'CA, a town of the province of Minas Geraes, Brazil, 100 miles north-west from Rio de Janeiro. It is situated in a fertile country, at the northern base of the Sierra Mantiqueira, on the river Ajuruoca, one of the head-waters of the Parana. The surrounding district once yielded much gold, which has apparently been exhausted; but it produces excellent crops of tobacco, millet, mandioc, sugar, and coffee. Swine are reared for the market of Rio de Janeiro. Pop. (including district) about 12,000.

AKBARPUR, a town of India, in the British district of Cawnpore, 28 miles west from Cawnpore, on the route from Cawnpore to Etawa. It is the capital of a pergunnah of the same name. Pop. 6330.

AKHALZIKH, or AKISKA, a town of Russian Armenia, 90 miles west from Tiflis, on the left bank of the Dalka, an affluent of the Kur. It is situated in a valley of the Keldir Mountains, and at such an elevation above the sea, that the winter is severe, although the summer is very hot. A. was anciently called Keldir or Chaldir. It is without walls, but has a strong citadel, built on a rock. The mosque of Sultan Ahmed, built on the model of St Sophia, in Constantinople, has a library attached to it, which was accounted one of the most valuable in the East; but the Russians, after acquiring possession of A., carried off great part of its most valuable treasures to St Petersburg. Maize, wheat, barley, flax, cotton, silk, grapes, figs, and honey are produced in the surrounding district. Some manufactures are carried on in the town, and it maintains an active trade with various places on the Black Sea. Pop. (1867) 15,977, two-thirds of whom are Armenians.

AK-HISSAR (anc. *Thyatira*), a town of Asia Minor, in Anatolia, 52 miles north-east from Smyrna, on somewhat elevated ground in the valley of the Hyllus. The streets are paved with carved stone, and other relics of antiquity abound; but there are no ruins of ancient buildings. Cotton goods are exported. Pop. estimated at 10,000, of whom two-thirds are Turks, and the remainder mostly Greeks.

AKHLAT, or ARDISH, a town of Asiatic Turkey, in the vilayet of Van, and 58 miles north-west from Van. It is situated on the north-west shore of Lake Van, and is surrounded by a double wall and moat, and further protected by towers and a citadel. Pop. estimated at 6000. The old city of A., at a little distance from the present town, in a ravine, was the residence of the kings of Armenia, and was the scene of many conflicts between the Greeks, Armenians, and Persians. It was taken

and devastated in 1228 by Jalal-ud-deen, and completely destroyed by an earthquake in 1246.

**AKHTYRKA**, a town of European Russia, in the government of Kharkov, and 58 miles north-west from Kharkov. It is situated on a small river of the same name, an affluent of the Dnieper. It was founded by the Poles in 1641. It has manufactures of light textile fabrics, and a great annual fair. The neighbourhood is very fertile. Pop. (1867) 17,411.

**A'KRON**, a town of the state of Ohio, North America, the capital of Summit County. It is situated 36 miles south of Cleveland, on the Little Cuyahoga, which falls into Lake Erie, and at the junction of the Ohio and Erie Canal with the Pennsylvania and Ohio Canal, at the highest point in the course of the former canal, whence its name (Gr. a summit). It is also on the Cleveland and Zanesville Railway. It was first settled in 1825. It has woollen factories, flour-mills, a steam-engine factory, a stove factory, &c. The machinery of all its public works is driven by water-power. It is a place of considerable trade. Pop. (1870) 10,006.

**AK-SHE'HR** (*White City*, and *Philomelion*), a city of Asiatic Turkey, in the pashah of Karaman, five miles south of the salt lake of Ak-shehr, at the entrance of an extensive mountain valley. The houses rise in successive terraces on the slope of a hill. There is here a celebrated carpet manufactory. Pop. estimated at 6000.

**AK-SU'**, a town of Eastern Turkestan, 260 miles north-east from Yarkand, on an affluent of the Tarim, and on the southern base of the Thian-shan Mountains. It was formerly the residence of the kings of Kashgar and Yarkand. While Eastern Turkestan formed part of the Chinese Empire, it was an important garrison town. In 1867, it was captured by the Atalik-Ghazee. In 1716, it was nearly destroyed by an earthquake, and in the beginning of the present century, suffered terribly from an inundation. It is celebrated for its manufactures of cotton cloth and saddlery. It is much resorted to by caravans, as an entrepôt of commerce between Russia, Tartary, and China. The pop. is very variously estimated from 6000 to 20,000 and upwards. Sheep and cattle are extensively reared in the neighbourhood. See **TURKESTAN, EASTERN**.

**AKYA'B**, a town of Further India, the chief seaport of the district of Akyab or Aracan Proper, and the capital of the province of Aracan. It was formerly called Twet-twe, and sometimes still receives that name. It is situated on the eastern side of the island of Akyab, at the mouth of the Kuladyne or Coladyne. The houses are well built, the streets broad and regular. The town is rapidly rising in commercial importance. Light-houses have been erected for the benefit of the harbour. Pop. (1872) 19,230.

**ALABAMA**, THE, an armed vessel of the Confederate States of America, which inflicted terrible injury upon the shipping of the Northern States of the American Union during the civil war which broke out in 1861. The career of the *A.* was in more than one respect unparalleled in the history of any previous naval war. She was, for a war-ship, a small vessel, built for speed, carrying a few guns, and intended not for fighting, but for preying upon defenceless merchant-ships. She was almost the only vessel the Confederate States had upon the open seas; but the destruction she wrought was so great, and in effect so alarming, as to produce a very marked diminution in the number of commercial vessels carrying the flag of the United States. She was built, too, in a British port, and never, at any time, entered a port of the state by which she was

commissioned: there was no port available for the disposal of her prizes, and, ship and cargo, they were usually burned. Her career demonstrated how completely, in the present state of commerce, under the conditions of navigation and naval warfare produced by steam and long-range artillery, belligerents fairly matched might rain each other at sea; and it raised international questions between the United States and Great Britain, which more than once threatened to issue in the gravest consequences to both nations. Even the end of the *A.* was singular and instructive: perhaps it was too honourable an end for such a career as hers. She went down in an artillery duel, quixotically entered upon for a fancied point of honour, with a vessel protected by armour: illustrating the impotence, in modern naval warfare, of the gallantry of the most gallant of seamen against advantages derived from speed, armament, and armour.

At the beginning of the civil war in 1861, the Confederate States were without a navy, and apparently without the means of acquiring one. Their population was agricultural; they had neither ships nor seamen; and the Northern States promptly instituted an effective blockade of nearly all their ports. The able men who had planned the secession of the Southern States from the American Union had not overlooked the subject of a navy; but events had been against them. They had reckoned upon securing a part of the United States fleet; and before the war commenced, they had determined upon fitting out small and swift vessels, carrying a few heavy guns, to cruise against the Northern commerce. They had no lack of able naval officers; for a majority of the senior naval officers of the United States were Southern men, and were at their command. Early in 1861, while parleying was still going on between the North and the South, and hopes of a peaceable separation were not extinct, Captain Raphael Semmes had been empowered by the Southern leaders to purchase ships and stores for the South; but as regards ships, Captain Semmes appears to have been unsuccessful. It was not till several months after the war began, in June 1861, that the Confederate States were able to send their first armed cruiser to sea. This was the *Sumter*, a small steamer, which had previously traded between New Orleans and Havana. Captain Semmes, who was appointed her commander, was singularly qualified for the work expected of him. He was a native of Maryland, about 51 years of age; he had been a Commander in the United States navy, and now held the same rank in the service of the Southern States. Besides possessing high professional abilities and attainments, he was a man of acute intellect and of decided character; and he was thoroughly instructed in the principles and details of international law and etiquette. He seems to have united with the good qualities of a naval officer the qualifications of an able lawyer, diplomatist, and publicist. He could be trusted to secure for a war-vessel of the Confederacy, however small, every advantage to which she was entitled from neutral powers; to give to subjects of neutral powers, and of the other belligerent alike, nothing which was not strictly their due; to carry out without finching, unmoved by taunts and abuse, the work of destruction which was expected at his hands. His career in the *Sumter* is a record of triumphs won over neutral governors and ministers, who were disinclined to admit the little *Sumter* to the position of a belligerent war-vessel; of clever avoidance of the enemy's cruisers, of which several were always on his track; and of the destruction of valuable ships and cargoes belonging to citizens of the United States. The *Sumter* and her captain

were soon known throughout the world. The enemy called Captain Semmes a pirate, and could they have caught him, would probably have treated him as a pirate. But he appears to have done nothing but what it was his right as a belligerent to do; at anyrate, he was scrupulous not to exceed the precedents of international law. It was upon his system of burning his captures, not upon the captures themselves, that the people of the Northern States founded their charge of piracy; but no Confederate port was open to him for the disposal of his prizes; and his treatment of them, though it greatly shocked an age which had seen scarcely anything of naval warfare, was warranted by precedents, and was probably, though not unquestionably, within his right. As an occasional resource, to be adopted upon an emergency, the burning of captures made at sea is undoubtedly lawful; it is not so certain that a belligerent is at liberty to carry out a *system* of burning captures, made without the hope of being able to bring them into port for adjudication before a prize court. The cruise of the *Sumter*, which began on the 30th June 1861, with her escape from New Orleans, then strictly blockaded, was over before the end of the year; but she had captured 18 vessels, had spread alarm through the Northern seaports, and had put shipowners and merchants to heavy charges for insurance; and by disinclining merchants to ship their goods in Northern vessels, had seriously injured the shipping-trade of the Northern States. Eventually, she was laid up at Gibraltar, and declared unfit for further service: had she been seaworthy, it would have been very difficult to carry her out of a port where she was diligently watched by Northern cruisers. She had, however, verified the anticipations of the Confederate government; and in 1862, this government found a successor for her, much better fitted for the work to be done, and destined to far greater celebrity. This was the *Alabama*.

This vessel was built for the Confederate government by Messrs Laird and Sons at Birkenhead. She was a screw steam-sloop of 1040 tons register, built of wood, and for speed rather than strength. She was barque-rigged, and was fitted with two engines of 350 horse-power each; she was pierced for 12 guns, and had the means of carrying two heavy pivot-guns amid-ships. She cost £47,500 without her equipment; including her equipment, £51,716. Semmes, now a captain in the Confederate service, was, in June 1862, appointed to superintend her equipment, and take command of her when ready for sea. Both Captain Semmes and Commander Bullock, who had superintended the building, were enjoined by the Confederate government to keep the destination of the vessel as secret as possible, and carefully to avoid any infringement of public law, or of the municipal law of Great Britain, which would give the British government a pretext for seizing her. These instructions were carefully acted upon. The destination of the 'No. 290,' as she was called from her number in the list of steamships constructed by the Messrs Laird, was so well concealed, that she was nearly finished before it was suspected by the emissaries of the United States. According to previous practice, there was no great difficulty in avoiding the infringement of the public and of the municipal law in such a case. It had been held lawful to build vessels for a belligerent in neutral ports, and lawful to purchase guns and stores in neutral ports, though they might be for the equipment of vessels thus built. What had been held unlawful was the equipment with guns and warlike stores of a vessel built for a belligerent in a neutral port previous to her leaving the neutral jurisdiction. Captain Semmes did not

intend to equip his vessel at Birkenhead, and therefore, supposing the rules of public law to have remained unchanged, he intended no infringement of the law. But the United States minister called upon the British government to detain the 'No. 290,' submitting some evidence that she was intended for a Confederate war-vessel. He maintained, or, at anyrate, it has since been maintained on the part of the United States, that her construction, being that of a war-vessel, was so different from that of vessels built for trade, as itself in some measure to constitute an equipment for war. The British government consulted the crown lawyers, who at first thought the evidence of destination insufficient. Afterwards, when further evidence was presented, a delay was caused by the illness of Sir John Harding, the Queen's Advocate. When an opinion favourable to the detention of the vessel was at length given, 'No. 290' was gone. The builders, made aware of the danger of a seizure, had made haste with their work; the vessel, though unfinished, was got ready for sea; under pretence of a trial trip, she made her way down the Mersey to Moelfra Bay, where the work remaining to be done was actively carried on; and on the morning of the 31st July 1862, warning having been given that she was to be seized that day, the 'No. 290' steamed away from the British coast. The ablest English lawyers were of opinion that there had been no infringement of the law, but that a case had been presented which the British government was bound to submit to a court of law. The detention of the vessel during a protracted lawsuit would have served the purposes of the United States almost as well as her condemnation; and as she must have been detained but for the delay caused by Sir J. Harding's illness, it is not without a show at least of reason that the United States government claimed from Great Britain indemnification for the losses consequent upon her escape.

'No. 290' made for Terceira, one of the Western Islands, where she arrived on the 13th of August—her speed and sea-going qualities being fully proved upon the voyage; and a few days after she was joined by the *Agrippina* of London, carrying her guns, stores, and supply of coal, and by the *Bahama*, with Captain Semmes and his officers on board. By the 24th of August, she had shipped her armament and stores, and was ready for sea; and now Captain Semmes produced his commission to the sailors, named the vessel the *A.*, and hoisted the Confederate flag. The sailors on board the *A.* and her consorts were Englishmen, all entered for a feigned voyage; but with few exceptions, they enlisted under Captain Semmes, though the terms upon which they insisted were exorbitant. The crew now consisted of 80 men all told; and the armament of eight 32-pounders. By the end of August, the vessel was got into good order; and she made her first capture on the 5th of September. Within eleven days of that date, she captured and burned property the value of which exceeded her own cost. The people of the United States were filled with indignation against Great Britain for permitting the escape of such a destroyer. Their indignation against 'the pirate Semmes' was only less than the alarm with which they regarded the depredations of the *A.* Several fast-sailing cruisers were sent in search of her.

Captain Semmes made for the American coast, which he had determined to make his first cruising-ground. He was ambitious of making a few captures within sight of New York; but running short of coal, he was obliged to give up this somewhat daring scheme, and make for a coaling-station. He afterwards lay on the track of the *California*

mail-steamers running between Aspinwall and New York; and after waiting for some time, he captured the *Ariel* mail-steamer, with 140 marines, several United States officers, and 500 other passengers on board. A heavy gun and a quantity of specie were all that he took by this capture, but it greatly raised the prestige of the *A.*, and increased the alarm of American shipowners. The passengers and crew of the *Ariel* were too numerous to be taken on board the *A.*; and as Captain Semmes found yellow fever raging at Kingston in Jamaica, at which port he intended to have landed them, he was unable to destroy the vessel, and had to set her free, after taking a bond for a large sum to be paid on the conclusion of the war. Shortly after, on the 11th January 1863, an encounter occurred between the *A.* and a United States vessel, which still further augmented the reputation of the former. Cruising off Galveston in Texas, the *A.* gave battle to the United States gun-boat *Hatteras*, an old vessel, somewhat her inferior in armament, and sunk her after a few broadsides. The destruction of the *Hatteras* and the capture of the *Ariel* were the most remarkable events in the career of the *A.* until her closing scene arrived. Her history consists of a monotonous succession of captures made in different seas, her prizes being merchant-vessels incapable of resistance, which were burned, or, when there was convincing evidence of the neutral ownership of the cargo, which did not often happen, liberated upon bond. She captured in all 65 vessels; and the value of the property she destroyed has been estimated at 4,000,000 dollars. It was, however, by the heavy insurance for war-risks to which she subjected them, and still more by the difficulty she caused them in getting freights, that the *A.*'s career inflicted the greatest injury upon the shipowners of the United States. When the pursuit after her became too hot on the American coast, she sailed for the Cape of Good Hope, and cruised in the eastern sea. Returning to Europe, she arrived in the English Channel in June 1864, and on the 11th of June entered the French port of Cherbourg to refit and supply herself with stores. She had been nearly two years at sea, and had got into bad condition; her speed and sailing qualities were considerably impaired. Permission to make the necessary repairs was given by the authorities of the port of Cherbourg.

But within a few days, the United States steamer, *Kearsage*, commanded by Captain Winslow, a former shipmate of Captain Semmes, arrived at Cherbourg; and she made a demonstration which the officers and crew of the *A.*—writhing under the abuse that had been heaped upon them, and aware that their career had been inglorious—regarded and resented as a challenge. Captain Semmes knew, and probably shared their feelings, and determined to gratify them; he sent notice to the United States consul that he would sail out and fight the *Kearsage*. The two ships were, to appearance, not unequally matched, in reality the *Kearsage* had considerably the advantage in number of crew, armament, speed, and general condition; besides that, she was protected amid-ships by armour. The fact of her being thus protected, and the extent of her superiority, seem to have been unknown to Captain Semmes. The fight took place on Sunday, the 19th of June, outside the port of Cherbourg, all Cherbourg gazing at it from the neighbouring heights. The *Kearsage*, having the superiority in sailing, was able to keep at a distance of about 500 yards from her enemy; her armour in a great measure protected her from the enemy's shot; and, as might be expected, her guns were better served than those of the *Alabama*. Before the fight had lasted an hour, Captain Semmes found his ship was sinking, and gave orders to pull

down his flag. The boats were got out, and the wounded placed in them; but before the *Kearsage* could come to the rescue, the *A.* went to the bottom. The boats of the *Kearsage* saved many of the crew. Others, including Captain Semmes, were picked up by an English yacht, the *Deerhound*, which had been allowed by Captain Winslow to help in rescuing the *A.*'s crew. These the *Deerhound* immediately carried within the neutral jurisdiction. Semmes and the others saved by this vessel were afterwards charged with having broken their faith as prisoners who had asked for quarter from the *Kearsage*. As regards the *Deerhound*, the seamen of the *A.*, once upon its deck, were entitled to the protection of Great Britain, and no previous compact could have deprived them of it.—See *The Cruise of the Alabama and the Sumter*, compiled from the papers of Captain Semmes.

The 'Alabama Question' was fairly raised in the winter of 1862—1863, when Mr Seward, in his diplomatic correspondence, declared that the Union held itself entitled at a suitable time to demand full compensation for the damages inflicted on American property by the Anglo-rebel vessels; and the question never ceased to be a source of irritation between the two peoples till its final settlement by special tribunal of arbitration. This court, consisting of the representatives of England and the United States, and of three other members appointed by the king of Italy, the president of the Swiss Confederation, and the emperor of Brazil, met at Geneva, 17th December 1871, and, the claim for indirect damages to American commerce having been allowed to drop, gave its final award, 15th September 1872. It was decreed that Great Britain should pay a sum of £3,229,166, 13s. 4d.

ALAIIS, a town of the dep. of Gard, France, situated in a fertile plain, on the right bank of the Gardon, at the base of the Cévennes Mountains, 23 miles north-west from Nîmes, with which it is connected by railway. It embraced the Protestant cause in the religious wars of France; and Louis XIII. in person, accompanied by the Cardinal de Richelieu, besieged it, and having taken it in 1629, demolished its walls. Three years later, the Baron of Alais having taken part in the rebellion of Montmorency, the castle was destroyed. Protestantism still prevails to a considerable extent. *A.* is a very flourishing town, and owes its prosperity chiefly to the mineral wealth of the surrounding district, which produces coal, iron, lead, zinc, and manganese. The coal and iron mines are of chief importance. There are large iron-foundries in the town and neighbourhood. There are also manufactures of ribbons, stockings, gloves, vitriol, and earthenware. *A.* is an episcopal seat. Pop. (1872) 15,384.

ALAJUELA, a city of the state of Costa Rica, Central America, 23 miles west-north-west from Cartago, and a little on the western side of the water-shed between the Atlantic and the Pacific. It contains many good houses, and has extensive suburbs of detached houses, embowered among trees and flowering shrubs. The neighbourhood is chiefly devoted to the culture of the sugar-cane. Pop., including suburbs, 12,575.

ALAMOS, Los (i. e., *The Poplars*), a town of Mexico, in the state of Sonora, and department of Sinaloa, 110 miles north-north-west from Sinaloa. It is situated in a barren plain, but in a region famous for its silver mines. The houses are mostly of stone or brick, covered with stucco. Provisions are dear, being brought from a distance, and the town is very insufficiently supplied with water. Pop. 10,000.

ALA-SHEHR (i. e., *The Exalted City*, ancient

*Philadelphia*), a city of Asia Minor, in the pashalic of Anatolia, 75 miles east-by-south from Smyrna, at the north-east base of Mount Tmolus. It was founded by Attalus Philadelphus, king of Pergamos, about 200 B.C., and is famous as the seat of one of the 'Seven Churches of Asia.' It is still a place of considerable importance, and carries on a thriving trade by caravans, chiefly with Smyrna. It is surrounded by a wall, and is of large extent; but the streets are narrow and dirty. There are many interesting remains of antiquity. Pop. about 8000, including 250 Greek families.

**ALAU'SI**, a town of the republic of Ecuador, South America, in the province of Chimborazo, 70 miles east from Guayaquil, at an elevation of 7990 feet above the sea, in a valley of the Andes, on the river Alausi, which flows into the Gulf of Guayaquil. The valley of the Alausi is extremely fertile, producing sugar, grain, and fruits. There are manufactures of woollen and cotton cloth in the town. Pop. 6000.

**A'LBA** (ancient *Alba Pompeia*), a very ancient city of North Italy, in the province of Cuneo, on the right bank of the Tanaro, 31 miles south-east from Turin. It is situated in a plain surrounded by hills. The neighbourhood produces much wine and silk, besides corn, oil, and fruits. The town has an extensive trade in cattle. It is an episcopal seat; the cathedral was founded in 1486. Pop. 6600.

**ALBAOËTÈ**, a town of Spain, capital of the province of the same name, in Murcia, 138 miles south-east from Madrid, and a station on the railway from Madrid to Alicante. It stands in a fertile but treeless plain, is built with some degree of regularity, and contains a number of squares and many good houses. It is a place of considerable trade, and has great cattle-fairs in September. It is noted in Spain for the manufacture of knives and other steel goods, which, however, are very inferior to those of Sheffield. Pop. 15,150.—The province of Albacete is partly formed from the former kingdom of Murcia, and partly from New Castile. It is generally hilly, and in some parts mountainous, some of its mountains attaining an altitude of 5000 feet; but it contains also rich plains and fertile valleys. Agriculture is in a more advanced state than in most parts of Spain; corn and wine are largely produced, as also oil, hemp, tobacco, saffron, fruits of various kinds, and honey. Great numbers of sheep, goats, oxen, horses, mules, and asses are reared. The mineral wealth of the province appears to be considerable, but is not turned to much account. The area of the province is 5966 sq. m.; pop. (1870) 220,973.

**ALBAY**, a town of the island of Luzon, Philippine Islands, the capital of a province of the same name, in the south end of the island. It is situated about two miles from the Bay of Albay, which is an excellent harbour, and very near a volcano also called Albay, which is in a state of constant activity. Earthquakes are frequent, but the province is very fertile. The town is regularly built, contains some good houses, and is a place of considerable trade. Pop. 13,115.

**ALBERT N'YANZA** (the Little Luta Nziye of Speke), a large lake of East Central Africa, one of the reservoirs of the Nile, situated in a deep rock-basin, 80 miles west of the Victoria N'yanza. The A. N. is of an oblong shape, and, as proved by the circumnavigation of Colonel Gordon (1874), is 140 miles long from north to south, and 40 miles broad. It is crossed by the equator near its centre. On the east, it is fringed by precipitous cliffs, having a mean altitude of 1500 feet, with isolated peaks, rising from 5000 to 10,000 feet. The surface of the lake is 2720 feet above the sea, and

1470 feet below the general level of the country; its water is fresh and sweet, and it is of great depth towards the centre. The north and west shores of the lake are bordered by a massive range of hills, called the Blue Mountains, which have an elevation of about 7000 feet. The existence of this vast lake first became known to Europeans through Speke and Grant, who, in 1862, heard of the Luta Nziye as a narrow reservoir forming a shallow back-water of the Nile. See map to article NILE. When Speke and Grant, after the discovery of the Victoria N'yanza, were, in 1863, descending the Nile on their return to Europe, they met, at Gondokoro, Mr (now Sir) Samuel White Baker (q. v.), who was ascending the river in the hope of meeting with and aiding these travellers. As soon as they informed him of the reputed great lake, Baker agreed to undertake its exploration. Joining a trading party, he travelled south-eastwards to Latooka, which he describes as the finest country he had seen in Africa. His course was now south and south-west, through the countries of Obbo and Madi, crossing the Asua, a tributary of the Nile, on 9th January 1864. Journeying next in a south and south-eastward direction over uninhabited prairies and swampy hollows, he came upon the Nile at the Karuma Falls, lat. 2° 17' N., at the identical spot where it had been crossed by Speke and Grant. Being prevented, by the jealousy of King Kamraai, from following the course of the stream to the westward, he was forced to proceed, by slow marches southward on the west side of the Somerset or Nile, to M'rooli, leaving which, his course lay south-west on the south side of the Kafoor River. After a toilsome march of eighteen days from M'rooli, the party came in sight of the glorious expanse of water. Baker says: 'Weak and exhausted with more than twelve months' anxiety, toil, and sickness, I tottered down the steep and zigzag path, and in about two hours reached the shore. The waves were rolling upon a bank of sand; and as I drank the water, and bathed my face in the welcome flood with a feeling of true gratitude for success, I named this great basin the Albert N'yanza, in memory of a great man who had passed away.'

The spot where the party first reached the lake, Vacovia, is in lat. 1° 14' N., 30° 40' E. Embarking thence in canoes, the party coasted north-eastward, and in 13 days arrived at Magungo, lat. 2° 16' N., near the mouth of the Somerset River. At this part, the lake was under 20 miles in width, and appeared to stretch away in a north-west direction. From Magungo, 250 feet above the lake, the travellers had a view of the Nile Valley for 15 or 20 miles northwards. Ascending the Somerset, at a distance of 25 miles from its mouth, the canoe-voyage was interrupted by a grand cataract 120 feet high, which was named the Murchison Falls. The explorers proceeded south-eastwards for about 30 miles to Kisoona, and then a march north-east for about the same distance brought them to the Karuma Falls, where they first entered the lake-region. The name Somerset is adopted from Speke's first map, in order to distinguish that river from the Nile proper. It issues from the Victoria N'yanza at the Ripon Falls, and flowing north-west and west for about 230 miles, it enters the A. N. within 30 miles of its northern extremity, and soon quits it to form the true Nile. From the Ripon Falls for 30 miles north, and from the Karuma to the Murchison Falls, 45 miles, the Somerset forms a series of rapids. The A. N. receives the drainage of a great equatorial mountain range, where rain falls during ten months of the year. The scenery of the lake is described as extremely beautiful. Salt, which is very abundant in the soil on the

eastern shores of the lake, is now the only article of trade to the inhabitants. Formerly, Magungo was a large town, when the trade from Karagne, in lat. 2° S., was conducted in large boats sent by Rumanika, the king of the country, with cowrie shells and brass bracelets from Zanguebar, to be exchanged for ivory.

**ALBOSTA'N**, a town of Asiatic Turkey, in the pashalic of Marash, and 39 miles north-east-by-north from Marash. Pop. estimated at 9000.

**ALBO'X**, a town of Andalusia, Spain, in the province of Almeria, 42 miles north-east from Almeria, on a small affluent of the Almanzora, which divides the town into two parts. It has some good streets and buildings, and a fine square. Blankets, coarse linen and hempen fabrics, and earthenware are manufactured. There are also corn and oil mills. There is a great annual fair in November, lasting for a fortnight. Pop. 7430.

**ALBU'GO** is a term employed in Surgery to designate the white opacity that often follows ulceration of the cornea of the eye. In infancy, the comparatively rapid interchange of materials will often diminish to a great extent both the extent and density of these spots; but in after-life, they do not undergo similar absorption, nor are they amenable to surgical relief.

**ALBUÑOL**, a town of Spain, in the province of Granada, 41 miles south-east from Granada, and about 3 miles from the coast of the Mediterranean. It is a well-built town, with clean paved-streets. The surrounding district abounds in vineyards, and is also very productive of figs and almonds. The making of wine and brandy, and the drying of raisins, are the chief occupations of the inhabitants of the town itself. Pop. 6764. The port of A. is a small place called La Rabitá.

**ALBUQUERQUÉ**, a town of Estremadura, Spain, in the province of Badajoz, and 24 miles north from Badajoz. It is a decaying place. Cotton and woollen fabrics are manufactured, also earthenware, soap, and chocolate. The neighbourhood is fruitful, producing corn, wine, oil, flax, honey, and fruits. Pop. 5470.

**ALBUQUERQUE**, a town of Bernalillo County, New Mexico, U. S., on the left bank of the Rio Bravo del Norte, 41 miles south-south-west from Santa Fé. Pop. (1870) 1307.

**ALCALA' DE GUADAI'RA** (*The Castle of the Guadaira*), the ancient Carthaginian *Hienippa* ('place of many springs'), a town of Andalusia, Spain, in the province of Seville, and 7 miles east-by-south from Seville. It stands near the Guadaira, partly on a hill, so that some of the streets are very steep, and is overlooked by the ruins of an ancient Moorish castle, once one of the most important, as its ruins are still among the finest, in Spain. This town is beautifully situated, and on account of the salubrity of its climate, is much resorted to as a summer residence by the inhabitants of Seville. It is celebrated for producing the finest bread in Spain; there are more than fifty bakeries in the town, and Seville is chiefly supplied from it. The water-mills and mule-mills for making flour are more than 200 in number, and with the bakeries, give employment to great part of the population. Every process connected with the making of bread is conducted with the greatest care. Seville is also supplied with water from the hill above A., which is perforated by tunnels, some of them 6 miles in length, forming underground canals. Some of the tunnels are believed to be Roman works, but most of them are known to have been made by the Moors. The water flowing through the subterranean canals is

as clear as crystal. The neighbourhood of A. is fertile, producing corn, wine, oil, silk, honey, and fruits, also sheep and oxen. Pop. 7000.

**ALCALA' LA REAL** (*The Royal Castle*), a city of Andalusia, Spain, in the province of Jaen, and 26 miles north-west from Granada. It is situated on a conical hill, in a narrow valley, on the north side of the mountains which separate the province of Jaen from that of Granada, at an elevation of nearly 3000 feet above the sea. It is a very picturesque town, irregularly built, with steep and narrow streets and bold towers. It was the stronghold of the Alcaide Ibn Zaide; and being taken in 1340, by Alonso XI. in person, it obtained the name *Real*. It has a hospital, formerly an abbey, a very fine building. The neighbourhood produces grain and fruits of the finest quality, and the inhabitants of the town are mostly engaged in agriculture. There is some trade in wine and wool. Pop. 11,621.

**ALCAMO**, a town of Sicily, in the province of Trapani, and 23 miles east from Trapani, in the Val di Mazzara, on the high-road between Palermo and Trapani. It is said to have been founded by the Arabs, on their first invasion of Sicily in 827. The original town stood on a hill, and long retained a Moslem population, who were driven out by the Emperor Frederick II. in 1233, and the new town was built at the foot of the hill. A. is surrounded by a battlemented wall of the 14th century. The houses are mostly mean, and the streets irregular and dirty; the whole place having an air of poverty and decay. It contains, however, some fine old churches and palaces. Pop. (1872) 20,890.

**ALCAÑIZ**, a town of Aragon, Spain, in the province of Ternel, 63 miles south-east from Saragossa. It is situated on a rising ground on the right bank of the Guadalupe, which is here crossed by a bridge of nine arches. It is a well-built town, with wide paved streets, and a number of squares. It has a magnificent collegiate church, in which are many fine tombs and pictures. There are manufactures of silk, woollen, and coarse linen fabrics, hats, and soap; there are also flour and oil mills, and some trade in grain, cattle, and the manufactures of the town. Pop. 6400.

**ALCA'NTARA**, a seaport town of Brazil, in the province of Maranhão, 17 miles north-west from Maranhão, near the mouth of the Bay of St. Marco. Most of the houses are only of one story. The more wealthy residents are mostly cotton-planters; the poorer classes live chiefly by fishing, and by making hammocks of some of the peculiar fibres of the country. There are salt-pits not far from the town. Cotton, rice, and salt are exported. Pop. 10,000.

**ALCARAZ**, a town of La Mancha, Spain, in the province of Albacete, and 36 miles west-south-west from Albacete. It stands on the slope of an isolated hill, on the left bank of the Guadarmena, a feeder of the Guadalquivir. A ruined castle crowns the summit of the hill; and there are also the remains of a fine Roman aqueduct. Some of the streets are very steep. The inhabitants are partly employed in weaving and iron-working, partly in agriculture. Pop. 7325.

**ALCAUDE'TE** (anc. *Uditumum*), a town of Andalusia, Spain, in the province of Jaen, and 22 miles south-west from Jaen. It is situated in a hollow, enclosed by three hills, on an affluent of the Guadalquivir, is overlooked by the ruins of an ancient castle, and is tolerably well built. There are fine pictures in some of the churches. Oil and rope making, weaving, and agriculture are the chief employments of the inhabitants. Grain, silk, oxen, sheep, goats, pigs, mules, and asses are produced in the neighbourhood. Pop. 6242.

**ALCAZAR DE SAN JUAN** (anc. *Alice*), a town of New Castile, Spain, in the province of Ciudad Real, and 49 miles north-east from Ciudad Real, on the Madrid and Alicante Railway. It is regularly built, and has two good squares. There are manufactories of soap, nitre, and gunpowder. Pop. 7540.

**ALCIRA** (anc. *Sebaticula*), a town of Spain, in the province of Valencia, 20 miles south-by-west from Valencia, on an island in the river Xucar, the two branches of which are here crossed by stone bridges. It is surrounded by old walls, with strong towers. The principal streets are wide, but the town is ill built. The inhabitants are chiefly employed in the manufacture of earthenware, the production of silk, and agriculture. The surrounding country is much intersected by canals, exhibiting an admirable specimen of the system of irrigation introduced by the Moors. Pop. 15,400.

**ALCOHOL, PHYSIOLOGICAL AND POISONOUS ACTION OF.** Alcohol, in a concentrated form, exerts a local irritant action on the membranes and tissues of the animal body. According to various circumstances, as, for example, its greater or less dilution, the quantity in which it is administered, the emptiness or fulness of the stomach, and the nature of the animal on which the experiment is made, alcohol may either act as a gentle stimulus, which assists the digestive process, or it may excite such a degree of irritation as may lead to the disorganisation of the mucous membrane. It is well known that dilute alcohol, in contact with animal matter, at a temperature of from 60° to 90°, undergoes acetic fermentation, and it was maintained by Leuret and Lassaigne that a similar change took place in the stomach. It appears, however, that only a small part of the alcohol undergoes this change; and it is the small part thus changed which produces the penetrating and disagreeable acidity which characterises the eructations and vomited matters of drunkards. Alcohol is, however, for the most part, rapidly absorbed in an unchanged state, either in the form of liquid or vapour; and this absorption may take place through the cellular (or connective) tissue, the serous cavities, the lungs, or the digestive canal. This is shewn by the experiments of Orfila, who fatally intoxicated dogs by injecting alcohol into the subcutaneous cellular tissue, or by making them breathe an atmosphere charged with alcoholic vapour; and by Rayer, who injected about half an ounce of proof-spirit into the peritoneum of rabbits, which almost immediately became comatose, and died in a few hours. It is, however, only with absorption from the intestinal canal that we have to deal, in relation to man. Almost the whole of this absorption is effected in the stomach, and it is only when alcohol is taken in great excess, or is mixed with a good deal of sugar, that any absorption beyond the stomach occurs. The rapidity of the absorption varies according to circumstances. The absorption is most rapid when the stomach is empty and the drinker is fatigued; while the action is delayed by a full stomach, and especially by the presence of acids, tannin, or the mucilaginous and saccharine ingredients of many wines. Fatty matters have a similar action, and hence it is that (as we learn from Dr Perrin's elaborate article on 'The Physiology of Alcohol,' in the *Dictionnaire Encyclopédique des Sciences Médicales*, vol. ii. p. 577, 1865) 'we must account for the English habit of taking a very fat soup, or even a glass of oil, before proceeding *aux libations*.' The mode of action of alcohol on the system, and the various phenomena of drunkenness, are sufficiently described in the article INTOXICATION. Previously to the year 1860, the actual presence of alcohol in the blood had been

attempted to be proved by many chemists, but no satisfactory evidence upon this point had been adduced; and its presence had also been sought for in the expired air and in the secretions, but the results were equally doubtful; and Liebig's view, that alcohol was oxidised in the blood, and after passing through various stages of oxidation, was finally converted into, and eliminated from, the system as carbonic acid and water, was almost generally accepted. In that year, however, an elaborate work, abounding in well-devised experiments, and entitled, *Du Rôle de l'Alcool et des Anesthésiques dans l'Organisme*, was published by three well-known physiological inquirers, MM. Lallemand, Perrin, and Duroy, and received a prize, with high commendation, from the Academy of Sciences. In this work, it seems to be proved beyond all doubt that 'alcohol stays for a time in the blood, that it exercises a direct and primary action on the nervous centres, whose functions it modifies, perverts, or abolishes, according to the dose; that neither in the blood nor in the expired air are any traces to be found of its transformation or destruction; that it accumulates in the nervous centres, and in the liver; and that it is finally discharged from the system by the ordinary channels of elimination.'—Perrin, *op. cit.*, p. 580. So far from carbonic acid being one of its final products, it is now ascertained that alcohol causes a diminished exhalation of that gas. The alcohol, when it has entered the blood, is diffused over the whole organism, remains during, apparently, different periods in different organs, and almost immediately begins to escape; and if as much wine or spirit is taken as contains 80 grammes, or rather more than 2½ ounces of alcohol, the urine passed some hours afterwards yields, by distillation, an amount of alcohol capable of burning; and the elimination by this channel continues for 16 hours or more. The elimination by the lungs continues for about 8 hours. The authors believe that in man the chief excreting channel is the skin, but they have no data to shew how long this elimination is continued. They further shew that, when a quantity of *vin ordinaire*, equivalent to half an ounce of alcohol, has been taken by a healthy man, the presence of alcohol may be readily detected in the blood, the expired air, the urine, and the cutaneous exhalation in the course of half an hour after the wine has been taken. In animals destroyed when intoxicated, the portions of the brain and of the liver are found to yield, weight for weight, considerably more alcohol than the blood. The fact of the retention and accumulation of alcohol in the nervous centres and liver, tends to throw much light on the special diseases of drunkards.

The action of any kind of alcoholic drink in moderate doses, is that of a somewhat rapid stimulant. The bodily and mental powers are for a time excited beyond their ordinary strength, after which there is a corresponding depression. Although the alcohol which is introduced into the system cannot act as a true food (for in that case it would not pass through the system unchanged), it indirectly takes the place of food, by diminishing the wear and tear of the system, and thus rendering less food sufficient; a fact which is proved by chemical experiments, shewing that less carbonic acid and urea (which are the ultimate products of the carbonaceous and nitrogenous tissues) are given off when alcohol is administered in moderation, than when it is totally withheld.

The influence of an excessive dose of alcohol has been demonstrated by various series of experiments on animals, and unfortunately by many observed cases in man. If a poisonous dose of alcohol is



## ALCOHOL

given to an animal (a dog, for example), its action on the nervous system is the first point that is noticed. The dog ceases to exhibit the ordinary control over its muscular movements, which seem to be no longer under the influence of the will. It walks with uncertain and doubtful steps, till the hind-legs lose their power, the fore-legs still preserving some activity. The general sensibility becomes more or less abolished, and the animal can no longer see or feel. Soon afterwards, the respiration fails; and finally, the circulation is arrested, and life ceases with the last beat of the heart.

As cases are of frequent occurrence in which it is almost impossible for non-professional persons (the police, for example) to distinguish between extreme drunkenness and certain other morbid conditions, as apoplexy, concussion of the brain, and opium-poisoning, it may be practically useful if we lay down a few rules on this subject. In concussion and in very extreme intoxication, there is profound coma or sleepiness; but in the latter case, the odour of the breath removes all difficulty of diagnosis. The most difficult cases are those in which the symptoms of concussion or apoplexy are associated with an alcoholic odour of the breath; in such cases, the head should be most carefully examined for marks of violence, and every effort should be made to obtain a history of the case from those who had previously seen the patient. In poisoning by opium or laudanum, the peculiar smell of the drug may generally be detected in the breath (a test which, however, fails if morphia has been taken). In poisoning by opium, the face is pale, and the pupils of the eyes are contracted; while in drunkenness, the face is flushed, and the pupils are generally dilated. Another difference (to which Dr A. S. Taylor calls attention) is this—that while perfect remissions are rare in poisoning by opium, in poisoning with alcohol the patient often recovers his senses, and subsequently dies. In either kind of poison, the stomach-pump should be used, and the ejected contents of the stomach may facilitate our diagnosis. A sulphate of zinc emetic should be prescribed, if there is no stomach-pump at hand; and after the stomach has been well cleared out, coffee and other strong stimulants should be given.

**ALCOHOLS.** During the last few years, our knowledge of the properties of ordinary alcohol and of the general class of bodies to which the term *Alcohols* is applied, in consequence of their resemblance, in certain chemical reactions, to ordinary alcohol, has been very much enlarged. We shall first make a few supplementary additions to the article **ALCOHOL**, and shall then proceed to notice the class of *Alcohols*.

In the article **SYNTHESIS**, a method is described by which Berthelot artificially formed alcohol from inorganic compounds. He has since devised another method, which throws much light on the nature of the composition of this substance. On combining the hydro-carbon ethylene, or olefiant gas ( $C_2H_4$ ), with hydriodic acid (HI), we obtain iodide of ethyl ( $C_2H_5I$ ); and by prolonged boiling with caustic potash, the former compound may be converted into alcohol, as is shewn in the equation,\*

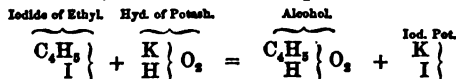

Here it is seen that the iodine of the iodide of

\* We have expressed the substances in the following equation in accordance with the theory of types, because the substitution of the ethyl for the potassium is thus more clearly seen than in the corresponding equation,  $C_2H_5I + 2KO = C_2H_5O_2 + KI$ .

ethyl abstracts the potassium from the hydrate; while the group  $C_2H_5$ , which constitutes ethyl, is substituted for the metal. Alcohol may thus be regarded as a hydrate analogous to hydrate of potash; and if the latter is regarded as water in which one atom of hydrogen has been replaced by one of potassium, so alcohol may be regarded as water in which one atom of hydrogen has been replaced by the monatomic radical ethyl. Hence, while alcohol was regarded, according to the compound radical theory, as hydrated oxide of ethyl,  $C_2H_5O_2HO$ , it is now regarded, according to the old theory of Types (q. v.), as water in which one atom of hydrogen is replaced by one atom of ethyl,  $C_2H_5$ , and is expressed by the formula  $\left. \begin{array}{c} C_2H_5 \\ H \end{array} \right\} O_2$ .

The action of oxygen on alcohol requires a brief notice. In a nearly anhydrous state, alcohol has little tendency to oxidation, but when freely diluted, and exposed to the air, it rapidly becomes oxidised into acetic acid, a result shewn by the equation,

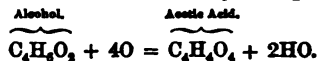

This conversion is, however, not a direct one, an intermediate compound, termed Aldehyde (q. v.), being first formed, which is rapidly oxidised into acetic acid. The oxidation of alcohol into aldehyde is represented by the equation,

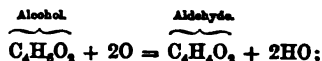

while the further oxidation of aldehyde into acetic acid is represented by

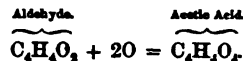

Chlorine and alcohol react singularly on each other—the final products being hydrochloric acid, and a very remarkable colourless oily fluid of a peculiar penetrating and irritating odour, called chloral, which is represented by the formula,  $C_2Cl_2HO$ . Dilute alcohol distilled with chloride of lime (bleaching-powder), yields chloroform; and this is the most economical process for obtaining this invaluable compound. Heated with an excess of sulphuric acid, alcohol loses all its oxygen in the form of water, and is converted into ethylene, the result being shewn by the equation,

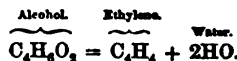

A less complete dehydration, under the action of sulphuric acid, converts alcohol into ether. The process is a complicated one, but the final result is expressed by the equation,

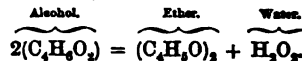

The best tests for discovering the presence of alcohol are—1. Its hot pungent taste, its odour, and its great volatility. 2. Absorbed in asbestos, it burns with a pale blue flame, which deposits no carbon on white porcelain; and when burned in the mouth of an inverted test-tube, containing a few drops of solution of baryta, it produces a well-marked deposit of carbonate of baryta—carbonic acid and water being the products of its combustion. 3. It dissolves camphor. 4. It sets free green oxide of chromium when boiled with a few drops of a saturated solution of bichromate of potash, mixed with sulphuric acid. The chromium test, originally discovered by Dr Thomson in 1846, is that on which

the French physiologists Lallemand, Perrin, and Duroy relied in their investigations regarding the presence of alcohol in the blood, urine, expired air, &c.—See ALCOHOL, PHYSIOLOGICAL ACTION OF.

Alcohol is of a double use to the chemist, inasmuch as it furnishes a cleanly and valuable fuel when used in the spirit-lamp, and possesses remarkable solvent powers without in general exerting chemical action on the dissolved substances. It dissolves many of the gases more freely than water, as, for example, nitrous oxide, carbonic acid, phosphuretted hydrogen, cyanogen, and the hydrocarbons, as, for instance, ethylene. Amongst the mineral substances which it dissolves may be mentioned iodine, bromine, boracic acid, the hydrates of potash and soda, the chlorides of calcium, strontium, magnesium, zinc, platinum, and gold, the perchloride of iron, corrosive sublimate, the nitrates of lime, magnesia, &c.; whilst amongst organic matters, it dissolves many organic acids, bases, and neutral bodies, the resins, the soaps, and the fats, which latter, however, dissolve more freely in ether than in alcohol. The alcoholic solutions of substances used in medicine are called *Tinctures*.

In the article POLYATOMIC ALCOHOLS (q. v.), the general characteristics of the class of bodies now known as alcohols are briefly given. The term *alcohol* is now so far extended as to include all neutral compounds of carbon, hydrogen, and oxygen, which react upon acids in such a way that water is eliminated while ethers are produced. We shall endeavour to elucidate the nature of the different classes of alcohols by giving one example of each principal kind. In a *monatomic alcohol* (see POLYATOMIC ALCOHOLS), half the hydrogen in the primary type for

water,  $\left. \begin{matrix} \text{H} \\ \text{H} \end{matrix} \right\} \text{O}_2$ , is replaced by an organic radical; thus, in methyl-alcohol, or wood-spirit, one equivalent of hydrogen, H, is replaced by one equivalent of the organic radical methyl,  $\text{C}_2\text{H}_5$ —the formula for methyl-alcohol being  $\left. \begin{matrix} \text{C}_2\text{H}_5 \\ \text{H} \end{matrix} \right\} \text{O}_2$ , or  $\text{C}_2\text{H}_5\text{O}_2$ ; while

in ordinary vinic or ethyl-alcohol, there is a similar replacement by the radical ethyl,  $\text{C}_2\text{H}_5$ —the formula for this (the ordinary) alcohol being  $\left. \begin{matrix} \text{C}_2\text{H}_5 \\ \text{H} \end{matrix} \right\} \text{O}_2$ , or

$\text{C}_2\text{H}_5\text{O}_2$ .

The *monatomic alcohols* are more abundant than all the polyatomic alcohols together. There are several series of them, of which the most important are alcohols whose radical is of the form  $\text{C}_m\text{H}_{2m+1}$  (as  $\text{C}_2\text{H}_5$ ,  $\text{C}_4\text{H}_9$ ,  $\text{C}_6\text{H}_{13}$ ), and which are represented by the formula  $\left. \begin{matrix} \text{C}_m\text{H}_{2m+1} \\ \text{H} \end{matrix} \right\} \text{O}_2$ . Of these, twelve are at present known. They are intimately related to the fatty acids, whose general formula is  $\text{C}_m\text{H}_{2m}\text{O}_2$ , which may be formed from the alcohol by oxidation— $\text{O}_2$  being substituted for  $\text{H}_2$ . Thus, alcohol, represented generally by  $\left. \begin{matrix} \text{C}_m\text{H}_{2m+1} \\ \text{H} \end{matrix} \right\} \text{O}_2$ , yields the fatty acid represented by  $\text{C}_m\text{H}_{2m}\text{O}_2$ ; for example, methyl-alcohol,  $\text{C}_2\text{H}_5\text{O}_2$ , yields formic acid,  $\text{C}_1\text{H}_2\text{O}_2$ ; ethyl-alcohol,  $\text{C}_2\text{H}_5\text{O}_2$ , yields acetic acid,  $\text{C}_2\text{H}_4\text{O}_2$ , and so on. The three highest alcohols of this set, whose formulae are  $\text{C}_{10}\text{H}_{22}\text{O}_2$ ,  $\text{C}_{14}\text{H}_{30}\text{O}_2$ , and  $\text{C}_{18}\text{H}_{38}\text{O}_2$ , known as cetyllic, cerotyllic, and melissyllic alcohols, are solid waxy or fatty matters. There is one alcohol whose radical is  $\text{C}_{10}\text{H}_{17}$ , and whose formula is  $\text{C}_{10}\text{H}_{19}\text{O}_2$ —viz. the solid substance known as Borneo Camphor (see RESINS); and in cholesterin (an ingredient of the bile), whose formula is  $\text{C}_{26}\text{H}_{44}\text{O}_2$ , the radical is  $\text{C}_{26}\text{H}_{43}$ . *Diatomic alcohols* belong to the

secondary water type,  $\left. \begin{matrix} \text{H} \\ \text{H} \end{matrix} \right\} \text{O}_2$ , in which, as before, half the hydrogen,  $\text{H}_2$  (which, in this case, is two atoms), is replaced by one atom of a compound radical. The radical is often marked with two

dashes in such cases as these, to indicate that one of its atoms replaces two of hydrogen. Thus, the most important diatomic alcohol, glycol, is represented, according to the theory of types, by the formula  $\left. \begin{matrix} (\text{C}_2\text{H}_4)'' \\ \text{H}_2 \end{matrix} \right\} \text{O}_2$ , its radical being  $\text{C}_2\text{H}_4$ . In the *triatomic*

alcohols, we take  $\left. \begin{matrix} \text{H}_2 \\ \text{H}_2 \end{matrix} \right\} \text{O}_2$ , or the tertiary type of water, and replace half the hydrogen—viz. three atoms, by one atom of an organic radical, which we consequently mark with three dashes. The well-known substance glycerine is the only example of the triatomic alcohols. Its radical is  $\text{C}_3\text{H}_7$ ; and as this replaces three atoms of hydrogen, its typical formula is  $\left. \begin{matrix} (\text{C}_3\text{H}_7)''' \\ \text{H}_3 \end{matrix} \right\} \text{O}_2$ ; its ordinary formula being

$\text{C}_3\text{H}_7\text{O}_2$ , which throws no light on its internal constitution. One *tetratomic* and one *hexatomic* alcohol have been discovered.\* The former is erythrite, a substance obtained from the litmus lichen; one atom of its radical,  $\text{C}_6\text{H}_{13}$ , replaces four atoms of hydrogen, and its typical formula is written  $\left. \begin{matrix} (\text{C}_6\text{H}_{13})'''' \\ \text{H}_4 \end{matrix} \right\} \text{O}_2$ ;

while the latter is mannite (the chief ingredient of the well-known substance MANNA, described in the article SUGAR), in which one atom of the radical,  $\text{C}_{12}\text{H}_{23}$ , replaces six atoms of hydrogen, its typical formula being  $\left. \begin{matrix} (\text{C}_{12}\text{H}_{23})'''' \\ \text{H}_6 \end{matrix} \right\} \text{O}_2$ , while its ordinary formula is  $\text{C}_{12}\text{H}_{24}\text{O}_{12}$ .

We have entered somewhat fully into the consideration of this somewhat difficult subject, because it is one of great general interest, as shewing the close chemical connection between various groups of bodies of apparently totally different natures. No one could have anticipated, twenty years ago, that such very different substances as cholesterin and mannite were allied to ordinary alcohol.†

ALCORA, a town of Valencia, Spain, in the province of Castellon, 43 miles north-north-east from Valencia. It is tolerably well built. Many of the inhabitants are employed in the manufacture of earthenware and the distilling of brandy. Corn, grapes, silk, and hemp are among the principal productions of the neighbourhood. Fruits are a chief article of export. Pop. 5609.

ALDEHYDE ( $\text{C}_m\text{H}_m\text{O}_2$ ) is a volatile fluid produced by the oxidation and destructive distillation of alcohol and other organic compounds. Its discoverer, Döbereiner, called it *light oxygen ether*; its present term is an abbreviation of *alcohol dehydrogenitum*, its composition being represented by that of alcohol from which two atoms of hydrogen have been abstracted. In the article on this subject in Watts's *Dictionary of Chemistry*, ten different modes of obtaining this substance are given. It is sufficient here to state that the best modes of preparing it may be found in that work, or any recent treatise on organic chemistry. It is a thin, transparent, colourless liquid, very inflammable, burning with a blue flame, and having a spec. gr. of 0.8, a boiling-

\* A second tetratomic alcohol, propylphyte,  $\text{C}_6\text{H}_{13}\text{O}_2$ , has been lately artificially formed by Carus; and dulcite, which is isomeric with mannite, is now regarded as a second hexatomic alcohol. We mention these facts to shew what constant additions are being made to this class of bodies.

† There can be no doubt that the sugars will soon be universally admitted to be alcohols, as Berthelot suggested a few years ago. In one of our best and latest works on chemistry, Naquet's *Principes de Chimie, fondée sur les Théories Modernes* (2d ed., 1867), cane-sugar, melitose, trehalose, mycose, méléitose, lactose, and parasaccharose (most of which are described in the article SUGAR, q. v.), are placed under the head of 'Alcohols Polyglucosides.'

point of about 71°, and a pungent, suffocating odour. It mixes in all proportions with water, alcohol, and ether, and dissolves sulphur, phosphorus, and iodine. As is shewn in the article ALCOHOLS, it constitutes an intermediate stage in the oxidation of alcohol into acetic acid. Aldehyde must be regarded as a monobasic acid, inasmuch as it contains one atom of hydrogen replaceable by a metal. Thus, when potassium is gently heated with aldehyde, one atom of H is replaced by one of K, the resulting compound being aldehyde of potash,  $C_nH_{2n-1}KO$ . Various salts of this kind may be formed, of which the most important is aldehyde of ammonia, or aldehyde-ammonia,  $C_nH_{2n-1}(NH_4)O$ , which is obtained in transparent shining crystals, and is a compound that has led chemists to the discovery of a large number of very remarkable derivatives.

ALDEHYDES are a class of organic compounds, intermediate between alcohols and acids; the ordinary aldehyde, described in the preceding article, being, as we have seen, intermediate between ordinary alcohol and its corresponding acid—viz., acetic acid. It has been shewn in the article ALCOHOLS that the compounds of this class related to the fatty acids are represented by the general formula,  $C_nH_{2n-2}O_2$ , while the corresponding acids have the formula,  $C_nH_{2n-4}O_4$ . Each aldehyde is derived from the corresponding alcohol by the abstraction of two atoms of hydrogen, and each aldehyde is converted into its corresponding acid by the addition of two atoms of oxygen. These essential facts are shewn in the equation,

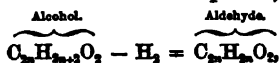

and

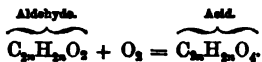

Nine aldehydes of the form  $C_nH_{2n-2}O_2$ , corresponding to  $n = 2, 3, 4, 5, 7, 8, 11, 12,$  and  $16$ , are at present known, the simplest being ordinary or acetic acid,  $C_2H_4O_2$ , and the highest being palmitic aldehyde,  $C_{16}H_{32}O_2$ . It is obvious that, as far as is yet known, there is not of necessity always an aldehyde intervening between the alcohol and corresponding acid; for example, methylic and caprylic alcohols have not yet yielded an aldehyde.

Amongst aldehydes not connected with the preceding group may be mentioned various organic compounds which have been recently shewn to belong to this class—thus, acrolein,  $C_3H_4O_2$ , is acrylic aldehyde; camphor,  $C_{10}H_{16}O_2$ , is camphoric aldehyde; bitter-almond oil,  $C_{11}H_{18}O_2$ , is benzoic aldehyde; oil of cumin,  $C_{11}H_{18}O_2$ , is cuminic aldehyde; oil of cinnamon,  $C_{12}H_{18}O_2$ , is cinnamic aldehyde; salicylic acid,  $C_7H_6O_4$ , is salicylic aldehyde; and anisylous acid,  $C_9H_8O_4$ , is anisyl aldehyde. Most of these aldehydes are obtained directly from plants, and either exist in them ready formed, or are given off as volatile oils on distillation with water.

For the best account of the aldehydes with which we are acquainted, we must refer to the chapter on that subject in the second edition (1867) of Naquet's *Principes de Chimie, fondée sur les Théories Modernes*, vol. ii. pp. 384—405, in which will be found a full account of the aldehydes derived from the monatomic alcohols, of the modes of preparing them, of the properties common to all aldehydes, and those specially belonging to different series, the rational formulæ and constitution of aldehydes, and the aldehydes derived from diatomic alcohols or glycols, in which this chemist includes not only salicylic, salicylic, and glycolic aldehydes, but that remarkable synthetic product, Furfural (q. v.).

ALDROVANDI, ULTRASSI, one of the most distinguished naturalists of the 16th c., was born at Bologna, probably about the year 1522. He was descended of a noble family, and received an excellent education, partly in his native city and partly at Padua. Some of his religious opinions having been called in question, he travelled to Rome in 1550, to vindicate himself; and whilst there, studied Roman antiquities, and wrote a treatise on ancient statuary. At Rome, he formed the acquaintance of Rondelet. On his return home, he devoted himself to the study of botany, and having taken his degree in medicine at the University of Bologna in 1553, he was in the following year appointed to the chairs of Philosophy and Logic, and also to the lectureship on Botany. He practised medicine for some time in Bologna, and appears after a short time to have exchanged some of the chairs which he held in the university for that of Natural History, to the study of which science he applied himself with great devotedness. He established the Botanical Garden at Bologna in 1567. He was much employed, during many years, in forming a museum of natural history, collecting specimens with great assiduity, and employing draughtsmen to make figures of them for the great work on natural history which he contemplated. In the pursuit of his favourite science, he travelled into different countries, but no particular record of his travels remains. Inspiring others with a zeal similar to his own, he had the pleasure of seeing his museum rapidly increase. He finally bequeathed it to the Senate of Bologna, and it became the foundation of the splendid public museum of that city, where many of A.'s specimens remain to this day. He left behind him, also, at his death, a prodigious mass of valuable manuscripts, which still remain in the public library of Bologna, a store of which proper use has never yet been made, and in which there is probably much correspondence of eminent men, interesting as shewing the first steps of progress of the science of natural history, after the long dormancy of the middle ages. All his studies and collections were made subservient to his work on Natural History, the first volume of which—on Birds—appeared in 1599. Six volumes appeared during A.'s life; other seven were published under the direction of his colleagues and pupils after his death, which took place in 1605. It has been stated in many notices of his life, and was long commonly believed, that, by his scientific pursuits, A. reduced himself to circumstances of great poverty, and that he died in a public hospital at Bologna; but the story, although Bayle has adopted it in his Dictionary, rests on no sufficient evidence, and there is reason to think that it is not true. It is difficult to procure a complete edition of the works of A., and the volume on Minerals is especially rare. A. has been censured for excessive copiousness in things of little importance, and at best merely serving to illustrate his subject and render it interesting. He shews, however, great anxiety to set forth all that is known on every subject of which he treats; he writes of natural history in a way which shews that he greatly loves the science, and at the same time with a devout and reverent spirit, always beholding in the works of creation the traces of the Creator's hand.

ALDSTONE, or ALSTON, sometimes called ALSTON MOOR, a market-town of the county of Cumberland, England, 30 miles east-south-east from Carlisle. The parish of A. contains extensive and very productive lead mines, formerly belonging to the Earls of Derwentwater, and now to the Lords Commissioners of the Admiralty. The town has manufactures of worsted yarns and flannel. It is situated in a mountainous district, on the declivity

of a steep hill, near the confluence of the Nent and South Tyne. The population is about 2500. The produce of the lead mines has fallen off considerably during the past 15 years. Pop. of pariah (1871) 5680.

**ALESSANDRIA DELLA ROCCA**, a town of Sicily, in the province of Girgenti, and 17 miles north-by-west from Girgenti, picturesquely situated in a mountainous district. Pop. of commune, 5214.

**ALEWIFE** (*Alosa tyrannus*), a fish of the same genus with the Shad (q. v.), which, in the end of spring and beginning of summer, appears in great numbers on the eastern coast of North America, and enters the mouths of rivers to spawn. It appears in Chesapeake Bay in March, on the coasts of New York and New England in April, and on those of the British provinces about the 1st of May. It abounds in the Bay of Fundy, but is more rare in the Gulf of St Lawrence; and the Bay of Miramichi appears to be its northern limit. It ascends rivers only as far as the tide extends, and after spawning, returns to the sea in the middle of summer. It prefers a soft, muddy bottom. Its length is not more than 12 inches. The A. is called *Spring Herring* in some places, and *gasperus* by the French Canadians. It is inferior to the herring, yet it is a valuable fish. The fishery is prosecuted in the rivers, by small-meshed seine-nets, set across the stream. Large quantities are taken in the rivers of New England, New Brunswick, and Nova Scotia. The harbour of St John's, New Brunswick, alone produces from 12,000 to 20,000 barrels annually. This fish, in a salted state, forms a considerable article of export from the northern parts of America to the West Indies.

**ALEXANDRI**, or **ALEKSANDRI**, **VASILIO** (Basil), a Rouman poet and *littérateur*, was born at Jassy, the chief city of Moldavia, in 1821. His family was of Venetian origin. After spending several years at a French boarding-school at Jassy, he was sent, in his fourteenth year, with a tutor to Paris; and in due course he obtained from the University of Paris the degree of Bachelor of Letters. He is said to have thereafter made trial in succession of the study of medicine and the study of law, and to have found neither of them to his liking; he certainly followed up neither, but without qualifying himself for any profession, went back to Jassy in 1839. He found at Jassy a band of young men educated, as he himself had been, in France, whose minds had been formed upon the literature and the political ideas of France; who, besides being ambitious of literary distinction, were zealous for political equality and for Rouman nationality and independence. He naturally became the associate of these men; and soon after his return, made his *début* in literature by contributing a story, *The Flower-girl of Florence*, to a periodical conducted by them under the editorship of Cogalniceano. He became a frequent contributor to this periodical. Unfortunately, it was not destined to live long, being suppressed by order of Prince Stourdza. It was in 1842, after a long excursion among the mountains of his native province, that he first made his appearance as a poet, publishing several pieces, most of them strongly tinged with national feeling. At this time, too, it was that he began to write the songs and ballads upon which his chief claim to literary reputation at present rests. In 1844, he suddenly attained to an almost unbounded local popularity as a play-writer. Having become concerned in the management of two theatres at Jassy, the one French, the other Moldavian, he produced a series of pieces, some in French, others in Rouman, which, though mostly slight and hasty performances, had merit enough to excite the

enthusiasm of his countrymen. *Georges de Sadagoura*, *Jassy en Carnaval*, *La Pierre de la Maison*, *La Noce Villageoise*, are the titles of the most important of them. In 1844, he had also, in conjunction with Cogalniceano and Prince John Ghika, set on foot a new periodical, devoted to literature and science; but this, like the one already mentioned, was not suffered to live long—it was suppressed by the government, after a career of only nine months.

A. was engaged in the revolutionary movement which took place at Jassy in the year of revolutions, 1848, and on its failure, had to betake himself for a time to Paris. There, through the press, during the short period of his exile, he laboured to arouse public opinion in favour of the independence of the Roumans; and his efforts, though they were unsuccessful at the time, helped, with those of others, to prepare the way for what took place several years after. It was to the Russian war that Moldavia and Walachia were destined to owe their virtual emancipation from the yoke of Turkey, and the chance of obtaining self-government and union. The union of the two principalities was carried by the resolution of their inhabitants, backed by the support of France, in spite of political obstacles that seemed almost insurmountable; and A. did not a little to inspire the resolution of his countrymen. A song which he wrote at the critical moment in 1856, *The Hour of Union*, became exceedingly popular, and, by its stirring appeals to the feeling of Rouman nationality, helped to allay the jealousies which divided the two principalities, and to make them work together for the union. A. took a prominent part in all the political transactions which culminated in this result. It should be stated, that two years earlier, when the death of his father had put him into possession of the family estate, he had emancipated the serfs who lived upon it; and that this example found so many imitators that the government found itself almost immediately compelled to decree a general measure of enfranchisement.

A.'s *Popular Ballads of Roumania*, which he had begun to compose in 1842, appeared at Jassy in two parts in 1852 and 1853. One of the parts, translated into French by himself, was afterwards published at Paris under the title of *Ballades et Chantes Populaires de la Roumanie*. His collected dramatic works were published at Jassy in 1852. Another volume of poems appeared at Paris in 1853; and of this volume a French translation, with the title, *Les Doimas, Poesies Moldaves*, was soon afterwards produced by M. Vanesco. *Le Collier Littéraire*, a miscellaneous collection of pieces in prose and verse, many of which had previously appeared in periodicals, he published in 1857. A., as may be inferred from facts already stated, has written largely in periodicals, but mostly upon subjects of passing interest. All his works, besides their intrinsic merits, which are very considerable, are interesting from the connection they have with the growth of a national feeling among the Roumans.

**ALEXANDRIA**, a town of Dumbartonshire, Scotland, on the west bank of the Leven, opposite to Bonhill, three miles from Dumbarton, on the Glasgow, Dumbarton, and Vale of Leven Railway. It is a town of recent growth, of a neat and pleasing appearance, in the midst of beautiful scenery. It has extensive cotton-printing works, and other public works. Pop. in 1871, 4650.

**ALFONSINÈ**, a town of Italy, in the province of Ravenna, nearly four miles north-west from Ravenna, in a level, irrigated, and fertile district. Pop. of commune, 6741.

**ALFRETON**, a market-town of Derbyshire, England, 12 miles north-north-east from Derby, and a station on the Erewash branch of the Midland Railway. It has manufactures of hats, stockings, and brown earthenware. There are collieries and iron-works in the vicinity. The town is irregularly built, and contains many very old houses, but has of late rapidly increased. It is said to derive its name from Alfred the Great. Pop. (1871) 3680.

**ALHA'MA** (Arab. *The Bath*; the Roman *Astigia Juliensis*), a town of Andalusia, Spain, in the province of Granada, 25 miles south-west from Granada. Its situation is extremely picturesque, on the edge of a projecting rock, overhanging a deep chasm of limestone hills, through which the river Marchan foams, and with mountains in the background rising to the height of 8000 feet. Vineyards and gardens mingled with the houses on the steep slopes add to the interest of the scene. A. is a decayed town, although its warm sulphureous baths are still frequented by visitors in the beginning and end of summer. The Moors derived a large revenue from its baths. It was a famous fortress of the Moors; and its capture, in 1482, prepared the way for that of Granada. There are still remains of the Moorish castle and town wall. There are ruins also of a Roman aqueduct: the principal bath still in use is a Moorish edifice; and a smaller one is supposed to be Roman. Pop. 6284.

**ALHAMA**, a town of Murcia, Spain, 17 miles south-west from Murcia. It is celebrated for its warm mineral waters, and is resorted to for bathing. It has a ruined castle. Pop. 5200.

**ALHAURIN EL GRANDE**, a town of Granada, Spain, in the province of Malaga, and 19 miles west from Malaga, on the north side of the Sierra de Mijas, and near the Faala, an affluent of the Guadalheroa. It is a well-built town, with a number of squares, wide well-paved streets, and many fountains. There are remains of a Roman aqueduct and of an Arab fortification. Many of the inhabitants are employed in working the marble, freestone, and granite quarries of the vicinity, and its lead and antimony mines. Pop. 5514.

**ALIA**, a town of Sicily, in the province of Palermo, 30 miles south-east from Palermo, picturesquely situated on the crest of a hill, in a mountainous and craggy district, near a torrent called the Fiume Torto. Pop. 5425.

**ALICATA**, or **LICATA**, a town of Sicily, in the province of Girgenti, and 26 miles south-east from Girgenti. It is most beautifully situated on the sea-coast, at the mouth of the Salso (anc. *Himera Meridionalis*), one of the largest rivers, if not the largest, in Sicily; its buildings stretch along the shore, and occupy the steep slope of the hill, which is crested by the great old fortress, now indeed of little strength, but of imposing appearance. On the brow of a hill to the west of the town, is the dismantled castle of St Angelo, said to occupy the site of that in which the tyrant Phalaris kept the brazen bull, his celebrated instrument of torture. A. itself is generally believed to stand on the spot where the ancient *Phintias* was built (280 B.C.) by Phintias, tyrant of Agrigentum, after he had destroyed Gela, the inhabitants of which he transferred hither. The place and immediate neighbourhood were the scene of some memorable battles in the wars between the Carthaginians and Sicilians, and between the Carthaginians and Romans. In the middle ages, A. suffered severely from the depredations of Barbary corsairs. It has a very bad port, the sea being so shallow that only vessels of small size can approach the town; larger vessels

are compelled to anchor about a mile from the town, and are loaded and unloaded by the aid of small craft. Yet A. has a considerable trade, exporting corn, macaroni, fruit, almonds, pistachio-nuts, sulphur, soda, and wines. Pop. 14,338.

**ALL SOULS' COLLEGE**, Oxford, was founded in 1437 by Henry Chichele, sometimes Fellow of New College, and successively Bishop of St Davids and Archbishop of Canterbury, for a warden, 40 fellows, 2 chaplains, and clerks. However, by an ordinance framed by the commissioners appointed under the statute 17 and 18 Vict. c. 81, ten of the fellowships have been suppressed in order to the endowment of two professorships, to be called 'the Chichele Professorship of International Law and Diplomacy,' and 'the Chichele Professorship of Modern History.' The remaining fellowships are open to all, irrespective of birth (date or place), position, or profession, provided only the candidates have passed all the examinations required for B.A., and have obtained either some prize or scholarship open to general competition, or a 'first-class' place in one of the public examinations of the university. The candidates also must be examined in Jurisprudence and Modern History. The patronage includes 19 benefices, situated in Kent, Oxford, Essex, Gloucester, Berks, Bucks, Herts, Northampton, Salop, Surrey, and Wilts, of an annual value of £7925. In 1875, this college had 115 members on its books.

**ALLYL** (Lat. *allium*, garlic) is an organic radical, represented when in combination by  $C_3H_5$ , and when in the free state by  $C_3H_7$ . The first compound discovered was iodide of allyl, which was obtained by Berthelot and De Luca in 1854; two years later, they isolated allyl; and shortly afterwards, Wertheim demonstrated its existence in the oils of mustard and garlic. Its properties, and those of some of its most important compounds, are described in the article **GARLIC**, OIL or.

**ALMA'DA**, a town of Portugal, in the province of Estremadura, on the south bank of the Tagus, opposite to Lisbon, and distant from it less than two miles. There is frequent steam-communication with Lisbon. A. is built upon a height, from the summit of which, above the town, there is a magnificent view of Lisbon and the Tagus. A. has a strong castle on a rock. The surrounding country is well cultivated. A. has long been celebrated for its figs. Near it is the gold mine of Adissa. Pop. 5500.

**ALMA'GRO**, a town of New Castile, Spain, in the province of Ciudad Real, and 13 miles east-south-east from Ciudad Real. It is situated in a high arid plain, but is very well built, with wide paved streets, a fine square, and a public walk lined with trees. Its most noteworthy building is an old church of beautiful architecture. It is a place of greater activity than most Spanish towns, and its whole appearance indicates prosperity. Brandy, soap, and earthenware are manufactured, and lace-making gives employment to about 8000 women in A. and the neighbouring villages. The surrounding country is celebrated for its mules. There are two great annual fairs, at which mules and lace are sold. Pop. 12,605.

**ALMA'NSA**, a town of Murcia, Spain, in the province of Albacete, and 43 miles east-by-south from Albacete, on the Madrid and Alicante Railway. It is situated in a wide plain, and is tolerably well built, and rather flourishing. The *vega*, or plain around the town is irrigated by water from a large reservoir called the *Pantano de Abujera*, and is very fertile. Many of its ague-breeding swamps have been drained and brought under cultivation.

A. carries on manufactures of linen, hempen, and cotton fabrics, the materials of which are supplied from the neighbourhood, also of brandy, leather, and soap. Pop. 8736.—Near A. the French, under the Duke of Berwick, natural son of James II. of England, gained a victory, on 25th April 1707, over an army of Spanish and English troops, commanded by Henry de Ruvigny, Earl of Galway. The French were more than twice the number of their opponents. Ruvigny fought under orders from home, contrary to his own judgment, and was deserted by the Spaniards almost as soon as the battle began. The battle of A. was, in its results, one of the most important in the War of the Spanish Succession. See SUCCESSION WARS.

A'LMAS, a town of the Austrian empire, in Hungary, 16 miles west from Maria Theresiopol. The inhabitants are almost all Roman Catholics. Pop. (1869) 8193.—Almas is the name of many small towns and villages in Hungary.

ALMAZORA, a town of Valencia, Spain, in the province of Castellon, four miles south-by-east from Castellon de la Plana, in a plain on the left bank of the Mijares, three miles from its mouth. It has some wide and well-paved streets and squares. Linen and woollen fabrics and paper are manufactured. The surrounding country is fertile, producing wheat, barley, maize, oil, oranges, &c. Pop. 5150.

ALMODOVAR DEL CAMPO, a town of New Castile, Spain, in the province of Ciudad Real, 22 miles south-west from Ciudad Real. It stands on the summit of a ridge, near the Vega, a branch of the Guadiana. The streets are tolerably clean, but ill paved. There are ruins of an ancient castle. The inhabitants are chiefly employed in agriculture, and the only manufactures are domestic. Pop. 5620.

ALMORA, the principal town of the British district of Kumaon (q. v.), India, 87 miles north from Bareilly, on the crest of a mountain ridge, 5337 feet above the sea, on the head-waters of the Kosila, a branch of the Ramgunga. It consists chiefly of one street, three-quarters of a mile long. The houses have a ground story of stone; the upper stories are of wood, covered with a sloping roof of heavy gray slate, on which small stacks of hay are sometimes erected. The ground story is generally white-washed and tricked out with grotesque paintings. Detached houses, both of Europeans and Brahmans, are scattered along the face of the mountain below the town. A. is a British military station, the lines of the regular troops and Fort Moira being close to the town. Since it came under British sway, it has been rapidly increasing in prosperity. Pop. (1871) 6151.

ALMORAVIDES ('The *Moravides*'), or MORABETHUN, the name of an Arab dynasty that ruled in Africa and Spain in the 11th and 12th centuries of the Christian era. The name A., which is commonly given to this dynasty by Western writers, is a corruption of the Arabic word *Al-morabeth*, 'the champion of religion.' This sect took its rise about 1050 among the Arab and Berber tribes which dwelt on the slopes of the Atlas range facing the Atlantic, and was founded by a Moalem teacher called Abdalla-ben-Yasim, who undertook to rescue these tribes from the gross ignorance in which they were plunged, and instructed them in the doctrines of the Mohammedan faith. The new proselytes soon exhibited the fruits of this teaching by descending from their hills, under the leadership of a chief named Abu-bekr, and conquering the kingdom of Fez. The adjoining kingdom of Morocco shared the same fate; and the victorious enthusiasts, under the famous Yussuf-ben-Taxfin, the cousin of

Abu-bekr, next crossed the Strait of Gibraltar, and subdued Spain to the Tagus on one side, and to the Ebro on the other. But this extensive and powerful dominion was of too rapid growth to possess much stability; and during the reign of Ali, the son of Yussuf, arose the sect of the Almohades (q. v.), which after a time expelled the A. from Africa, and in 1144 subdued their power in Spain. It was the Almoravide princes who introduced the *Maravidi* (q. v.) into Spain, and in that and the word *Marabuts* (q. v.) their name is still preserved.

ALMUNECA'B (Arab. *Al Munneca'b*, the gorge), a seaport town of Andalusia, Spain, in the province of Granada, 31 miles south of Granada. The port is somewhat exposed. The town is generally well built. It was a place of importance in Moorish times, when the coast of Granada was highly cultivated and extremely productive, particularly in sugar and cotton. Efforts have recently again been made to extend the culture of both. The inhabitants of A. are chiefly engaged in agriculture and sugar-refining. There is a considerable trade in cotton, sugar, and fruit. Pop. 5000.

ALORA, a town of Andalusia, Spain, in the province of Malaga, 18 miles north-west of Malaga, on an elevated site near the right bank of the Guadalherce. Some of the streets are well built and well paved; some are very steep and irregular. There are ruins of an ancient Gothic castle. The inhabitants are mostly employed in agriculture. Soap and sulphate of soda are manufactured. The neighbourhood produces much oil and excellent wine. Pop. 6794.

ALPES MARITIMES, a dep. of France, in the extreme south-east, on the shores of the Mediterranean and confines of Italy, formed in 1860, of the ancient county of Nice, then ceded to France, and formerly belonging to the kingdom of Sardinia, and of the arrondissement of Grasse, detached from the department of Var. The chain of the A. M. forms the northern boundary of the department, and from it numerous spurs run seaward, among which are lovely and fertile valleys. The chief rivers of the department are the Loup, the Var, and the Paillon, at the mouth of which Nice is situated. The climate is mild and pleasant in the vicinity of the sea, and in the lower valleys, although the higher mountains reach to altitudes where winter always reigns. The vine and olive are much cultivated in the more favoured localities; oranges, lemons, and figs are produced in abundance and of excellent quality; a considerable extent of land is devoted to tobacco, and not a little to the cultivation of herbs and flowers for the preparation of essences and perfumes. Grasse is particularly famous for the manufacture of perfumery. In many parts of the department, there are noble forests. In the more elevated parts, much land is used for the pasture of sheep, and also of goats, of which these regions possess a highly esteemed breed. The silk-worm is reared to a considerable extent, and the keeping of bees is a source of no little wealth, honey being largely produced and exported. The mineral riches are not great. There are some quarries of white marble, and some mineral springs. Among the chief branches of industry, besides those which are strictly rural, are brass-founding and the making of bijouterie. The tunny, anchovy, and sardine fisheries give employment to many people on the shores of the Mediterranean, and great quantities of anchovies and sardines are exported from the port of Cannes. The department is divided into three arrondissements—Nice, Puget-Théniers, and Grasse. The capital is Nice (q. v.), and the other

## ALTAI MOUNTAINS—ALVA.

principal towns are Antibes (q. v.), Villefranche, Cannes (q. v.), Grasse (q. v.), and Menton, or Mentone (q. v.), on the eastern frontier.—The county of Nice was bestowed in 1388 on Amadeus VII., Duke of Savoy, and latterly formed part of the kingdom of Sardinia till 1860, except that it was seized by France in 1792, and for a time formed into the department of Alpes Maritimes. It was restored to Sardinia in 1816. After the treaty of 1860 was concluded, it was apprehended that the people of this region, on account of their race, customs, and language, would not shew the same willingness to be transferred to France as the people of Savoy; but no transference of territory was ever more easily accomplished, or with less apparent dissatisfaction of those most nearly concerned. The pop. of the department in 1872 was 199,037.

**ALTAI MOUNTAINS.** Since the article **ALTAI** was originally written, the explorations of Russian surveyors have led to a more definite knowledge of the form and limits of this important range, now described as a separate system, one of the four parallel chains which constitute the skeleton of Eastern High Asia, covering the great tableland. The A. forms an alpine girdle, intersected by wide valleys traversed by many streams, among which are the Tez river, flowing west to the Ubsa Nor (lake), and the Kobdo, flowing south to the Tke Aral Lake. The general direction of the range is from west to east, about the parallel of 50° north. It extends between the meridians of 84° and 100° east. On the east, the A. is separated from the Daurian mountain-system by lakes Kogol and Baikal; on the west, it terminates in the Katunk Mountains, a small isolated group, in which Mount Beluka rises to 12,790 feet, far above the line of perennial snow, with extensive glaciers on its western flanks. The climate of the A. is not so severe as might be inferred from its position. The winters are frequently mild, and comparatively little snow falls. The mountain slopes are covered with rich grass, and their flanks are in many parts adorned by magnificent cedar forests. Stags, hares, and wolves abound in the lower, and bears in the higher portions of the range. The A. is celebrated for its gold, silver, and lead mines. Barnaul, on the northern slope of the range, is the chief mining town; and the village of Zeminogorski, south of Barnaul, is in the centre of the richest silver mines in the Russian Empire. North of the Ubsa Nor (lake), the Tangu Ula Mountains, connected with the A. on the north, rise to upwards of 11,000 feet. They furnish abundance of white marble of an excellent quality.

**ALTAMURA**, a town of South Italy, in the province of Bari, and 28 miles south-west from Bari, at the eastern base of the Apennines. It is a well-built and beautiful town, surrounded with walls, and having a magnificent cathedral. The surrounding country is fertile, produces much oil and wine, and abounds in rich pastures. A. is supposed to occupy the site of the ancient *Lupazia*. Many fine Grecian antiquities have been dug up. Pop. 17,198.

**ALTEA**, a seaport town of Valencia, Spain, in the province of Alicante, and 25 miles north-east from Alicante. It stands on a rising ground, on the right bank of a small river called the Alga, and at the head of a bay. It has wide streets, but many of them are steep. The inhabitants are mostly engaged in agriculture; some of them are fishers and sailors. Linen fabrics, ropes, and soap are manufactured. Pop. 5502.

**ALTENA**, a town of Westphalia, Prussia, in the government of Arnsberg, 40 miles north-east from Cologne. It stands on the right bank of the Lenne,

in a deep and picturesque valley. It has large public works, the machinery of which is moved by water-power, and manufactures great quantities of needles, pins, and other small articles of hardware. There are also stocking manufactories and tanneries. Pop. (1871) 7122.

**ALT-OFEN**, a town of Hungary, on the right bank of the Danube, about two miles above Ofen or Buda, of which indeed it may be considered a suburb. The towns are almost united. A. is a decayed place, but of great antiquity, and is believed to occupy the site of a Roman town, *Sicambria* or *Aquincum*. Remains exist of a Roman aqueduct, a bath, and an amphitheatre. Attila made this his capital. Pop. (1869) 16,002.

**ALTON**, a town of Hampshire, England, of considerable antiquity, near the Wey, 16 miles north-east from Winchester. It is pleasantly situated among picturesque hills and woods. Most of the houses are of brick, but some are of stone. The principal street forms part of the main road from London to Winchester. The church was erected in the reign of Henry VII., and is in the Perpendicular style. Its tower, older than the rest of the edifice, has massive Norman arches. A branch railway connects A. with the South-western Railway. Bombazines were formerly manufactured here. Good hops are grown in the neighbourhood, and there are large breweries in the town, the ale of which is much esteemed. Pop. (1871) 4092.

**ALTON**, a city and port of entry of Illinois, U. S., on the left bank of the Mississippi River, 21 miles above St. Louis, 3 miles above the mouth of the Missouri River, the terminus of the Chicago and Alton Railway, and centre of a large commerce. The city contains a Roman Catholic cathedral, 10 churches, 1 daily and 3 weekly newspapers, state penitentiary, and numerous mills and manufactories, with an abundant supply of coal and limestone. Pop. (1860) 6333; (1870) 8665.

**ALTOONA**, a city of Pennsylvania, U. S., on the Central Railway, at the eastern base of the Alleghanies, 244 miles west of Philadelphia; contains 11 churches, 2 banks, 6 hotels, and large locomotive works and machine-shops. Laid out in 1849. Pop. (1865) 5500; (1870) 10,610.

**ALTRINCHAM**, a market-town of Cheshire, England, on Bowden Downs, eight miles south-west from Manchester. It is situated on the Cheshire Midland Railway, and near the Duke of Bridgewater's Canal, which has contributed greatly to its prosperity. It is a very neat and clean town, and on account of the salubrity of the air, is much resorted to by invalids from Manchester. It has manufactures of artificial manures, and an iron-foundry, but a chief employment of its inhabitants is the raising of fruits and vegetables for the market of Manchester. Pop. (1861) 6628; (1871) 8478.

**ALVA**, a village of Stirlingshire, Scotland, pleasantly situated on nearly level ground at the mouth of a romantic glen of the Ochil Hills, 7 miles north-east from Stirling. The part of Stirlingshire in which A. is situated is detached from the rest of the county, and enclosed between the counties of Clackmannan and Perth. A. is a place of great industrial activity, having extensive woollen factories. Formerly the prevailing branch of industry was the blanket trade. In later years this has been entirely superseded by the manufacture of shawls. Tweeds have also been introduced. The number of looms employed is about 1100, the steam-looms having been introduced during the summer of 1867. To the east of the village is a glen, named the Silver Glen, where two pits are still to be seen, marking the site of old silver mines.

## ALVARADO—AMIDES.

The communion cups still in use in the parish church are made of silver derived from these mines.

Immediately behind the town is Alva Glen, noted for its picturesque beauty and magnificent waterfall. About a mile to the west of the village is Balquharn Glen, also a very romantic spot. Pop. (1861) 3147; (1871) 4096.

**ALVARADO**, a town of Mexico, in the department of Vera Cruz, on the Gulf of Mexico, at the mouth of the river Alvarado, 50 miles south-east from Vera Cruz. The situation, close to a lagoon, is unhealthy. A bar at the mouth of the river prevents the entrance of vessels of more than 12 or 13 feet draught, but within the bar, the harbour is sheltered from every wind. Great part of the town consists of cane-built cottages, roofed with palm-leaves. The river has a course of not much more than 100 miles, but collects the waters of an extensive swampy district. Much rice and cacao are produced in the country around Alvarado. Pop. 6000.

**ALWUR**, or **MACHERY**, a Rajpoot state of India, under the control of the governor-general's agent for the states of Rajpootana, but having a considerable measure of independence. It lies between N. lat. 27° 14'—28° 18', and between E. long. 76° 14'—77° 18'. Its area is about 3000 sq. miles; its pop. (1872) is 778,596. The capital, Alwur, is a small ill-built town, surrounded by a wretched mud wall, situated at the base of a rocky range of quartz and slate, 1200 feet above the adjacent country, and at least 2100 feet above the sea, 94 miles west-north-west from Agra. The palace of the Rao Rajah is a curious square building, having its walls pierced with a great number of small windows, and covered with glaring and grotesque paintings. The revenue of the Rao Rajah is estimated at about £180,000. The military force of the state amounts to about 3000 infantry and 4000 cavalry. The inhabitants, who are called Mewattis, are a rude and savage race. In former times, the Mewattis were a predatory tribe, and from the 13th to the 15th c., carried their raids even to the gates of Delhi.

**AMARANTÉ** (anc. *Ante Moranam*), a town of Portugal, in the province of Minho, on the Tamega, a branch of the Douro, 32 miles north-east from Oporto. The Tamega is crossed by a handsome stone bridge. The town is well built, but dull and decayed. A church, erected in the 16th c., is an interesting specimen of the Flamboyant style. A was the scene of a fierce conflict between the French and the Portuguese in 1809, when the bridge was defended by the Portuguese for several days, and the French committed great barbarities. Pop. 5500.

**AMASIA**, **AMASIEH**, or **AMASIYAH** (anc. *Amasia*), a town of Asia Minor, the principal town of the vilayet of Sivas, on the right bank of the Yesil-Irmak, about 80 miles from the mouth of the river, and 200 miles south-west from Trebizond. It stands in a deep and narrow valley, and the river flows through a narrow channel, between precipitous rocky banks. The streets are narrow and crooked; the houses mostly of wood, although some are of stone, all covered with tiles. The river is crossed by three stone bridges, and one wooden bridge. One of the stone bridges is supposed to be Roman. The ancient town, the birthplace of Strabo, occupied both banks of the river, and the remains of the Acropolis crown a lofty rock on the side of the river opposite to the present town. There are numerous other interesting remains of antiquity, particularly the tombs of the kings of Pontus, whose capital A. was, excavated in the

face of a steep rock, and some Saracenic buildings. Water is raised from the river by means of wheels driven by the river itself, for irrigation of the gardens and mulberry plantations. Much silk is produced in and around A.; also wine, cotton, corn, and madder. Silver, copper, and salt mines are wrought in the neighbourhood. Silk and salt are the chief articles of export. A. is the seat of an Armenian bishop. Pop. 30,000, of whom about one-third are Christians.

**AMATRIONE**, a town of South Italy, in the province of Aquila or Abruzzo Ulteriore II., on the right bank of the Tronto, 21 miles north-by-west from Aquila. It was formerly a place of much greater importance than it is at present. It has five churches. The inhabitants are chiefly employed in agriculture and the manufacture of blankets. Pop. 2242.

**AMBA'TO**, or **ASIENTO D'AMBATO**, a town of Ecuador, on the north-eastern slope of Chimborazo, 66 miles south from Quito, 8859 feet above the sea. It was destroyed in 1698 by an eruption of Cotopaxi, but was soon rebuilt, and became more flourishing than before. It carries on an active trade in grain, sugar, and cochineal, the products of the surrounding country. Pop. 12,000.

**AMBER**, a decayed city in the Rajpoot state of Jeypoor, India, four miles north-by-east from Jeypoor, in 28° 59' N. lat., and 75° 58' E. long. It is situated on the margin of a small lake, in a deep hollow among hills; and its temples, houses, and streets are scattered among numerous ravines opening on the lake. Comparatively few of its houses are now inhabited; but everywhere are to be seen ghastly Hindu ascetics, sitting amidst the tombs and ruined houses. On the slope of an adjacent hill is the vast and gorgeous palace of Amber, a building remarkable for its massiveness and solidity.

**AMELIA** (anc. *Ameria*), a town of Central Italy, in the province of Perugia, 21 miles south-west of Spoleto. It is picturesquely situated on the mountains between the Nera and the Tiber, about seven miles from the junction of the two rivers. It is the seat of a bishop, and has a cathedral. Pop. of commune, 7024.

**AMIDES** are a group of organic compounds, derived, under certain conditions, from ammonia (NH<sub>3</sub> or NHHH), by the exchange of one or more atoms of hydrogen for a corresponding number of atoms of a metal, or a compound radical. The first of these compounds that was discovered was that in which one atom of hydrogen was replaced by one of potassium (NH<sub>4</sub>K, or NH<sub>3</sub>K), the resulting product being regarded as a compound of NH<sub>3</sub> (*amidogen*) with potassium, and being termed *amide of potassium*. At present, the term *amide* is restricted to the case in which one or more atoms of hydrogen are replaced by an *acid radical*, and the amides are called primary, secondary, or tertiary, according as one, two, or all three of the atoms of hydrogen are replaced by the acid radical. The primary amides may be obtained in various ways, of which we shall mention two: (1.) If we heat an ammoniacal salt, two atoms of water are given off, and the amide corresponding to the acid is left; thus, acetate of ammonia (NH<sub>4</sub>O.C<sub>2</sub>H<sub>3</sub>O<sub>2</sub>)—water (H<sub>2</sub>O)<sub>2</sub> = acetamide {C<sub>2</sub>H<sub>5</sub>(NH<sub>2</sub>)O<sub>2</sub>}, which, expressed typically, is C<sub>2</sub>H<sub>5</sub>O<sub>2</sub>.

$$\left. \begin{array}{c} \text{H} \\ | \\ \text{H} \end{array} \right\} \text{N, where C}_2\text{H}_5\text{O}_2 \text{ is the radical of acetic acid.}$$

(2.) If an anhydride is submitted to the action of ammonia, there are simultaneously formed an amide and an ammoniacal salt. Thus, valerianic or valeric anhydride (C<sub>10</sub>H<sub>17</sub>O<sub>3</sub>)<sub>2</sub> + ammonia (NH<sub>3</sub>) = valerate of ammonia (NH<sub>4</sub>O.C<sub>10</sub>H<sub>17</sub>O<sub>3</sub>) + valeramide



$\left\{ \begin{array}{l} C_{10}H_7(NH_2)O_2 \\ C_{10}H_7O_2 \\ H \\ H \end{array} \right\} N$ , where  $C_{10}H_7O_2$  is the acid radical of

valeric acid. The amides are, for the most part, capable of being obtained in a crystalline form, and are fusible volatile bodies. For a description of the more complicated forms of amides, and for a history of their general properties, the reader is referred to the article 'Amides' in Watts's *Dictionary of Chemistry*, and to the chapter on Amides in the 2d edition (1867) of Naquet's *Principes de Chimie*, vol. ii. pp. 344—368. If, in place of an acid radical, a base radical replaces one or more atoms of hydrogen in ammonia, a class of compounds, termed *amines*, is formed, whose composition is noticed in the article ORGANIC BASES.

A'MLWCH, a town of Anglesey, North Wales, on the north coast of the island, 14 miles north-west from Beaumaris. It stands on a rising ground close to the sea, and consists of one principal street, with diverging streets and lanes. It is a busy but rather dirty town, deriving its importance and wealth almost entirely from the rich copper mines in its vicinity, the mines of the Parys Mountain. Copper-smelting is carried on in A., and contributes not a little to make the town unpleasant. A harbour has been formed by excavation out of the solid slate rock, at the expense of the mining companies, and is capable of receiving vessels of 600 tons burden. It is protected by a breakwater. A branch of the Chester and Holyhead Railway terminates at Amlwch. A. is associated with Beaumaris, Holyhead, and Llangefni, in returning one member to parliament. Pop. (1871) 2968.

AMOL, a town of Persia, in the province of Mazanderan, on the Heraz, a river which flows into the Caspian Sea; 76 miles north-east from Teheran. The town is unwall'd, but has good bazaars, and is a place of considerable prosperity and wealth. The river, which is powerful and rapid, is crossed by a bridge of twelve arches. Extensive ruins indicate the former importance of Amol. Its most notable building is the mausoleum of Seyed Quam-u-deen, king of Sari and Amol, who died in 1378. In the suburbs are a grand palace, which once belonged to Shah Abbas, and three towers, said to have been temples of the ancient Guebres, or fire-worshippers. The inhabitants of A. cultivate rice and cotton, or are employed in the iron forges and cannon-foundries of the district. The pop. in winter, when greatest, is estimated at 35,000 or 40,000; in summer, many of the inhabitants retire to summer residences in the mountains, which approach within about five or six miles of the town on the south.

AMPHIU'MA, a curious genus of *Batrachia*,

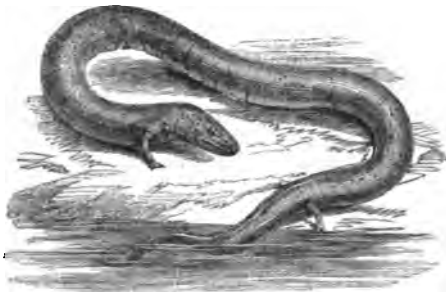

*Amphiuma means.*

having an eel-like form, a large head, thick and extensible lips, depressed and rounded snout; the

neck contracted, with a transverse fold at the throat; numerous small teeth on the maxillary and palate bones, a single spiracle on each side of the neck; four legs, all very small and two-toed. *A. means* is found in the southern and south-western parts of the United States. It attains a length of more than two feet, and is of a bluish-black colour. It lives in muddy water or in mud, burrowing like a worm in the ditches of rice-fields, and feeds on small fish, molluscs, and insects. It is regarded by the negroes as highly venomous, but there is no reason for the notion.

AMURNATH, a cave amidst the mountains which bound Cashmere on the north-east. It is a natural cave in a rock of gypsum, about 100 yards wide, 30 high, and 500 deep. It is believed by the Hindus to be the residence of the god Siva, and is therefore visited by multitudes of pilgrims. It is inhabited by vast numbers of doves, which fly out in alarm on the loud shouting of prayers by the pilgrims, and this is supposed to indicate the acceptance of their prayers.

AMYGDALIN ( $C_{20}H_{27}NO_{22}6HO$ ) is a crystalline principle existing in the kernel of bitter almonds, the leaves of the *Cerasus lauro-cerasus*, and various other plants, which, by distillation, yield hydrocyanic acid. It is obtained, by extraction with boiling alcohol, from the paste or cake of bitter almonds, which remains after the fixed oil has been separated by pressure. The alcoholic solution usually contains more or less oil, which must be removed by decantation or filtration; it must then be evaporated till a syrup is left, which must be diluted with water, mixed with yeast, and set aside to ferment, in order to get rid of any sugar that may be present: on now filtering and evaporating, the amygdalin crystallises in thin transparent needle-like prisms. It has a sweetish somewhat bitter taste, and is not poisonous, and when treated with alkaline solvents, ammonia is expelled, and amygdalic acid,  $HO.C_{10}H_7O_2$ , is produced. Its most remarkable change is, however, that which is noticed in the article ALMONDS, VOLATILE OIL OF, and which may be thus briefly stated. When the bruised almond kernel, or almond paste, is brought in contact with water, the peculiar odour of bitter almonds is almost immediately evolved; and in twenty-four hours, all traces of amygdalin will have disappeared, its place being taken by essential oil of almonds, hydrocyanic acid, sugar, and formic acid. This transformation is due to the presence of a peculiar nitrogenous matter called Emulsin (q. v.), or synaptase, which sets up a kind of fermentation. As the proportion of hydrocyanic acid which is liberated by the above reaction is fixed, Liebig and Wöhler recommend that amygdalin should be employed in preparing that acid for medicinal purposes. Amygdalin may be dissolved in water for any length of time without undergoing change; but if it be mixed with an emulsion of sweet almonds, immediate decomposition ensues. Seventeen grains of amygdalin, when dissolved in an ounce of emulsion of sweet almonds, furnish exactly one grain of pure hydrocyanic acid, which may be readily diluted to the strength of the Pharmacopœial acid.

A'MYL ( $C_{10}H_{11}$ ) is the fifth in the series of alcohol radicals whose general formula is  $C_nH_{2n-1}$ , and of which methyl and ethyl are the first two members. It is obtained by heating amyli-iodide with an amalgam of zinc in a closed tube at a temperature of about 350°, and is one of the natural products of the distillation of coal. It is a colourless liquid, with a spec. grav. of 32°, a boiling-point of 311°, and a somewhat aromatic odour, and it exerts a right-handed rotatory action on a ray of polarised light.

## ANAGNI—ANHYDRIDES.

It enters into a large number of chemical compounds, most of which—as, for instance, bromide, chloride, iodide, &c.—are derived from amylic alcohol, which bears precisely the same relation to amyl that ordinary alcohol bears to ethyl (C<sub>2</sub>H<sub>5</sub>). Amylic alcohol is sufficiently described in the article FUSZ. OIL, which is the name given to the crude alcohol. It seems invariably to accompany ordinary alcohol when the latter is prepared by fermentation, and apparently occurs in largest quantity in those liquids which remain most alkaline during fermentation.

**ANAGNI** (anc. *Anagnia*), a town of Central Italy, 37 miles east-south-east from Rome. It stands on a hill in the midst of a fertile district, and although an ill-built town, is the residence of many noble families. It is the seat of a bishop. There are some remains of ancient buildings. The ancient *Anagnia* was the chief city of the Hernici. It was a place of importance during the whole period of Roman history, and Virgil mentions it as the 'wealthy Anagnia.' Pop. 6000.

**ANCA'STE**, a town of the Argentine Republic, South America, in the province of Catamarca, 23 miles north-east from Catamarca. Pop. about 8000.

**ANDENNES**, a town of Belgium, in the province of Namur, 10 miles east from Namur, and nearly 2 miles south from the Maas. It has manufactures of paper, porcelain, and tobacco-pipes, for the last of which it is particularly famous. Cotton-spinning, bleaching, and other branches of industry are also prosecuted. There are beds of pipe-clay, quarries of marble, and lead, iron, and coal mines in the neighbourhood. Pop. (1870) about 6700.

**ANDERAB**, or **INDERAB**, a town in the Afghan portion of Turkestan, on the northern slope of the Hindu Kush Mountains, and on the right or northern bank of the Anderab or Inderab River, a branch of the Ghori or Kunduz, itself a branch of the Jihun, 80 miles south-south-east from Kunduz. It is surrounded by gardens, orchards, and vineyards. It is a principal entrepôt of commerce between Persia and India. Pop. supposed to be about 6500.

**ANDKHUY**, a town, formerly of Bokhara, but now of Afghanistan, Central Asia, about 200 miles south of Bokhara, on a river flowing north towards the Jihun, but only part of which has as yet been traced. It lies on the high road to Herat, and is much exposed to the attacks of the Emirs of Bokhara and Afghanistan. Down to the year 1840, it is said to have been tolerably flourishing. It was then subject to Bokhara, and was compelled to oppose the victorious march of Mohammed Khan, who besieged it during four months, and at last only took it by storm. The city was plundered, and left a heap of ruins. The sovereign, Gazanfer Khan, to preserve himself from utter destruction, threw himself into the arms of the Afghans. A. contained in 1863 about 2000 houses, which form the city, and about 3000 tents, which are either in the environs, or scattered over the oases in the desert. The pop. is estimated at 15,000, consisting principally of Turkomans, with a mixture of Uzbeqs and a few Tadjiks.—Vámbéry's *Travels in Central Asia*.

**A'NDRIA**, a city of South Italy, in the province of Bari, 31 miles west from the town of Bari. It stands on a plain, and in its vicinity are numerous caverns (*antra*), whence its name. Its cathedral, a fine edifice, was founded in 1046. During the wars of the Parthenopean Republic (q. v.), it was besieged by the republican army under General Broussier, and being taken after a gallant resistance, was burned, at the suggestion of Ettore Carafa, Count of Ruvo, himself its feudal lord. The neighbouring

country is famous for its almonds, which are a principal article of trade of the city. Pop. (1872) 34,034.

**A'NDROS**, an island of the Greek Archipelago, the most northern of the Cyclades, separated from Eubœa by a channel, the Doro Channel, six miles broad. The island is 21 miles long, and about 8 miles in its greatest breadth. Its eastern coast is very irregular. It is very mountainous, and on some of its mountains snow lies during great part of the year. The soil is very fertile, and wine, silk, wheat, barley, lemons, oranges, and pomegranates are produced. Silk is the chief article of export. The pop. is supposed to be about 16,000. The chief town, ANDROS, is situated on a bay of the eastern coast. It has manufactures of silk and carpets, and a large port, which, however, is suitable only for small vessels. Pop. 5000.

**ANDU'JAR**, a town of Andalusia, Spain, in the province of Jaen, 24 miles north-north-west from Jaen, on the right bank of the Guadalquivir, at the base of the Sierra Morena. Its streets are irregular, but many of the houses are well built. The river is crossed by an old dilapidated bridge. The situation of the town is unhealthy. The inhabitants are mostly employed in agriculture; but there is some trade in grain, fruit, oil, and cattle, the produce of the neighbouring country, and the town is famous for the manufacture of the porous cooling clay water-vessels which are in general use throughout Spain. The Convention of Baylen was signed here on 23d July 1808. Pop. 12,000.

**ANGEIOLEUCITIS**. See **ADENITIS**.

**ANGHIARI** (anc. *Castrum Angulare*), a town of Central Italy, in the province of Arezzo, Tuscany, 10 miles north-east from Arezzo, on the slope of a hill near the Sovara, one of the head-waters of the Tiber. In 1440, a battle was fought here, in which the Milanese were defeated by the Florentines. Pop. of commune, 6941.

**ANGORNOW**, or **NGO'RNU**, a town of Bornu, Central Africa, on the south-western bank of Lake Tchad, 15 miles south-east from Kukawa. The surrounding country is very level and monotonous, but fertile. The waters of Lake Tchad are usually some miles distant from the town, yet the whole intervening plain is sometimes covered with water, and the town itself is liable to destructive inundations. It is a place of considerable commercial importance; the principal articles of trade are slaves, cotton, amber, coral, and metals. The pop. is supposed to be about 30,000.

**A'NGRA**, the capital of the Azores, beautifully situated on the south coast of the island of Terceira. Its harbour is the best in the island, but is exposed to violent storms during certain months of the year. The principal exports are wine and grain. The town is strongly fortified. It is the seat of the Bishop of the Azores, and has a cathedral. The streets are broad, and have footpaths, and the houses are mostly of three stories. Pop. about 12,000.

**A'NGRI**, a town of South Italy, in the province of Salerno, and 17 miles north-west from Salerno, not far from the Naples and Nocera Railway. The surrounding country abounds in vineyards and cotton plantations. Pop. 6921.

**ANHYDRIDES** is the term now commonly given to the compounds formerly known as anhydrous acids, which was a very unsatisfactory name, seeing that these bodies do not present any of the ordinary properties of acids. In some cases, they are the result of the dehydration of acids, and in all cases they represent in their composition the acid *minus*

## ANHYDRIDES—ANILINE

water. One of the most eminent French chemists, Professor Wurtz, lays down the following general principles: (1) The anhydrides of monobasic acids (a) contain the elements of two molecules of a monobasic acid, *minus* one molecule (which corresponds with two atoms) of water; (2) the anhydrides of bibasic acids (b) contain the elements of a molecule of a bibasic acid, *minus* a molecule of water; (3), the anhydrides of tribasic acids (c) contain the elements of a tribasic acid, *minus* water. Thus, using the modern formulæ and the type theory, we give a case of each form of acid:

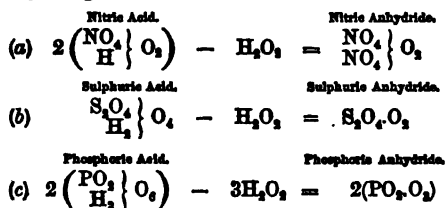

The reader who may not at once be able to interpret these formulæ, will readily see that  $\left( \begin{matrix} \text{NO}_4 \\ \text{H} \end{matrix} \right) \text{O}_2 = \text{NO}_2\text{HO}$ , the old formula for nitric acid, that  $\begin{matrix} \text{S}_2\text{O}_4 \\ \text{H}_2 \end{matrix} \left. \right\} \text{O}_4 = 2(\text{SO}_2\text{HO})$ , the old formula for sulphuric acid, which is now universally placed amongst the bibasic acids; and that  $\left( \begin{matrix} \text{PO}_3 \\ \text{H}_3 \end{matrix} \right) \text{O}_6 = \text{PO}_3\text{,}3\text{HO}$ , the old formula for tribasic phosphoric acid. According to the old system, the three anhydrides would be represented by  $\text{NO}_2$ ,  $\text{SO}_2$ , and  $\text{PO}_3$ , respectively. We might have taken organic acids, as, for example, acetic acid, succinic acid, in place of nitric and sulphuric.

The anhydrides of the monobasic acids are formed in various ways; thus, hypochlorous anhydride is formed by the action of chlorine on oxide of mercury; nitric anhydride is formed by the action of chlorine on nitrate of silver, &c. By the action of ammonia, the anhydrides of monobasic acids are converted into amides; thus, benzoic anhydride ( $\text{C}_6\text{H}_5\text{O}_2$ ) + ammonia ( $\text{NH}_3$ ) = benzamide ( $\text{O}_1\text{H}_7\text{NO}_2$ ) + water ( $\text{HO}$ ). The anhydrides of tribasic acids are often formed by the mere action of heat on the acids, as is the case with lactic and tartaric acids.

The anhydrides present no uniformity of appearance; for example, carbonic anhydride (commonly known as carbonic acid, which in reality is  $\text{CO}_2\text{,HO}$ ) is a gas; phosphoric anhydride is a white powder; nitric anhydride occurs in crystals; sulphuric anhydride is a ductile wax-like substance; while the anhydrides of the organic acids are oily bodies heavier than water.

The most important property of this class is their conversion into the corresponding acids, under the influence of water.

ANILINE is now universally regarded as, in a technological point of view, one of the most important organic compounds yet discovered (see DYE-STUFFS). Its chief physical and chemical characters are described under the head of *Phenyl* (q. v.), an organic radical, represented by  $\text{C}_6\text{H}_5$ , which, if aniline is (as Hofmann believes) a derivation of ammonia, replaces one of the atoms of hydro-

gen, yielding  $\left. \begin{matrix} \text{C}_6\text{H}_5 \\ \text{H} \end{matrix} \right\} \text{N}$ , or  $\text{C}_6\text{H}_7\text{N}$ , which is the

formula for this compound. There is one salt of aniline which requires notice, because its therapeutic value has been highly praised—viz., the sulphate of aniline, which is prepared by saturating a certain amount of aniline with dilute sulphuric acid,

evaporating to dryness, and extracting the residue with boiling alcohol, which, on cooling, leaves white silvery scales of sulphate of aniline. To obtain the salt quite pure, it may be dissolved and separated a second time, after which it must be preserved in well-stoppered bottles. The importance which the aniline manufacture as a dye-stuff has acquired during the last few years has led to the study of its physiological, therapeutical, and toxicological properties, and hence to the hygienic precautions which should be adopted in the chemical works devoted to its preparation, as well as to the influences which the aniline colours may exert on those who employ them in dress, &c.

The *physiological* action of aniline has been recently studied by nearly a dozen independent observers, and the following are the principal results at which they have arrived: (a) When administered internally in a moderate dose, this substance causes a considerable muscular excitement, lasting for some minutes, and then gradually disappearing. When given in a *poisonous* dose, it causes an immediate flow of viscid saliva, from which the animal tries to free itself by rubbing its mouth on the ground; in about ten minutes it becomes quiet and dull, and coldness supervenes, which continues and increases till death. The other most apparent symptoms are convulsive spasms, which first affect the hind legs, but soon extend to the anterior extremities. The eyelids are widely separated, while the pupils are somewhat contracted; and the tumultuous beating of the heart and the hurried respiratory movements shew that the convulsive state of the other muscles has extended to those which regulate the most important vital functions. From ten to fifteen drops of aniline will thus prove fatal to a rabbit or to a dog of medium size. In still larger doses the poison causes the animal's head to be convulsively drawn backwards, and death rapidly ensues. On examination after death, an odour of aniline is found to be given off by the blood, whose globules, when microscopically examined, are found to be partially disintegrated and deprived of their red pigment. (b) Its effects on animals, as well as those of nitrobenzine, from which it is produced, when *inhaled* in a state of vapour, have been carefully studied by M. Bergerow, whose experiments were so arranged as to imitate the conditions to which workmen are exposed in the aniline manufactories. As might be expected, the effects of aniline are slower and less marked than when the substance is introduced into the stomach, but are of the same character—the spinal cord and muscular system being more or less *excited*; while the vapour of nitrobenzine, which seems to act primarily on the brain, causes stupor. On the whole, the experiments tended to shew that aniline, notwithstanding the terrible spasmodic symptoms which it excites, is less serious in its consequences and more transient in its action than nitrobenzine. The phenomena observed in experiments on animals closely correspond with those which have been observed in cases in which man has been exposed to the noxious vapour. The following case recorded by Mr Knaggs seems well to illustrate the effects of inhaling a large dose of aniline vapour: A workman broke a carboy containing a large quantity of this liquid, which fell over him without entering his mouth. In trying to wipe up the aniline, he respired the vapour for some time, felt giddy, and complained of his head and chest. When seen some hours afterwards, his face and body were of a livid leaden blue; the lips, gums, tongue, and eyes of a corpse-like bluish pallor; he was breathing by gasping, and appeared at the point of death. There was then no convulsion, and he was quite sensible. His pulse was small and irregular.

## ANKLAM—ANSPACH.

Under very energetic treatment (alcohol, ammonia, chloric ether, internally, and cold affusions and sinapisms externally), he recovered. According to Dr Letheby, who has reported a similar case, the aniline undergoes changes in the blood similar to those which it undergoes in the formation of the dye-stuffs; and the mauve, magenta, &c., that are thus formed in the circulation, occasion the blue or violet colour which the gums and mucous membrane of the mouth present in these cases.

The symptoms observed in the various experiments on animals led several physicians to try its therapeutic action in diseases of the nervous system. Sulphate of aniline was the form selected, and chorea the disease on which it was especially tried, although it has also been administered in epilepsy and other nervous diseases. The results are contradictory; and till further evidence of its value is adduced, it is not likely to supplant other medicines of the same class.

The workmen employed in the fabrication of nitro-benzine and aniline (for the two are prepared in the same works) suffer, for the first day or two after commencing this occupation, from severe supra-orbital headache, frequently accompanied with nausea and vomiting. While some persons suffer so severely that they are compelled to seek another employment, most, after a fortnight's experience, cease to feel the ill effects, except accidentally, as after extra work or intense heat. Till they become seasoned, most suffer from vertigo, which rapidly disappears on exposure to a current of fresh air; and sometimes the vertigo is succeeded by loss of consciousness. Sometimes the face becomes congested, the patient staggers and falls to the ground in a semicomatose state like a drunken man; in the course of an hour or two he wakes up, suffering only a feeling of fatigue. In other cases, regular epileptiform convulsions of the limbs and tetanic spasms of the neck are observed, the patient often remaining in this state for an hour or more before recovery. Such may be regarded as the *acute* symptoms exhibited by new hands. Those who have become seasoned, complain of great general languor, a partial loss of sensation in the upper extremities, and constipation of the bowels; and they almost always present a decolorisation of the skin and mucous membranes, in consequence of the impoverished state of their blood, which is said to be rapidly restored by making the patient inhale oxygen gas or compressed air. In reference to the influence of the aniline colours on the health of those who use them, it may be remarked, that even if they were poisonous, they adhere so tenaciously to the stuffs that are dyed with them, that there is no fear of the detachment of a noxious powder, as in the case of the arsenical greens. But fortunately they seem perfectly harmless even when taken internally, according to Sonnenkelb, provided they are completely freed from the arsenic, lead, mercury, or other poisonous metal that has been employed in the oxidation of the aniline. Hence, when they are quite pure, fuchsine and the allied pigments may be safely employed in colouring sweetmeats, liqueurs, confectionery, ices, &c., which it is very satisfactory to know, seeing how largely they are at the present day employed.

**ANKLAM**, or **ANCLAM**, a town of Prussia, in the province of Pomerania, 44 miles north-west from Stettin, on the right bank of the Peene, and 4 miles from its mouth in the Kleine Haf. The river is navigable to A., which carries on a considerable commerce, and has long been a place of commercial importance, having been admitted into the Hanseatic League in 1319. It has manufactures of linens and woollens; it has also several breweries, soap-works,

and tanneries, and ship-building is actively prosecuted. During the middle ages, A. suffered more than almost any other town from fire and pestilence; and in the wars of the 17th and 18th centuries, it was again and again besieged and sacked. On the close of the Seven Years' War, in 1762, its fortifications were happily dismantled. It is still, however, surrounded by an old wall with three gates. It contains many interesting specimens of the Hanseatic or North German architecture, very like the Flemish. Pop. (1871) 10,739.

**ANNABERG**, a town of the kingdom of Saxony, in the district of Zwickau, on the right bank of the Sehm, 18 miles south from Chemnitz. It is situated 1800 feet above the level of the sea, in a mining district; the surrounding hills containing mines of silver, tin, cobalt, and iron. It has extensive manufactures of lace and of silk ribbons. The ribbon manufacture was introduced here by Protestant refugees from Belgium, who fled from the persecution carried on by the Duke of Alva. Pop. (1871) 11,693.

**ANNECY**, a town of the dep. of Haute Savoie, France, at the north-western extremity of the Lake of Annecy, and 21 miles south from Geneva. The Lake of Annecy is 1426 feet above the sea, and is surrounded by magnificent mountain scenery. It is about 9 miles long and 2 miles broad. Its waters flow by the Firan to the Rhone. In the 12th c. A. was called *Anneciacum novum*, to distinguish it from Old A., *Anneciacum vetus*, which occupied the slopes of a neighbouring hill, and was a place of some consequence in the times of the Romans. In the earlier part of the middle ages, A. belonged to the Counts of Geneva, and on the extinction of that House, it passed to the House of Savoy, in whose possession it remained, except for a brief period under the French Empire, until the transference of Savoy to France in 1860. It has manufactures of linens, cotton-yarn, glass, sulphuric acid, and steel-ware. Its linen bleachfields have subsisted since 1650. The town is clean, and has an air of respectable antiquity. The shops in many of the streets are under arcades. The most remarkable buildings are the château, once the residence of the family of Genevois-Nemours, the old bishop's palace, the cathedral, and the modern church of St Francis, the latter of which boasts of possessing the relics of St Francis of Sales and La Mère Chantal. Pop. (1872) 9097.

**ANNONAY** (anc. *Annoneum* or *Annoniacum*), a town of the dep. of Ardèche, France, at the junction of the Deaume with the Cance, which unite in the centre of the town, 37 miles south from Lyon. It is an active and prosperous manufacturing town, the chief manufacture being that of paper, of which 300,000 reams are produced annually. There are also manufactures of glove-leather, mostly from kid skins, and of silk and cotton twist, and woollen cloth. The paper-mills of A. were established by the father of the celebrated aeronauts, Montgolfier (q. v.), who were born here, and to whom there is a monument in the Grande Place. The situation of the town is picturesque and remarkable; the houses are placed among rocks, and some of the streets are very steep. A large quantity of silk is produced in the neighbourhood. Pop. (1872) 15,052.

**ANSPACH**, or, more properly, **ANSBACH**, a town of Bavaria, the capital of the circle of Middle Franconia (*Mittel-Franken*), on the Rezat, 25 miles south-west from Nürnberg. It has manufactures of cotton and half-silken fabrics, tobacco, earthenware, playing-cards, cutlery, and white lead; also a considerable trade in wool, flax, and corn. The situation is pleasant, but there are no remarkable buildings.

except the deserted palace of the former margraves of A., surrounded by gardens, and the church of St Gunibert, said to occupy the site of a church erected in the 8th c., around which the town grew. The margraves of A. were a branch of the family of Hohenzollern. The last of them sold his possessions in 1791 to Prussia; and in 1806, Napoleon I. transferred A. to Bavaria. Pop. (1871) 12,635.

**ANTACIDS** are medicines which correct abnormal acidity of the stomach and intestinal canal by directly combining with the free acid that may be present. Their action is obviously merely temporary, as, unless combined with other medicines, they do not correct the morbid condition which causes the undue acidity; and their too prolonged use must be carefully avoided, since, at all events, some of these medicines, as the alkalis and their carbonates, are liable to induce a state of general anemia, morbid deposits in the urine, and a series of symptoms not unlike those of scurvy. Antacids are best given in association with vegetable tonics; and for the reasons already stated, their administration must be carefully watched, and should be occasionally omitted. Dr Neligan makes the following excellent remarks on the particular remedy to be employed for special forms of acidity: 'When the acid exists in the stomach in the gaseous state, ammonia or its carbonates should be preferred, as, in consequence of their volatility, a gaseous acid which would elude the action of the fixed alkalis, may be neutralised by them. If the acidity be present in the lower bowel, as in the cæcum or colon, magnesia or lime ought to be administered, as being less likely than the other antacids to be neutralised or absorbed before it reaches that portion of the intestinal canal. When the acid exists in the urinary organs, the alkalis will be found best adapted, as they have a tendency to act more directly on the kidneys; and when it is *lithic* (or *uric*) acid which preponderates in the urine, the preparations of lithia or potash should be preferred to those of soda, as the salts formed by the two former with the acid in question are much more soluble than those formed with the latter. In persons of a corpulent habit of body, potash is to be preferred to ammonia or soda when the use of an alkali is indicated. And finally, ammonia and its preparations are best adapted for the old and debilitated, as also for those of enfeebled constitution.' The antacids include solutions of ammonia, lime (commonly known as lime-water), potash, and soda, various carbonates of these substances, magnesia and its carbonates, and the carbonate and citrate of lithia.

Many of the medicines of this class possess other properties besides that of neutralising free acids; but a notice of such properties does not fall within the scope of the present article.

**ANTISPASMODICS.** See **SPASM.**

**ANUPSHUHUR**, a town of India, in the British district of Bolundshuhur, North-west Provinces, on the right bank of the Ganges, 73 miles east from Delhi, on the route to Bareilly. The channel of the Ganges is here about a mile wide, but only about one-fifth of that space is occupied by the stream in the dry season. The town is ill built and crowded, the houses either of mud or ill-cemented brick. Pop. (1871) 10,644.

**A'NUS, THE, AND ITS DISEASES.** The term *anus* is applied by anatomists to the lower or (in the case of animals) the posterior aperture of the intestinal canal; the rectum terminating externally in the anus. With regard to its anatomy, it is sufficient to state that it is kept firmly closed on ordinary occasions by the *external* and *internal sphincter*

muscles, the former of which contracts the integument around the opening, and, by its attachment to the coccyx behind, and to a tendinous centre in front, helps the *levator ani* muscle in supporting the aperture during the expulsive efforts that are made in the passage of the feces or intestinal evacuations; while the latter or *internal sphincter*, is an aggregation of the circular muscular fibres of the lowest part of the rectum, and acts in contracting the extremity of the tube. The main function of the *levator ani* muscle is expressed in its name, it being the antagonist of the diaphragm and other muscles which act in the expulsion of the feces. The integument around the anus lies in radiating plaits, which allow of its stretching without pain during the passage of the feces; and the margin is provided with a number of sebaceous glands, which, in some of the lower animals, secrete strongly odorous matters. See **ANAL GLANDS.** Infants are occasionally born with an imperforate *anus*, or congenital closure of the rectum. In the simplest form of this affection, the anus is merely closed by thin skin, which soon becomes distended with the Meconium (q. v.). More complicated cases are those (1) in which the gut terminates some distance above the seat of the anus in a blind sac or pouch; (2) where the rectum terminates in the bladder, &c. Fortunately, the closure by a layer of skin is far the most common form of imperforate anus, and the little patient is at once relieved by a very simple surgical operation. If, however, no treatment be adopted, which is too often the case, in consequence of a popular delusion that the affection is incurable, the abdomen becomes distended and hard, vomiting comes on, the vomited matters soon assume a fecal smell, and the infant dies in a few days, either from exhaustion or rupture of the intestines.

*Spasm of the Sphincter Ani* is by no means a rare affection; it is characterised by violent pain of the anus, with difficulty in passing the feces. On attempting an examination, the muscle feels hard, and resists the introduction of the finger. It usually occurs in sudden paroxysms, which soon go off; but sometimes it is of a more persistent character. Its causes are not clearly known, and although most surgeons regard it as a special affection, some consider that the spasm is not a disease in itself, but merely a symptom of some slight excoriation or ulceration. Suppositories containing opium or belladonna introduced during the period of relaxation, are sometimes of use; and if there are ulcers, they must be specially treated. *Ulceration* occurring as a breach of surface at one or more points around the anus, but not extending within the orifice, is by no means uncommon in persons who are not attentive to cleanliness, and especially in women with vaginal discharges. Strict attention to cleanliness, the patient being directed to apply warm water to the parts at least twice daily with a sponge (which after each operation should be carefully rinsed out), and one or two applications of the solid nitrate of silver, followed by black-wash, will effect a speedy cure. If the ulcer is seated partly *without* the anus and partly *within* the rectum, the distress is much more severe, and the treatment often requires the use of the knife. *Fissure of the anus* is a term applied to an affection consisting in one or more cracks, excoriations, or superficial ulcerations, situated between the folds of the skin and mucous membrane at the verge of the anus, and only slightly involving the rectum. They give rise to intense pain during the passage of the evacuations, and for some hours afterwards to great discomfort, smarting, and itching. The treatment to be adopted is to endeavour to procure regular and somewhat soft evacuations, and to sponge with warm water

immediately afterwards, the parts being dried with a soft cloth. One or two applications of solid nitrate of silver will sometimes cure the disease; and an ointment of oxide of zinc, or one containing chloroform, will sometimes serve to allay the irritation and heal the parts.—*Pruritus ani*, which simply means intense itching and irritation of this part, is perhaps rather to be regarded as a symptom of certain morbid changes rather than as a special disorder; but as it is a very common affection, and is productive of much suffering, it must not be passed over. It is often associated with an unhealthy state of the intestinal secretions, or with simple constipation; with a congested state of the mucous membrane; with a disordered condition of the womb; with the presence of thread-worms in the rectum, &c.; and it is peculiarly common in persons whose occupations are sedentary. The affection is often much aggravated by the patient's being unable to refrain from scratching the parts, which leads to excoriations, ulcerations, thickening of the skin, &c. The symptoms are usually most severe when the sufferer begins to get warm in bed. If the affection arise from worms, or a loaded state of the large intestines, enemata and purgatives will give immediate relief. If unhealthy excretions exist, attention must be paid to the diet, and the occasional administration of a pill containing a grain of calomel and four grains of watery extract of aloes, together with the local application of soap and water to the parts, will often stop the itching. If there are any cracks or ulcers, nitrate of silver must be applied until they heal. To prevent the reappearance of these sores, the patient should bathe the parts night and morning with a strong solution of alum. An ointment composed of a drachm of calomel and an ounce of lard is strongly recommended by Mr Smith of King's College Hospital, when other means have failed; who also states that the daily introduction of a well-oiled bougie, made of black wax, will sometimes succeed in very obstinate cases. The other principal affections of the anus are *Fistula*, *Piles*, and *Prolapsus*, which are discussed in special articles.

AONLAGANJ, or AOUNLAH, a town of India, in the British district of Bareilly, 21 miles south-west from Bareilly, on the route to Allypurrh. It has a large bazaar. Pop. (1871) 9947.

APATHIN, a town of Hungary, in the county of Bacs, near the left bank of the Danube, 49 miles south-west from Theresiopol. It has manufactures of woollen cloth, and a considerable trade in hemp, silk, madder, and woad, the products of the vicinity. Pop. (1869) 11,047.

A'PELDORN, a beautiful village in the Netherlands province of Gelderland, is situated about 17 miles north from Arnhem, on a canal which joins the river Griff, a branch of the Yssel, by which, and the public roads from Arnhem and Utrecht to Deventer and Zutphen, and by railway, it has much traffic. The Loo, a hunting-lodge of the king, is in the neighbourhood. The principal industries are agriculture, making paper, grinding corn, founding copper, manufacturing blankets and coarse woollen cloth, &c. Pop. of A., (1st Jan. 1875) 13,340.

APHASIA (Gr. *a*, not, and *phasia*, speech) is a term adopted by the eminent French physician, Trousseau, to denote a remarkable symptom of certain conditions of the nervous system in which the patient is more or less unable to express his thoughts in speech. The disease has been casually noticed by many earlier observers, amongst whom Dr Parry of Bath may be especially noticed; but it was not until within the last twenty years that it has received the attention which its great singularity

demands. Before receiving its present name, it had been termed *Aphemia* (from *a*, not, and *phemi*, I speak), and *Alatia* (from *laleo*, I talk). Voisin, in an elaborate Memoir on this subject, published in 1865, observes that it may be due to several causes. It may be congenital or acquired, and in the latter case is due to some form of lesion or injury of the anterior lobes of the brain. This fact was observed as long ago as 1825 by Bouillaud; but in 1861, during a discussion of the Anthropological Society of Paris, as to whether certain faculties, such as language, are or are not localized in special parts of the brain, Broca advanced the view, that the faculty of language has its seat not only in the anterior lobes, but in the left lobe, and occupies exactly the external left frontal convolution, where the anterior lobe meets the middle lobe immediately in front of the fissure of Sylvius. This singular conclusion was deduced from only two post-mortem examinations which had just occurred at the Bicêtre, but a number of previously published cases supported it; and Dr Hughlings Jackson, of the London Hospital, 'has seen about seventy cases of loss or defect of speech with hemiplegia, and in all but one, the hemiplegia was on the right side, indicating disease of the left side of the brain.'—*Lancet*, Nov. 26, 1864. Moreover, in the two cases which during the year last named proved fatal in the Edinburgh and Glasgow Infirmeries, Dr Sanders and Dr Gairdner traced the disease to the exact spot described by Broca. It may be caused by wounds, tumours of various kinds, including hydatids, or by softening of the left anterior lobe, and has occasionally, but very rarely, been found in association with lesions of other parts of the cerebrum, and even of the cerebellum and spinal cord. According to Voisin, in 146 cases, the left anterior lobe was affected in 140, and the right in only 6 cases. A variety of aphasia has been noticed in typhoid fever and in the first stage of small-pox; also in certain chronic cachexias or intoxications, as, for example, in syphilis and chronic alcoholism; and there are cases in which the affection is purely nervous, and results from epilepsy, an over-taxed brain, &c. The patients in whom true aphasia from disease of the brain occurs, are excellently described by Dr Gairdner in his essay *On the Functions of Articulate Speech*, &c. (Glasgow, 1868). This description, in a condensed form, is as follows: These patients have been the subject of some form of disturbance of the cerebral functions, sometimes with, but sometimes also without a manifest disturbance of the intellect. It may have been epilepsy or apoplexy, in which latter case, as has been already noticed, there is often paralysis, almost invariably on the right side of the body. This paralysis may be of any extent of completeness, but in many cases the patient has such command over the movements of the tongue and lips, as to shew that it is not from paralysis his speech is affected. The states of intellect and consciousness are equally variable, the patient occasionally appearing and behaving as if he were in perfect bodily and mental health, except for the aphasia. Moreover, the aphasia itself shews itself in the most varied forms. In the more trivial cases, it is little more than an aggravation of the common defect of forgetting, or being unable to recall the name of a person or thing when wanted. Dr Gairdner records the case of what he calls 'an aphasic,' who could conduct an ordinary conversation pretty well, but who could not name the days of the week, and would, for instance, call Monday 'the first working-day,' and who had forgotten, or could not give utterance to his own name. Sometimes a patient will perfectly articulate such expressions as these: 'I want —, I want — Where's the' —, almost always stopping short at the name

of the object. Sometimes the patient's vocabulary is limited to one or two common words, as 'Yes' or 'No'; or perhaps he utters only one or more unintelligible words, as in the case of one of Trousseau's patients, who for four months uttered nothing but 'Cousin' to every possible question, unless when in moments of great irritation, and he would then articulate 'Sacon, sacon'—probably an abbreviation for a French oath. Strange to say, certain aphasics who can articulate absolutely nothing else, can swear with perfect facility. Such exclamations as 'Oh!' 'Dear me!' 'God bless my life!' and 'D—n it!' are often the only utterances of these patients. Dr H. Jackson, in a Memoir on Aphasia, in the first volume of the *London Hospital Reports*, has made some excellent remarks on this peculiarity, which are well worthy of perusal by all who study mental philosophy. He ingeniously regards an oath not as a part of language, but as 'a sort of detonating comma.' The general reader may also read with advantage the histories of two cases recorded by Trousseau, in which Frenchmen of high mental capacity, and well acquainted with the disease (one of them an eminent physician in Paris, who had specially studied the diseases of the brain; and the other, Professor Lordat of Montpellier), have passed through attacks of aphasia, have recovered, and have described their own cases.

Aphasia may be either temporary or persistent; in the former case, being due to loss of nervous energy, congestion, or some other functional disorder; while in the latter case, it is probably associated with disease of structure. It is unnecessary to describe the treatment, which varies according to the peculiarity of each individual case, and must be left solely in the hands of the physician.

APHONIA (Gr. *a*, not, and *phos*, voice) is the term used in Medicine to signify a more or less complete loss of voice. It is altogether distinct from mutism, in which it is impossible to form articulate sounds, and in most cases the voice is not entirely gone, but only more or less lost or suppressed. The voice is essentially produced (as has been proved in the special article on that subject) by three distinct agents—viz., (1) the expiration of air, (2) the opening of the glottis, and (3) the tension of the vocal cords—and hence anything interfering with expiration, or with the functions of the glottis and vocal cords, may cause aphonia. Thus, it may result from paralysis of the respiratory muscles, from pulmonary emphysema, and sometimes from pneumonia; or it may be caused by diseases of the larynx, as chronic laryngitis, oedema of the glottis, polypus, &c.; or by pressure on the larynx caused by abscesses, vegetations, and any kind of morbid growth; or it may be traced to some functional or organic disturbance of the inferior vocal cords. Thus, the muscular fibres which act on these cords may become affected in acute laryngitis by extension of the inflammation, or their action may be impeded by the pressure of false membrane in croup. In typhoid fever, the aphonia which is so commonly observed is due to ulceration extending to these structures. Again, in cases of lead or phosphorus poisoning, there is aphonia due to fatty degeneration of these muscles. Not unfrequently, aphonia may be traced to compression of the recurrent or inferior laryngeal nerve, which is the nerve supplying motor power to all the muscles of the larynx, with one trifling exception.

Such pressure is not unfrequently caused by an aneurism, an abscess, tumour, &c. In the same way, a wound or contusion of the pneumogastric nerve, or one of the recurrent branches, will cause aphonia, or, more commonly, an extremely hoarse modification of the voice, in consequence of the laryngeal

muscles being paralysed on one-side, and remaining active on the other. There are cases of direct nervous action being interfered with; but there are many cases of what may be termed *reflex aphonia*, as when the voice is often more or less lost in the course of pregnancy when accompanied with convulsions, or in consequence of the presence of intestinal worms, or after the rapid suppression of an exanthematous rash, or of a long-continued hemorrhagic discharge. Aphonia is, moreover, very commonly associated with hysteria.

When aphonia is not due to irremovable causes, as tumours pressing on the recurrent nerve, fatty degeneration of the laryngeal muscles, &c., it generally disappears after a longer or shorter interval. It occasionally assumes remarkable intermittent shapes. In one instance, the affection came on regularly at the same time of the year for seventeen years, beginning daily at noon, and lasting the remainder of the day, for a period varying from three to seven months. Another case is recorded in which, during fourteen years, a young woman could only speak during two or three hours daily.

In those cases which are amenable to treatment, emetics, electricity, strychnine, leeching, blistering, croton-oil liniment, and internal application of nitrate of silver, have been found to be the most useful remedies.

APO/LDA, a town of the grand duchy of Saxe-Weimar-Eisenach, Germany, on the Werlitz, a feeder of the Saale, eight miles north-east from Weimar. It is a station on the Thuringian Railway, between Weimar and Weissenfels. It is a place of much industrial activity, having extensive manufactures of hosiery. Pop. (1871) 10,507.

ARABGIR, or ARABKIR (anc. *Anabrace*), a town of Asiatic Turkey, in the vilayet of Sivas, in a mountainous and rocky district, not far from the Euphrates, and 150 miles south-south-west from Trebizond. It contains a pop. of about 30,000, nearly one-fourth being Armenians, the other three-fourths Turks. It is to the enterprise and industry of the Armenians that the town owes its prosperity. It is specially noted for the manufacture of goods from English cotton yarn. The neighbouring country is inhabited by Turcomans.

ARAGONA, a town of Sicily, 8 miles north-north-east from Girgenti. It is a poor town, and stands in the midst of bare green downs; but the hills above it are clothed with pines, cypresses, olives, almonds, and carobs. The only object of interest is the old castle of the princes of Aragona, a huge building, in the Renaissance style, which has fallen much into decay. Pop. 7947.

ARAVU'LLI, a range of mountains in Western India, extending from about 22° 40' N. lat., 74° E. long., to 26° 50' N. lat., 75° E. long. The highest summit is Abu (q. v.). The north-eastern extremity of the range sinks into comparatively low rocky hills. The north-western side is very bold and precipitous, the south-eastern less so. There is no road practicable for wheel-carriages across this range for a distance of 220 miles.

A'ROÈ (anc. *Arz*), a town of South Italy, in the province of Caserta, 60 miles east-south-east from Rome. It is situated on a hill near the Liris; and the summit of the hill, which is lofty and precipitous, is crowned by an interesting mediæval fortress called *Rocca d'Arce*. This fortress was considered impregnable till it was scaled and taken by the invading army of Charles of Anjou in 1266. Numerous inscriptions in which the name of Cicero occurs have been discovered near A.; and some

ruins near the town are known as *L'aja di Cicero*, or Cicero's Barn. Pop. of commune, 5467.

**ARCIDO'SSO**, a town of Central Italy, in the province of Grosseto, 23 miles north-east from Grosseto, on a feeder of the Umbrona, among the Apennines. Pop. of commune, 5859.

**ARCUS SENI'LIS**, a not very well chosen term for a change occurring in the cornea of the eye, in consequence of fatty degeneration of its marginal part. The term is objectionable, because the change usually commences before the advent of old age, and further, because the *arcus*, or arch, is usually converted into a complete circle by the time that the patient has reached the age of sixty or seventy years. The *arcus senilis* usually commences at or even before the age of forty years, as an opaque whitish crescent, skirting either the upper or lower margin of the cornea; and from this commencement it extends along the edge, till it finally becomes a complete circle, which sometimes assumes a chalky whiteness, and gives to the eye a very peculiar appearance. On careful examination, it may be seen that a narrow interval of partially clear cornea always intervenes between the arcus and the opaque sclerotic. As far as the eye is concerned, the formation of this circle is of little importance, but it is of great diagnostic value to the physician if, as Mr Canton and several late observers maintain, its presence indicates the coexistence of fatty degeneration of the heart.

**ARDOYE**, a town of Belgium, in the province of West Flanders, 17 m. S. from Bruges. Linen-bleaching is the principal branch of industry. Brewing and candle-making are also carried on. Pop. (including the commune, which is not large), 6500.

**ARECIBO**, a town of Puerto Rico, Spanish West Indies, on the north coast of the island. It is the chief town of a province of the same name. It has a considerable trade. Pop. 11,187.

**ARGENTA**, a town of Central Italy, in the province of Ferrara, and 18 miles south-east from Ferrara, on the Reno, in the plain near the Marshes of Comacchio. Pop. of commune, 15,926.

**ARL'ANO** (*Arianum*), a city of South Italy, in the province of Avellino, beautifully situated 2800 feet above the sea, in one of the most frequented passes of the Apennines, 50 m. N.-E. from Naples. It is a bishop's seat, and has a fine cathedral. The chief manufacture is earthenware. There is a considerable export trade in wine and in butter. A. is said to have been founded by Diomed. Roger II. held a parliament here to settle the affairs of the province, after his defeat of the allied armies of Pope Innocent II. and the Prince of Capua. In the face of the hill on which the city is built, hundreds of caves have been dug, in which many of the poorer inhabitants dwell. Pop. 12,583.

**ARIZONA**, a territory of the United States, lying between 31° 20' and 37° N. lat., and 109° and 115° W. long. It is bounded N. by Nevada and Utah, E. by New Mexico, S. by Mexico, W. by California. Area, 113,916 sq. m. The surface consists of elevated table-lands intersected by mountains and interspersed with valleys. Grazing lands cover three-fourths of the territory, but its chief wealth lies in its mineral resources. Pop. (1870) 9658; capital, Prescott. A., formerly a part of New Mexico, was organized as a separate territory in 1863.

**ARLON** (anc. *Orolanum*), a town of Belgium, the capital of the province of Luxemburg, 24 m. W.N.W. from Luxemburg. It is a neat and prosperous town, and has a considerable trade in corn, woollen stuffs, leather, iron, &c. It has frequently suffered the ravages of war. The French pillaged it in 1793,

after a victory won in its neighbourhood over the Austrians. Pop. (1870) about 5800.

**ARMENTIÈRES**, a town of the dep. of Nord, France, on the Lys, 8 m. from Lilla. The town is well built, and is active and prosperous, having manufactures of cotton, linen, and hamp, and a considerable trade in grain. A. was formerly famous for its cloth, cheese, and bricks. Pop. (1872) 17,831.

**ARMOUR-PLATES**. The employment of thick slabs of iron to protect the sides of ships of war and the fronts of fortifications, is quite a recent invention; or rather, the modern system is the practical realization of plans suggested long ago by Merenne and others. In 1842, Mr Balmano of New York proposed that war-ships should be clad with several thicknesses of iron plate, riveted one upon another, the plates being individually  $\frac{3}{4}$ th inch thick. Soon afterwards, Mr Stevens, an American shipbuilder, made further suggestions on the same subject, and other practical men kept the matter before the attention of the authorities in various countries. In 1854, the French sent several floating-batteries to the Black Sea, clad with iron plates; and the English Admiralty hastily imitated this example, producing eight very slow and unmanageable batteries in 1855—1856. Then came in a flood of suggestions for arming our regular ships of war in a similar way. The Admiralty, dismayed at the thought of dismantling the existing fleet, which had cost so much, delayed the subject as long as they could, but without abandoning it. In 1860, the French sent to sea *La Gloire*, a timber-built ship of war, altered from a 90-gun three-decker to a 40-gun corvette, clad with  $\frac{4}{4}$ -inch iron plates, having a burden of 3000 tons. This proceeding at once set the English government on the alert; they saw that further delay would be imprudent, and they set about the creation of an armour-clad navy. Many problems had to be solved—whether to case old wooden ships with armour; to build and case new wooden ships; or to build new vessels, of which the hull as well as the armour should be of iron. Then arose further problems—how near the bulwarks should the armour-plates come, how near the bottom of the vessel, how near the stem and stern; also, what thickness of iron, and whether the same thickness in every part.

From 1861 to 1876, the British Admiralty were engaged on a series of costly constructions and reconstructions, intended to afford eventually solutions to the above problems. Several of the ships built have cost from £300,000 to £450,000 each; several half-finished timber three-deckers have been cut down and converted into iron-clads; and variations of detail almost innumerable have been introduced. The following is a list of English vessels which in 1876 formed the iron-clad navy. Those which are wholly clad—i.e., covered with armour-plates in all parts of the hull needing protection—are the *Minotaur*, *Agincourt*, *Northumberland*, *Royal Oak*, *Prince Consort*, *Caledonia*, *Ocean*, *Lord Clyde*, *Lord Warden*, *Audacious*, *Invincible*, *Prince Albert*, *Scorpion*, *Wyvern*, *Monarch*, *Iron Duke*, *Sultan*, *Glatton*, *Cyclops*, *Hecate*, *Hydra*, *Gorgon*, *Dreadnought*, *Devastation*, *Thunderer*, *Suffolk*, *Triumph*, *Rupert*, *Hotspur*, *Hercules*, *Infantile*, *Alexander*, and *Shannon*. Those which are partially clad—i.e., covered with armour-plates only in the more exposed portions—comprise the *Black Prince*, *Warrior*, *Defence*, *Resistance*, *Achilles*, *Hector*, *Valiant*, *Royal Alfred*, *Bellerophon*, *Zealous*, *Pallas*, *Favourite*, *Research*, *Enterprise*, *Viper*, *Vixen*, *Waterwitch*, *Penelope*. Regarded as to the material of which the hulls are mostly built, and on which the armour-plates are laid, the following are timber-built: *Royal Oak*, *Prince Consort*, *Caledonia*, *Ocean*,



## ARMOUR-PLATES.

*Royal Alfred, Zealous, Lord Clyde, Lord Warden, Pallas, Favourite, Research, and Enterprise.* The *Vizen* is wood and iron; the *Swiftsure* and *Triumph* are iron sheathed with wood; all the rest are iron. The dimensions and weight of these ships, laden with armour-plates from 3 to 24 inches thick, are enormous. The load displacement of five of them exceeds 10,000 tons each; six, 9000 to 10,000; four, 7000 to 9000; twelve, 6000 to 7000; seven, 4000 to 6000. Some of the steam-engines for these ponderous ships, nominally of 1200 horse-power, work up to (indicated) 8000 h. p. Whatever the thickness of the armour, the plates are nicely tongued and grooved to fit closely together edgewise. The bolts which fasten them to the ship are generally 2 to 2½ inches thick, expanded at one end to form a head, and having a screw-thread at the other to receive a nut.

It is not yet known whether the thickest armour will resist any shot that can be hurled against it; whether, in other words, the thickest practicable armour will overcome, or be overcome by, the heaviest practicable shot. Experiments at enormous cost have been conducted by the government for some years to determine this important question: a natural result has been that cannon are made larger and larger, and armour-plates thicker and thicker, in the struggle between artillery and ship-building. The experiments (so far as England is concerned) have been conducted principally at Shoeburyness, but also on board the *Thunderer* at Portsmouth. The usual mode is, to construct a target resembling the armed side of one of our iron-clads, and then to try to pierce it with shot fired from guns at various distances. A *Warrior* target, for instance, consists of a 4½-inch armour-plate, backed by 18 inches of teak, and an inner skin of ¼-inch iron; while a

steel shell, Armstrong's conical shell, and Palliser's chilled-iron shell were fired at it from a 7-inch gun at 200 yards: the Palliser shot excelled the others, going clean through the target, armour and all, and bursting behind. On another occasion, a Palliser 115-lb. shot went through the target even at an angle of 30° from the perpendicular. The *Lord Warden* target has been pierced by 9½ and 10 inch shot at



Fig. 3.—Section of do., showing the hole made by the 600-lb. shell, and displacement of the upper plate. a, armour plating, 4½ in. thick (displaced); b, teak backing, 18 in. thick; c, boiler-plate skin, ¾ in. thick; d, wrought-iron beams; e, platform.

a distance of 1000 yards; while the thinner *Warrior* target was pierced at 2000 yards. The *Bellerophon* target is more ponderous than the *Warrior*, having 6-inch armour, 22 inches of teak backing, and 1 inch iron plate behind all. Still more ponderous is the *Hercules* target, with 9-inch armour. Some of the targets tried do not resemble the sides of any particular ships, but have the armour-plate backed up by some peculiar combination of wood and iron which seems to the inventor advantageous. One of these, invented by Mr Chalmers, has attracted much attention by its power of resisting shot and shell. As nearly half in number of our iron-clads are weaker than the *Warrior*, and as the *Warrior* target has been repeatedly pierced through and through by the Palliser 115-lb. chilled shell, the future value of those ships in warfare is an anxious problem.

Armour-clad forts are also attracting attention. Iron has been used largely in the defences of Plymouth and Portsmouth. In 1864, a line of iron-clad fort was built up at Shoeburyness, to test several modes of construction. In the same year, the Russian government employed the Millwall Company to build a wrought-iron shield, as an experiment for the defences at Cronstadt. The front was made of 12 inches thick of iron in horizontal bars; this was backed by 14 inches of thickness in upright bars; and the whole strengthened with enormous struts, brackets, ribs, and dovetails of iron. The shield was to form the facing or armour for a battery of three of Krupp's 600-pounder steel guns, and measured 43 feet by 10. The shield, with its foundation-plate, weighed 140 tons. In one experiment at Shoebury, a plate 13 inches thick was placed in front of a mass of granite 14 feet thick, and fired at with 200-pounders: four shots cracked the granite, although the plate was not pierced. The Americans made an experiment in Chesapeake Bay, in September 1866, on a temporary fortification, made of enormous granite blocks faced with 10-inch armour: shots of 430 and 620 lbs. were fired from Rodman guns, at a range of 350 yards, and eleven such shots destroyed the whole fabric. The *Thunderer* has been fitted up as a target-ship at Portsmouth, partly to test very thick plates at very short distances. The plates are fastened to an enormous bulkhead near one end of the ship, and the guns placed near the other end. On one special occasion, a Palliser 115-lb. chilled shot, with an extra charge of powder fired at 25 feet off, went clean through a 7-inch plate and 45 inches

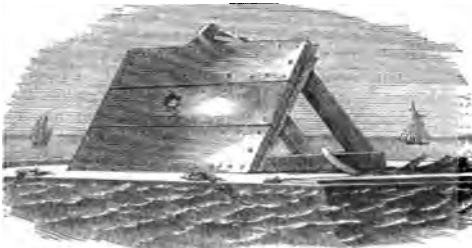

Fig. 1.—Front View of *Warrior* Target, after practice with 600-pounder Armstrong Gun.

*Lord Warden* target has 4½ inches plate, 30 inches teak, and 1½ inch skin. A few examples will serve to illustrate the method of proceeding.



Fig. 2.—Back View of do.

In August 1866, a *Warrior* target was built up at Shoeburyness—i.e., a target similar in strength and construction to the side of that ship. Alderson's

of teak bulkhead. On another occasion, soon afterwards, a *Hercules* target, with a 9-inch plate, was fired at with an 8-inch spherical shot at 30 feet; the shot made a dent 2½ inches deep, but did not further disturb the plate. The 24-inch armour of the *Infexible* is divided into two 12-inch plates, with 9 inches of teak between—the theory of this arrangement being that the outer plate, even if pierced, will shatter the shot, which will then be stopped by the inner armour. Dr Collis Brown has suggested a system of sloping armoured sides which would give a ship armour of 36 inches at any given point in a displacement not exceeding that of existing iron-clads. In the trial of the 100-ton Armstrong gun at Spezzia, a steel armour plate was fired at, and the shot, though it penetrated the plate, was stopped in the backing.

Regarded as articles of manufacture, armour-plates were at first produced mainly by hammering, several thicknesses of iron being welded one upon another, at a white heat, by blows of a ponderous steam-hammer; but it is now more customary to produce them by rolling than by hammering—pressure being considered to produce more satisfactory results than percussion. Whatever the thickness of the slab is to be, operations are commenced with plates about an inch thick: these are heated, rolled, cut, piled up, heated and rolled over and over again, until the required thickness is produced. The rollers are placed further and further apart, as the slab becomes thicker and thicker. Some of them are truly enormous masses of metal, solid cylinders 8 feet long by 32 inches diameter. At the Atlas Works of Messrs Brown & Co., Sheffield (the chief manufactory for armour-plates), there has been produced a rolled slab 17 feet long, 7 feet wide, and 14 inches thick, weighing 30 tons. At Grützer, in Germany, some excellent armour-plates of chilled (cast) iron have been manufactured. For armour-plates, the metal is very scrupulously selected, and every part of the processes conducted with great caution.

**AROKSZALLA'S**, a town of Jazygia, Hungary, 44 miles north-east from Pesth, and an entrepôt for the trade between that city and Upper Hungary. It stands in a plain on the Gyöngöy's Patak, a small stream, by which it is almost encircled. The surrounding country is fertile, and affords excellent pastura. Pop. (1869) 8170.

**AROMATICS** constitute a class of medicines, which owe their properties to the essential oils, to benzoic and cinnamic acids, to volatile products of distillation, or to odorous glandular secretions. The plants that contribute to this class of medicines are those which yield essences, camphor, or odorous resins, and amongst the families which yield the most important aromatics are the Labiate, Umbellifera, Lauraceæ, Myrtaceæ, Aurantiaceæ, Conifera, Scitamineæ, Orchideæ, &c. In some cases, the aromatic matter is diffused throughout all parts of the plant, but it is usually condensed in particular organs, such as the root, in the case of ginger and galanga; or the bark, in the case of cinnamon, canella, and cascarella; or the flowers, as in the case of cloves; or the fruit, as in the case of anise and vanilla; or the wood, as in the case of sandal-wood and aloes-wood; or the leaves, as in the case of most of the Labiate, Umbellifera, &c.

Aromatics may be arranged in the following sub-classes: (1.) Those in which the active principle is an essential oil, as the oil of thyme, lavender, cajeput, neroli, fennel, &c. (2.) Those containing camphor, or an allied body, such as artificial camphor obtained from turpentine. (3.) Bitter aromatics, in which there is a mixture of a bitter principle and

an essential oil, as chamomile, tansy, worm-wood, &c. These are tonics and vermifuges. (4.) Those of which musk is the type, such as civet and amber; and certain plants with a musk-like odour, such as *Malva moscata*, *Mimulus moschatus*, and *Hibiscus abelmoschus*. (5.) Those containing a fragrant resin, as benzoïn, myrrh, olibanum, storax, and the balsams of Peru and Tolu, which possess stimulant properties. (6.) Lastly, those which are artificially produced by destructive distillation, as tar, creosote, benzol, or the various empyreumatic oils.

As a general rule, these substances act as diffusible stimulants of more or less power, and as antispasmodics, while those in which a bitter principle is present act as vermifuges and tonics. The whole class were formerly regarded as possessing disinfectant and antiseptic properties, and there is no doubt that some, as coal-tar, creosote, &c., strongly possess this property. In this country we usually associate aromatics with other medicines; but in France aromatic infusion, lotions, baths, &c., are much prescribed. It will suffice to give the composition of aromatic infusion as an illustration. Take equal parts of the leaves of sage, ordinary and lemon thyme, hyssop, origanum, wormwood, and mint. Infuse 50 parts of these leaves in 100 parts of boiling water.

**ARTERECTOMY**, or the opening of an artery, is an operation that has been strongly advocated in those cases in which it is desirable to produce a more decided and immediate effect upon the cerebral circulation (as in severe forms of sanguineous apoplexy) than could be produced by ordinary venesection. It is supposed by some surgeons to relieve pressure on the brain more efficiently than opening the jugular vein could do; and whether this is the case or not, it is a simpler and less dangerous operation. The only vessel operated on is either the temporal artery itself or one of its main branches. The operation is a simple one, but should, of course, only be undertaken by a surgeon. To arrest the flow of blood when sufficient has been taken, the artery should be completely divided, and after the parts have been sponged, a compress, or small pad, should be applied to the wound, and secured by a bandage, which must be carefully adjusted, so as, if possible, to remain undisturbed for four or five days, when it may be removed, and the wound covered with a strip of plaster.

**ARTERIES, DISEASES OF.** Most of the important morbid conditions of the arteries are those which are occasioned by the deposition of *atheroma* (a Greek word signifying a tumour or deposit containing matter like *athëra*, meal or groats) on the free surface of the inner coat of the vessel; a new inner lining to the artery being thus furnished. As atheroma has the effect of weakening, enlarging, and occluding arteries, according to the extent and period of the deposition, it is expedient briefly to notice the most important stages of its progress. In the earliest stage, atheroma consists of a thin, soft, and clear membrane, lining a part or the whole of the tube. It seems to be a mere addition to the artery, in whose original coats there is no appearance of disease. It is most probably a deposit on the inner surface from the blood. On the inner surface of the new coat, a similar layer gradually forms, and in course of time, becomes the foundation of subsequent formations; and when many strata have thus been deposited, the collective mass ceases to be transparent, and becomes converted into an opaque material similar to hardened albumen, and finally to ligament. Until this consolidation occurs, the coats of the artery are not much affected; but by their adhesion to the hardened deposit, they

lose their strength, elasticity, and natural colour, and their functions are destroyed. The indurated deposit may now undergo one or other of these changes: it may either soften in its interior, in which case it degenerates into a pulpy mass of cholesterine, oil-globules, albuminous and chalky molecules; or it may be converted into a layer of hard, chalky, bone-like matter. This latter change (cretification or ossification) takes place only in the external oldest layers of thick deposits; and nothing intervenes between the bony plate and the middle coat of the artery, for the inner or lining coat partakes in the morbid change. It is obvious that either of these changes (softening or hardening) must gradually lead to disease of the arterial coats generally. The process of change is slow, and the change itself can only be detected in the living subject when it is in an advanced stage. In the radial artery and others which lie superficially, the finger can often detect rings or tubes of chalky matter. Most commonly, however, the state of the arteries is detected by some secondary symptom.

Atheromatous deposit is at first attended with a narrowing of the calibre of the vessel, varying with the thickness of the deposit, and most marked at the points of bifurcation. Smaller arteries may be completely obliterated, whilst the larger arteries may be very much contracted. Thus, the common iliac has been found to have its canal diminished by about one half, and the great ascending branches of the arch of the aorta, the subclavian and carotid arteries, have been found very nearly closed. A later consequence of the same disease is dilatation of the vessel. The power of the outer coats being insufficient to compress the deposit and to close in upon the blood, by which each contraction of the left ventricle of the heart distends them, they remain wide and distended during the relaxation of the ventricle, and the artery thus slowly expands; the enlargement being most marked at parts where there is most obstruction to the blood-current, as, for example, in curved arteries. These dilatations are apt to terminate in regular aneurism. The changes which we have already described have an effect on the retractile power of the arteries. A healthy artery, if cut across, may shorten to the extent of an inch and a half, as has been actually measured by Mr Moore ('Diseases of the Arteries,' in Holmes's *System of Surgery*, vol. iii. p. 329); but the retractile power is destroyed by the deposition of bony rings or plates. But although incapable of shortening, the arteries sometimes become abnormally lengthened, and consequently become not only dilated, but also tortuous. If the outline of superficial arteries thus affected be watched, each pulsation of the heart is seen to increase their curvature; and deep-seated arteries (as the iliac) are thus often forced from their normal positions. Another condition involving much danger is this: an ossified artery loses the smoothness which the interior of the vessel ought to present, and from the displacement or cracking of a bony plate, there may be sharp rough projections exposed, to which the fibrin of the circulating blood may adhere. These little clots becoming detached, may be carried with the blood till they become arrested, and plug up an artery, thus presenting cases of embolism or Thrombosis (q. v.). Again, the relation of this disease to accidents and surgical operations on arteries is obvious. A blow may crush a diseased artery, when a healthy elastic vessel might have escaped injury. Such a slight movement as suddenly lifting the arm to the head, for the purpose of securing the hat in a sharp gale, has been known to have been followed by aneurism of the axillary artery. A ligature applied to any ossified artery, is very apt to

cause it to break, and the difficulty of securing such vessels is often very great. It is to this form of disease that most of the failures of operations for aneurism are due. Having thus noticed the most important changes which are induced in the arteries by atheroma, and the evil consequences to which they may give rise, we shall now direct attention to an important cause of occlusion—that, namely, in which the canal is closed by an imported foreign body, and especially by fibrinous plugs originally formed in the heart, and transported to other parts in the stream of the blood. When a large artery, as, for example, the principal artery of one of the limbs, is 'suddenly plugged in its higher part, a sensation of severe pain is commonly the immediate result of the accident. In some cases, the pain extends along the course of the vessel, which, though pulseless, is extremely tender; in others, the suffering is referred to some distant part of the limb, as, for instance, to the calf. Signs of a deficient circulation succeed, and they may amount to pallor, loss of temperature, numbness of the surface, or even to that "torpor" which is observed to precede the total death of a limb in certain cases of injuries of vessels. Such torpor implies not only a loss of circulating blood, but also a cessation of all feeling and motor power in the limb.'—Moore, *op. cit.*, p. 335. Although Gangrene (q. v.) is always to be feared as the result of an obstructed artery of large size, it does not invariably follow; as a collateral circulation may be established, and the life of the limb may be thus saved. Very young persons will endure the obliteration of very large vessels without gangrene; and a case is on record (*Med. Chir. Trans.*, vol. xxix. p. 214) in which 'all the main arteries of both upper extremities and of the left side of the neck were reduced to solid cords,' and yet no gangrene ensued. From the description of the symptoms, the nature of a case of sudden occlusion of a large artery by a plug may possibly be recognised, or, at all events, suspected even by a non-professional observer. Medical aid must at once be sought. The early indications of treatment are to preserve the temperature of the part, to favour the establishment of a collateral circulation, to protect the limb from irritation or injury, to give nourishing blood-making food, and to relieve pain by the judicious use of opiates. The later treatment, if the affection is not checked, is that which is described in the article GANGRENE—*Arteritis, or Inflammation of the Arteries*, was a disease which was formerly recognised by physicians. No such specific general disease is now believed in; but the changes which have been already described as occurring in consolidated atheromatous deposits—either softening or ossification—are accompanied by an unnaturally vascular condition of the attenuated arterial walls, extending to true local inflammation, and even to suppuration.—*Aneurism* (a tumour containing blood, and communicating with the cavity of an artery) has been considered in a special article.

**ARTIFICIAL LIMBS.** With the exception of the celebrated artificial hand of the German knight, Götz von Berlichingen\*—who flourished

\* The iron hand of this knight, who has been immortalised by Goethe, is preserved at Jarxhausen, near Heilbronn, and a duplicate of it is in the Schloss at Erbach, in the Odenwald. It is stated in Scott's *Border Antiquities*, vol. ii., p. 206, that the family of Clephane of Carlolie 'have been in possession from time immemorial of a hand made in the exact representation of that of a man, curiously formed of steel,' which was conferred by one of the kings of Scotland on a laird of Carlolie, who had lost his hand in the service of his country.—See *Notes and Queries* for July 17, 1867, p. 35.

## ARTIFICIAL LIMBS.

in the early part of the 16th c. (1513), and who was named *The Iron-handed*—which weighed three pounds, was so constructed as to grasp a sword or lance, and was invented by a mechanic of Nuremberg, our knowledge of artificial limbs dates from the time of Ambrose Paré, whose *Œuvres de Chirurgie* were published in 1575. The twelfth chapter of that volume, as translated by

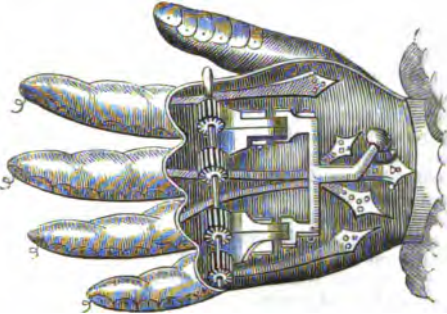

Fig. 1.

Thomas Johnson in 1605, shews 'by what means arms, legs, and hands may be made by art, and placed instead of the natural arms, legs, and hands that are cut off or lost.' The accompanying figures

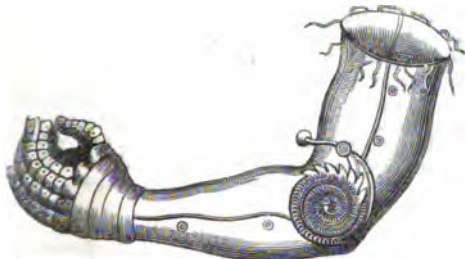

Fig. 2.

are copies of his drawings of 'an hand made artificially of iron (fig. 1),' and of 'the form of an arm made of iron verie artificially (fig. 2).' He also gives a drawing of 'a wooden leg made for a poor man' (fig. 3), which is simply the common wooden leg with bucket receptacle still in use. No improvements worthy of record were made from the time of Ambrose Paré to the beginning of the present century, when Baillif of Berlin constructed a hand which did not exceed a pound in weight, and in which the fingers, without the aid of the natural hand, not only exercised the movements of flexion and extension, but could be closed upon and retain light objects, such as a hat, and even a pen. 'Artificial hands,' says Mr Heather Bigg, 'are now constructed, by means of which a pin may be picked up from the ground, a glass raised to the lips, food carried to the mouth, and a sword drawn from its scabbard, and held with considerable firmness; while a combined arm and hand is fabricated, which is equal to the ordinary requirements of histrionic declamation.'—*Orthopraxy*, 1865, p. 157. The utility of an artificial arm depends much on the nature of the stump. A stump above the elbow is best suited for an arm when it gradually tapers to its lowest end, and terminates in a rounded surface. When an arm is removed at the shoulder-joint, and there is no stump, an artificial arm can still be fixed in its proper place by means of a corset. In amputation below the elbow-joint, the best stump

is one which includes about two-thirds of the forearm; while a stump formed by amputation at the wrist is very unsatisfactory. The simplest form of artificial arm intended to be attached to a stump terminating above the elbow, 'consists of a leathern sheath accurately fitted to the upper part of the stump. The lower end of the sheath is furnished with a wooden block and metal screw-plate, to which can be attached a fork for holding meat, a knife for cutting food, or a hook for carrying a weight.'—*Op. cit.* p. 160. The arm should be so carried as to represent the position of the natural arm when at rest. It is retained in its position by shoulder and breast straps, and forms a light, useful, and inexpensive substitute for the lost member. More complicated, and therefore more expensive pieces of apparatus are made, in which motion is given to the fingers, a lateral action of the thumb is obtained, and the wrist-movements are partially imitated; and a degree of natural softness is given to the hand by a covering of gutta-percha and India-rubber. Such a hand, says Mr Bigg, is often more symmetrical in aspect than the natural hand, but it possesses no efficient grasping power. Hence provision has to be made for attaching various instruments to its palm, such as special hooks, which can be removed at pleasure, for driving, shooting, &c.; apparatus for using the knife and the fork, for grasping the pen, &c.: indeed, the number and variety of instruments capable of being applied to an artificial hand are extremely great. Nothing has tended so much to the very highest development of artificial arms and hands, as an accident which happened more than a quarter of a century ago to the celebrated French tenor, M. Roger, who lost his right arm above the elbow. It was necessary, for his future appearance on the stage, that he should have an artificial limb, which would serve the purposes of histrionic action, and permit him to grasp a sword and draw it from its scabbard. Such a contrivance was invented in 1845 by Van Petersen, a Prussian mechanic, and the French Academy of Sciences commissioned M.M. Gambey, Rayer, Velpeau, and Magendie to report upon it. For a history of the nature of the limb, the reader is referred to the report which appeared in the *Comptes Rendus* for that date, or to Mr Bigg's *Orthopraxy*, pp. 176—181. The apparatus, which weighs less than 18 ounces, was tested upon a soldier who had lost both arms. By its aid he was enabled to pick up a pen, take hold of a leaf of paper, &c.; and the old man's joy during the experiment was so great, that the Academy presented him with a pair of these arms. Van Petersen's conceptions have been extended and improved by Messrs Charriere, the celebrated surgical mechanics of Paris, aided by M. Huguier, the well-known surgeon. A very marvellous arm has also been almost simultaneously constructed by M. Beohard, which, 'by means of a single point of traction, placed in pronation, executes first the movement of supination, next in succession the extension of the fingers and abduction of the thumb: the hand is then wide open.'—Bigg, *op. cit.* p. 190.

Artificial legs having fewer requirements to perform than artificial arms, are comparatively simple in structure. We borrow the description of our figure of the ordinary bucket leg in common use



Fig. 3.

amongst the poorer classes from Mr Bigg's *Orthopraxy*. 'It consists of a hollow sheath or bucket, A, accurately conformed to the shape of the stump, and having—in lieu of the more symmetric proportions of the artificial leg—a 'pin,' B, placed at its lower end to insure connection between it and the ground. This form of leg is strongly to be recommended when expense is an object, as it really fulfils all the conditions excepting external similitude embraced by a better piece of mechanism. It is likewise occasionally employed with benefit by those patients who, from lack of confidence, prefer learning the use of an artificial leg by first practising with the commonest substitute.' As, when the body rests on a single leg, the centre of gravity passes through the tuberosity of the ischium, it is essential that the bucket should be so made as to have its sole point of bearing against this part of the pelvis.

Of the more complicated forms of artificial leg three are especially popular. The first of these is of English origin, and owing to its having been adopted by the late Marquis of Anglesea, is known as the *Anglesea leg*. For a description of it, the reader is referred to Gray's work on *Artificial Limbs*, one of the firm of Grays having been the constructor of the legs used by the marquis. This was for a long time the fashionable artificial leg. The second leg worthy of notice is that invented by an American named Palmer, and called the *Palmer leg*. From its lightness and the greater ease of walking with it, it has long superseded the Anglesea leg in America. In the third of these legs, also invented in America, and known as *Dr Bly's leg*, the principal faults of the two other legs have been completely overcome. The advantages of this leg are thus summed up by Mr Bigg, who has fully described and figured its mechanism: (1.) Adaptation to all amputations either above or below the knee. (2.) Rotation and lateral action of the ankle-joint. (3.) Power on the part of the patient to walk with ease on any surface, however irregular, as, owing to the motion of the ankle-joint, the sole of the foot readily accommodates itself to the unevenness of the ground, which is an advantage never before possessed by any artificial limb. (4.) The ankle-joint is rendered perfectly indestructible by ordinary wear, owing to its centre being composed of a glass ball resting in a cup of vulcanite; thus it never gets out of repair, as the Anglesea leg but too frequently does, and the original cost is almost the only one the patient incurs. (5.) The action of the ankle-joint is created by five tendons, arranged in accordance with the position assigned to them in a natural leg. These tendons are capable of being rendered tight or loose in a few instants, so that the wearer of the leg has the power of adjusting with precision the exact degree of tension from which he finds the greatest comfort in walking, and also of giving the foot any position most pleasing to the eye. (6.) There is a self-acting spring in the knee-joint, urging the leg forward in walking, and imparting automatic motion, thus avoiding the least trouble to the patient, who finds the leg literally and not metaphorically walk by itself. (7.) The whole is covered by a beautiful flesh-coloured enamel, thus avoiding the clumsy appearance of the wood, as is always found in an Anglesea leg, admitting of its being washed with soap and water like the human skin. (8.) At the knee-joint there is a mechanical arrangement representing the crucial ligaments, and affording natural action to that articulation by which all shock to the stump in walking is avoided. This leg is patented, and as might be expected, is somewhat expensive.

In cases of arrested development of the lower

limbs, short-legged persons may be made of the ordinary height by the use of two artificial feet placed twelve or more inches below the true feet, and attached to the legs by means of metallic rods, jointed at the knee and ankle.

Other parts not entitled to be called limbs, can also be replaced by mechanical art—such as the nose, lips, ears, palate, cheek, and eye. In the present advanced state of plastic surgery, deficiencies of the nose, lips, and palate can usually be remedied by an operation; cases, however, may occur where an artificial organ is required. Artificial ears are moulded of silver, painted the natural colour, and fixed in their place by a spring over the vertex of the head. Loss of an eye causes sad disfigurement; but the artificial eyes of Boissonneau (see his *Renseignements Généraux sur les Yeux Artificiels, leur Adoption et leur Usage*), which have been shown in all the recent public exhibitions, completely throw all others in the shade, and cannot be detected without the closest inspection. For further details on all these subjects we must refer to Mr Bigg's volume, which is a complete encyclopædia on these and allied topics.

**ARTVIN**, a town of Asiatic Turkey, in the vilayet of Trebizond, 100 miles east from the town of Trebizond. It is situated in a ravine, on the Tchork, which is here crossed by a bridge. The houses are mostly built of wood, but some are of stone. The inhabitants mostly belong to the Roman Catholic Church. Olive and mulberry groves mingle with the houses. There is some trade in butter, wax, honey, olives, and oil, the products of the neighbourhood. Pop. supposed to be about 6500.

**ARZIGNA'NO**, a town of North Italy, 11 miles west-by-south from Vicenza, in a plain surrounded by hills, near the Agno. It has manufactures of woollens, leather, and silk twist, also an active trade in wine and in cattle. In the neighbourhood are brick-works, lime-works, and coal mines. Pop. of town (1871) 2706.

**ASCH**, a town of Bohemia, in the extreme west of that country, close to the border of Franconia, about four miles north from the Erzgebirge, on a small affluent of the Eger, and 100 miles west-north-west from Eger. It has cotton, linen, and woollen manufactures. Pop. (1869) 9405.

**ASCIANO**, a town of Tuscany, North Italy, in the province of Siena, 12 miles south-east from Siena, on the left bank of the Ombrone. The town stands on the slope of a hill. Its churches contain some fine pictures. Pop. (1871) 3430.

**A'SHBORNE**, or **ASHBURN**, a market-town of Derbyshire, England, a short distance from the left bank of the Dove, in a fertile valley, amid beautiful scenery, 13 miles north-west from Derby. The streets are pretty regular, the houses mostly of brick. The parish church of A. is supposed to have been erected in the 13th century. There are a grammar and a free school, and a number of well-endowed charities. The cotton manufacture is carried on here to a considerable extent; the lace manufacture to a small extent; and there is an active trade in malt and cheese. A. is connected by a branch with the North Staffordshire Railway. Pop. (1871) 2083.

**ASHTABULA**, a rapidly increasing town of the state of Ohio, North America, on the Cleveland and Erie Railway, 3 miles from Lake Erie, and 49 miles north-east from Cleveland. It stands on a river of the same name, which flows into Lake Erie, and at the mouth of which there is a harbour. It is a place of considerable trade. Pop. (1870) 1993.

**ASIA'GO**, a town of North Italy, 22 miles north

from Vicenza. It stands on a ridge, among the southern spurs of the Alps. It is celebrated for the manufacture of straw-hats, and also for carpenter-work and turning. Pop. 5140. The surrounding district, known as the 'Seven Communes,' is well wooded, and abounds in sheep and cattle (see *SERRÁ COMMUNI*).

**ASINALUNGA**, or **SINA LONGA** (anc. *Ad Mausulas*), a town of Tuscany, North Italy, in the province of Siena, 22 miles south-east from Siena, on the Siena Railway. It is beautifully situated on hills bordering the Val di Chiana, and is a well-built town, with wide and well-paved streets, and a handsome collegiate church, in which are many fine paintings. Pop. of commune, 8500.

**ASOCA** (*Jonesia Asoca*), an Indian tree of the natural order *Leguminosæ*, sub-order *Cesalpinea*, remarkable for the beauty of its red and orange flowers. The leaves are abruptly pinnate, shining, and very beautiful. The A. is often mentioned in Indian poetry, and is connected also in various ways with the Hindu mythology.

**ASOLA**, a fortified town of Northern Italy, in the province of Brescia, situated on the left bank of the Chiase, 19 miles west-north-west from Mantua. It is a place of great antiquity. The chief branch of industry, not agricultural, is the manufacture of silk twist. Pop. of commune, 5500.

**ASPARAGINE** ( $C_5H_7N_3O_6 \cdot 2HO$ ) is a crystalline substance which exists ready formed in common asparagus, in the marsh-mallow, in comfrey, in potatoes, in chestnuts, in the leaves of the deadly nightshade, in liquorice-root, in the milky juice of the lettuce, in the tubers of the dahlia, and in the young shoots of vetches, peas, beans, &c. According to Piria, the young shoots of these plants, when formed in the light, contain as much asparagine as when they are grown in the dark, but the asparagine disappears as the plant arrives at the flowering stage. Other chemists, including Pasteur, find that vetches grown in light are free from asparagine. This substance is readily obtained from the expressed juice of the young shoots of asparagus, of young vetches, &c., which, after filtration and evaporation to a syrup, soon deposits it in crystalline prisms of a right rhombic form. These crystals dissolve freely in boiling water, the cooled solution having a mawkish and cooling taste, and a slight acid reaction. Asparagine exhibits two remarkable transformations. (1.) When its aqueous solution is heated with alkalis or acids, it is decomposed into aspartic acid ( $C_4H_7NO_5$ ) and ammonia; from this and other reactions, there is no doubt that it should be regarded, according to modern views, as the Amide (q. v.) of aspartic acid. (2.) While a solution of pure asparagine-crystals remains unchanged, if any colouring matter is present the solution passes into fermentation, and the whole of the asparagine is converted, by the assimilation of hydrogen, from the pigment into succinate of ammonia, a reaction which may be expressed as follows:

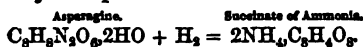

Like most of the amides, this substance unites both with acids and alkalis, but the resulting compounds are of little general interest. That asparagine plays an important part in the physiology of plants, is obvious from its wide distribution.

**A'SPÉ**, a town of Valencia, Spain, in the province of Alicante, and 21 miles west from Alicante, near the river Elcha. It is pretty well built, but the streets are narrow and winding. It has numerous flour-mills and oil-mills, also soap-manufactories and

brandy distilleries. There is a considerable trade in wine. Pop. 6744.

**ATESSA**, a town of South Italy, in the province of Chieti, and 23 miles south-south-east from Chieti. It has a beautiful collegiate church, and several other churches and convents. Pop. (1871) 5197.

**A'THERSTONE**, a market-town of Warwickshire, England, on the borders of Leicestershire, 16 miles north-east from Birmingham; in a valley surrounded by finely wooded hills, on the Roman road called Watling Street, the Trent Valley Railway, and the Coventry and Fazely Canal. The town is irregularly built; many of the houses are very ancient; the old houses are of stone, the modern ones of brick. Some of the modern churches and other public buildings are handsome structures. Hats, stockings, and ribbons are manufactured here. Pop. (1871) 3661.

**ATLANTIC TELEGRAPH**. Referring to other articles for details concerning the scientific and mechanical principles of electro-telegraphy, the Atlantic cables may more especially be described here.

The possibility of laying an electric cable in the Atlantic, from Europe to America, was suggested by Professor Morse so far back as 1843; but it was not until 1854 that Mr Cyrus Field and others discussed the means of practically realizing the idea. Lieutenant Maury discovered that the bed of the Atlantic, between Ireland and Newfoundland, forms a kind of plateau, covered with soft ooze, favourably situated as a resting-place for a cable. In 1855, negotiations were carried on, partly in America, but chiefly in England, to establish a company and raise capital; which objects were attained in 1856. The 'New York and Newfoundland Telegraph Company' connected Newfoundland with the mainland of America by cables and land-wires; but the 'Electric Telegraph Company' undertook the laying of a cable from Newfoundland to Ireland, with a capital of £350,000, in shares of £1000 each. A length of 2500 English miles of cable was ordered, and was completed by the summer of 1857. The conductor consisted of 7 fine copper wires, No. 22 gauge, twisted tightly together, forming a cord  $\frac{1}{4}$ th inch thick, and weighing 107 lbs. per mile. This thickness was increased to  $\frac{3}{4}$ th inch by a core of three layers of gutta percha. Outside the core was a jacket of hempen yarn, saturated with pitch, tar, bees-wax, and boiled linseed oil. The outer sheath consisted of 18 strands, each formed of 7 No. 22 iron wires. The whole diameter was about  $\frac{1}{2}$ th inch, and the weight 1 ton per mile. In the manufacturing processes, the wires and yarns were twisted round each other by revolving drums and circular tables worked by steam-power; while the coatings of gutta percha were applied by forcing the substance through dies which had the copper conductor passing through their centre. The *Niagara* and the *Agamemnon*, the one lent by the United States government and the other by the English, took 1250 miles of the cable each, and steamed forth from Valentia (west coast of Ireland) on August 7, 1857. The *Niagara* paid out her portion of cable as she went. On the 11th, in an attempt to slacken the rate of paying out, the cable snapped, and the end sank in 2000 fathoms water, at 280 miles from Ireland. The appliances on board were not sufficient to remedy the disaster, and the two ships returned to Plymouth, where the two portions of cable were placed in tanks until the next following year.

The Atlantic Telegraph Company raised more capital, made 900 miles additional cable, and prepared for a new attempt in 1858. The *Niagara* and

## ATLANTIC TELEGRAPH.

*Agamemnon* were again employed; but the submersion was to begin in mid-ocean, one ship proceeding eastward, and the other westward, after splicing the two halves of the cable. They left Valentia, June 10; but it was not till the 26th that they could finish the splice and commence the submersion. On the 29th, a double breakage took place, and 144 miles of cable went to the bottom, wholly severed from the rest. The *Agamemnon* returned to England for improved appliances and further instructions; and a month was thus lost. On July 23, the two ships again spliced their two halves of cable in mid-ocean, and proceeded with their work without further disaster. On August 6, the *Agamemnon* reached Valentia, and the *Niagara* Newfoundland, and exchanged congratulatory messages through the whole length of cable. Soon afterwards, greetings were exchanged between the Queen and the President, and between many public bodies and official persons. The station at Newfoundland was

connected by wires and cables with the general telegraphic system of America; and that at Valentia with the general system of Europe. The cable continued working until September 1, sending 129 messages (of about 11 words each on an average) from England to America, and 271 from America to England. The signals then ceased, and the cable became useless; it had been injured by the winter's sojourn at Plymouth.

From 1858 to 1864, the Company were engaged in endeavouring to raise new capital, and to obtain increased subsidies from the English and American governments; while scientific men were making improvements in the form of cable, and in the apparatus for submerging it. At length the Telegraph Construction and Maintenance Company (formed by an amalgamation of the Gutta Percha Company with the wire-cable-making firm of Glass and Elliott) made an entirely new cable, much thicker and more costly than the former one. The

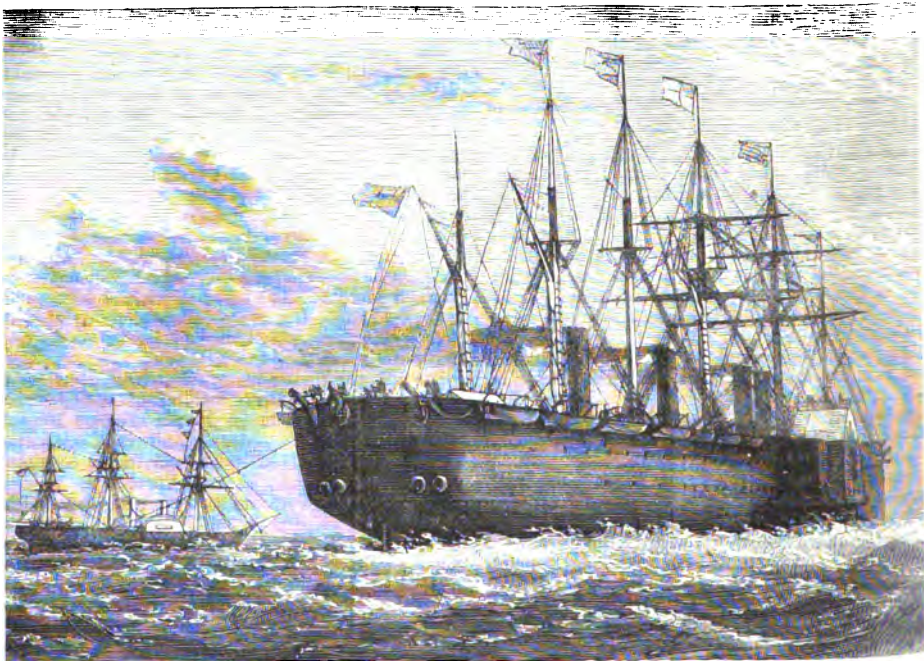

*Great Eastern* paying out the Atlantic Cable.

conductor, 300 lbs. per mile, and  $\frac{1}{4}$ th inch thick, consisted of seven No. 18 copper wires, each  $\frac{1}{16}$ th inch thick. The core was formed of four layers of gutta percha alternating with four of Chatterton's Compound (a solution of gutta percha in Stockholm tar); the core and conductor together were 700 lbs. per mile, and  $\frac{7}{8}$ th inch thick. Outside this was a jacket of hemp or jute yarn, saturated with preservative composition. The sheath consisted of 10 iron wires, No. 13 gauge, each previously covered with 5 tarred Manilla yarns. The whole cable was  $1\frac{1}{4}$ th inch thick, and weighed  $35\frac{1}{2}$  cwt. per mile, with a breaking strain of  $7\frac{1}{2}$  tons.

As the cable (2300 miles) weighed more than 4000 tons, it was resolved to employ the *Great Eastern* steam-ship to carry it out and lay it. Three enormous iron tanks were built in the fore, middle, and aft holds, from 50 to 60 feet diameter each, by 20 $\frac{1}{2}$  feet deep; and in these the cable was deposited,

in three vast coils. On July 23, 1865, the *Great Eastern* started from Valentia with her burden, the main cable being joined end to end to a more massive shore cable, which was drawn up the cliff at Foilhummer Bay, to a telegraph house at the top. The electric condition of the cable was kept constantly under test during the progress of the ship; and more than once, the efficiency was disturbed by fragments of wire piercing the gutta percha, and destroying the insulation. On August 2, the cable snapped by over-straining, and the end sank to the bottom, in 2000 fathoms water, at a distance of 1064 miles from Ireland. Then commenced the remarkable process of dredging for the cable. A five-armed grapnel, suspended from the end of a strong iron-wire rope, five miles long, was thrown overboard; and when it reached the bottom, it was dragged to and fro across the line of cable by slow steaming of the *Great Eastern*; the hope being

that one or other of the prongs would catch hold of the cable. A series of disasters followed by the breaking of swivels, and the loss of grapnels and ropes; until at length, on August 11, it was found that there were no more materials on board to renew the grappling. The *Great Eastern* returned

Content; having thus succeeded in laying a second line of cable from Ireland to America.

Mishaps have since taken place; but in every case the injuries have been attended to, and the two cables maintained in good working order. The rapidity of signalling (at first only two words per minute) was greatly increased; the tariff of charges was lowered; the public of the two nations used the cable-telegraph extensively; and the company realised good dividends, notwithstanding the heavy expenditure which had been incurred.

The art of laying submarine cables being thus established, many other projects for Atlantic telegraphy have from time to time been started. One scheme was for a line from the north of Scotland to Farøe Islands, Iceland, Greenland, and some point near the mouth of the St Lawrence; but the projectors did not succeed in raising capital. A French company afterwards planned a direct route from France to America. In

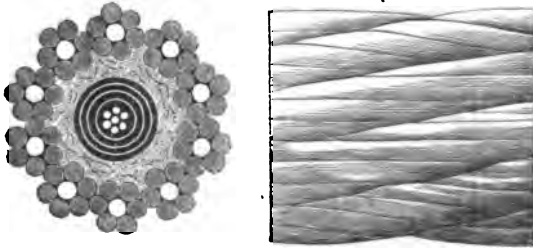

Section and External Appearance of Atlantic Cable of 1866.

to England, leaving (including the operations of 1857—1858) nearly 4000 tons of electric cable useless at the bottom of the Atlantic.

A new capital, and new commercial arrangements altogether, were needful for a renewal of the attempt. Another cable was made, slightly differing from the former. The jacket outside the core was made of hemp instead of jute; the iron wires of the sheath were galvanised, instead of being left in their natural state; and the Manilla hemp which covered them was left white instead of being tarred. These few changes made it weigh nearly 500 lbs. per mile less, mainly through the absence of tar; while its strength or breaking strain was increased. Enough of this cable was made to span the Atlantic, with allowance for slack; while a sufficient addition of the 1865 cable was provided to remedy the disaster of that year.

The Atlantic telegraph operations in 1866 were of a remarkable and interesting kind. On July 13, the *Great Eastern* set forth from Valentia, accompanied by the steamers *Terrible*, *Medway*, and *Albany*, which were to assist in the submersion and in subsidiary matters. The line of route was chosen midway between those of the 1858 and 1865 cables, for the most part a few miles from each. The *Great Eastern* exchanged telegrams almost continuously with Valentia during her progress. The mishaps were few in number, and easily remedied; and the *Great Eastern* safely entered the harbour of Heart's Content, Newfoundland, on the 27th. After this, operations commenced for recovering the end of the 1865 cable, and completing the submersion. The *Albany*, *Medway*, and *Terrible* set off, on August 1, to the spot on the ocean beneath which the end of the cable was lying, or as near to it as calculations could establish. Certain buoys, left anchored there twelve months previously, had been carried away by the storms of the preceding winter; but the latitude and longitude had been very carefully registered. The *Great Eastern* started from Heart's Content on the 9th, and then commenced a series of grappling operations, which continued through the rest of the month. The cable was repeatedly caught, and raised to a greater or less height from the ocean-bed; but something or other snapped or slipped every time. After much trial of patience, the end of the cable was safely fished up on September 1; and electric messages were at once sent through to Valentia, just as well as if the cable had not had twelve months' soaking in the Atlantic. An additional length having been spliced to it, the laying recommenced; and on the 8th the squadron entered Heart's

Content; having thus succeeded in laying a second line of cable from Ireland to America. June 1869, the *Great Eastern* steamed out of Brest with this new cable, no less than 2328 miles long; and the submersion was successfully effected. As the French company wished to obtain a share of the Anglo-American trade, a cable was laid from Brest to Falmouth, where a connection was made with the English land-wires. In the year 1874, a third British cable was successfully laid from Ireland to Newfoundland. A 'Direct United States Cable Company' was also formed; Messrs Siemens undertook the manufacture of the cable, the lightest yet planned for Atlantic telegraphy, its weight being 480 pounds of copper and 400 pounds of gutta-percha per mile; about 3060 miles were needed from Ireland to New Hampshire. The laying of this cable was completed early in the summer of 1875.

Lower down the Atlantic, extensive operations have been or are being completed. When a cable had been laid from Falmouth to Lisbon, the latter became the starting-point for extensive ocean routes. The 'Brazilian Submarine Cable Company' began in 1873 a cable to extend from Lisbon to Madeira, St Vincent, and Pernambuco. The whole length is 4000 miles, of which the longest section (across the ocean) is somewhat under 2000 miles; it is connected at Pernambuco with other cables to Para, Rio Grande, &c.

There is a 'Direct Spanish Cable' from the Lizard to Bilbao; and there are duplicate lines from Falmouth to Lisbon. In and near the Gulf of Mexico, the electricians have been working with great energy. Most of the principal West India islands are now connected by cable one with another, with Colon (Panama), and with the United States mainland at Florida.

A TRI (anc. *Hadria Picena*), a town of South Italy, in the province of Teramo, and 14 miles south-east from Teramo, on a steep hill, 6 miles from the Adriatic. It is of very great antiquity, and some of its coins bear a legend in Etruscan characters. Numerous remains of public buildings, baths, and walls attest its ancient importance. In a hill near the town are some remarkable subterranean chambers, supposed to be excavations of a very remote age. They are formed with the greatest regularity, but their purpose is unknown. A. is a bishop's see. It has an aspect of stagnation and decay. Pop. 3632.

ATROPIA, or ATROPINE ( $C_{17}H_{23}NO_3$ ), is an alkaloid existing in all parts of the deadly nightshade (*Atropa Belladonna*), and in the seeds of the thorn-apple (*Datura Stramonium*); hence it has also been called DATURIA or DATURINE. The Pharmacopœia directions for extracting it from the roots of



belladonna by means of alcohol are somewhat complicated. It is first taken up in combination with malic acid, which is removed by the addition of lime; sulphuric acid is then added, which throws down the lime and forms sulphate of atropia: the atropia is liberated by carbonate of potash, which also separates and resolves impurity, and is taken up by chloroform, which, after being distilled off, leaves atropia, which must be finally purified by decolorisation with charcoal, and crystallisation from an alcoholic solution. The crystals occur in colourless silky needles, united in tufts. It is so highly poisonous, that no one has ventured to use it internally in medicine. A single drop of a solution containing one grain of atropia, one minim of nitric acid, three minims of spirit, and a drachm of distilled water, let fall on the lower eyelid, will dilate the pupil to fully double its ordinary size in the course of about ten minutes, the dilatation lasting for four or five days. The solution thus used is now generally preferred to the dirty practice of smearing the vicinity of the eye with belladonna ointment, in all those cases in which the oculist requires the pupil dilated.

**ATROWLI**, a town of British India, the chief place of a pergunnah of the same name, in the district of Allypore, North-west Provinces, 63 miles north-north-east from Agra. The streets are wide, the bazaar good, and the supply of water abundant. Pop. (1871) 15,062.

**AUBAGNE** (anc. *Albania*), a town of the dep. of Bouches-du-Rhône, France, stands on the Huveaune, 9 miles east from Marseille, with which it is connected by railway. It is built with some regularity and elegance. The ancient town stood on a hill, at the base of which the present town is situated. It was the capital of the Albici, who were subdued by Julius Cæsar. The castle, once of great strength, is now in ruins. The church was founded in 1164. This town is a place of considerable activity, manufacturing pottery, tiles, paper, &c. It has also tanneries and distilleries. Pop. (1872) 4903.

**AUBUSSON**, a town of the dep. of Creuse, France, 125 miles west from Lyon. It is picturesquely situated on the Creuse, in a narrow valley or gorge, surrounded with mountains and rocks. It is a well-built town, consisting chiefly of one broad street. It is celebrated for the manufacture of carpets, which is said to have been introduced by the Arabs or Saracens, who settled here in the 8th century. Tanning and dyeing are carried on, and there is some trade in wine. Pop. (1872) 5890.

**AUGIER, GUILLAUME VICTOR EMILE**, a French dramatist of considerable reputation, was born at Valence, on the 17th of September 1820, and was educated for the profession of an advocate. He soon, however, shewed a predilection for letters, especially the drama. In 1844, he composed a piece in two acts, and in verse, entitled *La Ciguë*, which he offered to the Théâtre Français, but without success. The Odéon, however, received it, and it was played at that theatre with considerable applause for nearly three months. This, while it is the first, is said to be likewise the best of A.'s works, containing some excellent moral lessons, set in a framework of the antique, and made attractive by elegant versification. In the following year, the Théâtre Français sought his services, and he produced for that theatre his second comedy, entitled *Un Homme de Bien*, in three acts, and in verse. This was a comedy of the day, and was only partially successful. A third, *L'Aventurière*, which appeared in 1845, was better received; still there was said to be too much of common-place in the moral sentiments with

which it abounded. *Gabrielle*, in five acts, and in verse, which appeared in 1849, was also a highly moral piece, and gained for its author the Monthyon prize. In 1852, A. wrote a drama, entitled *Diane*, in which Rachel took the principal part, but in spite of all her efforts it proved a failure. He was more fortunate with *La Pierre de Touche*, a prose comedy in five acts, written in partnership with Jules Sandeau, and produced in 1853. In the same year he wrote a verse-comedy, in three acts, entitled *Philiberte*, said to be a charming *genre* piece, in which the grace of the details supplies the absence of intrigue. His subsequent pieces, however, belong all more or less to the comedy of intrigue. Such are *Le Mariage d'Olympe*; *Le Gendre de M. Poirier*, written in partnership with Jules Sandeau; and *La Revanche de Georges Dandin*—all produced in 1855; *La Jeunesse*, in 1858; *Les Lionnes Pauvres*, in the same year, written in conjunction with E. Fournier; and the *Beau Mariage*, also in conjunction with Fournier, in 1859. Either singly or with others, M. A. has also written *Les Effrontés*, *Le Fil de Giboyer*, *Maitre Guérin*, *La Contagion*, *La Chasse au Roman*, *L'Habit Vert*, *Paul Forestier*, and *Sapho*—the last mentioned an opera, the music by Gounod. In 1856, he published a small volume of *Poésies*, some of which are very elegant both in thought and expression. Usually, A. is regarded as one of the leaders of the school of good sense; in his later pieces, however, approaching too much to the manner of the younger Dumas. In 1858, M. A. was elected a member of the Académie Française, and in the same year was promoted to the rank of officer in the *Légion d'Honneur*, of which he became a commander in 1868.

**AUGUSTOWO**, a town of Poland, the capital of a circle of the same name, on the Netta, a feeder of the Bug, 138 miles north-east from Warsaw. It was founded by Sigismund Augustus, king of Poland, in 1557. It has woollen and linen manufactures, and some trade in horses and cattle. Great part of the surrounding district is occupied by lakes and marshes, or covered with forests. Pop. (1867) 9354.

**AULAPOLAY**, or **ALEPPI**, a town of India, in the native state of Travancore, on the sea-coast, in 9° 30' N. lat., and 76° 24' E. long. There is no shelter for shipping, but ships anchor four or five miles from the shore. There is, however, a considerable trade in timber, betel-nut, coir, pepper, and cardamoms. This town communicates with Quilon and Trivandrum on the south, and with Cochin on the north, by canals parallel with the sea-coast, and connecting a series of lakes or back-waters. Between these and the sea is a communication by a wide creek, through which the timber for exportation is floated, which is brought from the forests of the Rajah of Travancore on the Western Ghats.

**AUMALE**, a town of Algeria, on one of the head-waters of the Sahel, 57 miles south-east from Algiers. It is situated on the great road from Algiers to Constantine. It is a strong military post, with barracks, magazines, and hospitals. Population, 5196, of whom 1468 are Europeans.

**AUSTIN, JOHN**, a distinguished writer on jurisprudence, was born on March 3, 1790. At the age of 16, he entered the army, and served as a subaltern with his regiment in Sicily. But he left the service after the peace, and in 1818 was called to the bar. In 1820, he married Miss Sarah Taylor of Norwich (see following article), to whom he had been attached for many years, and went to live in Queen Square, Westminster, next door to Jeremy Bentham and Mr James Mill. In their society, his attention was naturally turned to the subjects he afterwards cultivated with success. He was compelled by bad

health to abandon his practice at the bar, about the time when the university of London was founded, and he then received the appointment of Professor of Jurisprudence. To fit himself for the chair, in the autumn of 1827 he settled at Bonn, then the residence of Niebuhr, Brandis, Schlegel, Arndt, Welcker, and Mackeldey, and he remained there throughout the winter. He returned to England well acquainted with the writings of some of the most eminent of the continental jurists. His lectures were well received by a few distinguished men; but the subject was not recognized as a necessary branch of legal study, and evidently did not supply that kind of knowledge best calculated to promote practical success in the legal professions. A. believed the position of a German professor of law to be the most enviable in the world; and with a small but sure income, he would have devoted his great powers to the exclusive cultivation of the subjects discussed in his lectures. But, unfortunately, no provision was made for the Chair of Jurisprudence beyond class fees, and in the absence of students A., in 1832, was reluctantly compelled to resign his appointment. In the same year, he published his *Province of Jurisprudence Determined*, a work, at the time, little appreciated by the general public, and the small success it met did not encourage him to undertake other publications on the allied subjects. In the estimation of competent judges, however, it placed its author in the highest rank among writers on jurisprudence. In 1833, he was appointed by Lord Brougham a member of the Criminal Law Commission. The post was not much to his taste, as he did not believe that the public received any advantage from such bodies, in the efficacy of which for constructive purposes he put no faith. 'If they would give me £200 a year,' he said, 'for two years, I would shut myself up in a garret, and at the end of that time I would produce a complete map of the whole field of crime and a draft of a criminal code.' These, he thought, a commission might with some profit revise and amend. A. was afterwards appointed a member of a commission to inquire into the grievances of the Maltese. He returned to England in 1838, not in good health, and was advised to try the springs at Carlsbad. During his stay in Bonn he had been delighted with the respect the Germans manifest for knowledge, their freedom of thought, and the simplicity of their habits. With his slender means, decent existence in England was scarcely possible, and he removed with his family to Germany, living at Carlsbad in summer, at Dresden and Berlin in winter. The revolution of 1848 drove him back to England, and he then settled at Weybridge, where he died in December 1859, universally respected for the dignity and magnanimity of his character. His lectures on the principles of jurisprudence had remained in manuscript and imperfect. Since his death they have been prepared for the press by his widow, and published between 1861 and 1863, under the title of *Lectures on Jurisprudence, being a Sequel to 'The Province of Jurisprudence Determined,' &c.* On this work his fame now rests.

A.'s great merit consists in his having been the first English writer who attached precise and intelligible meaning to the terms which denote the leading conceptions underlying all systems of jurisprudence. With a very perfect knowledge of the methods of Roman and English law, he displayed genius of the highest order in devising a novel system of classification for the subject-matter of his science. The work he did is incomplete, but it forms a sure foundation to future labourers in the same field. It is universally recognised as an enduring monument of learning and genius, and it entitles its

author to take rank with Hobbes and Bentham, as one of the three Englishmen who have made contributions of importance to the philosophical study of law. A. said of himself that his special vocation was that of 'untying knots'—intellectual knots; and it was so. He set himself to the task of exposing the errors hid under the phrases and metaphors current among writers on law, and this he accomplished with such skill and subtlety as to make his works models of close and sound reasoning. In education, they now perform a most important part—that of disciplining the mind of those who devote themselves to the study of law and of the mental sciences generally in the difficult art of precise thought; and in this way they exercise an influence it is scarcely possible to over-estimate on the rising generation of lawyers, publicists, and statesmen.—See Memoir of A. prefixed to the *Lectures on Jurisprudence*, and an article on A. in J. S. Mill's *Dissertations and Discussions*.

AUSTIN, MRS SARAE, wife of the preceding, is well known as the translator of many of the best contemporary French and German works. She belonged to the Taylors of Norwich, a family remarkable for the men and women it has produced distinguished by literary and scientific ability. A faithful and devoted wife, she spent a great many years with her husband abroad, and she enjoyed the friendship of many of the most eminent persons in continental society. Mrs A. translated from the German, *Characteristics of Goethe*, by Falk, &c., with notes (1833); *Fragments from the German Prose Writers*, with notes (1841); and *The Story without an End*, by F. W. Carove (several editions). She also translated from the German, Ranke's *Popes of Rome* and his *History of Germany during the Reformation*. Such is the excellence of these works, that they have been commended by the best judges as deserving to retain a place in English historical literature. Mrs A. translated from the French M. Cousin's *Report on Public Education in Prussia* (1834), and M. Guizot's work on *The English Revolution* (1850). She published in 1839 a work on *National Education*; and in 1857, *Letters on Girls' Schools and on the Training of Working-women*. From 1861 to 1863, she was engaged in editing her husband's lectures from his manuscripts, a duty she discharged with very great ability. She died at Weybridge, on the 8th of August 1867.

AUSTRALIAN EXPLORATIONS. Since the article AUSTRALIA in the first issue of the *Encyclopædia* was written, additional information collected by various exploring expeditions has largely modified the opinion formerly entertained with regard to its interior. The expedition of Sturt from South Australia to the centre of the country in 1845, dispelled the notion of a great inland sea, but it substituted the much less hopeful one of a vast and burning lifeless waste; and this opinion appeared to be corroborated by the fate of the gallant Leichhardt, who, after his successful overland journey from New South Wales to Port Essington in North Australia, started in 1847 to traverse the island from Queensland to Western Australia, and was never more heard of. It was for a time universally considered as decided, that a million of square miles in the interior was hopelessly barren, and in consequence, further explorations were abandoned. However, in 1858, John M'Douall Stuart, a companion of Sturt in his travels, having made a short expedition to the north-west of the colony of South Australia, brought back the cheering news, that a very extensive tract suitable for colonisation existed in that quarter, well supplied with lakes and running 'creeks,' and presenting millions of acres of

excellent pasture. Despite, therefore, the arrival of Gregory in the same year from the north-east of the colony with additional unfavourable reports, Stuart resolved to resume once more the exploration of the interior from south to north; and starting from South Australia in 1860, he held a generally north-by-west course, till his further progress was stopped by the threatening aspect of the natives, at a point in lat. 18° 17' S., long. 134° E. Returning with his two companions to organise a stronger force, he retraced his steps (1861) on the previous track; but after travelling 100 miles further than before, was baffled by an impenetrable scrub, through which he in vain sought a passage. Want of provisions forced him to return a second time; but nothing daunted, he started once more in 1862, along the now familiar path, and on July 24th of that year stood on the shore of the Indian Ocean at Van Diemen's Gulf. Mr Waterhouse, the naturalist, who accompanied Stuart in his third expedition, divides the country passed through into three regions: the first, extending as far north as lat. 27° 18' S., is watered by springs, and is suitable for pastoral purposes, though subject to great heat and drought in summer. The springs either issue from the surface of the plains, or from the tops of curious conical eminences evidently of volcanic origin; these eminences varying from the size of a beehive to a considerable hill. The second region, extending northwards to lat. 17° 36' S., is much more defective in water-supply, and its vegetation chiefly consists of a pungent-flavoured coarse grass, known as 'porcupine grass' (otherwise *Spinifex* or *Triodia pungens*), good pasture being only found in the hollows of creeks. This region also presents several ranges of hills of low elevation, the maximum height being 2000 feet above the plain. The third region, which extends from lat. 17° 36' S. to the sea-coast, possesses a rich soil, sometimes lacustrine, and sometimes alluvial, clothed with the usual abundance of tropical vegetation, and well timbered.

The resumption of the exploration of interior Australia by Stuart had the effect of arousing general attention to the subject in the other colonies; and accordingly, while Stuart was on his 1860 expedition, the colony of Victoria was fitting out another party for the same purpose. This expedition, which was put under the command of R. O'Hara Burke, consisted of a large party with a number of camels (which had a short time previously been imported by the Victorian government from India), and left Melbourne on August 20, 1860, reaching Cooper's Creek in the middle of December. Finding that his company was too numerous, and too much encumbered, Burke left the greater portion at the creek under Brahe, to await his return, and with his second in command, William John Wills, and two others, Gray and King, started, with 6 camels, 1 horse, and 12 weeks' provisions, in a northerly direction, reaching the mouth of the Flinders River, at the head of the Gulf of Carpentaria, on February 11, 1861, being the first explorers who crossed Australia from sea to sea. Unable, however, to obtain a view of the ocean, on account of the extensive marshes which skirt the coast-line, they commenced their return journey, and arriving at Cooper's Creek on April 21, found, to their astonishment, the camp completely deserted. From indications marked on a tree close by, they were induced to dig at its foot, and found a small supply of provisions, and a note to the effect that the party in waiting had left Cooper's Creek to return home; the note being dated April 21, the very day on which the exhausted explorers reached the camp, and having been only seven hours written

when read by Burke. In their worn-out condition, it was a hopeless task to think of following this fresh party to the river Darling through 400 miles of desert, though, had they done so, they would have met Brahe returning with a third section of the expedition, which he had met at the Darling, and led back to Cooper's Creek, reaching it on May 8, but retracing the road to the Darling, on finding (after a very slight examination) no signs of Burke's party having arrived there; so Burke, resolving to gain the nearest pastoral station of South Australia, 150 miles distant, the three travellers (Gray had already succumbed to fatigue and famine) pursued this new route at the rate of 4—5 miles per day, till want of water compelled them to return to the Cooper, though, had they known that the station they sought was not more than 50 (instead of, as they thought, 100) miles off, they might by a strong effort have reached it, and been saved. Instead of this, they returned to Cooper's Creek; and their camels being now all dead, and their provisions nearly exhausted, they resolved, as a last resource, to seek out some camp of natives, where they might remain till assistance reached them from the colony. But their limbs were growing feebler and feebler; at last, on June 28, Wills lay down to die, requesting the others to go on; and on June 30, Burke also succumbed. King, the sole survivor, succeeded in reaching the natives, with whom he lived for 2½ months, till a party under Howitt, which was sent out from Victoria in quest of Burke and Wills, arrived at the creek, and rescued him. Burke's experiences of the interior are, as far as we can gather from the scanty records, equally favourable with those of Stuart. He found some good grassy country north of the Cooper, then passed through a sandy and stony district; but from the tropic of Capricorn to the sea, a large proportion was richly clad with verdure and well watered, with now and then a range of hills traversing it.

The unaccounted-for absence of Burke and Wills produced much excitement in the two southern colonies, and gave birth to three separate expeditions, with the view of bringing aid to the missing explorers. Two of these were fitted out by Victoria, and one by South Australia. The former two were intended to act in concert, and were sent round from Melbourne to Rockhampton, in Queensland, in the *Firefly* of 200 tons. At Rockhampton, Walker and his party were landed, in order to make the Gulf of Carpentaria overland, while the brig pursued her voyage to the head of the gulf, and landed Landsborough and his party at the mouth of the river Albert, in the middle of October 1861. On the 17th, Landsborough commenced his march, and following out his instructions to make for Stuart's 'central' mount, followed up the Albert and Gregory rivers, and thence diverging more to the west, found that the water-supply had wholly failed. Turning then southwards along the river Herbert, his small party of three whites and two aborigines in all were compelled to stop in lat. 20° 11' S. by the menacing attitude of the natives, and returned to their dépot on the Albert, which they reached on January 19, 1862. Here they learned that Walker had arrived on December 7, bringing the important news that he had found traces of Burke's party on the Flinders; and Landsborough accordingly resolved to penetrate in an easterly direction. On reaching the Flinders, he found all traces obliterated by the rains, but notwithstanding ascended the river for 280 miles, then crossed to the Thompson, followed it up for the greater part of its course, afterwards striking out eastwards to the Barcoo or Cooper, and failing to reach Cooper's Creek on account of the extreme drought, made for the

settlements on the Darling, and arrived at Melbourne in August 1862. Landsborough found the country between the gulf and the Thompson to consist of good soil thickly grassed; and, with rare exceptions, water was generally abundant.

The South Australian expedition was got up on a much larger scale, consisting of 8 men, 4 camels, 26 horses, 12 bullocks, and 100 sheep, and was put under the command of M'Kinlay, an experienced explorer. It started from Adelaide on August 16, 1861, and on September 24, had passed the furthest settlements of the colony; crossed the formerly mysterious Lake Torrens, which was at that time a dry desert; and came into a district abounding with lakes and creeks, and luxuriantly clad with grass whenever the rain afforded support to animal life. Here it was learned that the fate of Burke and Wills had been ascertained, and the party then held northwards for the Gulf of Carpentaria. Leaving the lake district, they entered the Great Desert, whose inhospitable nature had been so vividly described by Sturt sixteen years before; but curiously enough, in a district in which Sturt had almost perished of thirst, M'Kinlay's party were almost carried away by a flood. In lat. 25° S., they emerged on an extensive country, abounding in grassy plains, watered by rivers, and intersected by hill ranges; and in lat. 22° S. they entered upon a country of tropical character, reaching the Leichhardt, which they followed down till the deep and broad mangrove creeks and boggy flats which form a wide border round the beach of the gulf, hindered their further progress; so that, like all the preceding explorers, with the exception of Stuart, a glimpse of the ocean was denied them. From the Leichhardt River they then proceeded in an east-by-south course, reaching Bowen at Port Denison, in Queensland, in the beginning of August 1862, and thence reached Adelaide by sea.

The results of these explorations of interior Australia agree in this, that there is a much larger extent of territory available for colonisation than was formerly believed; that, in fact, by far the greater portion of the interior is more or less suitable for colonisation, and that only to that portion of it lying in the centre in lat. 27°—25° S. can the term desert be with justice permanently applied. Yet Sturt's desert was certainly no fancy, and his route to the centre of the interior was through a barren waterless waste, while M'Kinlay, who followed nearly the same track, was delighted with abundance of rich pasture and water. The truth seems to lie between the two extremes; Sturt's expedition was carried out during a year of unusual drought, while the recent expeditions here sketched took place during exceedingly moist seasons, the year 1861—1862 being the wettest the colonists of Victoria had ever known. Consequently, we should err in supposing the interior to be a mere desert on the one hand, or a blooming, well-watered expanse on the other. It is in reality a surface covered with soil more or less fertile; the basaltic rocks and clays being the most, and the quartz, sandstone, and granite least fertile; and the rainfall is sufficient, in ordinary seasons, to revive the dormant germs of vegetable life, and cover the surface with a crop of grass more or less luxuriant. On the other hand, the occasionally long continuance of drought, accompanied with an excessive amount of evaporation, wholly dries up some streams, converts others into a series of pools, connected by threads of water, or 'creeks,' reduces extensive lakes to marshes or to shallow pools, in which the concentration of the soluble salts of the soil renders the water so brackish as to be wholly undrinkable, and restores the verdant surface for a time to the

condition of a desert, herbage remaining only on the banks of creeks. The rainfall, which is the sole water-supply in the central districts, does not occur at regular intervals, but there is every reason to suppose that the excessive drought experienced by Sturt has not reappeared since 1845. Occasionally, the fall of rain is so excessive as to convert the whole of a plain, as far as the eye can reach, into a shallow sea, which, however, soon disappears by the drainage of the rivers and creeks, or under the influence of the excessive evaporation, and in an almost incredibly short period thereafter, the ground is clothed with verdure. The climate of the northern districts is very different; there we have a temperature even higher, but its effect on vegetation is rendered very favourable by the frequent and moderate rains.

These expeditions have also contributed a few facts respecting the rivers of North Australia. The Flinders was estimated by Landsborough to be fully 500 miles, and the Albert 100 miles long; the Roper was found by Stuart to be a deep wide river at about 100 miles from its mouth; on the whole, the river system of North Australia is much more extensive than was formerly supposed.

In 1865, an expedition under the command of M'Intyre, an experienced explorer, was fitted out for the purpose of searching for evidence as to the fate of Leichhardt and his party, but it could not advance further than Cooper's Creek. In the end of 1866, another expedition was organised for the same object, which met with but small success.

Our knowledge of the interior of Western Australia was considerably extended by the expedition which started from the west under Forrest in 1869; and the observations made during the construction of the overland telegraph line from Adelaide to Port Darwin on the Gulf of Carpentaria, confirmed the view that much of the interior of the island continent is fitted for agricultural purposes. The expeditions of Gosse and Warburton in 1873 explored part of the *terra incognita* west of the central telegraph line. The superiority of Eastern Australia is the great lesson of recent explorations.

AUXERRE (anc. *Autissiodorum*), chief town of the dep. of Yonne, France, stands on the Yonne, 90 miles south-east from Paris, with which it is connected by railway. It is situated on the slope of a hill, in a rich and beautiful district abounding in vineyards; but the city itself is generally ill built, the streets narrow, crooked, and dirty. Its aspect from a distance is very imposing, the most prominent feature being the cathedral, a grand and beautiful edifice. It is dedicated to St Stephen, and although part of it is as old as the 13th c., it is not yet completed. The greater part of it is in the Flamboyant style, but the choir is in the Early Gothic. The painted glass of the windows is very splendid. The chapter of A. was at one time one of the richest in France. The church of St Germain is another fine building, with a lofty choir and transepts, and a very ancient detached tower. It contains crypts in which are the tombs of the early counts of Auxerre. The church of St Pierre is a beautiful specimen of the Italianised Gothic, built in the 16th and 17th centuries. There is a curious old clock-tower over a gate-house, with an ugly skeleton spire of iron bars. The ancient walls of the city have been converted into boulevards. A. was a flourishing town before the Roman invasion of Gaul. It successfully resisted the Huns under Attila, who only ravaged its suburbs. Clovis took it from the Romans. After his death, it became part of the kingdom of Burgundy. The English took it in 1359, but it was retaken by Du Guesclin. Charles VII. gave it up to the Duke of Burgundy. It was finally united to the kingdom of France by

Louis XI. It has a communal college, a museum of antiquities, and a botanic garden. The principal manufactures are of strings for musical instruments, woollen cloths, hosiery, earthenware, and leather. The Yonne becomes navigable here, and large quantities of Burgundy wines are sent down it to Paris; there is also a considerable export trade in timber and in charcoal. Pop. (1872) 12,919.

**AVALLON** (anc. *Aballo*), a town of the dep. of Yonne, France, 26 miles south-east from Auxerre, on a steep hill of red granite, nearly surrounded by the Cousin, which here flows through a ravine. Around the town runs a broad terrace-walk, shaded with lime-trees, about 500 feet above the bed of the river. The surrounding country is fertile, yielding much wine and grain, and abounding also in excellent pastures, on which great numbers of cattle and sheep are fed. The town is generally well built, and has broad and clean streets. The church is ancient, and has a curious Romanesque portal. Manufactures of various kinds are actively carried on, particularly of woollens and paper; and there are distilleries, tanneries, glass-works, &c. There is also a considerable trade in the produce of the neighbourhood. A. is a very ancient town, of Celtic origin. It was sacked by the Saracens in 731 A.D., and by the Normans in 843; taken by Charles VII. in 1433, retaken by Philip the Good, Duke of Burgundy, in 1455; and pillaged by the troops of the League in 1593. Pop. (1872) 5029.

**AVEIRO** (anc. *Avreium*), a city of Portugal, in the province of Beira, 31 miles north-west from Coimbra. It is situated on the Ria d'Aveiro, a salt lake or lagoon, extending five leagues to the north, and separated from the sea by a narrow bar of sand. Into this lake the Vouga, the Antua, and some smaller rivers flow. During a year of great drought, the sand-bar closed up the seaward opening, a vast mass of sand quickly accumulated, and the low grounds were inundated, the water of the rivers escaping only by filtering through the sand. In summer, the lake thus made is partially dried, and marshes are formed, the effluvia from which have rendered the city very unhealthy, so that its population has fallen from 14,000 to 5000, its present number. In 1808, the government opened a new passage through the sand-bar, and executed other works which dried part of the inundated grounds, and improved the sanitary conditions of the city, which, however, are far from being good. A. is a bishop's see, but its cathedral is 'a squalid and tawdry room, up one pair of stairs.' It is a place of considerable activity; it has manufactures of earthenware, but the chief article of trade is salt, which is made in the marshes in summer. Other important articles of trade are fish, wine, oil, and oranges. The anchovy, sardine, herring, and oyster fisheries are actively prosecuted. The city has a deserted appearance. Its streets are narrow and dark, and seamed with filthy canals of salt-water.

**AVE'LLA** (anc. *Abella*), a town of Central Italy, in the province of Avellino, 20 miles east-north-east from Naples. It is delightfully situated in a hilly district, and commands a very extensive view. A ruined castle marks the site of the ancient city, which was founded by one of the Greek colonies from Chalcia, and was celebrated in Roman times for its apples and pomegranates. Virgil speaks of it as *malifera Abella*. Pop. of commune, 5228.

**AVEZZA'NO**, a town of South Italy, in the province of Aquila, 22 miles south from Aquila. It is situated in a beautiful and fertile plain, covered with almond trees and vineyards, about a mile from Lake Fucino. It has a large square, in which is a palace of the Colonna family. The town belongs to

the Barberini family, whose baronial castle is a conspicuous object from the shores of the lake. The castle and some of the churches contain numerous ancient marbles with inscriptions recovered from the lake. The present town is about two miles distant from the site of Alba, the city of the Marsi, celebrated in the history of the Roman Republic, which occupied the crest of a hill; a small village on the site still retains the name of Alba. Pop. 5200.

**AVIGLIA'NO**, a town of South Italy, in the province of Potenza, ten miles north-west from Potenza, on one of the head-waters of the Sele, near the bifurcation of the Apennines. It stands on the brow of a hill, part of which gave way, after long-continued rains in 1824, carrying with it a portion of the town. A. has an elegant collegiate church. The pastures of the neighbourhood are celebrated for their large and fine oxen. Pop. (1871) 11,336.

**AVILE'S** (anc. *Flavignaria*), a town of Asturias, Spain, in the province of Oviedo, and 19 miles north-by-west from Oviedo, at the mouth of the chief branch of the Aviles, which is here crossed by a bridge, and is navigable at high water for vessels of the largest size up to the town. It has several good squares, but the streets are irregular and arcaded. There are copper-mines in the vicinity, and a considerable trade is carried on in copper vessels manufactured from their produce, as well as in coal, which is obtained not far from the town. Manufactures of earthenware, glass, linen, &c. are also carried on. A. is one of the cradles of the Spanish monarchy, and contains a number of curious old buildings. The charter granted to the town by Alonso VII. in 1135 is preserved among the public records. Pop. 7400.

**AVRANCHES** (anc. *Abrancee*), a city of the dep. of Manche, France, near the left bank of the Seez, 33 miles south-south-west from St Lo. It stands on the sides and summit of a high hill, which extends in a long ridge, and the ascent of which is by zigzag roads on terraces. This hill commands a very wide and beautiful view of a finely wooded and cultivated district, with a winding river, which expands into a broad estuary, at the mouth of which is the high islet peak of Mount St Michel. A. was formerly a bishop's see, and its cathedral was one of the most magnificent in Normandy, but was pulled down in 1799 to prevent it from falling. A stone still preserved on the site of the cathedral is said to be that on which Henry II. of England kneeled before the papal legates to receive absolution for the murder of Becket. Before the Roman conquest of Gaul, A. was the capital of the Abrincatui. It was a place of importance during the Roman period. Charlemagne fortified it, but it was taken by the Normans in 865. It was afterwards a frequent object and scene of strife during the wars between the French and English. It has manufactures of lace, tiles, and bricks, and a little trade in grain, butter, cattle, &c. Pop. (1872) 7324.

**AYAMO'NTÉ**, a town of Andalusia, Spain, on the left bank of the Guadiana, and near its mouth, where it forms the boundary between Spain and Portugal. It stands on an acclivity. The upper part of the town consists of narrow and irregular streets; those of the lower part are regular and wide. There are three public squares. The principal occupation of the inhabitants is fishing. Boat-building and lace-making were once very extensively carried on, but both have greatly declined. Pop. 8000.

**AYO'RA**, a town of Spain, in the province of Valencia, and 50 miles south-west from Valencia, on the upper part of a river of the same name, and

situated in an extensive hollow at the base of a limestone mountain. It has four squares and wide streets. On the summit of the hill are the remains of an old castle, close to which the town once stood. The inhabitants are chiefly employed in husbandry and oil-making. Pop. 5412.

**AZIMABAD**, or **TIROWLI**, a town of Sirhind, India, in 29° 48' N. lat., and 77° E. long., on the route from Kurnal to Lodiana, 9 miles north-west from Kurnal. Its site is slightly elevated above the neighbouring plain, which is inundated in the rainy season. It is surrounded by a high brick wall, pierced with loopholes for musketry, and having bastions surmounted with towers. A large

caravanserai is enclosed with a lofty embattled wall, having a tower at each corner, and surrounded by a deep ditch, capable of being filled with water.

**AZUA**, a town of the island of San Domingo, not far from the south coast, on the Bia, and near its mouth, 60 miles west from St Domingo. Pop. 6000.

**AZUAGA**, a town of Estremadura, Spain, in the province of Badajoz, 20 miles east from Llerena. It is situated in an elevated district, drained by the head-waters of the Matalchel, a branch of the Guadiana; the surrounding country produces much grain, is partly covered with extensive oak forests, and contains large tracts of heath, bright in summer with the blossoms of different species of *cistus*. Pop. 6400.

## B

**BACOLOR**, a town of the island of Luzon, Philippines, the capital of the province of Pampanga, 38 miles north-west from Manila. Pop. 8737. It stands in a plain, near the river Pampanga, with which it is connected by a canal.

**BA' CUP**, a rapidly increasing and very prosperous town of Lancashire, and station of the East Lancashire Railway, situated in a beautiful valley near the borders of Yorkshire, 15 miles N. from Manchester, and 12 miles E.-by-S. from Blackburn. Great improvements have been and are still being made in the condition and appearance of the town. There are many churches of all denominations, a mechanics' and a literary institute, reading-rooms, &c., and in August 1867 was opened a beautiful market-house. The pop. was 6981 in 1851, and 17,199 in 1871. B. has extensive cotton-factories, dye-works, brass and iron foundries. There are numerous coal-mines in the neighbourhood; and within a mile from the town, large woollen manufactories.

**BADARKA**, a town of Oude, India, in the district of Bainswarra, four miles east from the Ganges, and five miles east from Cawnpore. Pop. 8000.

**BADMINTON**, a popular game closely resembling Lawn Tennis (q. v. in SUPP., Vol. X.), is played with battledore and shuttlecock on a rectangular portion of a lawn. The ground is divided crosswise by a strip of net, not less than three inches wide, suspended from poles at a height of five feet. As in Lawn Tennis, the ground on either side of the net is divided lengthwise into right and left courts. The first player standing on a specified part of his right court, must strike the shuttlecock so as to fall across the net into the back section of the right court opposite. The opponent strikes it back, then it is returned by the first player, and so on till the first player misses the shuttlecock. After the first stroke it suffices that the shuttlecock be sent across the net, if it does not fly beyond the boundaries.

**BAGARIA**, or **BAGHERIA**, a town of Sicily, in the province of Palermo, nine miles east-by-south from Palermo, with which it is connected by railway. Pop. about 12,000. It is beautifully situated at the base of the isthmus which separates the Bay of Palermo from that of Termini, and is surrounded by groups of palatial villas of the Sicilian nobility, abandoned after the proprietors had ruined themselves by the festivals here cele-

brated in honour of Queen Caroline, at the commencement of the present century.

**BAGNA-CAVALLO**, an inland town of Italy, formerly belonging to the Papal States, 11 miles west from Ravenna, in the province of that name. Pop. about 3900. B. was a Roman city, called Tiberiacum, in honour of Tiberius.

**BAGNI DI LUCCA** (*Baths of Lucca*), a large inland village of Italy, in the province of Lucca, and 13 miles north from the city of Lucca. Pop. of commune about 8200. It is one of the most frequented bathing-places in Italy, and is situated in one of the finest valleys of Tuscany, the valley of the river Lima, a branch of the Serchio. There are hot springs of various temperature from 96° to 136° Fahr., scattered over a limited neighbourhood.

**BAGNO A RIPOLI**, a famous Italian bathing-place, in the province and circle of Florence, five miles east-north-east from the city of Florence.

**BAGNO IN ROMAGNO**, a town of Italy, in the province of Florence, and 35 miles east-by-north from Florence city, on the right bank of the Savio, not far from its source. It is a much frequented bathing-place, having hot springs of temperature 108°—110° Fahr.

**BAGNOLO**, a town of Piedmont, in the province of Cuneo, 12 miles north-west from Saluzzo, on the left bank of the Grana, at the foot of the Alps.—Another small town near Brescia bears this name; also a town in the province of Reggio, in Emilia; and a town of the province of Lecce, in South Italy, as well as many villages in Italy.

**BAHA'R**, or **BEHAR**, a town of Bengal, 34 miles south-east-by-south from Patna, the chief town of a British district of the same name (see *BAHAR*, Vol. I.). According to the census returns of 1871, it contains a population of 44,295. The original city is nearly deserted, and the present town consists of houses scattered about its remains, and interspersed with fields, gardens, and groves. There are some remains of fine mosques. The ruin of this town began with its sack by the Mahrattas about 1742, and was completed by famine some years after.—The present district of Bahar is but a small portion of the great province which was called by that name in the empire of Delhi.

**BAILEY, SAMUEL**, a writer on politics, political economy, mental philosophy, and other subjects, was born in 1791 in Sheffield, where afterwards he

became a banker. He died January 18, 1870, leaving £90,000 as a bequest to the town. His works are: *Essays on the Pursuit of Truth and on the Progress of Knowledge* (1821); *Questions for Discussion in Politics, Political Economy, and other Departments of Knowledge* (1823); *A Critical Dissertation on the Nature, Measures, and Causes of Value* (1825); *A Letter to a Political Economist, occasioned by an Article in the Westminster Review on the Subject of Value* (1826); *Essays on the Formation and Publication of Opinions* (1829)—a sequel to his work on the *Pursuit of Truth*; *A Discussion of Parliamentary Reform* (1831); *The Rationale of Political Representation* (1835); *The Right of Primogeniture Examined* (1837); *Money and its Vicissitudes in Value* (1837); *A Defence of Joint-stock Banks and Country Issues* (1840); *A Review of Berkeley's Theory of Vision* (1842); *A Letter to a Philosopher in Reply to some Recent Attempts to vindicate Berkeley's Theory of Vision* (1843); *The Theory of Reasoning* (1851); *Discourses on Various Subjects, Literary and Philosophical* (1852); *Letters on the Philosophy of the Human Mind* (three series, 1853, 1858, 1863); *On the Received Text of Shakspeare's Dramatic Writings, and its Improvement* (2 vols. 1862, 1866).

Mr B.'s works on the *Pursuit of Truth* and the *Publication of Opinions* gave a great impetus to liberal and advanced views. His writings generally are distinguished by independent thinking, logical precision, a careful English style, and warm aspirations for the improvement of mankind. His treatises on the mind, while abounding in original suggestions, expand and enforce the views of the school of Locke in metaphysics, and what is termed the doctrine of Utility in morals.

**BAILMENT**, an English law term, defined to be 'a delivery of goods for a particular purpose, upon a contract, express or implied, that the purpose shall be carried into effect, and that, when that is done, the goods shall be restored by the bailee, or person to whom they are delivered, to the owner or bailor, or according to its directions.'—*Tomlin's Dict.*

**BAIN, ALEXANDER**, writer on mental philosophy, was born at Aberdeen in 1818. He entered Marischal College and University in 1836, and graduated in 1840. From 1841 to 1844, he assisted the Professor of Moral Philosophy in Marischal College, and in 1844—1845, taught the class of Natural Philosophy. In the winter of 1845—1846, he lectured on Natural Philosophy in the Andersonian University, Glasgow. In 1847, he became Assistant-secretary to the Metropolitan Sanitary Committee, and was thence transferred to the same office in the General Board of Health, which office he resigned in 1850. From 1857 to 1862, and from 1864 to 1869, he was Examiner in Logic and Moral Philosophy in the university of London. For several years he acted as Examiner in Mental Philosophy at the India Civil Service Examinations. In 1860, he became Professor of Logic in the university of Aberdeen.

Mr B. began as a writer in 1840, by contributing to the *Westminster Review*. He also contributed a considerable number of treatises to the publications of W. and R. Chambers, especially in the educational department; among them was an edition of the *Moral Philosophy of Paley, with Dissertations and Notes* (1852). In 1855, he brought out *The Senses and the Intellect*, and in 1859, *The Emotions and the Will*, completing a system of the human mind. In 1861, appeared *The Study of Character, including an Examination of Phrenology*. In 1863, he published an *English Grammar*, and in 1866, a *Manual of English Composition and Rhetoric*. In 1863 appeared

his *Mental and Moral Science, a Compendium of Psychology and Ethics*; in 1870, *Logic, Deductive and Inductive*; in 1872, *A Higher English Grammar*; in 1874, *Companion to the Higher English Grammar*. In 1872, he acted with Prof. Robertson in preparing for publication Mr Grote's posthumous treatise on *Aristotle*; and, in 1873, edited, with a critical introduction, Grote's minor works. In 1873, he brought out a work on the *Relation of Mind and Body*.

As a thinker and writer, B. is remarkable for the subtlety and minuteness of his analysis, and the clearness of his exposition. He belongs decidedly to the empirical or experimental school of philosophy, in opposition to the *a priori*, or transcendental. His chief work, *The Senses and the Intellect*, together with *The Emotions and the Will*, is the most complete systematic exposition of the phenomena of the human mind in the English, or perhaps in any language. B.'s psychology is based on physiology, after the manner of Hartley's; but instead of considering the human organism as capable only of receiving impressions and of acting in response thereto, he finds in it a power of originating active impulses (see SPONTANEITY), and thus obviates many of the defects alleged by *a priori* philosophers to inhere in the system of sensualism, as hitherto exhibited.

**BAITOO'L, or BEITTOOL**, a fortified town of British India, in the presidency of Bengal, and territory of Saugor and Nerbudda, 50 miles north-east from Ellichpoor.

**BAJMAK, or BAJMOK**, a large village of the Austrian empire, in Hungary, province of Bacs, 16 miles south-west of Theresienstadt. Pop. (1869) 6446.

**BAKER, SIR SAMUEL WHITE, K.C.B.**, an African traveller, was born in 1821. He is the son of Mr Samuel Baker, of Thorngrove, in Worcestershire. B. was educated as an engineer, and at an early age, went to Ceylon. There, led by the love of field-sports into the recesses of the island, he gave evidence of that love of adventure which was to make him famous as an explorer. In 1854, he published a work entitled *The Rifle and the Hound in Ceylon*; and in 1855, *Eight Years' Wanderings in Ceylon*. B. afterwards superintended the construction of the railway which connects the Danube across the Dobruzscha with the Black Sea. In 1860, B. married Florence, the daughter of F. von Sess, a young Hungarian lady of great talent and enterprise; and in company with her, he undertook a journey of exploration on the Upper Nile. They set out from Cairo in April 1861; and B. devoted his attention first to the Atbara and Blue Nile, the chief affluents of the Nile, which descend from the highlands of Abyssinia. In June, he arrived at the course of the Atbara, which was at that season dry, or marked only by a few stagnant pools. On the 23d, when the Abyssinian rainy season had set in, a noise like distant thunder was heard, and in a few seconds the river-bed had been converted into a torrent 20 feet deep. Eight days later, it had become a great river, charged with mud, washed from the hills, which it carried down to the Nile, to cause the inundations and mud deposits of Egypt. B. reached Khartoum in June 1862, and there he had an opportunity of contrasting the Blue and White Nile. He found the former, like the Atbara, to be a mountain torrent, rising and falling with the Abyssinian rains, but always free from deposits of mud. The White Nile did not thus rise and fall, and its water, never pure, had a disagreeable taste of vegetation, shewing that it proceeded from lakes and marshes. When B., with his wife, quitted Khartoum to ascend the White Nile, he had in his pay an escort of 90 persons, 29 camels and asses,

BALAGHAT DISTRICTS—BANSWARRA.

and three large boats. After passing through a wonderful region of forests and marshes, the travellers reached Gondokoro, a rendezvous of the traders of the interior. They had only been there a fortnight, when they were joined by Speke and Grant, who had penetrated into those regions from the south. Speke and Grant told B. of the Victoria N'yanza, which they had just discovered and explored, and that the natives had described to them another great lake, named Luta Naige, which they had been unable to visit. B. resolved to reach this lake; and after a series of adventures, he and his wife arrived, on 14th March 1864, on the top of lofty cliffs, from which they beheld the vast inland sea, to which B. gave the name of the Albert N'yanza. In 1869, an expedition for the suppression of slavery in the interior of Africa was organised by the pasha of Egypt, under B.'s command. B. returned in 1873, and reported the success of the expedition. In spite of many difficulties, slavery, he says, has been put an end to, and the whole valley of the Nile is subject to Egypt. B. was knighted in 1866. In 1866, he published *The Albert N'yanza*; in 1871, *The Nile Tributaries of Abyssinia*; and in 1874, *Imailia*, an account of his expedition of 1869-1873.

**BALAGHAT DISTRICTS**, the name given to a large tract of elevated country in the S. of India, 28,669 sq. m. in area, and extending from the rivers Tumbuddra and Krishna in the N. to the furthest extremity of Mysore in the S. It includes Mysore, and the districts of Bellary, Cuddapah, and Kurnul. It was part of the ancient Hindu kingdom of Bijjanagar, or Carnata, was conquered by the Mohammedans, and fell into the hands of the British on the final overthrow of Tippoo (q. v.). The name Balaghat signifies *Above the Ghauts*.

**BALASINORE**, or **BALASINESHWAR**, a petty native state, or *jaghire*, of India, in the province of Guzerat, protected by the British government, and politically connected with the presidency of Bombay. It extends from N. lat. 22° 53' to 23° 17', and from E. long. 73° 17' to 73° 40', and contains an area of about 80 sq. miles. The river Mahi flows through the jaghire. The native ruler is styled Nawab of Balasinore. He has a revenue of 41,548 rupees, of which he pays 10,000 rupees as tribute to the British government. The pop. of B. is estimated at 41,964. The Nawab maintains a force of only 8 horsemen and 50 foot-soldiers, who are employed in revenue, police, and other services.—The capital of the jaghire also bears the name of Balasinore. It is rather a thriving town, and is surrounded by a wall. It is 51 miles north from Baroda.

**BALOTRA**, a town of India, in the Rajpoot state of Joudpore, 59 miles south-west of the city of Joudpore. It is situated on the right bank of the river Loonee. Being on the high-road from Joudpore to Dwarka, a celebrated place of pilgrimage in the west of Guzerat, it is a great resort of pilgrims, with whom its bazaar is often crowded. Many of the inhabitants of the town subsist by providing for their wants. The town is supplied with good water from 125 wells, lined with masonry. Pop. 7275.

**BAMPURA**, **BHAMPURA**, or **BHANPURA**, a town of Hindustan, in the territory of Indore, on the Rewa, 1344 feet above the level of the sea, about 180 miles south-west of Gwalior. It is situated at the base of a range of hills, is surrounded by a wall, and has an unfinished fort, built of stone, which encloses an unfinished palace. Both palace and fort were begun by Jeswunt Row Holkar, of whom there is a beautiful marble statue in the palace. B. is the principal place of a pergunnah containing 70 villages. Pop. 20,000.

**BA'NAS**, or **BUNAS**, the name of three rivers of India.—1. A river of Rajpootana, rising on the western frontier of Mewar, in the Aravulli Mountains, about N. lat. 24° 47', E. long. 73° 28'. Flowing through Mewar for 120 miles, in a generally north-eastern direction, receiving the Beria, or Beruch, on the right, and the Botaseri on the left, it passes the town of Tonk, where it changes its course to the south-east, and falls into the Chumbul in N. lat. 25° 54', E. long. 76° 50', after a total course of 320 miles.—2. A river which also rises in the Aravulli Mountains, and after a south-westward course of 180 miles, is lost in the Runn of Catch, terminating in a number of small and intricate channels.—3. A river of Rewah, in Bundelcund, having a north-westward course of about 70 miles, and falling into the Sone near Rampur.

**BANAWARA'M**, a town of India, in the territory of Mysore, in a fine open country, among the head-waters of the Hugri, 51 miles north-west from Mysore. It is a town of some antiquity. It was taken in 1694, in a night-assault by Chika Dec, Rajah of Mysore. When it had fallen under the dominion of Hyder Ali, the inhabitants were in great part removed to Nagapuri, a new town which Hyder had founded in the vicinity. Previous to this removal, the pop. was about 10,000. The new town proving extremely unhealthy, the survivors of the people of B. were permitted to return to their old habitations.

**BANDAJA'N**, a pass over the Himalaya, forming the southern boundary of Kunnawar. It is amidst mountains of gneiss, and is covered with perpetual snow. The summit of the pass is 14,854 feet above the sea, and is in N. lat. 31° 22', E. long. 78° 4'.

**BA'NDON**, or **BANDONBRIDGE**, a town of the county of Cork, Ireland, on the Bandon, 12 miles south-west from Cork, with which it is connected by a railway. The houses are built of stone. There are several good streets, and numerous ecclesiastical and other public buildings. B. was originally peopled by a colony of English Protestants, and was so strictly Protestant, that till about the beginning of the present century, no Roman Catholic would have been allowed to settle in it. More than three-fourths of the population are now Roman Catholics, and there is a Roman Catholic convent. B. was at one time a prosperous manufacturing town, cotton-spinning and weaving being extensively carried on; but these branches of industry have been almost entirely relinquished, and the pop., which was 9049 in 1841, had diminished to 6131 in 1871. It returns one member to the House of Commons. The country around B. is very beautiful, well wooded, undulating, and pastoral. The river Bandon rises in the Carberry Mountains, and at its mouth forms the harbour of Kinsale. Spenser describes it as 'the pleasant Bandon, crowned by many a wood.' It has a course of 40 miles, for 15 of which it is navigable, to Innishannon, 4 miles below Bandon.

**BANJOEMA'S**, a town of Java, 22 miles from the south coast, in S. lat. 7° 33' 45", and E. long. 109° 19' 20". It is situated at the opening of an extensive and fruitful valley on the left bank of the Serajo. It is well built, and carries on a considerable trade. Pop. 9000. B. is the residence of a Dutch governor, and has a fort and garrison. It is the capital of a province of the same name, which produces coffee, sugar, indigo, rice, tobacco, &c.

**BANSWA'RRRA**, a Rajpoot state in the west of Malwa, bordering on Guzerat. It extends from N. lat. 23° 10' to 23° 48', and from E. long. 74° 2' to 74° 41', and has an area of 1500 sq. miles. The pop. is supposed to be about 150,000. This state was dependent on the empire of Delhi until the



ascendency of the Mahrattas, by whom it was fearfully oppressed. In 1812, the ruler made overtures to the British government, offering to become tributary on condition of protection; and an arrangement to this effect was concluded in 1818.—The capital, also called Banawarra, is on the route from Mhow to Deesa, 123 miles north-west from Mhow. The majority of the inhabitants are Hindus, but the Mussulmans are also pretty numerous. The palace of the Rawul, or chief, is a large, turreted, battlemented building, on a rising ground overlooking the town, near a beautiful tank, overhung with trees.

**BARBACE'NA**, a city of Brazil, in the province of Minas Geraes, 150 miles north-west from Rio de Janeiro. It is situated on the top of two hills in the Sierra Mantiqueira, and at an elevation of about 3500 feet above the sea, so that, although within the tropics, it enjoys a mild climate. The streets are broad and straight, the principal ones paved and provided with footpaths. The houses are low, and have gardens behind. The inhabitants are chiefly engaged in gold-mining and in exporting coffee and cotton to Rio de Janeiro. B. is the centre of a productive district, the pop. of which is 12,000.

**BARBA'DOES LEG**, which seems to be identical with the *Elephantiasis of the Arabs*, is a disease which is characterised by hypertrophy of the skin and of the subcutaneous areolar tissue. Notwithstanding its name, it may affect the arm, female breast, &c. It begins with acute febrile symptoms, and inflammation of the superficial lymphatic vessels. The part swells, and becomes uneasy from tension, the glands being especially large and hard. The skin varies in appearance, being sometimes white and shining, and in other cases of a dark colour, and studded with projecting veins. The swelling is sometimes very great, and quite hard. In some parts of the body, skin which would naturally weigh less than a couple of ounces, is thus converted into a tumour weighing from 100 to 150 lbs. The disease is endemic in the tropics; and in the cases which we see in this country, it always appears that the disease commenced in a hot country.

Iodine is recommended by some doctors, and well-regulated pressure by others. The leg has been amputated, in consequence of the annoyance caused by its great weight; but this should be regarded as an ultimate resource, and ligation of the femoral artery, which often causes great subsidence of the swelling, should be first tried.

**BARCELLO'NA AND PO'ZZO DI GO'TTO**, two towns of Sicily, in the province of Messina, standing close together, so as really to form one town, the two parts of which are separated by a small stream, the Fiume di Castro Reala, supposed to be the Longanus of antiquity. Pop. of the two towns, 14,471. The chief street is a long street of mean houses of a single story. B. is situated in a broad plain, between the mountains and the sea, abounding in corn, wine, oil, and fruit. It is 22 miles west-south-west from Messina.

**BARCLAY, JOHN, M.D.**, lecturer on anatomy in Edinburgh, and eminent for his attainments both in human and comparative anatomy, in physiology, and in other branches of natural science, was born December 10, 1758, at Cairn, near Drummaquhance, in Perthshire, Scotland, and was educated at the parish school of Muthil, and afterwards at the university of St Andrews. He studied for the ministry of the Church of Scotland, and was licensed as a preacher, but afterwards devoted himself to the profession of medicine, and particularly to the study of anatomy. He obtained the degree of M.D. from the university of Edinburgh in 1796. After spending a year in London, he became a

private lecturer on Human and Comparative Anatomy in Edinburgh. He published in 1803, *A New Anatomical Nomenclature*; and in 1808, a treatise on the *Muscular Motions of the Human Body*. In 1812, appeared his *Description of the Arteries of the Human Body*, a work of vast labour and accurate observation. In 1825, not long before his death, he published *An Inquiry into the Opinions, Ancient and Modern, concerning Life and Organisation*. He died at Edinburgh on 21st August 1826, leaving to the Royal College of Surgeons in Edinburgh his admirable anatomical collection, for the reception of which a suitable and splendid hall was erected.

**BA'ARDI**, a small town of Italy, on the left bank of the Ceno, 31 miles west-south-west from Parma, in the province of Piacenza. The town is commanded by a castle, situated on a hill, erected in the 9th century. In the vicinity are noble forests of chestnut, beech, and oak. B. was formerly the capital of the duchy of Bardi.

**BA'RGA**, or **BARGA DE GARFAGNANA**, a town of Italy, in the province of Lucca, 25 miles north-north-east from Pisa, near the left bank of the Serchio. B. has a fine collegiate church, and is celebrated for its gunpowder manufactories. The sides of the neighbouring mountains are covered with noble chestnut forests.

**BA'RGA PASS**, in the Himalaya, in N. lat 31° 16', E. long. 78° 19', the highest part of it about 15,000 feet above the sea.

**BA'RKING**, a town of the county of Essex, England, in a low flat situation, on the left bank of the Roding, about two miles above its junction with the Thames, and five miles north-east of London, on the North Woolwich Railway. Pop. (1871) 5766, among whom are many fishermen, who pursue their occupation on the Thames, the tide flowing up the Roding to the town. The mouth of the Roding is often called Barking Creek. The neighbourhood sends large quantities of potatoes and vegetables to the London market. There is also a transit trade in coal and timber. The church of St Margaret is an edifice of considerable beauty, in the Perpendicular style, and probably of the beginning of the 15th c.; but it contains three columns of the Early Norman style, supposed to have been brought from the ruins of the adjacent abbey.—*Barking Abbey* was one of the richest nunneries in England. It was founded about 677 A.D., in the reigns of Sebba and Sighere, kings of the East Saxons, by St Erkenwald, Bishop of London, whose sister, St Ethelburga, was the first abbess. In 870, it was burned to the ground by the Danes, and the nuns killed or dispersed. It was rebuilt and restored to its former splendour by King Edgar, in the middle of the 10th century. The Abbess of Barking was one of four ladies who held the rank of baroness in right of their office. She lived in great state, and always furnished a quota of men to the king in time of war. She was required also to maintain certain embankments on the Thames. Several queens of England, and other ladies of very high birth, assumed the office of Abbess of Barking. After the suppression of convents by Henry VIII., the abbey buildings soon went to ruin, and scarcely any remains exist except the gate-house.

**BARNES, REV. WILLIAM**, poet and philologist, is author of three collections of poems written in the dialect of Dorsetshire, the first entitled *Poems of Rural Life in the Dorset Dialect, with a Dissertation and Glossary* (Lond. 1844); the second, *Hoomeety Rhymes*, &c. (Lond. 1859); and the third, *Poems of Rural Life*, &c. (Lond. 1862). The first of these collections reached a second edition in 1847, shewing that at least some interest was taken even at

that early period in Mr B.'s 'hwomely rhymes.' They were not critically noticed, however, so far as has been ascertained, until November 1859, when a highly eulogistic review of them appeared in the *North British Review*, pronouncing Mr B. to be 'the best writer of rustic eclogues since Theocritus.' The reviewer also says, speaking of Mr B.'s poetry, 'that it combines in a high degree the special merits of Wordsworth and Burns, but in a way which is so perfectly original, as to bear no trace of even a perusal of those poets by the author.' Such praise, although exaggerated, is not altogether without foundation. Mr B. is a true poet, combining with a genuine love of nature, as seen in the rich grazing-lands of Dorsetshire, a keen sympathy with the rustic population, their hopes and fears, loves, joys, sorrows, and superstitions. It is for this audience that Mr B. professed to write, and it is only such that can thoroughly appreciate his verse. He has, however, also written a collection of poems, called *Poems of Rural Life in Common English* (1868). Attention was again called to Mr B.'s poems by a writer in *Macmillan's Magazine* for June 1862, in an article evidently from the same pen as that in the *North British*, and claiming for Mr B. a place 'at the very head of the properly idyllic poetry of England.' In that article, we are informed that in the previous year (1861), the pension-list, which announced a yearly grant of £50 to Mr Close, in consideration of his deserts as a poet, mentioned one scarcely larger in amount conferred on Mr B. in consideration of his acquirements as a philologist. Mr B. was born of humble parentage at Rush-hay, Bagber, Dorsetshire, in 1810, and was for many years Master of the grammar-school at Dorchester. He is B.D. of St John's College, Cambridge, was ordained in 1847, and was promoted from the curacy of Whitcombe to the rectory of Winterbourn-Came, in Dorset, in 1862. Besides the collections of poems mentioned, Mr B. is author of *An Investigation of the Laws of Case in Language* (Lond. 1840); *An Arithmetical and Commercial Dictionary* (Lond. 1840); *The Elements of English Grammar* (Lond. 1842); *The Elements of Linear Perspective* (Lond. 1842); *S. Geflysta (the Helper): an Anglo-Saxon Delectus* (Lond. 1849); *Notes on Ancient Britain and the Britons* (Lond. 1858); *Views of Labour and Gold* (Lond. 1859); *The Song of Solomon in the Dorset Dialect, from the authorised English Version* (Lond. 1859)—printed at the expense of Prince Louis Lucien Bonaparte; *Tiw, or a View of the Roots and Stems of the English as a Teutonic Tongue* (Lond. 1862); *Early England and Saxon English* (1869). The philological works of Mr B. shew considerable learning and ability.

BARNUM, PHINEAS TAYLOR, American showman, was born at Bethel, Connecticut, July 5, 1810. His father was a tavern-keeper; and while young B. attended the village school, he traded with and played practical jokes upon his father's customers. At the age of 13, he was employed in a country store; and about five years afterwards, went largely into the lottery business. When only 19, he married clandestinely, and then moved to Danbury, where he edited *The Herald of Freedom*, and was imprisoned 60 days for a libel. In 1834, he removed to New York, where, hearing of Joice Heth, nurse of General Washington, he bought her for 1000 dollars, and with the aid of forged documents and puffing, exhibited her to considerable profit. Reduced again to poverty, he sold Bibles, exhibited negro dancers, and wrote for newspapers, until he bought the American Museum in New York, which he raised at once to prosperity by exhibiting a Japanese mermaid, made of a fish and monkey, a white negress, a woolly horse, and finally,

a noted dwarf, styled General Tom Thumb, whom he exhibited in Europe in 1844. In 1847, he offered Mademoiselle Jenny Lind 1000 dollars a night for 150 nights, and received 700,000 dollars—the concert tickets being sold at auction, in one case for 650 dollars for a single ticket. He built a villa at Bridgeport, in imitation of the Brighton Pavilion, and engaged in various speculations, one of which—a clock-factory—made him bankrupt. Settling with his creditors in 1857, he engaged anew in his career of audacious enterprises, and made another fortune. In 1866, he stood as a candidate for a seat in Congress, but was unsuccessful. His *Autobiography* (1854, since greatly enlarged) has the merit at least of frankness. In 1871, he again returned to the business of showman, from which in 1868 he had withdrawn. He has published a work on *The Art of Making Money*.

BAROA'CH, BROACH, or BHARUCH, a large town of British India, giving its name to a collectorate in the presidency of Bombay. It is situated on an elevated mound, supposed to be artificial, about 80 feet above the level of the sea, on the north bank of the Nerbudda, 25 miles from its mouth. The Nerbudda is here a noble river, two miles wide even at ebb-tide, but shallow, and the navigable channel winding and difficult even at high water. It abounds in fine fish. B. is a very ancient town; it is supposed to be the *Barygaza* of Arrian. Situated in the midst of a most fertile district, it was formerly a very flourishing town, with a large population; but fell, in consequence of political troubles, into decay. It has of late begun to recover prosperity, and its commerce is increasing. Its present pop. is estimated at 15,000, within the walls; but including the suburbs, which are extensive, the pop. in 1872 was 36,963. B. belonged to the Mussulman kingdom of Guzerat, on the overthrow of which by the Emperor Akbar, it was assigned to a petty nawab; and falling under the dominion of the Peishwa, was taken by the British in 1772, ceded to Scindiah in 1783, in acknowledgment of the kind treatment of some British prisoners; and again stormed by a British force in 1803, since which date it has remained in the possession of the British. The heat at B. is often excessive, and the situation is regarded as unhealthy. B. carries on a considerable trade with Bombay and Surat—the principal exports being raw cotton, grain, and seeds. It was long famous for its manufactures of cloth; but that of the finer kinds has fallen off very much, in consequence of the importation of English goods. Many of the weavers of B. are Parsees, of whom also are some of the more opulent classes—as ship-owners and ship-brokers. B. has one remarkable institution—a Brahmanical hospital for sick animals, into which horses, dogs, cats, monkeys, peacocks, and even insects are received. It is ostensibly attended by a number of Brahmans, who derive a good income from lands devoted to it, and from voluntary contributions. Pop. of collectorate (1872), 350,322.

BARQUESIMETO, a city of Venezuela, the capital of a province of the same name, situated on an affluent of the Portuguese, in a high plain, 156 miles west-south-west from Caraccas. B. was founded by the Spaniards in 1552; and in the beginning of the 19th c. was a flourishing town, with straight wide streets and some fine buildings, the pop. about 15,000; but in 1802, it was almost totally destroyed by an earthquake. The existing town has been mostly built from the ruins. The pop. is supposed to be about 12,000.—The province of Barquesimeto extends along the coast of the Caribbean Sea, contains an area of 9305 sq. m., and a pop. of about 313,000. Wheat, maize, coffee, cacao, indigo, and cattle are its principal products.

**BARRA MANSA**, a town of Brazil, in the province of Rio de Janeiro, and 70 miles north-west of the city of that name. It is situated on the right bank of the Parahiba. Pop. 6000.

**BARROW-IN-FURNESS**, a seaport and rapidly increasing town of North Lancashire, England, situated on the south-western coast of the peninsula of Furness, opposite to a small island called Barrow Island, which is traditionally reported to have been in former times a burial-place of Norse rovers. It is 8 miles south-west from Ulverston, and 18 miles west-north-west from Lancaster. It is connected by railway with Dalton (q. v. in *Supp.*, Vol. X.), from which it is not quite four miles distant, and so with the whole railway system of England. The growth of B. has of late years been so rapid as to be almost unparalleled in the history of the towns of England. In 1847, it was an insignificant fishing-village of about 300 inhabitants; in 1857, the population was more than 2000, a large proportion being sailors and fishers; in 1871, the population had increased to 18,245; and by 1875 it was above 40,000. This rapid increase is owing to the great quantity of iron ore, of the best quality—red hematite—which exists in the neighbourhood, and the establishment both of mines and smelting-works. A small quantity of iron ore from this neighbourhood was, for many years, exported to be smelted elsewhere; but about ten years since, smelting-works were established at B. by Messrs Schneider, Hannay, & Co., which soon gave employment to a great number of men, and converted the old fishing-village into a prosperous town. In 1865, these works produced about 160,000 tons of iron. In 1866, the Barrow iron-works were taken over by the Barrow Hematite Steel Company, which has now 16 blast-furnaces in constant operation, arranged in a straight line along the sea-shore. The Company raise their own ore, and, in order to keep the furnaces in full operation, require about 500,000 tons of ore annually. The amount of pig-iron made weekly is about 5500 tons, of which nearly 1000 tons are taken to the steel-works, and there converted by the Bessemer process into steel. Great quantities of limestone and coke are used in the iron furnaces and steel-works. The red hematite of B. yields an average of 57 per cent. of iron. The B. steel-works are the largest Bessemer steel-works in Britain, and their great enlargement is proposed. In the B. works, the iron is conveyed in a molten state from the blast-furnaces to the 'converters,' where it is made into steel. Some of the steam-hammers employed have heads of five tons weight, and some of six tons. Copper as well as iron ore is obtained in considerable quantity near B., and is exported to the amount of about 3000 tons annually. About 20,000 tons of slate are also annually quarried in the neighbourhood, and sent by coasters or by rail to other parts of Great Britain.

The town of B. is built on a regular plan, mostly in rectangles. St George's Church is a handsome Gothic building, erected chiefly at the expense of the Dukes of Devonshire and Buccleuch, the principal land-owners of the town and neighbourhood. There are other places of worship belonging to the Church of England and other denominations.

The Furness Railway Company have recently expended a large sum of money in converting the channel between the mainland and Barrow Island into docks. The total cost is estimated at £200,000. There are three principal docks. The total water area of the present docks and timber ponds is 105 acres. Barrow Island has become a great seat of iron ship-building. A large jute-work employs 2000 hands. Other branches of industry have also begun to be attracted to Barrow. Its foreign trade is increasing,

its chief import being timber from Canada. The harbour, however, is excellent, being formed by the island of Walney, a low island about eight miles long, and nowhere much more than a mile in breadth, which extends along the south-western coast of Furness. This island is separated from the mainland by a channel which, immediately to the north-west of Barrow Island, is very narrow, but on the south-west expands into a bay or basin of about three miles long by two broad, opening from Morecambe Bay. From the excellence of the harbour, the abundant facilities of railway conveyance, and the mineral wealth of the district, it may confidently be expected that B. will still increase very rapidly in importance as a commercial town.

**BARTHELEMY, AUGUSTE-MARSKILLE**, a French poet and politician of some eminence, was born at Marseille in 1796. Whilst still very young, he was sent to the college of Juilly; and he had scarcely completed his studies when he began to acquire reputation in his native town as a poet of distinct promise. He was naturally attracted to Paris, where, at first, his verses, published without his name, did not attract much attention. Gradually, however, he became known; and in 1825, in conjunction with his fellow-townsmen, M. Méry, he issued a collection of satirical epistles, under the title *Les Sidiennes*; and the year after, a mock-heroic poem, *La Villeliade, ou la Prise du Château de Rivoli*. This vigorous political squib had a great success: in the course of the year, it ran through fifteen editions, and is said to have put into the pocket of the young authors some 24,000 francs. Continuing to work together in opposition to the government of Charles X., and in the interest of Napoleonic ideas, they put forth upwards of 20 pieces of a like satirical cast before 1830. The Revolution of July of that year found B. in prison for an offence done to the government in one of his later publications. His liberation of course was immediate; and along with his friend Méry, he celebrated the victory of the people in a poem dedicated to the Parisians, and entitled *L'Insurrection*, which is characterised by the great critic, M. de Sainte-Beuve, as one of the happiest productions of the writers. A pension of 1200 francs, bestowed on him by Louis-Philippe, did not deter B. from attacking his ministers with the same asperity he had exercised towards those of the dethroned monarch; and in consequence, it was within a year or two withdrawn. During all the changes which followed, B. was indefatigable as a versifier on the political events of the day; but, except for readers intimately versed in the detail of these, the mere list of his numerous productions could have only the very faintest significance. The force and brilliancy of his satire is on all hands admitted; and though, in his later years, his popularity somewhat declined, his writings throughout exercised considerable influence in determining opinion among the lively population of Paris. He was, from the first, a warm supporter of the present Napoleonic régime. His death took place, August 1867, at Marseille, of which city he was librarian.

**BASANTGANJ**, a walled town of India, in the chief-commissionership of Oude, 55 miles north-west from Allahabad. Pop. 6000; of whom one-half are Mussulmans.

**BAUD**, a town of the dep. of Morbihan, France, situated on the Evel, 20 miles north-west from Vannes. Pop. (1872) 1446. B. has some trade in grain, cattle, hemp, butter, and honey. Near B. is a statue of granite, known as the *Venus of Quinsipily*, worthless as a work of art, but remarkable on

## BAUPETTAH—BEET-ROOT SUGAR.

account of its history. Its origin is unknown, but it is supposed, from its Egyptian character, to be a Gallic *Isis*. Down to the 17th c. it was worshipped with foul rites, and even now is regarded with superstitious veneration by the peasantry. It appears to have been first called *Venus* in inscriptions on the pedestal set up in 1689.

**BAUPE'TTAH**, a town of British India, in the presidency of Madras, 29 miles from Guntoor. Pop. supposed to be about 20,000.

**BAYAMO**, or **SAN SALVADOR**, a town in the eastern part of the island of Cuba, 60 miles north-west from Santiago. It is situated in an unhealthy plain, near the left bank of the Canto, a small river which falls into an arm of the sea called the Canal of Bayamo. The town carries on a considerable trade. Pop. about 7500.

**BEAUREGARD**, **PETER GUSTAVE TOUSSAINT**, a general of the army of the Confederate States of America during the War of Secession, was born of a family of Canadian French descent, on his father's plantation, near New Orleans, Louisiana, about 1817. He graduated at the military college of West Point in 1838; was appointed to the artillery, and transferred to the engineers; won his brevet of captain at the battles of Contreras and Churubusco, in Mexico, and of major at Chepul-tepec, where he was twice wounded. After the Mexican war, he was engaged upon the fortifications on the coast of the Gulf of Mexico, and was, for a few days in February 1861, superintendent of the military academy at West Point. At the secession of Louisiana, he resigned, February 20, 1861, and was appointed by the Confederate government to the command at Charleston, South Carolina, where, April 11, he commenced the war by the bombardment of Fort Sumter (q. v.). July 21, he won the battle of Bull Run. March 5, 1862, he took command of the Army of the Mississippi, under General A. S. Johnston, and on April 6, fought the battle of Shiloh—on the first day a victory, and on the second, when the Federals had been reinforced, a partial defeat to the Confederates, with the loss of General Johnston. After holding General Halleck in check for two months, he was obliged, by his failing health, to retire for a time from active service; but in 1863 defended Charleston; and in 1864 commanding at Petersburg, aided General Lee in the long and gallant defence of Richmond, the capture of which closed the war. He has since been President of the New Orleans and Mississippi Railway; and in 1866, in the interests of the Company, he visited New York, London, and Paris, being everywhere received with the highest distinction. He has also been in the service of the Khedive of Egypt.

**BE'CSÉ**, **NEW**, a market-town of Austria, about four miles east from Old Bessa. Pop. 6472.

**BECSÉ**, **OLD**, a market-town of the Austrian Empire, in the Servian Woiwodschaft, 24 miles north-north-east from Neusatz. Pop. 11,222.

**BEDNORE**, or **NUGGUR**, a decayed city of Mysore, India, situated in the midst of a basin in a rugged tableland of the Western Ghats, at an elevation of more than 4000 feet above the sea, in N. lat. 13° 50', E. long. 75° 6', 150 miles north-west from Seringapatam. It was at one time the seat of government of a rajah, and its pop. exceeded 100,000. In 1763, it was taken by Hyder Ali, who pillaged it of property to the estimated value of £12,000,000, and subsequently made it the seat of his own government, calling it Hydernuggur (Hyder's Town), of which the name Nuggur is an abridgment. It was taken by the British under General Matthews in 1783, but soon retaken

by Tippeco, at the head of a vastly superior force, when General Matthews and all the principal British officers were put to death. The neighbouring country is mostly covered with dense and luxuriant forests.

**BED-SORES** are often a very troublesome complication of disease, to which a patient is liable when for a long time confined to bed, and is either unable or is not allowed to change his position. Thus they are liable to occur in cases of continued fever, or any other prolonged debilitating disorder, in paralysis from injury of the spinal cord, and in cases of fracture of the thigh. The skin, at certain projecting bony parts, chiefly about the region of the buttocks, or on the heel, is apt to inflame, ulcerate, and slough, especially if the patient is not kept perfectly clean—as, for example, when the evacuations and urine escape involuntarily. The patient sometimes complains of a sense of discomfort at the parts, as if he were lying on dry crumbs of bread; at other times, he seems to feel nothing. Hence, in all cases of prolonged supine position, the parts naturally pressed upon by the weight of the body should be carefully examined every day or two, as prevention is far easier than cure. When a long confinement to bed is expected, attempts should be made to thicken the cuticle, and enable it to bear pressure better, by rubbing the skin with a stimulant such as spirits or eau-de-Cologne. If the part, when first seen, looks red and rough, further damage is often prevented by covering it with a piece of calico, on which soap-plaster has been spread; the local pressure may be removed by air-cushions specially constructed for cases of this kind, and in many instances, Arnott's Water-bed (q. v.) affords great comfort. If the case is one in which it is admissible, the patient should be made to alter his position frequently. When there are excoriations, and a threatening of sloughing, a poultice composed of equal parts of bread-crumbs and of finely-grated mutton suet, mixed over the fire in a saucepan, with a little boiling water, is often a comforting and useful application. After sloughing has fairly begun, stimulating applications, such as resin ointment, must be applied. It is worthy of notice, that bed-sores come on earlier in cases of fractured spine than in any other; they generally appear by the fourth day, and have been seen two days after the accident. They commonly form one of the most powerful agents in destroying life in cases of this accident, diseases of the urinary organs being the other.

**BEET-ROOT SUGAR**. Recent statistics of this manufacture afford the following results. Within the German empire there were, in 1872, 311 beet-root sugar-mills, producing near 140,000 tons of sugar. In 1863 there were in Austria 136 sugar-mills (the greater number in Bohemia); in 1873 no less than 233. In the former year 70,000 tons of sugar were made. The last statement of Russian industries gave the number of sugar-mills at 209, producing about 110,000 tons of sugar. Belgium has over 100 mills. In 1873 France had 528, and in 1872—1873 its production amounted to 418,000 tons; while the whole of Europe produced 1,100,000 tons. At a time (1869) when the French produce was 280,000 tons, there were 470 beet-sugar manufactories in that country; and the payment in salaries and wages amounted to £2,000,000. In the spring of 1870, the French growers estimated that the beet crop for the year would be worth £10,000,000 to the makers; made up of £7,700,000 sugar, £750,000 pulp for fodder and manure, £1,600,000 spirits, £250,000 potash; but the war interfered with the realisation of this estimate. There are supposed to be now about 2000 beet-sugar manufactories in all

countries. The beet is more precarious than the cane, both in the production of plant per acre of land, and of sugar per ton of plant. A good yield is said to be 20 tons of root per acre, and one ton sugar from 12 tons root; but sometimes there is the far lower estimate of 1000 lbs. sugar per acre, seeing that clumsy processes as well as bad seasons limit the yield. The United States began the beet-sugar manufacture in 1862; the civil war interrupted it; but it is now carried on to a considerable extent and with encouraging success in California. The attempts to make beet-sugar a profitable manufacture in Ireland, have never met with much success, although often renewed. Were it not that English land is so very valuable, this branch of industry would probably have taken root among us. A beet-sugar factory was established at Lavenham, in Suffolk, in 1868, but it has had only slight success.

The distilling of spirits from beet has not been so successful as the making of sugar. It received a temporary impetus from the Reports of the Paris Exhibition in 1855; but there has always been a difficulty in making the residue available as cattle-food; but these and all other attempts in England have failed in this very interesting manufacture. A new distillery was established at Lincoln in 1858, for obtaining spirit from beet and man-gold-wurzel; and a new mode of applying the residue (half a ton from every ton of root) as cattle-food. The Commissioners of Inland Revenue said in 1864: 'After patiently watching these experimental distilleries for seven years, we are relieved from further anxiety on the subject by the final relinquishment of the manufacture by the last of those gentlemen who had embarked in the undertaking. We understand that in all these cases the experiment has entirely failed as a commercial speculation.'

As to its uses in other ways, Payen recommends the mixture of beet farina with flour, in the proportion of 1 to 2, for bread, which he says makes and bakes well, and keeps good for five days. Beet has been made into a kind of pasteboard or papier-mâché, in Haute Marne, for tea-trays and ornaments. Beet coffee, or *betterave torréfiée*, mixed with an equal weight of West India coffee, is used to some extent in France, as being less heating, and requiring less sugar than the latter singly.

**BELJURIE**, or **BAILJURIE**, a town of India, in the British district of Moradabad, North-west Provinces, two miles north-west from Kashipur. Pop. (1871), including part of Kashipur, 8253.

**BELLEVILLE**, chief town of the county of Hastings, Ontario, Canada, situated on the Bay of Quinté, Lake Ontario, and on the Grand Trunk Railway of Canada, 48 m. W. from Kingston. It is a very thriving town. Here are several iron-foundries, manufactories, and saw-mills. Pop. (1871) 7305.

**BELLOWS**. See **BLOWING-MACHINES**.

**BELLUR**, a large town in the territory of Mysore, India, 40 miles north from Seringapatam, with a fort, which has a strong mud rampart and ditch. The town itself was formerly protected by a similar rampart, which is now ruinous.—Another town of the same name, also in Mysore, is situated 60 miles west-north-west from this, a mile from the west bank of the river Yagachi, or Bhadri, one of the head-waters of the Cavery.

**BELOIT**, a city of Wisconsin, U. S., on Rock River, on the Southern State Railway, 75 miles south-west of Milwaukee, built on two plains, one 70 feet above the other, with broad shaded streets, groves, and handsome residences. It has a college, 9 fine churches, several flour and paper mills, foundries,

and manufactories of agricultural implements, &c. Pop. (1870) 4396.

**BELPASSO**, a town of Sicily, on the lower part of the southern slope of Mount Etna, in the province and 8 miles north-west from the town of Catania. Pop. about 7500. Below the town is an expanse of brown lava, but the surrounding country is generally rich and fruitful. A town called Mel Passo, from the abundance of honey in its neighbourhood, stood not far from the site of the present town, but was destroyed by an eruption in 1669; when the inhabitants removed to a locality a few miles off, in the plain, and built a town of which the desolate remains are still to be seen, bearing the name of *Belpasso Vecchio*; malaria compelled them to leave it, and to return to the mountain-slope, notwithstanding its occasional dangers.

**BELPER**, a market-town of Derbyshire, England, on the Derwent; a station on the North Midland Railway, seven miles north from Derby. It is well built, in great part of gritstone, which is obtained in the neighbourhood. One of the most conspicuous public buildings is a church, of recent erection, on an eminence above the town; the union workhouse is also worthy of notice, being a splendid building in the Elizabethan style of architecture. B. is, to a considerable extent, a town of recent growth, and owes its prosperity to the establishment of cotton-works here by Messrs Strutt, one of whom was elevated to the peerage as Lord Belper. In these works, a very great number of operatives are employed. The manufacture of silk and cotton hosiery is also largely carried on in B. Nail-making and the manufacture of brown earthenware also give employment to many of the inhabitants. The surrounding country is rich in coal, iron, lead, and limestone. B. was at one time the residence of John of Gaunt, part of whose mansion still remains. Pop. (1871) 8527.

**BENAVENTÉ**, a town of Spain, in the province of Zamora. It is situated on the western or right bank of the Esla, opposite to the mouth of the Ces, 34 miles north from Zamora. It is overlooked by a huge half-ruined castle, and surrounded by a decayed mud-wall, in which are six gates. It has spacious streets and squares, six churches, a number of schools, three hospitals, a bishop's palace, &c. The castle was formerly the seat of the family of Pimentel, Counts of Benavente, to whose progenitor it was granted in 1394. The interior of the castle was desolated by Soult, on his retreat from Oporto, and fragments of sculpture still lie scattered about. It was at B. that Moore's retreat commenced, 28th December 1809; and it was the scene of other interesting events of the Peninsular War. B. is now a dull and poverty-stricken place, built chiefly of mud cottages. Pop. 2500. There is no bridge at Benavente. The Esla is crossed by a ferry-boat.

**BENEDICT BISCOP**, an English ecclesiastic of the 7th c., who exercised a most important influence on Anglo-Saxon civilisation and learning. He was born about the year 629, of a noble Northumbrian family (his patronymic, according to Eddius, being Baducing), and until about his 25th year, was a courtier of Oswin, king of Northumberland. About that time, he gave up his court-life, and accompanied Wilfred to Rome (654), where he spent about ten years in study, and from which he seems to have returned soon after the synod of Whitby in 664. In 665, he was in Rome a second time, being sent on a mission by Alchfrid, king of Northumbria. After a stay at Rome of a few months, he proceeded to Lerins, in Provence, where he became a monk, received the tonsure, and spent

about two years, thus acquiring a knowledge of monastic discipline. He returned to Rome in 668, came to England with Theodore and Adrian, and was made abbot of the monastery of St Peter (afterwards that of St Augustine) in Canterbury. This he resigned two years after, and went to Rome for a third time, for the purpose of bringing home the literary treasures which he had already collected. He returned about 673, bringing with him a large collection of valuable books, and repaired to Northumbria, where King Egfrid gave him land near the mouth of the Wear, on which he founded the famous monastery of Wearmouth. Workmen were brought from France to build and glaze the church and monastery, this being one of the earliest instances of the use of glass for windows in England. He also introduced from Gaul and Rome (which he visited again in 678) church utensils and vestments, relics, pictures, images, and again a vast number of books. He also brought with him John, arch-chancellor of St Peter's, who introduced the Roman choral service. On his return from this visit to Rome, King Egfrid presented him with more land on the other side of the Wear, at a place called Girwi, on which he built a second monastery, dependent on Wearmouth. B. made his fifth and last journey to Rome in 685, and, as on former occasions, came home loaded with books and pictures, bringing with him also, according to Bede, two silk palls 'of incomparable workmanship.' Shortly after his return from Rome, about 687, he was seized with palsy, under which he languished three years, dying on the 12th January 690. During his long illness, he often anxiously exhorted his monks to look carefully after his books, and preserve them from loss or injury.

The benefits conferred by B. on Anglo-Saxon civilisation, which was then only in its dawn, and the impulse given by his labours to Anglo-Saxon learning, were greater than can now be estimated. It is not certain that he wrote any books, and those ascribed to him are of little value; but by his personal teaching, and especially by his founding at Wearmouth such a valuable and, for the time, extensive library, he implanted in the nation a taste for literature and learning, which soon was fruitful in results, and continued to be so for many centuries. Bede, who was his pupil, has written a life of B., and the numerous works of this 'venerable' author are the best proof of the extent and variety of information to which he had access in the monastery of Wearmouth.—See Wright's *Biographia Britannica Literaria*.

BENEDICT, SIR JULIUS, a musician and composer, German by birth, but, since 1836, resident in England. He was born at Stuttgart in 1805, and studied first under Hummel at Weimar, and afterwards under Weber at Dresden. On Weber's recommendation, he was, in 1824, made music director of the Kärnthner Thor Theatre, Vienna; and he afterwards filled the same post in Naples. While in Naples, he produced an opera buffa called *Gracinta ed Ernesto*, and an opera seria, *I Portogesi a Goa*. In Paris, and afterwards (1835) in London, he appeared with great success as a pianist. In 1836, he took up his permanent residence in London, and was, during that year, director of the opera buffa at the Lyceum, where he produced an operetta of his own, composed in Naples, *Un Anno ed un Giorno*. Turning his attention afterwards to English opera, he composed *The Gipsy's Warning* (1838), *The Brides of Venice* (1844), and *The Crusaders* (1846), three works which, translated into German, have been well received in the composer's native country. He conducted the opera in Covent Garden Theatre in 1843 and 1844, and the Norwich

Musical Festival in 1845, and has since conducted much at concerts and great musical gatherings in London and in the provinces, besides being a successful pianoforte teacher. In 1850, he conducted at Mademoiselle Jenny Lind's concerts in America. In 1860, he produced a cantata, *Undine*, at the Norwich Musical Festival, which was very well received. His *Lily of Killarney*, first given in 1862, at Covent Garden, was his greatest operatic success. He has since produced a cantata, *Richard Cœur de Lion*; an opera di camera, *The Bride of Song*; a romantic opera, *Emeralda*; and a cantata, *St Cecilia*. His operas have much dramatic and melodic beauty, and in style and feeling are singularly English, to be the composition of a foreigner. His oratorio, *St Peter*, written for the Birmingham Musical Festival, 1870, met with extraordinary success. Knighthood was conferred on B. in 1871. His songs and minor works are numerous.

BÉPŪR, or BEYPORE, a seaport of India, on the western coast, six miles south from Calicut, at the north side of the estuary of a small river which rises in the Western Ghats. Its situation is very beautiful. It has a considerable trade in timber, particularly teak, which is floated down the river for exportation. Iron ore is found in the neighbourhood, and iron-works have recently been established here. B. is the terminus of a railway across the peninsula of India from Madras by way of Coimbatore, and will probably soon become a place of great importance. Pop in 1871, 5858.

BERCETO, a town of Italy, in the province and 25 miles south-west from the city of Parma, beautifully situated amongst the Apennines. It is a clean, well-built town. The church is an old Gothic building. The mountains rise rapidly to the west of B., and some of the scenery which they present is very wild and desolate.

BERGA, a town of Catalonia, Spain, situated near the river Lobregat, 52 miles north-north-west from Barcelons. Its streets are paved, but mostly narrow and crooked. It has five squares, three churches, several convents, a hospital, schools, &c. It is overlooked and defended by a castle with a strong battery. Pop. 6333, mostly employed in husbandry and as muleteers; the produce of the fields, vineyards, and olive-yards of the neighbourhood giving rise to a considerable trade. Cotton fabrics are also manufactured in B., and this branch of industry is on the increase.

BERGEDORF, a town of Germany, 10 miles east-south-east from Hamburg. When Lübeck joined the Zollverein in 1868, it resigned to Hamburg, on payment of 200,000 thalers, its share in the government of B., and its small territory. Pop. of territory above 12,000. Part of this territory is known by the name of the Four Lands (*Vierländer*). It is inhabited by a well-conditioned and industrious population, much occupied in the cultivation of fruit and vegetables, not only for the market of Hamburg, but for that of London. Peach and apricot orchards, and fields of strawberries, extend over great part of the district. Cattle-husbandry is also carried on, and much attention is devoted to the rearing of poultry. The people of the Four Lands are distinguished from their neighbours by peculiarity of dress, and even each of the four small communities from which the name has been derived has some distinguishing peculiarity of its own.

BERI, a town of India, in the British district of Rohtuck, Punjab, in N. lat. 28° 40', E. long. 76° 40', 36 miles west-by-north from Delhi. Pop. (1868) 9723.

**BERKHAMSTEAD, GREAT, OF BERKHAMSTEAD ST PETER'S**, a market-town of Hertfordshire, England, situated in a deep valley, on the right bank of the small river Bulbourn, on the Grand Junction Canal and the London and North-western Railway, 28 miles north-west from London. The main street is about a mile in length. The town is well built, mostly of brick. The parish church, a cruciform building in the centre of the town, is chiefly in the Perpendicular style. The father of the poet Cowper was rector of B., and the poet himself was born here. The town is supposed to be of Saxon origin, and the kings of Mercia had a palace or castle here. William the Conqueror met the nobles and prelates at B., and took an oath to rule according to the ancient laws and customs of the country. He bestowed the castle and manor of B. on his half-brother, the Earl of Moreton. The castle was rebuilt in the reign of King John. The property having reverted to the crown, was bestowed by Edward III. on his son, the Black Prince, when he created him Duke of Cornwall, and has since been held by the Princes of Wales as Dukes of Cornwall. A few massive fragments of the wall of the castle still remain, to the east of the town. A free grammar-school was founded in the reign of Edward III., and still subsists, having been lately much enlarged and enriched by the establishment of several exhibitions. A charity-school was founded under the will of Thomas Bourne in 1727. Straw-plaiting is carried on to a considerable extent in B., and a vast number of wooden articles are made, as bowls, cricket-bats, hoops, toys, &c. There are extensive chemical works, and a considerable trade in timber, malt, and coals. There is a weekly corn-market. Pop. (1871) 4083.

**BERNALDA**, a town of South Italy, in the province of Potenza, 32 miles west-by-south from Saranto. Pop. about 6000.

**BERNARD, CLAUDE**, a distinguished physiologist, was born at Saint-Julien, near Villefranche, in the dep. of the Rhone, on the 12th July 1813. He studied medicine at Paris; was admitted in 1839 as a pensioner in one of the hospitals; and in 1841, became Magendie's assistant at the College of France. He graduated in 1843 as Doctor in Medicine, and ten years later, as Doctor in Science; and was appointed in February 1854, to the chair of General Physiology in connection with the Faculty of Sciences in Paris. The same year, he was chosen member of the Academy of Sciences; and in 1855, he succeeded Magendie as Professor of Experimental Physiology in the College of France. B.'s first researches were devoted to the physiological action of the various secretions of the alimentary canal. His Memoir, published in 1844, in the *Gazette Medicale*, treats of the mechanism by which the gastric juice is secreted, and also of the modifications which alimentary substances undergo from that liquid. To the *Comptes Rendus* of the Biological Society he also contributed papers on the Saliva, on the Intestinal Juice, on the Influence of the Different Pairs of Nerves on the Digestive Apparatus, and on the Respiratory and Circulatory Systems. His first really original paper, however, was that on the Function of the Pancreas, in which he demonstrated that that viscus is the true agent of the digestion of fatty bodies. This essay obtained, in 1849, the grand prize in experimental physiology, and was printed in the *Comptes Rendus* of the Academy of Sciences in 1856. In 1849, appeared his first researches on the Glycogenic Function of the Liver, establishing the doctrine, that the blood which enters the liver does not contain sugar; while blood which leaves that organ, and goes to the heart by the hepatic veins, is charged

with it. He also shewed the influence of the nervous system on this function, and produced artificial diabetes by division of the pneumogastric. For this discovery, which was keenly criticised, but is now regarded as sound, he obtained, in 1851, the grand prize in experimental physiology. In 1852, he laid before the Institute his Experimental Researches on the great Sympathetic System, and on the Influence exerted by Division of this nerve on the Animal Heat. This paper procured him, for the third time, the prize of experimental physiology in 1853. Since 1854, when he succeeded Roux as Member of the Institute, he has continued his researches on the glycogenic function of the liver, and has also published his courses of lectures at the College of France, on *Experimental Physiology in its Application to Medicine* (1855—1856); on *The Effects of Toxic and Medicated Substances* (1857); on *The Physiology and Pathology of the Nervous System* (1858); on *The Physiological Properties and the Pathological Alterations of the various Liquids of the Organism* (1859); on *Nutrition and Development* (1860); and his *Introduction to the Study of Experimental Medicine* (1865). In 1861, he was elected Member of the Academy of Medicine; on the 31st July 1862, he became Officer of the Legion of Honour; in 1867, Commander; and in 1869 he was made a member of the Academy.

**BERNAY**, a town of France, in the dep. of Eure, pleasantly situated on the right bank of the Charentonne, 26 miles west-north-west of Evreux. Pop. (1872) 5696. Woollen, linen, and cotton manufactures are actively carried on, also paper-making, bleaching, dyeing, and tanning. There is a considerable trade not only in the products of these manufactures, but in grain, cider, horses, and cattle. B. is the seat of the greatest horse-fair in France, which is held in Lent, and is attended by nearly 50,000 persons, who congregate from all parts of France, chiefly to purchase post and diligence horses, for which Normandy has long been celebrated. B. is the seat of a tribunal of commerce. The church of St Croix has a large and magnificent altar, and marble statues and sculptures: the church of La Conture was formerly celebrated for the cure of persons possessed of evil spirits. The grain-market occupies part of the remains of an interesting old abbey church. B. has a communal college, and a hospital.

**BERTINO'RO**, a town of Italy, in the province of Forli, formerly belonging to the Papal States, six miles south-east from Forli, pleasantly situated on a hill, the slopes of which are famous for their wines. At the foot of the hill, to the west, flows the Ronco. B. is the seat of a bishop, and has a cathedral, three other churches, and five convents. It was one of the ancient fiefs of the Malatesta, by whom it was given to the church. Pop. of commune 6388.

**BESSÈGES**, a large and thriving village of France, in the north of the dep. of Gard, 11 miles north from Alais. It is situated on the river Cèze. A railway connects B. with Alais. There are extensive coal-mines in the neighbourhood. Pop. (1872) 8036.

**BESSENOVA**, a large village of the Austrian empire, in the Woivodina, on the north bank of the Aranka, eight miles west-south-west from St Miklos. Pop. 7896.

**BETHLEN-GABOR** (or, as he would be called in Western Europe, GABRIEL BETHLEHEM or BETHLEHEM, it being a common custom in Hungary and Transylvania to make the baptismal follow the family name) was descended from an ancient and distinguished Protestant family of Upper Hungary,

which also possessed important estates in Transylvania, and was born in 1580. He rose to prominence during the troubles which distracted the principality in the reigns of the two Bathories, Sigismund and Gabriel; and on the death of the latter of these unfortunate princes, succeeded (1613), by the aid of the sultan, in being chosen sovereign prince of Transylvania, the House of Austria being at that time in no condition to offer effective opposition. In 1619, when the Bohemians rose in defence of their religious and political rights, they looked eagerly for support to B., who had already gained a wide reputation as a warrior and a champion of Protestantism; and the Transylvanian prince, too glad of such an opportunity to gratify his ambition at the expense of his enemy, Austria, eagerly proffered his support. He accordingly marched into Hungary, took Kaschau, his advance more resembling a triumphal procession than a hostile invasion, and on arriving under the walls of Presburg was greeted with every mark of joy by the citizens. With an army now swelled by Hungarian volunteers to nearly 100,000 men, he pursued his route towards Vienna, driving before him the Spaniards under Bucquoy, and the Austrians under Dampierre; and would doubtless have captured the capital, had not the severity of the season, and the want of provisions, combined with the reinforcement of his opponents, and the defeat of his lieutenant, Ragotski, in Hungary, compelled him to retreat for a time. However, though he retired as far as Kaschau, he did not relinquish his hold of Hungary, of which, by the assembled diet, he had been crowned king at Presburg, 25th August 1620; but, resuming the offensive, on the defeat and death of Bucquoy, before Neuhausel, he recovered the fortresses which the imperialists had retaken, and spread terror and devastation to the gates of Vienna. His allies, the Protestants of Germany, being apparently crushed, B. concluded peace with Ferdinand II., receiving the town of Kaschau, with seven Hungarian counties adjoining Transylvania, the principalities of Oepeln and Ratibor in Silesia, and the dignity of prince of the empire. This treaty, however, was soon broken by the emperor, who thought so favourably of his own situation as to imagine he could violate his agreement with impunity; but he was soon undeceived, for B. raising an army of 60,000 men, invaded Moravia, obtained the solemn renewal of the former treaty, and then retreated homewards. His marriage with Catharine of Brandenburg in 1625 involved him once more in the Thirty Years' War; but he finally retired from the contest in the following year, and thenceforth devoted himself exclusively to the internal affairs of Transylvania. He died in 1629, after a lingering and painful illness. B.'s reign was a glorious and flourishing epoch in the history of the little principality; for not only did the great successes achieved through his military talents give a prestige to its arms, but his protection of science and letters, in both of which he was well accomplished, did much to aid the progress of learning. He founded the Academy of Weissenburg at Karlsburg, and installed there, as professors, Opitz, Alstedt, Biesterfeld, and Piscator.—His brother STEPHEN succeeded him, but was soon compelled to resign the throne.—To the same family of Bethlen belong JOHN and WOLFGANG, both Chancellors of Transylvania, the former of whom is celebrated for his work *Reverus Transylvanicarum, libri iv.* (Hermannstadt, 1683), which gives the history of the principality from 1629 to 1663; and the latter of whom wrote a History in 16 books, the MS. of which, from long neglect, had been much damaged, but which was afterwards restored and completed, and published

(6 vols.) at Hermannstadt in 1792, under the title of *Wolfgangi de Bethlen Historia de Rebus Transylvanicis* (1526—1609).

BEUST, FRIEDRICH FERDINAND FRIEDRICH VON, German statesman, one of the most prominent modern politicians. His family is of old nobility, distinguished both in the field and the cabinet. B. was born on 13th January 1809, at Dresden, and after a careful preliminary education in Dresden, he attended the universities of Göttingen and Leipzig. Having conceived early a liking for politics, he devoted himself to diplomacy. After spending some time in travel (1834—1835), he served as secretary of embassy, first in Berlin, and then in Paris. In 1838, he represented his government at Munich, where he began to shew his diplomatic talents, and soon acquired a certain celebrity. Eight years later, he went to London in the same character, from which he was removed in 1848 to Berlin. When called back to Dresden in 1849, he received the portfolio of Foreign Affairs. In this office, he declared against the adoption of the new constitution for the German Empire, and when thereupon an insurrection broke out in Dresden, he called in the assistance of Prussian military, which speedily crushed it. A few years later, he was made Minister of the Interior. On the death of Frederick VII. of Denmark (1863), B. came forward prominently as the exponent of the German national feeling on the Slesvig-Holstein question. In the name of his government, he disavowed the London protocol, and urged a policy favourable to the wishes of the Duchies, and in harmony with the national feeling of Germany. And, indeed, so prominent and popular did he become at this time, that he was sent as representative of the German Bund (the first that ever was sent) to the London Conference, where he stood his ground firmly, taking for his basis the principle of nationalities. Always the friend of Austria, he naturally supported that country in the crisis of 1866, joining in the declaration of war against Prussia, against the wishes of at least the liberal party in Saxony. After the termination of the 'six weeks' war,' he was obliged, at the demand of Prussia, to resign his office. He has since entered the service of Austria, and risen to the head of affairs. The chief result of his policy in the reorganisation of the empire is the reconciliation of Hungary (1867) on the footing of its remaining a separate kingdom. See GERMANY, in SUPP., Vol. X. In 1871, he resigned the office of Chancellor, and was appointed ambassador at the court of St James's.

BEUTHEN, or BÜTOM, a town of Prussian Silesia, the capital of a circle of the same name, in the government of Oepeln, and 50 miles south-east from Oepeln, near the Polish frontier. It has manufactures of woollen cloths and earthenware. The language generally spoken is Polish. Pop. (1871) 17,946.

BEZDAN, a market-town of the Austrian empire, in the Hungarian province of Bacs, about three miles east of the Danube, and 12 miles west-north-west from Zombor. Pop. (1869) 7573.

BHADARSA, a town of British India, in the chief-commissionership of Oude, on the Tons, 75 miles east from Lucknow. Pop. 5000, of whom 2000 are Mussulmans. Here is an eleemosynary establishment, founded by the Nawab Vizier Asaf ud Dowlah, with an endowment of 15,000 rupees a year, the proceeds of which are divided indiscriminately among Mussulman and Hindu religious mendicants. It is under the charge of a Seiad, or descendant of Fatima.

BHANPURA. See BAMPURA.

BHATGONG, one of the chief towns of Nepal,



situated about 9 miles south-east from Khatmandu. It contains a palace of striking appearance, and other notable buildings. It is the favourite residence of the Brahmans of Nepal, who form the greater part of its inhabitants. Its present pop. is estimated at 12,000, but it is supposed to have once contained 60,000 inhabitants.

**BHOWAN, BHOWANY, BHEWANNEE, or BHIWANI**, a town of British India, in the district of Hissar, Punjab, 55 miles west of Delhi. The pop. in 1868 was 32,254.

**BHU'JI, or BIJI**, a small hill-state of India, extending for about 20 miles along the left bank of the Sutlej, and about 7 miles at its greatest breadth. Its pop. is about 20,000. Having been overrun by the Goorkhas, it was, on their expulsion, bestowed by the British government on the present family.

**BIANA**, a town of India, in the Rajpoot state Bhurtpore. It was once a place of much greater importance than it now is, and was one of the most famous forts in India. The town contains many temples, and the whole ridge of the hill is covered with the remains of large buildings. A high pillar of stone called *Bhim Lat*, or the *Staff of Bhim*, is conspicuous over a wide extent of country.

**BICYCLE**, a form of velocipede or lightly-built wheeled vehicle propelled by the person who occupies it. The bicycle, as its name (from Gr. *bis*, twice, and *kyklos*, wheel) imports, has but two wheels; and as these are placed in line one behind the other, the machine acquires and retains its stability in the erect position only in motion. The front wheel of the bicycle is generally about twice as high as that behind, and may be as much as 60 inches in diameter. The two wheels are connected by a 'backbone' which rests in front on a forked bar rising perpendicularly from the axle of the front wheel. The rider, sitting on a saddle fixed to the backbone, moves the bicycle with his feet by means of cranks attached to the axle of the front or driving wheel, and steers by help of a cross-handle affixed to the erect bar. The bicyclist may without undue exertion, attain a pace of 9, 10, or more miles an hour, and can sustain this pace for many hours. As much as 106 miles have been accomplished in less than eight hours. The whole machine, though now made almost wholly of steel and iron, need not weigh more than 50 pounds. The earliest form of bicycle introduced from France about 1820, had two heavy wooden wheels of the same size, and was driven by the rider striking his feet on the ground.

**BIJAPORE**, a town of India, in Guzerat, in the Guicowar's territory, on the route from Mhow to Deesa, 200 miles north-west from Mhow, and 60 miles south-east from Deesa. Pop. 12,000.

**BIJAWUR**, a petty native state in the Bundelcund Agency, with an area of 920 sq. miles, and a pop. of 102,000.

**BIJNO'UR**, a town of India, the chief town of the British district of the same name, North-west Provinces, in 29° 22' N. lat., 78° 11' E. long. It is on the route from Moradabad to Mozuffurnuggur, 31 miles east from Mozuffurnuggur. Pop. (1871) 12,566.—The district of Bijour has an area of 1884 sq. m., and a pop. (1871) of 737,152.

**BIKAN'IR, or BEEKANEER**, a town of India, the capital of a Rajpoot state of the same name, in N. lat. 28°, E. long. 73° 22'. It is situated in a singularly desolate tract, hard, stony, and utterly unfit for cultivation. The town is surrounded with a battlemented wall, and has a very imposing appearance. The pop. is estimated at 60,000.—The state of Bikanir extends from north to south about

160 miles, and from east to west about 200 miles. Its area is 24,000 sq. miles. The climate is remarkable for extreme changes of temperature, the temperature during the night being often very cold, whilst the day is very hot. Ice is often formed on ponds in winter during the night, whilst the summer heat during the day sometimes reaches 123° Fahr. The majority of the population are by descent Jants, a people inhabiting from a very remote period a great extent of country between the Himalaya and the Indian Ocean. The rajah and dominant race are Rajpoots. Brahmans are numerous, but if they do not eat, they trade in oxen. There are many Jains. The burning of widows was in former times extremely prevalent in Bikanir. One corpse is said to have been burned with 84 victims. The annual revenue of the state is about £65,000. The military force amounts to about 6000. The pop. is about 300,000.

**BYLSA, or BHILSA**, a town of India, in Malwa, in the territory of Gwalior, Scindia's dominions, on the right bank of the Betwa, 188 miles south from Gwalior, and 32 miles north-east from Bhopal. It is situated on an elevated mass of trap rock, and has a fort enclosed by a stone wall, and furnished with square towers and a ditch. Outside the walls, are some spacious streets, and many good houses. B. was taken from the Hindus by Samsuddin Altamsh, sovereign of Delhi, in 1230; and after several times changing hands between Hindu and Mussulman masters, was finally incorporated with the empire of Delhi by Akbar in 1570. The pop. is about 30,000. B. and the pergunnah of which it is the capital, are said to yield a revenue of 325,000 rupees. The finest tobacco produced in India is from a small piece of land, about three acres, near Bilsa. Its superiority is said to be entirely owing to careful cultivation. There is at B. a brass cannon, of beautiful workmanship, said to have been made by order of Jehangir, 19½ feet in length, with a bore of 10 inches.

**BI'MAH**, a river of India, a branch of the Kistnah (q. v.), rises in the table-land of the district of Poona, in the presidency of Bombay, at an elevation of 3090 feet above the level of the sea, and following in a south-eastward direction, falls into the Kistna, in N. lat. 16° 24', E. long. 77° 20', after a course of more than 500 miles.

**BINO'NDU**, a town of the island of Luzon, Philippines, on the right bank of the Pasig, opposite to Manila, with which it is connected by a magnificent stone bridge, 411 feet in length. This bridge is regarded as the greatest structure erected by Europeans in the East. B. is chiefly inhabited by natives of the Philippines, but is also the residence of some Europeans. It is the seat of government of the province of Tondo. Pop. 29,200.

**BIO'RNEBORG**, a seaport town of Finland, on the Gulf of Bothnia, at the mouth of the Kumo, 76 miles north-north-west from Abo. Pop. (1867) 7270. Shipbuilding is carried on. Timber, pitch, and tar are the principal exports.

**BIRCH, SAMUEL**, keeper of the Oriental Antiquities in the British Museum, is a son of the late Rev. S. Birch, rector of St Mary Woolnoth, in the city of London, and was born in London, in the year 1813. B. was educated at Merchant Taylors' School. In 1834, he entered the public service under the Commissioners of Public Records; and in 1836, he obtained the appointment of assistant in the department of Antiquities, British Museum. In this capacity, B. acquired an extensive acquaintance with archaeology in all its branches. He studied not only Greek and Roman antiquities, including numismatic, but applied

himself with untiring zeal to Egyptian hieroglyphics. In process of time, he so distinguished himself in this difficult branch of learning, that he gained the notice of the celebrated Chevalier Bunsen, who gladly availed himself of B.'s knowledge in the philological portion of *Egypt's Place in Universal History*. The chevalier, in his preface, thankfully acknowledged this assistance in the following terms: 'This English edition owes many valuable remarks and additions to my learned friend, Mr Samuel Birch, particularly in the grammatical, lexicographic, and mythological part. That I have been able to make out of the collection of Egyptian roots, printed in the German edition, a complete hieroglyphical dictionary, is owing to him. To him also belong the references to the monumental evidence for the signification of an Egyptian word, wherever the proof exhibited in Champollion's dictionary or grammar is not clear or satisfactory. . . . The work may now be said to contain the only complete Egyptian grammar and dictionary, as well as the only existing collection and interpretation of all the hieroglyphical signs; in short, all that a general scholar wants, to make himself master of the hieroglyphic system, by studying the monuments.' After Bunsen's decease, B. was engaged to prepare for the press and edit the fifth and concluding volume of *Egypt's Place*, a task which he has performed in an admirable manner, giving the results of all the discoveries made by Egyptologists, since the publication of the first volume, in 1848, down to the year 1867. B. has also prepared a second edition of the first volume of *Egypt's Place*, published at the same time as vol. 5, and in which the same care has been taken to make the work correspond with the most recent investigations of hieroglyphic scholars. It was by the particular desire of Bunsen, as expressed on his death-bed, that B. undertook the revision of his work on Egypt. B. is now universally recognised as the foremost Egyptologist in this country. In 1844, upon the retirement of Mr Barnwell from the office of assistant-keeper in the department of Antiquities, B. was appointed his successor. In 1861, upon the retirement of Mr Hawkins from the post of keeper of the Antiquities, that department was divided into three separate and independent departments, viz. the department of Oriental, Medieval, and British Antiquities, and Ethnography; the department of Greek and Roman Antiquities; and the department of Coins and Medals. B. was appointed keeper of the first-named collections; but afterwards, a fourth department was constituted out of these collections, viz. that of British and Medieval Antiquities and Ethnography, at the head of which Mr Franks was placed, the consequence being, that B. is now the keeper only of the Egyptian and Oriental Antiquities. In 1862, B. received the honorary degree of LL.D. from the university of St Andrews. He is a corresponding member of the Institute of France (Académie des Inscriptions et des Belles-Lettres); also of the Academy of Berlin, of the Academy of Herculaneum, and of the Archæological Institute of Rome. B.'s principal publications are as follow: *Gallery of Antiquities selected from the British Museum* by F. Arundale and J. Bonomi, with *Descriptions* by S. Birch (1842); *Views on the Nile, from Cairo to the Second Cataract, drawn on Stone, from Sketches taken by Owen Jones and J. Goury, with Historical Notices of the Monuments* by S. Birch (1843); *Catalogue of Greek and Etruscan Vases in the British Museum* (1851), drawn up in conjunction with Mr Newton; *An Introduction to the Study of the Egyptian Hieroglyphs,*

contributed to Sir J. Gardner Wilkinson's work, *The Egyptians in the Time of the Pharaohs* (1857); *History of Ancient Pottery* (2 vols. 1858); *Description of the Papyrus of Nas-khem, Priest of Amen-ra, discovered in an Excavation made by direction of H.R.H. the Prince of Wales in a Tomb near Gournah at Thebes* (1863); and the *Rhind Papyrus* (1866). Besides his Egyptian and classical labours, B. has also studied Chinese, and in that direction is author of the following brief contributions, viz., *Analecta Sinensia*, short stories from the Chinese (1841); *The Friends till Death*, a tale translated from the Chinese (1845); and *Chinese Romance—The Elfin Faces* (1863). B. has likewise contributed papers to the *Archæologia*, to the *Transactions of the Royal Society of Literature*, the *Revue Archéologique*, the *Archæologische Zeitung*, and the *Zeitschrift für Aegyptische Sprache und Alterthumskunde*. He has also written many articles for the *English Encyclopædia*, principally on subjects connected with Egyptian antiquities and hieroglyphics. In the same class of subjects, he has been a much valued contributor to Chambers's *Encyclopædia*.

BISCEGLIE, a seaport town of Italy, on the Adriatic, in the province of Bari, in the former kingdom of Naples, 21 miles north-west-by-west from Bari. It is built on a rocky promontory, defended by strong fortifications. The port admits only vessels of small burden. B. is a bishop's seat, and has a cathedral, besides two collegiate and several other churches, convents, a seminary, a hospital, &c. Rain-water is collected in public reservoirs, the water-supply being otherwise very insufficient. Pop. (1872) 21,371. Around the town are many fine villas and country-houses. The neighbourhood produces good wine, and has acquired particular celebrity for its currants, which are said to be equal to those of the Ionian Islands. During the Crusades, B. was famous for its hospital, founded by Bohemond, for pilgrims from the Holy Land, of which some ruins still exist.

BISMARCK-SCHOENHAUSEN, OTTO EDUARD LEOPOLD, PRINCE VON, chancellor of the German empire, now the most prominent man in Europe, was born in 1813 at Brandenburg, of an old family, of which various members have gained a reputation both as soldiers and statesmen. B. received his university education at Göttingen, Berlin, and Greifswald, where he studied law. After he had finished his studies, he lived for a time on his estates. Before 1847, he was little heard of, but about that time he began to attract attention in the Prussian parliament as an ultra-royalist, and an advocate of the extreme absolutism. He was one of those who opposed the scheme of a German Empire, proposed by the German parliament of 1849. His diplomatic career commenced in 1851, when he was appointed chief secretary of the Prussian legation, at the resuscitated German diet at Frankfurt. Here he began to manifest that zeal for the interests and aggrandisement of Prussia, which has since undeviatingly guided him, often regardless of the means. In the diet, he gave open expression to the long-felt discontent with the predominance of Austria, and demanded equal rights for Prussia. In St Petersburg, whither he was sent in 1859, he is said to have tried to bring about an alliance between France, Prussia, and Russia, but without success. By this time he had acquired the special regard and confidence of the king, who sent him, in the spring of 1862, as ambassador to Paris, in order to give him an insight into the politics of the Tuileries, before taking the direction of affairs at home. In autumn, when the king's government could not obtain the consent of the

lower house to the new military organisation, B. was recalled, to take the portfolio of the ministry for Foreign Affairs, and the presidency of the cabinet. Not being able to pass the re-organisation bill and the budget, he closed the chambers (October 1862), announcing to the deputies that the king's government would be obliged to do without their sanction. Accordingly, the army reorganisation went on; and the next four sessions of parliament were closed or dissolved in the same way, without the government obtaining, or even caring to obtain, the sanction of the house. The people were now looking for a *coup d'état*, and the government for a revolution. At this crisis, the death of the king of Denmark opened up again the Slesvig-Holstein question, and excited a fever of national German feeling, which B. was adroit enough to work so as to aggrandise Prussia by the acquisition of the Duchies, and reconcile his opponents to his high-handed policy by being able to point to the success of the newly-modelled army. Throughout the events which ended in the humiliation of Austria and the reorganisation of Germany under the leadership of Prussia (see GERMANY IN SUPP., Vol. X.), B. was the guiding spirit; and such is the magic of success, that, from being universally disliked, he has become the most popular man in Germany. What is perhaps still stranger, the man who, of all others living, has been the most strenuous upholder of absolutism, and has all along manifested the strongest contempt for public opinion, received, in 1871, the thanks and congratulations of the extreme democrats of Great Britain for giving to North Germany a constitution based on universal suffrage. It was B. that negotiated the neutralisation of the Luxembourg territory (1867). The action of France in regard to the candidature of Prince Leopold of Hohenzollern for the throne of Spain gave B. the opportunity of carrying into action the intensified feeling of unity amongst Germans. During the war of 1870—1871, B. was the spokesman of Germany; he it was that, in February 1871, dictated the terms of peace to France. He was soon created a prince and chancellor of the German empire. The most striking feature of his administration has been a contest with the Catholic church, in which the expulsion of the Jesuits (July 1872), and the carrying out of the new ecclesiastical laws, were the most prominent events. His life was attempted in 1874. B.'s personal appearance is that of a man of energy; in social life, he is genial and witty; in the discharge of his public duty, earnest and stern; he has shewn himself cool and fearless in battle.

**BISULNUGGUR**, or **BISANAGAR**, a town of India, in Guzerat, in the territories of the Guicowar. It is situated on the route from Mhow to Deesa, 82 miles north-west of Mhow, and 44 miles south-east of Deesa. It has a considerable transit trade, in sending iron and other heavy goods to Marwar. The manufacture of cotton cloths is carried on to a considerable extent. Pop. 18,000.

**BISULPUR**, or **BESULPORE**, a town of India, in the British district of Bareilly, North-west Provinces. It is 24 miles south-east from Bareilly. It has a good bazaar, and is abundantly supplied with water. Pop. (1871) 9006.

**BITTENFELD**, **HERWARTH VON**, a Prussian general, one of the three leaders that commanded the invasion into Bohemia in 1866. B. was born in 1796, and gained his first martial laurels in the War of Liberation, especially in the battle of Leipzig. In the year 1848, he commanded the first regiment of the Guards. In 1863, raised to the rank of general, he acquired great fame through his daring crossing of the Sund, and capture of the isle of Alsen. In

the campaign of 1866, he was intrusted with the occupation of Saxony, and then with the command of the army which advanced from Saxony into Bohemia. He contributed largely to the brilliant victories of Hünnerwasser, Gitschin, Münchengrätz, and Königgrätz. On the outbreak of the war in 1870, B. was made governor of the Rhine provinces; and in the next year he was raised to the rank of general field-marshal. In the war of 1866, one of his sons fell; in that of 1870, two were killed.

**BLA'CKBURN**, an inland town of Lancashire, England, 21 miles north-north-west from Manchester, and 12½ miles by railway east-by-south from Preston. It stands on a stream, from which it appears to derive its name, a branch of the Ribbles. The surrounding district, formerly known as *Blackburnshire*, or *Blagbornshire*, was long very wild and dreary, but is now very populous. Coal and lime abound in it. B. had acquired some importance as a market-town in the 16th century. Its manufacturing prosperity can be traced back at least to the middle of the 17th c., when it was noted for the production of a kind of linsey-woolsey known by the name of *Blackburn Checks*, afterwards superseded by the *Blackburn Grays*, so called from their being printed unbleached. In the course of the 18th c., the cotton manufacture became the chief industry of the town, which is now one of the chief seats of it, the number of cotton factories being very large, and many of them employing from 1000 to 2000 operatives. The value of the calicos and other cotton goods annually produced was estimated some years ago at nearly £2,000,000 sterling, and is now certainly much more. The steam-power employed in the works for spinning and weaving cotton has been more than doubled within the last 20 years. Many improvements in machinery for the cotton manufacture have been made in B., among which the first place in importance as well as in date must be assigned to the invention of the spinning-jenny, by James Hargreaves (q. v.), a native of the town, in 1767. His invention, however, was regarded with so much popular dislike, that he was compelled to remove from the town, and it was not till the beginning of the present c., that it came into general use in the cotton-works of Blackburn. The pop. of B. in 1851 was 46,536; in 1861, 63,126. In 1871, pop. of municipal borough was 76,339; of parl. b., 82,928. A range of hills on the north of the town shelters it from the coldest winds. Many of the streets are spacious, and the town is generally well built. A park of 50 acres, known as the *Corporation Park*, has recently been laid out for public recreation. The most elevated part of this park is about 700 feet above the level of the sea, and commands a very extensive view. The parish church, St Mary's, is a very beautiful Gothic building, erected between 30 and 40 years ago. There are numerous other places of worship, both of the Established Church, and of various denominations of dissenters. The Grammar-school was founded by Queen Elizabeth in 1567; and there are many other educational establishments, and many benevolent and religious institutions. The finest building in the town is the Exchange, built in 1865, in the Gothic style, and containing a magnificent room, 40 yards by 20. The town-hall is also worthy of being mentioned. B. is supplied with water from capacious reservoirs, which have been constructed in the neighbourhood. The Leeds and Liverpool Canal, passing on the south side of the town, affords important facilities for the conveyance of goods; and B. is connected by several railways with all the neighbouring towns, and so with all parts of the kingdom. B. is governed by a mayor, 12 aldermen, and 36 common-councilmen. It sends

## BLACK DEATH—BLOWING-MACHINES.

two members to parliament, a privilege which it obtained under the Reform Bill of 1832.

**BLACK DEATH, THE RECENT,** is the title commonly given to a very fatal disease which occurred in Ireland, in an epidemic form, in the years 1866—1867. It is described under the title of **EPIDEMIC CEREBRAL MENINGITIS**.

**BLACKPOOL,** a flourishing town in the township of Layton-cum-Warbreck, in the county of Lancaster, is now a very considerable place, lying on the coast of the Irish Sea, between the estuaries of the Ribble and the Lune, distant from Poulton-le-Fylde 4 miles, and from Preston 18 miles. The population in 1861 was 3506, and in 1871 it had increased to 6001; but the numbers who resort here during the bathing-season far exceed the permanently resident inhabitants. Upwards of 100,000 visitors annually come from East Lancashire, Manchester, Yorkshire, and other parts of the kingdom. B. is one of the most frequented bathing-places in the west of England, the sands being excellent. It has a branch railway connecting it with the Preston and Wyre Railway, which affords easy access from Preston, Liverpool, Manchester, and all parts of the kingdom. There is also another railway connecting it with Lytham, another favourite bathing-place on the Ribble, about 7 miles to the south. B. has a fine pier, furnishing sitting accommodation to upwards of 3000 persons, which cost about £25,000; and a second, more recently opened, 500 yards in length. There are three established churches, a Roman Catholic chapel, and five other chapels for the Wesleyans, Independents, &c. Besides excellent streets and terraces of houses elegantly built, it has many large hotels (one of which, recently erected, cost upwards of £12,000); there is also a theatre, libraries, news-rooms, &c. There is no trade or manufactures; the lodging-house keepers depend solely on the large concourse of visitors. Fishing is the employment of many during the winter months.

**BLANC, LE,** a town of France, in the dep. of Indre, on the Creuse, 33 miles west-south-west from Châteauroux. It is beautifully situated, and is a neat and well-built town. It was formerly strongly fortified, but the fortifications are dismantled. Its principal industries are the manufacture of coarse woollen cloths, and tanning. Vinegar is also made here; and there is a considerable trade in the wine of the district, and in iron, fish, wood, and pottery. There are several iron-works in the vicinity. Pop. (1872) 4332.

**BLOWING-MACHINES.** The earliest blowing-machine was, doubtless, some form of the common bellows, the idea of which is supposed to have been derived from the lungs. A very primitive form of this instrument is still in use in some Eastern countries, consisting simply of the skin of some animal sewed into a rude bag with a valve and nozzle. The older forms of domestic bellows are all constructed on the same principle—viz., a chamber formed of two boards with flexible leather sides, having at one end a nozzle with a narrow mouth; and in the lower board, a valve of considerably larger area for the admission of air. When the bellows are distended by drawing the boards apart, air is sucked in by the valve, to replace the vacuum which would otherwise be formed; and then, when the boards are being closed, the valve, which only opens inwards, is shut by the compressed air; and the latter, having no other escape, is forced out at the nozzle.

The great fault of the common bellows is, that it gives a succession of puffs, and not a continuous blast. One remedy for this was to use two bellows, so that one was blowing while the other was filling;

but it was afterwards found that the double-bellows secured a still more uniform blast. This machine, shewn in fig. 1, is merely the common bellows with

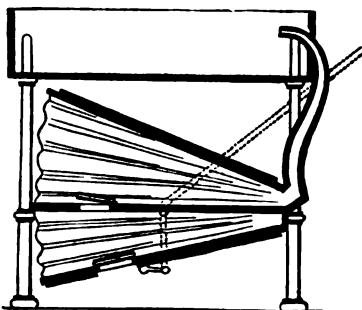

Fig. 1.—Section of Double-bellows for a Portable Forge.

a third board of the same shape as the other two placed between them, so as to form two chambers instead of one. The middle board is fixed, and both it and the lower one have valves placed in them opening inward. A weight on the lower board keeps the under chamber filled with air; and when this board is raised by a lever or otherwise, the air which it contains is forced into the upper chamber. The exit-pipe is attached to the latter, and a weight is placed on the upper board sufficiently heavy to press the air out in a continuous stream, the continuity being maintained by the large quantity of air always present in the upper chamber, and the uniform pressure of the weight. Sometimes a spring is used instead of a weight to press out the air. Even with the double-bellows, however, the constant refilling of the upper portion from the lower prevents the blast from being quite regular.

For such purposes as the supplying of a continuous stream of air to a flame for glass-blowing or soldering, a very convenient form of apparatus has been constructed by Mr P. Stevenson of Edinburgh, which the diagrams (figs. 2 and 3) will explain. By means of the common bellows worked by a treadle,

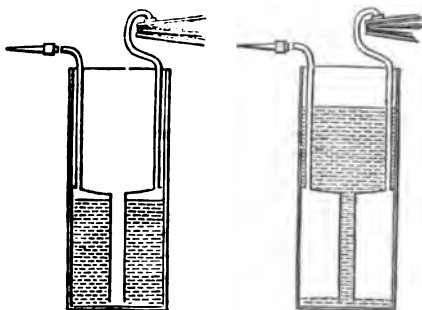

Fig. 2.

Fig. 3.

air is blown into the lower portion of a small cylinder containing a quantity of water, and having a diaphragm in the middle of the height, with a side pipe reaching nearly to the bottom. When the apparatus is at rest, the water remains below the diaphragm, as shewn in fig. 2; but when air is blown in, it gradually rises through the pipe to the position shewn in fig. 3. The water as it descends then presses out the air in a steady stream by the exit-pipe, as a valve prevents it returning to the bellows.

Bellows made entirely of wood except the nozzle, first made in Germany in the 16th c., are in use in some continental countries. They are usually of large size, and the contrivance consists in having two boxes, of which the sides of the upper enclose those of the lower, so that the former can move up and down on the latter without admitting air except by a valve, as in the common bellows, of which, in fact, they are only a modification.

The Chinese have a very simple form of bellows, shewn in fig. 4, which is not only interesting in

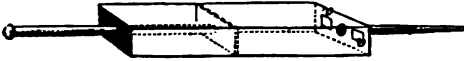

Fig. 4.—Chinese Bellows.

itself, but also because its action is almost the same as the blowing-engine. It is merely a square chamber of wood, with a close-fitting piston, which, when drawn from the nozzle, opens the valves *v, v*, to admit air, and when pushed in the opposite direction, shuts these valves, and forces the air out by the nozzle.

For blowing a domestic fire in a chimney, the most effective contrivance is a metal screen to close the front of the aperture above the grate, so that the supply of air must all pass through the fire. This kind of blower, however, will only act when the fire is already producing as much heat as to cause a sensible draught up the chimney.

For smelting and refining furnaces, where a blast with a pressure of 3 or 4 lbs. per square inch is required, blowing-engines of large size are usually employed. In our article IRON, this kind of engine is referred to, and a small figure of one given; but we shall here describe the blowing apparatus itself more in detail. A blowing-engine consists, as shewn in fig. 1, article IRON, of a steam-engine, with the ordinary steam-cylinder at one end, and a blast-cylinder at the other end of the beam. Such, at least, is the construction preferred for the larger-sized engines; but sometimes a horizontal arrangement of the cylinders is adopted for those of smaller size. The blowing-cylinder, X, shewn in fig. 5, is of cast-iron, with an air-tight piston, P, which, as it ascends and descends with the motion of the engine, alternately inhales and expels the air at each end. To effect this, a series of valves are provided, and these are arranged as follows: Inlet valves are placed on the top of the cylinder at A, and also on three sides of the box at B, but on the fourth side of this box there are two outlet valves at C. These valves consist of numerous openings, against which leather flaps lie when they are shut. Valves of a similar nature are placed at the bottom of the cylinder; those for the inlet of air at D, E, and F; and those for outlet at G. When the piston descends, it would create a vacuum in the upper portion of the cylinder, provided there were no openings in it; but the external air pressing on the inlet valves, opens them, and fills the space above the piston; at the same time, the outlet valves at C, which only open outwards, are tightly closed by the air pressing inwards from the pipe M. Again, when the piston ascends, it compresses the air above it, and exactly reverses the action of the valves; that is to say, it shuts the inlet valves at A and B, opens the valves at C, and allows the compressed air to pass along the outlet pipe M, which is made of large size, so as to offer as little resistance as possible to the passage of the air. The valves at the bottom of the cylinder work exactly in the same way, the inlet valves, D, E, and F, opening when the piston ascends, and shutting when it descends, thus compelling the inhaled air to pass into the pipe M by the lower outlet

valves at G. The air is conducted by the pipe M into a receiver of large capacity, which serves to equalise the blast before it passes to the tuyere. See IRON, fig. 1.

A blast-engine at Shelton Iron-works, of which the blowing-cylinder is 8 feet 4 inches in diameter, and has a 9-foot stroke (represented in fig. 5), working with 186 horse-power, and making 32 single strokes of the piston per minute, inhales 15,700 cubic feet of atmospheric air per minute; but this is compressed by the blowing-cylinder to a pressure of 3 lbs. per square inch above the atmosphere, which reduces the volume supplied by the cylinder to 13,083 cubic feet. Its volume, however, is largely increased again, when raised to the hot-blast temperature, before entering the furnace. Much valuable information respecting blowing-engines and blast apparatus will be found in Dr Percy's large

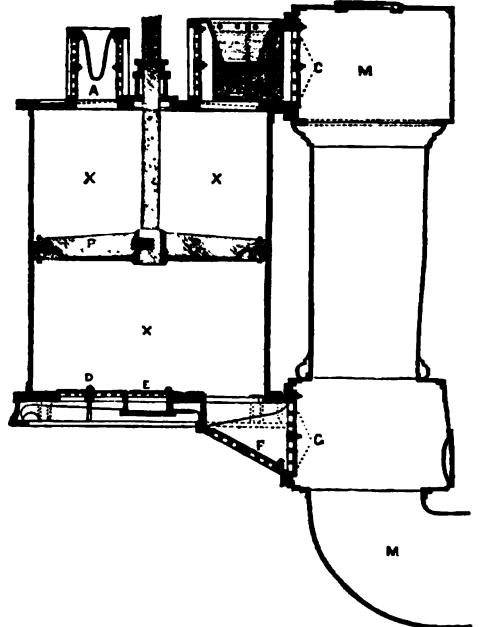

Fig. 5.—Section of a Blowing Cylinder, Shelton Iron-works, Stoke-upon-Trent.

work on Metallurgy, vol. ii., from which the above figure is taken.

In the Catalan forges of Spain and the south of France, there is a very ingenious water-blowing machine in use called a *Trompe*; but it can only be advantageously employed where a fall of a few yards of water is available. Its construction will be understood by an inspection of fig. 6. A strong wooden cistern, C, to act as a reservoir for the water; wooden pipes, P (generally two in number), through which it descends; and a wind-chest, W, to allow the air and water to separate, constitute the essential parts of the apparatus. It is put in operation by lifting the wedge *v* with a lever; this allows the water to rush down the pipe, and in doing so, it draws in air through sloping holes, *a, a*, called aspirators, at the throat of the pipe. A continuous current of water and air is thus supplied to the wind-chest, which is provided with an opening at *o* for the escape of the water, while the air passes out in a regular stream by the nozzle-pipe at *n*. The height from which the water falls determines the tension of the blast; but the height seldom exceeds

## BLOWING-MACHINES.

27 feet, which gives a pressure of from  $1\frac{1}{4}$  to 2 lbs. to the square inch. It is asserted that no other blowing-machine gives so equable a blast as the trompe, and it is the least costly of any; but it has the serious defect of supplying air more or less saturated with moisture. The theory of this singular machine has never been satisfactorily explained, although one or two able philosophers, who have specially studied the matter, incline to

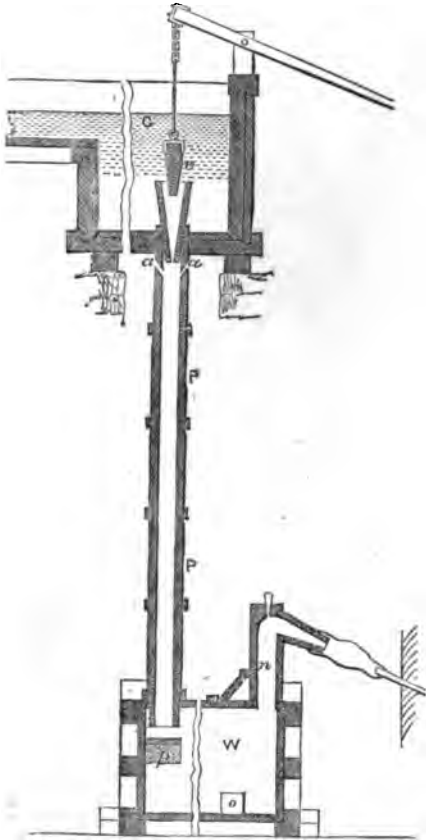

Fig. 6.—Trompe, or Water-blowing Machine (vertical section).

the belief that much of the air is carried down the pipe by becoming entangled in water. It is found that the separation of the air from the water is greatly promoted by allowing the falling current to impinge on a narrow platform at *p*.

The fan, or Fanners (q. v.), as it is sometimes called, is another machine of great value for producing currents of air. It has long been in use as a winnowing-machine for agricultural purposes, and also for creating a blast to melt pig-iron in foundries. More recently, it has been employed instead of bellows in smithies, on account of its greater convenience and the steadier blast which it yields. A domestic bellows has even been introduced on the fan principle. The fan is also much used in the ventilation of buildings, ships, and mines. For the last, it is now considered preferable to the plan of furnace-ventilation, especially where there are fiery seams of coal.

In its construction, the fan is like a wheel, having the arms tipped with vanes, instead of being joined by a rim. It is placed inside a chest—usually in

an eccentric position—with openings on each side round the spindle for the admission of air. The motion is given by steam or other power; and as it revolves, the centrifugal action sucks in air at the centre, draws it towards the tips of the vanes, and

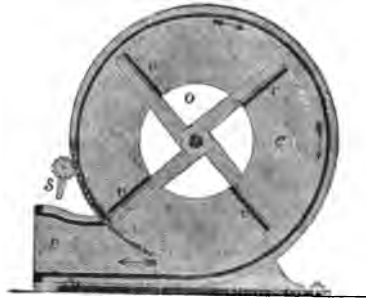

Fig. 7.—Fan (vertical section).

these impel it forward through the exit-pipe. Fig. 7 represents a vertical section, and fig. 8, a plan of a blowing-fan, in which *v, v, v* are the four vanes; *o*, one of the central openings; *c*, the chest or fan-case; and *e*, the exit-pipe. Engineers differ as to the proportions which should be adopted for the fan, and as to the extent of spiral which the fan-case should have. For foundries and smithies where the pressure of the blast required is from four to five ounces per square inch, the following have been found to suit very well in practice: the width of the vanes, as well as their length, made one-fourth of the diameter of the fan; the inlet openings in the sides of the fan-chest, one-half, and the degree of eccentricity, one-tenth of this diameter. There is a segmental slide shewn at *e* in fig. 7, by which the opening into the delivery-pipe may be increased or diminished. For

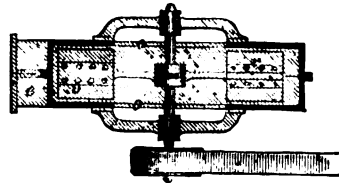

Fig. 8.—Fan (horizontal section).

such purposes, fans vary from 3 to 6 feet in diameter, and they are entirely constructed of iron. Double fans have been introduced by Mr Chaplin in England, and by M. Perrigault in France. In these, two simple fans are so disposed on one spindle that the blast produced by one passes in its compressed state through a tube to the other, which largely augments the working pressure. In Platt and Schiele's silent fan, the air enters by a central entrance at one side only, and is expelled from the case at the opposite side. The vanes are a peculiar shape, and describe what the inventor (Schiele) calls an antifriction curve. It is said to be very efficient, and so also is another form of noiseless fan by Mr George Lloyd, London.

For the use of the fan in ventilation, see that head. In some cases, fans are of large size; some also are of peculiar construction. Agricultural fans (see FANNERS) are not usually placed in an eccentric position in their cases, and only some kinds of ventilating fans are. One of the happiest applications of the fan has been to draw off and render harmless

the fine steel dust in the operation of needle-grinding. It has been lately employed to recover the waste gases in blast furnaces. A hot-air fan of an ingenious kind has been introduced for heating and drying purposes by Mr J. R. Davidson, London.

A modified form of the fan, called a *centrifugal disc*, patented by Mr Rammell (Patent No. 2718, Nov. 1860), has been successfully employed by the Pneumatic Dispatch Company for the transmission of the mail-bags. See PNEUMATIC DISPATCH. This machine can also be used to produce a blast, to raise water, and to propel vessels.

In the Paris Exhibition of the year 1867, there was an excellent blowing-machine, something on the principle of the fan, by Messrs Roots of Connersville, U. S. It is thus described in the *Engineer* for August 23, 1867: 'A pair of horizontal shafts, geared together at both ends, traverse a case of the form of two semi-cylinders, separated by a rectangle equal in depth to the diameter of the semi-cylinders, and in width to the distance between the centres of the shafts. . . . These shafts carry a pair of solid arms, each having a section somewhat resembling a figure of eight, the action of which, as they revolve, takes the air in by an aperture at the bottom of the machine, and expels it with considerable pressure, if required, at the top.' Fig. 9 will further explain

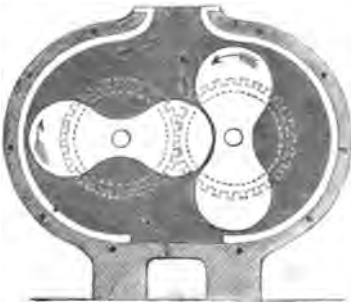

Fig. 9.—Roots' Blowing-machine.

the construction of this machine. It gives a much greater pressure of blast than is attainable by the fan.

For the purposes of ventilation, and also for expelling accumulations of hot air, dust, waste flyings, &c., in factories, a machine has been constructed by Mr J. Howorth, Farnworth, Bolton, called a *revolving Archimedean screw-ventilator*. It consists of an Archimedean screw enclosed in a tube with proper means of lubrication. Its diameter is 30 inches, and it is made to be set in motion by steam or other power, but it is also furnished with a hood, on the top of which there are curved vanes, which turn the screw by the action of the wind. Immediately beneath these, there is another series of lateral vanes for the escape of the hot air.

**BLUEFISH** (*Temnodon saltator*), a fish of the family *Scomberida*, of a genus having no detached finlets, no isolated dorsal spines, and no lateral armature of the tail, two dorsal fins, the first of which is small, and two deeply-hidden spines in front of the anal fin. The only known species is a native of the east coast both of North and South America. The upper parts are of a bluish colour, the lower parts whitish, a large black spot at the base of the pectoral fins. The mouth is crowded with teeth, the jaws are furnished with large ones. The B. preys on other fishes, as the weak-fish, menhaden, and mackerel, the shoals of which it pursues. It is very swift, strong, and voracious.

It sometimes attains a length of three feet, and a weight of 14 lbs. It is much esteemed for the table, and great numbers are brought to market in New York, Philadelphia, and other towns about the end of summer. It is often caught by trolling, as it bites readily at any object drawn swiftly through the water. It frequently ascends rivers even to fresh water.

**BOATBILL** (*Cancroma cochlearia*), a bird of the Heron (q. v.) family, the only known species of a genus differing from the true herons in little else



Boatbill (*Cancroma cochlearia*).

than the form of the bill, which is comparatively short, and very broad, the mandibles resembling the bowls of two spoons placed one upon the other, the upper mandible overlapping the lower, keeled on its upper ridge, and hooked at the point. The B. is about the size of a domestic fowl, has shorter limbs than most of the herons, but resembles them in plumage, and is abundantly provided with elongated feathers on the back of the head and neck, which it erects when irritated. Its general colour is rusty red, the forehead and breast whitish. It inhabits Cayenne, Surinam, Brazil, &c., sits perched upon trees which hang over streams, and darts down upon fish, which seem to be its principal food.

**BODE, THE BARONS DE**, a family of doubtful nationality, best known in England in connection with a claim for indemnity frequently brought before parliament. The first member of the family connected with England was CHARLES A. L. F. DE B., a baron of the Holy Roman Empire. He was born at Neuhof, in Germany, in 1741, and became an officer in the regiment of Nassau, which, although in the service of France, consisted exclusively of Germans. The baron had landed property in Germany, and remained German when he married a Miss Kennersley, an Englishwoman. Two years afterwards, a son was born of the marriage at Lockaley, in Staffordshire, named CLEMENT J. P. DE B., who returned when a child with his parents to the continent. In 1787, Baron Charles purchased an estate in Lower Alsace, held under German feudal tenures, in terms of the treaty of Münster, and thither he went to reside. The Revolution, however, broke out, and in 1791 the baron considered it prudent publicly to surrender his estates to his son. Two years later, the family was obliged to emigrate, and the property was confiscated. After leaving France, Baron Charles bought a fief held of the Archbishop of Cologne, and he died a German in 1797. Clement, his son,

became an officer in the Russian artillery, married a Russian, and, with his regiment, entered Paris in 1814. After the peace, conventions were entered into, under which British residents who had suffered during the Revolution by confiscation were to be indemnified. A large sum was handed over by France to England, to be divided among the claimants, one of whom was Baron Clement. The fact that he had been invested as proprietor of the estate in Alsace at the time of confiscation, that his mother was English, and that he had been born in England, secured at first a recognition of his claim to the extent of making it an item of the calculation for fixing the amount of the indemnity; but it was afterwards repudiated, on the ground, that Baron Clement was not an English subject at the time of confiscation, and that he had sustained no loss through his connection with England. He died in 1846. His son, BARON CLEMENT A. G. P. L., took out letters of administration to his father, and prosecuted the claim of his family; without, however, any success. He petitioned the House of Commons in 1852, and his case was fully discussed. See J. Hodgkin's *Case of the Baron de B. in its Present Aspect* (1860). Baron Clement is naturalised as a British subject, and has married an Englishwoman. He has acquired reputation as an Eastern traveller, and is the translator of *Bokhara, its Emir and People*, from the Russian of Khanikoff (1845), and the author of *Travels in Lauristan and Arabistan* (1845), and of an interesting *Account of Hilly Daghestan and the Lezghi Tribes of the Eastern Caucasus*, referred to with approbation by Earl de Grey in his address to the Geographical Society in 1860.

**BOEHRMIA.** The China-grass plant, *B. nivea*, has recently been introduced into cultivation in some of the southern parts of the United States, under its Malay name of *Ramee*. It succeeds well, and the results as to produce of fibre have proved very encouraging.

**BOISSONADE, JOHN FRANCIS**, a distinguished classical scholar, born at Paris, August 12, 1774, of a noble Gascon family. He was originally intended for the administrative career, but after experiencing some of its more violent vicissitudes, he renounced it for philology, in which he had always found his favourite recreation. He soon made himself known to the critical world by his acute and learned contributions to the literary journals, was appointed Professor of Greek in the Academy of Paris in 1809, and entered on the active duties of the chair in 1812. In 1813, he was admitted into the Academy of Inscriptions; and in 1828 he succeeded Gail as Professor of Greek Literature in the College of France. Beyond this high position he never aspired, but pursued his investigations with an energy which no mere social or public ambition could distract. His more important works are these: *Philostrati Heroica* (Paris, 1806); *Marini Vita Procli* (Leip. 1814); *Tiberius Rhetor de Figuris* (Lond. 1815); *Sylloge Poetarum Græcorum* (Paris, 1823—1826); *Babrii Fabula* (Paris, 1844); &c. He contributed in his earlier years numerous papers on philological subjects to Parisian, English, and German journals, and gave the cause of classical study in France a powerful and still perceptible impulse by his eloquent and attractive lectures from his chair. In spite of his many and laborious philological works, he also signalled himself as a French lexicographer and belle-lettrist, and was one of the most copious and valued contributors to the *Biographie Universelle*. He died in 1859, leaving behind him a reputation for learning almost German in its profundity, and more than English in its elegance.

**BOLI**, or **BOLY**, a town of Asia Minor, in the pashalic of Anatolia, on the left bank of the river Boli, and on or near the site of the Roman Hadrianopolis, 136 miles east from Constantinople. The town occupies an eminence, at the extremity of a fertile plain. It has several mosques. There are mineral springs near the town, and baths much frequented by the Turks. B. is on the caravan route from Constantinople to Erzeroum. Pop. 10,000.

**BOLSWAARD** (Lat. *Bolewerda*), an old town in the Netherlands, province of Friesland, lies 15 miles south-west from Leeuwarden. It is surrounded by a high earthen wall and broad canal. The church of St Martin, in the Gothic style, is the largest and handsomest in Friesland. There are several benevolent institutions, and a grammar-school. The trade is chiefly in butter, cheese, and cattle. Ship-building, tanning leather, making brick and coarse pottery, spinning worsted, carding wool, &c., are the principal industries. Pop. nearly 6000.

**BOM JARDIM** (i. e. Good Garden), a town of Brazil, in the province of Ceara, 20 miles south-by-east from Crato, in a rich and beautiful mountain valley. It is the centre of an extensive district, yielding mandioc, sugar, &c. Pop. 6000.

**BONILLO**, a town of Spain, in the province of Albacete, and 34 miles west-north-west from Albacete. Pop. 5980.

**BO'NYHAD**, or **BONHARD**, a market-town of Hungary, in the county of Tolna, 20 miles north-east from Fünfkirchen. Pop. (1899) 5610.

**BO'RA SA'MBA**, a curious little half-independent state, or raj, in India, within the jurisdiction of the political agent for the south-west frontier of Bengal. Its central point is in N. lat. 20° 55', E. long. 83° 10'; its area is about 622 sq. m.; the pop. is estimated at 28,000. The country is rugged, and the people savage. Outlaws from other parts of India have too often found refuge here. The revenue is about £400 a year. A tribute of £16 is paid to the British government.

**BORGETTO**, a town of Sicily, in the province of Palermo, and 13 miles west-south-west from Palermo. It is a long straggling town, of mean houses, but picturesquely situated on a wooded cliff overhanging a plain, and itself overhung by a lofty precipice of red rock. Pop. 6000.

**BORGOMANERO**, a town of North Italy, in the province of Novara, and 19 miles north-north-west from Novara, situated near the left bank of the Agogna. It is a walled town, well built, and contains a communal college and an hospital. It has little trade. Pop. 5320.

**BO'RGO SAN DONI'NO**, a city of North Italy, in the province of Parma, situated in a plain, 14 miles north-west from Parma, on the railway between Parma and Piacenza. It is surrounded by walls, has several good streets, is an episcopal see, and has a cathedral (the oldest part of which is in the Lombard style), several churches, and several educational institutions. Manufactures of silken, linen, and woollen fabrics are carried on; and oil and wine are produced in considerable quantities. The city derives its name from a saint, who is said to have been a soldier in the army of the Emperor Maximian, and to have suffered martyrdom here. The shrine of St Donino has long been one of the most frequented in Italy. There are some curious remains of very rude medieval sculpture in the cathedral. Pop. about 4200.

**BORGOTARO**, a town of North Italy, in the province of Parma, and 35 miles south-west from Parma, on the left bank of the Taro, a tributary of



the Po. It is encircled by walls, and is well built. Pop. (including commune) 6938. The surrounding district is hilly and wooded.

**BOBOVITCHI**, a town of Russia, in the government of Novgorod, 98 miles east of the town of Novgorod, on both sides of the river Msta, near some rapids. Pop. (1867) 9108. Its situation on the great canal and river water-way which connects the Volga with Lake Ladoga, renders it of considerable commercial importance.

**BORZNA**, a town of Russia, in the government of Tchernigov, 50 miles south-east of the town of Tchernigov. Pop. (1867) 8129.

**BO'SCO REA'LE**, a town of South Italy, in the province of Naples, at the south base of Mount Vesuvius, 10 miles east-south-east of Naples city. It contains several churches and convents. Population, 4553. Good wine is produced in the neighbourhood, and much silk. This town was in imminent danger of destruction by the eruption of Vesuvius in 1850, when a stream of lava advanced towards it with a front of about a mile and a half broad, and a depth of about 12 feet, enveloped the town, and consumed the wood on both sides of it, in which were many magnificent oak, ilex, and ash trees. The larger trees, as they were enveloped in the lava, poured out jets of hissing steam from every knot and branch, and then exploded with a loud noise, leaping into the air to the height of 10 or 20 feet.

**BOUCICAULT, DION**, dramatic author and actor, was born at Dublin on the 26th of December 1822. He was brought up under the guardianship of Dr Dionysius Lardner, the well-known popular writer on science, and was educated at University College, London. He produced his first dramatic work very early—before he was 19 years old. It was signally successful, and its success determined his career. This was *London Assurance*. It was first performed at Covent Garden Theatre in March 1841; and it has ever since remained a favourite with playgoers, both throughout Great Britain and in America. Much of the success it had in London must be ascribed to the admirable acting of Mr Charles Mathews; but it had merits of its own sufficient to secure to it the favourable verdict of the public. The plot was slight, but ingenious; it abounded in comic situations; the dialogue was brisk and sprightly; there was no lack of wit, and there was perhaps somewhat too much of those flippancies and pleasant impertinences which average theatre-goers prefer to wit. Once embarked in the career of a play-writer, B. produced piece after piece in rapid succession, and greatly increased the reputation which his first attempt had brought him. *Old Heads and Young Hearts*, *Love in a Maze*, *Used Up*, *Louis XI.*, and *The Corsican Brothers* were among the most popular of his early works. Several of these are still stock pieces at our theatres; and to playgoers, the mere enumeration of their names will shew that B. distinguished himself equally in comedy, farce, and melodrama. When he went upon the stage, as he soon did, he added a high reputation as an actor to the reputation he had previously gained as an author. From 1853 till 1860, he was in America, where his popularity was scarcely less than it had been in England. On his return to England in 1860, he produced at the Adelphi Theatre, a play, *The Colleen Bawn*, which proved among the most successful of modern times, and which, if not the first of a new school, has at least supplied a new descriptive name to our dramatic literature. *The Colleen Bawn* was, happily enough, described as a 'sensation drama;' its interest depended largely upon scenery, mainly upon

startling incidents and astounding stage-effects. It was not a high kind of work, or fit to stand the tests of a good dramatic piece, as nobody knew better than the author; but it suited the public taste, and the author made a fortune by it. It has been performed at almost every theatre in the United Kingdom; it had a great run in America too; it was even translated into French, and brought out at the Ambigu Theatre at Paris. Mr B. subsequently produced at the Adelphi—of which he was for some time joint-manager with Mr B. Webster—another 'sensation' drama, *The Octoroon*, the popularity of which was only inferior to that of *The Colleen Bawn*. Having quarrelled with Mr Webster, he, in 1862, opened a new theatre in London, the Westminster, erected on the site of what had been for generations known as Astley's Amphitheatre; but this speculation turned out unfortunate, and B. was ruined by it. He afterwards re-established his fortunes by new plays, brought out at the Princess's, the Holborn, and other theatres, in some of which he and his wife—formerly Miss Robertson, a very popular actress—took the leading parts. *The Streets of London*, *Flying Scud*, *After Dark*, and the *Shanghaiana* have been the most popular of his recent works, all of which are of the 'sensation' school, with which, it may be said, he first familiarised the public. He has written upwards of 150 dramatic pieces; and in illustration of the facility with which he has composed works which—all deductions made—are of considerable merit, it may be said that he lately stated to a royal commission that he would undertake to write plays for all the theatres in London. He is undoubtedly capable of writing better works than any he has yet written; but he found the public taste bad, and instead of making thankless attempts at improving it, he has been content to gratify it; and in fact has helped to debauch it. As an actor, B. has always been popular, without attaining to high excellence in his vocation. He wants some natural gifts, without which a man cannot be a great actor: he has an immobile countenance, an indifferent voice, and a too artificial manner. Any success he has had has been gained by the soundness of his judgment, his great cleverness, and his intimate knowledge of stage business.

**BOU'FARIK**, a village of Algeria, in the province of Algiers, and 16 miles south of Algiers. It is an important military station on the road from Algiers to Blidah and Oran. It has well-frequented markets, and a considerable trade in corn, cotton, olives, oranges, tobacco, raisins, and cattle. Pop. 7650.

**BOUVA'RDIA**, a genus of plants of the natural order *Cinchonaceæ* (q. v.), and of the same tribe with the *Cinchona* (q. v.), or Peruvian Bark. The calyx is 4-partite, with teeth between the segments; the corolla tubular and 4-fid; and the stamens 4, included within the corolla; the capsule 2-celled. The species are natives of Mexico. One of them, *B. triphylla*, with oblong ternate leaves and trigonous branches, has obtained a place among the favourite ornaments of flower-borders in Britain, but requires careful protection from frost. To preserve it, the roots are generally taken up, and are sometimes placed in a greenhouse or frame for the winter, sometimes in a dry cellar. Its beautiful corymbs of scarlet flowers are produced from June till November.

**BRADDON, MISS MARY ELIZABETH**, one of the most popular novelists of the day, was born in London in the year 1837. Her father, Mr Henry Braddon, was a solicitor. She very early shewed a turn for literature, which she indulged in the usual manner, by sending verses and other trifles to the

magazines and newspapers. In 1860, she essayed a somewhat more sustained effort in a little *commedietta* called *The Loves of Arcadia*, which was brought out at the Strand Theatre; and the year after, she published a volume of verse entitled *Garibaldi and other Poems*. Neither these, however, nor the tales which she now began to issue through the medium of the *Temple Bar* and *St James's Magazine*—*Lady Lisle*, *The Captain of the Vulture*, *Ralph the Bailiff*, &c.—in any decisive way succeeded in drawing to her the attention of the public. Her first great success came with the publication, in 1862, of *Lady Audley's Secret*, which instantly attained a great popularity. This has since been extended by the appearance of *Aurora Floyd*, *Eleanor's Victory*, *John Marchmont's Legacy*, *The Trail of the Serpent*, *The Ladies' Mile*, *Str Jasper's Tenant*, *Only a Clod*, *The Doctor's Wife*, *Run to Earth*, *The Loves of Arden*, *Birds of Prey*, *Dead Sea Fruit*, *To the Bitter End*, *Strangers and Pilgrims*, *Joshua Haggard's Daughter*, *Weavers and West* (1877), &c. Miss B. has contributed very extensively to *Belgravia*, a London magazine which she conducts. Few books of the period have secured a wider circle of readers than Miss Braddon's. They mainly depend for their interest on good bold effects of what is termed, in the slang of the day, *sensation*, and the art of their appeal to 'that low vice, curiosity,' in the conduct of a story, carefully leading up to some suspended and unforeseen *dénouement*. In their particular way, though without much claim to attention as regards either character or sentiment, they display undoubted talent: in style, they are fresh and vigorous, and their narrative power strongly excites the reader's interest. Miss B. is still in uninterrupted literary activity.

BRAY, MRS ANNA ELIZA, an authoress, is daughter of the late John Kempe, Esq., of the New Kent Road, Surrey, and was born towards the end of last century. At an early age, she shewed much of the imaginative faculty, and a taste for design, which latter brought her the acquaintance of the celebrated Mr Stothard, R.A. From Stothard she took lessons in drawing; and in February 1818, married his second son, Charles Alfred Stothard, also an artist, and author of a well-known work entitled *The Monumental Effigies of Great Britain, selected from our Cathedrals and Churches*, &c. In July 1818, she accompanied her husband to France. Their tour and residence in France lasted until about the middle of November in the same year; and Mrs Stothard wrote an agreeable and lively account of her first foreign experiences, under the title of *Letters written during a Tour through Normandy, Brittany, and other parts of France, in 1818, with Numerous Engravings after Drawings by C. Stothard, F.S.A.* (Lond. 1820, 4to). Subsequently, Mrs Stothard accompanied her husband on a similar tour in the Netherlands. In May 1821, however, she had the severe misfortune to lose her husband, who was killed by falling from a ladder. In 1823, Mrs Stothard wrote a life of her husband, entitled *Memoirs, including Journals, Letters, Papers, and Antiquarian Tracts of the late C. A. Stothard, with Connective Notices of his Life, and some Account of a Journey in the Netherlands*. Distress of mind brought on ill health, and Mrs Stothard suffered from an affection of the eyes, which obliged her to give up literary labour altogether for more than two years. In 1825, she married the Rev. E. A. Bray, vicar of Tavistock; and in the following year, published a historical romance entitled *De Foix*, which she had begun during her first husband's lifetime. The idea of this romance was conceived during the tour in Normandy; and similarly, that of her second

romance, *The White Hoods*, during her tour in the Low Countries. This was published in 1828, and was followed by *The Protestant*, also in 1828; *Fitz of Fitz-Ford, a Legend of Devon* (1830); *The Talba, or Moor of Portugal* (1830); *Warleigh, or the Fatal Oak, a Legend of Devon* (1834); *Trelawny of Trelawne, or the Prophecy, a Legend of Cornwall* (1837); *Trials of the Heart* (1839); *Henry de Pomeroy* (1842); and *Courtenay of Walreddon, a Romance of the West* (1844). A collective edition of all these romances was published in ten volumes in 1845, with a 'general preface,' in which the writer mentions the circumstances under which each was produced. Mrs B. is also author of *The Borders of the Tamar and the Tavy* (1836), *The Mountains and Lakes of Switzerland* (1841), *Trials of Domestic Life* (3 vols. 1848), *Life of Thomas Stothard, R.A.* (1851), *A Peep at the Pizies* (1854), and *Händel, his Life, Personal and Professional, with Thoughts on Sacred Music* (1857). In July 1857, Mrs B.'s husband died; and in 1859, she published his *Poetical Remains*. In 1870, appeared *The Good St Louis and his Times*, and *The Revolt of the Protestants of the Cevennes*. In 1871 came *Hartland Forest: a Legend of North Devon*; in 1873, *Joan of Arc, and the Times of Charles VII., King of France*; and in 1874, *Roseteague*.

BRAY, a maritime town, situated partly in the county of Dublin, partly in that of Wicklow, 13 miles S.E. from Dublin, with which city it is connected by the Dublin, Kingstown, and Bray Railway, and the Dublin, Wicklow, and Wexford Railway. The pop. in 1861 was 4182, and in 1871 had risen to 6087, of whom 4562 were Roman Catholics, 1315 Protestant Episcopalians, and the rest of other denominations. Some years since, B. was a small fishing-village; but the beauty of its situation has made it a popular watering-place, as well as a favourite position for villa residences; and under the enterprise of a few active speculators, it has not only grown in its dimensions, but the extensions have been carried out with excellent taste and spirit. The most striking buildings are the new hotels, and a Turkish bath, recently diverted to other purposes. The affairs of the municipality are administered by town commissioners. B. has a weekly newspaper.

BRAZIL CABBAGE, or CHOU CARAÏBE (*Caladium sagittifolium*, or *Xanthosoma sagittifolia*), a plant of the natural order *Araceæ*, nearly allied to Cocco (q. v.), and very similar to it, although it differs in having arrow-shaped pointed leaves. It is supposed to be originally a native of tropical America, but is now in common cultivation throughout the whole tropics; not only the root being used for food like that of cocco, but also the leaves, boiled as greens. Both root and leaves are almost entirely destitute of the acidity so generally characteristic of the order.

BREECH-LOADING ARMS AND NEEDLE-GUNS. To be loaded at the breach, and to be fired by the penetration of a needle into, or the impinging of a piston on, a detonating cap within the cartridge, are distinct attributes in a weapon; and although it is only within the last thirty years that the system has been carried out with success, breech-loading arms have been tried, accepted, and abandoned without number during the last three centuries. Indeed, a sort of instinct dictates that loading at the breach is the preferable course; and all the earliest muskets were so made, the system being doubtless abandoned from the difficulty of accurately closing the breech, in those days of rough workmanship. The extraordinary efficacy of breech-loading arms for military purposes was brought prominently forward

## BREECH-LOADING ARMS AND NEEDLE-GUNS.

during the wars of the last few years, and notably in the Prussian campaigns of 1864 against Denmark, and of 1866 against Austria. The successes of the Prussian arms were attributed in no small degree to the rapidity with which their troops could fire as compared with the enemy. They had, in greater or less numbers, borne these same rifles since 1835, but these were the first opportunities of using them in warfare. To all the other powers, whose men still carried muzzle-loading rifles, and who had debated, without practical result, for years past the question of armament with breech-loaders, soldiers thus armed appeared irresistible. From July 1866 to the present moment, the hammer and the anvil have been busy night and day throughout the civilised world in making the weapons of death yet more deadly. Scarcely two countries seem to have adopted the same plan: each nation has elaborated a system from among its own inventors. Those possessing no great reserve of rifles have prepared new arms; but the majority of governments have been content, in the first instance, to convert their existing stock into breech-loaders of as good a construction as circumstances would permit. Thus, Britain, after offering a handsome prize for the best design, selected one said (subject to some controversy) to be the invention of the late Mr Snider. As this weapon has been produced already to the number of a million, and as it has confirmed the favourable auguries entertained of it by accuracy of fire, and by loading thrice to the muzzle-loader's once, much of the following article will be devoted to a consideration of it. At the same time, it is to be borne in mind that the British Government only regarded the Snider arm as a make-shift for the conversion of the enormous stock of Enfield rifles then in hand, reserving to itself the ultimate selection of a pattern on which to manufacture new weapons. It is not to be understood from what is said above that Britain adopted a breech-loading arm in a sort of panic after the battle of Sadowa. It was after the Danish campaign, on the 11th July 1864, that it was decided as an abstract question to arm the British infantry with breech-loaders; a portion of the cavalry having for a number of years previously been armed with Sharp and Westley Richards carbines, loading at the breech. The selection of an arm took longer; but by the beginning of 1865 it had been decided to convert our great stock of rifles on the 'Snider' system. In 1869 it was determined that new arms should be on the Martini-Henry system—i.e., with the Henry barrel, and the Martini breech-action. A description of this rifle will be given farther on.

**Breech-loading.**—The advantage of breech-loading is obvious: to be able to insert the charge at the breech end instead of the muzzle, is to save time, and to avoid exposure to hostile fire during the operation of loading and ramming home, which involves considerable outstretching of the limbs. The great condition of success is, that the bullet shall be propelled with equal force and accuracy, and with equal safety to the rifleman, as from the muzzle-loader.

When a charge is ignited, the constituents of the gunpowder, assuming a gaseous condition under the heat engendered, expand into a volume of light gas many times greater in bulk than the powder before occupied. On the amount of this expansion, and its sudden action on the projectile, the force of the shot depends. Any joint in the breech-piece through which a portion of this gas can escape, without having imparted its thrust to the ball, tends, therefore, to lessen the range and penetration; while the shock of the explosion falling more severely on this than on any other part of the barrel, tends yet

more to dislocate the breech-piece, and diminish the closeness of the joint's fit. In weapons which do not call for a long range, as revolver pistols, a perceptible interval is left between the chamber and barrel, through which much gas escapes; but in rifles, which have range and penetration as principal objects, there is *primis facie* ground for preferring a muzzle-loader. The gas, however, is far from pure as generated in the barrel, for much water is produced and held in suspension, while there is also a solid residuum consisting of unburned materials of the powder. In the muzzle-loader, these clog (or, technically, foul) the barrel, filling the grooves, and rendering the ramming home of succeeding charges more and more difficult. The effect is, that a solid mass of unburned matter is gradually forced by ramming into the head of the barrel, destroying the accuracy and usefulness of the weapon. In the breech-loader, this solid deposit must be provided against both ways. The backward throw on firing (for, of course, the charge explodes with equal power in every direction) tends to force it into the mechanism of the joints, preventing their proper fit, and continually augmenting the escape of gas; and on the other hand, the deposit in front is most detrimental to accuracy of fire. This protection of the breech-apparatus, the prevention of fouling, and the retaining and if possible improving the force and accuracy of fire, were the problems which inventors have had to solve.

A moderate escape of gas in front of the first position of the ball, is not found to be any material disadvantage. If, then, the barrel could have an opening, as in fig. 1, at *a*, where the cartridge could

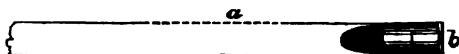

Fig. 1.

be inserted, and then pushed backwards towards *b*, an escape of gas through the joints by which a might be subsequently closed would be comparatively immaterial; but this formation would be impracticable, because the explosion of each cartridge would drive the fouling more and more towards *b*, till ultimately the chamber between *b* and *a* would be unable to contain the cartridge. It is clear, therefore, that the charge must be inserted either at the barrel's head *b* (in fig. 2), or, if the

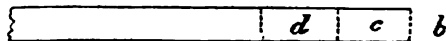

Fig. 2.

barrel be opened, in a space close to that head, as *c*. In either of these cases, the breech at *b* must be solidly closed to resist the explosion. A third case, as in the Snider, is where the cartridge is inserted, as at *c*, and then pushed forward to the position *d*, the aperture *c* being closed by a solid breech-piece which completely fills that portion of the barrel, and forms, with the barrel's head, a massive foot to resist the backward pressure of the fired powder. No breech action can be made to fit so accurately as to prevent a backward escape of gas unless a properly constructed cartridge case is used. A perpendicular moving joint is found, in practice, to be the best adapted for preventing a serious escape of gas: such a joint is shewn in fig. 3, and is naturally the most convenient in an arrangement like the Snider, where the breech-piece turns on a hinge. In the Prussian needle-gun, the end of the barrel is the frustum of a cone, which fits into a corresponding cavity in the fore-end of the

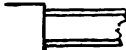

Fig. 3.

## BREACH-LOADING ARMS AND NEEDLE-GUNS.

breech-piece *a*, as in fig. 4; but in practice this joint is not sufficiently tight to prevent an escape of gas from the self-consuming cartridge used with this gun, which becomes inconveniently great after long use of the weapon, and it is only available when the

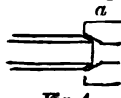

Fig. 4.

breech-piece is pushed up from the rear. In the Snider and several other breech-loading weapons, the cartridge is made itself to close hermetically the aperture between the barrel and the fore-end of the breech-piece. This

is effected by the expansion of the cartridge case *d*, fig. 5, which being composed of metal, or a combination of metal and paper, is driven out by the force



Fig. 5.

of the explosion till it completely fills the chamber *d*, and prevents any escape backwards between the sides of the case and the chamber. The cartridge *d* has a portion of its case at the base flattened out into a rim which fits into a corresponding recess, *a*, in the end of the barrel; and to prevent expansion backwards, which would fracture the cartridge-case and injure the breech or the firer, the breech-piece, *c*, is made to fit as closely as possible against this base, which, in addition, is made much stronger than the rest of the case. This rim is seen on the Snider cartridge at fig. 9, and serves as a convenient catch for the extractor in extracting the empty cartridge-case.

The remainder of the article will be devoted to a description of the three most prominent breech-loaders—the Prussian Zündnadelgewehr, and the British Snider and Martini-Henry.

The Prussian gun, which was first in the field, consists, as regards its breech-apparatus and needle-lock, of three concentric hollow cylinders, with a

solid cylindrical bolt inside the last (see figs. 6, 7). The rear-end of the barrel is firmly screwed into the head of the chamber *a*, which is fixed to the stock of the piece, and is open at the rear-end. The upper half of the cylinder is cut away at the front-end for rather more than the length of the cartridge: this constitutes the opening in which the musketeer inserts the cartridge. From the rear of this opening to the back, a groove is cut, sufficiently wide to allow the square pillar of the breech-handle, *c*, to pass along it. In the middle of this groove is a right-angled shunt, offering a stop to the breech-handle when drawn backwards, unless it be likewise turned downwards, when it may be passed completely out at the rear-end. Next within the chamber is the breech-piece *d*, which, to admit the cartridge, is drawn back for a sufficient distance by the breech-handle along the groove. When the cartridge is deposited in the recess in the chamber, this breech-piece is closed against the heel of the breech by moving up the handle to the front-end of the groove, and then turning it down to prevent it from being driven back on the explosion of the charge; representing, indeed, the resistance offered by the heel of an ordinary muzzle-loading barrel. Firmly screwed within the breech-piece, at a short distance from its front, is a solid block of metal *f*, on which impinges the first force of the explosion. Projecting from this block to the base of the cartridge, is a strong *tige*, or pillar, *g*, around which a space containing air is left. Through this pillar is the channel for the needle to work. Fitting within the rear-end of the breech-piece is a smaller cylinder *h*, constituting the lock of the gun. It slides within the breech-piece, and is retained from falling out backwards by the spring *i*, which catches in a notch at the end of *d*. Along the bottom of this cylinder is a groove to admit the passage of the trigger *k*; and at the back is a short upright handle, by means of which the weapon is cocked. Lastly, within the lock is a bolt *l*, pressed forward by a spiral spring, and having the needle, *m*, rigidly fastened to its front end. Having now described the several parts of the rifle, it is easy to

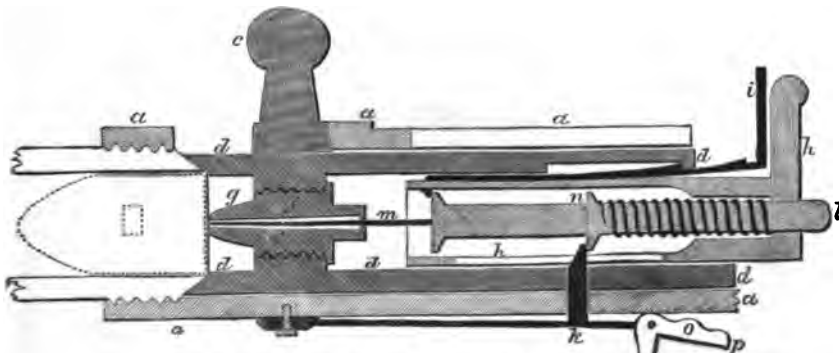

Fig. 6.—Section of Prussian Needle-gun: Half-cock.

follow it from the moment of a shot being fired until the next is ready for discharge. The soldier first presses down the spring *i* with his finger, releasing the catch below it, and enabling him to draw back the lock to the next catch on the spring, into the position shown in fig. 6. Having done so, he raises the breech-handle to the perpendicular, and passes it along the groove to open the breech, and thus made in the chamber, and again moving up the breech-piece to close the breech, the

tige in it pushes the cartridge forward into the barrel, and the rifle is at once at 'half-cock,' as in fig. 6; for in drawing back the lock, the front point of the spring *i* forced the bolt *l* (including the needle *m*) with it, and the projection, *n*, on it having passed over the head of the trigger *k*, is caught by the latter in a way which can only be released by the falling of the trigger. It will be observed that at half-cock the needle is ready to penetrate the cartridge, but that the spiral spring is loose and without power. To 'full-cock,' no more is necessary

## BREACH-LOADING ARMS AND NEEDLE-GUNS.

than to push *h* back to its original position. It cannot take the bolt, *l*, with it, as the trigger retains it to the rear. The position (fig. 7) is now obtained, in which the bolt, *l*, projects at the back, and the spiral spring is compressed into a state of passive strength. All that is now needed to fire the gun is to press upon the trigger, until the point *o* bears, when the bolt *l*, being released by the depression of *k*, the spiral spring asserts its power, and drives the needle into the heart of the cartridge, the parts all resuming their original positions. At first sight, one cannot help exclaiming: 'What a complicated apparatus with the four cylinders and the springs!' but, in reality, it is as simple as almost any other gun, for

the whole mechanism of the Lock (q. v.) is dispensed with. If it be desired to take the needle-gun to pieces, press the trigger till the point, *p*, bears. If the breech-handle be then in the hinder part of its groove, the breech-piece with its contents will slip out of the chamber. Pressing down, next, the spring *i*, until the second catch is passed, there is nothing to retain the lock, *h*, in the breech-piece; and the lock being free, the needle, with its attached bolt and spring, falls readily out of its fore-end. The gun is thus taken to pieces in a few seconds, and as many suffice to put it again in fighting order. The most delicate portions are the needle and the spiral spring; but in case of accident to

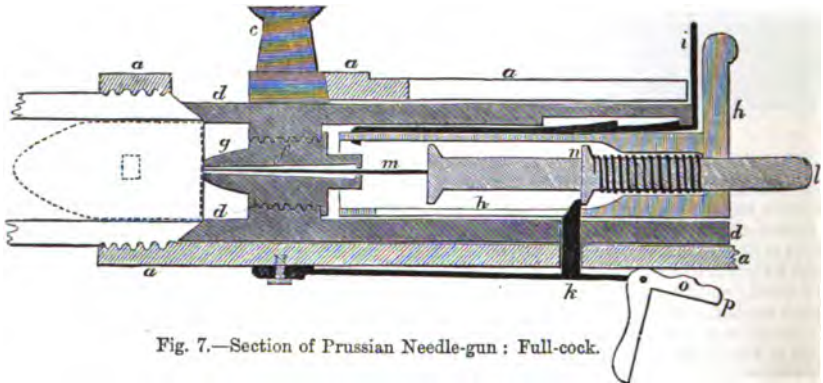

Fig. 7.—Section of Prussian Needle-gun : Full-cock.

these, there is a spare one in a small cavity opening by a spring in the butt-end of the stock. The worst feature about this celebrated gun is its weight, 12 lbs., or 33 per cent. heavier than the Enfield or Snider rifle.

The converted Enfield or 'Snider' rifle was selected in 1865—1866 by the British government from the specimens submitted at an open competition of inventors. It is an extremely simple weapon, and though by no means free from faults, has given very satisfactory results up to this time. The ordi-

nary Enfield barrel is shortened by about two and a half inches, and the heel of the remainder is screwed in to a strong shoe, *a* (fig. 8), with which is connected by a powerful hinge, *b*, the solid breech-piece, *c*, which, when shut, completely closes the breech. Through this passes the piston or striker from *d* to *e*; the normal position of the piston is maintained by a spiral spring within the nipple (which screws into the upper side of *c*), and is such that the piston does not project at *e*, while it does project at *d*. Given the breech open as in

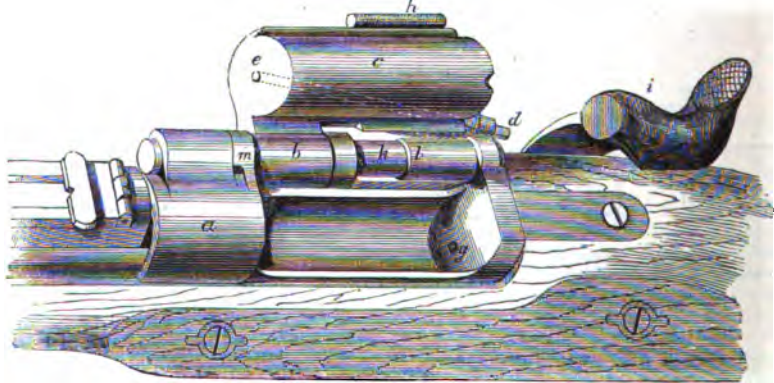

Fig. 8.—Snider : Open.

fig. 8, the cartridge is inserted and pushed forward into the barrel, where its metal rim fills the groove left around the barrel's heel. The breech-piece, *c*, is closed down, the hammer, *i*, drawn to full-cock, and the piece is ready for discharge. The breech-piece is securely locked by the spring bolt, which enters a recess in the false breech at *g*, and can only be withdrawn on the lever thumb-piece, *h*, being pressed by the thumb in the act of again lifting the breech-block. On the trigger being pulled,

the hammer falls, drives in the piston at *d*, and out against the detonating cap of the cartridge, with a sharp blow at *e*, firing the charge. The hammer is drawn back to half-cock, the piston flies up to its former position; the breech-piece, *c*, is thrown back, and slid on its hinge *b*, along the pin *k*, until the part *l* touches the part *l*, a process during which a small catch, *m*, hooks back into the breech, by its projecting rim, the empty cartridge-case. The canting of the rifle to one side now

## BREECH-LOADING ARMS AND NEEDLE-GUNS.

throws this out, a spring within the hinge moves the breech-piece to its former place, and the gun is ready for another charge.

The cost of altering an 'Enfield' to a 'Snider' varies from 15s. to 20s. Up to the present time (1876), upwards of a million have been converted, and a large number of new arms made for our own government; but conversion and manufacture are now suspended both in the government factories and by the large small-arms companies. The government factories were capable of converting 1100 rifles daily.

At first, the firing of the Snider was inferior to the old Enfield; but, by alterations in the bullet, effected by Colonel Boxer, in the direction of decreasing the specific gravity at the apex by the insertion of a wooden plug (which is now, however, dispensed with, and the point of the bullet spun over the mouth of the cavity), this condition has been reversed, and the Snider now fires 30 per cent. better than the old Enfield. Of course, these changes add to the cost of the cartridge, which has, however, these great perfections—first, that it is absolutely impervious to wet; and second, that fire can scarcely be communicated to it otherwise than through the detonating cap. A single cartridge has been fired within a barrel of loose cartridges without exploding any of the others.

Adverting to the Snider cartridge, fig. 5, the whole is enclosed in a roll of thin brass foil, outside which is a covering of paper, and having for its base an iron disc, in front of which is a double cup of thin brass, while a round of millboard or pulp encircles the chamber containing the percussion cap, which communicates with the powder. Between the powder and the ball is a layer of wool. The ball has, as explained above, the point spun over a cavity in its front, and a conical hollow is made at the base; into the wider part of this is dropped the wooden plug, while on the circumference of the bullet, and outside this conical hole, are four small cannellures or cuts in the lead. When the powder explodes, the wooden plug is driven forwards to the head of the hollow, driving the base of the bullet outwards till the lead completely fills

the grooves of the rifle—a process aided by the comparatively less resistance at the cannellures. These cannellures are also receptacles for a wax lubrication which prevents fouling, interposing always a film of wax between the bullet and the barrel. The charge and bullet are held together by the copper sheathing being pressed into the cannellures. Returning to the percussion-cap, we should find, if it were enlarged, an apparatus—as in fig. 9—where the cap is a thin copper cylinder open at front and closed at the rear end, where there is contained a deposit of detonating powder, *c*, of great sensitiveness. A brass bead, *b*, called the 'anvil,' is contained within the cap, the sharp point being next the detonating powder, and its broader end resting at the bottom of the cap-chamber on each side of the hole *d*. The cap itself fits tightly into the chamber, leaving no opening for the escape of gas backwards from the explosion, and is fired by the external blow of the piston or striker, which drives the base of the cap down upon the point of the anvil, by which means the detonating powder is exploded, and the flash, passing down the sides of the anvil, communicates through the opening, *d*, with the powder in the cartridge. The weight of the bullet is 480 grains; of the powder, 70 grains; the cost being about £3 per thousand.

From this description, it is evident that the Snider cartridge is a complicated arrangement; but it is not much more so than that of the Zündnadelgewehr, though vastly more efficient.



Fig. 9.—Snider Cap.

In comparing the Snider and the Prussian gun, the former has certainly the greater simplicity; while its smaller weight (9 lbs. to 10½ lbs.) is an immeasurable advantage. Of the two it is probably the less likely to get out of order, but would perhaps be the most difficult to restore if it did. There is this difference of a material character between the two weapons, that in the Prussian arm,

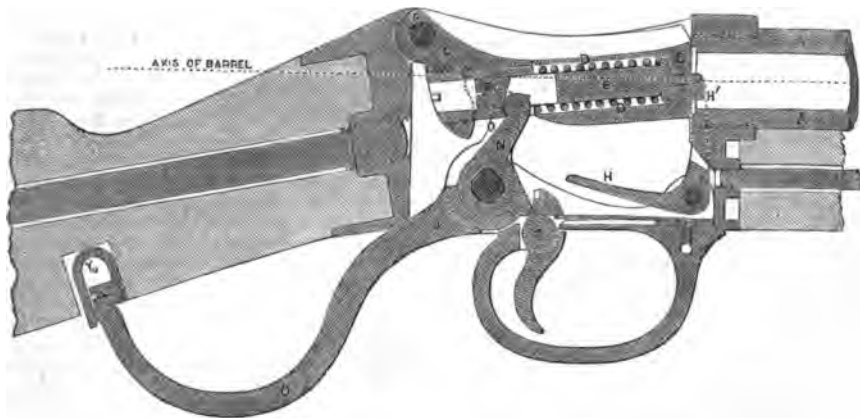

Fig. 10.—Section of Martini Breech Action : Closed.

the needle, by its own mechanism, fires the charge; while in the Snider, it is a mere medium for conveying the blow of the hammer.

The breech-action of the Martini-Henry rifle, which has been adopted as the pattern for new rifles for the British army, will be understood from figs. 10 and 11.

The principle of the action consists in closing the breech by a falling block, *C*, working in a morticed breech body, and hinged on a pin, *F*, at the back end, and falling in front sufficiently when open to clear the opening of the barrel; the top of the breech-block forms an inclined groove, along which the cartridge is slipped into the barrel *A*. The

ordinary gun lock is replaced by a direct acting striker E, impelled by a spiral spring, D, both being contained within the breech-block. The act of opening the lever, O, draws down the breech-block, simultaneously drawing back the striker, and compressing the spiral spring; at the same time the toe of the cranked extractor, H, is struck by the breech-block, thus throwing its upper claws, which

encircle the base of the cartridge-case, backward, and jerking out the used case. On a fresh cartridge being inserted, the lever, O, is drawn back and fixed to the stock by the spring Y. This closes the breech, but the spiral spring is kept compressed, and the striker at the full-cock position, by the tumbler, N, into the bent of which the point of the trigger and the tumbler-rest entered when the breech was

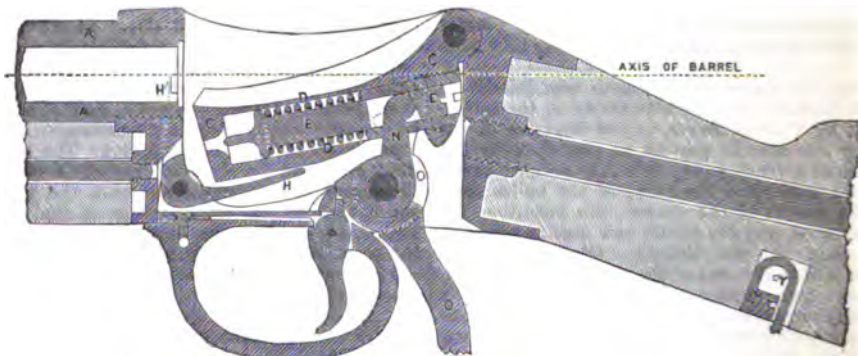

Fig. 11.—Section of Martini Breech Action : Open.

opened. The trigger being pulled, the tumbler, N, is let loose, and the spiral spring discharges the pointed end of the striker, E, on to the cap in the rear-end of the cartridge, which is thus fired.

Fig. 12 represents, in section, the Boxer-Henry cartridge for Martini-Henry rifle.

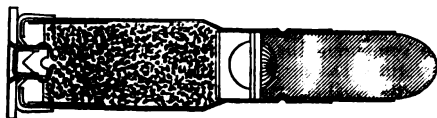

Fig. 12.

The following table shews at a glance the breech-loading rifles in use in 1875 by the principal powers :

Country.	System adopted.	Bore.		Weight of Bullet.		Weight of Powder.	
		Inch.	Lbs.	Grains.	Grains.		
Austria .....	Werndl.....	.432	9.88	313	62		
Bavaria .....	Werder .....	.433	9.70	338	66		
Belgium .....	Albini- Braendlin	.433	10.14	386	77		
Denmark .....	Remington...	.450	9.08	386	60		
	Snider .....	.577	9.06	460	70		
England .....	Martini- Henry	.450	8.75	460	85		
France .....	Chassepôt...	.433	8.93	386	85		
Germany .....	Mausor .....	.433	10.75	378	71		
Holland .....	Beaumont...	.433	9.59	386	66		
Italy .....	Vetterli...	.412	6.61	316	54		
Russia .....	Berdan .....	.420	8.48	370	78		
Sweden .....	Remington...	.480	9.56	370	66		

The breech-loaders with and without the needle-arrangement are too numerous even for mention. In addition to what are known as breech-loaders proper, there are repeating-arms, one of the most remarkable of which is the Spencer Magazine Rifle, having, in a tube in the stock, a series of cartridges, which, by a simple action, pass into the barrel for discharge. As the gun can ordinarily be loaded at the breech without drawing on the magazine, it is doubtless that this reserve would be a powerful means of defence in a moment of danger, as in resisting cavalry; but among its drawbacks are weakening of the stock, serious increase of weight,

and worst of all, great complexity and delicacy—fatal objections in the rough usage of active service. Nearly all sportsmen now use breech-loading guns.

BRENNER PASS, a pass in the main chain of the Alps, on the road between Innsbruck (q. v.) on the north and Botzen (q. v.) on the south, connecting the south of Germany with Venice and the north-east of Italy. The B. P. is the lowest which crosses the main chain of the Alps, the summit being only 4775 feet above the level of the sea. Lofty mountains rise above it to the further height of more than 7500 feet, yet the scenery of the pass is less sublime and less interesting than that of any other of the great passes of the Alps. It is open at all seasons of the year. At the summit of the pass is the village of Brenner, a resting-place for travellers, with a pop. of about 400. The climate here is so severe that corn seldom ripens. Here the traveller finds in close contiguity the Eisach, a small stream, which, after growing to be a considerable river, joins the Adige, and the Sill, a tributary of the Inn; the one stream flowing to the Gulf of Venice, and the other into the Black Sea. On 18th August 1867, a railway through the B. P. was opened, and thus a complete line of railway communication was established between Germany and Italy; Botzen having already been connected by a railway through the valley of the Adige, with Verona, and so with the whole of Italy—Innsbruck being likewise connected with the railway system of Germany. This work was begun by the Austrian government when Venetia belonged to the Austrian Empire, and with the view not only of facilitating military operations, but of restoring the commercial prosperity of Venice, by making it the port of Southern Germany. The prosecution of the works, however, was not arrested by the great political changes which took place. A liberal commercial treaty, recently made between Austria and Italy, binds the two countries together in community of interests, restoring, in fact, the natural state of things with which political animosities had long interfered; and it has been made quite apparent, from the activity with which the roads have been repaired on some of the Alpine passes, and particularly that of the Stelvio, that both Germans and Italians appreciate the importance of an intimate commercial intercourse. The distance from

Innsbruck to Botzen in a direct line is only 52 miles, but by the windings of the road or of the railway, it is much increased.

**BREZOWA**, a market-town of Hungary, in the county of Neutra, on a river of the same name, about 19 miles north-west of Leopoldstadt. It has a Roman Catholic church and a Protestant church, tanneries, and distilleries. Pop. (1869) 5886.

**BRIERLY HILL**, an ecclesiastical district of Staffordshire, England, two miles north-north-east from Stourbridge, on the Oxford, Worcester, and Wolverhampton Railway. It is a place of much activity, the district abounding in coal, iron, and fireclay; and there are here numerous collieries, large iron-works, glass-works, brick-works, and potteries. The manufacture of steam-boilers is extensively carried on. Pop. (1871) 11,046.

**BRITANNIA METAL**. The present composition of Britannia metal at Birmingham is usually 90 tin + 8 antimony + 2 copper, without any zinc or bismuth; although some manufacturers deviate a little from this formula, by adding one or both of the metals last named. The manufacture was begun at Sheffield by Hancock and Jessop, in 1770; it reached Birmingham towards the close of the century, and made gradual progress. At first, the articles were made by stamping with dies, and soldering up into form; this, being a slow operation, rendered the articles expensive. Afterwards, the curious process of *metal-spinning* was introduced; and this, with the subsidiary operation of swaging, rendered a great reduction in price possible. In the spinning process, a thin sheet or piece of Britannia metal is placed upon a wooden model shaped like the article to be made; the model is made to rotate in a lathe; and burnishers and other tools are employed to press the yielding metal into all the curvatures of the model. Ductility is an essential quality to the attainment of this end with the metal; how complete it is, may be seen in such articles as Britannia metal teapots and dish-covers, the principal forms of which are not given by hammering, stamping, or casting, but by spinning. Besides spinning and swaging, the processes include stamping, soldering, casting, and polishing. When electro-plating was introduced, an increased use of Britannia metal arose, as it forms a good ground or basis for the deposited silver. Britannia metal spoons and ladles, made by casting, stamping, and burnishing, have been nearly driven out of the market by German silver; but the former metal is more largely used than ever for hot-water jugs, soup tureens, gravy-dishes, vegetable and side dishes, dram bottles, drinking-cups, sandwich cases, wine-coolers, soap-boxes, liquor-frames, cruetts, waiters, trays, &c.; and as a basis for electro-plate. Birmingham is the chief seat of the manufacture.

**BRIXHAM**, a market-town and seaport of Devonshire, England, beautifully situated on the south side of Tor Bay, 5 miles south from Torquay, and 22 miles directly south from Exeter. The town occupies the sides of two hills, and is divided into two parts, called Upper and Lower B., the former consisting chiefly of a long straggling street. Some of the more recently erected parts of the town are well built, and contain good houses, but the older parts are mean. The prosperity of B. depends chiefly on its fisheries, it being the head-quarters of the great Devonshire fishery of Torbay, in which many vessels are employed, mostly trawlers, of which there are about 200. These are decked sloops of 40 to 50 tons burden, and generally managed by three men and a boy. Great quantities of fresh fish are sent to London, Bath, and Bristol. Considerable quantities of iron ore are raised in the neighbourhood and

shipped here. B. has also a number of vessels engaged in the coasting and foreign trade, the foreign trade being chiefly with the Mediterranean. The Admiralty have an establishment here for watering the navy. Near B. is a station of the South Devon branch of the Great Western Railway. It was at B. that the Prince of Orange, afterwards William III., landed, November 4, 1688. Pop. (1871) 4941.

**BROMSGROVE**, a market-town of Worcestershire, England, near the small river Salwarp, 12 miles south-south-west from Birmingham. It is 1½ mile east from a station on the Birmingham and Bristol Railway. The Birmingham and Worcester Canal also passes near it. It is situated in a highly cultivated and richly wooded valley. The principal street is about a mile in length. There is a very flourishing grammar-school, founded by Edward VI. in 1553. The linen manufacture was formerly carried on at B.; button-making and nail-making are at present the principal branches of industry. B. returned two members to the House of Commons in the reign of Edward I., but was afterwards disfranchised on petition of the inhabitants themselves, because the trade of the town had declined. Pop. (1871) 6967.

**BROOKS, CHARLES SHIRLEY**, novelist and journalist, was the son of Mr William Brooks, an architect, and was born at Brill, in Oxfordshire, about the year 1820. B. was educated chiefly by the late Rev. T. J. Bennett, canon of St Paul's; and upon leaving school, was articled to an attorney. Upon serving out his time, he passed with distinction the examination in the Law Society's Hall. Literature, however, had more charms for him than the law, and he had not long been settled in London, before he tried the experiment of living by it as a profession. He wrote dramas—*Our New Governess*, *Honours and Tricks*, *The Creole*, *The Daughter of the Stars*; and he contributed at the same time to some of the leading periodicals and journals. An introduction to the editor of the *Morning Chronicle* procured him a steady engagement as writer of the Parliamentary Summary for that journal. He was also sent by the proprietors of the *Chronicle* on a mission into Russia, Syria, and Egypt, to report on the condition of labour and the poor in those countries; and the results of his observations appeared in a series of letters in that journal. B. was also a contributor to *Punch* from the commencement of that periodical. The 'Essence of Parliament' in *Punch* is said to have been regularly contributed by him. He also wrote for it 'Miss Violet and her Offers,' 'The Naggletons,' &c. B. also contributed political and other articles to the columns of the *Illustrated London News*. As a novelist, B. is a graceful and pleasing writer, and therefore deservedly popular. He is author of *Aspen Court*, *The Gordian Knot*, *The Silver Cord* (originally published in *Once a Week*), and *Sooner or Later*. B. is likewise author of *The Russians of the South*. He acquired a reputation as a lecturer. On the death of Mr Mark Lemon, in 1870, B. became the editor of *Punch*. He died in 1874. A volume of his *Wit and Humour* appeared in 1875.

**BROOM-CORN**, a grass cultivated in North America for the manufacture of brooms and whisks, which are made of the tops of the culms and the branches of the panicle. It is regarded as a mere variety of the same species (*Sorghum saccharatum*), of which the shaloo, or sugar-grass (see *SUGAR-CANE* and *DURRA*), is another variety. It has been much longer cultivated in North America, however, than the sugar-yielding variety. Its introduction is ascribed to Dr Franklin, who, seeing an imported



whisk in the possession of a lady of Philadelphia, found a single seed on it, and planted it. It is said to have been brought from the East Indies. It is now extensively cultivated in all parts of the United States, and especially by some branches of the religious society called Shakers. The manufacture of brooms is annually becoming of greater importance, much capital being invested in it. The crop of B. has a beautiful appearance when near maturity. It often attains a height of 12—15 feet. The stalks are long and hard, and mostly used for manure, although cattle will feed on them before they are touched by frost, and cattle are very fond of the leaves. The seed is used like Indian corn, for feeding poultry, and sometimes for feeding cattle and horses. The usual practice in harvesting B. is to bend the stalks 2½—3 feet from the ground, and leave them a few days to dry, then to cut them over 6—8 inches below the panicle, laying the tops in heaps, to be conveyed to the scraper, which is often wrought by horse-power, and which removes the seed from them. Improved machinery has recently begun to be employed in the manufacture of brooms and whisks from B., and they are therefore produced with much greater rapidity than before. It is supposed that, in 1860, about 10,000 acres of B. were cultivated in the state of New York, 9000 in Illinois, 6000 in Ohio, and about an equal amount in all the other states of the Union, or 30,000 acres in all; the value of the produce about 1,590,000 dollars. Great numbers of brooms and whisks of this material are exported to Britain.

**BROWNE, CHARLES FARRAR**, an American humorist, better known as 'ARTEMUS WARD,' was born in Waterford, Maine, in 1836, and graduated from the free village school into a printing-office—the American boy's college. As a printer's boy, he worked in all the principal towns in New England, until settled at Boston, where he began to write comic stories and essays. A roving disposition carried him to the West, and he was engaged as local editor in Toledo, and later in Cleveland, Ohio, where his letters from 'Artemus Ward, showman,' a pretended exhibitor of wax figures and wild beasts, first attracted general attention. In 1860, he became a contributor to *Vanity Fair*, a New York comic weekly paper; and being invited to lecture, soon became very popular and attractive. As a lecturer, in 1863, he visited California, making the overland trip, visiting Salt Lake City, the Mormon capital, and drawing crowds in every town he visited. In 1864, he opened his illustrated lectures on California and Utah in New York with immense success; and in 1866, was induced to visit England, where he became a contributor to *Punch*, and gave his lecture on the Mormons in the metropolis, at the Egyptian Hall, Piccadilly. But while convulsing crowded audiences with laughter, he was wasting with pulmonary disease. Early in 1867, he went to Guernsey for a milder air, but with no benefit; and was about to embark for America, when he died at Southampton, March 6, 1867. He was tall, slender, with striking features, and a most amiable character, which attracted and attached to him many friends. By his will, after providing for his mother, leaving legacies to his friends, and his library to the best boy in the school of his native village, he left the bulk of his property in trust to Horace Greeley to provide an asylum for printers. His collected writings, which have had a wide circulation in America and England, are *Artemus Ward His Book*; *Artemus Ward among the Mormons*; *Artemus Ward among the Fenians*; and a posthumous collection and biography entitled *Artemus Ward in England*.

**BRSHES'NY**, an insignificant town of Poland,

in the government of Piotrkov, 62 miles south-west of Warsaw, near the railway that connects Warsaw with Vienna and other places. Pop. (1867) 6040.

**BRYOPHYLLUM** (Gr. *bryon*, moss, and *phyllon*, a leaf), a genus of plants of the natural order *Crossulaceae* (q. v.). *B. calycinum*, a succulent shrubby plant, a native of the Moluccas, with quinate or almost pinnate leaves, oblong deeply crenulated leaflets, and panicles of large pendulous greenish-yellow flowers, is not unfrequent in British hot-houses, being regarded as an object of interest, upon account of its producing buds on the edges of the leaves more frequently than almost any other plant. These buds are capable of forming independent plants. This curious mode of propagation is found also in the Bog Orchis (*Malaxis paludosa*), a plant of a very different natural order. See **BUD** and **LEAF**.

**BRUISE**, or **CONTUSION**, signifies an injury inflicted by a blow or sudden pressure, in which the skin is not wounded, and no bone is broken or dislocated. Both terms, and especially the latter, are employed in surgery to include all such injuries in their widest range, from a black eye to a thoroughly crushed mass of muscle. In the slighter forms of this injury, as in ordinary simple bruises, there is no tearing, but only a concussion of the textures, the utmost damage done being the rupture of a few small blood-vessels, which occasions the discoloration that is always observed in these cases. In more severe contusions, the subjacent structures—muscles, connective tissue, vessels, &c.—are more or less ruptured, and in extreme cases, are thoroughly crushed, and usually become gangrenous. The quantity of blood that is extravasated mainly depends upon the size and number of the ruptured blood-vessels, but partly also on the nature of the textures of the injured part. Thus, a lax tissue, as that of the eyelids, favours the escape of blood into the surrounding parts. Moreover, the constitution of the patient has some influence, and many persons, especially (according to Mr Paget, in his article on 'Contusions' in Holmes's *System of Surgery*, vol. i.) pallid, fatty, soft-skinned women, though suffering from no apparent disease, are subject to extravasations, and consequently to discolorations, very disproportionate to the injuries that cause them.

The most characteristic signs of a recent contusion are more or less Shock (q. v.), pain, swelling, and discoloration of the surface from effused blood (commonly known as *Echymosis*, q. v.). There is nothing special in the character of the shock, but it is worthy of notice that it is most severely felt in injuries of special parts—as the testes, the breasts, and the larger joints, which are often followed by remarkable general depression, faintness, loss of muscular power, and nausea. The immediate pain following the blow is succeeded by a feeling of numbness, which, after a varying time, unless the part is killed, gives place to a heavy, aching pain. Although some depression may usually be observed immediately after the infliction of the blow, swelling of the parts rapidly follows, as may be well seen in the case of a child receiving a blow on the head, or of the wale that rises after the lash of a whip. In lax parts, such as the eyelids, the swelling is often considerable, and may remain for a week or more; but in other parts, it usually subsides in two or three days. The discoloration of the skin consequent on blows is of a more or less purple tint, varying from black to crimson or pink. 'Blackness,' says Mr Paget (*op. cit.*), 'usually indicating intense injury, is probably due to the extravasation of a large proportion of entire blood; crimson or pink tints, to the prevalence of a blood-stained fluid;

blue, to the degrees in which blackness is veiled by the cuticle and skin, as the colour of blood in veins is; and perhaps some of the shades of pink to the partial aëration of the blood by the penetration of air through the epidermis. After a variable time, proportionate to the severity of the injury, these colours fade out, passing most commonly through gradually lightening shades of brownish olive, green, and yellow.' The causes of these changes of colour are not clearly known; as, however, the changes are not observed in bruises of parts removed from air and light, they are probably due to oxidation and actinic agency. When a severe bruise tends to a natural cure, and there is no inflammation or sloughing, the effused blood is generally absorbed, the liquid portion rapidly disappearing, while the blood-cells are more slowly removed. In some cases, it is probable that the effused blood becomes organised into vascular connective tissue, which takes part in the repair of the injured tissue. We need not follow the course of a bruise in which active inflammation with suppuration ensues, or in which sloughing takes place, as these complications must be treated according to the ordinary rules for those affections. There are, however, one or two ill consequences following partial recovery, which require notice. Thus, in some organs, as the breast, abscess may ensue long after a blow; or a sensitive indurated lump may remain; or (more commonly) there may be long-continued pain, without change of texture; or, lastly, cancer may ensue. Blows on superficial bones, as those of the skull, are not unfrequently followed by very painful thickening of the periosteum; and a muscle violently struck may be paralysed, and rapidly waste away; and constitutional diseases, such as gout and rheumatism, are well known to localise themselves with special severity in parts that have once been seriously bruised.

With regard to treatment, simple and not very severe bruises require little treatment but the rest necessary for the avoidance of pain; but the removal of the swelling and discoloration may be hastened by the application of various local stimulants, which seem to act by accelerating the circulation through the bruised part, and promoting the absorption of the effused fluid. Friar's balsam, compound soap liniment, or poultices made with the roots of black bryony beaten to a pulp, are popular remedies of this class. Mr Paget regards the tincture of arnica as the best application. Where the skin is thick, it may be gently rubbed over the bruised part in an undiluted state; where the skin is thinner, it should be mixed with an equal bulk of water; or, which is probably better, it may be constantly applied as a lotion if diluted with five or six parts of water. Pugilists, who are probably better acquainted with ordinary bruises than any other class of men, are in the habit of removing the swelling of the eyelids that often naturally occurs during a prize-fight, to such an extent as to close the eyes, by at once puncturing the eyelids at several points with a lancet; and their favourite remedy for a black-eye or other bruise on the face is a fresh beef-steak applied locally, as a poultice. Bruises of a more severe nature, as when there is much breaking or crushing of the tissues, must, of course, at once be placed in the hands of a surgeon.—For further details on this subject, the reader is referred to Mr Paget's excellent article, from which we have freely quoted.

**BUCCARI**, or **BAKAR**, a free port of Austrian Croatia, an inlet of the Gulf of Quarnero, 5 miles east-south-east from Fiume. It is beautifully situated on the slope of a hill, and has a small but very good and safe harbour. The linen manufacture

is carried on here, and ship-building is actively prosecuted; but the inhabitants are principally sailors and fishermen. The tunny fishery is the chief fishery of this part of the Adriatic. The vine is extensively cultivated in the neighbourhood of B., and good wine is made. Pop. (1869) 2116.

**BUCKLAND**, **FRANCIS TRUVELYAN**, a son of the Rev. Dr Buckland (q. v.), born at Christ Church College, Oxford, December 17, 1826. He was educated at Winchester School, and at Christ Church College, Oxford. He devoted himself to the study of medicine; and after being house-surgeon of St George's Hospital, London, was appointed assistant-surgeon to the 2d Life-guards in 1854, retiring in 1863. From his boyhood, he manifested an enthusiastic delight in natural history, especially when it could be applied practically to the cultivation of useful quadrupeds, birds, or fish, in which study he was encouraged and guided by his father. He has contributed a vast number of brief papers on various branches of his favourite science to the *Times*, *Field*, *Queen*, *Land and Water* (of which he is editor), &c. He is also the author of *Curiosities of Natural History* (Lond. 1857; second series, 1860; third series, 2 vols., 1866); of a work entitled *Fish-hatching* (Lond. 1863); and *Logbook of a Fisherman and Zoologist* (1876); and editor of a new edition of his father's *Bridgewater Treatise* (Routledge, 1858); and of *White's Selborne* (1876). He was first secretary to the Acclimatisation Society of Great Britain and Ireland. He is an acute observer, and his writings on subjects of natural history in great part exhibit the results of fresh and original observations, which his sprightly style exhibits in a most interesting manner. He has long taken a great interest in fish-culture, and has been actively concerned in the recent endeavours to promote it in England. He has, at his own cost, established under the Science and Art Department, South Kensington, a 'Museum of Economic Fish-culture,' illustrating the natural history of salmon and sea-fish by means of plaster-casts, which he makes with his own hands, and by preparations and dissections in spirits. In 1867, B. was appointed inspector of salmon fisheries for England and Wales, and in 1870, special commissioner to inquire into the effects of recent legislation on the Salmon Fisheries of Scotland.

**BU'ZACZ**, a town of the Austrian Empire, in Galicia, 30 miles east-north-east of Stanislawow, on the Stripa, a considerable affluent of the Dniester. A treaty of peace between the Poles and the Turks was signed here in 1672. Pop. 8500.

**BUDAON**, **BUDAUN**, or **BUDAYOON**, a town of India, 140 miles north-west of Lucknow, giving its name to a British district of the Rohilcund division of the lieutenant-governorship of the North-west Provinces. It is situated in 28° 2' N. lat., and 79° 11' E. long. Its pop. was officially ascertained in 1872 to amount to 33,322. It was occupied by the mutineers and a body of liberated prisoners from Bareilly, June 1, 1857. The Europeans escaped by flight. It was captured by General Whitelock, April 19, 1858, and the rebels in this quarter were soon afterwards entirely subdued.—The district of Budaon contains an area of 2005 sq. m., and a pop. (1872) of 934,348, of which nearly six-sevenths are Hindus, and the remainder mostly Mussulmans. The district is a level, fertile tract on the Ganges and tributaries of it, of which the chief is the Ramganga.

**BUDHA'NUH**, a town of India, in the British district of Mozuffurnuggur, North-west Provinces, on the route from Kurnool to Meerut, 43 miles south from Kurnool. The surrounding country is

wooded and well cultivated, and the bazar of the town is well supplied. Pop. (1872) 6162.

**BUFFO** (Ital. from corrupt Latin *buffa*, a slap on the cheek, as practised by clowns and mountebanks in farces), an Italian theatrical term applied to an actor or operatic singer who takes the light or humorous part in an opera or play. A burlesque opera is called *opera buffa*, and a burlesque play, *commedia buffa*.

**BUHREA'CH**, or **BHARAICH**, a town of Oude, India, the principal place of a district of the same name. It is in N. lat. 27° 34', E. long. 81° 33'—65 m. N.E. of Lucknow. It is an old town, of considerable size, situated in a pleasant wooded plain, on the left bank of the Sarju. The houses are mostly built of mud and covered with thatch; but the mausoleums, mosques, and residences of merchants are of brick and lime-mortar. North-east of the town is the tomb of Selar, a reputed Mussulman saint, to which there is a great concourse of pilgrims annually in the month of May. Pop. (1871) 18,889; of district, 774,640.

**BU'KKUR**, a town of Sind, about three miles east from the Indus, on a water-course derived from the great river, and flowing parallel with it, 190 miles west of Lahore. It is situated in a fertile district, and carries on an active commerce. Pop. 8000.

**BU'LLÆ** are collections of serous fluids of considerable size, situated immediately beneath the cuticle, and rising from the true skin. They differ from vesicles only in size; and no very definite line can be drawn between a large vesicle and a small bulla. They usually vary in diameter from a quarter of an inch to two inches. They may be followed by crusts or by ulcerations. They constitute a special order of skin-diseases, which includes Pemphigus and Rupia (q. v.).

**BULLAS**, a town of Spain, in the province of Murcia, and 26 miles west-north-west of the town of Murcia. It is situated on a hill, 1840 feet above the sea. The streets are steep and unpaved. B. has manufactures of linen and hempen fabrics, earthenware, and brandy, and a considerable trade in manufactured goods and grain. Pop. 5145.

**BULRAMPUR**, a town of Oude, India, near the frontier of Nepal, in N. lat. 27° 24', E. long. 82° 15', on the Raptee, in a plain, 90 miles north-east from Lucknow. It is a town of considerable size, but mostly of mud houses, covered with thatch. From B. there is a magnificent view of Dhawalagiri. The town is on one of the most frequented routes between Lucknow and Nepal, so that during spring and summer it is much thronged by traders, exchanging the products of Hindustan and Tibet. Pop. (1871) 14,026.

**BULSAR**, a seaport of India, in the British district of Surat, presidency of Bombay, on the estuary of a small river of the same name, which falls into the Gulf of Cambay. It is 44 miles south of Surat. It is a thriving place, with manufactures of ginghams, and a considerable trade in grain, salt, and sugar. Pop. (1871) 11,313, chiefly weavers and sailors, but partly also employed in agriculture.

**BULUGU'RH**, or **BALLAMGARH**, a town of India, the principal place of a jaghire of the same name, called also Furreedabad. The town is situated on the route from Delhi to Muttra, 29 miles south of Delhi, in a pleasant well-cultivated country. The town is not large, and is very crowded, surrounded by a high brick wall, with mud bastions and a deep ditch. The jaghire has an area of 190 sq. m., and its pop. is supposed to be about 57,000. The British have never interfered with the civil or criminal affairs of the jaghire,

except when their interference was requested, during the minority of the present rajah; but the Rajah of B. derives his rights from the British government. The revenue of the state is estimated at 160,000 rupees. The rajah maintains a small force of 100 cavalry and 350 infantry.

**BU'NDI**, or **BOONDEE**, a town of India, in N. lat. 25° 26', E. long. 75° 43', 190 miles south-west from Agra, the capital of a small state of the same name. It is situated in a valley nearly surrounded by rocky hills. The palace of the rajah is on the slope of the hill above the town, and is of great magnificence and beauty, consisting of a number of parts built at different dates, but harmonising extremely well together. The town contains few notable edifices. It has two good bazars, but it is a place of little commerce. It is celebrated for its iron manufactures.—The raj or state of Bundi has an area of 2291 sq. miles. A range of mountains, running north-east and south-west, divides two nearly equal level tracts—that on the south-east extending to the river Chumbul, and that on the north-west to the base of the mountains towards Ajmera. The climate is said to be unhealthy. Although the rajah and dominant portion of the inhabitants are Rajpoots, the greater part of the population, particularly in the mountains, are Meenas, supposed to be an aboriginal race, who are indefatigable freebooters. The military force of the state, including the troops of the feudal chiefs and the police force, is 6170 men. The revenue is about £50,000. Pop. of B. 224,000.

**BUNGAY**, a market-town of the county of Suffolk, England, 30 miles north-north-east from Ipswich. It occupies the sides and summit of a gently rising hill, on the right bank of the Waveney, and is a well-built town, with wide streets, the principal ones diverging from the market-place. The town grew around Bungay Castle, which is supposed to have been erected by the Bigoda, Earls of Norfolk, and of the walls of which some ruins still remain. The ruins of a Benedictine nunnery are also to be seen in the town. The Church of the Holy Trinity is an edifice with a round tower, supposed to be of the time of Edward the Confessor. There are numerous places of worship, belonging to different denominations, and schools, charitable institutions, assembly-rooms, &c. What was formerly the theatre is now used as a corn-hall. B. carries on a considerable trade by the river Waveney in corn, malt, flour, coals, and lime. Pop. (1861) 3806; (1871) 3903.

**BUNION** is a term applied in Surgery to enlarged bursæ, or synovial sacs, situated in the anterior part of the foot, and especially over the metatarsal joint of the first or the fifth toe (see *Foot*), and accompanied by more or less distortion of the joint. In the great majority of cases, bunions are directly produced by the pressure of badly-fitting boots; and if the boots are constructed of patent leather, or any material which stops the excreting action of the skin, this, too, may be regarded as an indirect cause of their formation. A bunion begins as a painful and tender spot over one of the metatarso-phalangeal joints; the part gradually enlarges, and there are indications of an effusion into a natural bursa or a newly-formed sac. The progress of the affection may stop here, the bursa remaining, and serving to protect the subjacent parts from pressure; but far more frequently it undergoes repeated attacks of inflammation, causing its enlargement; or becomes the seat of corns; or suppurates; the contents of the cyst ensues. The last accident may be followed either by obliteration of the cyst and cure, or by a troublesome form of ulcer, especially in persons of languid circulation.

It is only in its early stage that there is any hope of removing the disease; subsequently, the treatment must be only palliative. The tender spot that precedes the enlargement should be covered by night with wet lint and oiled silk, while by day a boot or shoe exerting no pressure on the part should be worn. If the part is very tender, it may be covered during the day with soap-plaster spread on wash-leather. As soon as a cyst can be detected, the part should be occasionally treated with strong tincture of iodine, with the view of promoting absorption. The writer of the article on this subject in Holmes's *System of Surgery*, recommends an ointment of biniodide of mercury (ten grains to an ounce of lard) for the cure of bunions when uninfamed, and for such as have much fluid within them. It should not be applied so constantly as to blister the skin. When, from any cause, inflammation takes place in the sac, water-dressing, or a poultice, should be applied; and as soon as there are definite signs of suppuration, a free incision should be made, which at once relieves the pain, and is often followed by a complete cure.

The ulcers resulting from the bursting of a bunion are very difficult to heal, especially in old persons whose circulation is languid. Stimulating local applications, such as ointment of resin, should be applied, while opium and stimulants should be prescribed for internal use, together with nourishing diet. Such ulcers, under the best treatment, not very unfrequently form the starting-point for senile gangrene.

**BUNZLAU, JUNG or NEUE** (*New Bunzlau*), a town of Bohemia, on the left bank of the Iser, a tributary of the Elbe, 31 miles north-east from Prague. It is well built of stone, has several churches, a Jewish synagogue, barracks, a hospital, a Piarist gymnasium, &c. It has manufactures of cotton and woollen fabrics, soap, and leather. It is said to have been founded by King Boleslaf in 973, and the fort built by him still exists. Its Bohemian name is *Mlada Boleslav*. Pop. 5000.

**BURDETT-COUTTS, THE RIGHT HON. ANGELA GEORGINA, BARONESS**, daughter of Sir Francis Burdett, was born in 1814. In 1837, she inherited much of the property of her grandfather, Thomas Coutts, the banker, on the death of his widow, who died Duchess of St Albans. The liberal and public-spirited use she has made of this wealth, in her efforts to mitigate the sufferings of her fellow-creatures and the lower animals, has rendered her name well known and deservedly popular. Besides spending large sums of money in building and endowing several churches and schools, she endowed the three colonial bishoprics of Cape Town, Adelaide, and British Columbia, at an outlay of about £50,000, and founded an establishment in South Australia for the improvement of the aborigines. In her zeal for the good of her own sex, she effected important reforms in the teaching of girls at the National Schools, and established a shelter and reformatory for fallen women. To the city of London she has presented, besides several handsome fountains, the Columbia Market, Bethnal Green, for the supply of good and wholesome food in a poor district. She also built Columbia Square, consisting of model dwellings at low rents, for about 300 families; and, taking great interest in emigration, has assisted many poor families in their passage and outfit. Her private charities have been on a corresponding scale; and she is also a liberal patroness of art. In 1871, she accepted a peerage from government, with the above title. In 1872, the freedom of the City of London was conferred upon her (the first woman who ever received it); and in 1874 she received the same honour from Edinburgh.

**BURHAUNPUR**, a large town of India, in the territory of Gwalior, or possessions of Scindia's family, on the right bank of the Tapti, in N. lat. 21 18', E. long. 76° 20', 280 miles north-east from Bom bay. The banks of the Tapti are here bold, rising 60 or 70 feet above the stream. The town is surrounded by a rampart of brickwork, and contains a palace built by Akbar. A few of the wealthie merchants have good houses, built of teak, and profusely decorated with carvings. The most wealthy and influential are the Borahs, a Mohammedai tribe, who inhabit a distinct ward, which they shut up at night, excluding all other persons. There are manufactures of muslins, flowered silks, and brocades, for which the place was formerly famous so that, in the 17th c., they were exported in great quantities to Persia, Egypt, Russia, and Poland.

**BURNS, REV. JABEZ, D.D.**, a Baptist minister and one of the most prolific religious writers of the 19th century, was born at Oldham, near Manchester in 1805, and was educated at Chester, and after wards at Oldham Grammar-school. After helping his father as a medical practitioner, and acting an assistant in a drapery establishment, he joined the Methodist New Connection, and removed at the age of 21 to London. In 1828 and 1829, he published his first two works, *The Christian Sketch-book* and *The Spiritual Cabinet*, which gained him much popularity among the religious public. After having exercised the functions of the ministry at Perth, in Scotland, for a few years, he returned to London in 1835, to become minister of the General Baptist congregation assembling in New Church Street Chapel Marylebone. Here his fame increased so much that it was found necessary twice to enlarge his chapel during the first 25 years of his ministry, in order to afford room for the large numbers who flocked to hear him. He was elected by the body to which he belonged to fill various posts of honour and lectured in all parts of the United Kingdom on temperance, peace, abolition of capital punishment, &c. In 1839, Dr B. became editor of the *Temperance Journal*. About 1846, he received the degree of D.D. from the Wesleyan University of Middleton, Connecticut. Meantime his pen has not been idle, the number of his separate works being upwards of thirty, some of them consisting of a number of vols., and one of them, *Sketches and Skeletons of Sermons*, of 15 vols., having reached the 14th edition. The following are the names of a few: *Christian Exercises for every Lord's Day* (1858); *Christian Philosophy* (1849); *Deathbed Triumphs of Eminent Christians*; *Light for the House of Mourning* (1850); *Pulpit Cyclopædia*, 10 vols. (1846—1860); *Marriage Gift-book and Bridal Token* (1862); &c., which are all highly popular among a large section of the English and American evangelical religious world. Dr B. died in 1876.

**BURNUGGUR**, a town of India, in Guzerat, the territory of the Guicowar, 52 miles north from Ahmedabad, in N. lat. 23° 48', E. long. 72° 38'. It is a place of considerable trade, which is mostly in the hands of wealthy Brahmans. Pop. 12,000.

**BURTON, RICHARD FRANCOIS**, one of the most daring and successful of modern travellers, was born in 1821 in Norfolk. He is the son of Colonel J. N. Burton, and was educated in France and England. In 1842, he entered the Indian army, and served many years in Sindh. While in this employment he exhibited a remarkable facility in acquiring the Eastern languages, and a still more remarkable dexterity in imitating the appearance and habits of the natives of India. In 1851, he published his first important work—*Sindh, and the Races that inhabit the Valley of the Indus*—full of graphic description

...sian, and Moutani. He had devoted special attention to Arabic, and had made such progress as to be able to speak it like a native. Possessed of these qualifications, he resolved to explore Arabia in the disguise of an Afghan pilgrim; and after a visit to England, he set out on his journey. Political commotions prevented him from traversing the whole country, as he intended; but his *Personal Narrative of a Pilgrimage to El Medinah and Meccah* (1855) records one of the most daring feats on record. A perpetual strain on the ingenuity was necessary to keep up his assumed character, most difficult in moments of fatigue, and in the midst of shrewd and observant fellow-travellers. The next journey undertaken by B. was into the country of the Somaulis, in Eastern Africa. It proved less successful than was anticipated. B.'s companion, Lieutenant Stroyan, was killed, and B. himself was wounded. He succeeded, however, in reaching Harar (q. v.), a most important town in Eastern Africa, not before visited by any European, and in penetrating a vast and populous region scarcely known to geographers. The journey led to a still more important series of expeditions—those to the country of the Upper Nile. Towards the end of 1856, B. set out in company with Lieutenant Speke, also of the Indian army, to ascertain the truth of the reports collected by the missionaries, that a vast sea existed in the heart of the continent. The journey is one of the most memorable of our time. It led to the discovery and exploration of the great lake of Tanganyika, and the opening up of the eastern part of the continent. B. was rewarded with the medal of the Geographical Society. His health had been affected by his African journeys, and he sought to recover it by a journey in North America, from which he brought the first reliable account of the Mormons. In 1861, B. was appointed consul at Fernando Po, on the west coast of Africa, and while holding this appointment, he visited the Cameroons Mountains, and went on a mission to the king of Dahomey, the incidents of both journeys being recorded in two of his most interesting works. B. has subsequently been consul at Santos in Brazil, and at Damascus; and on the death of Mr Charles Lever in 1872, B. succeeded him in the post of British consul at Trieste.

The following is a list of the principal works of Captain B. not mentioned above: *Sindh, or the Unhappy Valley* (1851); *Goa and the Bue Mountains, or Six Months of Sick-leave* (1851); *Falconry in the Valley of the Indus* (1852); *First Footsteps in East Africa, or an Exploration of Harar* (1856); *The Lake Regions of Central Africa, or a Picture of Exploration* (1860); *The City of the Saints, and Across the Rocky Mountains to California* (1861); *Abeokuta, or the Cameroons Mountains* (1863); *The Nile Basin*—Part I., shewing Tanganyika to be Ptolemy's Western Lake Reservoir, &c.; and Part II., Captain Speke's discovery of the source of the Nile, a Review by J. M'Queen; *A Mission to Gelele, King of Dahome, with Notices of the so-called Amazons, &c.*; *Explorations in the Highlands of Brazil*; *Vikram and the Vampire*; *Zanzibar*; *Two Trips to Gorilla Land*; *Ultima Thule, or a Summer in Iceland*; *Etruscan Bologna* (1876).

**BUSSAHR,** a hill-state of Northern India, on the border of Chinese Tartary, in N. lat. 30° 56'—32° 8', and E. long. 77° 34'—78° 52'. It is one of the most elevated and mountainous countries in the world, the lowest part being more than 3000 feet above the sea, and much of it from 7000 to 12,000 feet. The Sutlej flows through the country from east to west. The district on the north of

southern frontier is almost tropical, and there are many genial and fertile districts of mild temperate climate; other districts are near, and within the limits of perpetual snow. The vine succeeds admirably in many places, and it is supposed that some parts of this state are extremely suitable for the culture of tea, which, indeed, is cultivated to some extent. Very rich deposits of copper ore have been discovered in Kunawur, and copper-mining is prosecuted near the south-west frontier. The inhabitants are little advanced in civilisation; many of those in the more northern parts have strongly marked Mongolian features. Polyandry prevails among them, and the females left unmarried take refuge in Lamaic convents. The rajah and upper classes in the southern parts are Rajpoots, and the people generally are of Hindû race. Their observance of Hinduism, however, is very partial. The Rajah of B. holds his dignity by a grant from the East India Company, made on the expulsion of the Ghoorkas in 1815. The tribute paid is £340. The pop. is estimated at 90,000. Principal productions are opium, grain, and woollen manufactures.

**BUSTO-ARSI'ZIO,** a town of Northern Italy, in the province of Milan, and 20 miles north-west from Milan. It stands in a fertile plain, which produces much wine. In one of the churches are numerous statues and fine paintings, by Daniel Crespi, a native of the town. Remains of ancient buildings shew that B. was in ancient times of considerable importance. It is a place of active trade, and has a cotton-thread factory. Pop. of town and suburbs, 12,909.

**BUTERA,** a town of Sicily, in the province of Caltanissetta, and 8 miles north-north-west from Terranova. It stands on a height on the left bank of the Manfria. Ruins of great antiquity exist in the neighbourhood, but the ancient name is unknown. In 853, B. was besieged for five months by the Saracens, who raised the siege on the surrender of 6000 people as slaves. B. was almost the last town in Sicily taken by the Normans, having held out against Count Roger till 1089. The present castle is of Norman erection, and contains a number of mediæval antiquities. Pop. 5150.

**BUTLER, BENJAMIN FRANKLIN,** general of Volunteers, U. S. army, was born at Deerfield, New Hampshire, November 5, 1818. He graduated at Waterville College, Maine, in 1838, studied law at Lowell, Massachusetts, where he was admitted to the bar in 1841, and became distinguished as a criminal lawyer and democratic politician. He was a member of the state legislature in 1853, of the state senate in 1859—1860, and a delegate to the Democratic National Conventions at Charleston and Baltimore in 1860, where he supported the nomination of Jefferson Davis and John C. Breckenridge, and was nominated as the Democratic candidate for governor of Massachusetts. B. had risen to the rank of brigadier-general of militia; and at the outbreak of the War of Secession, April 17, 1861, he marched with the 8th Massachusetts Brigade, and after a check at Great Bethel, was appointed to the command of Baltimore, and subsequently of Eastern Virginia, with his head-quarters at Fortress Monroe. In February 1862, he commanded the military forces sent from Boston to Ship Island, near the mouth of the Mississippi; and after New Orleans had surrendered to the naval forces under Commander Farragut, he held military possession of the city, and by his severity, and especially by an, at least apparently, atrocious order respecting the treatment of women, brought upon himself the intense detestation of the Southern people, and a very general

Grant in his operations against Petersburg and Richmond, and, June 13, 1865, by his refusal to co-operate with the naval forces, caused the failure of the first attempt to take Fort Fisher, the chief

politics as an extreme Radical, advocated the impeachment of President Johnson; and in 1866, was elected member of the House of Representatives of the U. S. Congress.

## C



**ABEZA DEL BUEY**, a small town of Spain, in the province of Badajos, 86 miles east-south-east of the town of Badajos, on the north slope of the Sierra el Pedrosa. The town is tolerably well built, and has a number of churches and other public buildings. Pop. 5395, engaged chiefly in the manufacture of woollen and linen cloths.

**CADA'MBA**, or **KUDUMBA**, the wood of several species of *Nauclea*, a genus of trees of the natural order *Cinchonaceae*, natives of the East Indies, having flowers with a funnel-shaped corolla. *N. cadamba* is a noble tree, with orange-coloured fragrant flowers, collected in heads about the size of a small apple. The leaves are from six to ten inches long. The wood is yellow, soft, and fine-grained. The tree is highly prized for the shade which it affords; the wood is used for various purposes. *N. cordifolia* is a large tree, plentiful in mountainous districts of Hindustan; the wood yellow, close-grained, and used for flooring-planks, packing-boxes, and many other purposes, as is also that of *N. parviflora*. All kinds of *C.* wood are, however, liable to be injured by moisture, and can only be used where they are to be kept dry.

**CAHETÉ**, or **CAETE**, a small town of Brazil, in the province of Minas Geraes, about 250 miles north of Rio de Janeiro. The town is tolerably built, has some churches, a hospital, primary school, electoral college. Agriculture and mining are carried on. Pop. about 6000.

**CAIVANO**, a town of Southern Italy, in the province of Naples, and 8 miles north of the city of that name. It was a place of considerable strength in the middle ages, and still retains many remains of its walls and towers, though they have suffered severely in the various revolutions of Naples. Pop. 10,000.

**CALABAR BEAN**, a very remarkable medicinal agent, which has been introduced into the new edition of the British Pharmacopoeia (1867). It is the seed of *Physostigma venenosum*, a twining, half-shrubby plant, a native of Western Africa, of the natural order *Leguminosae*, sub-order *Papilionaceae*, nearly allied to the kidney bean, but of a genus distinguished by the hood-shaped stigma, and the deeply-furrowed hilum of the seed. The following are the leading characters of the bean itself: 'About the size of a very large horse-bean, with a very firm, hard, brittle, shining integument, of a brownish-red, pale chocolate, or ash-gray colour. Irregularly kidney-shaped, with two flat sides, and a furrow running longitudinally along its convex margin, ending in an aperture near one end of the seed. Within the shell is a kernel, consisting of two cotyledons, weighing on an average

about 46 grains, hard, white, and pulverisable, of a taste like that of the ordinary edible leguminous seeds, without bitterness, acrimony, or aromatic flavour. It yields its virtues to alcohol, and imperfectly to water.' It is used in the form of an emulsion by the natives of Africa, as an ordeal when persons are suspected of witchcraft. About twenty years ago, Dr Christison very nearly fell a victim to his zeal for science in experimenting on some specimens of this bean which had been sent to Edinburgh by some African missionaries, dangerous symptoms having been produced by 12 grains of the kernel which he swallowed. In 1861, Dr Thomas R. Fraser tried the effects upon himself of doses of 6, 8, and 10 grains. The general symptoms were epigastric uneasiness, great feebleness, dimness of vision, salivation, giddiness, and irregular, feeble, and slow heart's action. About the same time, he made the interesting discovery, that when placed on the eyeball this substance contracts the pupil, and produces near-sightedness; and it is now frequently employed for these purposes by ophthalmic surgeons. In 1864, 50 children were poisoned by eating these beans, which were swept out of a ship at Liverpool. A boy aged six years, who ate six beans, died very rapidly. The chief symptoms in these cases were griping, vomiting, and contracted pupils; the face was pale, the eyes bright and protruding, and in trying to walk, the children staggered as if they were drunk. Dr Fraser, in a paper which he communicated to the Royal Society of Edinburgh in 1866, maintains that, in mammals, death is generally produced by a combination of syncope (faintness) with asphyxia (suffocation); the symptoms of the one or the other depending on the dose, which, when large, at once destroys the heart's action. It has been used medicinally in small doses (one to ten grains of the powder, or  $\frac{1}{4}$  to  $\frac{1}{2}$  of a grain of the extract) in chorea, tetanus, general paralysis of the insane, and other diseases of the nervous system. Being now a recognised medicinal agent, it is satisfactory to know that the dangerous and even fatal effects of excessive doses may be prevented by administering belladonna (night-shade), or its active principle, atropia, as a counter-poison. This fact has been established by Dr Fraser in a communication to the Royal Society of Edinburgh, embracing the results of 500 experiments on dogs and rabbits. So unmistakable is the power of the antidote, that it can prevent even three times a fatal dose of the kernel from causing death in those animals. Belladonna has also an opposite action on the eye to that of this substance, as it dilates the pupils and produces long-sightedness. When the pupil is contracted by Calabar bean, it may be dilated to its normal, or to a greater, size by belladonna; and when it is dilated by belladonna, it may be reduced to its normal, or to a less, size by Calabar bean.

Sicily, near its centre, 2½ miles south-east of Palermo, in the province of Caltanissetta. The town is mean and dismal looking, and is built on a steep and isolated height, the summit of which is 2570 feet above the sea, and commands a magnificent view. It was founded in 1080. The only object worthy of notice is the tower of the principal church, which is of early architecture. Pop. 5600.

CALLA, a genus of plants of the natural order Araceae, or, according to some botanists, of the



*Calla palustris.*

natural order *Orontiaceae*, which is distinguished from *Araceae* only by having hermaphrodite flowers. The genus *Calla* is characterised by a flat spathe

as a mere mixture of stamens and pistils, and a one-celled ovary with 6-8 erect ovules. The known species are few, and natives of very different climates. *C. palustris* is found in swamps in Europe, Siberia, and North America, but not in Britain. It has a creeping root-stock, and heart-shaped, stalked leaves, the midrib of which is prolonged beyond the blade into a point; the spathe is white, and the spadix yellow. The root-stock is extremely acrid and caustic; but being deprived of its acridity by grinding, boiling, and macerating, is made by the Laplanders into a kind of bread called *Missebroed*, which they hold in high estimation.—The well-known and beautiful *Richardia Ethiopica* was formerly included in this genus, and is often still called *Calla*.

CALLERNISH, a district on the west coast of the island of Lewis, about 16 miles from Stornoway, remarkable for its circles of Standing Stones (q. v.). There are four circles, at no great distance from one another, but without any visible relation. The principal one, of which the figure gives a bird's-eye view, is of a more than usually elaborate design. 'A double line of upright stones run parallel to each other in a northerly direction, while a single line of similar stones is projected from the south, east, and west points, thus giving a cruciform figure to the structure. A stone of larger dimensions than any of the others occupies the centre of the circle, and completes the whole. . . . That the position was chosen and laid down from astronomical observation, can easily be demonstrated by visiting the spot on a clear night, when it will be found that by bringing the upper part of the single line of stones extending to the south to bear upon the top of the large stone in the centre of the circle, the apex of that stone coincides exactly with the pole-star. . . . The stones themselves are not

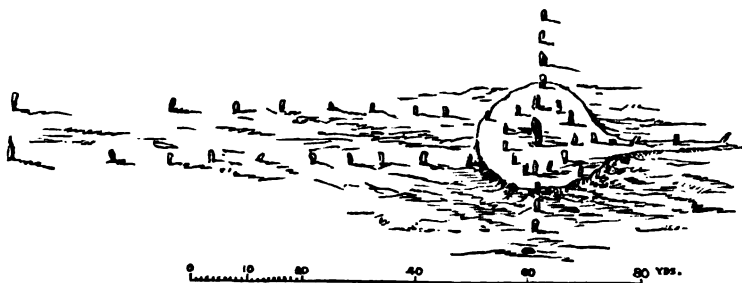

Callernish Circle.

columnar, or shaped into any form; they are simply broad, flat blocks of gneiss—the all-prevailing rock from the Butt of the Lewis to Barra Head. The following are their dimensions: diameter of circle, about 40 feet; length of west line, 43 feet; length of east line, 38 feet; length of south line, 69 feet; length of avenue, 270 feet; breadth of avenue, 27 feet; average height of stones, 6 to 8 feet; height of centre stone, 12 feet. There are 13 stones in the circle including the centre one, 19 in the avenue, 5 in each of the east and west, and 6 in the south arm. The measurements of height are taken from the present level; but it must be borne in mind that there is a bed of peat-moss, 4 or 5 feet thick, through which the stones rise from the clay beneath; this gives a height of 16 to 17 feet to the centre stone, and from 10 to 13 feet to the

others, exclusive of the foundation.'—*Notice of the Stone Circle at Callernish*, communicated to the Society of Antiquaries of Scotland, by Mr Henry Callender, March 1857.

CALTABELLO'TA (a Saracenic name = 'the Castle of the Cork-trees'), a town of Sicily, Girgenti, 7 miles north-east of Sciacca, most picturesquely situated around an ancient castle, which crowns a steep rock overhanging a stream (anc. *Crimisus*), of the same name as the town. Of its churches the *Chiesa Matrice* is a beautiful relic of the middle ages, resembling a mosque, with a single row of columns down the middle. C. was captured by the Saracens in 840 A.D. Pop. 6200.

CALTAVUTURO, a town of Sicily, province of Palermo, and 37 miles south-east of the city of that

name, on a small river, the Granda. The town is of Saracenic origin. Jasper is found near C. Pop. 5000.

CALW, or KALW, an important manufacturing town in Württemberg, chief seat of the Württemberg timber-trade with Holland, and capital of a bailiwick of the same name, in the circle of the Black Forest, lies in the valley of the Nagold, on both sides of the stream, over which are two stone bridges. Cotton and woollen spinning, dyeing turkey-red, manufacturing woollen and cotton fabrics, making leather, stout shoes, cigars, &c., are the principal industries. Though the streets in the old town are irregularly built, there are many large and beautiful houses. Pop. (1871) 5582, nearly all Protestants.

CAMDEN, a city of New Jersey, U.S., on the left bank of the Delaware River, opposite Philadelphia, with which it is connected by 4 steam-ferries. It is the terminus of the Camden and Amboy, Camden and Atlantic, and West Jersey Railways. It has a court-house, 2 banks, 2 railway dépôts, 15 churches, ship-yards, iron-works, foundries, manufactories of machinery, &c. Pop. (1870) 20,045.

CAMORRA, the name of a secret society, existing throughout all parts of the former kingdom of Naples, the members of which are called *Camorristi*, and have exercised lawless force to a great extent over the humbler classes of society. Under the Bourbons, they openly presented themselves at markets, hackney-coach stations, public spectacles, and all occasions of popular amusement; assumed the right of deciding disputes; extorted a portion of whatever money passed from hand to hand for purchases, rents, wages, and the like, or in games; undertook also the transport of smuggled goods, and contracted for the commission of serious crimes. Their readiness for violence and murder, and their close association among themselves, made them so much dreaded, that even *Camorristi* who had been thrown into prison, succeeded in exacting money from their fellow-prisoners, and from the jailer himself. The society has a central rendezvous in every large provincial town, and twelve such in the city of Naples. Those who belong to each of these sections of the society are under the absolute government of a chief elected by themselves, with whom is associated a treasurer. The latter has the charge of the common fund into which all the *Camorristi* of that section pay their whole gains, for equal distribution among all their associates. Candidates for membership must shew that they have neither been guilty of espionage nor theft; also that neither their wives nor their sisters are prostitutes; and must swear upon an iron crucifix a fearful oath of fidelity and secrecy. The candidate remains for a year, with the designation of *Piccotto d'onore*, as a pupil under an old *Camorrista*; and having completed this probation, and given proof of his courage and obedience in circumstances involving danger of life, he is advanced to the rank of a *Piccotto di guerra*. Finally, after a longer period, and when he has given proof of his fitness on a number of occasions, he is admitted to full membership of the society as a *Camorrista*. Each *Camorrista* carries about with him two knives of peculiar form, by which the members of the society recognise each other. They are held under the strictest discipline. Disobedience is punished by flogging, suspension from employment, or expulsion; treachery, even on the part of a member who has been expelled, is punished with death. If two *Camorristi* quarrel, their chief decides the question between them; but in difficult cases, a duel with daggers is the mode of decision. Under King Ferdinand II. the *Camorra* was tolerated for political reasons. The government of Francis II. endeavoured to put down the society, and the police

received instructions to seize and transport all known members of it. Those who remained entered into alliance with the Garibaldi committee, and rendered essential service in the expulsion of the Bourbons. An attempt was now made to employ them in the police service, but completely failed. The *Camorra* having fallen out with the new government, the members of the society now chiefly live by robbery in South Italy.—See Monnier, *La Camorra, Notizie Storiche* (Flor. 1863).

CAMPANHIA, a town of Brazil, about 150 miles north-west of Rio de Janeiro, surrounded by bare hills, much cut up by gold mines. The houses are built chiefly of earth, and surrounded by gardens. C. has several churches, a Latin school, an hospital, theatre, &c. Pop. 6000.

CAMPINAS, or SAN CARLOS, a town of Brazil, in the province, and 70 miles north of the city, of Sao Paulo, is situated in a fertile and picturesque district, on a small river, the Piraticaba, a feeder of the Parana. There are large coffee and sugar plantations in the surrounding district, and large quantities of sugar are exported. Many of the houses are built of mud or clay, and the immense church, whose walls are five feet thick, is composed of beaten earth. Pop. 6000.

CANADA has recently acquired a more enlarged signification. An act of the imperial parliament (called shortly the *British North America Act*) was passed 29th March 1867, and came into force 1st June of the same year, uniting federally the former separate provinces of Canada, Nova Scotia, and New Brunswick into one *Dominion*, under the name of *Canada*. The upper and lower divisions of the former Canada (q. v.), which had been politically united since 1840, are again dissociated, so that the federation consisted, in 1867, of four members or provinces, as under:

	English Square Miles.	Estimated Pop. (1867).
Quebec (formerly <i>Lower Canada</i> , or <i>Canada East</i> ).	210,090	3,800,000
Ontario (formerly <i>Upper Canada</i> , or <i>Canada West</i> ).	121,260	
New Brunswick.	57,105	
Nova Scotia.	18,660	
Total.	377,045	

The constitution of the Dominion is after the model of the mother-country. The parliament consists of the Queen, an Upper House styled the Senate, and a House of Commons. The Queen is represented by a Governor-general (with a salary of £10,000), who exercises his authority with the aid and advice of a council, styled the Queen's Privy Council for Canada, chosen from time to time by the governor. The Senate, in 1867, consisted of not more than 72 members, 24 for each of the provinces of Ontario and Quebec, and 12 each for the maritime provinces. The senators are chosen by the governor-general, and hold the appointment for life. Among other qualifications, a senator must have real property to the value of 4000 dollars, and must be resident in the province for which he is appointed. The Speaker of the Senate is nominated by the governor-general. The House of Commons consisted at the same date of 181 members—82 for Ontario, 65 for Quebec, 19 for Nova Scotia, and 15 for New Brunswick. The duration of a House of Commons is five years. Until the parliament of Canada otherwise provides, the franchise and other regulations are to be the same as those hitherto in force in returning members to the House of Assembly in the several provinces. The House of Commons elects its own Speaker. Any bill passed by the houses of parliament, even though assented to by the governor-general in the Queen's name, may



own, presided over by a lieutenant-governor, and constituted in the meantime pretty much as before the union. The lieutenant-governors are appointed by the governor-general. The provincial parliaments may, under the provisions of the act, amend from time to time their own constitutions.

In the distribution of legislative power between the general and the provincial parliaments, certain classes of subjects of a local nature are assigned exclusively to the legislatures of the provinces, while subjects of more general concern are assumed by the parliament of Canada. Among the subjects enumerated in the act as coming under the latter description are: the public debt and property; taxation (for federal purposes), postal service, military and naval defence, the salaries of the civil officers of the general government; the census; navigation; money, weights, and measures; copyrights; marriage and divorce; criminal law. The provincial legislatures, again, have the power of taxing themselves for provincial purposes, and of borrowing money on the sole credit of the province; of regulating and paying provincial officers; of establishing asylums, &c. Education is also left to the provincial legislatures, with certain provisions against encroachment on the rights of religious minorities.

The debts of the several provinces, at the union, are assumed (with certain limitations) by the federal government; and, on the other hand, certain duties and revenues, and certain public works and properties belonging to the several provinces before the union, are taken possession of, to form a consolidated revenue fund for defraying the interest of these debts, and for the other expenditure of the federal government.

Provision is made for the introduction of uniformity of laws, which, however, must be with consent of the legislatures of the several provinces.

The union of the various British American provinces had been long and eagerly discussed, public opinion in Canada being generally in its favour, but in the other provinces, strongly opposed to it, from the natural apprehension, that the immense preponderance of C. in population, wealth, and general importance would utterly swamp the others. However, after much and careful consideration, the great advantages which it was shewn the scheme would confer, overcame the provincial jealousies, the pro-federalists in Nova Scotia and New Brunswick came to preponderate, and these two provinces were in 1867 united with Quebec and Ontario to form the Dominion of Canada. In British Columbia and the Hudson's Bay Territories the feeling in favour of annexation was strong, and in 1869 the latter, and 1871 the former, was transferred to the imperial government. The Hudson's Bay Company received an indemnity of £300,000. In 1871 the Red River Settlement was formed into a province under the name Manitoba. In 1873 Prince Edward Island was annexed. The only part of British North America which stands aloof is Newfoundland, but provision has been made for its admittance in the Act of Union, and its accession cannot be long deferred. The area of the vast dominion is about 3,500,000 sq. m., exceeding that of the United States, and little inferior to Europe. See CANADA in the body of the work. The number of members of parliament given above has, of course, been increased by the representatives of the new provinces—viz, 2 senators and 4 members of the House of Commons for Manitoba, 3 senators and 6 members for British Columbia, and 4 senators and 6 members for Prince Edward Island. The total (with a few additional

CANANDAIGUA, a beautiful village in New York, U.S., at the north of the lake of the same name, on the Rochester and Syracuse Railway. Pop. (1870) 4862.

CANCRUM O'RIS, known also as *Noma*, *Water-cancer*, and *Water-canker*, is a peculiar form of mortification, arising apparently from defective nutrition. The disease seldom occurs except between the second and eleventh years, and is usually preceded by measles, remittent or intermittent fever, or some other serious disease. The following is the ordinary train of symptoms: more or less general disturbance of the system, accompanied by loss of appetite, followed by swelling of the salivary glands, and a profuse flow of saliva, which escapes from the mouth involuntarily during sleep; ulceration of the gums, which swell and become livid; looseness of the teeth; and the appearance of ash-coloured spots on the gums and adjacent mucous membrane, which turn into dark-coloured sloughy sores. These sores spread rapidly by a gangrenous process, expose the bone, and finally make a large aperture in the cheek. In some cases, the entire cheek has been destroyed in a very few days. Fortunately, this terrible disease is more rare in this country than in some parts of the continent, and most of the cases recorded are described by foreign writers. Van Swieten describes a case in which he saw the first set of teeth fall out, the second set destroyed, the lower jaw exfoliated, and the lips, cheeks, tongue, and chin eaten away before the child died. The obvious indications of treatment are to remove the patient to pure air, to administer tonics, nourishing food, and (in moderation) stimulants; to touch the diseased parts with nitrate of silver, or glyceride of carbolic acid, and to wash out the mouth frequently with a weak solution of Condy's fluid.

CANDELA, a town of Southern Italy, province of Foggia, 22 miles south of the town of Foggia. Pop. 5600. It is pleasantly situated on the summit of an eminence. The surrounding district is very fertile.

CANDLE-FISH, or EULACHON (*Thaleichthys Pacificus*), a remarkable fish of the family *Salmoidae*, nearly allied to the Capelin (q. v.), and, like it, strictly a sea-fish, approaching the coasts to spawn, but not entering rivers. The C. inhabits the Pacific Ocean, near the western shores of America, from Vancouver's Island northwards. It is not larger than a smelt, has a somewhat pointed and conical head, a large mouth, teeth on the pharyngeals, and the tongue rough, but the lower jaw, palatines, and vomer destitute of teeth. The colour is greenish olive on the back, passing into silvery white on the sides and belly, sparsely spotted with dirty yellow. It is probably the fattest or most oleaginous of all fishes, or indeed of animals, and is used by the Indians not only as an article of food, but for making oil. To broil or fry it, is nearly impossible, because it almost completely melts into oil. Indeed, the Indians often use it, in a dried state, as a lamp for lighting their lodges, merely drawing through it a piece of rush-pith, or a strip from the inner bark of the 'Cypress Tree' of these regions, *Thuja gigantea*—a species of *Arbor Vitis*—as a wick, a long needle of hardwood being used for this purpose; and the fish being then lighted at one end, burns steadily until it is all consumed. In order to use the dried fish for food, the Indians often melt it into oil, by the application of heat, and drink the oil. It is also eaten uncooked. Drying is accomplished without

the thick smoke at the top of woods in which wood-fires are kept burning. They soon acquire a flavour of wood-smoke, and the smoking helps to preserve them. They are then stowed away in large frails, made from cedar-bark or rushes, in order to be used for food in winter. Immense shoals of *C.* approach the shores in summer, and are caught in moonlight nights, when they come to sport at the surface of the water, which may often be seen glittering with their multitudes. The Indians paddle their canoes noiselessly amongst them, and catch them by means of a monster comb or rake—a piece of pine-wood from six to eight feet long, made round for about two feet of its length at the place of the hand-gripe, the rest flat, thick at the back, but having a sharp edge in front, where teeth are driven into it about four inches long, and an inch apart. These teeth are usually made of bone, but the Indian fishers have learned to prefer sharp iron nails when they can get them. One Indian, sitting in the stern, paddles the canoe; another, standing with his face to the bow, holds the rake firmly in both hands, the teeth pointing sternwards, sweeps it with all its force through the glittering mass, and brings it to the surface teeth upwards, usually with a fish, and sometimes with three or four, impaled on each tooth. This process is carried on with wonderful rapidity. When a sufficient quantity of *C.* has been dried for winter, the rest that are caught are made into oil, being, for this purpose, piled in heaps until partially decomposed, and then placed in large square pine-tree boxes; a layer about three deep in the bottom of each box, covered with cold water, and a layer of hot stones put in, then a layer of small pieces of wood, another layer of fish, stones, and so on. The oil is skimmed from the surface of the water in the boxes. A vast quantity of oil is thus obtained. The *C.* is an excellent article of winter-food in a climate of which the winter is severe; and notwithstanding its excessive fatness, is of agreeable flavour. It has not yet become an article of economical value to the civilised inhabitants of North-western America, but seems very likely to do so, and to acquire a very considerable commercial importance.

**CAPRE'RA, or CABRERA**, one of a group of small islands called the Buccinari Islands, in the Strait of Bonifacio, to the east of the north point of Sardinia (q. v.). They belong to the Italian province of Sassari. *C.* is separated from the coast of Sardinia by a strait of little more than a mile in breadth, and by a similar narrow strait from the island of Maddalena, which lies to the west. Its greatest length, from north to south, is about six miles, and its breadth is from two to three miles. Like Maddalena and the rest of the Buccinari Isles, and the neighbouring coast of Sardinia, *C.* is rocky, bare, and unfertile. It has no streams, and is in few places adapted either for the pasture of cattle or for the plough. In former times, it was the abode only of wild goats—whence its name (Lat. and Ital. *capra*, a goat)—and rabbits, and was occasionally visited by goat-herds and fishermen. It has of late years acquired celebrity as the ordinary residence of Garibaldi, who acquired a property and built a house here in 1854. He dwelt here from 1854 to 1856, and again made it his abode in the autumn of 1860. It was to *C.* that he was sent in September 1867, in honourable banishment by the Italian government, after having been taken prisoner at Asinulunga, in consequence of his design of entering the Roman territory to promote an insurrection and overthrow the papal government, and in *C.* he still resides.

$C_{12}H_{18}O_2$ , and  $C_{12}H_{16}O_2$ , and are members of the acetic or fatty-acid series. They derive their name from *capra*, a goat, in consequence of their less resembling in smell the odour of the *C.* They may all be obtained from butter by pressing the portion which remains liquid at 60°, and distilling this oil, and distilling the soap which formed with sulphuric acid. The liquid which passes over contains these three acids, together with butyric acid, which, by being converted into salts, are separable from one another. All of these acids are also obtained by the action of oleic acid by nitric acid; and capric acid is obtained by acting upon oil of rose with nitric acid; hence it is frequently called *rose*.

**CAPULETS and MONTAGUES**, the spelling of the names of the Cappelletti and Montecchi, two noble families of Northern Italy, memorable from their connection with the *Romeo and Juliet* on which Shakspeare has founded his play of *Romeo and Juliet*. According to tradition, both families belonged to Verona; but this does not appear to have been the case. The Cappelletti were a Veronese family, and the fact that their burying-ground is the tomb of Juliet are shewn at Verona to prove how easy it is, in a country of ruins, to connect fact with fable. It has also been asserted that one family was Guelf and the other Ghibelline; but this is disproved by a reference to the *Purgatorio* of Dante (canto vi. l. 10) where the poet is blaming the Emperor Albert for neglecting the Veronese, the very garden of his domain. 'Romeo,' he says, 'come see how the Montecchi and the Cappelletti are oppressed;' and the *Tragedy* shews that the Guelfs were the oppressors in cases of these great Ghibelline families. The Emperor Albert was murdered in 1308, and this has supplied the Veronese with a date for their legend. The first publication in which we read of the essential incidents of Shakspeare's play is in the novel *La Giulietta*, by Luigi da Porto, printed in 1535, after the death of the author. He prefixed an epistle to the work, that the story was told him 'by one Perigrino, a man fifty years of age, much experienced in the art of war, a pleasant companion, and, like almost all the Veronese, a talker.' In 1554, Bandello published in his *Novelle* another Italian version of the story. It was entitled *The unfortunate Death of two happy Lovers, one by Poison and the other by the sword*. Both writers fix the date of the event by which it took place when Bartholomew dalla Scala ruled Verona. A French version of the tale was published by Pierre Borsteanu in Belleforest's *Histoires Tragiques*. It was translated into English in 1667, and published in *Painter's Palace of Pleasure*. About the same time, Arthur Brooke published an English poem on the same subject, entitled *The Tragical History of Romeus and Juliet, first in Italian by Bandello, and now in English by Arthur Brooke*. There is evidence that an English play had appeared previously, and that before Shakspeare's *Romeo and Juliet* story was so well known in England that it supplied subjects for tapestries. Shakspeare's *Romeo and Juliet* seems to have been principally based on the English poem. It was Brooke who first introduced the Montecchi Montagues, and the Prince of Verona Escalus, instead of Scala. Wright and other translators of Dante, have followed the example of Shakspeare, and puzzle English readers by referring to the 'Capulets and Montagues' as Ghibelline families. The historical date of the tragedy has not, however, been adopted by modern stage actors and Shakspearian critics, who very pro-

the revival of arts and letters, supply accessories more in keeping with the drama than the ruder age to which history must assign the 'civil broils' and the fall of the Capulets and the Montagues.—See notes to Dante in *Classici Italiani*, and Knight's and Dyce's *Shakespeare*.

**CARBIDES**, formerly termed **CARBURETS**, are compounds of carbon with metal. None of them occur in a natural state.

**CARBO'LIC ACID**. Since the article on this substance first appeared in the *Encyclopædia*, much has been ascertained regarding its uses, both as a therapeutic agent and as a disinfectant. It has been introduced into the new British Pharmacopœia (1867), where its characters and tests are thus described: 'In colourless acicular crystals, which at a temperature of 95° become an oily liquid, having a strong odour and taste resembling that of creosote, which it also resembles in many of its characters and properties. Its specific gravity is 1.065; boiling point, 370°. The crystals readily absorb moisture on exposure to the air, and they are thus liquefied; the acid, however, is but slightly soluble in water, but it is freely soluble in alcohol, ether, and glycerine. It does not redden like litmus paper; a slip of deal dipped into it, and afterwards into hydrochloric acid, and then allowed to dry in the air, acquires a greenish-blue colour. It coagulates albumen. It does not affect the plane of polarisation of a ray of polarised light.' It may be taken internally in doses of from one to three grains in the same class of cases as those in which creosote is prescribed. Its principal uses are as external applications, in which, in various degrees of dilution, it is serviceable in unhealthy ulcerations, gangrenous sores, ozæna and all fetid discharges, gleet, the destruction of lice, and especially, as Professor Lister has shewn, as an application in compound fractures (in which it coagulates all albuminous effusions, and forms a solid crust, impermeable to air, over the broken surface), and to abscesses immediately after they have been opened. Indeed, it is most probable that his investigations on the treatment of abscess will, like those on the treatment of compound fractures, lead to a total alteration in this department of surgery. The observations of Pasteur and others have shewn that, in even apparently the purest air, numerous organic germs are always floating. In a hospital ward, these germs are multiplied to an extraordinary degree. In any wound exposed to the atmosphere (as a compound fracture), decomposition takes place by the action of these germs, and hence it is necessary to introduce the carbolic acid, which has the power of destroying these germs, into the interior. In an unopened abscess, no septic organisms are present, and the object of the surgeon is to guard against their introduction from without, and at the same time to afford a free exit for the discharge of the contents of the abscess. The following are the outlines of Professor Lister's mode of proceeding: A square piece of rag is dipped in a solution of one part of crystallised carbolic acid and four parts of boiling linseed oil, and is laid upon the skin where the incision is to be made. The lower edge being raised, a scalpel dipped in the oil is plunged into the cavity of the abscess, and a sufficient opening made; and the moment the knife is withdrawn, the raised part of the rag is dropped upon the skin as an antiseptic curtain, beneath which the pus escapes. The cavity of the abscess is firmly pressed, so as to remove as nearly as possible all the existing pus, and if it should seem expedient, a piece of lint dipped in the

'Thus,' says Professor Lister, 'the evacuation of the original contents is accomplished with perfect security against the introduction of living germs. This, however, would be of no avail unless an antiseptic dressing could be applied that would effectually prevent the decomposition of the stream of pus constantly flowing out beneath it.' He finds that the most suitable dressing is made as follows: Six tea-spoonfuls of the oily solution are mixed with common whiting (carbonate of lime) so as to form a putty, which is spread upon six inches square of common tinfoil, strengthened with adhesive plaster to prevent its tearing. The tin thus spread with putty is laid upon the skin, so that the middle of it corresponds with the point of incision, the antiseptic rag used in opening the abscess being removed the moment previously. The tin is then fixed with adhesive plaster, the lowest edge being left free for the escape of the discharge into a folded towel placed over it, and secured with a bandage. The dressing must be removed every day, and a piece of rag dipped in the oily solution must be placed on the incision when the first tin is removed, so as to guard against the possibility of the entrance of germs during the cleansing of the skin with a dry cloth, and pressing out any discharge that may exist in the cavity. If a piece of lint was inserted into the wound, it must be removed when the tin is applied. From the absence of the irritation excited by decomposition, pus almost at once ceases to be formed under this treatment; and large abscesses, after their original contents have been evacuated, often yield in 24 hours only a few drops of serum in the course of a few days. The Pharmacopœia gives the glyceride of carbolic acid (consisting of one part of the acid to four of glycerine) as a good form for local application; but the proportion of acid must vary with the case.

The value of carbolic acid as a disinfectant is placed beyond all doubt by the investigations of Mr Crookes, made at the request of the Royal Commissioners, who were appointed to obtain information and report on the cattle disease. As an account of his experiments is reprinted, in a very cheap form, from the Appendix to their Third Report, and is accessible to every one, we will merely insert the recommendation of the Commissioners: 'That the use of carbolic acid should become general throughout the country in uninfected as well as in infected districts. There is little doubt that even were there no danger from cattle-plague, the great purifying effect of the substance on the air of cattle-sheds would contribute greatly to the health of the animals.'

**CARIPE**, a town of Venezuela, South America, situated in a fertile valley of the same name, 50 miles south-east of Cumana. The valley is noted for a cavern frequented by the remarkable bird called Guacharo (q. v.). Pop. of town and valley, 5000.

**CARLSLE**, the capital of Cumberland county, Pennsylvania, U. S., 18 miles south by west of Harrisburg, the centre of a rich agricultural country; seat of Dickinson College, a flourishing Methodist institution; with 13 churches, 2 banks, 2 newspapers, machine shops, rail-car factory, and United States barracks; was shelled by the Confederates, July 1, 1863. Pop. (1870) 6850.

**CARLOS, SAN**, a town of Venezuela, South America, in a valley on the Aguaré, a feeder of the Orinoco, 120 miles south-west of Caracas. Before the wars of independence it was a place of considerable importance, having been one of the richest towns in the province. The town is handsome and

engaged chiefly in the rearing of cattle, and the cultivation of indigo, cotton, and coffee, of which there are still considerable plantations in the neighbouring savannahs.

**CARLSHAMN**, a fortified town on the south coast of Sweden, about 30 miles west of Carlscrona, at the end of a beautiful valley. The harbour is small but secure, and a considerable trade in iron, timber, pitch, and tar is carried on. There are manufactures of sail-cloth, tobacco, hats, soap, and leather; there are also dye-works and ship-building yards. Pop. 5731.

**CARNARVON, HENRY HOWARD MOLYNEUX HERBERT**, fourth Earl of, born in Grosvenor Square, 1831. His family is a branch of the House of Herbert, Earls of Pembroke, springing from Major-general the Hon. W. Herbert, whose son, Henry, was created, in 1780, Baron Porchester of Highclere, Hampshire, and advanced to the earldom of Carnarvon in 1793. The present earl was educated at Christ Church, Oxford, where he was first-class in classics in 1852. His father dying before he was of age to sit in the House of Commons, he lost the advantage of the training in public speaking and statesmanship which the sons of peers usually enjoy during the lifetime of their parents, in the Lower House. He took his seat on the Conservative benches, and soon shewed himself ambitious of parliamentary distinction. His earlier speeches in the House of Lords were not thought to exhibit much vigour and grasp of intellect, and were marred by a simpering and affected delivery. He was appointed governor of Carnarvon Castle in 1854. In 1858, he became Under-secretary of State for the Colonies, in the administration of the Earl of Derby. In 1859, he received the degree of D.C.L., and was elected High Steward of the University of Oxford. He resigned office with the Conservative ministry in 1859, and availed himself of the period of leisure thus obtained to visit the East. The feuds of the tribes in the Lebanon had broken out in a massacre of the Christians; and the Earl of C. gave the world the benefit of his investigations, in an interesting work, entitled the *Druses (q. v.) of the Lebanon*. On his return, he delivered lectures in the country, and speeches in the House of Lords, on prison-discipline, education, and other social subjects. When the Conservatives again returned to power in 1866, C. accepted from Lord Derby the office of Secretary of State for the Colonies, with a seat in the cabinet. In this he obtained for his colonial administration a large share of public confidence. He censured in calm and measured language the misconduct of the courts-martial during the Jamaica insurrection, and especially the trial and execution of Mr Gordon; and the pacification of the colony satisfactorily progressed under his instructions. During the recess, he developed and framed a plan for the confederation of the British North American colonies; and when parliament met in 1867, he explained the provisions of the measure in an elaborate speech. The bill met with general approval in both Houses, and it passed; but before it obtained the royal assent, C. had, with two other colleagues in the cabinet, resigned office upon the Reform Bill of the Derby government, which he regarded as democratic in its operation, and dangerous in its results. When the Reform Bill came before the House of Lords, C., in an animated speech, vindicated his consistency at the expense of his colleagues; and in the discussions in committee, he addressed the House with great vigour and argumentative ability. He edited in 1869 a work by his father, who was

*Journal of Travels in Greece during 1839, by the late Earl of Carnarvon*. He has also published one or two of his lectures. On Mr Disraeli's return to power in 1874, Lord C. resumed office as Secretary of State for the Colonies, and was one of the small cabinet of statesmen who inspired public confidence in the new Conservative government. Lord C. married, in 1861, the only daughter of the sixth Earl of Chesterfield.

**CARORA**, a town of Venezuela, South America, in the province of Caro, 210 miles west-south-west of Caracas, and 60 miles east of Lake Maracaybo, on the Tocuyo. The town is well built, has a handsome parish church, convent, hermitage, &c. There are manufactures of leather, ropes, and fine hammocks from the fibre of the *Agave fatida*. A trade is carried on in agricultural produce, and in the aromatic balsams, resins, gums, and wild cochineal for which the district is famous. The pop., which was formerly much larger, is now about 6000.

**CAROUGE**, a town of Switzerland, in the canton and about one mile south of Geneva, on the left bank of the Arve. It is beautifully situated, regularly built, and surrounded by villas, orchards, and meadows. It has a handsome Roman Catholic and a Protestant church. There are manufactures of thread, clay pipes, leather, watches, and pottery. There is a bridge across the Arve connecting the town with Geneva. Pop. (1870) 5871.

**CARRAPATO**, a species of Tick (*q. v.*) of the genus *Ixodes*, which infests dry bushy places in the interior of Brazil, hanging in clusters of many hundreds on very slender twigs, and ready to attach itself to any quadruped or man that passes, instantly burying its beak in the skin, from which it cannot be detached without considerable force. Horses and oxen suffer very much from the attacks of the C., of which in dry seasons the numbers are so great, that whole herds of cattle are destroyed by the exhaustion which they produce.

**CARVIN-EPINOY**, a town of France, dep. of Pas-de-Calais, 11 miles south-south-east of Lille, and about the same distance by railway. There are manufactures of beet-root sugar, starch, earthenware, and leather. Pop. (1872) 5780.

**CASIA**, or **POET'S CASIA** (*Osyris alba*), a shrub of the natural order *Santalaceae*, a native of the south of Europe, 3-4 feet high, with linear-lanceolate deciduous leaves, long supple branches, numerous small white flowers, and red drupes (stone-fruit) of the size of a pea. The branches are used for making crates. The shrub has been much admired for its modest beauty. Keats speaks of

'The drooping flowers  
Of whitest casia, fresh from summer showers.'

**CASSIDA'RIA**, a genus of molluscs—class *Gastropoda* (*q. v.*), order *Pectinibranchiata*—with univalve shells, generally regarded as belonging to the family *Buccinidae* or *Whelks* (*q. v.*), but as forming a connecting link with the family *Muricidae* (see *MUREX*). The shell is ventricose, with a moderately elevated spire, the aperture elongated, and the canal recurved, but not very abruptly—much less so than in the nearly allied genus *Cassia* (see *HELMET SHELL* in *SUPP.*)—the columellar lip covered with a plate, and the outer lip similarly margined within. The recent species, which are not numerous, belong to tropical and subtropical seas. Fifty fossil species have been described. The genus first appears in the Upper Cretaceous measures, where a single species occurs. In the Eocene 11 have been found,

being known

The name *Cassidaria* is sometimes given to a family of coleopterous insects, of which the type is the genus *Cassida*. See TORTOISE BEETLE.

**CASTIGLIO'NÉ**, a town of Sicily, province of Catania, on the north slope of Mount Etna, on the right bank of the Cantara, 35 miles south-west of Messina. The town stands on a square rock rising abruptly from the valley, and having a double crest, on which stand a domed church and the ruins of a feudal castle. Here, in 1297, in the war of the Vespers, Admiral Roger Toria raised the standard of rebellion against his sovereign, Frederick of Aragon. In the district are several large nut-plantations, which produce the best Sicilian hazelnuts. Pop. 8000.

**CA'THA**, a genus of the natural order *Celastraceæ*. The fruit is a three-cornered capsule.—*C. edulis*, sometimes called **ARABIAN TEA**, the **KHÂT** of the Arabians, is a shrub with erect smooth branches, elliptical obtusely serrated leaves, and small flowers in axillary cymes. It is a native of Arabia, and the Arabs ascribe to its leaves, even carried about the person, extraordinary virtues as a preventive of plague, with probably about as much reason as our forefathers had for esteeming the rowan tree formidable to witches. When fresh, they are stimulant, narcotic, and intoxicating, and are eaten with greediness by the Arabs. They are very antisporific, so that a man, after using them, may keep watch for a whole night without drowsiness.

**CATTLE-PLAGUE, RINDERPEST** (Ger.), or **STEPPE MURRAIN**, is a contagious eruptive fever, or exanthema, of the bovine species; sheep, goats, deer, and other allied species occasionally, however, catch it from cattle. It occurs indigenously on the plains of Western Russia, whence it has at various times overspread most parts of the Old World. The specific virus from diseased or infected animals is the only source of cattle-plague; no filth, overcrowding, or other health-depressing cause has hitherto produced it. As in smallpox, scarlatina, and other eruptive fevers, an incubative stage, varying between two and twenty days, intervenes between the introduction of the virus into the system, either by inoculation or contagion, and the development of the characteristic symptoms. These consist essentially of congestion of the mucous and cutaneous surfaces, with a sort of aphthous eruption, and thickening, softening, and desquamation of the superficial investing membrane. The disease runs a tolerably fixed and definite course, which is not materially altered by any known remedial measures. It seldom attacks the same individual a second time.

*History.*—The cattle-plague has been recognised for upwards of a thousand years. It appears to have destroyed the herds of the warlike tribes who overran the Roman Empire during the 4th and 5th centuries. About 810, it travelled with the armies of Charlemagne into France, and about the same period is also supposed to have visited England. Several times throughout the course of every century it spread from the plains of Russia over the western countries of Europe, and is stated to have again visited England about 1225. Although occasioning, every few years, great losses on the continent of Europe, the plague does not appear to have again shewn itself in England until 1714, when it appeared at Ialington about the middle of July, was very destructive for about three months, but was again got rid of towards Christmas. In 1744, it was in Holland, destroying there, in two years, 200,000 cattle; in Denmark, from 1745—1749, it killed

havo throughout Italy, destroying 400,000 beasts in Piedmont alone. In April 1745, the plague was again imported into England, probably by some white calves from Holland, where, as already stated, it had for some time prevailed. It continued its devastations for twelve years, but it is now impossible accurately to discover the losses it occasioned. In the third and fourth years of its ravages, 80,000 cattle were slaughtered, and double that number are supposed to have died. In 1747, 40,000 cattle died in Nottingham and Lancashire alone; whilst, so late as 1757, 30,000 perished in Cheshire in six months. In March 1770, the disease was brought with some hay from Holland to Portsoy, in the Moray Firth; several cattle died, and others, to the value of £78, 12s. 2d., being destroyed, the further spread of the pest was prevented. By the wars which wasted Europe towards the close of the last and first eighteen years of the present century, cattle-plague was spread widely over the continent, and occasioned, wherever it occurred, terrible losses. Since then, at short intervals, it has spread—always being traceable to its source on the Russian plains—over Poland, Hungary, Austria, Prussia, portions of Germany and Italy, and has extended to Egypt. It has also reached China and Japan.

The British outbreak of 1865—1867, like its predecessors, undoubtedly came from Russia. The steamer *Tonning* from Revel, brought 331 cattle and 330 sheep into Hull on 29th May 1865. A portion of the cattle had come from the interior of Russia, where the plague then was, or recently had been; the cargo was rapidly landed, and very hurriedly inspected. Nearly half of the cattle were distributed in various lots to butchers in Leeds, Derby, and Manchester, but, curiously, these do not appear to have left any contagion in their trail. One hundred and seventy-five came to London, remained from the Monday evening until Thursday's market in lairs at York Road, adjoining the cattle-market. It was stated, in a leader in the *Times* of 15th August, that rinderpest was seen in the metropolitan market as early as 12th June. Certain it is that more than one lot purchased on 19th June carried the disease to several dairies in and about London. The first cases were mistaken for cases of poisoning, the cows they had stood beside were sent into market, and thus the subtle disorder in a few weeks spread into many dairies both in town and country. Twenty-three Dutch cattle, having stood over for several markets, were sent back to Holland on 2d July, carried with them the contagion, were placed in a field near Schiedam, but soon sickened and died, thus spreading the disease in Holland. During the next six months, plague was repeatedly reimported thence into England. Until 11th August 1865, no restrictions whatever were put upon the removal of cattle; diseased and infected animals were freely taken to fairs and markets, were openly travelled by road and rail; whilst the metropolitan market continued every week to send forth infected cases, not only to the neighbouring counties, but to Southampton, Birmingham, Hereford, Liverpool, Edinburgh, and even to Aberdeenshire. As early as 18th July, the pest was brought from London to Huntly by four calves; subsequent outbreaks occurred in the same way. The stamping-out system was, however, early and rigidly enforced in Aberdeenshire, and eight distinct outbreaks were promptly got rid of.

In Edinburgh, it appeared probably about 9th August, was brought from London by some low-priced foreign cows; in six weeks, about 800, or one half the dairy cows in Edinburgh, had died—200

but Edinburgh was reported clear. In Glasgow, the first case occurred on 19th August, in a cow sent from Edinburgh. By 30th September, 432 cases were reported, and it continued to spread. By the middle of October, it was in Mr Harvey's valuable stock of 800, of which 25 died in one night, and to save further loss, 50 healthy animals were in one day disposed of to the butcher. From Falkirk Trysts, as from Barnet, Norwich Hill, and other large English fairs, the disease was transmitted into fresh localities. From the autumn trysts, it was carried into Perthshire, Forfarshire, and Fifeshire. Diseased cattle passing along in railway trucks, appear to have spread the contagion over the fields adjoining the line at Thornton, Fifeshire. Into West Lothian it was conveyed early in September by lambs from the Edinburgh market.

The rapid spread of the insidious disorder may be gathered from the fact that, whilst, during the week ending 24th June 1865, there was only one outbreak at Mrs Nicholl's dairy at Islington, and 30 animals affected, by 30th September there were 1702 farms, sheds, or other places in which the pest had appeared, and 13,263 animals had been attacked. Three months later, 8252 separate places had been visited, and 62,743 animals attacked. During six months, the aggregate of cattle attacked was 76,002. During the three months to 30th March, 13,443 farms and other premises had been infected, and 147,275 cattle attacked. In December 1865, the fresh cases each week reached 9000; but in spite of remedial and preventive measures, of orders in council, and restrictions on the movement of stock, the number of weekly cases steadily increased to 15,706 in the third week of February. 'The Cattle Diseases Prevention Act' passed 20th February 1866, and the advantages flowing from the restrictions thus tardily imposed on the trade in cattle, and the slaughter of diseased and infected animals, were speedily apparent. In four weeks, the number of cases was reduced by one half. During the three months ending 30th June, 28,276 cases were reported; during the next three months to 30th September, the numbers fell to 2108; whilst, to 29th December, the three months' cases were but 149; to 30th March 1867, 89 new cases were noted. Throughout April and May the number of cases continued steadily to decline; but during the week ending 25th May a fresh outbreak occurred in the Finsbury district of the metropolis, and 81 animals died, or were slaughtered to prevent the further spread of the pest. With the exception of an isolated outbreak in Essex, which was promptly stayed by slaughter of the ailing and suspected animals, the country was free of plague during August. The following are the records of its destructive career during 1865—1867:

	Attacked.	Killed.	Died.	Recovered.
England,	223,672	102,740	90,450	21,589
Wales,	8,388	1,180	5,794	1,117
Scotland,	46,963	6,263	28,088	10,707
Total,	278,923	110,183	124,332	33,413

To this sad total must be added 11,000 cases known to have been attacked and unaccounted for, and upwards of 60,000 healthy cattle slaughtered to prevent the spread of the disease. Plague was again imported into Hull in August 1872; it was brought with cattle from Cronstadt; it spread into several districts of the East Riding, attacked 72 animals, 51 of which were killed, and 21 died; whilst, to arrest the outbreak, 171 animals which had been in contact with diseased subjects were slaughtered.

such causes, is untenable. Faulty hygiene, by lowering vitality, probably renders the animal more prone to the attack, and less able to bear up against it, but it cannot originate plague. Like hydrophobia, smallpox, or syphilis, it is developed only by the special virus, which appears to have its habitat on the Russian steppes. This virus occurs abundantly in the blood of every plague-stricken beast, in the discharges from its nostrils, mouth, or eyes, in the off-scourings from the bowels, probably even in the breath. It may be transferred to healthy beasts by inoculation. A little of the blood or nasal or other mucous discharges of a plague case, if introduced underneath the skin of a healthy cow, develops the disease within a few days. The transference of the virus or contagion from the sick to the sound animal, is not always so direct and evident. As with other catching diseases, the virus may be carried considerable distances in the air; its particles are minute, but they have powerful vitality; it may adhere to the food that has lain before infected beasts; to the litter from the stalls, or even after it has been heaped for weeks; to the clothes of attendants; to the floors, walls, or stalling of buildings; to imperfectly cleansed cattle-trucks. So subtle and potent is the plague poison, and so endowed with the power of self-multiplication and growth, that a very minute portion of it finding access to the blood of a healthy animal of the bovine race increases so rapidly, that, to use the words of the Commissioners' Report, No. III. p. 4, 'the whole mass of the blood, weighing many pounds, is infected; and every small particle of that blood contains enough poison to give the disease to another animal.' It may gain access to the blood probably through the air-passages, perhaps also by absorption through the mucous surface of the bowels, or even through the skin.

*Symptoms.*—In from three to six days after an animal has been exposed to the virus of cattle-plague, or about 36 to 48 hours after being purposely inoculated, the temperature of the body is raised by several degrees. A delicate thermometer introduced into the vagina or rectum, instead of marking about 102° F., indicates 104° to 106°. As yet, the appetite, secretion of milk, breathing, and pulse are scarcely if at all affected, and but for the elevation of temperature, accompanied sometimes by dulness, the animal might be supposed to be in the best of health. Two or three days later, or usually within six or eight days after the beast has taken in the subtle virus, the mucous membrane of the mouth is generally observed to be slightly reddened, and soon a granular yellowish-white eruption, consisting of thickened epithelium cells and granules, appears on the gums round the incisor teeth, and by and by on the lips and dental pad. Some hours later, the same eruption extends to the cheeks, tongue, and hard palate. Within 48 hours, or about the sixth day of attack, a crust of epithelium covers the gums, lips, and mouth, and when wiped away, or accidentally rubbed off, leaves the abraded membrane red and vascular, and exhibiting patches of erosion. The membrane lining the vagina indicates very similar appearances; it is reddened and vascular, dotted with grayish translucent elevations about the size of rape-seeds, covered with a whitish-yellow, usually sticky discharge, and occasionally marked with patches of excoaration. The skin, like the mucous surfaces, is congested; there is hence a perverted development of scarf skin, and of the oleaginous secretion of the irritated sebaceous glands. The skin is thus invested with a furfuraceous desquamation; whilst on its thinner portions

About two, or even three days after the temperature has been increased, and usually one, or even two days after the appearance of the characteristic eruption on the gums, the constitutional symptoms present themselves. The animal is dull, hangs its head, arches its back, the eyes are leaden and watery, and from both eyes and nose there latterly comes a dirty slimy discharge. Appetite and rumination are irregular, and in dairy cows, the secretion of milk rapidly abates. The breathing, especially towards the sixth day, is oppressed, expiration is prolonged, and accompanied by a peculiar grunt. The pulse is small and thready, and quickened as death approaches. The bowels, usually at first confined, become, towards the sixth or seventh day, much relaxed; the discharges passed, often with pain and straining, are profuse and liquid, offensive, acid, pale coloured, and occasionally mixed with blood. The patient loses weight and strength, totters if it attempt to walk, and prefers to lie rather than to stand. Death usually occurs about the seventh day, and is preceded by muscular twitchings, a peculiar sickly, often offensive smell, a cold clammy state of body, moaning, grinding of the teeth, and rapidly increasing prostration.

**Prognosis.**—Cases usually terminate unfavourably when about the fifth or sixth day the animal temperature falls rapidly; the pulse becomes small, quick, and weak; the breathing more difficult, distressed, and moaning; the diarrhoea increased; and the depression more notable. A more favourable termination may be anticipated when, after the fifth day, the heightened temperature, so notable even from the earliest stages, abates gradually; the breathing becomes easier; the pulse firmer; the visible mucous membranes appear healthier; and patches of extravasation, or erosion speedily disappear.

Sheep do not take rinderpest spontaneously, and even when kept with diseased cattle, or inoculated with cattle-plague virus, they do not catch the disease so certainly as cattle do. When diseased, they exhibit, however, very similar symptoms, but Professor Röhl, and other observers, record that upwards of 40 per cent. recover. Goats, deer, antelopes, gazelles, yaks, and indeed all animals taking rinderpest, exhibit with tolerable uniformity the same characteristic symptoms.

**Post-mortem Appearances.**—The mucous membranes are generally deeper coloured than natural, are congested, softened, marked in places with the same granular patches discoverable during life within the mouth and the vagina, and in bad cases exhibit oedema, hæmorrhage, and sloughing. The first three stomachs sometimes contain a good deal of food, but shew less declension from health than the fourth stomach, of which the mucous membrane is dotted with spots of congestion and extravasation. The coats of the bowels are thinned and easily torn. The mucous coat, especially towards the middle of the small intestines, the opening into the cæcum, and posterior half of rectum, is much congested, bared of epithelium, and sometimes ecchymosed, but never ulcerated. Peyer's glands, so generally inflamed in the somewhat analogous typhoid fever of man, are perfectly healthy. The liver, spleen, and pancreas seldom present any special appearances. The respiratory mucous membrane, like the digestive, is vascular, and marked with submucous hæmorrhage; the lungs are generally emphysematous, the heart often marked with petechial spots. The urino-genital, like the other mucous membranes, is congested in females, especially towards the lower part of the vagina and vulva; the kidneys

Dr Beale, by his microscopical observations, discovers in the capillaries a great increase of nuclear or germinal matter, and white blood-corpuscles, which he believes may account for the local congestion. The blood itself is dark in colour; in the later stages it contains less water, probably owing to the draining diarrhoea, and about double its usual proportion of fibrine. The muscular tissues are softened, easily broken down, and contain an abnormal amount of soluble albumen. The urine is little altered in quantity, but from the first rise in the animal temperature, it contains an increase of urea varying from 5 to 15 per cent. The chief change in the milk is its rapid diminution in quantity, and the increase of its fatty matter. The bile is watery, offensive, and prone to decomposition.

**Treatment.**—Cattle-plague is proved to be an eruptive fever. When the specific poison, on which such disorders depend, has entered the body of a susceptible subject, no remedy has yet been discovered which can destroy it, or even materially shorten or mitigate its effects. Until such an antidote is found, there can be no hope of certain cure. The Cattle-plague Commissioners have collected information regarding the four following methods of treatment—namely, the antiphlogistic, the tonic and stimulant, the antiseptic, and the special. Diverse as are these systems, the percentages of recoveries, varying from 25·83 to 27·45, were so nearly alike, that it is fair to conclude that no one of the systems tried exercised any notable influence in checking the mortality. Partly, perhaps, from the varying virulence of the plague, partly from differences in the nursing and care bestowed on the animals, the proportion of recoveries has varied greatly in different localities. Up to the end of 1865, in Huntingdon they were only 4·668 per cent.; in Norfolk they were 12·102; in Flint, 15·909; in Scotland, 19·889; whilst in Fifeshire they reached 24·552; and in Yorkshire, 29·731 per cent.

Like smallpox, measles, and other eruptive fevers in man, rinderpest runs a definite course which cannot safely be interfered with. Rational treatment is therefore limited to warding off untoward symptoms, to careful nursing, and husbanding the failing strength. It must, however, be remembered that throughout the progress of the disease there is constantly given off from the sick body minute particles, which are capable of developing the disorder in healthy cattle. Hence plague-subjects, by the orders in council, are very properly desired to be immediately destroyed. Except, therefore, for purely scientific purposes, and with careful precautions to prevent the spread of the poison, it is unwise to attempt remedial treatment. Where, however, a beast is to have a chance of recovery, so soon as the elevated temperature indicates the accession of the disease, solid indigestible food should be withheld, and the patient restricted to mashes, gruel, boiled linseed, malt, and other food, which can be digested without the necessity for rumination. The paramount importance of such a dietary is clearly demonstrated in the returns of the Edinburgh Cattle-plague Committee to the government commissioners. The recoveries amongst 310 cattle 'fed with dry food, and treated medicinally with drugs,' were 13·6. Amongst 303 cattle treated with mixed food and hay, 22·2 recovered. Where mashes were given during sickness, but dry food supplied during convalescence, the recoveries reached 51·6; whilst in 95 cottagers' cows, whose chief ordinary dietary consisted of mashed food, and which were fed in

Where the bowels at the outset are costive, a dose of oil, or a very small quantity of some saline purgative, may be required. Cold water, gruel, mashes, or stale bread soaked either in water or beer, should be offered at short intervals throughout the attack. The animal, kept in an atmosphere of about 60°, should be comfortably clothed, and have its legs bandaged. The hot-air bath and wet-packing has been repeatedly tried, but although probably useful in the earlier stages, appear, when the disease is fully established, to harass and weaken the patient. Small and repeated doses of sulphite of soda have in some cases proved useful, and may be conjoined with carefully regulated moderate doses of such stimulants as ale, whisky and water, sweet spirit of nitre, spirit of ammonia, or strong coffee. It is most important, however, that these and other such medicines should be drunk by the animal of its own accord in its gruel, water, or mashes, as the forcible hoarding over of drenches always disturbs the patient. The inhalation of chloroform, although temporarily relieving the distressed breathing, does not appear to exert any permanent benefit.

**Prevention.**—From what has been stated regarding the nature of cattle plague, it must be evident that its prevention can only be effected by the destruction of the specific virus, or by removing beyond its influence all animals on which it might fasten. Sparks fall harmless where no inflammable materials lie within reach, and there are many such materials. Neither should sheep, fresh hides, hay, nor any other fodder and litter from countries where this ruinous plague exists, or has recently visited, be allowed to enter British ports. This very obvious precaution took strong hold of the public mind, and the practical result is, that importations of cattle plague are guarded against by the provisions of the Contagious Diseases (Animals) Act, 1869. Neither cattle, sheep, nor pigs, fodder or litter, hides or skins, can be landed from countries where the plague exists, or from places in direct communication with such infected countries. All foreign stock is inspected at the ports of debarkation, and inspectors have orders for the immediate slaughter and disinfection of cattle-plague subjects, and of any animals with which they have been in contact. But even with such precautions, foreign cattle frequently bring with them catching disorders, notably foot-and-mouth disease. Since they constitute, however, less than 5 per cent. of the total cattle stock of the country, such risks should be removed by converting the foreign cattle traffic into a dead-meat trade.

Rinderpest being found to resemble smallpox in men and sheep, it was thought that its propagation and virulence might be abated by vaccination with cowpox lymph; but cattle, even when effectually vaccinated, which is often a difficult task, readily take rinderpest, often in its most mortal forms. Inoculation with the discharges from mild cases and from young calves has been tried as a palliative; but the disease, thus artificially developed, loses nothing either of its severity or of its dangerous contagious character. Cattle in Oxfordshire receiving for several weeks daily doses of sulphite of soda are stated to have had the plague in a mild form.

Where an outbreak occurs, the diseased animals must be promptly destroyed, and all cattle in immediate contact with them should likewise be slaughtered. This 'stamping-out system' prevents the multiplication and diffusion of the virus, and hence saves still further losses. It is rigidly and successfully carried out in many continental coun-

try. An outbreak of the disease occurred in Belgium during the autumn of 1865, and was stamped out with the sacrifice of forty-three animals. The disease was imported to Paris in November by two gazelles purchased in London by the French Acclimatization Society. Before it was stayed by slaughter and segregation, thirty-four animals, including yaks, antelopes, deer, gazelles, goats, and peccari, died and were destroyed. The determined slaughter of diseased and infected animals, and the restrictions on the movement of all stock, were the only means that reduced the number of attacks during the British outbreak of 1865 and 1866. As is officially recorded in the Commissioners' Report, No. IV., p. 6, 'where the percentage of killed is high, the ratio of increase of the disease is low, and vice versa.' This has generally been noticed under each county and district.

When plague is in the neighbourhood, it is desirable daily to sprinkle the walls, wood-work, and floor of the sheds and hovelling with carbolic acid solution and to keep up throughout the premises a continuous odour of this useful antiseptic, and with a diluted solution of the acid, or with M'Dougall's disinfecting soap, to wash over the cattle daily. The animals should be carefully fed on digestible soft food; receive daily about an ounce of sulphite of soda in a mash; and, in order to note the first access of the disease, should have their temperature examined by the thermometer every night in the morning.

The recommendations of the Cattle-plague Commissioners for the purifying of infected sheds, litter and manure must receive careful attention. In whatever premises infected beasts have stood, the walls should be lime-washed, a pint of carbolic acid being added to each pailful of the whitewash. The floors and wood-work, after being washed and scrubbed with boiling water, should be sprinkled with a strong solution of carbolic acid. The shed being emptied of their living inhabitants, and the doors and windows closed, sulphur should be burned and the vapours allowed to float about for a couple of hours before the sheds are again thrown open to the purifying influences of abundance of fresh air. A pound of sulphur placed on a shovel of burning coals suffices for a twelve-stalled shed or byre. Where cattle-plague has raged, this cleansing and fumigation should be repeated, and, if possible several weeks allowed to elapse before the premises are again occupied by sound animals. All shovels, forks, buckets, or brooms that have either directly or indirectly come in contact with diseased or infected animals, should be washed with the carbolic acid solution. The clothes and boots of attendants, inspectors, and others coming in contact with plague-stricken animals must be similarly cleansed. The manure should be sprinkled with carbolic acid at intervals of a few days, and then covered over with a foot of earth, freely mixed with soil, or carted away and ploughed in. It is safe thus to put the manure on the arable land than to use it as a top-dressing for the pastures.

**Authorities.**—Official Reports of the Commissioner appointed to inquire into the Cattle-plague, Nos. I., II., III., and IV.; *The Cattle Plague*, by Professor John Gamgee.

**CAVARZERE**, a town of Northern Italy, province of Venice, 22 miles south-south-west of Venice city. Pop. 12,400. It is situated on the Adige which divides it into two parts called *C. destro* and *C. sinistro*. Its soil is fertile, and its inhabitants carry on an active trade in cattle, silk, and wool for fuel.



12,000. It produces much grain, and has the pastures.

CENEDA, now officially called VITTORIO, a city of Northern Italy, province of Treviso, 36 miles north of Venice. Pop. 10,530. It is an episcopal see, has a very handsome modern cathedral and a fine monolithic fountain. Under the republic of Venice, it was rich, and famed for its manufactures of woollen cloth, silk, and paper. C. is very ancient, dating from the time of the Romans, but now it is a decayed city.

CHAILLU, PAUL B. DU, a distinguished traveller, was born in the south of France, about 1820. His father was for many years a merchant trading on the Gaboon (q. v.) River, in Western Africa, and thither he was carried when a boy. He lived there for several years, and became familiar with the habits and languages of the natives, thus—as well as in his habituation to the climate—unconsciously preparing himself for the explorations which he was afterwards to undertake. In 1842, the French made a settlement and built a fort on the Gaboon. Under the protection of this fort, both the elder and younger Du C. resided and carried on their commercial pursuits for some years. Du C. afterwards went to America, where he resided for a number of years, and was naturalised by the legislature of the state of New York. In October 1855, he sailed from New York to West Africa, where he spent four years in explorations, making many interesting discoveries, and travelling, as he himself tells us, about 8000 miles, always on foot, and unaccompanied by other white men. He returned to America, and after subjecting his specimens in natural history and ethnological notes to the examination of the scientific men of New York and Boston, he crossed the Atlantic to England, and published a volume of travels—*Explorations and Adventures in Equatorial Africa, with Accounts of the Manners and Customs of the People, and of the Chase of the Gorilla, Crocodile, Leopard, Elephant, and other Animals* (Lond. 1861). His travels were in a region lying between N. lat. 1° 30', and S. lat. 2°, and extending from the coast to about E. long. 14° 15'; and the work in which he gives an account of them contains very important contributions to geographical, ethnological, and zoological science. Under the first of these heads must be ranked, as of chief importance, the information concerning the Fernand Vas, Ogobai, and Rembo rivers (see OGOBAI in SUPPLEMENT), and concerning the mountain chain which, between the equator and S. lat. 1°, stretches from west to east from the neighbourhood of the coast far into the interior of Africa. He made known the existence and described the characteristics and habits of a number of African tribes, among which particular interest attached to his account of the Fans (q. v.), a cannibal tribe, inhabiting a region on the western side of the coast-range of mountains, just to the north of the equator. His contributions to zoology related not only to the gorilla and other remarkable apes, some of them previously quite unknown, but included also many new species of mammals and birds. Many of the statements contained in his volume, however, being very extraordinary, it was received with much distrust, and was subjected to very adverse criticism; to which it was the more exposed because the author's journals having been put into the hands of a literary gentleman in America to be prepared for the press, separate journeys were mixed up in the narrative, and the chronology was thrown into confusion. Much discussion took place in newspapers and

never seen the animal alive, but had purchased the specimens which he brought to England from natives on the coast. His descriptions of nest-building apes were, of course, also received with incredulity, and the truth of his account of the cannibal Fans was much doubted. The maps drawn up by Dr Barth and Dr Petermann in 1862 moved the positions of all the places which he had visited much nearer the coast than he had fixed them, so as greatly to reduce the length of his routes. The general trustworthiness of Du C.'s narrative was, however, maintained by some men of the highest eminence, and particularly by Sir Roderick Murchison and Dr Owen. Du C. resolved to confute his opponents, and vindicate his own reputation, by another expedition to Africa, for which he prepared himself by a course of scientific study, to enable him to make astronomical and other observations, and by acquiring the art of photography. During his first explorations, he had laid down the position of places from compass-bearings only. The substantial accuracy of his observations was, however, in the meantime confirmed by a French government expedition under Messrs Serval and Griffon du Bellay, which explored the Ogobai River in 1862; and Dr Petermann then reconstructed his map of that part of Africa as Du C. had originally laid it down. His statements regarding the cannibalism of the Fans were also confirmed by Captain Burton, who himself travelled among them. Du C., however, proceeded on his second expedition. He freighted a small schooner, and sailed in her from England on 6th August 1863, carrying with him not only an ample store of scientific apparatus, but also of goods for presents to the natives, or barter with them. He reached the mouth of the Fernand Vas River on 10th October, and was warmly welcomed by the African chiefs whom he had formerly known; but he sustained a grievous misfortune in the loss of all his scientific instruments and many other valuable articles, through the swamping of the canoe by the surf, as they were being landed from the schooner. He was compelled to send to England for another set of instruments, and to wait till they arrived. Meanwhile, he made several excursions in the neighbourhood of the coast, through the almost impenetrable jungle—which covers the western coast regions of equatorial Africa, and had abundant opportunity of confirming his former observations regarding the gorilla. He also had live ones caught and brought to him by the natives. In September 1864, Du C. having received his new supply of instruments from England, started on his expedition for the exploration of the interior. He was attended by a body-guard of ten Commi negroes, in thick canvas trousers, blue woollen shirts, and wooted caps, each man having a blanket to keep him warm at night. There was difficulty, however, in getting leave to set out on the expedition at all. It is the universal rule among the coast tribes of West Africa to prevent, if possible, all strangers from penetrating into the interior, even if it be only to the next tribe, through fear that the exclusive privilege of trading with that tribe should be lost. A grand *palaver* was held on the subject, and it was at last agreed that Du C. should be allowed, as a special favour, to ascend the Fernand Vas or Ogobai, as his object was not to trade, but to shoot animals, and to bring away the skins and bones. 'Truly,' the chiefs and councillors said, 'we do not know what Chaillie has in his stomach to want such things, but we must let him go.' Du C.

loss even for food, and his attendants being almost all at one time ill of smallpox, which made fearful havoc among the native population, and exposed him to the dangerous suspicion of having caused it by witchcraft. He passed through a forest district so dense that animal life is scarcely found in it, and an almost unbroken silence prevails by day and by night. He found also in his journeyings many scenes of extreme beauty, scenes of mountain and meadow, hill and pasture-land, groves of plantains, groves of lime-trees remarkable for dark foliage, stately palms, and clear sparkling streams. An unfortunate misunderstanding took place at last between Du C.'s party and the inhabitants of a village which he had reached. A conflict took place, the natives became exasperated, and it was with difficulty that the traveller escaped, being obliged, however, to resign all thought of proceeding further. He reached the mouth of the Fernand Vas River on 21st of September 1865, and found a vessel there loading for London. He had lost everything but his journals; all the treasures in natural history which he had collected were gone. He brought home, however, his astronomical observations, which have been carefully examined by the most competent persons, and the map of western equatorial Africa has been made much more complete and correct than before. Du C. did not penetrate, on any of his journeys, much more than 240 miles in a direct line from the coast, but his discoveries have been numerous and important, and amongst them are about eighty new species of mammals and birds. No one now doubts the right of Du C. to be ranked among the most enterprising and truthful of travellers. The account of his second expedition to Africa is entitled *A Journey to Ashango-Land* (Lond. 1867). His ethnographical observations were published in *My Apingi Kingdom* (1870); and *The Country of the Dwarfs* (1872).

**CHAMBRE INTROUVABLE** (Fr. unfindable chamber; i.e., the chamber the like of which is not to be found again) was the name sarcastically given to that Chamber of Deputies in France which met after the second return of Louis XVIII. (July 1815), and which, by its fanatical royalty, began to throw the country and society anew into commotion. The former chamber, which had shewn much moderation, had been dissolved under the influence of the court party; and the ministry, led by Talleyrand, had done everything to procure for the ruling party at least a manageable chamber adapted for business. The number of the deputies was arbitrarily raised from 259 to 392; and to secure the victory of a complete restoration, all rushed forward who saw in the constitutional charter an encroachment on their privileges and pretensions. When it is considered, in addition, that the elections, at least in the departments of the south, took place under terror and the sanguinary outrages of a populace in a state of political and religious excitement, that the press was stifled, and the people deprived of all freedom of expression by the foreign armies, ultra-royalism could not fail to be completely triumphant. When the ministers saw this startling result, they did not venture to open the session; they resigned, and gave place to the Richelieu ministry. Then broke out the most frightful excesses in the southern provinces. At the elections in Nimes (22d August), more than 100 persons were killed by the royalist bands. At last, on 7th October, the king opened the chamber, on which he enjoined quietness and moderation; and it appeared as if it did take this advice to heart for an instant. But when, in one of

by the ultra-royalist bands, the speaker was called to order, and the chamber from that time ceased to observe any bounds or moderation. The fanatical legislation of this chamber inspired the ministers, the king, and especially the Emperor Alexander, with so much aversion and apprehension, and also met so decidedly with the disapprobation of all peaceful and sincere friends of the throne, that the news of its dissolution, on 5th April 1816, was received with universal rejoicing. The electoral law of 5th February 1817 prevented the return of a similar chamber; and it was not till by the modified electoral law of 1820 that ultra-royalism regained a predominating influence in parliament. It is said that Louis XVIII. first used the epithet *Chambre Introuvable* in an ironical sense, and that the majority of the chamber took it seriously as a compliment.

**CHA'NDAH**, a town of India, on the south-west frontier of the territory of Nagpore, on the left bank of the river Eræe, near its junction with the Wurda, 90 miles south of the town of Nagpore. Its walls, built of cut stone, and surrounded by a high parapet, are 6 miles round, from 15 to 20 feet high, and flanked with round towers large enough for the heaviest guns. Within the place, and almost equidistant from the north and south faces, is a citadel; the rest of the interior consists of straggling streets, detached houses, and plantations. It is well supplied with water. In 1818, C. was taken by the British. Pop. 16,233. C. is capital of a British administrative district having an area of 9700 square miles, and a pop. of 534,431.

**CHANDHAITREE**, or **CHANDERI**, a town of Gwalior, India, in a hilly and jungly district, near a tributary of the Jumna. It is at present much decayed, on account of Mahratta oppression, the scourge of war, and the decay of its manufactures, which are undersold by the cheaper fabrics of Britain; but the extent and architectural excellence of its ruins indicate its splendour and importance in former times, when it is said to have contained 14,000 stone houses, 384 markets, 360 caravanserais, and 12,000 mosques. The fort of C., formerly deemed impregnable, consists of a strong rampart of sandstone, flanked by circular towers, and is situated on a high hill. Among other remains of former greatness, is a pass cut through a solid rock 100 feet high. During the native wars, being a place of importance, C. was frequently besieged. Under Mahratta sway, it became a haunt of freebooters, very troublesome to the native districts under British rule or protection; and on the conclusion of the treaty of 1844, it was, among other lands, assigned for the maintenance of the increased Gwalior contingent, commanded by British officers.

**CHANDPOO'R**, a town of British India, in the North-west Provinces, district of Bijour, about 930 miles north-west of Calcutta, and 80 north-east of Delhi. It is of considerable size, and has a pop. (1872) of 12,033.

**CHANK-SHELL**, the popular name of the shell of several species of *Turbinella*, a genus of gasteropodous molluscs of the group *Siphonostomata* (q. v.), natives of the East Indian sea. These shells are obtained chiefly on the coasts of the south of India and Ceylon, and form a considerable article of trade to Calcutta. They are much used as ornaments by Hindu women, the arms and legs being encircled with them; and many of them are buried with the bodies of opulent persons. Those which are thrown



Chank-shell.

returns shew an exportation of chank-shells from Madras amounting to the number of 2,460,727 in one year, 1853—1854, the value of which was about £10,000. The quantity ordinarily exported is smaller. A chank-shell opening to the right is rare, and is highly prized in Calcutta, so that a price of £50, or even £100, is sometimes paid for one.

**CHARLES X.,** or **CHARLES-GUSTAVUS**, king of Sweden, was born at Nyköping, 8th November 1622. After studying at the university of Upsala, he travelled through France, Germany, and Switzerland, joined the army of Torstensohn (q. v.) in 1642, fought at the battles of Yankovitz and Leipzig; and at the close of the war was the representative of Queen Christina at the conferences which were held for giving effect to the treaty of Westphalia. On the abdication of Christina, Charles-Gustavus, who was the son of Gustavus Adolphus's eldest sister Catharine, and John Casimir the Palatin of Zweybruck in Clerburg, succeeded as next heir, 17th June 1654, to the throne of a kingdom which, after his accession, he discovered to be in an almost bankrupt condition. There was a debt of 10,000,000, while the revenue did not amount to 800,000 crowns, out of which one-fourth was granted as a pension to the ex-queen, whose carelessness and extravagance had brought about this deplorable state of matters, and who, in the words of the aged chancellor Oxenstierna, 'had cost Sweden dearer than ever an enemy did.' She had taken away everything belonging to the royal residences which was portable; and C. was forced at first to borrow even a set of kitchen utensils. C. was the second of the three great warrior-monarchs of Sweden, but unlike his uncle, who could plead religious grounds, and his grandson, who was at first forced to fight for self-preservation, C. seemed to make war principally for war's sake. First he attacked Poland in July 1655, because the Polish monarchs had not resigned their claim to the Swedish throne; captured in the same year Warsaw, Cracow, Thorn, Elbing, Posen, and Kalicz; and drove the king to take shelter in Silesia: he then assailed the Danes, who had declared war against him, crossed the Belts on the ice, and speedily made himself master of all the continental possessions of Denmark. Next marching from isle to isle over the frozen sea, he ultimately, by menacing Copenhagen, compelled the treaty of Roskild (7th March 1658), which gave to Sweden, Holland, Scania, Bleckingen, Bornholm, and the other Danish possessions beyond the Sound, and emancipated Sweden from the Sound Dues. Charles, however, still cherished enmity against the Danes; and after fruitlessly proposing to the Dutch and English a partition of Denmark, he invaded Zealand, and

was compelled to abandon the siege. Soon after, while labouring to effect a complete reconciliation with Poland in order to be free to attack the Danes in Norway, he died suddenly at Gothenburg, February 23, 1660.

**CHARLES XI.,** one of the ablest kings of Sweden, was the son of King Charles (X.) Gustavus, and was born November 24, 1655. While he was little more than four years old at his father's death, the government was committed to his mother Hedwig as regent, and a council. The peace of Oliva (May 3, 1660) with Poland, by which Sweden obtained Esthonia, part of Livonia, and Oesel, and the Polish monarch renounced all pretensions to the Swedish crown; and that of Copenhagen (June 6, 1660), generally confirmatory of the treaty of Roskild with Denmark, were the first important acts of the government. A treaty with Russia on the basis of the *status quo* followed in 1661; and from this period till 1672, the kingdom was free from foreign wars. In December 1672, C. (whose education had been so ill attended to that he had reached manhood before he could read) took the reins of government, and by the allurements of France, was induced to make war on Brandenburg. This unprovoked attack was disastrous to the Swedes, for they suffered a severe defeat from the elector at Fehrbellin (1675); and though C. revenged himself by defeating the Danes (who were allied with Prussia) at Halmstadt, Lemd, and Landskrona, his fleet was defeated by the Dutch near Oeland, and again by the Danes at Bleking and Kiöge; and many of Sweden's recent acquisitions were wrested from her. These, however, were restored by the peace of Saint-Germain-en-Laye (17th September 1679), which closed this needless and unfortunate contest. In 1680, a struggle commenced between the crown, supported by the burghers and peasants, on one hand, and the nobles on the other; and a considerable diminution of the power of the nobles was the consequence. The resumption of all the crown lands which had been alienated since 1609, was a fatal blow to the preponderating power of the nobles; and by a voluntary declaration of the states, December 9, 1682, the king was invested with absolute authority. This voluntary erection of a despotism by the people, a thing of rare occurrence in the world's history, is yet more extraordinary at the close of the 17th c.; and it speaks highly for C. that he never employed his unlimited authority otherwise than for the best interests of his kingdom. By a judicious administration of the revenues, he was enabled to extinguish the public debt (1686), reorganize the fleet and army, and by 1693 to dispense with the calling up of extraordinary subsidies. Though absolute, he never imposed a tax but with consent of the states; and he every year published a detailed account of revenue and expenditure. In 1693, he was formally declared absolute by an act of the diet. The foreign policy of the country was also conducted in a manner equally satisfactory and effective. Deux-Ponts fell to him as heir to his cousin Friedrich-Ludwig, the last palatine, in 1681; the attempts of the Danes upon Holstein were rigorously repressed, and many small outlying territories were brought under his sway. His anxiety for his subjects' welfare was particularly shown by commercial and maritime regulations superior to any that then existed in Europe; and by his numerous journeys to all parts of his dominions to examine for himself into the remote details of the administration. A codification of the laws was commenced, but was unfinished

Russia, government of Tambov, 175 miles south-east of Moscow, on a small river of the same name. It is situated in the midst of a vast fertile plain, contains a number of churches, and has a trade in hardware, grain, and cattle. Pop. (1867) 6783.

**CHAUVINISME.** Chauvin was the name of the principal character in a French comedy, which was played with immense success at the time of the Restoration. He represented a bragging veteran of the empire, who was continually talking of his achievements at Austerlitz and Jena, and his determination to take a brilliant revenge for Waterloo. Since then, a *chauviniste* has come to mean a man who has extravagant and narrow-minded notions of patriotism, and corresponding enmity towards foreign peoples.

**CHEA'DLE,** a small but neat market-town of England, in the moorland district of the north part of the county of Stafford, 14 miles north-north-east of the town of Stafford, 3 miles from the Froggall station on the Churnet Valley branch of the North Staffordshire Railway, and 4 miles from the Blyth Bridge station on the main line from Derby to Crewe. The town is seated in a pleasant vale, surrounded by hills mostly planted with fir and other trees. The parish church (St Giles) was a very ancient structure, but was rebuilt in 1837—1838. A magnificent Roman Catholic church, erected at the sole expense of John, Earl of Shrewsbury, was opened in 1846. There are several dissenting chapels, various schools, a mechanics' institute, a large tape manufactory, and also one for silk. There are copper and brass works a short distance from the town, and coal and limestone abound in the vicinity. Pop. (1871) 2929.

**CHE'LIFER,** a genus of *Arachnida* (q. v.) of the order *Trachearia*, and of the family to which, from their resemblance to scorpions without tails, the name *Pseudo-scorpions*, or False Scorpions, has been given, the true scorpions belonging to the order *Pulmonaria*. The genus *C.* consists of minute species in which this resemblance is very strong. The palpi are elongated and armed with pincers. The species live under the loose bark of trees, in chinks of old furniture, &c. One species, *C. cancroides*, about a line and a half in length, is frequently to be seen in old books, herbaria, &c., and is called the *Book Scorpion*; it is said to be useful as feeding on the insects which are most destructive to books and collections in natural history.

**CHELM,** or **CHOLM,** a town of Russian Poland, in the government of the same name, 126 miles south-east of Warsaw. It is the seat of a United Greek bishop, and has a theological seminary. The Poles were defeated here by the Russians, June 4, 1794. Pop. (1867) 4483.

**CHEMICAL TOYS,** which in the course of recent years have been brought prominently before the public, deserve a brief notice. 'Pharaoh's Serpents,' which have been already described in the article **SULPHOCYANOGEN**, are highly poisonous, and during combustion evolve dangerous vapours. *Larmes du Diable*, or 'Crocodiles' Tears,' are formed of metallic sodium, burn with extreme violence if thrown into water, or even if moistened with water or heated, and scatter particles of caustic alkali, which may inflict serious burns. 'Sunshine in Winter Evenings,' 'Fiery Swords,' &c. are formed of magnesium, and, like the preceding, may cause serious burns. 'Sensation Cigarettes' are charged with gun-cotton, and project, when fired, noxious vapours into the mouth; while pyroxylin, which is

the various toys known as 'Will-o'-the-wisp Paper,' 'Parlour Lightning,' 'Fireflies,' 'Aerial Glow-worms,' 'Chinese Fire-paper,' &c.

The use of these toys in teaching rudimentary chemistry to children and young persons is quite incommensurate with their danger.

**CHEMISTRY.** It is impossible in this article to do more than briefly describe some of the most important of the numerous changes which have been introduced into the science of chemistry within the last few years.

1. The system of measuring temperatures, lengths, weights, and volumes has been altered. The centigrade has completely superseded the Fahrenheit thermometric scale in all recent chemical works, and the French metric (which is a decimal) system has been adopted for all measurements and weights, inches and their fractions being replaced by 10ths or 100ths of a metre, and grains by grammes. It has this advantage over all other systems, of possessing one fundamental linear unit, from which all the ramifications of linear, superficial, or solid dimensions, and of weight are derived. See **MÈTRE, LITRE, GRAMME, FRANCO.** This unit is the 10-millionth part of a quadrant of the meridian, or of the distance from the pole to the equator. It is only to measures of weight and capacity or volume that we need here refer. 'Multiply,' says Dr Hofmann in his energetic appeal in favour of the metric system, 'the cubic metre by one million, and you have a fit measure in terms of which to express the capacity of the Atlantic, or its cubical contents of brine; divide the cubic metre by one million, and you arrive at the petty volume of the gambler's ordinary die.'—*Modern Chemistry*, p. 124. This last-named volume, the millionth of a cubic metre, taken as so much distilled water at a temperature of 4° C. (its point of greatest density), furnishes the metrical unit of weight called the *gramme*, which thus forms a link connecting weight with measure. Again, dividing the edge of a *metre cube*, which is a linear metre, into 10 parts, called *decimètres*, and cubing one of these parts, we obtain a unit of volume or capacity to which the term *litre* is applied. The various weights in use are all multiples or divisions by tens. Thus, 10 metres form a decamètre, 100 a hectomètre, and 1000 a kilomètre; while  $\frac{1}{10}$ th of a metre is called a *decimètre*,  $\frac{1}{100}$ th a *centimètre*, and  $\frac{1}{1000}$ th a *millimètre*, the Greek prefixes in all cases denoting multiplication, and the Latin division. The reader will do well to recollect the following rough comparisons between the chief French and English measures chiefly used in chemistry, as otherwise he can form no conception of the length, size, or weight of the substances treated of: A *metre* = nearly 1·1 linear yard = 39·37 inches; a *millimètre* = 0·039, or nearly  $\frac{1}{25}$ th of an inch; a *centimètre* = 0·39, or nearly  $\frac{1}{2}$ ths of an inch; and a *decimètre* = 3·94, or nearly 4 inches; a *gramme* = 15·43 grains; and a *litre* = rather more than 61 cubic inches, or a pint and three-quarters. The accompanying figure represents a cubic decimètre. Two of the edges of the front side are divided, as may be seen, into 10 linear centimètres; and the space occupied by a cubic centimètre is shewn on the upper right-hand corner of the tube. Now, a cubic decimètre is employed as a unit for measures both of weight and of volume, for in the former capacity it contains, at 4° C., 1 kilogramme, or 1000 grammes of distilled water, and in the latter it loses its name of kilogramme and receives the appellation of *litre*, which corresponds

to serve as standard units of measurement, and Professor Hofmann has selected 1 cubic decimetre = 1 litre, as the most appropriate unit of volume, and the weight of this measure of pure hydrogen as the unit of weight, hydrogen being taken at 0° C.

*krithé*, a barley-corn, signifying figuratively a small weight; and the weight is now in universal acceptance amongst modern British chemists. There is probably no figure in chemical science more important than this one (0.0896 of a gramme)

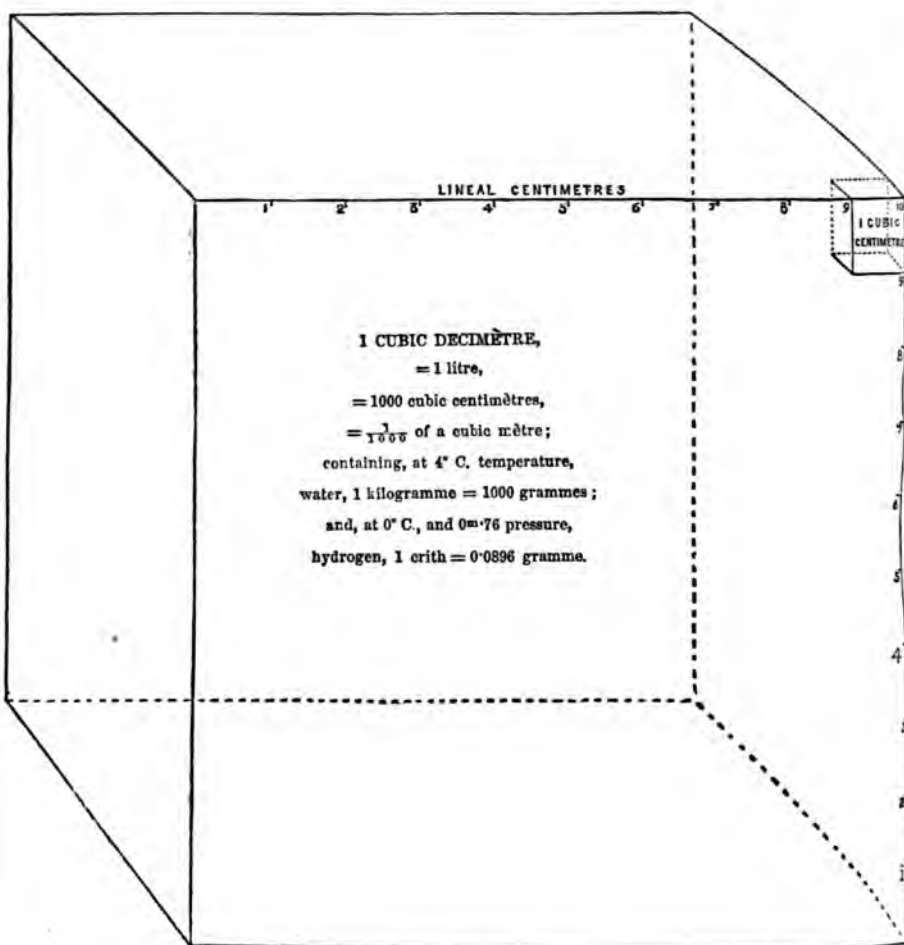

to be remembered and kept ready for calculation; for it is the standard multiple or co-efficient by means of which the weight of 1 litre of any other gas, simple or compound, is computed. For example, the relative volume-weight of chlorine being 35.5, that of oxygen 16, and that of nitrogen 14, the actual weights of 1 litre of each of these elementary gases at 0° C. and 0.76 pressure, may be called respectively 35.5 *criths*, 16 *criths*, and 14 *criths*. So again with reference to the compound gases, the relative volume-weight of each is equal to half the weight of its product-volume. Hydrochloric acid (HCl), for example, consists of 1 volume of hydrogen + 1 volume of chlorine = 2 volumes, or by weight, 1 + 35.5 = 36.5 units; whence it follows that the relative value-weight of hydrochloric acid gas is  $\frac{36.5}{2} = 18.25$  units; which last figure therefore ex-

presses the number of *criths* which 1 litre of hydrochloric acid gas weighs at 0° C. and 0.76 pressure,  $18.25 \times 0.0896 = 1.6352$  as the actual weight in grammes of hydrochloric acid gas. Again, as the product-volume of water-gas (H<sub>2</sub>O),† taken at the above temperature and pressure, contains 2 volumes of hydrogen + 1 volume of oxygen, and therefore weighs 2 + 16 = 18 units, the single volume of water-gas weighs  $\frac{18}{2} = 9$  units, or substituting as before the concrete for the abstract value, 1 litre of water-gas weighs 9 *criths*; that is to say,  $9 \times 0.0896$  gramme

\* It is almost unnecessary to notice that 0.76 signifies 0.76 of a metre, or nearly 30 inches—the ordinary atmospheric pressure at the level of the sea, and at lat. 51 $\frac{1}{2}$ °.

† The reason why the formula H<sub>2</sub>O, instead of HO, for water is used, will be presently explained.

be estimated at 0.09 gramme.

2. Such terms as *atomic weight*, *atom*, and *molecule* are now employed in a stricter sense than formerly. Every element has been held from the time of Dalton to have a number called its atomic weight. This number, according to Dr Frankland, one of our most distinguished modern chemists, is made to represent, as far as possible: '1st, The smallest proportion by weight in which the element enters into or is expelled from a chemical compound—the smallest weight of hydrogen so entering or leaving a chemical compound being taken as unity. 2d, The weight of the element in the solid condition at any given temperature contains the same amount of heat as seven parts by weight of solid lithium at the same temperature. 3d, The weight of the element which, in the form of gas or vapour, occupies, under like conditions of temperature and pressure, the same volume as one part by weight of hydrogen.'—*Lecture Notes for Chemical Students*, 1866, p. 2. Recent investigations have led chemists to assign to many of the elements double the atomic weights that were previously assigned to them. Thus, taking as formerly the atomic weight of hydrogen as the unit, the atomic weight, or, as it is now often styled, the *atomic number* of oxygen is changed from 8 to 16, that of carbon from 6 to 12, that of sulphur from 16 to 32; and this doubling is by the latest writers extended to most of the elements except the halogens, nitrogen, phosphorus, boron, the metals of the alkalies, gold, and silver. The old atomic weights are still recognised as *combining* or equivalent numbers. The reason why this doubling of the number has been adopted will be presently given. The distinction between an *atom* and a *molecule* must be clearly recognised. 'We may define an *atom* of an elementary body to be the smallest proportional weight thereof which is capable of existing in *chemical combination*; and we may define the *molecule* of an elementary body to be the smallest proportional weight thereof which is capable of existing in the *free or uncombined state*.' This, which is Hofmann's definition (*Modern Chemistry*, p. 157), is now generally accepted. Thus a molecule (or *elementary molecule*, as it is often termed) may consist either of an isolated atom, or of a group of atoms.

The bulk of a molecule, or the *molecular volume* of an element in the gaseous or vaporious state, is the same as the molecular volume of hydrogen at the same temperature and pressure, and in a large number of cases the *molecular weight* of an element is twice its atomic weight. Dr Frankland gives the following list of the elements whose molecular volumes have as yet been determined: The molecules of mercury, cadmium, and zinc contain *one atom*, and are termed *monatomic molecules*; those of hydrogen, oxygen, chlorine, bromine, iodine, fluorine, nitrogen, sulphur, and selenium contain *two atoms*, and are termed *diatomic molecules*; the molecules of oxygen, as ozone, contain three atoms, or are *triatomic*; while those of phosphorus and arsenic are *tetraatomic*, and those of sulphur under certain conditions are *hexatomic*. Thus an element, as in the cases of oxygen and sulphur, may, under different conditions, have two distinct molecular weights. We shall presently refer more fully to the subject of *atomicity*.

3. We shall now proceed to explain the reasons why many of the atomic weights have been doubled. 'It is obvious,' says Dr Odling, in his elaborate article on 'Atomic Weights' in *Watts's Dictionary of Chemistry*, vol. i. p. 456, 'that the atomic weights

of unations of the simplest series of elements, or so as best to accord with the chemical properties and metamorphoses of the bodies; so as best to illustrate their analogies with other bodies; and so as to be in relation with their physical properties, such as their specific volumes, specific heats, isomorphism, &c.' We shall endeavour to shew how he applies these views to prove that, in the case of oxygen, 16 parts of that element, or the quantity thereof which unites with 2 atoms of hydrogen, is the smallest proportion of oxygen that can enter into a combination. 'We find, in the first place,' says Dr Odling, 'that the quantity of oxygen contained in the great majority of definite oxidised compounds must necessarily be represented by 16, or some multiple of 16 parts. Thus, the molecules of all hydrates, double oxides, acids, oxisalts, aldehydes, ketones, alcohols, oxacid-ethers, and a great number and variety of other compounds, doubtless forming together 99 per cent. of all known compounds of oxygen, cannot be represented save with 16 parts, or some multiple of 16 parts of oxygen. For example, the molecules of *hydrate of potassium*,\* *benzoic aldehyde*, *acetone*, *chloral*, *hypochlorite of sodium*,\* &c., each contain 16 parts of oxygen. The molecules of *spinelle*, *brown hematite*, *camphor*, *benzile*, *acetate of sodium*,\* *benzoic acid*, &c., each contain twice 16 parts of oxygen. The molecules of *nitric acid*, *glycerin*, *chlorate of potassium*,\* *salicylic acid*, *avgite*, &c., each contain three times 16 parts of oxygen.' We need not carry the quotation further, it being sufficient to remark that Dr Odling gives similar lists of substances whose molecules each contain 4, 5, 6, 7, &c. times 16 parts of oxygen. Hence it follows that, when two bodies only differ in composition by the different proportions of oxygen which they contain, that difference amounts to 16 parts, or some multiple of 16 parts of oxygen. This is well shewn in the two following series of bodies given by Odling, in the former of which the symbols are arranged according to modern views:

KCl,	Chloride of potassium.	C <sub>2</sub> H <sub>4</sub> ,	Ethylene.
KClO <sub>2</sub> ,	Hypochlorite of potash.	C <sub>2</sub> H <sub>4</sub> O <sub>2</sub> ,	Aldehyde.
KClO <sub>3</sub> ,	Chlorite of potash.	C <sub>2</sub> H <sub>4</sub> O <sub>4</sub> ,	Acetic acid.
KClO <sub>4</sub> ,	Chlorate of potash.	C <sub>2</sub> H <sub>4</sub> O <sub>6</sub> ,	Glycolic acid.
KClO <sub>5</sub> ,	Perchlorate of potash.	C <sub>2</sub> H <sub>4</sub> O <sub>8</sub> ,	Glyoxylic acid.

It is obvious that in both these series each term differs from the preceding one simply by O<sub>2</sub>, or 16 parts of oxygen. Again, the quantity of oxygen which can be liberated by any reaction, and which, either alone or in the form of water, can be added to or separated from a compound, must be 16, or some multiple of 16 parts. Thus, each molecule of nitrate of soda (NaO,NO<sub>3</sub>), when decomposed by heat, yields nitrite of soda (NaO,NO<sub>2</sub>) and O<sub>2</sub> (or 16 parts of oxygen); similarly, each molecule of permanganate of potash, when decomposed by sulphuric acid, yields manganese-alum, and O<sub>4</sub> (or twice 16 parts of oxygen); and each molecule of chlorate of potash (KO,ClO<sub>3</sub>) is decomposed by heat into chloride of potassium (KCl) and O<sub>6</sub> (or three times 16 parts of oxygen). Again, water (and consequently its main constituent, oxygen) is always eliminated in double or some higher even atoms. Thus, formic acid (C<sub>2</sub>H<sub>2</sub>O<sub>2</sub>) yields carbonic oxide (C<sub>2</sub>O<sub>2</sub>) and two atoms of water (H<sub>2</sub>O<sub>2</sub>); alcohol (C<sub>2</sub>H<sub>6</sub>O<sub>2</sub>) yields olefiant gas (C<sub>2</sub>H<sub>4</sub>) and two atoms of water (H<sub>2</sub>O<sub>2</sub>); oxalate of ammonia (NH<sub>2</sub>,C<sub>2</sub>HO<sub>4</sub>) yields cyanogen (C<sub>2</sub>N) and four atoms of water (H<sub>2</sub>O<sub>4</sub>); and innumerable additional examples

\* In these cases, one of the new forms of nomenclature is introduced.

oxidised bodies were correctly formulated, they would be represented more simply by the formulæ in which O = 16 than by formulæ in which O = 8. Reasons of a similar nature have led to the duplication of the atomic weight of carbon, sulphur, and many of the other elements. There must obviously be some means of distinguishing when O indicates 8 or 16 parts of oxygen, C indicates 6 or 12 parts of carbon, &c. Various modes of distinction have been adopted by different chemists. In *Watts's Dictionary of Chemistry*, now in the course of publication, the new atomic weights are represented by the same symbols which have hitherto been adopted for the old weights; while the latter (when they are occasionally introduced) are printed in italic capitals; thus, water is represented by  $H_2O$  in the new and by  $HO$  in the old system, acetic acid by  $C_2H_3O_2$  in the new and by  $C_2H_3O_4$  in the old system, &c. A more common means of indicating when the value of the symbol of an element is doubled in value is by drawing a horizontal bar through it, a notation due to Berzelius; thus,  $\bar{C}$ ,  $\bar{O}$ ,  $\bar{S}$  represent respectively an atom of carbon, of oxygen, and of sulphur in the new system. This system is useful in forming, as it were, a bridge to facilitate the passage from the old to the new system, and will gradually disappear when all chemists recognise the doubled atomic weights. Naquet, Miller, (in the 3d edition of his *Chemistry*, 1864), and others, adopt this *barred* system, and the latter frequently gives the formulæ pertaining to both systems; for example,  $FeO.S\bar{O}_2.H\bar{O}.6\bar{H}\bar{O}$ , or  $Fe\bar{O}\bar{S}\bar{O}_2.H_2\bar{O}.6H_2\bar{O}$ , represents the composition of the crystallised sulphate of protoxide of iron often described as protosulphate of iron.—*Inorganic Chemistry*, 3d ed., p. 6. Some writers, as Frankland, in his *Lecture Notes for Chemical Students*, 1866, following the plan of Watts and the contributors to his Dictionary, unreservedly adopt the doubled atomic weights, and represent them by the old formulæ; thus, O, C, and S represent in these works precisely double the weight of oxygen, carbon, and sulphur that these capitals represent in the 1st and 2d editions of Miller's *Chemistry*, Fownes's *Manual of Chemistry*, and other standard works published a few years ago. It is now customary for the writers of chemical papers who object to the barred symbols as being unseemly, to insert at the commencement C = 6, O = 8, or C = 12, O = 16, in order that the reader may be able to recognise which system is adopted.

*Chemical Nomenclature* is still in an unsettled state. The chemists of all countries are, with one notable exception, agreed as to the names and symbols which should represent the different elements. The French chemists persist in designating nitrogen by the name of *azote*, and of using *Az* instead of *N* for its symbol; and in Italy the term *azoto* is still employed, but as it is often coupled with the symbol *N*, it will probably soon be exchanged for the more general term nitrogen. When the elementary bodies unite together, they form a *binary compound*. The nomenclature of the binary compounds is in a transitional state. The compounds of sulphur with metals used to form *sulphurets*, latterly they have been termed *sulphides*, and now they are denominated after a third fashion; sulphuret of potassium (for example), after having been for some years sulphide of potassium, now being termed *potassic sulphide*. In order to obtain uniformity, the following rule is adopted by the representatives of the modern school. The names of binary compounds are formed from those of their constituents, the English or

potassium and sulphur form *potassic sulphide*; sodium and oxygen form *sodic oxide* (formerly *soda* or *oxide of sodium*); silver and chlorine form *argentic chloride* (formerly *chloride of silver*); lead and iodide form *plumbic iodide* (formerly *iodide of lead*); calcium and chlorine form *calcic chloride* (formerly *chloride of calcium*), &c. When the same elements form two compounds, the one which contains the smallest proportion of the negative element is distinguished by changing the terminal syllable of the name of its positive constituent into *ous*, while the terminal *ic* is retained for the compound containing the larger proportion of the negative element. Thus, 1 atom of iron and 1 atom of oxygen form *Ferrous oxide* (the old protoxide of iron); 2 atoms of iron and 3 atoms of oxygen form *Ferric oxide* (the old peroxide of iron). Sometimes the same elements form more than two compounds with one another, and then the prefixes *hypo* and *per* are employed. When a binary compound contains oxygen, and becomes an acid when made to unite with water, or becomes a salt when united to a base, it is termed an *Anhydride* (q. v.) or *anhydrous acid*. Thus 1 atom of carbon and 2 atoms of oxygen form *carbonic anhydride*, formerly known as *carbonic acid gas*; 1 atom of sulphur and 3 atoms of oxygen form *sulphuric anhydride*, &c. In a considerable number of cases, the trivial or common name has not been displaced by the new systematic name; thus water, ammonia, hydrochloric acid, phosphuretted hydrogen, sulphuretted hydrogen, &c. are not as yet replaced by hydric oxide, hydric nitride, hydric chloride, hydric phosphide, hydric sulphide, &c.; and soda and potash are still preferred by some chemists to sodic and potassic hydrates.

The term *acid* was originally applied only to substances which, like vinegar, possessed an acid taste; it is now made to include a large number of compounds which do not possess this property. The most general definition of acids is that of Gerhardt, which is adopted in *Watts's Dictionary of Chemistry*—namely, that '*acids are salts of hydrogen*.' A more intelligible definition to ordinary readers is that which is adopted by Frankland, in which an acid is described 'as a compound containing one or more atoms of hydrogen, which become displaced by a metal when the latter is presented to the compound in the form of a hydrate.' Thus, using the new nomenclature and atomic weights, nitric acid and sodic hydrate yield sodic nitrate and water—



in which reaction the hydrogen of the nitric acid is displaced by the sodium of the sodic hydrate (or soda), and as only one atom of hydrogen is displaced, nitric acid is said to be *monobasic*. When an acid admits of the displacement of two atoms of hydrogen, it is termed *di-basic*—as tartaric, oxalic, and, according to recent views, sulphuric acid; and when three atoms can be replaced—as in the case of common phosphoric acid, H<sub>3</sub>PO<sub>4</sub>, in which H<sub>3</sub> may be displaced by K<sub>3</sub> or Ag<sub>3</sub>, the acid is termed *tribasic*. The nomenclature of the compounds of acids with bases is still unfixed. The names of the alkali-metals (potassium, sodium, and lithium) and alkaline-earth metals (barium, calcium, &c.) are now commonly substituted for those of their oxides in the nomenclature of the corresponding oxygen salts—as, for example, *carbonate of sodium* and *sulphate of calcium* for carbonate of soda and sulphate of lime. The names of these bodies are

land's *Lecture Notes* such compounds are denominated *sodic carbonate, calcic sulphate, sodic nitrate*, &c.; and these terms will doubtless soon be generally adopted for the metallic salts of the oxygen-acids generally. The nomenclature of complex inorganic bodies is founded, for the most part, on the theory of types, the names of particular compounds being obtained from the name of the type by prefixing to it adjectives which express the nature of the element by which the hydrogen of the type is replaced and the number of atoms of it contained in one molecule of the compound. By way of illustration, we give a simple and a complicated example :

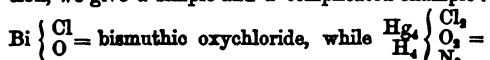

tetramercuro-tetrahydric dioxi-dichloro-dinitride. The nomenclature of organic compounds is founded on the same principles as that of inorganic bodies ; but our limited space prevents our entering into this subject.

*Chemical Notation* has been considerably altered by certain members of the recent chemical school ; but on the whole, the modifications, since the time when the system of Berzelius was introduced into England in the third edition of Turner's *Elements of Chemistry*, are not numerous. The most important are the introduction of 'general formulæ' by Gerhardt, in which letters of variable value are used as coefficients instead of numbers, and Odling's method of denoting the atomicity of polyatomic elements and radicals by means of accents placed above the symbols, which are then called dashed symbols. See TRIADS. Chemists are still at variance as to whether, when two or more atoms are represented in a compound, the figure indicating the repetition should be above or below the symbol ; whether, for example, water should be represented by  $\text{H}^{\circ}\text{O}$  or  $\text{H}_2\text{O}$ , and alcohol by  $\text{C}^{\circ}\text{H}^{\circ}\text{O}$  or  $\text{C}_2\text{H}_5\text{O}$ . The *ordinary*

similarly unite by twos, led to the division of salts into two classes—viz., into salts composed of an oxygen acid and an oxygen base, which were hence called oxygen salts, as  $\text{NaO}, \text{SO}_2$ , and  $\text{KO}, \text{NO}_2$ , which in the old notation represent sulphate of soda and nitrate of potash ; and binary or haloid salts, of which chloride of sodium,  $\text{NaCl}$ , is the type, which are formed by the union of the radical in hydrogen acids with some metal. Davy considered that the former class might be made similar to the latter by regarding them as composed of a metal and a compound radical having the same electro-negative chemical relations as the radicals in the hydrogen acids. According to this view, a radical,  $\text{SO}_2$ , not yet isolated, combines with hydrogen to form sulphuric acid, and with a metal to form sulphates, sulphuric acid being represented by  $\text{H}_2\text{SO}_2$ , and sulphate of lime by  $\text{Ca}, \text{SO}_2$ . In like manner, nitric acid and the nitrates were supposed to contain a radical,  $\text{NO}_2$ . Against this view Gerhardt urges that we know nothing of the proximate constitution, but are merely acquainted with the ultimate composition of compounds. Hence we now no longer use a formula for sulphuric acid indicating its supposed constitution ( $\text{HO}, \text{SO}_2$ ), but regarding it as a dibasic acid, express it, either as Miller does, by  $\text{H}_2\text{S}\text{O}_4$ , or by  $\text{H}_2\text{SO}_4$  (where  $\text{S} = 32$  and  $\text{O} = 16$ ), or by  $\text{SO}_2 \left\{ \text{O}_2 \right.$ , if we adopt the type-notation ; and we must not omit that Frankland, who may be regarded as the leading representative of the English school of modern chemistry, represents it by the formula  $\text{SO}_2\text{Ho}$ , when  $\text{Ho}$  is the abbreviated formula for  $\text{HO}$ , and represents a compound radical, to which he gives the name of hydroxyle, and which is commonly known as binoxide of hydrogen, being expressed, according to the old system, by  $\text{HO}_2$ . The following examples may enable the reader to pass from one system to another :

	Old System.	Revised System.	New Atomic Weights.	Frankland's Notation.
Sulphate of potassium, . . .	$\text{KO}, \text{SO}_2$	$\text{K}_2\text{SO}_4$	$\text{K}_2\text{SO}_4$	$\text{SO}_2\text{K}_2$
Sulphate of zinc, . . . . .	$\text{ZnO}, \text{SO}_2, 2\text{HO}$	$\text{ZnSO}_4, 2\text{H}_2\text{O}$	$\text{ZnSO}_4, 2\text{H}_2\text{O}$	$\text{SO}_2\text{HoZn}''', 2\text{HO}$
Nitric acid, . . . . .	$\text{HO}, \text{NO}_2$	$\text{HNO}_3$	$\text{HNO}_3$	$\text{NO}_2\text{Ho}$
Nitrate of sodium, . . . . .	$\text{NaO}, \text{NO}_2$	$\text{NaN}_3$	$\text{NaN}_3$	$\text{NO}_2\text{Na}$

The  $\text{Ko}$ ,  $\text{Zn}''$ , and  $\text{Na}$  in Frankland's notation represent compound radicals, to which he has given the names *potassoxyl, zincoxyl, and sodoxyl*, and which are represented in the ordinary new notation by  $\text{KO}$ ,  $\text{ZnO}$ , and  $\text{NaO}$ . These new names will probably soon get into general use in consequence of Frankland's great influence as the teacher of chemistry in the government School of Mines, and at the Royal Institution.\* We must refer to the article TRIADS for a description of what is meant by *atomicity*, or, as Hofmann terms it, *quantivalence*, and the reader will do well to study Lectures 10 and 11 of his *Modern Chemistry*. In the article just mentioned, we have stated that the degree of atomicity of an element is indicated by the number of dashes with which it is furnished. In the so-called *Graphic Notation*, which,

in the hands of Kekulé, Crum Brown, Naquet, Frankland, and others, has proved a most valuable aid in explanation of the constitution of chemical compounds, the degree of atomicity of an atom is thus expressed :  $\text{H}'$  by  $\text{H}$ ,  $\text{Zn}''$  by  $\text{Zn}$ ,  $\text{B}'''$

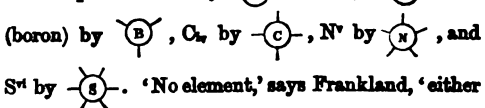

'No element,' says Frankland, 'either alone or in combination, can exist with any of its bonds disconnected ; hence the molecules of all elements with an odd number of bonds are generally diatomic, and always polyatomic—i. e., they contain two or more atoms of the element united together. Thus :

	Symbols.	Graphs.
Hydrogen,	$\text{H}'_2$	$\text{H}-\text{H}$
Chlorine,	$\text{Cl}'_2$	$\text{Cl}-\text{Cl}$
Nitrogen,	$\text{N}''_2$	$\text{N}=\text{N}$
Phosphorus,	$\text{P}^4_4$	$\text{P}-\text{P}-\text{P}-\text{P}$

An element with an even number of bonds can exist

\* Another peculiarity of Frankland's notation is the introduction of thick letters (Egyptian capitals). His formulæ are so written as to denote that the element represented by the first symbol of a formula, and printed in this type, is directly united by points of attachment or bonds with the other elements or compound radicals following the first symbol. Thus, to use his own illustration and notation, the formula  $\text{SO}_2\text{Ho}$ , (sulphuric acid) signifies that the hexad atom of sulphur is combined with the four bonds of the two atoms of oxygen, and also with the two bonds of the two atoms of hydroxyl. (By hexad we mean an atom with six bonds, one of which is subsequently figured in the text.)



Mercury,

Hg<sup>m</sup>

Graphic



Zinc,

Zn<sup>m</sup>

This graphic notation is most useful in fixing upon the mind the true meaning of symbolic formulae, and in elucidating the internal arrangement of the very complex molecules which often occur in both mineral and organic compounds. It also affords an easy means of shewing the causes of isomerism in organic bodies. The following example will suffice to illustrate our meaning. The simplest of the alcohol family, methylic alcohol, is derived from marsh-gas by the substitution of one atom of Frankland's hydroxyl, Ho or HO (O = 16), for one of hydrogen.

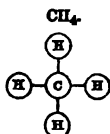

Marsh-gas.

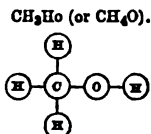

Methylic alcohol.

The Classification of Organic Compounds has, during the last few years, been much improved. Until a comparatively few years ago, organic compounds were arranged, according to their most obvious properties, into acids, bases, fatty bodies, &c. Now the great majority of these compounds are arranged in series, of which each group differs from the preceding one by a fixed additional number of certain atoms. Thus (see Armstrong's *Organic Chemistry*, pp. 143, 144) twelve alcohols are represented by the general formula  $\text{C}_n\text{H}_{2n+2}\text{O}$  (new notation), the first being represented by  $\text{CH}_4\text{O}$ , and the others differing from it by an additional number of multiples of  $\text{CH}_2$ . Bodies of analogous properties thus united are termed *homologous*. Again, every compound in a homologous series yields other compounds differing in composition from that from which they are derived, but yet bearing a different relation to it. Thus, alcohol yields ether, aldehyde, and acetic acid, and these so-called *heterologous* bodies form collateral series. This mode of classification is daily extending. It includes the *organic radicals*, such as methyl, ethyl, allyl, phenyl, cyanogen, &c.; the *hydrides of the compound radicals*, such as methylic hydride or marsh-gas, benzol, cyanic hydride or hydrocyanic acid, &c.; the *alcohols*, which form one of the most important of the families of organic compounds, and which are considered in a special article in this SUPPLEMENT; the *aldehydes* and *ethers*, both of which are specially described; the *acids*, of which the monobasic acids alone include six series, amongst which are the acetic or fatty series, represented by the general formula  $\text{C}_n\text{H}_{2n}\text{O}_2$ , and containing 19 or 20 distinct acids, the oleic series, the lactic series, the benzoic or aromatic series, &c.—while the dibasic acids may be divided into four series, in which occur the succinic series, containing nine acids, most of which present several modifications, and the tartaric series; the *Anhydrides* (q. v.), of which those belonging to the acetic acid group may be arranged in series; the *ketones* or *acetones*; the compounds of nitrogen containing the *amines*, *amides*, *imides*, &c.; and, in short, excepting the natural alkaloids, the protein-compounds and their derivatives, the uric acid group, pigments, &c., there are few organic com-

ments. In this article we have scarcely touched our remarks to the subjects bearing on general, and for the most part on theoretical chemistry. We may, however, allude, in conclusion, to two subjects which have undergone a great development during the last few years—viz., *Volumetric Analysis* and the *Synthesis of Organic Bodies*, both of which are discussed in special articles.

The general tenor of this article shews that chemistry is at present in altogether a transitional state. As Professor Anderson of Glasgow observes in his address to the Chemical Section of the British Association in September 1867, the atomic theory, which, at the commencement of the present century, sufficed to explain all the facts of chemistry that were then known, is now quite inadequate to that end. At that time, chemists were acquainted with comparatively few compounds, and in these, oxygen was of such preponderating importance, that the science might have been almost termed 'the chemistry of oxygen.' Oxygen is now deposed from its high place, and is supplanted by carbon to such a degree, that one of the first living chemists has actually proposed for organic chemistry the name of 'the science of the carbon-compounds.' Facts gradually accumulated in the course of time which did not admit of explanation on the Daltonian theory; and as their number increased, such terms as catalysis, allotropy, &c., were invented, under which such facts were grouped together as were supposed to depend on similar causes. Such grouping may have certain temporary advantages, provided it is understood that, to use Professor Anderson's words, it is 'the grouping of ignorance.'

It is indeed obvious that a true theory of chemistry must be a part of a general theory of dynamics, and that until we obtain some more distinct idea of how the atoms are grouped in the molecules of substances (see ATOMIC THEORY) than we at present possess, the link connecting theoretical chemistry and theoretical dynamics is wanting. The doctrine of *Atomicity* evidently points to some general truth; it has been of great use in grouping together numerous facts, and in leading to investigations which have resulted in the discovery of many new facts and new generalisations, but we now want an explanation of this doctrine, and this chemistry does not appear to be able to give us. The want of a theoretical explanation does not, however, render a generalisation valueless, and much progress has been made of late years in ascertaining the 'chemical structure' of substances—that is, in obtaining graphic formulae, which consistently represent all the reactions by which the substances are formed or transformed. Before discussing the subject of chemical structure, it will be well to consider somewhat more fully than has been done above, the reasons why certain numbers have been selected for the atomic weights of the elements rather than any multiples or sub-multiples of them (see ATOMIC WEIGHTS). It was pointed out by Dulong and Petit that a close relation exists between the specific heat of a solid elementary substance and its atomic weight. Thus, if we take the old system of *Atomic Weights* (q. v.), and multiply the specific heat of each solid element by its atomic weight, we find that the elements form three groups. In the first, the product of specific heat into atomic weight, or *atomic heat*, varies from 6 to 6.6. In the second it varies from 3 to 3.3. In the third group, containing the allied elements, carbon, boron, and silicon, no regularity can be traced. By far the greater number of solid elements belong to the first or second group. Now it is plain that the atomic heat of a member of the first group is approxi-

arbitrary, we can make the atomic weights of the two groups agree by doubling the atomic weights of the members of the second group. This was first proposed by the eminent Italian chemist, Cannizzaro, and has now been accepted by most chemists. These new atomic weights not only greatly simplify Dulong and Petit's law, but are also in harmony with many other facts, most of which were observed after the change had been made. Thus the formulae of corrosive sublimate, bichloride of tin, and zinc methyl are, according to the old system,  $HgCl_2$ ;  $SnCl_2$ ; and  $ZnC_2H_2$ , and  $H = 1$ . According to the new system they are  $HgCl_4$ ;  $SnCl_4$ ; and  $ZnC_2H_4$ .

Nitrate of Silver.

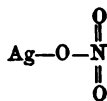

Nitrate of Lead.

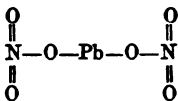

Basic Nitrate of Lead.

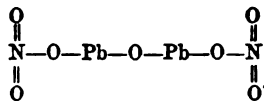

We at once see the connection between the dyad character of lead ( $-\text{Pb}-$ ), and the occurrence of basic salts.

Similarly we know that if we pass a current of chlorine gas into a cold solution of caustic potash, we obtain a mixture of chloride of potassium and hypochlorite of potash— $\text{Cl}_2 + 2\text{KHO} = \text{KCl} + \text{KClO} + \text{H}_2\text{O}$ . But that if, instead of caustic potash, we take slaked lime, we obtain, not a mixture, but a single substance:  $\text{Cl}_2 + \text{CaH}_2\text{O}_2 = \text{CaOCl}_2 + \text{H}_2\text{O}$ . Putting the new symbols into a graphic form we have:

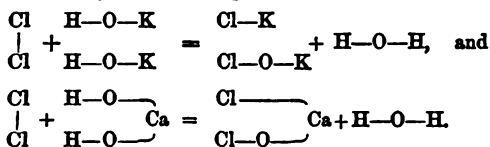

Where we see why we have a mixture in the first case, and a single substance in the second, the reason being that calcium being a dyad, one atom of it represents two atoms of potassium. Many other examples might be given, but these may suffice as an indication of the reasons which have induced chemists to prefer the atomic weights given in the second column in the table in the article ATOMIC WEIGHTS.

Assuming, then, these atomic weights, let us return to the subject of *Chemical Structure*. This may be defined in various ways, but most conveniently as the indication by a graphic formula, or something equivalent to it, of all the chemical changes by which the substance can be formed or decomposed. This will best be illustrated by means of a few

examples, and we shall select these from among organic compounds—that is, compounds of carbon, because the structure of these compounds has been most fully investigated.

Acetic acid has (on the new system, which will be exclusively used in the remainder of this article) the formula  $\text{C}_2\text{H}_3\text{O}_2$ . If it is treated with caustic potash, it yields acetate of potash according to the equation  $\text{C}_2\text{H}_3\text{O}_2 + \text{KHO} = \text{C}_2\text{H}_2\text{KO}_2 + \text{H}_2\text{O}$ . Here one atom of hydrogen has been replaced by one atom of potassium, and we find that further treatment with caustic potash does not cause any further replacement of hydrogen by potassium. We may therefore write the formula of acetic acid thus:  $\text{H}-(\text{C}_2\text{H}_2\text{O}_2)$ , and this formula indicates the replaceability of one atom of hydrogen by metal, and explains (as far as such formulae can explain anything) the occurrence of such compounds as acetate of lead ( $\text{C}_2\text{H}_2\text{O}_2$ )— $\text{Pb}-(\text{C}_2\text{H}_2\text{O}_2)$ , and all the other acetates. The question now remains, what is the structure of the group ( $\text{C}_2\text{H}_2\text{O}_2$ ), which is united in acetic acid to hydrogen, and in the acetates to metal?

To answer it we must examine some other reactions of acetic acid. When treated with pentachloride of phosphorus, it loses an atom of oxygen, the place of which is taken by two atoms of chlorine—the pentachloride of phosphorus taking the oxygen in exchange for the chlorine; but instead of obtaining a compound ( $\text{C}_2\text{H}_2\text{OCl}_2$ ), we find that the result is expressed by the equation:  $\text{C}_2\text{H}_3\text{O}_2 + \text{PCl}_5 = \text{C}_2\text{H}_3\text{OCl} + \text{HCl} + \text{POCl}_3$ . We thence conclude that in acetic acid the atom of dyad oxygen removed in the action given above was united to an atom of hydrogen, and to the group ( $\text{C}_2\text{H}_2\text{O}$ ), and represent the change thus:

When treated with pentachloride of phosphorus, it loses an atom of oxygen, the place of which is taken by two atoms of chlorine—the pentachloride of phosphorus taking the oxygen in exchange for the chlorine; but instead of obtaining a compound ( $\text{C}_2\text{H}_2\text{OCl}_2$ ), we find that the result is expressed by the equation:  $\text{C}_2\text{H}_3\text{O}_2 + \text{PCl}_5 = \text{C}_2\text{H}_3\text{OCl} + \text{HCl} + \text{POCl}_3$ . We thence conclude that in acetic acid the atom of dyad oxygen removed in the action given above was united to an atom of hydrogen, and to the group ( $\text{C}_2\text{H}_2\text{O}$ ), and represent the change thus:

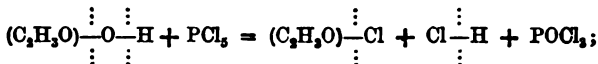

the replacement of the dyad oxygen by two atoms of the monad chlorine necessitating the falling asunder of the compound. The reactions of chloride of acetyl ( $\text{C}_2\text{H}_3\text{OCl}$ ) lead us to the further conclusion that the atom of hydrogen replaceable by metal is the atom not present in chloride of acetyl, so

that the formula  $(\text{C}_2\text{H}_2\text{O})-\text{O}-\text{H}$  is a fuller and more explanatory form of  $(\text{C}_2\text{H}_3\text{O}_2)-\text{H}$ . Again, if we heat acetate of potash with caustic potash, we have marsh gas ( $\text{CH}_4$ ) given off, and the residue consists of carbonate of potash

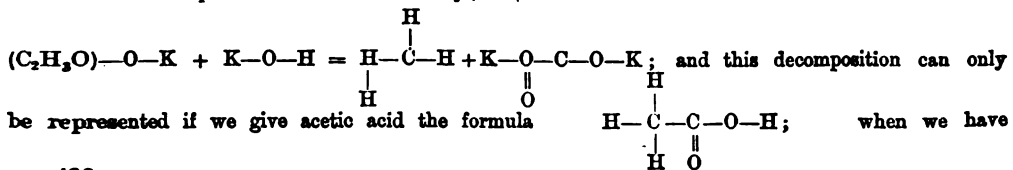

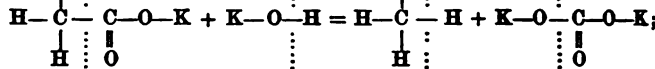

the dotted lines separating in the diagram the symbols of the parts of the molecules which change places.

We have considered only a few of the reactions of acetic acid, but the formula just given is equally consistent with all the others. It is therefore said to exhibit the *structure* of acetic acid. This word 'structure' is perhaps a little misleading—we must recollect the precise sense in which it is used, as a concise representation of many reactions. It is conceivable that it may have some relation to the actual relative position of the atoms in a molecule of acetic acid, but we have not as yet any means of ascertaining whether this is so or not.

We may illustrate the meaning of chemical structure further by a somewhat more complex case. Asparagine, a colourless crystalline substance extracted from asparagus, and also from the blanched shoots of other plants, has the composition expressed by the formula  $\text{C}_4\text{H}_8\text{N}_2\text{O}_5$ . When treated with caustic potash it yields ammonia and a body called aspartate of potash—the potash salt of aspartic acid. The change is obviously an exchange of

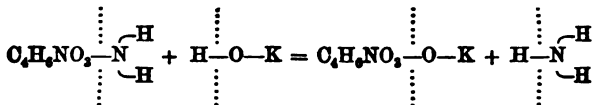
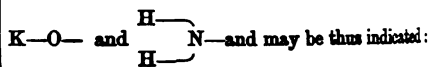

Aspartic acid is then  $(\text{C}_4\text{H}_8\text{NO}_5)-\text{O}-\text{H}$ , and we have to study its decompositions in order to discover the structure of the group  $(\text{C}_4\text{H}_8\text{NO}_5)$ . Now, aspartic acid is attacked by nitrous acid, and the products are nitrogen gas, water, and malic acid, thus:  $\text{C}_4\text{H}_8\text{NO}_5 + \text{HNO}_2 = \text{C}_4\text{H}_8\text{O}_5 + \text{N}_2 + \text{H}_2\text{O}$ . Here we have the triad nitrogen of the aspartic acid re-

placed by the dyad O, and the monad group  $-\text{O}-\text{H}$  of the nitrous acid, and this leads to the formula  $\begin{array}{c} \text{H} \\ | \\ \text{N}-(\text{C}_4\text{H}_8\text{O}_5)-\text{O}-\text{H} \end{array}$  for aspartic acid. The equation above thus becomes:

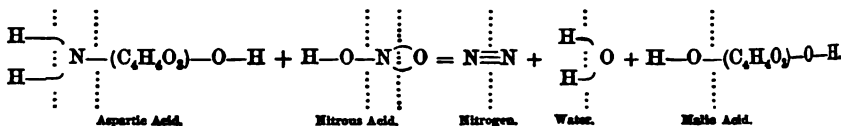

When malic acid is treated with hydrobromic acid, we obtain water and bromo-succinic acid:

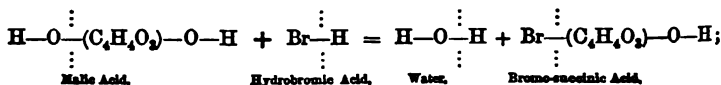

and we can prove that the group  $\text{H}-\text{O}-$ , here replaced by Br, is that one which in aspartic acid

is represented by  $\begin{array}{c} \text{H} \\ | \\ \text{N}- \\ | \\ \text{H} \end{array}$ . Bromo-succinic acid,

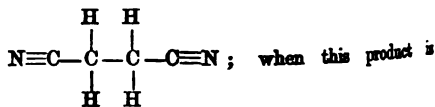

when treated with nascent hydrogen, has its bromine removed and hydrogen put in its place, thus yielding succinic acid ( $\text{C}_4\text{H}_8\text{O}_4$ ). We shall most easily arrive at the structure of succinic acid by studying its synthesis.

Olefiant gas ( $\text{C}_2\text{H}_4$ ) unites with bromine to form a liquid having the composition ( $\text{C}_2\text{H}_4\text{Br}_2$ ), and (as can easily be proved by its relation to glycol and glycollic acid), a structure represented thus:

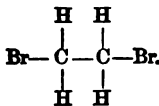

This bromide of ethylene, as it is called, when treated with cyanide of potassium, gives bromide of potassium, and a substance which may be called cyanide of ethylene—bromine and cyanogen changing places  $(\text{C}_2\text{H}_4\text{Br}_2) + 2\text{KCN} = \text{C}_2\text{H}_4(\text{CN})_2 + 2\text{KBr}$ . As cyanide of potassium is  $\text{K}-\text{C}\equiv\text{N}$ , it follows that cyanide of ethylene is

boiled with caustic potash and water ammonia, is given off, and succinate of potash remains in solution. Here we have nitrogen uniting with hydrogen, while the place of the nitrogen is taken by that with which the hydrogen was united—viz. the dyad O, and the monad  $-\text{O}-\text{K}$ . We thus obtain the structural formula of succinic acid.

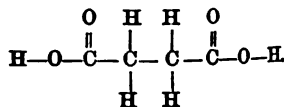

Here are obviously two hydrogen atoms having a different function from the rest—those, namely, which are replaceable by metal, and which, in the above formula, are represented as directly united to oxygen. That it is not one of these that is replaced by bromine follows from the fact that bromo-succinic acid has also two atoms of hydrogen replaceable by metals in exactly the same way as in succinic acid itself, and as the other four atoms of hydrogen do not differ in position in the diagram from one another, we have only one possible formula for bromo-succinic acid; and therefore, for malic acid:

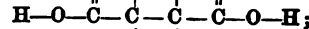

and for aspartic acid :

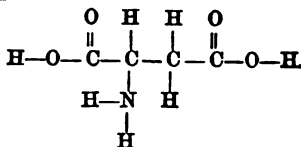

We have, however, two possible structural formulæ for asparagine, as it is plain that the two groups H—O— in aspartic acid are not similar to one another, and we have not as yet any means of deciding between them. The reader will see that they are different, and from the way in which structure has been proved, will also see that reactions may be obtained which would decide between the two.

It is not necessary to give any further examples of chemical structure—the two we have treated in some detail may suffice to shew how the principle is applied, and what is the nature of the evidence in favour of particular structural formulæ.

**CHERUBINI, LUIGI-CARLO-ZENOBIO-SALVATORE-MARIA**, an eminent musical composer, was born at Florence in 1760, and received his early musical training there under the Felici (father and son), P. Bizzari, and C. Castrucci. He afterwards studied for a year at Bologna under Sarti, to whom he owed his thorough knowledge of counterpoint and fugue. He visited London in 1784, where he brought out two operas, *La Finta Principessa* and *Giulio Sabino*, and afterwards settled in Paris for the remainder of his life, paying occasional visits to Italy. His *Ifigenia in Aulide* appeared in 1788; and in 1791 his *Lodoiska*, which work first secured proper appreciation for his genius, and effected a change in the whole character of the French school of composition. These operas were followed in succession by *Eliaca*, *Medea*, *Les Deux Journées* (also known as *Die Wasserträger*), *Anacreon*, and *L'Hôtelier de Portugal*. His latest opera, *Ali Baba*, was produced, after a long interval, in 1833. Besides operas, C. wrote numerous masses, motets, and other sacred compositions of so great merit, that Beethoven regarded him as the greatest living master of sacred music; also quartets for the violin, viola, and violoncello, and symphonies. His latest work, *Cours de Contrepoint et de Fugue*, appeared in 1835. C. died at Paris in 1842, and his *Requiem*, the last of his masses, was performed at his funeral service.

**CHICOPEE**, formerly **CABOTSVILLE**, and including Chicopee Falls, a manufacturing town of Massachusetts, U. S., on the left bank of Connecticut River, at the mouth of Chicopee River, 5½ miles north of Springfield. Chicopee Falls supplies water-power to numerous cotton and woollen factories, paper-mills, brass cannon and bell foundries, and the Ames Manufacturing Company, which makes machinery, swords, bronze cannon, statues, &c. C. has 10 churches and several newspapers. Pop. (1870) 9607.

**CHIFF-CHAFF** (*Sylvia hippolais*), a small species of warbler, very widely diffused, being found both in England and in the neighbourhood of Calcutta. It is common in the south of Europe, is in Britain a summer bird of passage, arriving, however, very early in spring, and does not extend northward into Scotland. Its general colour is brown;



Chiff-chaff (*Sylvia hippolais*).

repetition of two notes resembling the syllables chiff-chaff. It is also called the Lesser Pettychaps.

**CHILLICOTHE**, or **CHILICOTHE**, a city of Ohio, U. S., beautifully situated on the right bank of the Scioto River, 45 miles from its confluence with the Ohio, and the same distance south of Columbus, on the Cincinnati and Marietta Railway, and Ohio and Erie Canal; has 13 churches, 3 banks, court-house, foundries, steam-engine and agricultural implement factories, &c. Founded in 1796, and former capital of the state. Pop. (1870) 8920.

**CHINANDEGA**, a town of Central America, Nicaragua, stands in a fertile plain at the foot of some mountains, about 18 miles north-west of Leon, and about 10 miles from the Pacific coast. The houses are straggling, of one story, built of adobe, and many of them are enclosed by gardens and plantations. Maize, sugar, cotton, hides, and poultry are produced in the vicinity. Pop. about 10,000.—**OLD CHINANDEGA**, which is contiguous, has a pop. of about 4000.

**CHINESE EDIBLE DOG**. The kind of dog used as an article of food in China, and reared in order to be so used, being esteemed as a delicacy, is a small dog of greyhound-like form, with somewhat



Chinese Crested (Edible) Dog.

terrier-like head, and muzzle more elongated than in terriers. It is fleet and active, gentle and affectionate. The skin is almost destitute of hair; but there is a variety having a crest of long hair on the head, and a large tuft of hair at the tip of the slender and otherwise naked tail.

laccæ, a native of the mountainous countries to the east of Bengal. In some parts of India, it is called *Cedar* or *Bastard Cedar*, names, however, which are also given to other kinds of wood. C. W. is much valued in India, and is used for all purposes for which mahogany is used in Britain. It makes beautiful and light furniture, but is apt to warp in very dry weather. Beautifully veined and mottled pieces are occasionally met with, and are highly valued.

**CHIUSA, LA** (so called from the ground having been originally enclosed as pasture-land for horses), a town of Sicily, in the province and 30 miles south-south-west of Palermo, on the slope of some hills. The town was built in 1320. Agates are found in the vicinity. Pop. 6840.

**CHLO'RODYNE** is a patent or quack medicine of considerable popularity, invented by a Dr Collis Browne, but largely imitated by various chemists. It contains opium, chloroform, prussic acid, and probably Indian hemp, and is flavoured with sugar and peppermint. As it is apt to separate into two liquids on standing, it should never be taken unless it has previously been well shaken; and as, in taking a dose of chlorodyne, the patient swallows an unknown quantity of three or four of the deadliest poisons with which we are acquainted, it is always advisable to begin with small doses. It is unquestionably a compound which sometimes succeeds in allaying pain and inducing sleep, when opiates have failed; but whether a physician is justified in recommending a remedy with the composition of which he is unacquainted, is a doubtful question. Ten or fifteen drops is the average dose.

**CHOPIN, FRÉDÉRIC**, a distinguished Polish pianist and musical composer. He was born at Zelazowa-wola, near Warsaw, in 1810, and studied music at Warsaw under Professor Joseph Elsner. An exile after the revolution of 1830, he took up his residence in Paris, where he lived admired both professionally and in society. His health, always delicate, broke down in 1837, when he went for a time to Majorca, from which he afterwards returned, benefited by the change. After again suffering much from illness and depression of spirits, he visited England and Scotland in 1848, and in London was welcomed with enthusiasm in public and private. He never recovered from the fatigues of this journey, but died in Paris, 17th October 1849, and was buried, by his desire, beside Bellini, in the cemetery of Père-la-Chaise. His compositions, restricted to pianoforte music, are in high esteem among musicians, and consist chiefly of preludes, nocturnes, polonaises, mazurkas, and valse, with a few concertos and sonatas. They are pervaded by a sensitive, restless, and highly poetic fancy, and abound in subtle ideas, graceful and original harmonic effects, and rich ornamentation. The so-called polonaises, mazurkas, and valse are not dance music, but dreamy compositions suggestive of the rhythm and character of these dances, in which the peculiarities of Polish national music are blended with French elegance and taste.

**CHRO'NOGRAPH.** Different forms of time-measurers, or time-recorders, under this designation, have been invented within a recent period.

*Benson's* chronograph is intended to measure intervals of time down to tenths of a second, for use at horse-races and other occasions where a seconds watch is not exactly suited. It has an ordinary quick train lever movement, carrying hands which move over a dial. One of these is a seconds hand, very peculiarly made. This seconds hand is

most hand has a small cup with a minute hole at the bottom; while the corresponding end of the uppermost hand is bent over so as exactly to reach this puncture. The little cup is filled with ink, having a consistency between that of writing fluid and printers' ink. Suppose that a horse-race is about to take place. The observer keeps a steady look-out for the fall of the starter's flag, or whatever the signal may be; he gives a pull to a cord or string connected with the mechanism peculiar to the instrument; by this movement, the outer and bent end of the upper seconds hand dips down through the ink-cup in the lower hand, and through the puncture to the dial. A small black spot or mark is thus made upon the dial-plate; and this is repeated as each horse passes the winning-post. If the eye and hand of the operator are quick and accurate, there is a reliable record thus presented by the instrument of the duration of the race, sometimes as close as one-tenth of a second. The instrument is now adopted at the principal races as a suitable one for the purpose; thus it is used for races such as the Derby, the Oaks, the Goodwood, the St Leger, &c. It is also available for many other purposes.

*Strange's* chronograph is designed for a more scientific purpose, and constructed with more careful details. The object is to measure extremely short intervals of time, for the determination of longitudes in great trigonometrical surveys. The observer, when a particular star traverses the field of his telescope, touches a small ivory key; and on the instant, a dot or mark appears on a sheet of paper coiled round a barrel. The instrument being connected with an astronomical clock, there is a dot made for every beat of the pendulum; and as these dots are a considerable space apart (considerable, that is, for the refined instruments of the present day), it is possible to determine so wonderfully minute an interval as one hundredth of a second.

Other forms of chronograph have been adopted by astronomers. One was suggested by Professor C. A. Young in 1866 to assume the functions of a recording chronograph, by marking the instant of observation in hours, minutes, seconds, and hundredths of a second, in printed characters, and in a form suitable for preservation and reduction.

Chronographs connected with electric and magnetic apparatus are used for determining the velocity of projectiles. Many forms have been devised by Noble, Bashforth, Navez, Le Bouleugé, and other inventors. The most general arrangement consists in causing the bullet to pass through a series of screens; the rupture of each screen breaks for a moment the continuity of an electric current, sets in action an electro-magnetic apparatus, and makes a permanent mark or record.

**CHRYSOBALANA'CEÆ, or CHRYSOBALANEÆ**, according to some botanists, a distinct natural order of plants; according to others, a sub-order of ROSACEÆ (q. v.). They are distinguished from the other plants usually included in the order Rosaceæ by their irregular petals, and by having the stamens also irregular, either in size or position; the ovary stalked, its stalk adhering on one side to the calyx, the style proceeding from its base. The fruit is a drupe of one or two cells. The species are trees or shrubs, natives generally of tropical and sub-tropical regions. About 50 species are known. The fruit of many is eatable, as the COCOA PLUMS (q. v.) of the West Indies (*Chrysobalanus*), the fruit of *Parinarum excelsum* in Sierra Leot, and that of *Mouillea grandiflora* in Brazil. The kernels of some resemble sweet-almonds, as those of

spiny plant, common in some parts of the Himalaya Mountains, and which is also planted for hedges in the Khasia Hills, at an elevation of 5725 feet above the sea; whilst in Sikkim, it is only found where the elevation is above 8000 feet. This plant would in all probability succeed well in Britain, and an attempt should certainly be made to introduce it.

**CHUCUITO, or CHUQUITO**, a town of Bolivia, in the dep. of Puno, and 100 miles east-north-east of Arequipa, on the west shore of Lake Titicaca, at the mouth of a stream flowing from the Andes. It was formerly of much greater size and importance than it is at present, having had, it is said, at the beginning of the 18th c., the incredible number of 300,000 inhabitants. Its present pop. is only about 5000. In the province of the same name, of which it is the capital, there are mines of silver and gold, and interesting antiquarian remains.

**CHU'NAM**, the Indian name for a very fine kind of quick-lime made from calcined shells or from very pure limestone, and used for chewing with Betel (q. v.), and for plaster. Both recent and fossil shells are used for making chunam. Extensive beds of fossil shells employed for this purpose occur in the south of India, particularly in low marshy situations near the sea-coast. The shells used are in the first place very carefully cleaned; they are then calcined in kilns, with wood charcoal. When chunam is to be used for plaster, it is mixed with fine river-sand, and thoroughly beaten up with water. A little *jaggery* (coarse sugar) is also added. When very beautiful work is desired, three coats of chunam are given to the wall, and the result is a plaster almost equal to marble in its polish and beauty. The third coat is applied in the form of a very fine paste, consisting of four parts of lime and one of fine white sand, beaten up with whites of eggs, sour-milk, and *ghee* (butter). After it has been rubbed on with a wooden rubber, the surface is washed with a cream of pure lime, and is rubbed with a polished piece of quartz or rock crystal. During this process, the wall is sprinkled with powder of pot-stone, and the rubbing is continued until the wall is quite dry, every trace of moisture being finally removed by a cloth. Chunam is an important article of trade in India.

**CHUR** (Fr. *Coire*, anct. *Curia Rhetorum*), a town of Switzerland, capital of the Grisons, in the valley of the Upper Rhine, in a fertile plain about 2000 feet above the sea, and surrounded by high mountains, 60 miles south-east of Zurich, on the Plessur, about a mile from its junction with the Rhine. It is of importance as standing on the great road to Italy by the Splügen and Bernardin passes, and thus possessing a considerable transit trade. C. stands on uneven ground, has narrow streets, and is divided into a high and low town. The bishop's palace, and the quarter around it, inhabited by the Roman Catholics, occupy the summit of an eminence, and are separated from the rest by walls and battlements, closed by double gates. In the same quarter stand the old cathedral, a round, arched, or Byzantine edifice, founded in the 8th c.; the Church of St Lucius or the *Dom*, a curious example of early-pointed Gothic, including fragments of earlier buildings. It contains singular old carving, paintings, and statues, and also, it is said, the bones of St Lucius, who was a British king. Behind the episcopal palace is a kind of ravine lined with vineyards. In the lower town there are also some very ancient buildings. *Romansch* is still spoken in the vicinity; a newspaper in this dialect is published in the town; and a considerable collection of *Romansch* literature is to

directions through the Grisons; and a railway connects the town with Zurich and other places. There are manufactures of zinc wares and cutting tools. Pop. (1870) 7552, of whom about 2000 are Catholics.

**CIALDINI, ENRICO**, son of Giuseppe Cialdini, civil engineer in the Modenese service, was born at Castel Vetro, in that duchy, August 10, 1813. Incurring the displeasure of his Jesuit preceptors, he was sent by his parents, who designed him for the medical profession, to study at the university of Parma. When the abortive insurrection of 1831 broke out in the duchies, C. joined the volunteers of Reggio; and on the capitulation of Ancona, embarked for France. Here he resumed his medical studies, living in the Rue de la Harpe, and eking out his scanty means by translating for the booksellers. The struggles against absolutism in the Iberian Peninsula opened anew the career of arms to the Italian exiles. He determined to join the legion raised by Don Pedro in France against the Miguelists. A severe attack of cholera delayed his departure till March 1833, when he sailed for Oporto with letters of introduction from several Parisian notabilities. Arrived off the port, he threw the letters into the sea, determined to trust to his merit alone, and enlisted as a private in the 2d Regiment, composed mainly of Italian refugees. His great personal courage soon secured his promotion; and the unanimous vote of his comrades pronounced him the worthiest man to receive the Order of the Tower and Sword decreed by the government to his company.

After the capitulation of Evora, C. joined (October 22, 1835) the legion of Oporto, formed under Borso di Carminati for service in Spain. In this force, in which Fanti and Durando were officers, C. gained further honours. At Cherta he received the Cross of San Ferdinand; and in the retreat from Morella, by a great effort of strength and courage, saved the life of his brother Guido. In 1839, he exchanged, with some sacrifice of rank, into the regular army, in which, at the close of the war, he found himself captain with another decoration. The fact that some of his old chiefs conspired against Epartero in 1841, seems to have caused him to be sent on half-pay to Valencia, where he married a lady of good family. In 1843, he followed Narvaez in his march against Madrid; was made by him colonel of the regiment of St Ferdinand; and afterwards employed in organising the Civil Guard on the model of the French *gendarmérie*. He was in this force when Charles Albert headed the Italian rising in 1848. A bold and loyal soldier, C. had always kept aloof from the plots of the secret societies; but now he at once threw up his appointments in Spain, and hurried to Italy, arriving in time to aid his old comrade Durando in the defence of Vicenza. Here he received a dangerous wound, and fell into the hands of the Austrians. On his release, he was employed by the Sardinian government in the arduous task of reducing to regular discipline the unruly volunteers from the duchies. He succeeded at last, and fought well at the head of his new regiment in the brief campaign of 1849. During the ten years that elapsed from the defeat of Novara to the renewal of the war in 1859, C. was actively employed. In the Crimea, he commanded the 3d division of the Sardinian Contingent; and on his return was appointed inspector-general of Bersaglieri and aide-de-camp to the king—a rare distinction for a man of plebeian origin. He was entrusted by Cavour with the formation of the famous *Cacciatori delle Alpi*, placed under the command of

the victory at Palestro was his chief exploit, the further progress of the Italians being stopped by the peace of Villafranca. In 1860, the success of Garibaldi in the south, and the formation of a papal army, led to the intervention of Piedmont. Fanti entered the States of the Church with two divisions, one of which was under the command of Lieutenant-general Cialdini. The campaign thus commenced was the most brilliant in C.'s history. He reduced Pesaro; intercepted, by a prompt and skilful movement, the march of Lamoriciere on Ancona; defeated him at Castelfidardo, and compelled Ancona to surrender. Then turning southwards, where the irregular forces of Garibaldi were beginning to weary before a first-class fortress and a veteran army, he defeated the troops of Francis II. on the Garigliano. Diplomacy delayed the fall of Gaeta till February 13, 1861, when it yielded to C. after a vigorous bombardment, as did the citadel of Messina shortly afterwards. Turin erected a statue to C. (*Vincitore Sempre*), and Reggio elected him deputy in April. In the following summer, he was sent as governor to Naples; but was relieved in a few months at his own request. He had also to act against Garibaldi on the occasion of the second Sicilian expedition. When the army of Italy was reorganised in 1863, C. was appointed to one of the chief commands. Senator in March 1864, he signalled himself by his brilliant speech in favour of the transfer of the capital (Dec. 1864). In the war of 1866, the advice of La Marmora was followed, and the defeat of Custoza was the result. Before a new campaign could be fairly opened, the cession of Venetia put an end to active operations. C. was appointed chief of the staff on the resignation of La Marmora. In 1867, C. was intrusted by the king with the formation of a new ministry, but failed; and in the same year he was made commander-in-chief of the troops in Central Italy.

**CICINDELA**, a genus of insects of the order *Coleoptera*, section *Pentamera*, the type of a large family, *Cicindelidae*. This family is nearly allied to *Carabidae*, and the insects belonging to it are among

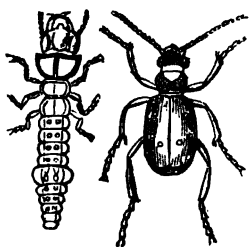

*Cicindela campestris*, larva and perfect insect.

the most voracious of those beetles which, both in their perfect and larva state, prey on other insects. They have a strong head, with projecting toothed mandibles, and are particularly distinguished by a sort of hook or nail, which is articulated by its base to each of the lower jaws or maxilla. They are more abundant in tropical than in cold countries; a few species, none of them large, are found in Britain. The head of the larva is large, concave above, and the back furnished with two remarkable hooked spines, which are said to be used as anchors to fix it at any part it chooses of its burrow in the earth; whilst the soil which it excavates, is carried to the mouth of the burrow in a sort of natural basket formed of the concave back of the head and the recurved mandibles. The larva lies in wait in its burrow, its head just level with the ground, till its prey comes within reach, upon which it suddenly rushes.—*C. campestris*, a green species with whitish spots, is common in most parts of Britain, in dry sandy places exposed to the sun.

its entrance into the Gulf of California. It is a thriving place, with gold-washings in the vicinity. Pop. about 9000.

**CINISI**, a town of Sicily, in the province of Palermo, 14 miles west-north-west of Palermo, near the coast. It is a neat, cheerful town, with straight, regular streets, and has 6714 inhabitants. The Benedictine convent here was once a feudal castle.

**CINNAMIC ACID AND THE CINNAMYL SERIES.** Cinnamyl is a compound radical, as yet unisolated, which is represented by the formula  $C_{12}H_9O_2$ , and which includes amongst its compounds cinnamic acid ( $C_{12}H_9O_2HO$ ), oil of cinnamon, which is chemically a slightly impure aldehyde of cinnamic acid, or a hydride of cinnamyl ( $C_{12}H_9O_2H$ ), chloride of cinnamyl ( $C_{12}H_9O_2Cl$ ), styrene or peruvine, known chemically as cinnamic alcohol ( $C_{12}H_{11}O_2$ ), cinnamol and styrol, each represented by the formula  $C_9H_7$ , and styracin ( $C_{12}H_9O_2$ ). We shall briefly notice the most important of these compounds—viz., cinnamic acid and oil of cinnamon. *Cinnamic Acid* ( $C_{12}H_9O_2$ ) crystallises in colourless prisms, which are sparingly soluble in cold water, but dissolve readily in boiling water, alcohol, and ether. It fuses at  $266^\circ$ , and boils with or without decomposition, according to the manner in which it is heated, at about  $570^\circ$ . It is converted by most decomposing agents into benzoyl compounds, such as benzoic acid, oil of bitter almonds, &c.; for example, when fused with hydrate of potash, it assimilates the elements of water, and breaks up into acetic and benzoic acids; when boiled with peroxide of lead, it is converted into oil of bitter almonds and benzoic acid, &c. It exists naturally in a free state in liquid storax, the balsams of Tolu and Peru, and gum benzoin, and is often deposited in large crystals from old samples of oil of cinnamon and from cinnamon water. It is always formed from oil of cinnamon when the latter is exposed to the action of the air, and it has been synthetically or artificially formed by exposing equivalent quantities of chloracetyl ( $C_2H_3O_2Cl$ ) and oil of bitter almonds ( $C_{11}H_9O_2$ ) to a prolonged heat in a closed glass tube. *Oil of Cinnamon* and *Oil of Cassia*, although prepared from different kinds of trees, are virtually identical in their composition, each consisting mainly of cinnamic aldehyde, or hydride of cinnamyl, mixed with certain resinous matters. Oil of cinnamon is an article of the materia medica, and in doses of one minim to a five-grain pill, forms an excellent aromatic addition to cathartic pill-masses.

**CITRIC ACID** ( $C_6H_8O_7$  or  $C_6H_8O_{11}.3HO$ ) is a powerful tribasic acid, which crystallises in large transparent colourless prisms. These crystals are readily soluble in water and alcohol, but are insoluble in ether. The crystals contain two atoms of water of crystallisation (not expressed in the above formulae), which are expelled at a temperature of  $212^\circ$ . Citric acid has a strongly acid taste and reaction, and displaces carbonic acid from the carbonates. Its watery solution quickly becomes mouldy on exposure to the air, and the acid is then found to be converted into acetic acid. When heated to about  $350^\circ$ , vapour of acetone and carbonic oxide are given off, and a residue of acetic acid ( $C_2H_4O_2$ ), an acid occurring in the leaves and roots of monkhood and other species of *Aconite*, is left; and when fused with potash, it assimilates the elements of water, and is decomposed into oxalic and acetic acids, as shewn in the equation:

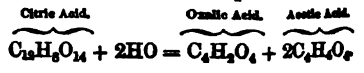

many fruits owe their agreeable acidity. It occurs in a free state either alone or associated with malic and tartaric acids in oranges, lemons, cherries, currants, raspberries, gooseberries, strawberries, whortleberries, &c., and in several tubers and bulbs, as in the potato and onion. It also exists in combination with potash or lime in potatoes, onions, and artichokes.

This acid, which is almost always prepared from lemon or lime juice, is thus obtained. The juice, after undergoing incipient fermentation, is filtered, and neutralised with chalk; and the insoluble citrate of lime thus formed is decomposed with very dilute sulphuric acid. On the removal of the sulphate of lime that is thus formed by filtration, the solution of citric acid must be concentrated till a film begins to form, when the crystals readily separate on cooling. Citric acid has also been prepared from unripe gooseberries, whose juice is allowed to ferment; and after the removal of the alcohol by distillation, the acid is separated in the way already described. 100 lbs. of gooseberries yield 10 lbs. of spirit of spec. grav. 0.928, and 1 lb. of crystallised acid.

Citric acid is used largely in manufactures; calico-printers employ it for discharging the mordant from the cloth in patterns; and it is used in dyeing silk with safflower, and for heightening the tint of cochineal. The raw material from which the acid for these purposes is obtained 'is a black fluid like thin treacle, which comes from Sicily, and is obtained by inspissating the expressed juice of the lemon after the rind has been removed for the sake of the essential oil.'—Watts's *Dictionary of Chemistry*, vol. i. p. 995.

The most important of the numerous salts of citric acid are the citrates of lime, potash, ammonia, and iron. *Citrate of Lime* ( $C_3H_5O_{11} \cdot 3CaO + 4Aq$ ) is formed in the preparation of citric acid, and is a fine white crystalline powder, more soluble in cold than in hot water. *Citrate of Potash* ( $C_3H_5O_{11} \cdot 3KO + 2Aq$ ) is formed by neutralising the acid with carbonate of potash, and crystallises in clear deliquescent needles, insoluble in alcohol. *Citrate of Ammonia* ( $C_3H_5O_{11} \cdot 3NH_4O$ ) can only be obtained in solution. *Citrate of Iron* is prepared by dissolving freshly precipitated peroxide of iron in a warm solution of citric acid; a reddish-brown solution is formed, which, on evaporation, yields brilliant scales of a light-brown colour. Excepting the first, all these salts are employed in medicine—the citrates of potash and ammonia as diaphoretics and febrifuges (see **AERATED WATERS**), and the citrate of iron as a tonic. Lemon juice, in which citric acid is the most active ingredient, is a most valuable medicine in scurvy, active hæmorrhage, rheumatism, &c.; and when it cannot be obtained, citric acid is the best substitute. The general uses of citric acid in combination with an alkali have been already noticed.

**CIVITANOVA**, a town of Central Italy, province of Macerata, 12 miles west of the town of Macerata. Population, including the port, 8583. It stands not far from the Adriatic, and has a fine harbour, much frequented. Its lands produce vines, olives, and pasturage. It is an industrial and commercial city.

**CLAVARIA**, a genus of *Fungi* of the division *Hymenomyces*, subdivision *Clavati*. The spores are produced equally on all parts of the surface. The species are numerous, some of them simple and club-shaped, some branched. Some are natives of Britain. *C. Botrytis*, a species common in oak and beech woods in Germany, growing on the ground,

becomes old. Another German species, *C. flava*, which grows on sandy ground in fir-woods, is used in the same way. Other species appear to possess similar properties, and Liebig found them to contain the saccharine substance called Mannite. *C. Botrytis* is the *Keulenpilz*, and *C. flava* the *Ziegenbart* (goat's-beard) of the Germans.

**COACH-DOG**, or **DALMATIAN DOG**, a variety of dog apparently allied to the hounds, although it is said to be deficient both in keenness of scent and in sagacity. It is often kept in stables, becomes attached to the horses, and may be seen running after carriages. Its general light colour and numerous dark-brown or black spots are constant characteristics; as are also its short hair, tail destitute of brush, and inoffensive disposition. Its origin is uncertain; the name Dalmatian is probably altogether misleading; and it is supposed that it may have been brought from India, where a very similar kind of dog exists.

**COAL-SUPPLY**. Referring to **CARBONIFEROUS SYSTEM** and **COAL** for various details connected with the localities of coal-beds, the diversity of qualities, and the modes of working, we shall treat here of a question which has recently been accepted as one of great importance to the welfare of the nation—viz., the amount of available supply. All the coal now existing was formed untold ages ago, when the conditions of temperature and moisture on the earth's surface were different from those now prevailing. Coal is not a growth annually renewable, but an accumulation which we are gradually spending. We are living, not on the interest of our coal, but on the capital. This is a truth which scientific men have recognised for some time past; but statesmen and manufacturers, mine-owners and merchants, have paid singularly little attention to the subject, under the supposition that the existing stock will last for so great a period as to relieve us from all anxiety on the matter. John Williams in 1789, Sir John Sinclair in the *Statistical Account of Scotland*, Robert Bold in 1812, and Dr Buckland in 1830 were almost the only writers, until recently, who cautioned England that her supply of coal will not last for ever. Two volumes on the *Coal Question*, by Mr Hull and Mr Jevons respectively, have now, however, effectually roused public attention to the matter.

At the Newcastle meeting of the British Association, in 1864, Sir W. G. Armstrong, as chairman, forcibly urged the subject on the attention of scientific and practical men. He said: 'Contemplating the rate at which we are expending those seams of coal which yield the best qualities of fuel, and can be worked at the least expense, we shall find much cause for anxiety. . . . We have already drawn from our choicest mines a far larger quantity of coal than has been raised in all other parts of the world put together; and the time is not remote when we shall have to encounter the disadvantages of increased cost of working, and diminished value of produce.' He urged especially that we ought not to squander our coal as at present. We waste nearly all the smoke, heated air, and heated gases from our furnaces; we waste sadly in our open fireplaces; and there is a vast quantity of small-coal recklessly burned at the pit's mouth. Various statistics as to supply and consumption had furnished Sir W. G. Armstrong with his data. So widely have estimates differed as to available quantity still in store, that between 1792 and recent times, the conjectures, for Northumberland and



attempts made in late years to arrive at approximate figures. In 1857, M. De Carral, a Prussian mining-engineer, estimated the coal-mining of that year in all countries at 125 million tons, with an average value of 7s. per ton at the pit's mouth; he credited Prussia with enough unexhausted coal to supply all the world for 900 years. In 1861, Mr Robert Hunt ascertained, by reliable mineral statistics, that Great Britain raised 86 million tons in the year; that the quantity was increasing by nearly three million tons every year; and that we were working our mines at thrice the rate which had been in force 20 years before. These facts had much influence in drawing the attention of public men to the subject. The produce of Great Britain in 1861 was from 3052 collieries; and the different districts joined in the supply as follows: Durham and Northumberland, 19 million tons; Lancashire, 12; Yorkshire, 9; Staffordshire and Worcestershire, 7; South Wales, 7; Derbyshire and Nottinghamshire, 5; Scotland, 11; all other districts, 16—amounting to a total of 86 million tons. M. Burat, in his *Situation de l'Industrie Houillère en 1864*, estimated the coal-produce of the world at 141 million tons, of which he credited Great Britain with about four-sevenths. In the same year, Sir W. G. Armstrong, taking Mr Hull and Mr Hunt as his authorities, estimated the available stock of coal in the United Kingdom at 80,000 million tons, rejecting all seams below 4000 feet as too deep to work, and all less than two feet thick as too thin to work. Taking 1864 as a standard of consumption, it would last 930 years; but at the rate of increase of recent years, it would only last 212 years, because this rate would be geometrical and not merely arithmetical in its progression.

In the year 1866, the question came into the arena of the British parliament. On April 17, during a discussion in the House of Commons on the malt-tax, Mr J. Stuart Mill dwelt on the fact, that coal is one of our greatest sources of national wealth; and he accepted as trustworthy the calculations of Mr Jevons—that in three or four generations, we shall have scarcely any usable coal at a less depth than 4000 feet, a depth which will either be unworkable, or workable only at a greatly increased cost. This speech made a great impression on the House; and the government, a few days afterwards, undertook to ascertain what facts the officers of the Geological Survey possessed on the subject. On May 3, the Chancellor of the Exchequer, Mr Gladstone, made his financial statement for the year, in which he accepted Mr Mill's views, based as they were on the opinions of Sir Roderick Murchison, Sir John Herschel, Sir W. G. Armstrong, Dr Percy, Mr Hull, Mr Jevons, and other authorities. He assented to the probability that by the year 1970, if matters go on at their present rate, we shall have no coal left. 'I disbelieve and disapprove,' he added, 'of all attempts to limit by law the consumption of coal. In vain would it be to think of stopping the consumption of coal in this country; in vain would it be to think of diminishing that consumption by the imposition of a tax; and it would be more vain still to think of prohibiting its exportation.' In other words, the remedy, if any, can not be by legislation. The question was brought to a decisive point on June 12, when Mr Hussey Vivian moved an address to the crown, praying for the appointment of a royal commission to investigate the whole matter. In an elaborate speech, he stated his reasons for believing that the forebodings of Mr Hull and Mr Jevons are too

practicable; that we shall be better able than ever to ventilate and drain the deep workings; that the area of coal workable even with our present means is larger than has been estimated; that the magnesian limestone and new red sandstone beds are likely to afford an opening for new stores of coal quite incalculable in amount; that the theory of an increase of consumption in a geometrical ratio is not tenable; and that we shall probably economise consumption in future years by the adoption of new processes, new furnaces, new stove-grates, smoke-consuming apparatus, and the utilisation of waste heat and gases. Although entertaining these favourable views, he nevertheless suggested official inquiry. The government assented; and a Royal Commission, comprising the Duke of Argyll, Sir Roderick Murchison, Sir W. G. Armstrong, Mr Vivian, Mr Prestwich, Dr Percy, Mr Jukes, Mr Robert Hunt, and several other experienced men, was appointed in July 1866.

The Coal Commissioners gradually collected a large body of information concerning the quantity of coal raised annually in the United Kingdom; the probable future rate of increase; the quantity still remaining at available depths underground; and the best means of economising coal in future. They obtained a great mass of evidence, which was published in 1871, with maps, plans, and diagrams. They reported that the deepest of our mines are about 2000 feet, but that 4000 feet might possibly be worked with improved lifting and ventilating appliances. They estimated the coal of the United Kingdom, at all depths down to 4000 feet, at 90,207 million tons—viz., 46,000 millions in England; 34,000 millions in Wales; 10,000 millions in Scotland, and a mere trifle in Ireland. The largest single coal-field they found to be that of South Wales, 32,000 million tons. Many geologists believe that coal underlies the New Red Sandstone and Permian formations, and that an additional quantity of 56,000 million tons might possibly be obtainable from this source. Supposing the available total to be 146,000 million tons, the Commissioners endeavoured to estimate how long it would last. The quantity raised in 1869 was 107,000,000 tons, of which 97,000,000 were retained for home consumption. Taking into account all the circumstances which had to be considered, the Commissioners expressed an opinion that our coal-supply will be exhausted in 300 years.

Since 1871, the subject has been much discussed. The balance of opinion tends towards a greater duration than 300 years; but all is vague guessing on this point. The coal-harvest of Great Britain in 1872 was 123,000,000 tons; in 1873, 127,000,000 tons; and in 1874, 125,000,000 tons.

Consequent on the revelations concerning our (future) coal-famine, other nations are making renewed investigations respecting their own reserve deposits.

COATBRIDGE, a rising and prosperous town of Scotland, in the parish of Old Monkland, about eight miles directly east of Glasgow, on the Monkland Canal and Caledonian Railway. The town is straggling, has some good houses, and a number of small villages or suburbs on its outskirts. There are six churches besides the parish church, two academies, and several other schools, banks, &c. The town is in the centre of a mineral district, is surrounded by about fifty smelting-furnaces, and contains eight malleable iron works, one tin-work (the only one in Scotland), and several other works connected with the iron manufacture. C, owing

COBAN, a town of Central America, Guatemala, in the dep. of Vera Paz, in a fertile valley on the Rio Dolce, 55 miles north of the town of Guatemala. The inhabitants are nearly all Indians, are generally industrious and some of them wealthy, and possess plantations of sugar-cane, bananas, pimentos, and various kinds of fruit-trees. Pop. estimated at 14,000.

**COCOMYLIA**, or **COCUMIGLIA** (*Prunus coccomilia*), a species of plum, a native of Calabria, and of which the bark—particularly of the root—is much used in that country for the cure of intermittent fevers. Its valuable qualities have been strongly attested by Neapolitan physicians, and it is employed both in private practice and in military hospitals, but it has not come into use in other countries. The C. has obovate leaves, short double flower-stalks, and austere tawny-yellow fruit.

**COCUM OIL**, a solid oil or vegetable butter, obtained from the seeds of *Garcinia purpurea*, an Indian tree of the same genus with the mangosteen. It is white or pale greenish yellow, brittle or friable, with a faint and not unpleasant odour. It melts at 95° F., but when cooled after being melted, remains liquid to 75° F. It is used for mixing with ghee (butter), and is exported to Britain for mixing with bear's grease in the manufacture of pomatum.

**COHESION-FIGURES**, a remarkable class of figures produced in liquids by the action of their natural cohesive attraction for the surfaces of other liquids or solids on which they are deposited, or by induced cohesive attraction effected by the means of electricity. They may be described under four heads: (1) The Surface-cohesion Figures of Tomlinson; (2) The Submersion-figures of Tomlinson; (3) The Breath-cohesion Figures of Strethill Wright; (4) The Electric-cohesion Figures of Strethill Wright.

1. *The Surface-cohesion Figures of Tomlinson.*—This class of figures was submitted to the Chemical Section of the British Association by Mr Charles Tomlinson of King's College, London, in 1861. He shewed that a drop of an 'independent liquid,' such as an oil, alcohol, or ether, when gently placed upon chemically clean water, spreads itself out into a definite figure as it enters into solution or diffuses itself over the surface. He stated that each figure is characteristic of the fluid employed, and that any change in the chemical or molecular state of the fluid is attended with a corresponding change in its 'cohesion-figure.' Hence he recommended that these figures should be applied to the qualitative analysis of various liquids whose ordinary methods of testing were inoperative or inadequate. *Cohesion analysis*, performed as he directs, has been applied with signal success in the verification of oils and balsams, and as a ready means of indicating the changes which take place in those bodies by age or oxidation. The cohesion-figures of Tomlinson, from their great beauty and variety, combined with the exquisite harmony of colouring displayed by many of them, have been employed, like those of the kaleidoscope of Brewster, to suggest forms for the pattern-designer.

In the production of cohesion-figures, water was the receiving surface generally employed by their discoverer; but in certain cases, he also employed other fluids, such as mercury, acetic acid, coconut oil, and castor oil in the cold state; and spermaceti, white wax, lard, and sulphur in a

benzene figure, and hence additional means of comparison and verification were afforded. Fig. 1

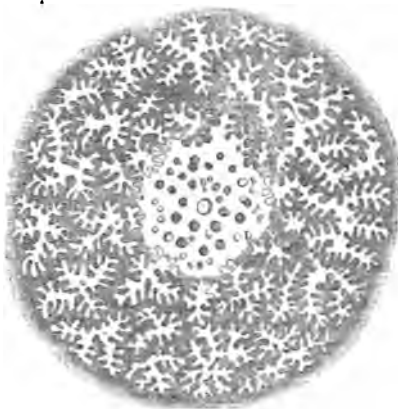

Fig. 1.

shows the surface-cohesion figure of oil of lavender on water.

2. *The Submersion-figures of Tomlinson.*—In the *Philosophical Magazine* for June 1864, this author brought forward a new series of cohesion-figures of liquids, in which the drop, being of great specific gravity, instead of forming a figure on the surface, sank beneath it, and formed a figure as it slowly made its way to the bottom of the vessel. In order to exhibit these phenomena, he employed a column of liquid in a cylindrical vessel. He states that a solution of cochineal dropped into water formed a figure typical of a large class of these figures. A drop laid on the surface sank down, opened into a ring, which became depressed at two opposite points; from these points, lines of fluid descended, which terminated in secondary rings; the secondary rings, in like manner, drooped down into lines carrying tertiary rings, and so on, until the lower part of the vessel became crowded with a complicated system of drooping rings and lines. Oil of lavender in a column of alcohol, fusel oil in paraffin

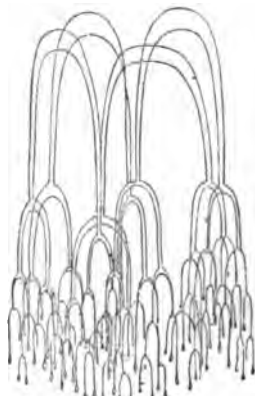

Fig. 2.

oil, in benzole, in ether, &c., gave various and distinctive figures. He found that similar figures were obtained by the use of oils dropped into columns

the submersion-figure of oil of lavender in alcohol; fig. 3, that of fusel oil in paraffin oil. We have already stated that each of these figures, whether surface-figures or submersion-figures, is characteristic of the fluid which forms it; and Tomlinson considers, with regard to the *surface-figure*, that it is a function of the cohesive force and diffusibility of the liquid, and the adhesion of the surface on which it is deposited: he also considered that it might be a function of the solubility and the diffusibility of the fluid in question, or of the solubility, the density, and the molecular attraction; while with regard to the *submersion-figure*, he thought each figure to be a function of the solubility, the density, and the molecular attraction.



Fig. 3.

**3. The Breath-cohesion Figures of Strehill Wright.**—These figures were discovered by Dr Strehill Wright of Edinburgh, and communicated to the Royal Scottish Society of Arts on December 12, 1864. This author, who had long been engaged in observing phenomena connected with the modification of cohesive attraction produced between solids and fluids by heat and electricity, was induced to take up the subject afresh by the publications of Tomlinson, and one of the results was the production of his so-called 'breath-cohesion figurae.' He

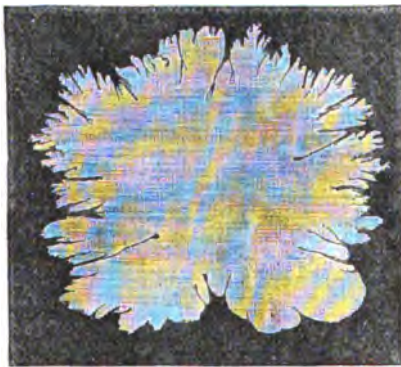

Fig. 4.

employed as the recipient surface a freshly-split, and therefore chemically clean, surface of mica; on this he placed a single drop of the fluid to be experimented on. He then breathed upon the surface, and instantly the drop flashed out into a figure characteristic of the fluid of which it was composed.

mucus, and urine in his various pathological conditions, could be examined. By dusting the figures with hair-powder or lycopodium, he was also enabled to render them permanent, and to exhibit them in his lectures, expanded to a diameter of fourteen feet by the oxyhydrogen microscope. Fig. 4 shews the cohesion-figure of vaccine lymph; fig.

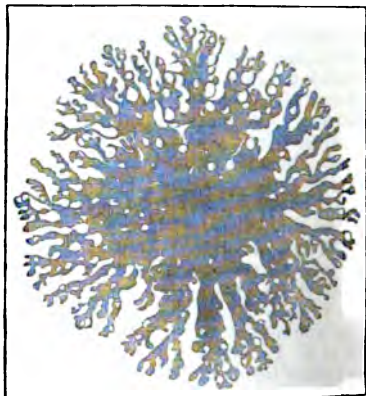

Fig. 5.

5, that of urine containing a small proportion of bile; fig. 6, oil of bitter almonds. In general appearance, the breath-cohesion figures bear a strong resemblance to vegetable forms, especially to the fronds of the *Desmidiæ*. In many of them, as in



Fig. 6.

the *Desmidiæ*, a very distinct bilateral symmetry is apparent. Others, again, simulate the forms of the larger *Alga*. A great many are resplendent with the hues of the soap-bubble, arranged in concentric bands and curves of excessive beauty; while others are veined throughout so as to resemble sections of agate. Dr Wright considers that the breath-cohesion figure is the product of electric attractive force developed on the freshly-split mica, as a well-known consequence of cleavage.

**4. The Electric-cohesion Figures of Strehill Wright.**—These figures were described by Dr Wright to the Royal Scottish Society of Arts on April 11, 1864, and are produced by electrifying drops of various

this method, an endless variety of beautiful dendritic figures are produced, differing not only with the fluid employed, but also with the slightest change in the character of the surface on which it is placed, and with the electricity, whether positive or negative, which is imparted to the drop. The electric-cohesion figures are produced in the following manner: A sheet of plate-glass is laid upon a plate of blackened metal, and in the centre of the glass a drop of the fluid to be operated on is deposited with a clean glass rod. The metal plate and the drop are then connected with the opposite poles of an induction coil (capable of giving a spark of about half an inch in length) in full action, and immediately branches protrude from the drop, which slowly creep over the glass until they closely cover a circle of four or five inches. The accompanying figure (fig. 7) shows that produced on a surface of mica by the positive pole

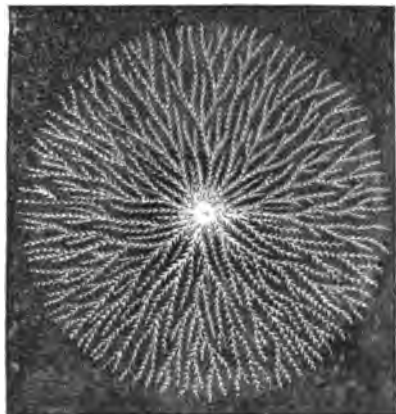

Fig. 7.

from a solution of cyanide of potassium. Sulphuric acid, and solutions of potash, deliquescent salts, and organic fluids, give the best figures; while nitric and muriatic acids and distilled water do not form figures under the electric influence.

**COMAYAGUA** (formerly **VALLADOLID LA NUEVA**), chief city of Honduras, Central America, 190 miles east of Guatemala, in a fine but unhealthy valley, 1800 feet above the sea, on the right bank of the Humuva, which flows into the Pacific. The city was founded in 1540, is the see of a bishop, has a cathedral, college, ecclesiastical seminary, several convents, and a rich hospital. Pop. 8000; it was 18,000 previous to 1827, when the city was burned by the monarchical faction of Guatemala, and has never since wholly recovered.

**COMMEMORATION**, or **ENCÆNIA**, the great festival of the Oxford academic year, usually takes place on the third Wednesday after Trinity Sunday. It is of very ancient date, public exercises and recitations having been held from time immemorial in honour of the act, or period when Masters of Arts and Doctors complete their degrees, at first in St Mary's Church, but subsequently to the erection of the Sheldonian Theatre (1669), in that building.

At present, the proceedings consist of a Latin oration in honour of founders and benefactors, delivered in alternate years (according to the bequest of Lord Crewe, Bishop of Durham) by the Public Orator and the Professor of Poetry; the

introduced to the Chancellor, or, in his absence, to the Vice-chancellor, by the Public Orator, in a short Latin speech; and the recitation of the Newdigate or English prize poem, the Latin prize poem, and the Latin and English prize essays, the three last named prizes being the gift of the Chancellor. During the ceremonial, the northern extremity of the theatre is occupied by the Vice-chancellor, doctors, proctors, &c.; the area or pit by Masters of Arts and their friends; the lower seats in the semicircle by lady visitors; and the upper, or gallery, by Bachelors and Undergraduates, who claim on this occasion all the time-honoured privileges of a gallery audience. Commemoration Day itself is only the culminating point of a week of gaiety, in which concerts, balls, theatrical representations, &c. replace the usual studies of the university, and in which heads of houses and tutors are only tolerated in so far as they give a sort of official sanction to the general festivity. In the theatre itself, the more strictly academic and solemn portion of the proceedings receives but scanty respect from the majority of the audience. A momentary pause may perhaps be made when the 'Newdigate' is being recited, or when some 'lion' of unusual mark advances to receive his degree; but as a rule, the noisy humours of the gallery command much more attention than the stately periods of the Public Orator, or the timid recitations of the prize essays. Of late, however, a feeling has sprung up among the senior members of the university (shared in, it is said, by several distinguished strangers) that the licence of the gallery has exceeded all due limits; and in 1876 a change was made in the interior arrangements, the undergraduates not occupying a separate gallery, but being distributed among the ladies.

The Vice-chancellor, who holds his office for four years, generally presides at Commemoration, but it is usual for the Chancellor to do so once in the period of each vice-chancellorship. These occasions are called Grand Commemorations.

**COMMENTRY**, a town of France, in the dep. of Allier, eight miles south-east of Montluçon, on the Oeul. It stands in the centre of one of the most important coal-fields of France, and within the last thirty years has risen from a mere village to be a busy and populous town. Pop. (1872) 9058, mostly engaged in the coal-mines and iron-works. A railway connects it with Montluçon and other places, and with the Canal de Berry. In 1846, an immense fire consumed an enormous quantity of the coal in the mines.

**COMPRESSED-AIR ENGINE**. One mode of employing air as a motive-power is described in **CALORIC ENGINE** (q. v.). Another obvious way is to compress it, and then apply it in the manner of high-pressure steam. Although compressed air has been used for working small engines in confined situations, such as Tunnels (q. v.), it is not at all likely that it will ever come into extensive use, owing to the great waste of power attending it. This waste arises from two causes—first, the friction due to forcing the compressed air along a great length of pipe; and secondly, the loss from the dissipation of the great heat which results from its compression. If, say, 100 cubic feet of air is compressed into 1 cubic foot, it will become very hot, and although it is very easy to keep in the air, it is impossible to keep in the heat. In spite of every precaution, the heat will find its way through the vessel in which the air is confined, and through the pipes in which it is being transmitted, and this is equivalent to a portion of the air itself leaking out,

original compression of the air, the higher its temperature will rise; and as this caloric, which cannot be kept from escaping, is practically a part of the bulk of the air, it follows that the loss of power from this cause will increase with the pressure or tension of the air. Even were it possible to prevent the escape of the heat, by covering the vessels and pipes with some non-conducting substance, it would not be practicable to use the hot air in the same way as steam is used, because the lubricating material necessary to keep the piston and slide-valves from 'tearing' would be decomposed by the high temperature. In steam-engines, there is always a small quantity of water in the cylinders and slide-valves, arising from the condensation of a portion of the steam, and this suffices to lubricate the piston and valves. It is well known that when steam is *superheated* so highly as to prevent a slight condensation in the cylinder and slide-valves, they are very rapidly destroyed. Air rises in temperature when very much compressed, and we cannot use it until its temperature falls; and as this involves a great waste of power, it follows that where economy is of any consequence, air cannot be used as a mode of transmitting mechanical power. Indeed, no fluid can be economically used for transmitting power for any great distance. We have just seen that compressed air is very unsuitable; steam is even more wasteful, because it condenses into water in long pipes. Water itself loses much of its force from friction in passing through long pipes, unless they are of very large size; and in applying it to working Hydraulic Cranes (q. v.), where the weight to be raised varies, great waste of power arises from the fact, that the cylinder, in which the ram works, has to be filled every time the crane is worked with water at the full pressure of 600 or 700 lbs. to the square inch, even when a pressure one-tenth of that amount would suffice to raise the weight. In short, the power actually used in working a hydraulic crane is always the maximum, even when the weight to be raised is a minimum. It uses as much power to lift a hundred-weight as it does to lift a ton. The extreme handiness and other practical advantages possessed by the hydraulic cranes leave a large balance in their favour, notwithstanding their waste of power.

In boring the Mont Cenis Tunnel (see TUNNEL), air was compressed at the mouth of the tunnel by the abundant water-power easily obtainable there, and forced along to the working face through small iron pipes, for working the boring-machines. General Haupt, an able American engineer, who has been engaged in some extensive tunnelling operations in the United States, has proposed a plan for using ordinary steam boilers and engines close to the working face in the tunnel, and drawing out the smoke and vitiated air through a wooden trunk, by means of a large fan at the mouth of the tunnel. This scheme offers the very great advantage of having to deal only with air and smoke under pressure differing but little from that of the atmosphere. A wooden trunk of no great strength, and involving little difficulty in keeping it sufficiently air-tight, would take the place of strong cast-iron pipes, which require to be perfectly air-tight, and are necessarily, from their considerable cost, of such a small size as to involve great loss of power in forcing high-pressure air through them.

CO'NCORD, the capital of New Hampshire, U.S.—called RUMFORD before the American Revolution, from which Count Rumford took his title—is on

along the river, with state-house, state-prison, state lunatic asylum, city hall, two railway depôts, nine churches, four or five newspapers, and manufactures of carriages, iron, steel, machinery, musical instruments, woollens, leather, &c. Pop. (1870) 12,241.

CONDOM, a town of France, in the dep. of Gers, pleasantly situated on a height on the river Baise, here crossed by two bridges, 25 miles north-west of Auch. The town is very old, having been founded in 721, is irregularly built, but has handsome suburbs. It has a handsome Gothic church, an exchange, and two hospitals. There is a very considerable trade in grain, flour, wine, and brandy, and manufactures of cotton and mixed fabrics, cotton yarn, and earthenware. C. was formerly the capital of an extensive district, now comprised in the departments of Gers, Landes, and Lot-et-Garonne. Bossuet was at one time Bishop of Condom. Pop. (1872) 5033.

CONGESTION may be defined to be 'excess of blood in the vessels of a part, with diminished motion of that blood.' The chief causes of congestion may be classed under the two heads of (1) congestion from venous obstruction, and (2) congestion from want of tone in the vessels.

1. *Congestion from venous obstruction* is easily illustrated by tying up the arm, as is done before opening a vein, when the veins are compressed more than the arteries. If the ligature is kept on for a sufficient time, the veins swell, the fingers become red, and then livid, and the whole limb is swollen. Cold applied to the surface of the body acts similarly on it, and contracts the veins more rapidly than the arteries, which lie deeper; and the purple colour of the hands and face after exposure to cold shews the congested state of the capillaries. 'Congestions,' says Dr C. J. B. Williams, 'are caused in external organs by an obstruction of the veins leading from them. Thus, congestion of the brain may be produced by a tight cravat or by a tumour pressing on the jugular veins. Efforts of straining, coughing, holding the breath, and asthmatic paroxysms which impede the flow of blood through the lungs, cause congestion in various parts. Tubercles in the lungs cause congestion of that organ. Obstruction to the transit of blood through the liver causes congestion in the abdomen, hæmorrhoids, &c.'—*Principles of Medicine*, 2d ed., p. 180.

2. *Congestion from want of tone in the vessels* includes a numerous class of cases. In stony of the vessels generally, as in extreme debility, certain fevers, &c., there is general congestion of the parenchymatous organs—the lungs, liver, &c.—and the blood gravitates to the lowest parts, giving rise to what is termed *hypostatic* congestion of the posterior parts of the lungs, the skin of the back, &c. In other cases, the weakness is local, as when the feet swell after long standing, in consequence of over-distension of the veins. Similarly, a continued stooping posture may occasion headache, giddiness, and the other symptoms of congestion of the brain. Congestive affections of this kind are often mistaken for inflammation, and instead of being treated by inflammation, are treated by depletion, which, although affording temporary relief, increases the evil.

Another cause of congestion is over-excitement of the vessels, and this often occurs at an early stage of inflammation, or as a result of that process.

We must pass over the symptoms and effects of congestion, because they vary very much according to the organ affected, and shall conclude with a few words on the general remedies for congestion. First

tumour compressing veins, elevation of the head in affected brain, and the recumbent position in congestion of the hæmorrhoidal or uterine vessels. Pressure, by supporting the weak vessels, and friction, by increasing the onward movement of the blood in the veins, are often of great use. Astringents, such as solutions of alum, sulphate of zinc, tannin, oak-bark, &c., may be applied with advantage locally to certain parts, as the eye, throat, rectum, &c.; and stimulants may be similarly used, as a capsaicum gargle to a relaxed sore throat. Medicines of these classes may also be given internally. Thus, the principal action of bark, quinine, and arsenic in the cure of ague is supposed to lie in their reducing the great visceral congestion that is always present. A glass of strong hot brandy and water will often remove a congestive headache, and a stimulant draught will often relieve the pulmonary congestion which follows a fit of asthma. Various remedies are supposed to have a special power of removing the congestion of certain organs: thus, mercurials are recommended for congestion of the liver; digitalis and cantharides for congestion of the kidneys; and squills, benzoïn, and the balsams for bronchial congestion.—For further details, the reader is referred to the excellent work of Dr Williams, from which we have quoted.

CONGOO'N, or KONGUN, a town of Persia, on the Persian Gulf, 130 miles south of Shiraz. It has an excellent and safe roadstead; and both wood and water, which are generally scarce in the gulf, may be obtained here. Pop. 6000.

CONSANGUINITY (Lat. *con*, together, and *sanguis*, blood), the relationship which subsists between persons who are of the same blood. It is either *direct*—which is the relationship between ascendants and descendants—or *collateral*, between persons sprung from a common ancestor. In the direct line, a son is said to stand in the first degree to his father; a grandson, in the second degree to his grandfather; and so on. In the collateral or oblique line, two different modes of numbering the degrees of consanguinity have been in use, the one that of the civil, the other of the canon law. By the civil law, the degrees are separately numbered downwards to each party from the common ancestor, the common ancestor not being counted. Thus, brothers are in the second degree of consanguinity; uncle and nephew in the third; cousins-german in the fourth; and second cousins, or the children of cousins-german, in the sixth degree. By the canon law, consanguinity in the equal oblique line, i. e., where the parties are equally removed from the common ancestor, is computed by the number of degrees between one of them only and the common ancestor; brothers being said to stand in the first, and cousins-german in the second, degree to each other. In the unequal oblique line, i. e., which the parties stand in different degrees of relationship to the common ancestor, the degree is determined by the number of steps between the common ancestor and the party further removed from him: thus, uncle and nephew are computed as in the second degree to each other, because the nephew, the further removed of the two, stands in the second degree to the common ancestor, his grandfather. The canon law computation is more generally used by English lawyers, though statute 22 and 23 Car. I. c. 10 adopts that of the civil law. Scotch lawyers, since the Reformation, have generally used the civil law mode of computation.

*Affinity* is the relationship brought about by

tions of her husband. The relations of one spouse in any particular degree of consanguinity stand in the same degree of affinity to the other spouse. There is no relationship by affinity between the blood-relations of the husband and those of the wife.

Consanguinity and affinity have been at different times and in different parts of the world more or less looked on as impediments to marriage between the parties related. Among the ancient Persians and Egyptians, marriages are said to have been sometimes sanctioned between brother and sister, and even father and daughter. The Athenians, while permitting marriages between brothers and sisters uterine, prohibited them between the same relations by the father's side or the full blood. In the book of Genesis, we read of Abraham marrying his half-sister. The Levitical law prohibited marriage between relations in the direct line, between brother and sister, nephew and aunt, and apparently by implication, uncle and niece. A son was prohibited from marrying his father's wife.

The Roman law prohibited marriage between ascendants and descendants, a prohibition extended to relations by adoption, and even after the dissolution of that tie. In the collateral line, the prohibited degrees included brother and sister (extending to persons so related by adoption where the tie continued to exist), and all cases where one party stood *in loco parentis* to the other, as uncle and niece. Marriage between cousins-german, at one time prohibited, was declared lawful by Arcadius and Honorius. The degrees prohibited in consanguinity were by Constantine also prohibited in affinity.

By the old canon law and early decretals, marriages were prohibited between persons as far removed as the seventh degree of consanguinity or affinity—i. e., between persons who might, by the civil law computation, be within the twelfth degree to one another. The fourth council of Lateran, 1215 A. D., narrowed the prohibition from the seventh to the fourth degree; i. e., the grandchildren of cousins-german. Affinity was held to be constituted not merely by marriage, but by the spiritual relationship of standing sponsor at baptism, and by illicit intercourse; marriage being prohibited between persons one of whom had had carnal connection with a relation in the fourth degree of the other. A marriage between persons related in any of these ways was accounted incestuous, and the children bastards. The pope assumed the right of granting dispensations from impediments to marriage arising from consanguinity and affinity, a power which seems to have been first exercised in the 12th century. In no instances have dispensations been granted to relations in the direct line, but one or two dispensations are said to have been granted between brother and sister; and between uncle and niece, they are still occasionally granted in countries where the canon law continues to be binding. Between remoter relations, they have been common. The extent to which these prohibitions were carried, and the possibility of their being dispensed with, naturally tended to encourage profligacy and lax ideas of the marriage tie, it being hardly possible to say of any marriage that it might not one day be proved invalid. The Council of Trent restricted the impediment of affinity from illicit intercourse to the second degree.

In the countries which embraced the Reformation, a general relaxation took place in the prohibitions to marriage from consanguinity and affinity. In England, 32 Hen. VIII. c. 38 allowed all persons

in the direct line, brother and sister, and collaterals, when one party is brother or sister to the direct ascendant or descendant of the other; the degrees prohibited in consanguinity being equally prohibited in affinity. The prohibitions from consanguinity have been held to extend to bastard relations. But down to 1835, marriages within the prohibited degrees were valid and the issue legitimate, unless the marriage had been annulled by a declaratory sentence of the Ecclesiastical Court, which could only be obtained while both spouses were alive. By act 5 and 6 Will. IV. c. 54, all marriages within the prohibited degrees of consanguinity and affinity were made absolutely void.

In Scotland, for a very short time after the Reformation, the papal power of dispensation was exercised by the crown. Acts 1567, c. 14, and 1567, c. 15, professing to take the Levitical law as the standard, assimilated the prohibitions from consanguinity and affinity to those of England. Incest, or sexual intercourse with persons within the prohibited degrees, was, by the former statute, made a capital crime. As to marriages between bastard relations, the law of Scotland is in a doubtful state; but there is no prohibition against marriage with a relation however near of a person with whom one has had sexual intercourse.

In France, the Code Napoléon prohibits marriage between ascendants and descendants lawful or natural, and persons similarly connected by affinity; and in the collateral line between brothers and sisters lawful or natural, and persons similarly connected by affinity. Marriage between uncle and niece, and aunt and nephew, is also prohibited. In Spain and Portugal, the canon-law restrictions are in full force, with the corresponding system of permissive dispensations. In various countries of Europe, as Denmark, no prohibitions from affinity, except in the direct line, are recognised. In most of the United States of America, marriage is allowed between uncle and niece.

**CONTAGIOUS DISEASES (WOMEN) ACTS** were passed in 1865, 1867, and 1868 for the seaport and military towns, Aldershot, Canterbury, Chatham, Colchester, Dover, Gravesend, Maidstone, Plymouth and Devonport, Portsmouth, Sheerness, Shorncliffe, Southampton, Winchester, Windsor, and Woolwich; and in Ireland, the Curragh, Cork, and Queenstown. The policy of these Acts has since been keenly canvassed, one party denouncing them as demoralising and degrading, the other party defending them on purely sanitary grounds. They authorise a justice of the peace, on the sworn information of a superintendent of police that a woman within the above area is a common prostitute suffering from venereal disease, to cause her to be examined, and if necessary detained in an hospital. She is, however, first entitled to notice, so that she may submit voluntarily to examination. The limit of detention in hospital is three months to nine months. She may be convicted for refusing to attend for examination, and imprisoned for one month; and for a second offence, three months. If she considers herself cured, she can demand to be taken before a justice, who, on reasonable evidence, can discharge her. Occupiers of houses are liable to a penalty for permitting a woman uncured to resort to or be in their houses. The justice hears the case in private; but if the woman demands it, he must hear her in open court.

**CONVALESCENT HOSPITALS**, although as yet rare in this country, are institutions of the

very considerable number of patients must almost of necessity die soon after returning to their own unhealthy homes, simply for want of an institution where convalescence may be developed into perfect health, under the general influences of pure air, gentle exercise, and a nourishing and well-regulated diet. The convalescent hospital must be regarded as a stage in the process of cure intermediate between the ordinary hospital and the patient's home: it is an equally necessary addition both to civil and military hospitals. One of the greatest of our military surgeons, Robert Jackson, writing in 1803, recommends 'separate and detached houses, and the removal of convalescents 'to other apartments or hospitals.' He states his firm conviction, as based on long and most extensive experience, that soldiers, in a state of convalescence, recover their health better and sooner in sheds, huts, and barns, exposed occasionally to wind and rain, than in the most superb hospitals in Europe. 'Pure air,' he adds, 'in this respect, is alone superior to all forms of cure, and to all other remedies without such aid.' The same great authority frequently notices relapse as being the leading cause of mortality in general hospitals.

The magnificent establishment at Vincennes, founded in 1857 by the late Emperor of the French, may be taken as a type of what convalescent hospitals ought to be. We borrow the details from Sir James R. Martin's article on 'Convalescent Hospitals' in Holmes's *System of Surgery*. It is composed of a main building, with two long wings, two stories high, with a ground floor, and contains more than 400 beds. It contains a chapel, airy dining-halls with marble tables and convenient seats, a library, and play-rooms; the wings in both stories being subdivided into rooms, each containing three beds, and looking towards the south. Each patient has the use of a press, with lock and key. There is ample garden-ground attached to the building. The mean duration of residence is 22 days, the patient remaining till he is either completely cured, or declared incurable. The diet is regulated by the director and head physician, and usually consists of soup at 7.30 A.M.; meat and vegetables at 10.30 A.M.; soup, roast meat, vegetables, and salad or dessert at 5 P.M.; each convalescent receiving a pint of Burgundy, and as much bread as he may choose. Numerous means of diversion, as skittles, balls, draughts, dominoes, &c., are afforded, but cards are prohibited; and the library, the greater part of which has been presented by Paris booksellers, is much resorted to, there being on an average fifty readers. The conduct of the inmates is exemplary. They are allowed to see their friends thrice a week. The officers are: a director, treasurer, head physician, and three house-surgeons; six nurses, a chaplain, five clerks, a store-keeper, four overseers, and forty subalterns. The simple fact, that this hospital, in less than three years, administered relief to 14,000 convalescent artisans, affords undoubted evidence, were such evidence required, of the utility of such institutions. Several establishments of the kind are already in operation in England. One, for 50 to 60 patients, was erected in 1867 near Edinburgh; and a large one has recently been built at Lenzie junction, near Glasgow.

**CO'PRA**, the dried kernel of the cocoa-nut, from which cocoa-nut oil has been expressed. It is much used in India as an ingredient of curries.

**CO'PTIS**. Very similar to the *C. trifoliata*, noticed in the article *COPTIS*, is *C. teeta*, the *Golden Thread* of Assam, the root of which has long been in high repute in Assam and neighbouring countries. It

curacy is ascribed to it as a tonic for patients beginning to recover; but it is of no value as a febrifuge.

**COQUITO** (*Jubaea spectabilis*), a beautiful Chilean palm, of the same tribe with the cocoa-nut, rising with a naked stem to the height of 40 or 50 feet, and bearing a crown of wide-spreading pinnated leaves. By cutting off the crown, the sap is obtained in great quantity, continuing to flow for months; and when boiled down to the consistence of treacle, becomes a very sweet syrup, and forms, under the name of Palm-honey (*miel de palma*), an article of great importance in the domestic economy of the Chileans.

**CORA'TO**, a large town in Southern Italy, province of Bari, 25 miles west of Bari, is situated on a fertile plain, where much cattle is reared. Pop. (1872) 26,220. It is an ugly, dirty town, although it boasts of having been founded by the Normans. It has a fine church, fine convents, and an orphan asylum. It was between C. and Andria that the famous 'Challenge or Tournament of Barletta' took place between 13 Italians and 13 Frenchmen on February 13, 1503, in which the Italians were victors.

**CORNWALLIS, CAROLINE FRANCES**, was born on the 12th July 1796, and was the younger daughter of the Rev. William Cornwallis, rector of Wittersham and Elam in Kent. Her childhood was precocious; but she escaped the usual fate of precocious children. She lived to a good old age; she was even more remarkable as a woman than as a child; and her mind was growing, if not in vigour, in boldness and freeness, even to the last. Her character, as well as her intellectual powers, appear to have been early developed; and from expressions in her mother's Diary, we learn that her premature sensibility at the age of seven caused her relatives no little concern. When she was a little older, she began to produce literary works; and the writing of histories, poems, commentaries, and essays, though not pursued to the exclusion of the ordinary interests of her age, appears to have occupied much of her time, and to have been her chief delight for several years. Some specimens of her juvenile compositions have been included in a volume of her *Letters and Remains*, published in 1864. In character, and in respect of the tastes and abilities which they display, they certainly are very remarkable as the productions of a child. Notwithstanding this early promise, Miss C. was not destined to be an early authoress. She was brought up in the decorous life of an English country parsonage; she was sensible of, and at first, perhaps, was not unaffected by, the prejudice against female authorship which prevailed thirty or forty years ago. It was not till she was getting old that she began to publish books, and even then she was careful to keep her authorship a secret.

She received the school education usually given to young ladies in her time; a worthless education, as she afterwards thought. She was encouraged by her mother and other friends in supplementing it by severer and more useful studies; but the ill-health of her father, which imposed many duties upon her, and the state of her own health, were considerable obstacles to her progress. Gradually, however, she acquired a thorough knowledge of Latin and Greek, and a considerable knowledge of Hebrew; and made herself conversant with nearly every study which occupies the more thoughtful of men—with philosophy, theology, history, natural science, social science, politics, and even law. In her latter days, her knowledge of most of these subjects was only

on a correspondence with many persons whose intimacy was calculated to stimulate and aid her; and a selection from her *Letters* has been published. They are often intrinsically valuable and interesting; and, moreover, they present a curious picture of the progress of her mind and the development of her opinions. In style, they are always excellent, and the subjects treated are very various, and seldom ephemeral. Theology, philosophy, history, politics, and social questions afford the themes she most often discussed with her correspondents. To these *Letters* we are indebted for what little has been made known to us of her life; Miss C. having desired that her Life should not be written, and having carefully destroyed the papers which might have supplied the materials of a memoir. As regards religion—the great interest of her life—we learn from these *Letters* how, under the influence of enlarged knowledge and reflection, she gradually drifted away from the narrow orthodoxy in which she had been brought up, and adopted views which some would call more enlarged and rational, others latitudinarian. It is to the study of the Greek Fathers, and to the influence of a long residence in Italy, which began in 1826, that she ascribed the complete change which took place in her religious opinions. It is right to say, that while she was bold and fearless in accepting beliefs far removed from those of her age and country, her faith in Christianity became stronger instead of weaker, and that she was always careful not to wound the honest opinions or prejudices of others. Among the most esteemed of her correspondents was Sismondi, who is said to have made her an offer of marriage when she was about 20 years old. The offer was declined, but without causing any abatement of friendship or admiration on either side.

Her first work, *Philosophical Theories and Philosophical Experience, by a Pariah*, appeared in 1842. It was the first of a series entitled 'Small Books on Great Subjects,' which she had formed the idea of writing with the help of a few friends. Of the 20 volumes of this series which appeared between 1842 and 1864, nearly all—the most important—were written by Miss Cornwallis. The subjects discussed were very various—the Connection of Physiology and Intellectual Science, Ragged Schools, Grammar, Criminal Law, Chemistry and Geology, Greek Philosophy, and the History and Influence of Christian Opinions. The works in which the last-mentioned subject was treated—*The State of Man before the Coming of Christ* (1 vol.), and *The State of Man after the Coming of Christ* (3 vols.)—were the most important of the series. She had designed to add to them one more volume—a Survey of the Present Condition of England, Social, Political, and Religious; but this was never completed. The series attracted much attention in this country, and still more in America; and the books in which Christianity and its influence were considered were so judiciously written, that, though presenting a system of thought and belief entirely different from our orthodox Christian teaching, they were favourably received by many of every religious party. These are still the best short and popular account we have of subjects of great interest and importance, of which the majority of the clergy even were profoundly ignorant twenty years ago. In illustration of the ignorance which prevailed amongst Anglican clergy at a time still recent, Miss C. used to say that she once met a clergyman who had never heard of the Fathers; and that among a multitude to whom she applied for information about their writings, not one knew anything about them. Besides



picture of Athenian life; and in 1853, she published a prize essay on Juvenile Delinquency.

From an early period of her life, her health had been infirm; in her later years, it was very precarious, and she was for the most part confined to bed. She lived latterly at Ildwells, near Tunbridge Wells. She died there on January 8, 1858. A voluminous author, her name was at her death unknown to the world, and it remained unknown until the publication of her *Letters and Remains* in 1864. She had two reasons for making a secret of her authorship. First, there was a strong prejudice against female authorship in her young days, and even when she began to write; and she feared not the ridicule or scorn, but the neglect which might await her books were it known that they were written by a woman. She wrote in the hope of doing some good, and she concealed her name, that her purpose might not be frustrated. Secondly, she wished to shew the world what the female intellect was capable of, and the concealment of her name made her secure of impartial criticism. She believed firmly that the intellects of women were not inferior to the intellects of men, and that their apparent inferiority was entirely the result of inferior training. She regarded the praises bestowed upon her books, the acknowledgment of their originality, accuracy, and vigour, as a tribute not to herself but to her sex. If the books do not prove the intellectual equality of the sexes, they certainly prove that Miss C. was a very exceptional woman. We know from her letters and from the testimony of her friends, that her masculine brain and a great stock of erudition did not prevent her from affording a beautiful example of the graces and charms of the feminine character.

**CORREGGIO**, a town of Northern Italy, province of Reggio nell' Emilia, midway on the railway between Parma and Modena; pop. 2700. It is very handsome, regularly built, and has a castle, a cathedral, and a theatre. It was a barony of the lords of Correggio, who were great patrons of letters. It is the birthplace of the painter Antonio Allegri, surnamed Correggio; and of the engraver Jesi, &c.

**CÖTHEN, or KÖTHEN**, an ancient town of Germany, in the duchy of Anhalt, 22 miles south-west of Dessau, and about 82 south-west of Berlin, on a tributary of the Saale, and at the junction of railways from Berlin, Magdeburg, Bernburg, and Leipzig. The streets are broad, the town is neat and well-built, is surrounded by high walls, and is divided into the old and new town. It contains a castle with three towers, several churches and schools, a synagogue, a library, a handsome railway station containing a gaming-house, and various charitable institutions. Sugar from beetroot is largely manufactured here. Pop. (1871) 13,563.

**COTONEASTER**, a genus of plants of the natural order *Rosaceæ*, sub-order *Pomaceæ*, having polygamous flowers; a top-shaped calyx, with five short teeth; five small, erect petals; erect, short stamens; and a top-shaped fruit, the nuts of which adhere to the inside of the calyx, but do not cohere in the centre. The species are pretty numerous, shrubs or small trees; some of them evergreen; with simple undivided leaves, more or less woolly beneath; small flowers in lateral cymes; and small fruit not agreeable to the palate, but the bright colour of which, and its remaining on the tree in winter, make them very ornamental. *C. vulgaris* is a deciduous species, a native of hills in Europe and Siberia, and said to be found wild in a single



*Cotoneaster vulgaris*.

for the climate of Britain, and have become among the most common of our ornamental shrubs. Some of them, as *C. rotundifolia* and *C. microphylla*—both from the north of India—are much used for covering walls.

**COTTON FAMINE.** The history of manufacturing industry does not present a more striking episode than that which was connected with the effects of the Civil War in America on the cotton manufactures of Great Britain in 1861 and following years.

The years 1859 and 1860, unparalleled for the magnitude of the cotton manufacture, had much to do with the collapse that followed. So rapidly has this branch of industry increased in Lancashire, that the immigrants into that county from other districts have varied from 10,000 to 20,000 a year for a long series of years, irrespective of the natural increase of population by the excess of births over deaths. The imports of raw cotton, the exports of manufactured cotton, the number of mills, the number of hands, all were at their maximum in 1860. The imports were 1390 million lbs., of which 1054 millions were worked up in Great Britain. There were 1920 mills in Lancashire, 275 in the adjacent portions of Cheshire and Derbyshire, and enough elsewhere to make up a total of 2650. There were 440,000 hands employed in these mills; by age, 90 per cent. adults and young persons, and 10 per cent. children; by sex, 44 per cent. males, and 56 females. The machinery was worked by steam-engines having an aggregate of 300,000 horse-power. There were more than 30,000,000 spindles, making from 4000 to 6000 revolutions per minute; and 350,000 power-looms. The fixed capital in mills and machinery was valued at £54,000,000; while the money paid for wages in that year was £11,500,000. The cotton goods of various kinds manufactured for home consumption used up 180 million lbs. of cotton, and were valued at £24,000,000; while the exported goods—consisting of 2776 million yards of calico, muslins, &c., and 197 million lbs. of yarn—were valued at the enormous sum of £50,000,000; besides £2,000,000 more for cotton hosiery and small wares. The

that year. Considering that, of 1850 millions were imported, no less a weight than 1120 millions came from the United States, there is at once evidence afforded of the tremendous effect that would be produced by any stoppage in the American cotton-trade. Irrespective of this, however, there would have been a stagnation in our manufacturing districts in 1861, even if raw cotton had been plentiful and cheap. The manufacturers had glutted all the markets by the wholly unprecedented extent of their operations in 1860. The English warehouses, as well as those elsewhere, were full; and time was needed to carry off the immense stock. There were cotton goods on hand in Great Britain at the end of the year valued at £20,000,000; while in India our merchants continued to pour in goods even when the consignments of 1860 exceeded £17,000,000.

Fort Sumter was bombarded in April 1861. This was virtually the beginning of the American Civil War, and the beginning also of the rise in the price of cotton. A blockade was early established by the Federal government of Washington; and it was only by 'running' this blockade that cotton-laden ships could clear from the Southern or Confederate ports. The price of Middling Orleans (the kind of cotton mostly used, and that which governs the price of all other kinds) rose from 7½d. to 9d., 10d., and 12d., as the year advanced. There was thus a twofold motive for lessening the operations of the Lancashire mills—the markets were so fully supplied with manufactured goods, that no immediate augmentation was necessary; while the increase in the price of the raw material rendered manufacturing less profitable than before. The Liverpool dealers made colossal fortunes by the enormous rise in price of every bale of cotton which could reach the country from any quarter; while the manufacturers were also prosperous, because they could sell their accumulated stocks of calicoes and yarns at much higher prices than had been obtainable in 1860. It was the operatives who suffered. One by one, the mills were put upon half-time, because the mill-owners had not much inducement to spin and weave, under the extraordinary double influence above adverted to. It was not until autumn, however, that these effects were heavily felt, when there was the enormous quantity of 1000 million lbs. of cotton, raw and manufactured, on hand in Great Britain. When half-time began at the mills in October, there were, in Lancashire and the two neighbouring counties, 890 spinning-mills, 593 weaving-mills, 635 spinning and weaving mills, and 152 other cotton-mills of miscellaneous kinds, employing 369,453 factory-hands; and all these four classes of establishments became equally embarrassed. India or Surat cotton could still be had in considerable quantity, at 10d. per lb. instead of its former price of 5d.; but it was greatly out of favour, on account of its dirty condition, and the shortness and hardness of its staple. In November, there were 49 mills stopped, throwing out 8063 hands, while 119 were working half-time—placing something like 20,000 persons on half their usual wages. In December, Middling Orleans rose to 12d. So singular was the state of things, and so unlike what would be called a 'famine,' under other circumstances, that the actual quantity of raw cotton in Great Britain at the end of the year (280 million lbs.) was greater than ever before known in the history of the trade; but as the market-price of yarns and piece-goods at that time scarcely equalled that of raw cotton plus wages, the manufacturer could scarcely operate without a

a famine of cotton as a famine of employment. The year 1862 opened very gloomily. Relief committees began to be formed in Manchester, Wigan, Blackburn, Preston, and other towns, to distribute subscribed funds to such of the hands as were totally out of work. The streets were thronged with the unemployed; but there was no disturbance, and scarcely any begging. Sewing-schools were established by ladies in the several districts, to teach the factory girls useful domestic needle-work—of which they are generally very ignorant—to get them to make clothes for themselves and others; and to shield them from the vicious temptations which would beset them during a period of idleness. The ladies also won upon the affection of the girls by reading to them, and sympathising in many ways with their sorrows. Many of the manufacturers set apart large rooms as school-rooms and soup-kitchens for the boys and men, and abundant stores of soup were provided at 1d. per basin. The Poor-law Board sent down instructions to the local guardians how to give as much elasticity as possible to the system of parochial relief. In April, Blackburn had only 18 mills on full-time out of 84, the rest being either on half-time or closed; and there were 9000 of the inhabitants receiving parochial relief. Most of the other towns were in nearly as bad a plight. In May, matters were worse; Preston had 10,000 operatives out of work, and Blackburn had just about half-employment for 27,000. Middling Orleans rose in price to 15d., and manufacturers had more inducement to speculate in cotton than to spin it. Meanwhile, great efforts were made to assist the distressed operatives. The letters of a 'Lancashire Lad' in the *Times*, with the text, 'Con yo help us a bit?' made a great impression. The *Daily Telegraph* raised a fund of £5000 by its own exertions. The Lancashire landowners established a 'Cotton District Relief Fund' in London, to which they subscribed £11,000 in one day; the Lord Mayor established a 'Mansion-house Committee,' which received subscriptions from all parts of the world; Manchester established a 'Central Relief Committee,' as a nucleus for various local funds; while a great county meeting brought in £130,000, of which £70,000 was subscribed in one day in one room. Mr Farnall was sent down by the Poor-law Board, as special commissioner, to superintend the plans for parochial relief. A Rate-in-aid Bill was passed through parliament, to enable the government to issue Orders in Council, authorising parishes to raise money on the guarantee of future rates; it was only to be done where the current poor-rate had already reached a high figure, and the money raised was to be applied strictly to mitigate the distress of the operatives. Notwithstanding all these sources of assistance, the work-people became reduced to great distress. 'The pawnbrokers' stores,' said an eye-witness, 'were glutted with the heir-looms of many an honest family. Little hoards were drained to meet the exigencies of the time. Many found it the sorest trial of their lives to ask for food; and it is a happy circumstance for all to remember, as it is honourable to those of whom it is recorded, that none suffered more severely than those who had a struggle to overcome their unwillingness to subsist upon food which they had not earned. Rents were falling in arrears, and many a house which had held only one family, was now occupied by three or four, in order to economise rent, fuel, and furniture.' Nevertheless, none died of privation, and the average sickness was even less than usual. It was a fact well ascertained that spirit-drinking was less indulged in than

Orleans rose to 2s. 3d. in October, and thus there was less inducement than ever to purchase for the sake of manufacturing. Strange as it may appear, 50,000 bales of cotton were resold by the manufacturers themselves during the year, at the very time when the phrase 'cotton famine' was on the lips of every one; but the simple fact was, that more profit could be made by reselling than by manufacturing.

It was a gloomy winter, that of 1862—1863, for the mill-hands. In October, the loss of wages was estimated at £136,000 per week. In November, there were 208,000 persons in the Lancashire district receiving out-door parochial relief, and 144,000 others aided by subscribed funds; there were at the same time 20,000 mill-girls at the sewing-schools. At Christmas, there were 250,000 hands totally out of work; those, and about as many more dependent on them, received £40,000 a week from the parishes and the committees. Vast sums were sent from various parts of the world to be spent in winter-clothing only, and prodigious stores of second-hand clothing were contributed by private families. As the money relief seldom exceeded 2s. or 2s. 6d. per week per applicant, to purchase clothing out of this was of course impracticable. The small shopkeepers also suffered greatly; for there was only one-third the amount of wages received by their customers per week that had been received two years before. Emigration schemes were much discussed, but were not carried on very largely, because Lancashire men felt convinced that trade would revive after a time. Meanwhile, the rate of wages was not lowered; few mill-owners proposed it, and the operatives were rootedly against it; however small the quantity of work, it was paid for at the old rate.

No date can be named for the actual cessation of the distress; it died out by degrees. When the manufacturers had sold off their old stocks, they recommenced buying more to spin and weave; because, although the price of raw cotton was enormously high (2s. 5d. for Middling Orleans in May 1863), the selling price for calicoes and muslins was now proportionably high, and therefore they could manufacture at a profit. In June 1863, a 'Public Works Act' was passed, to enable the government to advance £1,200,000 for public works in the cotton districts—partly to make good drainage, roads, water-supply, &c., and partly to yield £800,000 or £700,000 as wages to the unemployed cotton-hands in doing so much of the work as they could manage. The money (to be repaid by parish rates at subsequent dates) was to be advanced by the Exchequer Loan Commissioners on the recommendation of the Poor-law Board, and a government engineer was to examine and sanction the several works to be executed. All these operations were to be confined strictly to the cotton districts, where the distress existed. Mr R. A. Arnold, the resident government inspector of these public works, states in his *History of the Cotton Famine*, that by the month of June 1865, there had been works planned, and in great part executed, under the clauses of this and a supplementary bill, to the amount of £1,846,000. They comprised the making or improving of 276 miles of street and highway, 304 miles of main sewer, reservoirs for 1500 million gallons of water, several parks and cemeteries, and a large area of land-drainage. Nearly 30,000 persons had been fed by the wages of the cotton operatives on these works. The subscriptions to meet the distress reached the vast sum of £2,000,000;

cotton available during this extraordinary period are strikingly shewn in the following parallel columns, relating to the raw cotton imported, and the money paid for it:

	Quantities (Cwts.).	Value.
1860. . . . .	12,410,000	£35,757,000
1861. . . . .	11,223,000	38,683,000
1862. . . . .	4,678,000	31,093,000
1863. . . . .	5,978,000	54,276,000
1864. . . . .	7,976,000	75,204,000
1865. . . . .	8,732,000	66,032,000
1866. . . . .	12,296,000	77,521,000

Remark here the sudden and tremendous increase in the amount paid for cotton in the latter half of the period; the payment, indeed, of forty millions sterling more in 1866 than in 1860, for about the same quantity. To shew how India and Egypt benefited by this unprecedented state of affairs, we give (in pounds,\* not cwts.) the quantities imported from those countries as compared with the imports from the United States:

	United States.	India.	Egypt.
1860. . . . .	1,119,000,000	204,000,000	45,000,000
1861. . . . .	816,000,000	369,000,000	41,000,000
1862. . . . .	12,534,000	393,000,000	58,000,000
1863. . . . .	6,394,000	434,000,000	94,000,000
1864. . . . .	14,148,000	507,000,000	125,000,000
1865. . . . .	139,000,000	446,000,000	177,000,000
1866. . . . .	520,000,000	615,000,000	118,000,000

Look, again, at the prices per cwt. :\*

	United States.	India.	Egypt.
1860. . . . .	3 0 4	1 17 0	2 15 6
1861. . . . .	8 12 5	2 17 5	4 4 9
1862. . . . .	10 2 4	6 5 9	7 1 4
1863. . . . .	11 5 8	8 18 11	10 11 3
1864. . . . .	13 11 0	8 9 0	12 15 3
1865. . . . .	9 18 6	6 5 7	8 16 1

The export of British Indian cotton in 1860 brought only £2,500,000: in 1864 it fetched £24,000,000. The largest quantity imported was in 1866. In 1876, the total value of Indian cotton was £5,874,704.

CO'VINGTON, a city of Kentucky, U. S., on the south bank of the Ohio River, and west of the mouth of Licking River, opposite Cincinnati, with which it is connected by a lofty suspension-bridge and steam-ferris. It has a city hall, 25 churches, the Western Theological College, a Roman Catholic cathedral, and manufactories of cotton, hemp, silk, tobacco, and iron. There are also several establishments for packing pork and beef. Pop. (1860) 16,471; (1870) 24,506.

ORAB, ROSS, a singular sectary of the English Revolution, had served for seven years in the Parliamentary army, and though he had his 'skull cloven' by a royalist trooper, yet, for some breach of discipline, Cromwell sentenced him to death, a punishment subsequently commuted to two years' imprisonment. After his release from jail, C. set up in business as 'a haberdasher of hats' at Chebham, in Buckinghamshire. His wandering mind, probably not improved by the skull-cleaving operation, then

\* The Board of Trade Tables, from which these figures are taken, are often difficult to consult, on account of the quantities of cotton being stated sometimes in bales, sometimes in cwts., and sometimes in pounds.

was: "Deceitful to know, and heavy, and injurious to the young man in the gospel, he sold off his stock in trade, distributing the proceeds among the poor, and took up his residence in a hut, situated on a rood of ground near Ickenham, where for some time he lived on the small sum of three-farthings a week. His food consisted of bran, dock-leaves, mallows, and grass; and how it agreed with him we learn from a rare pamphlet, principally written by himself, entitled *The English Hermit, or the Wonder of the Age*. 'Instead of strong drinks and wines,' says the eccentric Roger, 'I give the old man a cup of water; and instead of roast mutton and rabbit, and other dainty dishes, I give him broth thickened with bran, and pudding made with bran and turnip-leaves chopped together, at which the old man (meaning my body) being moved, would know what he had done, that I used him so hardly. Then I shewed him his transgressions, and so the wars began. The law of the old man in my fleshly members rebelled against the law of my mind, and had a shrewd skirmish; but the mind, being well enlightened, held it so that the old man grew sick and weak with the flux, like to fall to the dust. But the wonderful love of God, well pleased with the battle, raised him up again, and filled him full of love, peace, and content of mind, and he is now become more humble, for now he will eat dock-leaves, mallows, or grass.'

The persecutions the poor man inflicted on himself, caused him to be persecuted by others. Though he states that he was neither a Quaker, a Shaker, nor a Ranter, he was cudgelled and put in the stocks; the wretched sackcloth frock he wore was torn from his back, and he was mercilessly whipped. He was four times arrested on suspicion of being a wizard, and he was sent from prison to prison; yet still he would persist in his course of life, not hesitating to term all those whose opinion differed from his by the most opprobrious names. He published another pamphlet, entitled *Dagon's Downfall, or the great Idol digged up Root and Branch; the English Hermit's Spade at the Ground and Root of Idolatry*. This work shews that the man was simply insane. We last hear of him residing in Bethnal Green. He died on the 11th of September 1680, and was buried in Stepney Churchyard. — *Chambers's Book of Days*, vol. ii. p. 334.

**CREUZOT**, LE, a town of France, dep. of Saone-et-Loire, 12 miles south-south-east of Autun. It is situated in the midst of a district rich in coal and iron, and possesses large iron-foundries, which turn out cannon, anchors, steam-machinery, &c., and which employ 10,000 workmen. A short railway connects the town with the Canal du Centre, which traverses the coal-field. There is also a glass manufactory, one of the most important in France. C. has of late increased rapidly in size and importance. The pop., which in 1841 was 4000, in 1872 had reached 21,011.

**OROQUET**, an open-air game, in which two or more players endeavour to drive wooden balls, by means of long-handled mallets, through a series of arches set in the ground according to some pattern. The player who first makes the complete circle of the hoops or arches wins the match; but during the progress of the game, each player may have the progress of his ball retarded by his adversaries, or assisted by his allies; and these friendly aids and hostile attacks constitute the chief interest of croquet. Although generally spoken of as a modern game,

was popular in England in the days of the Stuarts, and gave the name Fall Mall to localities in various towns in England as well as on the continent (see BALL). The name (It. *paella*, a ball, and *maglio*, a mallet; Fr. *paletaille*) suggests an Italian origin; but the game was early in vogue in France, and thence passed into England, probably in the beginning of the 17th century. Blount's *Glossographia* describes the game as quoted in the article BALL, and gives figures of the mallets, which are here reproduced. This game seems to have gone out of fashion early in the 18th century. Who resuscitated it in its modern form, and how it got the name of croquet, are questions that have not been answered. Since 1850 C. has been a favourite game, and was for a time the most prevalent of all summer amusements, though latterly its charms have been shared by lawn-tennis, rink-skating, &c. One advantage of the game is, that the two sexes can join in it on equal terms.

A croquet-ground should be a well-rolled level grass plat or lawn, not less than thirty yards long by twenty yards wide; a full-sized croquet-ground measures forty yards by thirty yards. The boundaries of the ground should be well defined, either by a raised walk or a trench. The game may be very well played on an ordinary cricket-field, or in an enclosed meadow. The grass plats in the squares of large towns have been very generally appropriated to croquet. Croquet can also be played upon a well-rolled gravel ground, or upon the sea-shore, where the sands are hard and dry. Hardness is essential, so as to prevent the ball from sinking into the ground.

THE IMPLEMENTS used in croquet are mallets, balls, posts (or sticks), and hoops (which are called indifferently hoops, wires, or arches). To these are sometimes added a cage, or a pair of tunnels; or hoops, tunnels, and cage may be all employed in the same game. The progress of each player may be marked with either clips or a marking-board.

The Mallets should be light and handy; with ash shafts, and boxwood or ash heads. The heads of the mallets are of various shapes—as the dice-box,

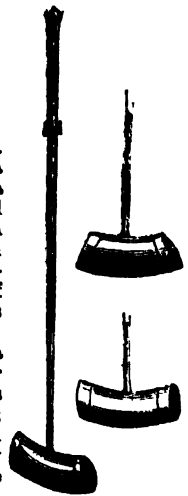

Fig. 1.—Mallets used in the old game of well played on an ordinary cricket-field, or in an enclosed meadow.

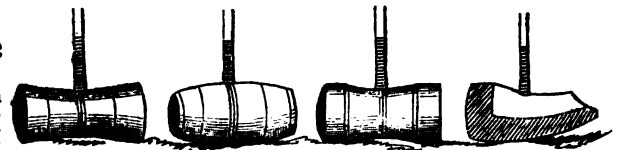

Fig. 2.—Mallets used in Croquet.

which is the most common shape; the plano-convex, the hammer-head, and the cue-shape. The last, which came latest into use, has a flat end and a pointed end; the latter, like a billiard-cue, being tipped with leather. The head of the mallet should be from four inches to four and three-quarters in length, by not more than two

shaft should be three feet nine inches to three feet in length. Next the head there should be a ring or rings of paint, corresponding in colour or number to the player's ball, and the series of colours on the starting and turning pegs.

*The Balls* are made of box or beech, thoroughly well turned and seasoned. Boxwood is generally preferred, but a ball composed of cocoa-nut fibre and india-rubber, which is very pleasant to play with, has also been used.



Fig. 3.—Ball. These balls are perfectly round, are made of the correct size and weight, and are known as 'Nicholson's Patent Compound Croquet Balls.' The proper size of the balls is three inches and five-eighths in diameter. Where wooden balls are employed, they should be kept rubbed with linseed-oil when out of play.

A full set of croquet balls consists of eight. In order to determine the order of play, these are either severally painted, in whole or in part, blue, pink, black, yellow, brown, orange, green, and red; or distinguished by bearing a different number of stripes of the same colour, four of them having from one to four red stripes, and the other four from one to four blue stripes.

*The Pegs* are two or three in number, according to the particular style of game played. They are each about two feet in height, round in shape, pointed at the lower end like a cricket stump, and painted in rings corresponding to the colours of the balls—the top line blue, and then pink, black, &c., as in the diagram here shewn. When the numerical distinction of the balls is adopted, the pegs are painted in rings alternately of red and blue.



Fig. 4.—The Peg.

at Wimbledon, the hoops are only one-eighth of an inch larger than the balls, but in private play they are usually much wider. They should not, however, be more than six inches in width. The hoops are made of galvanised iron, or iron painted white, and are either round or flat at the top; a hoop with the crown at right angles to the legs is

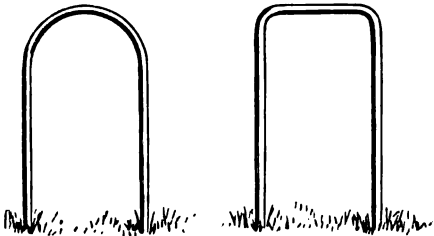

Fig. 5.—Hoops.

to be preferred. When set, the crown of the hoop should be at least twelve inches clear of the ground. By having the hoops painted white or galvanised,

than the hoops, with flat sides. When used, the player is sometimes restricted to one way of running them. They merely add to the difficulties of the game, and are not very popular or essential.

*The Cage* consists of an additional pair of white hoops placed crosswise in the ground, either with or without a suspended bell at their junction.

*Clips* or discs of tin, marked with the several colours, are sometimes used to mark the game by being hung on the hoops as each player passes through; but many players do without the clips altogether. In the place of the clips, a *marking-board*, the same in principle as the pool-board in billiards, is often used.

#### *Terms used in the Game.*

In croquet, as in other games, there are various terms employed, which, to the uninitiated, often sound strange and meaningless. We mention the most indispensable.

*Roquet* (pronounced *rokay*).—The word is used to denote that when both balls are 'in play,' the striker's ball is caused by a blow of the mallet to hit another which it has not before hit in the same turn since making a point. The making a roquet gives the striker the privilege of croqueting (pronounced *krokaying*) the ball struck. A second roquet, without a point in the interval, does not count; but it may be made for the purpose of driving away an opponent's ball, cannoning, &c.; the striker's turn ending there, unless by the same stroke he make a point, or roquets another ball, which he has not previously struck during the round, and since making a point.

*Croquet*.—When one ball has roqueted another, the striker's ball is placed in contact with the one roqueted, the striker then hitting his own ball with the mallet. The non-striker's ball, when moved by a croquet, is called the *croqueted ball*. The striker is not allowed to put his foot upon the ball, as was formerly the case in what was known as *tight croquet*.

*A Loose Croquet* is made in three ways: first, by the striker placing his ball close to the one he has roqueted, and striking the former, in a line passing through the axis of each—by which plan the striker's ball remains almost stationary while the other flies forward; secondly, by the player striking the ball at any angle, so as to drive the balls in opposite directions. This is called a 'splitting croquet.' And lastly, by touching the roqueted ball slightly, with as little movement in the player's ball as need be. This last stroke is called 'taking two turns off' the roqueted ball. In any case, the latter must be sufficiently moved to satisfy the umpire as to the fairness of the stroke.

*A Rolling Croquet* is made by placing the two balls in juxtaposition as before, and the player striking his own ball in such a way as to make it follow after the ball struck. This is also called a 'following stroke,' and is made by striking your ball high; while in a *tight croquet*, you hit your ball below its centre, and with a sudden drawback motion of the hand, as in making the screw in billiards. Considerable judgment is required to make the croquet in such a way as to assist your own game and encumber that of your opponent by one and the same stroke.

*The Side Stroke* is made by raising the mallet to the shoulder, and hitting your ball full in the centre.

*The Straight Stroke* is made with the mallet held straight to the axis of the ball, perpendicularly in front of the body.

no noise. The umpire must decide, on being appealed to, whether the ball is a *spoon* or a *tap*.

When a ball has been roqueted, the striker takes up his own ball, and places it close to the roqueted ball. He then makes his croquet as above described.

*In Play.*—A ball is said to be 'in play' as soon as it has run the first hoop; and it remains in play till it makes a roquet, when it is

*In Hand.*—The ball being 'in hand,' cannot score till it has made a croquet, after which it is again 'in play;' but unless it makes a point, it continues 'in hand' to the ball or balls it has croqueted for the remainder of its turn. When it has made another point, it is 'in play' again to all the balls, as at the beginning of its turn.

*Dead Ball.*—A ball is said to be 'dead' when it has run all the hoops 'in order,' and has struck the winning-peg.

*In Order.*—This term is used to signify the hoops, tunnels, cages, pegs, &c., in their regular order of play, according to the plan or arrangement adopted in placing them in the ground. When a player has made the complete round of the hoops in their proper sequence, he is said to have made his 'tour' or 'round' of play. The striker's hoop or peg *in order* is the one he has next to make. The game is won by the side or player succeeding in first driving the balls through the hoops, in order, to the turning-peg, and then back again to the winning-peg.

*The Starting and Winning Peg* is the stake from which the play in the game proceeds. *The Turning-Peg* is the stake placed at the other extremity of the hoops, directly opposite the starting-peg; and round which the player must strike his ball before he makes the return-route.

*To Dismiss* a ball, is to strike it to a distance. *Running a Hoop* is when a ball is struck fairly through the hoop next in order of play. *Rueing a Hoop* is the failure of a ball to reach the hoop aimed at. The player who misses his first hoop is by some players known as a *booby*. *Ricochet* is the striking of the player's ball against two balls in succession. This stroke, which is sometimes called the double roquet, is precisely similar to the cannon in billiards. A *Wired Ball* is one which cannot be croqueted, by reason of the leg of the hoop intervening. A *Rover* is a player who has made the complete tour of the hoops, 'in order,' and elects to remain in the game to assist his side and encumber their adversaries.

#### *The Points of the Game.*

The points reckoned are—1. Running a hoop; 2. Running a tunnel or cage; 3. Striking a peg; each in the regular order of play.

1. A hoop is said to be 'run' when a ball has fairly passed through it while in play. A ball is considered to have 'passed its hoop' if it cannot be touched by a straight stick—as the handle of a mallet—laid on the ground parallel to the hoop on the side whence the player struck.

2. In running a tunnel, the ball must pass completely through; and in running a cage, the same test may be applied as for the hoop. Where a ball is suspended—as in the Eglinton Game—it must be rung before the point can be scored by the player.

3. The peg must be fairly hit, so that the blow may be heard, or the peg be seen to be moved from its position.

The player is not compelled to play for a roquet or point. It is sometimes better play for him to strike his ball towards a particular spot, so that on his turn coming round he may make his hoop the

#### *The Game.*

The game of croquet may be played by any number of players not exceeding eight—four on each side. It is common, indeed, when two players engage in a match, for each to have two balls. The committee of secretaries from various croquet clubs, which drew up the now universally recognised Conference Code of Laws, recommend the game where there are two players on each side in preference to any other. The hoops being set according to one of the plans following, or in any other way decided on by the players, the game commences by the choosing of 'sides.' The players, for distinction's sake, take balls and mallets of opposite colours—those on one side choosing, say, blue, black, brown, or green; those on the other the light balls—pink, yellow, orange, or red. This done, the players address one another as pink, brown, &c., according to the colour of their balls. When the balls are marked by different numbers of rings, one side takes the balls with red rings, the other those with blue rings, the players being then addressed as One Red, Three Blue, &c.

The player whose ball is nearest the top of the peg—according to any succession of colours that may be adopted or determined on—starts from a mallet's length of the *starting-peg*, and endeavours to strike his ball through the first hoop. If he fail in 'running his hoop,' he must wait till his turn comes round again; his ball, meanwhile, remaining on the ground to be struck (roqueted) or croqueted by any of the succeeding players. If, however, the player succeed in making his first hoop, he goes on to strike his ball through the second hoop, and so on till he fail; which, from the peculiar angles or lines of direction between the hoops, he will probably do at his third hoop. The other colours then play in their order. It is unnecessary to follow all their strokes; but let us suppose that orange, whom we will make a lady, is just passing through her second hoop, blue, pink, black, yellow, and brown lying in various positions, in the neighbourhood of the third and fourth hoops, one or other of which they are severally desirous of threading. Orange, having passed her ball through a hoop, is entitled to another hit. Carefully calculating her distance, she strikes her partner, yellow, gently, just impelling that ball towards the mouth of the hoop through which yellow has to pass. The same stroke brought orange nearly below the third hoop, which a long stroke would enable it to pass. Like passing a hoop, striking another ball—friend or foe—gives another turn; consequently, orange has a choice before her. She may aim for the third hoop, and, as she is a good player, probably passes it; but the distance is considerable, and any pebbles or slight irregularity in the ground may cause her ball to diverge from the direction in which it was struck. On the other hand, as there are several balls in her vicinity, she prefers to work her way to the hoop by successive strokes among her neighbours, distributing favours as she goes. Blue, an enemy, lies nearest, still anxious for his third hoop. A gentle tap with the mallet brings orange against him. This entitles her either to another free stroke or to a croquet. She chooses the latter, and to perform it, selects a spot as unfavourable as possible for blue. The turning-peg seems suitable; she lifts her ball, places it at the side of blue farthest from the turning-peg, and bringing down the mallet with a sharp stroke upon her own ball, sends her azure enemy flying over the lawn in the direction of the turning-peg, and even beyond it; while her

She similarly croquets pink; but pink being a friend, she croquets him through his hoop and well up for his fourth hoop. Black escapes orange's attention, and she, after croqueting pink, passes the hoop herself, by so doing acquiring another turn; and as she has passed a hoop between, she may again aid yellow or pink, or pass on to her other hoops herself, as she pleases. With the aid thus obtained from other balls, a good player may sometimes pass the whole round of hoops without being once stopped.

When a player has passed all the hoops on the one side, he makes his way round the turning-peg, and proceeds to run the hoops on the other side, in the contrary direction, but with the same restrictions and methods as before. Having passed through the last hoop, he may proceed to strike the

no more. If, however, he be a good player, he may considerably benefit his friends, and annoy his enemies, by becoming a 'rover,' and travelling about from hoop to hoop, aiding his partners against their foes. Of course, if a rover be a clever player, the opposite side will do their best to strike his ball against the winning-peg, and so stop his further ravages. On the other hand, if he be an awkward croqueteer, it is best to let him live, as his side cannot win, though all his partners be out, so long as he can be kept afield.

This description, with the aid of the Rules and Definitions of Terms, will, we fancy, enable anybody to play croquet without much trouble.

Each side should choose a captain or leader to conduct the game; and it is also well that a

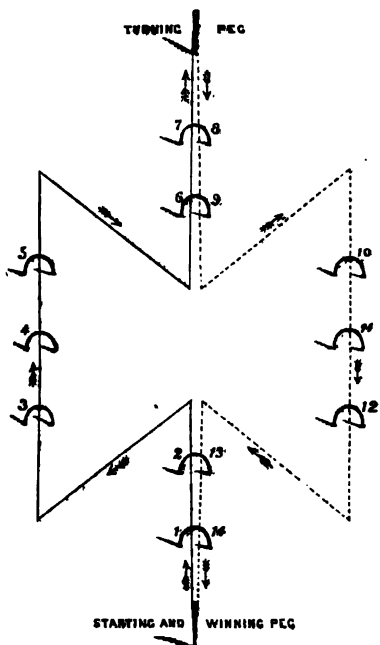

Fig. 6.—The Original Plan for Ten Hoops.

umpire, who thoroughly understands the theory and laws of croquet, should be selected to decide disputed points.

*The Arrangement of the Hoops.*

Various plans for the placing of the hoops have been adopted by croquet players; but the general principles of the game are the same in all cases, whatever the shape of the ground or the disposition of the arches. The following is the original plan, and the easiest way of setting out the hoops; and a clever player may make the entire round without stopping (see fig. 6).

To set out the hoops in this fashion, drive in the starting-peg (which is also the winning-peg), and set the first hoop in a straight line from it at a distance of 12 feet. Set the second hoop 10 feet farther on; then draw a diagonal line of 20 feet, and set up the third hoop, with the fourth hoop 10 feet distant in a straight line, and the fifth hoop 10 feet farther. Then draw another diagonal of 20

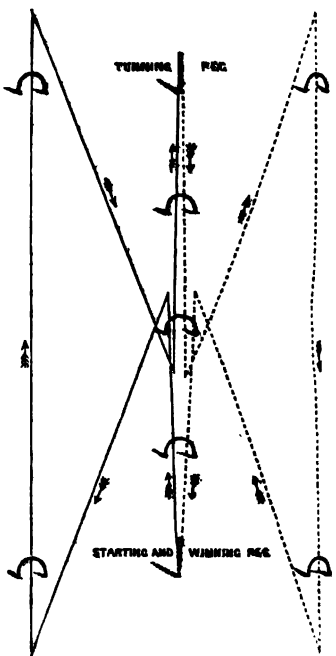

Fig. 7.—Arrangement for Seven Hoops.

feet, and set up the sixth hoop immediately opposite the second; carry the seventh hoop 10 feet back in a straight line, and fix the turning-peg 12 feet back, to correspond with the starting-peg. Afterwards, complete the other side in precisely the same way. Thus, the order of play will be from the starting-peg to hoop 1, and so on to the turning-peg, and thence back to the winning-peg. The perfect lines shew the onward march of the balls, and the dotted lines their return. This arrangement is carried through all the diagrams here given. Of course, the distance from hoop to hoop must be greatly governed by the space of the ground; but the proportions here indicated should be generally observed. A tape or line marked in feet or yards will be found of great assistance in setting out the hoops.

The setting in fig. 7 is a more modern one, and is recommended for private play. It is known as No. 2 setting, and requires only seven hoops. In small grounds, one of the hoops between the pegs

Sometimes ten hoops are placed in a circle, with a cage in the middle, which arrangement makes the game rather more difficult; sometimes two extra pegs are added; in fact, the variety of figures which may be improvised by an ingenious captain is almost endless. But whatever the number of hoops, pegs, &c., and whatever the arrangement adopted, the main elements of the game are the same.

#### Law of Croquet.

The following rules are those known as the Conference Code, drawn up by a meeting of the secretaries of various clubs, and the recognised standard in all public games:

1. *Mallets.*—There shall be no restriction as to the number, weight, size, shape, or material of the mallets; nor as to the attitude or position of the striker; nor as to the part of the mallet held, provided the ball be not struck with the handle, nor the mace stroke used.

2. *Size of Balls.*—The balls used in match-play shall be 3½ inches in diameter.

3. *Choice of Lead and of Balls.*—It shall be decided by lot which side shall have choice of lead and of balls. In a succession of games the choice of lead shall be alternate, the sides keeping the same balls.

4. *Commencement of Game.*—In commencing, each ball shall be placed on the starting spot. The striker's ball, when so placed and struck, is at once in play, and can roquet another, or be roqueted, whether it has made the first hoop or not.

5. *Stroke, when taken.*—A stroke is considered to be taken if a ball be moved in the act of striking; but should a player, in taking aim, move his ball accidentally, it must be replaced to the satisfaction of the adversary, and the stroke be then taken. If a ball be moved in taking aim, and then struck without being replaced, the stroke is foul (see Law 25).

6. *Hoop, when run.*—A ball has run its hoop when, having passed through from the playing side and ceased to roll, it cannot be touched by a straight-edge placed against the wires on the side from which it was played.

7. *Ball driven partly through Hoop.*—A ball driven partly through its hoop from the non-playing side cannot run the hoop at its next stroke, if it can be touched by a straight-edge placed against the wires on the non-playing side.

8. *Points counted to Non-striker's Ball.*—A ball driven through its hoop, or against the turning-peg, by any stroke not foul, whether of its own or of the adverse side, counts the point so made.

9. *Points made for Adversary's Ball.*—If a point be made for an adversary's ball, the striker must inform his adversary of it. Should the striker neglect to do so, and the adversary make the point again, he may continue his turn as though he had played for his right point.

10. *The Turn.*—A player, when his turn comes round, may roquet each ball once, and may do this again after each point made. The player continues his turn so long as he makes a point or a roquet.

11. *Croquet imperative after Roquet.*—A player who roquets a ball must take croquet, and in so doing must move both balls (see Law 25). In taking croquet, the striker is not allowed to place his foot on the ball.

12. *Ball in Hand after Roquet.*—No point or roquet can be made by a ball which is in hand. If a ball in hand displace any other balls, they must remain where they are driven. Any point made in

13. *Balls Roqueted simultaneously.*—When a player roquets two balls simultaneously, he may choose from which of them he will take croquet; and a second roquet will be required before he can take croquet from the other ball.

14. *Balls found touching.*—If at the commencement of a turn the striker's ball be found touching another, roquet is deemed to be made, and croquet must be taken at once.

15. *Roquet and Hoop made by same Stroke.*—Should a ball, in making its hoop, roquet another that lies beyond the hoop, and then pass through, the hoop counts as well as the roquet. A ball is deemed to be beyond the hoop if it lies so that it cannot be touched by a straight-edge placed against the wires on the playing side. Should any part of the ball that is roqueted be lying on the playing side of the hoop, the roquet counts, but not the hoop.

16. *Pegging out.*—If a rover (except when in hand) be caused to hit the winning-peg by any stroke of the same side, not foul, the rover is out of the game, and must be removed from the ground. A rover may similarly be pegged out by an adverse rover.

17. *Rover pegged out by Roquet.*—A player who pegs out a rover by a roquet loses the remainder of his turn.

18. *Balls sent off the Ground.*—A ball sent off the ground must at once be replaced 3 feet within the boundary, measured from the spot where it went off, and at right angles to the margin. If this spot be already occupied, the ball last sent off is to be placed anywhere in contact with the other, at the option of the player sending off the ball.

19. *Ball sent off near Corner.*—A ball sent off within 3 feet of a corner is to be replaced 3 feet from both boundaries.

20. *Ball touching Boundary.*—If the boundary be marked by a line on the turf, a ball touching the line is deemed to have been off the ground. If the boundary be raised, a ball touching the boundary is similarly deemed to have been off the ground.

21. *Balls sent off and returning to Ground.*—If a ball be sent off the ground, and return to it, the ball must be similarly replaced, measuring from the point of first contact with the boundary.

22. *Ball sent within 3 feet of Boundary.*—A ball sent within 3 feet of the boundary, but not off the ground, is to be replaced as though it had been sent off; except in the case of the striker's ball, when the striker has the option of bringing his ball in, or of playing from where it lies.

23. *Boundary interfering with Stroke.*—If it be found that the height of the boundary interferes with the stroke, the striker, with the sanction of the umpire, may bring in the balls a longer distance than 3 feet, so as to allow a free swing of the mallet. Balls so brought in must be moved in the line of aim.

24. *Dead Boundary.*—If, in taking croquet, the striker send his own ball, or the ball croqueted, off the ground, he loses the remainder of his turn; but if by the same stroke he make a roquet, his ball, being in hand, may pass the boundary without penalty. Should either ball, while rolling after a croquet, be touched or diverted from its course by an opponent, the striker has the option given him by Law 26, and is not liable to lose his turn should the ball which has been touched or diverted pass the boundary.

25. *Foul Stroke.*—If a player make a foul stroke, he loses the remainder of his turn, and any point or roquet made by such stroke does not count. Balls moved by a foul stroke are to remain where they lie,



or be replaced at the option of the adversary. If the foul be made when taking croquet, and the adversary elect to have the balls replaced, they must be replaced in contact as they stood when the croquet was taken. The following are foul strokes:—(a) to strike with the mallet another ball instead of or besides one's own, in making the stroke; (b) to spoon—i.e. to push a ball without an audible knock; (c) to strike a ball twice in the same stroke; (d) to touch, stop, or divert the course of a ball when in play and rolling, whether this be done by the striker or his partner; (e) to allow a ball to touch the mallet in rebounding from a peg or wire; (f) to move a ball which lies close to a peg or wire by striking the peg or wire; (g) to press a ball round a peg or wire (crushing stroke); (h) to play a stroke after roquet without taking croquet; (i) to fail to move both balls in taking croquet; (k) to croquet a ball which the striker is not entitled to croquet.

26. *Balls touched by Adversary.*—Should a ball when rolling, except it be in hand, be touched, stopped, or diverted from its course by an adversary, the striker may elect whether he will take the stroke again, or whether the ball shall remain where it stopped, or be placed where, in the judgment of the umpire, it would have rolled to.

27. *Balls Stopped or Diverted by Umpire.*—Should a ball be stopped or diverted from its course by an umpire, he is to place it where he considers it would have rolled to.

28. *Playing out of Turn, or with the Wrong Ball.*—If a player play out of turn, or with the wrong ball, the remainder of the turn is lost, and any point or roquet made after the mistake. The balls remain where they lie when the penalty is claimed, or are replaced as they were before the last stroke was made, at the option of the adversary. But if the adverse side play without claiming the penalty, the turn holds good, and any point or points made after the mistake, are scored to the ball by which they have been made (that is, the ball is deemed to be for the point next in order to the last point made in the turn), except when the adversary's ball has been played with, in which case the points are scored to the ball which ought to have been played with. If more than one ball be played with during the turn, all points made during the turn, whether before or after the mistake, are scored to the ball last played with. Whether the penalty be claimed or not, the adversary may follow with either ball of his own side.

29. *Playing for Wrong Point.*—If a player make a wrong point it does not count, and therefore (unless he have, by the same stroke, taken croquet, or made a roquet), all subsequent strokes are in error, the remainder of the turn is lost, and any point or roquet made after the mistake. The balls remain where they lie when the penalty is claimed, or are replaced as they were before the last stroke was made, at the option of the adversary. But if the player make another point, or the adverse side play, before the penalty is claimed, the turn holds good: and the player who made the mistake is deemed to be for the point next in order to that which he last made.

30. *Information as to Score.*—Every player is entitled to be informed which is the next point of any ball.

31. *State of Game if Disputed.*—When clips are used, their position, in case of dispute, shall be conclusive as to the position of the balls in the game.

32. *Wires knocked out of Ground.*—Should a player, in trying to run his hoop, knock a wire of that hoop out of the ground with his ball, the hoop does not count. The ball must be replaced, and the stroke taken again; but if by the same stroke a

roquet be made, the striker may elect whether he will claim the roquet or have the balls replaced.

33. *Pegs or Hoops not upright.*—Any player may set upright a peg or hoop, except the one next in order, and that must not be altered except by the umpire.

34. *Ball lying in a Hole or on Bad Ground.*—A ball lying in a hole or on bad ground may be moved with the sanction of the umpire. The ball must be put back—i.e. away from the object aimed at—and so as not to alter the line of aim.

35. *Umpires.*—An umpire shall not give his opinion, or notice any error that may be made, unless appealed to by one of the players. The decision of an umpire, when appealed to, shall be final. The duties of an umpire are—(a) to decide matters in dispute during the game, if appealed to; (b) to keep the score, and, if asked by a player, to disclose the state of it; (c) to move the clips, or to see that they are properly moved; (d) to replace balls sent off the ground, or to see that they are properly replaced; (e) to adjust hoops or pegs not upright, or to see that they are properly adjusted.

36. *Absence of Umpire.*—When there is no umpire present, permission to move a ball, or to set up a peg or hoop, or other indulgence for which an umpire would be appealed to, must be asked of the other side.

37. *Appeal to Referee.*—Should an umpire be unable to decide any point at issue, he may appeal to the referee, whose decision shall be final; but no player may appeal to the referee from the decision of an umpire.

#### PARLOUR CROQUET.

During winter evenings, or in wet weather, the lovers of croquet may play at the game within doors, either in a large play-room or on a table. Sets of implements for various parlour and table games akin to the croquet of the lawn, are now produced by various makers. The hoops for parlour croquet are set on feet, so that they will stand



The Croquet Stand.

straight and firm. All the rules of ordinary croquet are observed; while for the other games, rules are given with each set of implements.

CSERVEKA, a town of Hungary, in the county of Upper Bacs, on the Franzens Canal, about 130 miles S. of Pesth. Pop., which is German (1869) 6877.

in the province, and 25 miles south-south-east of the town, of Valencia. C. is irregularly built, but clean; has an old castle, several churches, schools, convents, a hospital, extensive barracks, &c. From its position, it is considered a place of great military importance. It stands on the outskirts of an agricultural district, 'an Eden of fertility,' and the inhabitants are mostly engaged in agriculture, cattle-rearing, fishing, and the production of oil and wine. A considerable coasting-trade is carried on with France and the Mediterranean. Pop. 8500.

CULNA, a town of India, in the British district of Burdwan, presidency of Bengal, 47 miles north of Calcutta, on the right bank of the Hooghly. The town contains a vast number of temples, is a station of the Free Church (Scotland) Mission, and has a flourishing English school. It is a place of considerable trade, rice, grain, silk, and cotton being the chief articles of commerce; and of late years, the traffic has greatly increased, in consequence of its being found a convenient station for steamers plying between Calcutta and the upper provinces. C., in 1871, had 27,336 inhabitants, the chief part of whom are from different parts of the country carrying on trade here.

CUMBERLAND, a township of Rhode Island, U. S., on Blackstone River, and Providence and Worcester Railway, 10 miles north of Providence, containing extensive manufactories of iron, machinery, cotton, boots and shoes, &c. Pop. (1870) 3882.

CUMBERLAND, a city of Maryland, U. S., on the left bank of the Potomac River, at the foot of the Alleghanies, the eastern terminus of the National Road, and the western of the Chesapeake and Ohio Canal, 179 miles west-by-north from Baltimore. C. is a station on the Baltimore and Ohio Railway. It contains county buildings, 8 churches, 3 newspapers, flour-mills, &c. The C. semi-bituminous coal is supplied from this region. Pop. (1870) 8056.

CURTIUS, ERNEST, a distinguished German philologist and antiquary, born September 2, 1814, at Lübeck. After a good preliminary education at the High School of that place, he attended several German universities (Bonn, Göttingen, and Berlin) as a student of philology. In further pursuance of the path he had chosen—viz., the investigation of Greek antiquity—he went (1837), in company with Professor Brandis, to Athens, where he stayed several years. When his teacher, O. Müller (q. v.), came to Athens, C. accompanied him in his travels through Greece. On the death of Müller at Athens, in 1840, C. returned to Germany, visiting many places in Italy by the way. He graduated in Halle, and after he had taught for some time at two Berlin gymnasia, he received an extraordinary professorship at the university of that place. His *Ancedota Delphica Inscriptiones Attica Duodecim*, and *The Akropolis of Athens*, were published about this time. In 1844, he was called to the honourable position of tutor to the present Crown-prince of Prussia. Six

months before he was made Ordinary Professor at Berlin, and permanent Secretary of the Academy of Sciences. In 1874 he was sent by the German government to negotiate a treaty with the Greeks, to permit its undertaking those important excavations at Olympia begun in 1875. His principal works are *Peloponnesos* (1852), a description of the country of Greece, with reference to its traditions, history, and monuments; *Attic Studies* (1864); and a *History of Greece*, which has been translated into English by A. W. Ward (1868—1876).

CURTIUS, GEORG, a distinguished classical scholar, the brother of the former, who has acquired a high reputation for the light he has thrown on the Greek and Latin languages, by applying to them the comparative method. Born April 16, 1820, at Lübeck, he studied at Berlin and Bonn. After a short activity at Berlin, and a longer stay at Prague and Kiel universities, he accepted (1862) the Professorship of Classical Philology at Leipzig. Of his published works are to be noted, *De Nominum Græcorum Formatione* (Berl. 1842); *Die Sprachvergleichung in ihrem Verhältnis zur Classischen Philologie* (Dresd. 1845); *Sprachvergleichende Beiträge zur Gr. und Lat. Gram.* (Berl. 1846); *De Nominum Homerici* (Kiel, 1855). His *Griech. Schulgrammatik* (11th ed., 1875) is in high repute, and his *Grundzüge der Griech. Etymologie* (Leipzig, 1862) is a most valuable contribution to that department of philology.

CURUKU OIL, or BRAHMADU'NDU OIL, a pale yellow, limpid oil, obtained in large quantities in India from the seeds of the *Argemone* (q. v.) *Mexicana*, or Prickly Poppy, a plant accidentally introduced, but which now flourishes luxuriantly in all parts of India. It is used for lamps, and for other purposes, but possesses properties which render it unfit for food.

CUTTEAMU'NDU, the juice of the *Euphorbia Cullimundu*, a species of Spurge (q. v.), a native of India, particularly of the Northern Circars. It is used for cementing iron with other substances, as for uniting the blade and handle of a knife. The fresh juice is used as a vesicant. In a dried state, it is capable of being moulded into any form, and a great variety of articles may be made of it, as of gutta percha. A medal was awarded to Mr Elliot at the London Exhibition of 1851, for the introduction of this interesting substance to notice.

CYBIUM, a genus of fishes of the family *Scomberidae* (q. v.), having a long first dorsal, detached finlets, an elongated body, a keeled tail, no pectoral cuirass, and no armature on the lateral line, compressed trenchant teeth in the jaws, and very numerous villiform teeth in other parts of the mouth. A number of species are natives of the seas of the East Indies, some of which are much esteemed for the table; and one species, *C. Commer-soni*, is used in a dried as well as in a fresh state; and in a dried state is, to some extent, an article of commerce in India.

## D



**DAE'T**, a town of the island of Luzon, Philippines, situated on a river of the same name, which falls into the Bay of San Miguel on the eastern side of the island. Some of the houses are built of stone and some of nipa palm. Pop. 7702.

**DA'LIAS**, a town of Andalusia, Spain, in the province of Almeria, and 18 miles west-south-west from Almeria, about nine miles from the Mediterranean, on a small river, which is navigable for boats up to the town. The immediate neighbourhood is a dreary sandy plain; but not far off are mountains containing lead and antimony mines, which afford employment to many of the inhabitants of the town. Husbandry and fishing are the other principal occupations. The streets are mostly irregular, and the town is ill built. It suffered considerably from an earthquake in 1804. Near D., on the sea-side, are mineral baths, much frequented. Pop. 9000.

**DALRY**, a town of Ayrshire, Scotland, on the Garnock, near the mouth of the Rye, 20 miles south-west of Glasgow; it is a station on the Glasgow and South-western Railway. The vale of the Garnock is naturally beautiful and fertile; but its mineral wealth in coal, lime, and iron has recently caused a great change in its aspect, and it is much disfigured by blast-furnaces, &c., and by vast heaps of refuse from mines. D. was recently a small village, but has of late rapidly increased in population and importance in consequence of the establishment of iron-works at and near it. D. possesses also a large woollen mill, which gives employment to upwards of 400 hands. Pop. (1851) 2706; (1861) 4232; (1871) 5214. It is feared that the increase in population and prosperity will not long continue, as the ironstone is being rapidly exhausted.

**DA'LTON**, a town of Furness, Lancashire, England, on a gentle acclivity, about three miles and a half from the sea, and 18 miles west-north-west from Lancaster. It is connected by railway with the railway-system in Lancashire on the one hand, and with that of Cumberland on the other. There are iron mines and foundries in the vicinity, and making is carried on, but not to so great an extent as formerly. Near the town are the ruins of Furness Abbey, founded in 1127 by Stephen, Count of Boulogne, and afterwards king of England, for monks of the Cistercian Order. Pop. of township (1871) 9310.

**DARAGU'NJ**, a town of India, in the British district of Allahabad (q. v.), on the left bank of the Ganges, opposite to Allahabad, with which it is connected by a ferry. The bed of the Ganges is here about a mile wide, two-thirds of the width being occupied in the dry season with wet sand and mud, over which the passage is difficult. Pop. 9000.

**DARJEELING**, a sanitary station of British India, in a district of the same name, in the Sikkim Himalaya. It is situated at an elevation of 7400 feet above the sea, on the side of a great hollow or basin, in which flows the Runjeet, a branch of the Teesta. Forest-covered mountains rise above it, where the rhododendrons of the Himalaya grow in great luxuriance. It commands a magnificent view of the snowy ranges of the Himalaya to the north and west. Notwithstanding frequent heavy rains, and a very great annual rainfall, the climate is very salubrious. D. is only about 36 miles from the plain of Bengal, and 308 miles north from Calcutta. It was obtained by the British government from the Rajah of Sikkim in 1835, in order to be made a sanitary station. A further portion of the territory of Sikkim was annexed to the district in 1850, in consequence of outrages committed by the rajah on British subjects. Tea culture has recently been introduced, and in 1862, there were 8762 acres under tea; in 1872, there were 55 tea plantations, extending over 52,000 acres, and employing 7300 labourers.

**DA'VENPORT**, a city of Iowa, U. S., on the right bank of the Mississippi, at the foot of the upper rapids, and opposite Rock Island, Illinois, on the Great Western route from Chicago. It is connected with Rock Island by a large iron bridge across the Mississippi with railway, carriage, and foot tracks; contains 25 churches, 3 banks, Griswold College, cotton, woollen, and other manufactories. Coal is abundant, and a large trade is carried on by rail and river. The scenery is of the finest on the North Mississippi. Pop. (1870) 20,038.

**DAWLEY MAGNA**, a town in Shropshire, 2½ miles N. by W. from the Madeley station of the Wellington and Madeley Railway. It has one church belonging to the establishment, and 7 dissenting chapels. A new market-hall was erected in 1867. The inhabitants are chiefly employed in blast-furnaces, collieries, and bar-iron mills. Pop. (1861) 6365; (1871) 11,254.

**DEAK, FRANZ**, Hungarian politician, was born in 1803 at Kehida, in the Hungarian county of Zala. Having studied law at Raab, he began to practise as an advocate in his native county, and soon became noted for his eloquence and enlightened patriotism. Elected in 1832 to the national diet, he, as leader of the liberal opposition, opposed, by legal and constitutional means, every attempt of the imperial government to infringe on the constitutional rights of his country. This firm and moderate policy enabled him to effect more than one reconciliation between Hungary and the Austrian emperor as her king—temporarily in 1840, and in 1867 more permanently. While upholding the independence of his country, he laboured for its internal improvement, promoting measures for the elevation of the peasantry, and advocating the abolition of the odious exemption from taxes enjoyed by the nobility. His views on this last point displeased

the party of the nobles, and for some years after 1840 his county did not return him to the diet. He still, however, continued to guide the councils of the moderate liberal party, and in spite of his aversion to extreme measures, he promoted the association for national defence, in the view of a possible struggle with Austria. After the revolution of March 1848, he became Minister of Justice in the cabinet of Count Batthyányi (q. v.), and had formed the project of effecting a general reform in the administration of justice in Hungary, which, however, the war rendered impossible. D. used every effort to ward off the war, and came to an arrangement with Austria. On Kossuth's coming into power (September 17, 1849), D. resigned his portfolio, and retained only his place in the diet. In the last months of 1849, at the approach of Prince Windischgrätz, he proposed to sue for peace, and was one of the deputies sent for this purpose to the Austrian general. It is well known that that step failed, and that D. was even for some time a prisoner at Pesth; he then withdrew from public affairs, and retired to his estate. When the Hungarian revolution was suppressed, he refused the invitation sent him by M. de Schmerling, Minister of Justice at Vienna, to take part in the legislative conferences, as he disapproved of the Austrian policy with regard to Hungary. He did not return to public life till 1860, when a constitution was granted to his country.

On hearing of the arrest of Count Ladislas Téliški, D. set out for Vienna with M. Eötvös, and procured the release of his countryman, as well as the promise of an independent Hungarian ministry. Returned by the city of Pesth to the diet in 1861, he became in it the leader of the moderate party, at the same time that the extreme party collected round Count Téliški. The death of the latter (8th May) destroyed the only influence which could counterbalance that of D.; and the diet appointed him to draw up the address to the emperor. D. demanded, in that paper, the constitution of 1848, a Hungarian ministry resident in Pesth, the return, without restriction, of the exiles, and the restitution of their property. Rejected at first by the emperor, this address was again drawn up with some modifications in the details; the emperor answered it by a rescript which with difficulty dissimulated his repugnance to such an arrangement; and in his turn, D., in name of the diet, protested publicly against the imperial rescript. On the 23d, the emperor pronounced the dissolution of the Hungarian Diet, which protested anew, under the direction of D., against the illegality of the measure which dispersed them. Among the events consequent on the war between Austria and Prussia in 1866, was the final triumph of D.'s policy in the establishment of a constitutional relation between Hungary and Austria. At a general election in 1869, the results of which were favourable to his policy, D. was, by an overwhelming majority, returned again for the city of Pesth. D. died in 1876. His funeral was a truly national event, and was attended by every Hungarian of note.

**DEBTS, RECOVERY OF.** Courts of law, besides serving to decide cases in which questions of fact or law are really in dispute, serve an important purpose in facilitating the recovery of debts, against which the debtor has no defence other than that he is unable, or unwilling, to pay. The great majority of the cases in which the services of courts are required is of this kind. The statistics of the English county courts give a striking illustration of this. Of the number of cases which are entered for judgment, it appears that about 95 per cent. end in favour of the plaintiff; whereas, had there been any question really in dispute, the defendants, with the advantages they

possess, might have been expected to be at least as often right as the plaintiffs. The knowledge of this has had much to do with modifying judicial proceedings. Another cause which has operated in the same direction is, that the consequences of issuing a decree are now much less serious, as a creditor holding a judgment has not now the exorbitant powers over his debtor that he once had. The theory, accordingly, on which judicial proceedings are based, has very much changed. Formerly, lawyers thought that every case should come into court, prepared for being disputed on every point, and thus a great deal of expense was incurred before it was known whether there was to be any dispute at all. The end now in view is, that there should be a cheap means of obtaining judgment in undisputed cases; and that, at the same time, every precaution should be taken, that if the defender has any good ground of defence, he should have the opportunity of stating it; and that, when stated, it should receive due attention. Various law reforms have been carried to facilitate the recovery of debts with this end tacitly, at least, in view. In England, as might have been expected from the courts of law being situated in a great commercial capital, law reform has proceeded further in this direction than in Scotland; but in both countries, it has made great progress.

Understanding by debt the price of services rendered, or goods furnished, it may be useful to point out shortly the proceedings that must be taken to recover it. If the debt exceed £50 in amount, the creditor must, in England, proceed in one of the superior courts of law; and, in Scotland, he may proceed either before the superior court or before one of the sheriff-courts; but in any view, he must prepare for considerable expense—the services of professional advisers being in practice unavoidable—and for a mere or less tedious litigation. If the debt do not exceed £50, the creditor may proceed in the English or Scotch county courts (in Scotland called the sheriff-courts), and the proceedings are simple and expeditious.

In England, the first step to recover a debt not exceeding £50 in the county court, is for the creditor to go to the registrar of the district within which the defender resides, or to the jurisdiction of which he is on some other ground amenable (30 and 31 Vict. c. 142\*). He there fills up a printed form, called a *plaint*, shortly stating the claim and the ground of it. The registrar upon this issues a summons, and gives it to the bailiff of the court, who serves a copy of it on the defendant. This summons names a day on which the parties must appear before the judge. No written pleadings are in general necessary; but if the debtor has any special defence—such as, that he has a counter-claim against the plaintiff, or that he (the defendant) was a minor at the time the debt was contracted, or that he has been discharged under the bankruptcy acts—he must give the creditor notice in writing five days before the hearing. If he simply denies the debt, he has nothing to do but to attend the hearing, with what witnesses he may require. If the witnesses are not likely to come voluntarily, summonses to enforce their attendance (as well as the production of documents) may be obtained at the registrar's office. At the hearing, the judge (unless a jury have been required) proceeds himself in a summary way to try the cause. He examines the witnesses on oath, keeping no record of the evidence; and, on hearing the parties,

\* This act contains a schedule enumerating the statutes regulating proceedings in the English county courts.

gives judgment at once. If he decides for the plaintiff, he may make the sum payable at once, or by instalments. The costs are according to a fixed scale, which may be seen in the court or in the registrar's office.

There are provisions for parties having their case tried by jury, and also for appeal on questions of law. Either party who wishes it, may ask for a jury; and if the sum claimed exceed £5, the demand must be complied with. If there be a jury, the number of jurymen is five, and their verdict must be unanimous. The party dissatisfied with the verdict may ask for a new trial, and the judge, if he thinks right, may grant it on such terms as he thinks reasonable. This power to try by jury is used very rarely indeed—less than one per cent. of all the cases which go to trial being tried in that manner. The right to appeal is against decisions in point of law, and against the admission and rejection of evidence. The appeal is to the superior courts of law at Westminster. It is taken by requiring the judge to state a case for the opinion of the higher court, and thereafter entering it for discussion there. The appellant must give security for the costs of the appeal, and (if defendant) for the amount (both of principal and costs) contained in the judgment. The right of appeal is not much exercised, and the parties have it in their power to agree beforehand (in writing) that there is to be none.

When judgment is for the creditor, and the order for payment is not complied with, execution may issue against the goods of the debtor. Although imprisonment for debt was (in the general case) abolished in England in 1869, it still remains the law that in the county courts, in certain cases, the debtor may also be imprisoned. The debtor is summoned to shew cause why he has not obeyed the judgment. At this hearing (whether the debtor attend or not), the creditor may get an order to commit, if he can shew to the judge's satisfaction that the debtor obtained credit on false pretences, or by fraud, or that he wilfully incurred the debt without a reasonable expectation of being able to pay it, or if he have made away with or concealed any of his property to defraud his creditors, or if he has had, since the judgment, sufficient means to pay it without defrauding other creditors, and has refused to do so. Imprisonment for debt is no longer in the option of the creditor, as it was before 1869; the power is reposed in the discretion of a judge, and can be exercised only on proof that the defaulter has the means, and refuses to pay.

Although it is competent to proceed in the county courts for sums as large as £50, they are not much used for sums above £20. When the debt does not exceed £20, there is a certain compulsitor on the creditor to resort to the county court, for if he resort to a superior court, and recover no more than that sum, he will have no costs, unless he satisfies the court that he had sufficient reason for taking that course. In point of fact, there is only about one case for a sum exceeding £20, for a hundred which do not exceed it; and the average amount sued for is between £2 and £3.

In *Scotland*, debts not exceeding £12 may be recovered in the Sheriff Small-debt Court. The creditor takes two copies of his account to the office of the sheriff-clerk for the circuit in which the debtor lives; from him he obtains a summons, in which the day for the trial is fixed; and this summons he takes to an officer of the court (sheriff-officer), who serves a notice, with one of the copies of the account, on the debtor, at least six days before the trial. Both parties may employ an officer to cite such witnesses as they require. The creditor must appear at the trial, either by himself or by one of

his family, or by such other person as the sheriff may permit. Law-agents require special permission to appear, unless where both parties consent. If the defender intend to plead a counter-claim, he must cause a sheriff-officer to give a copy of it to the pursuer, at least one free day before the trial; otherwise, there are no written pleadings. On the day fixed for the trial, if the debtor does not appear, decree is given against him, with expenses, as a matter of course; against which he can afterwards be 'reponed' only on consignment of the expenses and a sum of 10s. If both parties appear, the judge hears the case. If the pursuer or the defender have clearly no good ground of action or defence, he disposes of it at once; but if not, he examines the witnesses on oath. No record of the evidence is taken. At any time before judgment, the case may be remitted to the 'ordinary court' of the sheriff, where it is conducted by agents on written pleadings and written proof. Otherwise, the whole proceedings are concluded in one day, adjournments not being permitted, except in special cases. After judgment, there is no appeal, except on the ground of want of jurisdiction, malice, oppression, or wilful neglect of the statutory forms, in which cases there is an appeal to the Court of Justiciary. If the sum decreed for, together with the expenses, do not exceed £8, 6s. 8d., there is only execution against the debtor's goods; above that amount, there is also execution against the person.

The Debts Recovery Act, 1867 (30 and 31 Vict. c. 96), has extended the Scottish small-debt jurisdiction, with important alterations, to £50. The class of debts that may be sued for between £12 and £50, has been limited to those which most require summary proceedings—namely, those which prescribe if not sued for within three years, such as all ordinary merchants' accounts, and accounts for professional services or for servants' wages. The principal differences between this and the proper small-debt proceedings are, that agents are allowed to appear; that there are two days in court, one at which the grounds of action and defence are stated, and an adjourned one, at which the witnesses are examined; that the judge makes a note of the pleas of the parties; that a record is kept (if required) of the admissions in fact and of the evidence; and that there is a right of appeal, if the debt does not exceed £25, from the sheriff-substitute to the sheriff, and if it exceed £25, also to the Court of Session. If the judge be not asked to take a note of the evidence, there is no appeal in matters of fact. All the fees and costs, whether payable to the sheriff-clerk, the officers of the court, or the law-agents, are distinctly stated in the act, and must be hung up in every court. In other respects, the proceedings are analogous to those in the Small-debt Court, and, like them, may proceed either at the principal town of the county, or at one of the towns at which sheriff's circuit-courts are held.

In England and in Scotland, there are other courts which deal with the recovery of debts beside the county courts. The Sheriff's Court of the city of London has a jurisdiction similar in general to that of the English county courts; and there are local courts, such as the Court of Passage at Liverpool, and the Manor Court at Bradford, which exercise jurisdiction in small as well as other debts. In Scotland, the magistrates of royal burghs, and the justices of peace, possess a small-debt jurisdiction for debts not exceeding £5 in amount. The procedure in them is similar to that of the Sheriff Small-debt Court.

DECAMPS, ALEXANDRE-GABRIEL, a celebrated French painter, was born at Paris in 1803. He was

cannot be made to imitate approved models, and he soon began to strike out a style of his own, which was new to the public, and was long in becoming popular. About 1830 he made a tour in the East, which had a considerable effect upon the character of his works. For several years after his return he painted chiefly Eastern subjects. Either the novelty of his subjects—Eastern scenes and customs being then comparatively unfamiliar to Europeans—or the novelties of his manner, made the public hesitate in its verdict upon these works; while they were not unfrequently rejected by the jury at the Academy of Paintings. Gradually, however, they grew into favour; and the prices fetched by these and the other works of D. shew that he is now among the most esteemed of the artists of his time. He painted landscapes, genre-pieces, and historical pictures; but though he has produced works in each of these kinds which are of the highest order of merit, his animal pictures are those which first attained to popularity among his countrymen. D. had a great deal of humour; and he loved to paint animals of all kinds. The monkey was his specialty; and a series of humorous pictures in which the monkey, or groups of monkeys, are introduced—now widely known by engravings or lithographs—were among his best and most popular works. In one of this series, *Les Singes Experts*, he managed to convey a stinging criticism upon the judges at the Academy who were so slow to admit his merit as an artist. Successful as he was in animal painting, D. was much chagrined by the preference shewn by the public for his genre over his historical pieces—which, by English critics at least, are now considered among the finest productions of the French school. Of his landscapes, and even of his historical works, the majority are taken from Eastern subjects. It was perhaps a consequence of the tardy recognition given to him by critics and other authorities, that not more than one of his pictures is now in a public collection in France. His works are in private hands; but at the Exposition Universelle of 1855, sixty of them were brought together, and an opportunity was thus afforded of comparing them with the more accessible works of other contemporary painters. His pictures divided attention with those of Ingres, Delacroix, and Vernet, and received the award of a medal. D. was made a chevalier of the Legion of Honour in 1839, and was promoted to the grade of officer in 1851. He died at Fontainebleau on the 22d of August 1860, of injuries which he sustained by falling from his horse.

Humour, as has been indicated already, was one of the principal characteristics of D.'s most popular works. His really great—his historical—works were remarkable for the fineness, in many cases the grandness, of the conceptions, and for a large and free style of treatment deemed over-daring and irregular by connoisseurs, but usually resulting, nevertheless, in a very impressive *tout ensemble*. Undoubtedly, his execution had considerable faults, but they were closely associated with its merits. His drawing was often careless, and when some favourite effect was to be produced, he never hesitated to set perspective at defiance. The boldness of his colouring, and the startling light-effects introduced in his pictures, were what critics at first found most fault with. These are, however, the peculiarities of his manner, and now that they are no longer strange, they find not only apologists but admirers. If they were merits, they were of a kind which, in the hands of imitators, were very apt to

reproduction of their master.

DE'CTAUN, a town of India, in a detached portion of the native state of Gwalior, belonging to Scindia, on the route from Mow to Baroda, twenty miles west from Mow. It is the capital of a pergunnah of the same name. It is 1881 feet above the sea. Pop. estimated at 6000.

DELFTSHA'VEN, an old town in South Holland, is situated on the Maas, two miles west from Rotterdam. It is defended from floods by three strong dykes. The principal buildings are the Reformed Church, which is a handsome cruciform building, the Roman Catholic Church, and the town-house. There is some trade and shipping; but the chief sources of wealth are distilling spirits, beer-brewing, iron-founding, ship-building, sawing wood, refining sugar, &c. Pop. (1875) 9440.

DELIRIUM EBRIOSUM, a term intended to denote a form of acute mania, having intoxication for its exciting cause. It is often mistaken for Delirium Tremens (q. v.), and doubtless has frequently been dealt with as such in criminal cases. It originates either from a single fit of intoxication, or a short course of intemperance—frequently of periodical occurrence—in those who are mentally excitable from hereditary peculiarity of constitution, or from some previous injury of the head, and who may have experienced some cause for depression of spirits. It is marked by an uncontrollable desire for drink, which, when gratified, only leads to further imperious demands, until the thing itself is loathed, and a fit of sickness brings about recovery. In the course of the paroxysm, however, more or less of indecorous conduct or wild and vicious passions are displayed; so that, unless the affected is restrained, and stimulants withdrawn, violence is apt to be offered to any one coming in the way. It is in this state that homicide and murder are so frequently perpetrated. On the delicate question of legal responsibility connected with this state, we do not here enter.

DELIRIUM NERVO'SUM or TRAUMATI-CUM, a term given by Baron Dupuytren, the celebrated French surgeon, to designate an attack of delirium with tremors, which frequently supervenes on severe bodily injuries, such as gunshot wounds, burns, and fractures—chiefly met with in large hospitals—in the case of persons of weakly constitution, and who are irritable and nervous, and have been intemperate in their habits. It has been considered by some as identical with Delirium Tremens (q. v.), but it only simulates that affection, being but a symptom of a sympathetic fever, having a typhoid character.

DELIRIUM TREMENS is the term given to a disease originating from the abuse of alcoholic stimulants by those of a nervous and irritable temperament, characterised by a combination of delirium with muscular tremors. The tremors are general, but chiefly of the hands, and of the tongue when protruded; and the delirium is of a muttering, sight-seeing, bustling, abrupt, anxious, apprehensive kind. The individual affected cannot follow out a train of thought, explain an illusion or perverted sensation, or perform any act correctly; and although at one moment partially conscious and rational, is the next incoherent and excited by the most ridiculous fancies of a spectral kind, such as visitors in the shape of devils, cats, rats, and snakes, or by alarming occurrences, such as robberies, fires, and pursuits for crimes. All this is ushered in and

attended by complete sleeplessness; and during the attack, in an uncomplicated form, there is no violence or ferocity of demeanour (see article DELIRIUM EBRIOSUM), although mischief to himself or others may be done under false impressions; and he is easily pleased by gentleness and indulgence, and fretted by restraint and opposition. The face has generally a pale dirty colour, and anxious expression; eyes startled but lustreless, sometimes considerably suffused, and the pupils not contracted, unless under treatment with opium, or when inflammation of the membranes of the brain has supervened; skin warm and moist, often perspiring copiously; tongue sometimes loaded, but generally pale, moist, and remarkably clean; appetite small, but the individual will often take whatever is presented to him; thirst by no means urgent, with seldom or never any craving for spirituous liquors; alvine evacuations bilious and offensive; urine scanty, high coloured, and often albuminous; the pulse usually ranges from 90 to 120, and is generally soft, but of various degrees of fullness and smallness. The precursory symptoms are not peculiar to or pathognomonic of this disease, but common to many other febrile affections implicating the functions of the sensorium, of the circulation, of digestion; and the paroxysm—distinguished by the above phenomena—runs a remarkably uniform course, independently of age and constitution. In genuine uncomplicated cases—that is to say, when not precipitated by other illness, such as bronchitis, pneumonia, erysipelas, and fever; or some accident, such as contusions and fractures—when the illness is more of the nature of the Delirium Traumaticum (q. v.)—the paroxysm runs its course in from two to three days, and terminates in sleep, from which the individual generally awakens convalescent.

The above description has been taken from a paper by Dr Peddie of Edinburgh, referred to underneath, whose views shall here be further developed. Previous to its publication, the generally received opinions regarding the essential nature of delirium tremens were, that it is a disease of exhaustion or irritation of nervous power, and that it has the habitual abuse of intoxicating liquors for its predisposing, and the abstraction or diminution of the accustomed stimuli for its exciting, cause; and consequently, that the proper treatment consists in the continuation of stimulants—'a hair of the dog that bit'—together with large opiates to act on the same principle, and force on the salutary, or what has been called the critical sleep. Since then, however, a great revolution has taken place in the views of the medical profession regarding the pathology and treatment of delirium tremens; and in consequence of this, a fatal result in a genuine case of the disease now seldom or never occurs, where these views are understood and acted on.

It has been shewn that the more the history and phenomena of the affection are examined, the greater will the difficulties surrounding the second part of the proposition above stated become. It has been shewn that the affection is specific and peculiar, uniform in its symptoms and progress; and that it is essentially a form of nervous poisoning—a toxicological result from the accumulation of alcohol in the system through the continued abuse of stimulants. It has been observed that the alcohol—in whatever way it may be atomically changed or chemically combined—acts on the nervous pulp of the brain through the medium of the circulation, and sets up in it an alcoholism or alcoholic erethism, manifested by a certain amount and kind of exhaustion of the cerebral and muscular functions, together with decided over-action in the meningeal vessels; and that the alcoholic principle, although

acting at first slowly, begins ere long to poison the gray matter of the brain, so that every additional drop thereafter brings it more and more into a poisoned condition, until at length, unless arrested by judicious treatment, the state of irritation tends to inflammatory action and serious encephalic mischief. While, therefore, the first part of the above proposition is true—though explainable in a very different way from formerly received opinions—the second part, viz., that the diminution or abstraction of the accustomed stimulus, is the exciting cause of the disease, is altogether untenable. Analogy will not bear out the assertion. Mercurial fumes, or the oxides of mercury, when long inhaled or absorbed into the body, as in the case of quicksilver miners, gilders, and others, in the course of time produce an attack of shaking paralysis—the *tremblement mercuriel* of the French pathologists; but will the workmen thus long exposed be more likely to become affected with tremors when removed from this poisonous atmosphere and occupation, than if continuing at their work? The reverse is well known to be the fact, not only in the case of such artisans, but of those who are beginning to suffer in a somewhat similar way from lead-poisoning. In both affections, when the symptoms are precursory or recent, a cure can be effected only by removal from the injurious occupation; otherwise, the symptoms deepen with hourly increasing rapidity, until tremors are succeeded by sleeplessness, delirium, and ultimately coma. Then, too, for example, salivation from any of the preparations of mercury, and narcotism from any opiate, are not intensified by withdrawing these agents after a certain point is reached. On the contrary, a continuation beyond that stage, particularly in some kinds of constitution, more rapidly develops their peculiar physiological manifestations; and now, an infinitesimal dose will do what a large dose in an earlier stage could not. Thus is it with alcoholic stimulants in the production of delirium tremens. In those of a highly sanguine temperament, and of a nervous irritable disposition, the effect of a certain length of indulgence is to induce this condition (just as in subjects with the tendency to gout, a certain amount of high-living is apt to produce an attack of that affection), and beyond that stage, a small quantity of alcoholic stimulus will keep up and deepen the effect, which, previously, a large dose would not do, or, in another individual, could not produce, whatever quantity is imbibed. Thus is explainable the very common erroneous statement made in regard to an individual affected with delirium tremens; that although for a considerable time he had systematically indulged in considerable quantities of spirits, wine, or malt liquor, or in all of these, yet for a week or two he had drunk very sparingly, and, within the last few days, little or none; indeed, that he was now suffering from the withdrawal of his wonted stimulus, in meritorious efforts to free himself from a habit of which he had begun to be ashamed. All this seems plausible: but the statement should rather have been that, although consuming large quantities of drink at one time, he had felt latterly a smaller quantity affect him; that he then reduced still further the amount, but experienced an equal if not greater constitutional effect therefrom; and thus, from day to day, reduction was forced on him by his own sensations of gastric irritation, nervous excitement, and muscular debility—these feelings being, in fact, neither more nor less than the premonitory symptoms of an attack of delirium tremens, and just what might be looked for on the view that the alcoholic principle is in such instances a cumulative poison, and the exciting as well as the predisposing cause of the

any time followed by symptoms of delirium tremens, this is not to be regarded as the result of the change in the practice of the individual, but as occurring in spite of it, and because the constitutional effect is already produced, and the premonitory stage of the disease begun. In a considerable number of instances, drink is taken freely up to the period when the disease is developed, there being no diminution of the quantity consumed, and no interval in the practice; and when there really is some diminution from the amount of previous supplies, it is on account of the system being already affected so much that a less quantity now produces a greater or equal effect. On the other hand, it may be safely averred, in contradiction to the popular error, that although stimulants are at once taken away from the habitual dram-drinker, a paroxysm of delirium tremens will not be produced if the peculiar diathesis is not yet established, and the precursory symptoms of the disease are not already begun. He may experience much mental disquietude and physical discomfort, and feel weak for a time, just as a gourmand would feel lowered and depressed by the abstraction of his accustomed good living; but this would soon pass off, without the occurrence of the usual signs of delirium tremens, more especially without those spectral illusions or phantasms, which are common to poisonings with several other agents of the narcotico-acrid class.

It seems unnecessary to add more on this part of the subject, than that experience derived from some of our large prison-establishments shows that while fully three-fourths of the criminals committed belong to the intemperate classes, and a large number, especially of the debtor class, are habitual drinkers up to the moment of admission, no bad effects are observed from the sudden withdrawal of the wanted stimuli, and the substitution of prison-fare.

In regard to the treatment of this remarkable disease, it is evident, from a common-sense consideration of its phenomena and pathology, that the non-stimulating and non-opiate plan must be the safest and best. If more spirits deepen the paroxysm, by producing greater cerebral determination, then why administer even one drop additional? And if opiates combined with spirits, or given alone, act in the same manner, and tend to occasion congestion in the blood-vessels of the brain, why run the risk of inflammation, convulsions, and coma, in an endeavour to force on the salutary sleep? It must not be overlooked that this sleep is the normal termination of the paroxysm, and is not to be viewed as a part of the affection, or in the same light as we are accustomed to regard a critical sweat or other discharge. It indicates diminished activity of the cerebral circulation and functions, and the commencement of convalescence. Hence, in a large proportion of instances, the sleep will take place spontaneously, and it will be safer to do nothing at all. The object, therefore, of treatment should rather be to remove all hindrances to sleep than to force it. In the more severe cases, this is best done by a moderate and well-regulated course of tartrate of antimony, the action of which, in this affection, appears to be remarkably sedative. It greatly diminishes excited action, induces weariness of muscle, general nervous exhaustion, and mental languor. It thus removes all obstacles to the occurrence of the salutary sleep, and favours it; and when the individual exhausted seeks his couch, he finds repose—not as a drugged sleep, but naturally and profoundly—awaking in general with restored reason and muscular control.

milder cases, however, no medicine is required, and it seems enough to do in such, what is essentially necessary in the severer attacks—to support the strength—the organic functions of life—by suitable nourishment, such as soups, *cafés au lait*, and white-of-egg, and to soothe in every possible manner the excited feelings of the patient. Nothing is more hurtful in delirium tremens than restraint, particularly that of the strait-waistcoat. It increases the cerebral excitement by the never-ceasing struggles for liberty which ensue, so that fatal convulsions have very frequently been the result. All the control required is the presence of one or two judicious attendants, who will humour the patient in his whims and fancies; who will speak and act regarding them so as to assure him of safety, and to relieve him of that apprehension which is the most characteristic feature of the delirium; and who will mildly but firmly interpose, if he attempts anything which may accidentally prove injurious to himself or others. The apartment, however, in which the patient is confined should be well secured, for he may rush out at the door, or leap from a window, in the fright and frenzy of imagined danger. The larger, too, the room is, the better, that he may have space to advance and retreat, according as he wishes to scrutinise or avoid a suspicious or distressing object of his fancy; to arrange and rearrange the furniture; or to carry on, after a fashion, the imaginary duties of some bustling occupation. Besides this, there should be abundance of light, so as to dissipate terrifying hallucinations. The expenditure of muscular effort without any restraint, aids greatly in producing a safe kind of mental and physical exhaustion; and the individual, languid and worn-out, lies down voluntarily, and falls into the desired and restorative sleep.—*The Pathology of Delirium Tremens, and its Treatment without Stimulants or Opiates*, by A. Peddie, M.D., F.R.C.P.E., &c., pp. 61, 8vo. (Sutherland and Knox, Edinburgh.)

DE'LITZSCH, a town of Prussian Saxony, 15 miles north from Leipzig, with which it is connected by railway, on the right bank of the Lobber, a small river. It is an old but well-built town, and has manufactures of tobacco, woollen cloth, and hosiery. It is the capital of a circle, for the most part flat, but producing much corn and fruit. Pop. (1871) 8112.

DE'LLYS, a seaport town of Algeria, 49 miles east from Algiers. The French part of the town has wide streets, and a square planted with trees. The Arab part, which is greatly more populous, retains its old character: its streets are narrow and tortuous. The climate of D. is reckoned very salubrious. The vine and the olive succeed well in the neighbourhood. *Bechena*, a kind of sorghum or durra, is grown. There is a trade in grain, oil, and salt. Pop. 10,484, of whom 862 are Europeans.

DELPHINORHYNCHUS, a genus of *cetacea* of the family *Delphinidae*, having one dorsal fin like the true dolphins, but the beak not distinguished from the forehead by a furrow. *D. Bradanensis*, or *D. rostratus*, a species about eight feet long, black above and reddish below, has been thrown ashore on the French Atlantic coast. A much larger species, *D. coronatus*, attaining the length of thirty to thirty-six feet, is described as one of the whales of high northern latitudes, having been seen in numerous flocks among the ice-islands near Spitzbergen.

DELUNDUNG (*Prionodon javellus*), a carnivorous animal inhabiting the forests of Java, referred





Delundung (*Prionodon gracilis*).

slender form, with a long cylindrical tail, and is prettily streaked and spotted.

**DEMAVEND, MOUNT**, an extinct volcano of Persia. It forms the loftiest peak of the Elburz Chain, which separates the low shores of the Caspian Sea from the high table-land of Persia. Although no longer subject to eruptions, D. bears traces of its having been an active volcano within the most recent geological epoch. Its summit is conical, covered with sulphur, and rent by heated fissures. The crater is still visible, and the surface of the mountain is in many places covered with scoria. At its base hot springs give evidence of the continued existence of volcanic fire at no great distance beneath the surface. A great deposit of sulphur covers the summit of D., and is brought down to the plains in bags to be disposed of as an article of commerce. Although the path that leads to the peak is, for this reason, familiar to the inhabitants of the adjoining districts, the mountain was not ascended by any European till 1837. In September of that year Mr William T. Thomson of the English Embassy at Teheran, with the view of taking important bearings from a point which commands an extensive view of the shores of the Caspian, determined to reach the summit. He set out from the base with four guides, three of whom deserted him when they experienced the effect of the rarified atmosphere on their breathing. The first night he slept below the snow limit; the second night in a sulphur cavern near the summit, so highly heated that it was impossible to place the hand near a crevice of the interior. On leaving this place of shelter, the traveller's wet clothes were instantly frozen with a bitter blast from the Caspian. The height, as recently determined by the Russian Survey, is 21,000 feet.

D. towers high above the neighbouring mountains, the adjacent summits not exceeding two-thirds of its elevation. At all times it has been a conspicuous object from the great trade route between India and the West, along the edge of the Persian table-land. It is not then to be wondered at that it is connected with the earliest Persian as Etna is connected with the earliest Greek traditions. There seems indeed more than an accidental coincidence between the fables which relate to the two mountains. According to the Greeks, the giant Typhon was buried under the volcanic region of Sicily, and the earthquakes and eruptions were caused by his efforts to escape. Fire proceeded from his mouth, and he was figured with one hundred snakes growing from each shoulder. Zohak, a personification of

shoulder; and in other respects he had much in common with the Greek monster.

**DENNERY, or D'ENNERY, ADOLPHE PHILIPPE**, a French dramatic writer of Jewish extraction, was born at Paris on June 17, 1811. His first employment was that of clerk to a notary; he gave that up to become a painter; and afterwards, while still very young, he became a contributor to the newspapers. The first dramatic work in which he had a hand was brought out in 1831; this was *Emile, ou le Fils d'un Pair de France*, and it was produced by him in concert with M. Charles Desmoy, a well-known *littérateur* and theatrical critic. It had some success, and D. followed it up with two or three others, which had so much popularity that his services as a play-writer came into considerable demand. He was a ready writer, and always able to come up to a fair standard of merit; and encouraged by the theatrical managers of France, he has been one of the most prolific of dramatic authors. He has produced, by himself or in concert with others, about 200 pieces in one style or another; and a few years ago, five of his pieces were to be seen upon the Parisian stage at one time. Latterly, D. has been a man of business as well as an author. He was appointed director of the Théâtre Historique in 1850, but resigned this appointment almost immediately. An attempt which he made in 1855 to establish a new theatre, which he first proposed to call the Théâtre du Peuple, and afterwards the Théâtre du Prince Impérial, did not succeed; but since that, he has had a large share in establishing and in managing a public company, in which many persons connected with the press and with the theatres were concerned—the Société Thermale de Cabourg-Dives. Of this company, whose speculation consisted in developing the attractions of a new watering-place (in the dep. of Calvados), he has been successively secretary and managing director. D. was decorated with the Legion of Honour on the 10th December 1849, and was promoted to the rank of officer on the 16th of August 1859.

**DENTARIA**, a genus of plants of the natural order *Cruciferae*, having a lanceolate compressed silique. One species only, *D. bulbifera*, is found in Britain, and is a rare plant, with a simple stem, the lower leaves pinnate, the upper leaves simple, and rose-coloured flowers, the axils of the leaves producing bulbs, and the creeping rhizome having tooth-like knobs, whence the name D., and the English name Coral-root. The root, when dried, is said to have greater pungency than pellitory of Spain, and was formerly used in the same way for toothache. *D. diphylla*, a North American species, is called Pepper-root from the same property.

**DEOBUND**, a town of India, in the British district of Saharunpore, North-west Provinces, 20 miles S.E. from Saharunpore, on the railway route from Saharunpore to Mozuffurnuggur. It is situated between the rivers Hindun and Kali Nuddee, the one a branch of the Jumna, the other of the Ganges, in an open cultivated country.  $\frac{1}{2}$  Pop. (1872) 19,168.

**DERA'YEH, or DEREY'EYAH**, a town of Arabia, formerly the capital of the Wahabees. It is situated near the centre of Nedjed, 430 miles north-east from Mecca. It was a town of some consequence before the time of the Wahabees, but attained its highest importance under their dominion. See WAHABIS. It was taken by Ibrahim Pasha in 1819, after a siege of seven months, and nearly destroyed. It stands in a valley about half a mile in breadth, filling the whole breadth of the valley,

estimated at more than 10,000.

**DESIO**, a town of N. Italy, province of Milan. It is a well-built town, surrounded with gardens and vineyards, and has a fine hospital. Pop. 5500.

**DEUTSCH**, EMANUEL OSCAR, was born, of Jewish parents, at Neisse in Silesia, in 1829. His education was begun by an uncle, to whom he owed his mastery of the whole range of Hebrew and Chaldee literature, and was finished at the university of Berlin. In 1855, he came to England to fill an appointment in the National Library; and from this time he was known for his labours in the British Museum, and his efforts to promote the study of the Semitic languages. He is best known to the outside world by his brilliant article on the *Talmud* in the *Quarterly Review*, to which he also furnished an article on *Islam*. He wrote excellent articles on the *Targum* and the *Samaritan Pentateuch* for Dr Smith's *Dictionary of the Bible*, and was a valued contributor to the present work, for which he wrote nearly 200 articles. The best monument of his official work in the National Library is to be found in the *Phœnician Inscriptions*, edited by Mr Vaux, to whom D. rendered most valuable assistance. D. died in 1873 at Alexandria, whither he had gone in the pursuit of health. His engrossing public duties and comparatively short life prevented D. from fulfilling the dream of his life, an elaborate work on the *Talmud*. A volume of his literary remains, with a sketch of his life, was published in 1874.

**DEWA'S**, a town of Malwa, India, 24 miles north-north-east from Indur. It is the capital of a petty state or raj under British protection, held conjointly by two chiefs of the lineage of the Puar or Pramara Rajpoots, once very powerful, although now of fallen fortune. The military force of the state consists of 175 horse and 500 foot; the pop. is about 25,000, the revenue about £40,000.

**DHO'LKA**, a town of India, in the British district of Ahmedabad, presidency of Bombay. It is surrounded by a mud wall four miles in circuit. Pop. (1871) 20,854.

**DIAPASON REGULATOR**. The French, who give the name of *diapason* to the tuning-fork, have lately made attempts to use that instrument in connection with clockwork, partly as a means of counting very small intervals of time. M. Duhamel made an arrangement in which a cylinder, by means of a screw-tapped end, was made to advance a little in the direction of the axis; this cylinder was covered with blackened paper, and was rotated by means of clockwork. A diapason had a style or marker, made of a small bit of pointed spring, fixed to the end of one of the prongs. On the diapason being sounded in the usual way, and the spring placed lightly against the cylinder, the style traced a sinuous white line on the black paper. The sinuosities became visible representatives of minute intervals of time, the prongs vibrating possibly hundreds of times in a second. M. Lissajous devised an electrical apparatus to prolong the vibrating of the prongs; but it was too complex for practical use. M. Breguet then proposed clockwork for this purpose, superseding the pendulum and the spiral spring by a diapason. The diapason regulates the rate of motion of the train of wheels by the equality of the vibration of the prongs, while the train of wheels tends to increase the time during which the prongs vibrate and sound. An index, carried by an arbor round a dial, may be made to count or record the vibrations. Breguet's experiments have gone as far as instruments giving 200 simple vibra-

tion of vibrations in a second, by mechanical treatment of the prongs: it can, by a proper distribution of metal, be made to yield any required note within certain limits; and thus, with the aid of the style, the paper, and the cylinder, it may be made to give a kind of visible existence to excessively minute intervals of time, such as  $\frac{1}{1000}$ th part of a second. Fuller details are given in Breguet's description of the apparatus in the *Revue Chronometrique*.

**DICHROISM** (Gr. *dis*, twice, *chroma*, a colour) is a term chiefly used in Crystallography to designate the property which many doubly-refracting crystals possess of exhibiting different colours, when viewed in different directions. It, or the allied term *Dichromatism*, has also been applied to those fluids which appear of different colours when viewed by reflected and refracted light; when seen in thick or thin layers, &c. For example, venous blood, or any blood impregnated with carbonic acid, hydrogen, or nitrogen, appears, when seen in moderately thin layers, to be of a purple colour; while in extremely thin layers it appears green.

**DIETERICH**, JOACHIM FREDERICK CHRISTIAN, an eminent veterinary surgeon, was born on the 1st of March 1792, at Stendal, in Prussia. In 1818, he undertook, at the instance and expense of the Prussian government, a tour through France, Württemberg, Bavaria, Austria, and Hungary. On his return, he was appointed to a chair in the Veterinary College of Berlin, which he held for four years. In 1830, he accepted a post in the General Military School of Berlin, where, in 1841, he was appointed Professor in Ordinary. His publications, which are widely known, and have been translated from the German into various languages, include *Pulmonary Consumption in Cattle* (Berlin, 1821); *Manual of Veterinary Surgery* (1822); *Manual of Special Pathology and Therapeutics for the Use of Veterinary Surgeons* (1828); *Manual of the Practical Knowledge of Horses* (1834); *Manual of Obstetrics* (1845); *Manual of the Education of Domestic Animals* (1848); *The Principal Defects of Horses, and the Mode of Diagnosing them* (1853).

**DIETRICH OF BERN**, the name under which the Ostrogoth king, Theodoric (q. v.) the Great, appears in the German heroic legends; in which by Bern, his capital, Verona, is to be understood. As early as the 7th c., he would seem to have become the centre of a distinct cycle of legends. A little later, he was, with a not unusual disregard of all historical truth, brought into connection with the traditions of Attila, or Etzel. According to these legends, D. is said to have fled from Italy before Ottacher (Odoacer), or Ermanarich; to have met, along with his attendant vassals, with a hospitable reception from Etzel; but after many years, to have again got possession of his kingdom. The extermination of the royal House of Burgundy by Attila, which is an historical event, was the cause that D., as well as Etzel himself, was woven into the Burgundian and Frankish Siegfriedsage; and thus he appears, in the second part of the *Nibelungen*, at Etzel's court, and is handled by the poet with special predilection. There have been numerous poems, besides, of which D. was the centre and principal hero. It is very probable that the *Hildebrandslied*, of the 8th c., is the fragment of such a poem. Except this, we have only late versions of these legends; for example, *Schlacht vor Raben* (Ravenna) of the 13th c., *Alphart's Tod* (13th c.), *Zwery Laurin, oder der kleine Rosengarten* (15th c.), *Diétrich's Ahnen*, *Diétrich's Flucht*, &c.

**DIKAMA'LLI**, a gum-resin which exudes, in amber-coloured transparent drops, from the ends of young shoots of *Gardenia* (q. v.) *lucida*, an Indian tree. It has a very powerful fragrance, and has been found extremely useful in hospitals, in keeping away flies, and especially as a dressing for wounds and running sores.

**DIKOWA**, or **DEEGO**, a large town of Bornu, Central Africa, about 30 m. S.W. of Lake Tchad. It is in a great cotton-growing district, and is a place of considerable trade. The spinning and weaving of cotton are also extensively carried on. The houses are mostly of clay, but each has its court-yard. Pop. supposed about 30,000.

**DIMA**, a large town of Abyssinia, in the state of Amhara, on an affluent of the Abai, 150 m. S.S.E. of Gondar. The houses are mostly of stone, and the church is one of the largest edifices in Abyssinia. The town is divided into many quarters by stone walls.

**DIMIDIA'TION**, in Heraldry, a mode of marshalling arms, adopted chiefly before quartering and impaling according to the modern practice came into use, and subsequently retained to some extent in continental though not in English heraldry. It consists in cutting two coats of arms in half by a vertical line, and uniting the dexter half of the one to the sinister half of the other. Coats of husband and wife were often so marshalled in England in the 13th and 14th centuries. Mr Planché traces the double-headed eagle of the German Empire to a dimidiated coat, with half an eagle for the eastern, and another half for the western empire.

**DINDIGU'L**, a town of India, in the British district of Madura, presidency of Madras, at the extremity of a valley of the same name, on a feeder of the Cauvery, 247 miles south-west of Madras city. It is 700 feet above the level of the sea, and built on a gentle declivity; the streets are wide, the houses well built, and the bazaar plentifully supplied. The pop. is supposed to be between 6000 and 7000, exclusive of the military. The fort is situated on a wedge-shaped mass of gneiss, which rises to a height of 280 feet, perfectly naked, except near the summit, where some stunted trees and shrubs grow on patches of thin soil. The ascent is on the eastern side by a flight of stone steps, the other sides being nearly perpendicular. Near the summit, there is a well of great depth, popularly reputed unfathomable, which yields excellent water.

**DIOCLETIANUS, VALERIUS**, born in humble life near Salona, in Dalmatia, 245 A.D., inherited from his mother, Dioclea, the name of Diocles, which he afterwards enlarged into D., and attached as a cognomen to Valerius, a name of the most patrician associations. He adopted a military career, and served with distinction under Probus and Aurelian, accompanied Carus on his Persian campaign, and finally, on the murder of Numerianus having been discovered at Chalcedon, he was proclaimed emperor in 284 by the army on its homeward march. The suspected assassin of Numerianus, the prefect Arrius Aper, he slew with his own hands, in order, it is alleged, to fulfil a prophecy communicated to him, while still a lad, by a Druidess of Gaul, that he should accede to a throne as soon as he had killed an *aper* (wild-boar). In 285, D. commenced hostilities against Carinus (the joint-emperor along with the deceased Numerianus), who, although victorious in the decisive battle that ensued, was murdered by his own officers, thus leaving to D. the undisputed supremacy. His first years of government were so molested by the incursions of barbarians, that, in order to repel their growing aggressiveness, he took to himself a colleague—namely, Maximianus—who, under the title of Augustus, became joint-emperor

in 286. D. reserved for himself the charge of the eastern empire, and gave the western to Maximian. Still the attacks of the barbarians continued as formidable as ever. The empire was menaced by the Persians in the east, by the Germans and other barbarians in the west; and in order to provide for its permanent security, D. subjected it to a still further division. In 292, Constantius Chlorus and Galerius were proclaimed as Cæsars, and the distribution of the Roman Empire was now fourfold: D. taking the East, with Nicomedia as his seat of government; Maximian, Italy and Africa, with Milan as his residence; Constantius, Britain, Gaul, and Spain, with Trèves as his headquarters; Galerius, Illyricum, and the entire valley of the Danube, with Sirmium as his imperial abode. It was upon his colleagues that most of the burden of engaging actively in hostilities fell, as D. seldom took the field in person. Among the conquests, or rather re-conquests, that were made under his rule, may be enumerated that of Britain, which, after maintaining independence under Carausius and Allectus, was, in 296, restored to the empire; that of the Persians, who were defeated, and compelled to capitulate in 298; and that of the Marcomanni, and others of the northern barbarians, who were driven beyond the Roman frontier. D., after 21 years' harassing tenure of government, desired to pass the residue of his days in tranquillity. On the 1st of May 305, accordingly, he abdicated the imperial throne at Nicomedia, and compelled his colleague, Maximian (much against the latter's will), to do likewise at Milan. D. sought retirement in his native province of Dalmatia, and for 8 years resided at Salona (see SPALATO), devoting himself to philosophic reflection, to rural recreation, and to horticultural pursuits. Two years before his abdication, he was instigated by his colleague, Galerius, to that determined and sanguinary persecution of the Christians for which his reign is chiefly memorable. He died in 313.

**DIOGENES**, the Cynic philosopher, was a native of Sinope, in Pontus, where he was born about 412 B.C. His father, Ioesias, or Icetias, by name, and a banker by occupation, was convicted of having swindled, and so the young D. had to leave Sinope. His youth had been that of a spendthrift and a rake; but on coming from Sinope to Athens, he became interested in the character of Antisthenes, by whom, however, his first advances were repelled. In spite of his inhospitable reception, D. renewed the attempt to find favour with Antisthenes; but though often driven away by blows, his perseverance at last prevailed; and Antisthenes, moved with compassion, consented to admit him as a pupil. D., from being an extravagant debauchee, plunged into the opposite extreme of austerity and self-mortification. He would roll in hot sand during the heat of summer; in winter, he would embrace a statue covered with snow. His clothing was of the coarsest, his food of the plainest. His bed was the bare ground, whether in the open street or under the porticoes. His permanent residence (if such it could be called) was a tub which belonged to the Metron, or the temple of the Mother of the Gods. His eccentric life did not, however, cost him the respect of the Athenians, who admired his contempt for comfort, and allowed him a wide latitude of comment and rebuke. Practical good was the chief aim of his philosophy; for literature and the fine arts he did not conceal his disdain. He laughed at men of letters for reading the sufferings of Ulysses, while neglecting their own; at musicians who spent in stringing their lyres the time which would have been much better employed in making their own discordant natures harmonious; at savans for gazing at the heavenly

not how to practise it. He was seized by pirates on a voyage to Ægina, and carried to Crete, where he was sold as a slave. When asked what business he was proficient in, he answered: 'To command men.' His purchaser was Xenias of Corinth; but the slave soon came to rule the master, acquired his freedom, was appointed tutor to the children, and spent his old age as one of the household. It was here that he had his interview with Alexander the Great. The king opened the conversation with: 'I am Alexander the Great,' to which the philosopher answered: 'And I am Diogenes the Cynic.' Alexander then asked him in what way he could serve him, to which D. rejoined: 'You can stand out of the sunshine.' Alexander is said to have been so struck with the Cynic's self-possession, that he went away, remarking: 'If I were not Alexander, I should be Diogenes.' In spite of his early excesses and his subsequent privations, D. lived at Corinth till 323 B. C., when he died, at the age of 90.

**DIPSOMANIA** (Gr. *dipsa*, thirst, and *mania*, madness, or eager desire) is a term intended, whether correctly or not, to denote a condition in which certain individuals manifest an irresistible craving for alcoholic drinks. **ONOMANIA** (Gr. *onos*, wine), used by German writers; and the English **DRINKING INSANITY**, are also intended to designate the same state. It is of importance to distinguish dipsomania from ordinarily intemperate and drunken individuals. In our streets and in society, we are only too familiar with the various phases of the habit and vice of drunkenness, and the different grades and circumstances of drinkers, such as the morning dram-drinker; the jolly social drinker; and the individual who, knowingly and intentionally, gives himself up to a debauch. While many thus of their own choice degrade and injure themselves, they are generally able, for a time at least, to perform tolerably well their usual occupations during business-hours. Many hard drinkers can exercise wonderful control over themselves, choosing the time to drink and the time to keep sober; and while sober, can discharge all their family, professional, social, or even religious duties—so far at least as outward appearances go. Some of them may drink continuously, until attacked by what is called *Delirium Tremens* (q. v.), or fall into the state of *Delirium Ebriosum* (q. v.); but when the supplies are stopped, and the necessary treatment is undergone, they are soon able to resume their usual duties, and too soon, in general, their former practices.

There is, however, especially in persons of a nervous and sanguine temperament and constitution—and more readily in women than in men—a condition in which the mere vice is transformed into a disease, the vicious habit into an insane, impulsive propensity, and then the drunkard becomes a dipsomaniac. The alcoholic principle, by habitual abuse, perverts the action, if not the nutrition of cerebral matter; and the frequent disturbances of the mental functions from fits of intoxication, the loose and irregular habits engendered, and the alternate states of remorse and attempts to drown conscience by more copious libations, all combine to create the dipsomaniac. He loses entire command over his will; has no power to resist the craving for alcoholic stimuli; and is transformed into the involuntary slave of an insane propensity. Physically, the dipsomaniac has a lamentably broken-down aspect; limbs feeble and tremulous; visage pale, leaden-coloured, or sodden; and eyes watery and lustreless. But in the manifestations of mind and heart, the change is still more sad. A process of mental deterioration goes on simultaneously with

the means of gratifying the craving; the precepts of morality and religion, the ties of nearest and dearest kin, have no sway over him; indeed, no consideration, human or divine, will interpose any barrier in the way of gratifying the propensity, whenever it is possible. Nor does he now drink with real relish, socially and convivially, but will swallow spirits, away from society and observation, even as it were a drug; and the only satisfaction derived from the act is, that it secures insensibility to the wretched state of mind which prompts the insatiable desire. When this has gone on for some time, although a suspension of the use of stimulants be imposed by the interference of friends, or the occurrence of an attack either of the form of delirium or maniacal excitement mentioned, yet his mind has suffered so materially, that unless control is exercised over him, and continued for a considerable period, he returns immediately like the 'dog to his vomit.' His moral feelings become more and more perverted, and his intellectual powers weakened. He is thus rendered either facile or wasteful, and incapacitated for the ordinary business of life; or he is irascible, resentful, or mischievous, and torments and annoys those about him, or commits homicide or suicide; or he becomes decidedly insane. Such is acquired dipsomania. But very frequently it is met with as a disease, *ab origine*—a constitutional, and, in the greater proportion of instances, a hereditary affection. When it takes this character, dipsomania resembles other constitutional diseases; and such cases especially illustrate its affinity to insanity. It is well known that gout and rheumatism, or disease of the heart, may be developed from errors in the mode of living of individuals in whose family connections there is no sign of predisposition; while, on the other hand, these diseases may also exist in virtue of a strong hereditary tendency, without any appreciable infringements of the laws of health. And so also dipsomania; for, while frequently resulting from acquired vicious habit, it occurs likewise from an insane hereditary taint, very frequently visited on children by the sins of their parents, especially if the latter have suffered from repeated attacks of delirium tremens, or have been in reality confirmed dipsomania. Indeed, it has even been met with in the offspring of dipsomania during the years of childhood, and that also in the sudden paroxysmal form. But what goes still further to prove its affinity to insanity, is the well-known fact, that in the family of the dipsomaniac, not only several cases of this drink-craving propensity are often met with, but marked instances of mental disorder in other forms. Some interesting examples of this may be found in the *Edinburgh Medical Journal* for April 1858, by Dr Thompson of the Perth prisons. When dipsomania thus occurs from constitutional organisation, the disease is assuredly of a worse type than when it springs merely out of the vicious habit of drinking. There is generally more eccentricity of habit and deportment, more perversity of mind and disposition, and more untruthfulness and deceit, which is a remarkably uniform feature in this malady. The victim of it is more unscrupulous in the means employed to gratify the ruling desire of existence; and when the disease is fairly developed, and allowed to take its course unrestrainedly, the moral sense becomes utterly perverted, and the intellect annihilated, so that the affected is readily led to the commission of crimes which would not otherwise be perpetrated, or sinks into a state of complete imbecility or hopeless mania. Whether, therefore, the disease exists in its ordinary phases and

abnormal organisation—and these are sufficient characteristic to present a marked line of distinction from the ordinary vice of intemperance—the pathological and mental phenomena and results are the same—viz., an insatiable craving for alcoholic stimulants, with complete loss of self-respect and self-control in gratifying the desire, despite all obligations due to God and to man. There are generally also some special features in each case, affording additional evidence of decided mental unsoundness. Some of these are wastefulness and senseless extravagance; ridiculous eccentricity of conduct; gross indecency of behaviour, and obscenity and profanity of language; tendency to theft of articles of little or no value—often of one class or kind of things; extreme perverseness and vindictiveness of disposition; and impulsive violence, which leads readily to the commission of homicide or suicide.

These, then, are the features, variously combined in different cases (of which many examples could be easily given), which distinguish instances of dipsomania from ordinary drunkenness, and warrant the opinion that the condition described is a form of mental affection—a disease, like any other insanity. Almost all medical men, we believe, now hold this view, or at least that it should be treated as an insanity; and it has of late been very widely accepted by the general public, at anyrate by all, without exception, who have come in contact with instances in their own families or among their friends.

If such, then, is a correct view of the case, it follows that special physical treatment must be adopted before moral and spiritual agencies can be expected to operate with any chance of success; and as the dipsomaniac is incapable of governing his own will, and making any effort to subdue his ruling desire, it is evident that he should be placed under the power of others who have the means of controlling him. From the very nature of the malady, however, it is scarcely to be expected that the inveterate drunkard will voluntarily submit to control, or continue under it for a sufficient length of time to receive lasting benefit; and therefore it seems essential, as in the case of other insanities, that legal power, with proper precautions and restrictions, should be available, to secure the possession of his person, and the protection of his property. It is undoubtedly the duty of a good and wise government to provide for such care, when it is so well known that the consequences of unrestrained action may be so serious to the individual chiefly concerned; when families are so often thereby plunged into deep distress or absolute ruin; and when the amenity of society is so frequently outraged by a display of mischievous eccentricity, or glaring indecency, or by the occurrence of some flagrant crime. 'The liberty of the subject' is a precious trust, but the absence of law to meet the case of the insane drunkard, is in reality licence for evil, since no precaution is taken to prevent most grievous infringements of the liberties of others. It is certainly an overstrained delicacy in legislation to shirk interference with a class of cases which lead to so much private misery and public expenditure, as the records of our courts of law, prisons, poor-houses, and lunatic asylums can amply attest. But considering the case of the dipsomaniac from another point of view, a facility by law to control, would confer on himself an unspeakable benefit. It would thus afford him his only chance of cure and restoration to society, instead of permitting him to go on

sistent, unjust, and inhumane, when we consider, that while it permits the insensate drunkard to endanger his life, to waste his property, and deprive his family of that which they are justly entitled to expect from his hands during life, or to fall to them at his death, it holds him responsible for any criminal act he may commit. No doubt, the law assumes that he drinks voluntarily, and with his eyes open to all the consequences, and that his practices therefore form an aggravation of his guilt; but such is not the case, for he drinks—as has been shewn—involuntarily, and without any reflection as to ultimate consequences; and he is manifestly unable to exercise his reason aright, or govern his will. That the existing law of lunacy does not meet the case of insane drinkers, is well known, and much felt. One would imagine that the definition of insanity—'a person so diseased and affected in mind as to render him unfit to be at large, either as regards his own personal safety and conduct, or the safety of the persons and property of others or of the public' (20 and 21 Vict. c. 71, s. 3); and again, 'a person of unsound mind' (25 and 26 Vict. c. 54, s. 1)—recognises a dipsomaniac as a fit object for control. But the ancient dicta of English and Scotch judges, as to the nature of insanity, still appear to adhere to the legal mind; and as medical certifiers now require to state the facts on which they form their opinion, the statement that one or the chief manifestation is excessive intemperance, or an uncontrollable craving for intoxicating liquors, is quite enough to prevent a sheriff—or at least some sheriffs—from granting the wished-for warrant. He declines to interfere unless there is evidence of some fury in the case, or the existence of a delusion; and in all probability, were he to do otherwise, and the case be carried into court, a deliverance would be given against the plea of insanity. At anyrate, the uncertainty in the administration of law in such cases, and the danger of subjection to annoyance and expense, even did they gain their plea, deter medical men from granting certificates, which, otherwise, they would most unhesitatingly do. In the last Lunacy Amendment Act (29 and 30 Vict. c. 51, s. 15, 1866), as permission is given to the superintendent of any asylum, with assent, in writing, from one of the Commissioners in Lunacy, to admit as a boarder any person wishing to submit himself to treatment—whose mental condition is not such as to warrant certificates of insanity—it was supposed likely to open a door for the admission of dipsomaniacs. But it has only in a very few instances, and for a very brief period of time, been taken advantage of, under the temporary pressure brought to bear on them by friends, &c. Indeed, there is the same difficulty in getting individuals to go voluntarily into private sanatoria, refuges, and boarding-houses for inebriates—where no legal steps are available—or, when admitted, to detain them sufficiently long so as to effect a cure.

Establishments for inebriates, on a small scale, have existed in this country for many years; and there are at present several excellent ones, for the middle and upper classes, in various parts of the country, particularly in Argyleshire, Ross-shire, Inverness-shire, and Perthshire; besides, several medical men, clergymen, and farmers throughout Scotland receive one or two boarders of this class. Into these places, however, only a very few individuals go quite voluntarily; in fact, it is generally under more or less constraint. Straited circumstances, bodily suffering, the tears and entreaties of relations, threatenings of being cast off altogether, and such-like influences, may succeed perhaps in one

pure air, exercise, occupation, and amusement, so improve the physical condition, that ere long, and before deeper and more radical changes can be effected, or the tone of the moral feelings restored, they become restless, and demand liberty as a right, which they know well cannot be disputed. Out in a few weeks or months, therefore, fully three-fourths of those admitted go, or are taken by injudicious or timid friends, and the result may easily be imagined. Years rather than months of control, and gradual trials of liberty on probation, are necessary to effect a permanent cure in any considerable proportion of the more confirmed cases of this malady. Taking into consideration, therefore, these uncertainties, there is evidently not much inducement for parties to invest money in the establishment of a desirable and trustworthy institution. For a good building, in a pleasant and salubrious situation, with some ground attached, must be secured; the furnishings must be comfortable, the cooking good, and considerable opportunities must be provided for within-door and out-door occupation, amusement, and cheeriness. In fact, all the arrangements must be made so as to provide such new and reliable enjoyments as will counteract or take the place of the cravings for alcoholic stimuli, and prevent, as much as possible, discontentment with the situation in which they are placed. Admission to the private boarding-houses, which do exist in this country is generally at the rate of £100 per annum—unless some extra accommodation or arrangements are required; and payments are made quarterly in advance. The chief stipulations made on entrance are, that no pocket-money be allowed; that no stimulants are to be placed on the table, or given, unless in particular circumstances, under medical direction, since the smallest quantity tasted is apt to keep up or excite a desire for more; and that should there happen to be any hotels, taverns, or spirit-shops in the locality, intimation be made at these places, that no debts will be paid for drink furnished to the boarders. The only public institution in Great Britain for the treatment of inebriates is the Queensberry Lodge, Edinburgh, in connection with the House of Refuge. Into the latter, from 100 to 200 intemperate persons—chiefly of the lower classes, and mostly females, have for a number of years been admitted; but some years ago, a handsome building, distinct from the Refuge, was finished, and comfortably furnished so as to accommodate 27 female boarders of the better classes, at the rates of from £40 to £100 per annum, according to the accommodation given. Already a considerable number have been admitted; and in several instances, apparently with excellent results, although, as yet, there has not been time to test satisfactorily the success of the institution. It is to be hoped, however, from the excellence of its design and management, that its social results will be most valuable; and that it will prove the practicability of working such an institution, after it is once founded—and even with lower scales of payment for board—so as to become self-supporting. From this, a good hint may be taken by any one who has money to bequeath for a truly benevolent purpose.

In several cities of the United States of America, somewhat similar institutions are in active operation, some of them amply endowed, others partly supported from public funds, although into all the admission is only voluntary. Of these, in the state of Massachusetts, the Boston 'Washingtonian Home' was incorporated by the legislature in 1859, and is pointed to as a model institution—although on a small scale—with results highly satisfactory. But the institution about which we have heard

sufficient to accommodate about 200 individuals, amply endowed, and possessing every arrangement and appliance for the treatment of the unfortunate class requiring its aid. But its usefulness has apparently been much checked during past years by the occurrence of a destructive fire, and some other untoward circumstances. It has been recently restored to working order, and placed under the superintendence of Dr Albert Day, who was previously so efficient in the management of the Washingtonian Home; and a great amount of good is expected to result from his labours in this new and larger sphere. It is evident, however, from the number of boarders reported as annually undergoing treatment in these American asylums, that they receive all sorts of drunkards; and we fear that the good accomplished must, in a large proportion of instances, be only partial and temporary. Thus, the Washingtonian Home—which has accommodated hitherto an average of about 18 persons daily—is said to have had from 250 to 300 cases annually under treatment; so that the necessarily brief average residence of each, holds out little hope that much lasting benefit can have resulted in the cases, at least of such confirmed inebriates as we have described under the name of dipsomaniacs, and for whom we desire some legislation. Doubtless, such institutions must be of much social value, were it only in contributing, for a short time, to the greater happiness of the individual chiefly concerned; but it is only a somewhat prolonged course of physical, mental, and moral treatment under judicious control, followed by carefully extended probationary liberty, that can permanently benefit the real dipsomaniac.

The Americans appear to be in advance of us in legislation regarding the care of the person and property of inebriates; for to the magistrate, or rather judge, is committed the care and custody of all insane persons, and of all persons who are wasteful and incapable of conducting their own affairs, in consequence of habitual drunkenness; and he is empowered to provide out of their estates for their safe keeping and maintenance, and for the maintenance of their families and the education of their children. Hence it might be inferred that legal power is given to enforce the care and treatment of insane drinkers in lunatic asylums, or in reformatory asylums, such as those at Binghampton or Boston. But this does not seem to be the case; and although much good must be done to this unfortunate class of individuals under the voluntary system, an infinitely greater amount would, we conceive, be accomplished were compulsory measures resorted to in the worst class of cases, when voluntary submission is unattainable or utterly unavailing.

It is pleasing to see the freedom of legislation on this and other subjects in a new country, where antiquated precedents and prejudices do not drag the wheels of reform, and where common-sense views of social interests prevail. In Southern Australia, a great step has been taken in the right direction, chiefly through the exertions of Dr M'Arthy of Melbourne, who had considered with lively interest the late discussions in this country regarding the treatment of dipsomaniacs. In 1867, after a full ventilation of the question, the government brought in and carried through the houses of legislature a measure placing inveterate inebriates in the same category with insane persons, and providing, in connection with a Lunacy Amendment Act, for their voluntary admission to any asylum or refuge, or compulsory control and

brought before the House in January of the necessity for the step. Ere long, our law-makers will have before them the results of this Australian tentative legislation; but in the minds of many in Scotland a conviction has long since been felt that some law is absolutely necessary to meet the case of insane drinkers; and in 1857 and 1861, our Commissioners in Lunacy gave utterance to most decided views to that effect. Some with them have thought that provisions of this kind should be embodied in a Lunacy Act; but we incline rather to the opinion, that the case requires special legislation; and that separate asylums, sanatoria, reformatories, or by whatever name inebriate institutions may be called, should be provided and licensed for this class of the unsound in mind. Interference with personal liberty would thus be more in accordance with the delicacies of the case, less painful to the feelings of those chiefly concerned, and more likely to secure the humane and remedial objects contemplated. Besides, the arrangements proposed would greatly relieve ordinary asylums, in which the dipsomaniac inmates have hitherto been confined, and in which apparently they have occasioned much trouble and annoyance, from their comparatively early return to sanity, consequent on abstinence from stimulants, while as yet they had undergone very little moral improvement; and apart from this, the malady itself could in many respects be much better treated when separated from other insanities.

Were sufficient facilities afforded, under government sanction, for the control of dipsomaniacs, and their detention until fit for liberation, we have no doubt numerous institutions—and better than those hitherto existing on voluntary enterprise—would spring up in various parts of the country, to accommodate individuals of all grades of society. Institutions so licensed, and endowed with necessary powers, would not only be productive of much public good, but be remunerative. Even supposing it necessary that government should establish three or four inebriate asylums in central situations of the country, these would soon be found to a great extent to be self-supporting, while they would assuredly lessen the burdens of the country otherwise, by the diminution of disease, destitution, and crime. Parochial boards, too, might send their inveterate drunkards into such asylums with more benefit and more economy than they can keep them in the wards of a workhouse.

There are just two points to be brought into view so as to remove the objections which otherwise might naturally be urged against these proposals. The first is, that careful inspection of the proposed institutions should be made by commissioners appointed for the purpose, so as to see that all necessary humane and remedial arrangements are properly carried out, and that no one is detained longer than is essential for recovery; and the second is, that they, along with the medical superintendents, should decide when the inmates, although still under control, are sufficiently sane to execute any testamentary deeds, or to conduct other business matters, or to perform—under more or less surveillance of course—any external civil privilege; or when they may be allowed probational leave of absence, as a preliminary step to final liberation. These latter arrangements would do much to remove the odium connected with personal restraint, and the supposed infringement of civil privilege; and would effectually prevent any one from seeking to impose or prolong control from improper motives. A committee was appointed by the Gladstone government on the occasion of the second reading of the Bill of the

Habitual Drunkards; and in the following session of parliament Mr Dalrymple brought in his second Bill, founded on the Report of the afore-mentioned committee. Unfortunately, the second reading of this Bill was displaced from its position in the business of the House by the resignation of the government, and the death of Mr Dalrymple shortly afterwards arrested the further prosecution of any measure on this subject before parliament. It is understood, however, that the British Medical Association, in consequence of the proceedings in several of its branches, but more especially at the meeting in Edinburgh in 1875, is pledged to make strenuous efforts to obtain some legislation on this matter.

In the foregoing descriptions and remarks, we have drawn freely from Dr Peddie's papers on *The Necessity for some legalised Arrangements for the Treatment of Dipsomania, or the Drinking Insanity; and Dipsomania, a Proper Subject for Legal Provision*, read before the National Association for the Promotion of Social Science at Glasgow, in 1860. To these we refer for a fuller elucidation of the subject; and also to Dr Christison's admirable lecture (*On some of the Medico-legal Relations of the Habit of Intemperance*); but more especially to the Blue-book of Evidence led before the Select Committee of the House of Commons in 1872 on Habitual Drunkards, and the Report thereon by the committee, in the former of which there is a great mass of testimony borne by magistrates, governors of prisons, medical men, superintendents of lunatic asylums, and of inebriate asylums in America; while in the latter, the committee strenuously recommend the adoption of certain legal provisions of a mixed reformatory and punitive character for the control and treatment of habitual drunkards.

DISS, a market-town of the county of Norfolk, England, on the right bank of the *Waveney*, 19 miles south-south-west from Norwich. It is a station on the Great Eastern Railway. The town stands on the slope of a hill; its streets are narrow, but many of the houses very good. There are brush manufactories and breweries. The church of St Mary is a large and handsome Gothic building. Pop. (1871) 3851.

DISSECTION WOUNDS. The practical study of anatomy is attended with certain dangers, which, however, during the last quarter of a century have been much lessened. The atmosphere of the dissecting-room, now comparatively pure by the application of proper ventilation and other sanitary measures, was, less than a generation ago, too commonly loaded with noxious emanations, which more or less poisoned the blood of those who continuously inhaled it, and consequently produced nausea, sickness, diarrhoea, a bad taste in the mouth, and other symptoms. Dissection wounds, which are always attended with a certain amount of risk, were rendered more dangerous by the low state of the system, induced by the depressing influence of the surrounding air. Now, probably in consequence partly of the purer air, and partly of the general and extensive use of antiseptic injections into the vessels of the subjects to be dissected, it rarely happens that severe symptoms follow a cut or puncture. We may incidentally remark that a puncture in making a post-mortem examination, when the body is comparatively fresh, is much more likely to be followed by serious consequences than a wound in the dissecting-room in which the bodies have been lying for some weeks.

In the great majority of cases, punctures or cuts in the dissecting-room are followed by no unpleasant results; it being an established rule, that every

silver. When, however, the poison has been absorbed, and is going to act, the patient begins to have a feeling of general illness in less than 24 hours. He is low-spirited, faint, and chilly, and often complains of nausea. Then come rigors, intense headache, rapid and sharp (but weak) pulse, a coated tongue, vomiting (sometimes), and great restlessness. The first local symptom is intense pain in the shoulder of the wounded side, which is followed by fulness of the neck and armpit, extending in the form of a doughy swelling down the side of the trunk, and assuming a pinkish tint.

The general symptoms increase in severity, the breathing becoming difficult, the pulse very rapid and weaker, the tongue dry, brown, and often tremulous when protruded, and the skin more or less yellow. The case may terminate fatally at or before this stage; or abscesses may continue to form, from which the patient may more slowly sink; or if he survive, the arm may remain stiff and useless, or some of the fingers may be destroyed by gangrene. In the article POISONS we have noticed the rapidity with which death occasionally ensues in these cases. The essential points of treatment are briefly summed up as follows by Dr Druitt in his excellent remarks on this subject in *The Surgeon's Vademecum*: 'The indications clearly are to eliminate the poison from the blood; to support the strength; and to relieve pain, and promote the discharge of pus or sloughs.' The treatment, both general and local, is, however, so similar to that of Pysmia, that it is sufficient to refer our readers to that article.

As a precautionary measure in post-mortem examinations, the surgeon, especially if he be out of health, or if the patient have died from a disease of an erysipelatous character, should thoroughly anoint his hands with lard. Very thin india-rubber gloves have been recommended as a safeguard to dissectors; but they have not been found to answer; probably from the constraint to which they subject the action of the fingers.

**DIVIRIGI** (anc. *Tephrese*), a town of the province of Rumili, Asia Minor, on the Kurner-Su, a branch of the Euphrates, 28 miles north-west from Arabkir. Pop. supposed to be about 10,000.

**DOESBORGH** (*Drunsborg*), a town in the Netherlands, province of Gelderland, lies 11 miles east-north-east from Arnhem, on the right bank of the Yssel. It was formerly fortified, but the walls have been broken down, planted with trees, and formed into pleasant promenades. An entrenched camp has been constructed on the north-east side, between the Yssel and Old Yssel, which here unite. The streets are broad, and many of the houses handsome. There are several benevolent institutions, a grammar-school, boarding-schools for boys and girls, and good public schools. The trade is considerable. Ship-building, book-printing, the making of Eau de Cologne, preparing mustard, &c., are carried on. Pop. above 4000.

**DO'KKUM**, a town in the Netherlands, province of Frisland, lies 12 miles north-east from Leeuwarden, on the Ee (pronounced *Ay*), which cuts it into two irregular parts. Within the town is a broad haven, suited both for sea-going and inland ships. There are several regularly built streets and many neat houses. The trade in flax, cattle, wool, and chickery is extensive. In the Dokkumerdiep, shrimps are largely taken. Ship-building, gin-distilling, beer-brewing, carding wool, &c., are principal industries. There are a grammar and other good schools. Pop. 4500.

**DOLINA**, a town of Austrian Galicia, in the

Pop. of town and commune about 1000.

**DÖLLINGER**, JOHN J. IGNATIUS VON, one of the most distinguished of the Roman Catholic divines of modern Germany, was born at Bamberg, February 28, 1790. He was educated at Würzburg, where he received holy orders. For a time he was engaged in parochial duties in his native diocese; but having manifested a peculiar fitness for a literary life, he was appointed a professor at Asehaftenburg, whence, in 1828, he was removed to the chair of Ecclesiastical History in the newly-established university of Munich. From the first he was distinguished as a ready and profound writer. He inaugurated his new professorial career by a work on *The Doctrine of the Eucharist during the First Three Centuries*, in 1828, and a *History of the Reformation*, being a continuation of Hertig's *Handbook of Church History*. He subsequently undertook a new *History of the Church* (vol. i. 1833, vol. ii. 1835), which was speedily translated into French, and also into English, and was carried down to the 15th c.; with a compendium which came down to the Reformation (1836—1843). His very learned and suggestive essay on *The History, Character, and Influence of Islamism* appeared in 1838, and *The Reformation, its Internal Development and Effects*, in 3 vols., in 1846—1848. The design of this work, which consists almost entirely of extracts (connected by a very slight thread of narrative) from the writings of the leading reformers and other contemporary Protestant divines, is to present, in the words of the actors in the great religious drama of the 16th c., a picture, doctrinal, moral, social, and political, of the Reformation and its results; but as the great body of the authorities (exclusively Protestant) are German, the interest of the work is mainly national.

For a time, D. undertook the chair of Dogmatic Theology, in which capacity he delivered lectures on 'The Philosophy of Religion,' on 'Symbolism,' and on 'Patristic Literature,' none of which, however, have been published. He was a frequent contributor to the *Historisch-politische Blätter*; he published several pamphlets on subjects of occasional interest; and was one of the chief contributors to the Catholic cyclopaedia entitled *Kirchen-Lexicon*, in which his articles on Luther, on Bossuet, and on Duns Scotus attracted much attention. In the politico-religious movement of 1846—1847, D. was elected to represent the university of Munich in the Bavarian chamber; but being deprived of his professorship, he became disqualified to sit in the chamber. In the parliament of Frankfurt in 1848, he was recognised as the leader of the Catholic party. Most of the measures of importance bearing on the relations of church and state which (however ineffectively) were originated in that assembly were prepared or suggested by him. In 1849, he was restored to his professorship at Munich, and also to his place in the Bavarian chamber, which he held till 1852. Since that year, he has devoted himself entirely to theological literature. His work entitled *Hippolytus und Kallistus* (1853) is a masterpiece of patristic criticism; and his *Heathenism and Judaism, the Vestibule of the History of Christianity*, is a most masterly survey of the religious, moral, and social condition of the world at the advent of our Lord. It was quickly followed by *The First Ages of Christianity*, to which it had been designed as an introduction. During the early discussions on Italian unity, D. delivered an address at Munich, which was represented as hostile to the temporal sovereignty of the pope. In order to explain his



*Church and the Churches*, which was partly a comparative survey of the condition of the non-Catholic communions, and of the Church, and partly a *résumé* of the history and condition of the Papal States; shewing that, while the temporal sovereignty was the means providentially established for maintaining the spiritual independence of the papacy, yet it was by no means essential; that the papacy long existed without it, and that even if it were overthrown, Providence would devise another means of attaining the same end. The second part was a criticism of the administration of the Papal States, which is understood to have given dissatisfaction to the authorities, as being, although well meant, inopportune, and from this inopportune, unfriendly. A similar feeling is said to have been drawn forth by the part taken by Dr D. in reference to the 'Catholic Union,' some of the principles of which were supposed to trench dangerously upon the province of authority in matters of religious inquiry; but his orthodoxy and learning were unquestioned, and his influence, especially among Catholics of his own nationality, was very great until the approach of the time for the celebration of the council of the Vatican. It being understood that the doctrine of the infallibility of the pope would form a subject of discussion, D. took an active part in organising an opposition. Articles which appeared in the *Augsburg Gazette*, in March 1869, and which were reprinted more fully under the *nom de plume* 'James,' were ascribed to him or to his influence; and during the discussions of the council, he was entirely identified with the party opposed to the Ultramontane view. On the publication of the decree of the council, which defined the infallibility of the pope in all doctrinal teachings on faith and morals addressed *ex cathedra* to the universal church, D. refused to accept the doctrine. In October, and in deprecation of the impending censure of excommunication by the archbishop of Munich, he published an address to the archbishop, in which he claimed to be heard in the synod of German bishops, or before a committee of the cathedral chapter. His declaration on papal infallibility called forth replies from Dr Hergenröther and others, and was accepted, on the other hand, by the so-called Old Catholic party. D. was elected Rector of the university of Munich (February 29, 1871) by a large majority of votes. Persisting in his refusal to submit to the authority of the council, he was excommunicated by the archbishop of Munich on the 18th April, 1871. In 1874, Dr D. presided over the 'Old Catholic' Conference at Bonn, where he frankly declared that he and his colleagues did not consider themselves bound by the council of Trent. He also introduced a declaration, adopted unanimously, that the Eucharistic celebration in the church is not a continuous repetition or renewal of the great propitiatory sacrifice. His literary activity is little diminished. In relation to the prophecy of Orval, and other French prophecies supposed to bear upon the late war with Germany, he published recently an elaborate essay on *Prophecies and the Prophetic Spirit*, which has been translated into English by Alfred Plummer. In addition to his accomplishments in book-learning, Dr D.'s attainments as a linguist, both in ancient and modern languages, are very remarkable. In 1871, D. received the honorary degree of D.C.L. from Oxford University; and in 1872, that of LL.D. from Edinburgh. In 1872, the King of Bavaria conferred on him the Order of Merit; and in 1874, the Emperor of Germany the order of the Red Eagle, second class. In 1873, he

DO'LO, a town of Northern Italy, in the government of Venice, and 12 m. W. from Venice, on the Brenta and Brentano. It is a station on the railway between Padua and Venice. In the vicinity are many villas of the Venetian nobility. Pop. 4468.

DONA, SAN, a town of North Italy, in the province of Venice, 18 miles north-east from Venice, on the left bank of the Piave. Pop. 5550.

DORCHESTER, formerly accounted a separate city of Massachusetts, U.S., was in 1870 annexed to the city of Boston. The fortification of Dorchester Heights, in 1776, compelled the evacuation of Boston.

DORÉ, PAUL GUSTAVE, a French artist of great and versatile power, was born at Strasburg in 1832. He was educated at Paris, and very early gave indication of superior ability. His first attempts were sketches, contributed to the *Journal pour les* and others of the Paris periodicals. In 1855, he exhibited his picture of the 'Battle of the Alma,' which was followed by the 'Battle of Inermann' in 1857. In this year he first became heard of in England by the reissue of his illustrations of the legend of the 'Wandering Jew,' the power of weird and grotesque imagination displayed in which could not fail to arrest attention. The success of this work might seem to have determined the future career of the artist, who has since chiefly worked as an illustrator. His productiveness in this field is amazing. He has illustrated editions of *Rabelais*, of the *Contes Drolatiques* of De Balzac, of *Dante's Divina Commedia*, of *Don Quixote*, of *Lafontaine's Fables*, of Milton, and of the Bible—all of which bear the impress of D.'s original genius. He has also illustrated Tennyson's works, Coleridge's *Ancient Mariner*, the *Legend of the Wandering Jew*, and a tour in Valencia, besides executing a vast mass of miscellaneous work. He has from time to time reproduced and exhibited in Paris and London, many of his designs. The 'Doré Gallery,' used for this purpose, has been open in London for several years. 'Christ leaving the Prætorium' is his most important painting. The slightest of D.'s productions shews that he is at once artist and poet, and excites a greater interest than many works more free from hastiness and mannerism. In 1861, D. received the decoration of the Legion of Honour.

DOUGLASS, FREDERICK, American orator and journalist, was born at Tuckahoe, near Easton, Maryland, about 1817. His father was a white man, his mother a negro slave, and he was reared as a slave on the plantation of Colonel Edward Lloyd until ten years old, when he was transferred to a relative of his owner at Baltimore. There he worked in a ship-yard, and taught himself to read and write. At the age of 21, he escaped to New York, and thence to New Bedford, in Massachusetts, where he married a woman of colour, and worked until 1841, when he attended an Anti-slavery Convention at Nantucket, and spoke so eloquently on the subject of slavery, that he was employed as an agent of the Massachusetts Anti-slavery Society, and lectured for four years with great success. In 1845, he published his Autobiography, and accepted an invitation to make a lecturing tour in Great Britain, where, in 1846, a contribution of £150 was made to buy his freedom. Returning to America, he established, in 1847, *Frederick Douglass's Paper*, a weekly abolition newspaper, at Rochester, New York. In 1853, he re-wrote his Autobiography, under the title of *My Bondage and my Freedom*. In 1871, he was secretary to the Santo Domingo Commission; and in 1872 was elected a presidential elector for the state of New York. Mr D. is a tall, dark mulatto;

**DOWNING COLLEGE, CAMBRIDGE**, founded solely by Sir George Downing of Gamlingay Park, Cambridge, who, by a will of date 20th December 1717, devised his estates in the counties of Cambridge, Bedford, and Suffolk to various relations in succession, and on failure thereof, to build and found a college on a plan to be approved of by the two archbishops of England and the masters of St John's and Clare Colleges. Owing to various litigations and other difficulties, it was not till 22d September 1800 that the college received its charter, sealed with the Great Seal, nor till May 1821 that the buildings were sufficiently advanced to admit of undergraduates residing and keeping terms. The college will consist of a master, two professors (one of Law and one of Medicine), at least 8 fellows, and at least 10 scholars; but at first only the master, professors, and three fellows were appointed. The fourth of the remaining five fellowships was filled up in 1871. Of the 8 fellows two must be resident, and of these one must be in holy orders; the resident fellows hold their fellowships for life, but the tenure is affected by marriage; the 6 non-resident fellows, who are presumed to be persons actively engaged in the studies of law and medicine, hold their fellowships for 12 years. This college had, in 1873, 51 members of senate, 41 undergraduates, and 132 members on the boards.

**DRAINAGE-TUBES**, in Surgery, are a recent but important addition to the surgical appliances for which this profession is indebted to a distinguished French surgeon, M. Chassaignac. They are composed of india-rubber, about  $\frac{1}{4}$ th of an inch in diameter, perforated with numerous holes, and of various lengths. They are of great use in chronic abscesses, Empyema (q. v.), &c.; and the method of employing them is as follows: In the case of a large chronic abscess, which it might be dangerous to empty at once, the surgeon takes a long trochar (a tapping instrument such as is used to draw off the fluid in abdominal dropsy), introduces it at the top of the abscess, and brings it out as near the bottom as possible. Through the tube of this instrument a drainage-tube is inserted, which is secured in its place; the tube of the trochar being removed. Through the drainage-tube the pus oozes out, drop by drop, and the abscess is thus emptied. Like all new inventions, it has its advocates and opponents. Thus, while Mr Paget, in his article 'Sinus and Fistula' in Holmes's *System of Surgery*, says: that '*drainage*, for which the perforated caoutchouc-tube of M. Chassaignac is a very happy invention, is applicable to a great number of cases; but chiefly to those in which a sinus or incomplete fistula depends mainly on pus collecting at a level below or distant from the aperture of discharge, or more generally, when pus is apt to be retained'—Mr Paget's surgical colleague at St Bartholomew's Hospital, in his article 'Abscess,' which immediately precedes that from which we have just quoted, objects to the drainage-tube on the grounds that, as a foreign body, it sets up irritation, and adds that 'if a proper opening be made there can be rarely any occasion for a drainage-tube; and however carefully it is inserted, it must of necessity inconvenience and distress the patient.' Notwithstanding Mr Coote's objections, drainage-tubes are gradually getting into use in hospital practice.

**DRAPER, JOHN WILLIAM**, American chemist and physiologist, was born near Liverpool, England, May 5, 1811, and educated at a Wesleyan school at Woodhouse Grove, and later pursued his studies in

Germany, and in America, and in 1830, took his degree of Doctor of Medicine in the university of Pennsylvania, and was appointed Professor of Natural Philosophy, Chemistry, and Physiology, in Hampden Sidney College, Virginia. In 1839, removing to the city of New York, he was connected with the preparatory department, and in 1841, joined Doctors Mott, Patterson, &c. in founding the Medical College of New York University, in which he was at first Professor of Chemistry, and in 1850, of Physiology. He is a clear and able lecturer, and a voluminous writer, having been a liberal contributor to the *American Journal of Medical Science* and the *Edinburgh Philosophical Journal*, and published a treatise on *The Forces which produce Organisation in Plants* (4to, 1844); *Text-book of Chemistry* (12mo, 1846); *Text-book of Natural Philosophy* (8vo, 1847); *Human Physiology, Statical and Dynamical, or the Conditions and Course of Life in Man*. Dr D. has also published *History of the Intellectual Development of Europe*; *Thoughts on the Future Policy of America* (1865); *Philosophical History of the Civil War in America* (1867—1870); *History of the Conflict between Religion and Science* (1874).

**DROY'LSDEN**, a large and rapidly increasing Lancashire township, a district pariah of Manchester, and 4 miles east from Manchester, a station on the Lancashire and Yorkshire Railway. It is situated on an elevated plain, is irregularly built, the houses of brick, but many of them very neat. The cotton manufacture is extensively carried on; there are also print-fields, dye-works, and copperas-works. Pop. (1871) 6768.

**DUBU'QUE** a city and port of Iowa, U. S., on the right bank of the Mississippi, 450 miles above St Louis, built on a bluff 200 feet high, contains a city hall, market-house, U. S. custom-house, Episcopal seminary, surveyor-general's office, 14 Protestant and 3 Catholic churches and cathedral, 8 newspapers, of which 2 are German. Settled in 1783, by Julian Dubuque, a French trader, it became the centre of a large trade, and is the chief dépot of the great lead region of Illinois, Wisconsin, and Iowa. Pop. (1860) 13,012; (1870) 18,434.

**DUFOUR, GUILLAUME HENRI**, a Swiss general, was born at Constance in 1787, of a Genevese family. While Switzerland formed part of France, he studied at the Polytechnic School of Paris for two years; and on leaving it, he received an appointment as an officer of engineers in the French army. At the fall of Napoleon, he entered the Swiss service, and rapidly rose to the rank of colonel. When the government survey of Switzerland was undertaken, he was appointed Director—at the same time acting as the Principal of the Swiss Military School at Thun. In 1840, he published *A Treatise on the Artillery of Ancient and Medieval Times*; and in 1842, *A Manual of Military Tactics*. In 1847, he was raised to the rank of general, and intrusted with the command of the army employed against the Sonderbund. He defeated their forces at Freiburg (13th November) and at Lucerne (24th November); and by his promptitude and skilful manœuvres, secured a triumph for the liberal party in time to prevent the interference of foreign powers, diplomatically or otherwise. The diet voted him a gift of 40,000 francs, and for a time he was the most popular man in Switzerland. His politics were not, however, those of the Genevese democrats, and in 1848 they deprived him of the public offices he had previously held. In 1856, he was again admitted to the council of Geneva, and sent on a special mission to Louis Napoleon à propos of the dispute between

the conference held at Geneva relative to the treatment of the wounded in time of war. In 1869, he presided at a fête in celebration of the jubilee of the reunion of Geneva with Switzerland. He died in 1875.

**DÜPPEL**, or **DYBBÖL**, a small fortified town of the Prussian province of Sleevig-Holstein, in the peninsula of Sundewitt, 16 miles north-east from Flensburg. During the war between Germany and Denmark, it was bombarded for more than a month by the Prussians, and finally taken, April 18, 1864.

**DÜRCKHEIM**, a town of Rhenish Bavaria, on the Isenach, 20 miles north from Landau. It stands at the entrance of the valley of the Isenach, at the base of hills which skirt the plain of the Rhine, and the neighbourhood is very beautiful. Many invalids resort to D. on account of its amenity, and to take the *grape-cure*. It has manufactures of tobacco, cutlery, and paper. D. was formerly the residence of the princes of Leiningen-Hardenburg, whose palace was burned by the French in 1794. Not far off are the salt-works of Phillipshall. The summit of a neighbouring height is crowned by a rampart of loose stones, 6—10 feet high, 60—70 feet wide at the base, and enclosing a space of about two sq. m., called the Heidenmauer (heathens' wall), which the Romans are said to have built to keep the barbarians in check, and where Attila is said to have passed a winter, after having wrested the fortress from the Romans, when pressing on his way to Rome. Pop. (1871) 5848.

**DURUY**, **VICTOR**, historical writer, ex-professor, and ex-Minister of Public Instruction in France, was born at Paris in 1811. Members of his family were employed as designers in the lace-works at Gobelins, and he was, in his boyhood, intended to follow their occupation. He was, on this account, somewhat late in beginning his classical studies, which he did at the College Rollin, then called the College Sainte-Barbe; but the progress he made was rapid enough to enable him to enter the Ecole Normale in his nineteenth year. Here his career was sufficiently distinguished to obtain for him, in 1833, in succession, the position of teacher of history in the College of Rheims—which he only held for two months—and that of teacher or Professor of History at Paris, in the College Henri Quatre, afterwards called the College Napoleon. This college (as well as the former) is a school of secondary instruction, in which history forms part of the programme of studies of the second (the next to the highest) class. The post which D. obtained in it was therefore by no means a high one. He continued to fill it till 1861. He had meanwhile gained a considerable reputation as a teacher of history, and as a writer on history and geography. Most of his books were school-books, but they were so good that they had a great influence upon the teaching of history in French schools. He got the degree of Doctor of Letters in 1853. In 1861 and the following year, he passed through a rapid course of promotion. He was first appointed an Academy-inspector of the Academy of Paris (an inspector of schools of secondary instruction in the district under the jurisdiction of that Academy); next, Master of Conferences at the Ecole Normale; then Inspector-general of Secondary Instruction; and, finally, Professor of History in the Ecole Polytechnique. From the last-named post he was, on the 23d June 1863, by imperial decree, advanced to the office of Minister of Public Instruction.

D., who, by activity and ability combined, had made himself distinguished while filling a somewhat

out important changes in the educational system of France—which had undergone scarcely any modification since the introduction of Guizot's Education Law in 1833. He instituted a tribunal for trying charges brought against professors. He remodelled the examinations for the degree of Bachelor of Letters. He first suspended, and afterwards abolished, the division of the highest class, which had prevailed in schools of secondary instruction, into two sections: the one rhetorical or literary, the other philosophical (scientific)—thus making the study of science obligatory upon all who passed through the school curriculum. He introduced other changes into the course of secondary instruction, of which the most important—at any rate, that which has been most discussed—was the teaching of contemporary history in the Lycées, or departmental public schools. Previously, the text-books used in teaching history in these schools were Bossuet's *Histoire Universelle* and Montaigne's *Grandeur et Décadence des Romains*—these works being supplemented by the lectures of the professor. D. had a text-book prepared for their use, containing a compendium of French history to so late a period as that of the recent French invasion of Mexico; and it has been alleged that this work, and the circulars which the minister published for the instruction of teachers of history, disclosed a systematic attempt to imbue the youth of France with a Bonapartist view of recent history—to make the teaching of the schools a source of future strength to the Empire. Perhaps it would be difficult altogether to acquit D. of the Machiavellian design imputed to him. As to primary instruction, he officially proposed to the Emperor to make it compulsory and gratuitous; but the proposal was badly received by the public, and the Emperor withheld his sanction. He also procured legislative sanction for a measure which greatly increased the number of primary schools, especially of girls' schools, for which the provision made had previously been inadequate. The night-schools for adults, too, were greatly improved and extended under his care; and the educational libraries established in connection with them proved very effective aids to the education of the working-classes. He procured an enactment for establishing schools of special secondary instruction, intended mainly to teach the elements of science to boys of the lower middle class who are to be engaged in manufactures or commerce, and, in the country districts, to give systematic instruction in the methods of agriculture and horticulture.

The matters which have been mentioned are only a few of those which D., with bold and unsparring hand, leaving no part of the system of education untouched, dealt with while in office. It is unquestionable that he in many cases effected improvements; but the spirit and tendency of his administration were strongly impugned, and his conduct was jealously watched by the best portion of French society. It is alleged that he steadily attempted to secure the entire control of education for the state; and to use national schools as a state instrument. For example, the changes which he introduced in the examinations for the degree of Bachelor of Letters are said to have been intended to force candidates to study at the government establishments; and certainly, if their working has not been misrepresented, their tendency seems to be to place candidates educated elsewhere at a disadvantage. In such changes as this, there may be exaggeration or misconception; but D. is an ardent Bonapartist, and it is natural to suppose that he intended the results which his acts

decorated with the Legion of Honour in 1845, and was promoted to be officer, commander, and grand commander of that order. He has been an officer of the Turkish order of Medjidie since 1857.

Of D.'s numerous works, not a few were written for a series published under the title *L'Histoire Universelle*, of which D. was the editor. His earliest work, *Géographie Politique de la République Romaine et de l'Empire*, first appeared in 1838; it was followed by *Géographie Historique du Moyen Age* in 1839; *Géographie Historique de la France* in 1840; and *Atlas de Géographie Historique Universelle* in 1841. In 1840, he published the first volume of a work of greater pretensions than these—*Histoire des*

under the title *L'Etat du Monde Romain vers la Fondation de l'Empire*; but the work appears to be still incomplete. *Histoire Sainte d'après la Bible* (1845), *Histoire Romaine* (1848), *Histoire de France* (1852), *Histoire Grecque* (1851), were among his subsequent productions. In 1862, appeared two volumes of his *Histoire de la Grèce Ancienne*, a work which has been crowned by the French Academy. *Histoire Moderne* (1863), *Histoire Populaire de la France* (1863), *Histoire Populaire Contemporaine* (1864), *Introduction Générale à l'Histoire de France* (1865), were works prepared under his direction, and some of them partly consisting of extracts from his previous writings on French history.

## E



**E** A'GEE, another name for the Bore (q. v.) in tidal rivers.

**EAR, DISEASES OF THE.** See **DEAFNESS** and **OTITIS**.

**EAU DE LUOE** is the name given to a preparation which was formerly a very popular stimulant, and is still occasionally used. It is a mixture of oil of amber with alcohol and ammonia, and has a milky appearance. It had a great reputation in cases of snake-bites.

**ECRASEUR**, the name of a long steel instrument, invented a few years ago by a distinguished French surgeon, M. Chassaignac, and consisting of a fine chain which, passed round any structure—as the base of a tumour, for example—gradually constricts it, and finally crushes its way through it by means of a screw or rack for tightening it, which is worked at the end of the handle. The advantage of this instrument over the knife is, that it causes little or no bleeding, the torn vessels spontaneously contracting and closing. It is specially applicable to cases of cancer of the tongue, piles, polypi, and various kinds of tumours. When a solid mass—as, for example, a considerable portion of the side of the tongue—is to be removed, the chain is sometimes pressed through the centre, and made to cut two lines successively in the form of a V, in which the diseased structure is included. As the pain which is caused by this instrument is very great, the patient should be placed completely under the action of chloroform before it is applied.

**ECRICOK**, or **ICRICOK**, a town of Guinea, the capital of a petty chief, on the Old Calabar river, about 100 miles from its mouth. The river is here about a mile broad. The town consists of mud-houses, erected on platforms.

**EOTHY'MA** is a pustular disease of the skin, in which the pustules often reach the size of a pea, and have a red, slightly elevated, hardish base. In the course of two or three days after the appearance of the pustule, it is replaced by a scab, which adheres firmly to the base, and is somewhat concave. On its removal, a deep red mark, a new scab, an ulcer, or a healed scar remains. The disease may be acute or chronic. The acute form is ushered in by slight constitutional, not amounting to febrile, symptoms, and by a burning or pricking pain at the seat of

the eruption, which is usually confined to the neck and shoulders. The disease runs its course in ten days or a fortnight. In chronic ecthyma, the pustules which follow in crops (often for several months) are usually scattered over the extremities. This form of eruption indicates a low state of the system. It sometimes follows the acute disease, and not unfrequently is a tertiary symptom of syphilis. Pustules, which in no respect seem to differ from those of ecthyma, are produced by various local irritants. Thus the affection of the hands, popularly known as *the grocer's itch*, is produced by the irritation of brown sugar, perhaps by the *acari* which are so often present in it. Stone-masons are said occasionally to suffer from a similar disease. With regard to *treatment*, the acute form would in most cases doubtless disappear in the course of a fortnight, if left entirely to itself; but as the bowels are usually disordered, an occasional alterative aperient, as a few grains of gray powder with a little rhubarb, may be prescribed, and tepid water applied locally gives great relief. The patient should, moreover, be kept on a moderately good, nutritious diet. In the chronic form of the affection, a meat diet and the use of wine or porter are essential; while tonics, such as a combination of bark and nitric acid, are called for. Tepid baths are often useful, and if there is sleeplessness, an opiate should be taken at or shortly before bedtime.

**EDA'M**, a town in North Holland, lies 12 miles north-north-east from Amsterdam. It has seven entrances, and lies within a green dyke, ornamented by two rows of elm-trees. There is an extensive trade in wood and cheese. The principal industries are ship-building, rope-spinning, sawing wood, tanning leather, &c. There are a Lutheran, a Baptist, a Roman Catholic, and two Reformed churches, one of the latter having beautiful painted windows. In 1864, pop. 5190; in 1870, 5185.

**E'DENKOBEN**, a town of Rhenish Bavaria, in the circle of Pfalz, six miles north-north-west from Landau. It has a station on the Mannheim and Strasburg Railway. It is surrounded by vineyards, which produce much wine, but not of very good quality. Chestnuts are also produced in large quantity in the neighbourhood. There is a bathing establishment at E., also several mills and manufactures of fire-arms. It has important grain markets.

**EDUCT** is a term employed in Chemistry to indicate that the body to which it is applied is separated by the decomposition of another in which it previously existed as such. It thus stands in opposition to *product*, which denotes a compound not previously existing, but formed during decomposition. Thus, the volatile oils which pre-exist in cells in the fruit and other parts of plants, and oil of sweet almonds obtained by pressure, are educts; while oil of bitter almonds, which does not pre-exist in the almond, but is formed by the action of emulsin and water on amygdalin, is a product.

**EIBENSTOCK**, a town of the kingdom of Saxony, in the circle of Zwickau, and 16 miles south-south-east from Zwickau. It stands in a high and bleak district. It has extensive manufactures of chemical products, muslins, lace, tobacco, and tinware, and a considerable trade in cattle. Medicinal plants are very extensively cultivated. Pop. (1875) 6773.

**EJUTLA**, a town of Mexico, in the province of Oajaca, on a small river, 250 miles south-south-east of Mexico city. It was the capital of a dep. of the same name, in the new division of the country made by Maximilian. Pop. 7128.

**EKHMIM**, or **AKHMIM**, a town of Upper Egypt, 53 miles south-south-east from Siout, on the right bank of the Nile, and about a quarter of a mile from it. It occupies the site of the ancient *Chemnis*, or *Panopolis*, one of the great cities of the Thebaid. Remains of ancient buildings exist. Cotton fabrics are manufactured here. Pop. supposed to be about 10,000.

**EL BASSA'N, ALBASSAN, or ILBASSAN**, a town of European Turkey, in the province of Albania, on the Scombi, 35 miles east from the mouth of that river. It stands in a fertile plain, surrounded by mountains, is the capital of a sanjak, and the seat of a Greek bishop. It has manufactures of iron and copper wares. Pop. 10,000.

**ELCHO, FRANCIS WEMYSS-CHARTERIS-DOUGLAS, LORD**, born August 4, 1818, is eldest son of the eighth Earl of Wemyss. This ancient Scottish family has a traditional descent assigned it from the House of Macduff, Earl of Fife. Sir Michael de Wemyss in 1290 was sent to Norway by the lords of the regency in Scotland to conduct the young Queen Margaret to her dominions. He swore fealty to Edward I. in 1296, and was a witness to the act of settlement of the crown of Scotland by King Robert I. at Ayr in 1315. From him lineally descended Sir John Wemyss, who was created a baronet in 1625; raised to the peerage of Scotland as Baron Wemyss of Elcho in 1628; and advanced to the dignities of Earl of Wemyss in the county of Fife, and Lord Elcho and Methel, in 1633. Although indebted for his honours to Charles I., he was engaged during the subsequent civil wars on the side of the parliament. David, fourth earl, was appointed by Queen Anne Lord-high-admiral of Scotland, and one of the commissioners for concluding the treaty of Union. The eldest son of the fifth earl having taken part in the rising of 1745, escaped to France after the battle of Culloden, and was attainted. At his death, the family honours were taken up by his brother Francis, sixth earl, who, having inherited the estates of his maternal grandfather, Colonel Charteris, of Amisfield, county Haddington, had assumed the surname of Charteris before that of Wemyss. Francis, his grandson, became heir to the titles of Earl of March, Viscount Peebles, and Baron Douglas of

Kingdom, by which title the possessor of the earldom holds his seat in the House of Lords. A parliamentary reversal of the attainder of Lord Elcho, obtained in 1826, put beyond question the succession to the Scottish honours. His son, the present earl, is Lord-lieutenant of Peeblesshire, and lieutenant-general of the Royal Archers.

Lord E. was educated at Christ Church, Oxford, where he graduated B.A. in 1841. He was returned to the House of Commons as M.P. for East Gloucestershire from July 1841 to February 1846, and has sat for Haddingtonshire since 1847 to the present time. He took his seat on the Conservative benches, but accepted office, with other members of the party of Sir Robert Peel, in the coalition government of the Earl of Aberdeen, and was a Lord of the Treasury from January 1853 to February 1855. In 1859, the menacing attitude of France, and the periodical recurrence of seasons of alarm, caused by the unprotected state of our shores, and the possibility of invasion, led to an organisation of Rifle Volunteers in Great Britain. In this movement, Lord Elcho took the earliest and most prominent part. He organised a regiment of London Scottish Volunteer Rifles, of which he was appointed major in 1859, and lieutenant-colonel in 1860, and went to Hythe Barracks, to receive instruction in the use of the Enfield rifle, and to the camp at Shorncliffe, in order to become familiarised with regimental duties and brigade movements. Lord Elcho also projected the National Association for the Promotion of Rifle-shooting, the first shot at which was fired by her Majesty, July 2, 1860, at Wimbledon. He and other patriotic noblemen and gentlemen associated with him in the Volunteer movement, had the satisfaction of assisting, in 1860, at two grand reviews by the Queen of various brigades of Volunteer Rifle corps—of 20,000 men in Hyde Park, and 22,000 men in Edinburgh. The War Office assisted in organising the force, and thus was consolidated the Volunteer army of Great Britain, who adopted as their motto, 'Defence, not Defiance.' The National Rifle Association, mainly under the auspices of Earl Spencer and Lord E., has become an established institution—the centre and keystone of the Volunteer movement. Lord E. has since given additional efficiency to the Volunteer movement by watching, in his place in parliament, its financial relations with the government. In 1865, Lord E. took a more active part in parliamentary politics than had been possible during his labours in promoting the Volunteer movement. He spoke against the 26 franchise proposed by Mr Baines, and gave notice of a motion for a Royal Commission to examine into the extension of the franchise. When the government of Earl Russell brought in the Reform Bill of 1866, Lord E. organised a secession from the Whig party, under the leadership of Earl Grosvenor, which was nicknamed the 'Cave of Adullam,' but which succeeded in defeating the Bill, and displacing the government. Lord Derby, on his accession to the premiership, offered a post in his government to Lord E., but the offer was declined. In 1867, his party found themselves powerless to prevent the passing of a more democratic Reform Bill than that which in the previous year they had thrown out. Lord E. is a fluent and pleasant speaker, and he is exceedingly popular with the Volunteers both of England and Scotland. Lord E. is an LL.D. of Edinburgh University. In 1871, he published *Letters on Military Organisation*. In 1875, he drew public

**ELECTRIC LOOM.** A reference was given in **JACQUARD LOOM TO WEAVING**, for a notice of Bonelli's electric loom; having been accidentally omitted in the last-named article, the notice is inserted here. The machine is not so much a loom, as an electric appendage to the Jacquard apparatus. Although not at present brought much into use, its principle is very beautiful, and is likely to be suggestive of other applications. The apparatus will suit any Jacquard loom. The design or pattern to be woven is painted with a brush and black varnish on an endless band of paper covered with tinfoil. When in action, the band passes under a series of metallic teeth connected with a galvanic battery. Whenever the foil touches a tooth, a galvanic current is sent through them both to coils of wire surrounding small bars of iron: the bars become temporary magnets; but as soon as the varnish on the foil touches a tooth, the galvanic current and the magnetism alike cease. There are thus produced rapid alternations of action, which are made to work the Jacquard apparatus in a remarkably ingenious way. Small iron rods are placed opposite the ends of the small bars; when the latter are in a magnetic state, they attract or draw forward the former to a small distance; but when the bars are not magnetic, the rods are not attracted. The rods fill like pistons, but without tightness, a series of holes in a vertical iron plate, and are drawn a little way out of these holes whenever the bars are magnetized. Now, the pattern on the foil continually changes the contact of the foil and the varnish with the teeth; this change makes the bars alternately magnetic and non-magnetic; this, in its turn, varies the order in which the rods are drawn out of the holes; and this, finally, converts the plate into a sort of Jacquard card, with its holes partially open and partially closed, in accordance with some determinate pattern, and changing these openings and closings continually. A treadle moves the plate towards the bars, with a swinging motion; and each swing is accompanied by one throw of the shuttle. This is for one-colour thread; if there are two or more, there must be as many bands of tinfoil as colours: the arrangement is more complex, but the principle is the same. By varying the velocity of moving the band, the pattern may be made larger or smaller, and thicker or thinner in the closeness of the web; while the design may quickly be changed by substituting another strip of foil.

**ELECTRO-METALLURGY.** Within the last few years many advances have been made in the art of electro-metallurgy. It used to be nearly always the case, in electro-plating, that the silver presented a dull appearance when drawn out of the trough, requiring to be polished by a burnisher and a scratch-brush. Messrs Elkington have, however, devised a mode of causing the galvanic action to polish the metal. If bisulphide of carbon be added to the bath, or, better, if the article be dipped into a bath containing this liquid after immersion in the usual acid solution of silver, a thin but hard and bright layer of silver is deposited on the main layer, brilliant enough to do without polishing. There are certain difficulties in the process which render it only applicable under some circumstances.

Both copper and brass are now *made* by electricity. Messrs Elkington have a plan for bringing copper ore, by the usual processes, to that degree of refining called 'pimple' or 'blister' copper; after which the rest of the operation is performed by

using a zinc and copper pole in a battery; the negative pole being a very thin sheet of pure refined copper, about one-thirtieth of an inch in thickness, and perhaps twelve inches by six. This thin plate forms the basis on which any amount of pure copper may be deposited. Particles of pure copper, by the electric action, separate themselves from the crude plate of pimple metal, and attach themselves to the thin plate of pure copper. By this means plates twelve inches by six, and an inch thick, are produced, fitted to use in various ways for casting or rolling. The metallic impurities of the pimple copper fall down as a residue, which has a value for some purposes.

M. Heeren, of Hanover, makes brass by electro-deposit. Brass is a compound of copper and zinc, and he brings these two elements together in the trough. An article of any kind, which is to be covered with brass, is placed in a hot solution containing, among other chemicals, sulphate of copper and sulphate of zinc; and an electric current is sent through the bath. As copper is more electro-negative than zinc, and separates more easily from its solution, the deposit would be wholly of copper under average circumstances; but by adopting means to retard the action of the copper, and accelerate that of the zinc, the two metals are deposited in the proportion to constitute brass. Mr W. H. Bradbury invented a mode of depositing pure zinc on an engraved copper-plate, with such exquisite thinness and regularity as to preserve all the fine lines of the engraving. In one hour a layer may be thus applied, from which fifteen hundred to two thousand impressions can be taken; and then it may be stripped off, and a new layer deposited. The object held in view is, to multiply greatly the number of impressions that may be taken from any one engraved copper-plate.

The manufacture of electro-plate has now become a very large and important branch of industry, chiefly at Birmingham. Cups and competition trophies for all kinds of contests; presentation plate, dinner services, tea and coffee services in various degrees of completeness; forks and spoons, cruet-stands, liquor-stands, nut-crackers—are now made of electro-plate, in immense quantities; a thin layer of pure silver being deposited on a foundation of nickel, German silver, or some other white metal.

The making of large copper or bronze statues by electricity instead of by casting, is another department of the art which is making great strides. Between the years 1861 and 1866, Messrs Elkington produced in this way statues of Crompton, Goldsmith, the Queen, the Prince Consort, Lord Hill, Mr Fielden, Lord Howe, General Murray, Lord Hopetoun, Lord Combermere, General Seaton, and the Earl of Eglintoun, varying in height from 6 feet to 134 feet. The last-named colossal statue, that of the Earl of Eglintoun, weighs two tons. There is a trough or deposit-tank at the works of this celebrated firm, 15 feet long, 9 feet wide, and 9 feet deep, that will contain 6600 gallons of acid solution.

The French are also making great progress in the art. M. Oudry has taken electro-casts of the bas-reliefs on Trajan's column at Rome, covering 700 square yards. He has also coated many thousands of the iron lamp-posts of Paris with copper by electro-deposit, as well as numerous fountains, &c., producing most of the good effects of bronze at a much smaller expense.

**ELECTROPHONE**, an instrument devised by Dr Strehill Wright for producing sound by electric currents of high tension. In its simplest form, the

closed together together by a heavy weight or screw. Such an instrument, when its plates are connected with the terminals of a small induction-coil, forms a sonorous condenser, the note of which varies with the rapidity of action in the electrotonic or contact-breaker. The more complicated electrophone communicated to the Royal Scottish Society of Arts, 25th April 1864, by Dr Wright, of which a diagram is shown in fig. 1, is composed of four curved plates of the thinnest sheet-zinc, each two by four feet, arranged as in the figure, and each separated from its neighbour by a double layer of imitation silvered paper, the silvered sides being in apposition to the zinc. The plates 1 and 3 and 2 and 4 are connected by fine wires, *c* and *d*, which also connect the instrument with the induction-coil. When this instrument is connected with a small coil, the terminals of which afford a spark almost inaudible, it becomes charged and discharged with each impulse of current, each charge being attended by a sonorous tap given out by the whole mass of metal thrown into vibration, and the rapid succession of taps producing a prolonged trumpet-note, the power of which may be increased by adding battery-power to the coil. The electrophone has been recommended by its author for use as a telegraphic relay capable of giving two or four signs with a single wire, with

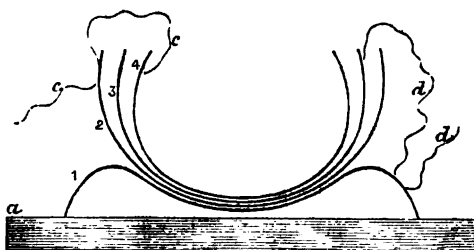

Fig. 1.

the advantage over other relays that perfection of contact was not necessary to its working. Fig. 2 shows the mode of working the electrophone as a double relay with four signals and the galvanometer of Thomson;

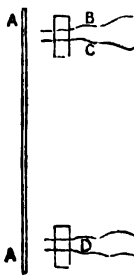

Fig. 2.

table instrument to report to a large audience results of processes which can only be rendered sensible by the most delicate galvanometric apparatus. Thus, the effect of acids and salts on the conductivity of water and flame, the retarding effect of diaphragms and of distance in various solutions between the elements of the voltaic pile, and even the most difficult of all experiments, the determination of the slightest variation in the electric equilibrium of muscle and nervous tissue,

nomena hitherto only perceptible to a single close observer may be rendered manifest to the thousands who crowd the lecture-rooms of popular scientific institutions. Fig. 3 shows the adaptation of the

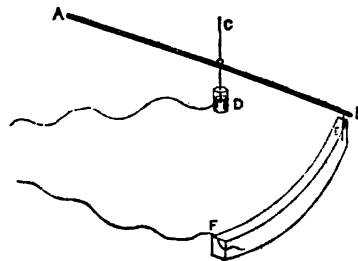

Fig. 3.

electrophone to the galvanometer. AB represents the needle of the galvanometer suspended by a silk fibre, C; D is a small vessel of mercury communicating by a fine wire with the centre of the needle; while a similar wire, attached to the end of the needle B, dips into the curved trough EF, containing distilled water. The wires inserted into D and F connect the coil with the electrophone, the current passing through F, E, B, D. When the needle is deflected, the tract of water between E and F is shortened, and the electrophone gives forth a gradually increasing sound. By a delicate system of levers attached to the wrist, as in the Sphygmograph (q. v.), the rhythm and character of the human pulse, and its variation in disease, may be indicated to the class by the physician. Further, the electrophone may be adapted to the telephone by placing the primary wire of the induction-coil in connection with the membrane of the latter instrument (see TELEPHONE), and thus a song gently sung in one place may be repeated in trumpet-tones in another hundreds of yards distant.

**ELEPHANTIASIS** is a term applied to two varieties of skin-disease, in which the limbs, from their enlargement, and from the changed condition of the skin, have a slight resemblance to those of the elephant. There is the *elephantiasis of the Greeks*, which is usually regarded as the same as the eastern leprosy, and as the *spedakleth of Norway*; and the chief features of which are described in the article **LEPROSY**. In this affection, the size of the limbs and the state of the epidermis are comparatively slightly altered. In the *elephantiasis of the Arabs*, which seems to be identical with the *Barbadoes Leg* (q. v.), there is great enlargement of the affected parts, and the skin is much thickened.

**ELLEZE'LLES**, a large village of Belgium, in the province of Hainaut. Linen-weaving is extensively carried on. There are several flour-mills, breweries, and a salt-refinery. Pop. 6200.

**ELLIS, ALEXANDER JOHN, F.R.S., F.S.A.**, was born at Hoxton in 1814, and educated at Shrewsbury, Eton, and Trinity College, Cambridge, taking his B.A. degree in 1837. His name by birth was Sharpe, which was changed by royal license in 1825. He was elected a Fellow of the Royal Society in 1864, and of the Society of Antiquaries in 1870. He was president of the Philological Society during 1872-1874, and is a member of the Philosophical and Mathematical Societies of London. Among his numerous and valuable works may be noted: *Alphabet of Nature* (1845); *Essentials of Phonetics* (1848); *Universal Writing and Printing* (1856); *Early English*

**ELLIS, WILLIAM**, an eminent English missionary, was born in the year 1795. In January 1816, he sailed with his wife for the South Sea Islands, as a missionary of the London Missionary Society, and laboured there for nearly ten years. He set up in Tahiti the first printing-press in the South Sea Islands. In 1824, he returned to England, on account of the illness of his wife. He was for some years employed at home in the business of the London Missionary Society. In 1826, he published a *Narrative of a Tour through Owhyhee*; and in 1829, *Polynesian Researches*, 2 vols. In 1839, he published a *History of Madagascar*, 2 vols., compiled from government papers, and information received from missionaries. In 1835, his wife died, and two years afterwards he married Miss Sarah Stickney, who for many years conducted a school for girls at Hoddesdon, in Hertfordshire, and who is well known as the authoress of many popular works, among which are *The Women of England* (1838), *The Daughters of England* (1842), *The Wives of England* (1843), *Hearts and Homes* (1848—1849), and *The Mothers of Great Men* (1859). Her works are all of an excellent moral and religious tendency, and have been very widely circulated both in Britain and America. She was educated among the Society of Friends, to which her parents belonged.—In 1853, Mr E. was sent to Madagascar by the London Missionary Society, to inquire into the state of things in that island, and particularly into the condition and prospects of the Christians there. In 1859, he published an interesting and valuable work, entitled *Three Visits to Madagascar, during 1853—1856, with Notices of the People, Natural History, &c.*, a work to which we are largely indebted for our present information concerning that island. In his *Polynesian Researches*, as well as in this work, Mr E. gives much information concerning the inhabitants, scenery, and productions of the countries which he visited, and few works of greater general interest or higher value have come from the pens of modern missionaries. In 1867, he published another work, the nature of which appears from its title, *Madagascar Revisited, describing the Events of a New Reign, and the Revolution which followed, setting forth also the Persecutions endured by the Christians, and their Heroic Sufferings, with Notices of the Present State and Prospects of the People*. He died in 1872.

**EMBOLISM** (derived from the Greek word *embolon*, a plug) is the term employed by recent pathologists to designate the plugging-up of a vessel by a clot of coagulated blood-fibrin, by a detached shred of a morbid growth from a diseased cardiac valve, &c. It is in cases of ill-nourished, broken-down constitutions, or after a protracted or a debilitating illness, that the morbid tendency of the fibrin to coagulate spontaneously within the veins chiefly exists, and in such cases very trivial circumstances may call it forth, especially if they lead to any pressure on the vessel. Clots, or portions of a clot, may be transported by the blood-current from the venous system to the right side of the heart, and block up the pulmonary artery either entirely or in part: if the occlusion is entire, sudden death is produced; while, if it is only partial, gangrene, or inflammation of a part of the lung, commonly ensue. Many of the sudden deaths of women in child-bed (till recently quite inexplicable) are due to this cause, the plug being formed in the inflamed uterine veins, or possibly, in some cases, in the right side of the heart, and passing from thence to

the arterial system. A detached fragment of a diseased tricuspid or aortic valve of the heart, or a separated fragment of coagulated fibrin, may be driven onwards in the blood-current, and enter and occlude some of the cerebral arteries, causing softness of the brain, by cutting off the due supply of nourishment. For further details, the reader is referred to an exhaustive treatise on this subject published a few years ago by Cohn, entitled *Ueber embolischen Krankheiten*.

**EMETINE** is the alkaloid which forms the active principle of ipecacuanha root. It is a yellowish-white powder, which is slightly soluble in cold water, but dissolves readily in alcohol. When taken internally, it exhibits violent emetic properties, 1/10th of a grain being sufficient to cause vomiting.

**EMMANUEL COLLEGE, CAMBRIDGE**, was founded in 1584 by Sir Walter Mildmay, Chancellor of the Exchequer and privy-councillor in the reign of Queen Elizabeth. The foundation fellowships are thirteen in number. These fellowships are open to all her Majesty's subjects, and a candidate becomes eligible to them on proceeding to the degree of B.A. or any equivalent degree. All the foundation fellows are obliged to proceed regularly to the further degree in Arts, Law, Medicine, or any other faculty they have selected. There must be four of them always in priest's orders; and any who are not tutors or bursars in the college, are bound to be in orders at the end of the seventh year of their fellowship, at the risk of forfeiting it three years afterwards. The college also possesses two fellowships and four scholarships on Sir Wolstan Dixie's foundation (but the Dixie fellows have no voice in college affairs, nor any claim to the offices or dividends of the college); 18 scholarships (2 of £80 a year, 10 of £60, and 6 of £30), paid from the general revenues of the college; five of £30 a year, founded by Dr Thorpe; and other seven (4 of £32, 2 of £50, and 1 of £16), for which candidates from certain schools have a preferable claim. The patronage of the college consists of 24 benefices, situated in the eastern and south-western counties of England; and of two schools, one in Norfolk, and the other in Suffolk. In 1873, this college had 298 members of senate, 74 undergraduates, and 455 members on the boards.

**ENCEPHALOCOELE** (derived from the Greek *encephalon*, the brain, and *cele*, a tumour) is the term applied to a tumour projecting through the skull, in one of the parts where the bones are incomplete in infancy, and consisting of a protrusion of the membranes of the brain, containing a portion of brain itself. The most common situation of such tumours is in the middle line and at the back of the head. Surgical interference is scarcely ever justifiable, and all that can usually be done is to give uniform support to the tumour, and to defend it from injury.

**ENCHONDROMA** is the term employed in Pathological Anatomy to signify an abnormal cartilaginous growth. These growths most commonly occur in connection with the bones, and they are not unfrequent in some of the glandular structures. See TUMOURS.

**ENCUMBERED ESTATES COURTS.** See INCUMBERED ESTATES COURTS in SUPP., Vol. X.

**ENDERMIC AND HYPODERMIC METHODS OF TREATMENT.** These terms are, as the names imply, used to designate certain methods of making the skin an agent for the reception of



small puncture, which must not be at the lowest part of the bladder, gently pressing out the fluid contents, and then injecting a medicinal solution, by means of a small syringe, through the puncture into the emptied sac; or, if the medicine is in the form of powder, it may be scattered over the raw surface. The endermic method is now almost entirely superseded by the hypodermic method, in which medicines are introduced into the subcutaneous cellular tissue by means of a very finely pointed syringe. For the invention of this process, the science of medicine is indebted to Dr Alexander Wood of Edinburgh. It is chiefly, but not solely, to anodynes that these methods are especially applicable. It has been found that morphia given by Dr Wood's method acts more speedily and more powerfully than when given by the mouth: moreover, the medicine given in this way does not disturb the functions of the stomach, and may be administered in those cases of irritation of that organ in which medicines introduced into it would be rejected by vomiting. A solution of acetate of morphia, carefully freed from any excess of the acid, and of such strength that three minims shall contain one-third of a grain, is commonly employed, the dose varying from one to three minims, or from one-ninth to one-third of a grain of the salt. If the general effects of the morphia (as relief of pain and sleep) are required, any convenient part of the body, as, for instance, the fore-arm, may be selected: the skin, pinched up between the fore-finger and thumb of the left hand, is penetrated by the point of the syringe, and the solution injected. When a local action is required, as in the case of various forms of neuralgia, the solution should be injected as near as possible to the seat of pain. As some patients are remarkably susceptible to the action of morphia administered in this method, it is advisable to begin with the smallest of the above-named doses.

A scientific committee appointed by the Royal Medical and Chirurgical Society of London to investigate the physiological and therapeutical effects of the hypodermic method of injection, have just sent in their Report, which was read in June 1867. Amongst the most important *physiological* facts which were observed, the following may be especially mentioned. Watery solutions of drugs subcutaneously injected were far less rapid in their action than when they were introduced into a vein. On comparing the effects of medicines subcutaneously injected with those produced when they were administered by the mouth, or by injection into the lower bowel, it was found that, in the case of some drugs, the local action was different according to the mode of administration, although the general effects produced were of the same kind. Thus, aconitine given by the mouth affected the salivary glands; when given by the rectum, it caused irritation of the gut; and when given by the skin, it occasioned local pain. The smallest dose fatal to rabbits was, by the mouth,  $\frac{1}{16}$ th, by the rectum,  $\frac{1}{16}$ th, and by the skin,  $\frac{1}{16}$ th of a grain: it was thus five times as energetic when given subcutaneously as when given in the most usual way. The effects of morphia when injected under the skin were also more rapidly manifested and more intense than when given by the mouth or rectum. A solution of podophyllin, which, when administered by the mouth, acts as a powerful cholagogue (bile-provoking) aperient, when injected into the skin, gives rise to free action of the kidneys. The investigations of the *therapeutic* value of this mode of administering drugs were limited by the fact, that many substances (aconitine, for example) give

found to have a very beneficial effect when thus given, and in some cases more permanent relief followed its injection than that of morphia. The value of the latter drug was found to be much increased by this method, the required action being of longer duration, and being produced with greater rapidity and intensity. The same advantages followed this mode of giving quinine in intermittent fevers, but some caution is requisite in giving large doses, as irritation may arise from its presence under the skin. Amongst the conclusions at which the committee arrives are the following: (1) That, as a general rule, only clear neutral solutions of drugs should be employed, decidedly acid or alkaline solutions being apt to cause irritation, and even local ulcers, at the point of application; (2) that, as in the case of podophyllin, symptoms are observed to follow the administration of some drugs by the skin, which are wanting when the same drugs are otherwise administered; and (3) that the advantages to be derived from this method of introducing drugs are (a) rapidity of action, (b) intensity of effect, (c) economy of material, (d) certainty of action, (e) facility of introduction in certain cases, and (f) in some drugs, the avoidance of unpleasant symptoms.

ENDLICHER, STEPHEN LADELAS, a distinguished botanist, was born at Pressburg in Hungary, June 24, 1804. He was educated in his native town, Pesth, and Vienna, and then entered the church which he, however, abandoned in a few years. In 1827, he commenced his botanical and linguistic studies, and in the following year he was placed at the head of the imperial library at Vienna. In 1836, he was appointed keeper of the museum of natural history at Vienna, and in 1840 he became professor of botany in the university, and director of the botanic gardens. E. was much disturbed by the turn political events had taken in 1848, fell into a state of gloom, and in March 1849 put an end to his own life. A few of his works are upon ecclesiastical subjects, but the great bulk of his writings are botanical, the most important being connected with the systematic arrangement of plants. One of his earliest works was *Flora Posoniensis* (1830); in which he describes the plants growing in the neighbourhood of Posen arranged according to the natural system. His most important work *Genera Plantarum secundum ordines naturales disposita*, appeared from 1836 to 1840. In it he follows out with great elaboration the system of natural arrangement. It has had great influence on succeeding botanists, and is still one of the most complete works upon systematic botany. Among his other works are: *Prodromus Flora Norfoliciensis* (1833); *Iconographia Generum Plantarum* (1838); *Mantissa Botanica* (1843); *Mantissa Botanica Altera* (1843); *Grundzüge der Botanik*, written along with Franz Unger (1843); &c.

ENDRÖD, a large village of Hungary, in the county of Bekes-Csanasd, on the Körös, 90 miles east-south-east from Pesth. Pop. 8700. The surrounding district produces much corn, wine, fax, honey, and cattle.

ENSCHÉDÉ, a town in the Netherlands, province of Overysseel, lies about four miles from the Hanoverian boundary, and 30 miles west-north-west of Zutphen. Besides fustians and dimities, cottons for export to Java are largely manufactured. Cotton-spinning, bleaching, dyeing, and calendering also employ many of the inhabitants. There are several benevolent institutions, a Reformed, a Roman Catholic, a Baptist Church, a Chamber of

EPIDEMIO CEREBRAL MENINGITIS is a disease which has been noticed and described by many American physicians since the year 1811, when Dr North specially drew the attention of the profession to it. In 1838—1840, it appeared in France, and committed great ravages in Versailles, where the mortality was 28 per cent.; in Strasbourg, where the mortality was 42 per cent.; in Lyon, Nancy, and other garrison towns. The patients, in these cases, were almost entirely young conscripts; and the disease was regarded as non-infectious. In the spring of 1846, it appeared in the Dublin and Belfast workhouses, boys under 12 years of age being the only victims, while girls under similar circumstances escaped; it likewise appeared in the constabulary depot, in the same year, amongst the recruits. In 1863, it was very fatal in the United States. In 1865, it ravaged West Prussia: of 2000 cases recorded, half died; and of 347 cases, 330 were under 14 years of age. In this epidemic, no mention is made of the purple spots which excited such alarm in Ireland; and in the United States, two forms of the disease are recognised—one marked by shock, weak pulse, purple limbs, and coma, death happening within the first day; the other presenting signs of cerebro-spinal mischief, such as tetanoid spasms, and death here occurring in three days. Purple spots were present in 27 out of 44 cases.

We now pass to the consideration of the so-called *Black Death*, which, during the two years 1866 and 1867, caused such intense alarm in Ireland, and especially in Dublin. The history of this disease is as follows: A healthy medical student, aged 19, residing in Dublin, fell ill with chilliness and *malaise* about noon on March 18, 1866. When he was visited in the evening, it was found that he had vomited frequently and was very prostrate; purple blotches appeared on his skin during the night, and about noon next day, he suddenly fell into stupor, and was dead at two, or about 26 hours from the apparent commencement of the symptoms. Drs Stokes and Benson, who, with Mr Croly, saw the case, at once recognised it as presenting a novel type of disease. A girl, aged 18, presented similar symptoms on April 2, but recovered. Fatal cases were recorded on May 12, 13, and 17. According to Dr Mapother—from whose excellent Report 'On the Malignant Purple Fever Epidemic in Ireland,' read before the Epidemiological Society in July 1867, the materials of this article are almost entirely drawn—it appears that 63 fatal cases had been registered (up to July) in the Dublin district, exclusive of eight deaths amongst soldiers. This able physician gives the following description of the symptoms, which include two types of very different severity, and in this respect he agrees with the American observers. In the graver, life is rapidly extinguished as if by a blood-poison; in the milder, the symptoms are those of inflammation of the cerebro-spinal axis, or its membranes. Dr Stokes, however, regards these latter phenomena as secondary to the essential disease, and believes that they will always appear, if the patient lives long enough for their development. The earliest symptoms are chilliness and a sense of impending danger, and vomiting of a persistent character soon follows. There is constipation till shortly before death, when the evacuations are involuntarily discharged. The tongue is dry; the pulse abnormally compressible, and usually over 100. The dark purple blotches, caused by the escape of dissolved hæmatin (colouring matter of the blood) from the smaller vessels, are situated in

that of a pin's head to that of a walnut, and are often sufficiently raised to be detected by the touch. The skin is dusky and moist, sometimes even bathed in sweat. In some cases, stupor, and in others, delirium and intense restlessness, are the forerunners of death. The rapidity with which this disease runs its course is appalling. A healthy boy, aged 10½ years, sank in less than five hours from the time of his seizure; and of 41 investigated fatal cases, 14 terminated within 24 hours. Of these cases, 21 were females, and 20 males. Youth predisposes very strongly to the disease. No position in life affords exemption; one young nobleman, three medical students, two undergraduates, and several inhabitants of the lowest hovels—the seats of typhus and cholera—were amongst the victims.

With regard to treatment, almost every kind has been tried, and each has been found equally unavailing. The external application of cold to the spine and head, as advocated in various forms of disease by Dr Chapman, deserves a trial. Dr Mapother suggests, that the disease is due, like scurvy, to the want of fresh vegetables as an article of food; and if this view is correct, it is satisfactory to feel that if this terrible malady is incurable, it is at all events preventable. A few cases of this disease have been recorded as occurring quite recently in various parts of England. They would probably have passed unnoticed but for the Dublin epidemic.

ÉPINAY, LOUISE FLORENCE PÉTRONILLE DE LA LIVE D', a French writer, born about the year 1725. At the age of 19, she married her cousin, M. d'Épinay, but the union did not prove a happy one. While her husband was abandoning himself to dissolute courses, she sought the intercourse of philosophers and men of genius. In 1745 she formed a close intimacy with Rousseau, and presented him with a small house (the now famous Hermitage) which stood on one of her husband's estates in the woods of Montmorency. An unfortunate jealousy, however, which Rousseau conceived for Grimm, another friend of Madame d'E., was followed by an open rupture with his benefactress, and in his *Confessions* he scrupled not to malign her by way of vengeance. She spent the remaining twenty-five years of her life in comparative solitude, seeing only a small and select circle of philosophers and litterateurs. When Grimm was obliged to leave Paris, she continued, under the direction of Diderot, his literary correspondence with northern sovereigns. She died in 1783. From the pen of Madame d'E. we have *Conversations d'Emilie* (Paris, 1774), a work on education pronounced by the French Academy to be the most useful that had been published for a number of years; *Mémoires et Correspondance de Madame d'Épinay, renfermant un Grand Nombre de Lettres inédites de Grimm, de Diderot, et de J. J. Rousseau, &c.* (Paris, 1818); *Les Confessions du Comte de \*\*\**; &c.

EQUINIA, or GLANDERS. In the body of this work, glanders has been considered simply as a disease peculiar to animals, and especially the horse. We shall here consider it as a disease affecting man, to whom it is transmissible from animals. It is remarkable that although the disease in the horse and ass has been recognised from the time of Aristotle (who describes it as common in the ass), it was not till the year 1810 that Waldinger of Vienna drew attention to the fact, that special precautions should be taken in the dissection of horses affected with glanders and farcy, inasmuch as the most serious and often fatal consequences might arise

that the disease thus induced in man is identical with that of the horse; and it was not till 1821 that Schilling recognised this important point. It was not till a living physician, Dr Elliottson, published his Memoir *On the Glanders in the Human Subject*, in 1830, that the attention of the medical profession in this country was directed to the subject. In 1837, Rayer, in his Memoir *De la Morve et du Farcin chez l'Homme*, collected all the cases that had been observed up to that date, and gave a complete description of the various forms of glanders both in the horse and in man; and in 1843, Tardieu published his investigations, *De la Morve et du Farcin Chroniques*. It is to these writers and to the brothers Gamgee ('Glanders—Equinia,' by Arthur Gamgee, M.D., and John Gamgee, in Reynolds's *System of Medicine*, vol. i. 1866) that we owe almost all our knowledge of this terrible disease.

In the great majority of cases, the disease is transmitted from the horse, the ass, or the mule to man; but several instances have been recorded in which it has been transmitted from one human being to another. The disease is no doubt generally due to inoculation, but the virus is also probably capable of being absorbed by unbroken mucous membrane. Most of the recorded cases have occurred in man of good constitution and in the prime of life. The four varieties of this disease which occur in the horse have also been observed in man—viz., (1) Acute Glanders, (2) Chronic Glanders, (3) Acute Farcy, and (4) Chronic Farcy.

*Acute Glanders* is the commonest form. The period of inoculation ranges, in the majority of cases, from three days to a week. If there is a distinct wound or abrasion through which the poison has been absorbed, the parts around the broken surface become red, tense, and painful, often before the appearance of any of the constitutional symptoms, such as a general feeling of illness, great depression of the spirits, headache, rigors, increased rapidity of the pulse, and pain in the joints. A characteristic pustular eruption, often accompanied by bullae or blebs, appears on the face and limbs; and abscesses frequently occur on the face and about the principal joints. A yellow, purulent, fetid discharge, often mixed with blood, exudes from the nasal mucous membrane, which is invariably the seat of a pustular eruption, or of ulcerations. The prostration which is observable from the beginning increases during the course of the disease. The pulse becomes weak and frequent, the breathing difficult, the voice feeble, and the bowels very relaxed, the stools being extremely fetid. Delirium now sets in, which is followed by coma and death. Death usually occurs about the end of the second week, but the duration of the disease has been known to vary from three to fifty-nine days.—*Chronic Glanders* is so rare an affection in man that it hardly requires notice. The course of the disease usually extends over several months; and only one case of recovery is reported.—*Acute Farcy* seems only to differ essentially from acute glanders in the fact of there being no affection in the mucous membrane of the nostrils. The cutaneous eruption may or may not be present; in most cases, it is present, and the disease then follows exactly the same course as glanders. When there is no eruption, there is merely an inflammation of the lymphatic vessels and glands, or *Adenitis* and *Angioloecitis* (q. v.), accompanied with the formation of soft subcutaneous tumours at various parts. This form of the disease often terminates favourably, or may merge into *Chronic Farcy*, which is characterised by the formation of an abscess on the forehead or elsewhere,

of the body, open spontaneously, and form very intractable ulcers. The disease usually runs its course in about a year. Of twenty-two cases recorded by Tardieu, six recovered.

Little need be said regarding treatment, since no remedies have been found to exercise any influence in checking the course of acute glanders. Arsenic, combined with strychnia, has been found useful in chronic glanders in the horse, and is recommended by the brothers Gamgee as worthy of trial in man; and some relief might probably be afforded by the application of weak injections of carbolic acid into the nostrils.

**ERCKMANN—CHATRIAN** (EMILE ERCKMANN and ALEXANDRE CHATRIAN), two French men of letters, the first of whom was born 20th May 1822 at Phalsbourg; the second, 2d December 1826, in the village of Soldatenthal, commune of Abreschwiller, both in what was then the French dep. of Meurthe, but is now re-united to Germany as part of the imperial territory of Alsace-Lorraine. E., the son of a bookseller, went through a rather irregular course of study at the college of his native town, went to Paris in 1842 to study law, which he broke off several times, and only passed his third examination in 1857, and finally abandoned the study in the following year. During the interval, he had set himself to make a name in literature, in co-operation with M. Chatrian. The latter, belonging to an old family of glass-makers in Meurthe, ruined by reverses in trade, was acting as tutor at the college of Phalsbourg, when, in 1847, he was introduced to M. Erckmann. From that time the two friends employed their pens in the same work, which they signed with the two names united in one; and it was only about 1863 that the authors informed their readers that the numerous works of fiction, which had obtained a widespread popularity, and were supposed by the general public to be the work of a single writer, were the fruits of their friendly collaboration. Their early works attracted comparatively little notice; and it is said that their first work was rejected by all the newspapers of Paris, and by many provincial journals. In 1844, they published several feuilletons in the *Démocrate du Rhin*, which had just been started: *Le Sacrifice d'Abraham*, *Le Bourgmestre en Boutelle*, &c. which they have since published separately. At the same time they wrote a drama, *Le Chasseur des Ruines*, for the Ambigu-Comique, which the theatre accepted, subject to changes, which they refused to make. They produced another drama, *L'Alsace* in 1814, for the theatre of Strasbourg, which was suppressed by the prefect on the second representation. They wrote numerous novels at this time for different journals, some of which were very little noticed, while others remained in MS. for years. Despairing of being able to live by their pens, E. recommenced his law studies, and C. obtained a situation in the office of the Eastern Railway. It was not till 1859 that *L'Illustre Docteur Mathéus* (1859, in-18; 3d edition, 1864), published by the Librairie-Nouvelle, gave a certain éclat to the collective name of Erckmann-Chatrian. *Le Fou Yégo!* (1862, in-18) is one of a series of novels, the subjects of which are taken from their national history, and gives a picture of the invasion of 1814. *Le Concert de 1813* (1864) and *Waterloo* (1865) are fragments of an autobiography, and are supposed to be the recollections of a common soldier, and relate the disastrous campaigns of 1813 and 1814. These may be called the gems of their collection. *Le Joueur de Clarinette* (1863), a simple story of a village

and is less favourably spoken of as a work of art. It pictures the life of the modern French workman. In 1866 appeared *La Maison Forestière*, and *La Guerre*; in 1867, *Le Blocus*, which has been translated under the title, *The Blockade of Phalabourg*; a historical romance in 1868, *Histoire d'un Paysan*; in 1869, *Le Juif Polonais*, a play. Among their latest works are *The Story of the Plébescite by one of the 7,500,000 who voted Yes* (trans. in *Cornhill Magazine*, 1871—1872); and *Brigadier Frederic: a Story of an Aleatian Boile* (Eng. trans. 1875).

ERNST, HEINRICH WILHELM, an eminent violinist, born at Brünn, in Moravia, in 1814. He early became a pupil of the Vienna Conservatorium, studying under Seyfried and Mayseder. At the age of 16, his talents excited much interest on his appearance in public at Munich, Stuttgart, and Frankfurt; and he soon afterwards performed in Paris. His first visit to London was in 1843; and he returned in subsequent years, spending the intervals in Paris and in different parts of Germany. His playing was characterised by immense brilliancy, combined with passion and sentiment. He suffered much from acute neuralgia, which latterly interfered with the exercise of his art; and the last seven years of his life were spent at Nice, where he died, October 8, 1865. E.'s compositions have generally a bravura character, and include works for the violin and orchestra, quartets, &c.

ESCHWEILER, a town of Rhenish Prussia, in the circle of Aachen, and nine miles east-north-east from the city of Aachen (Aix-la-Chapelle), is a station on the railway between Aix-la-Chapelle and Cologne, and stands at the confluence of the Inde and Dente. It has extensive manufactures of ribbons, woollens, canvas, needles, iron-wire, and machinery, also of wax-cloth, lace, glass, vitriol, and vinegar. In the vicinity are mines of zinc and lead. Pop. (1875) 15,540.

ESKAR, a term applied in Ireland to certain objects in the superficial drift, which occur in several parts of that country, and are not unknown in Scotland, but which are more abundant in Sweden than in any other known country, being there recognised as *osar*. An *eskar* is generally a long linear ridge of rounded gravel, including pieces of considerable size; in Sweden, they often have rough erratic blocks deposited upon them. It is an unsettled point whether they are connected with glacial action; if connected with it, the whole appearances and consistency demonstrate at least subsequent marine action. There is a remarkable eskar on a moor spreading below Darrington Law, in Berwickshire (900 feet above the sea); another, about a mile long, has been pointed out amidst a vast alluvial accumulation at St Fort, Fifeshire.

ESQUINTLA, or ESCUINTLA, a town of the state of Guatemala, Central America, 25 miles south from Guatemala, on the river Michatoya, which falls into the Pacific Ocean. It has a fine church. Pop. 6000, consisting in great part of Indians.

ESSENCES. This term is frequently used as synonymous with volatile oils.

EVANS, MISS MARIAN, known under the *nom de plume* of 'George Eliot,' was born in Warwickshire about the year 1820. Before she became known as the author of the remarkable series of fictions with which her name is popularly associated, she had already acquired reputation in the literary circles of the metropolis as a writer of distinguished ability. She contributed largely to the *Westminster Review*, of which she was at one time editor; and trans-

lated *Le Homme à l'épée* appeared in 1800, and also Feuerbach's *Essence of Christianity*. During 1857, there appeared in *Blackwood's Magazine*, with the signature of George Eliot, a series of stories under the title of *Scenes of Clerical Life*, the very unusual merit of which instantly attracted attention. They seemed to proclaim with great distinctness the advent of a new novelist of fresh and original power. It was from the first sufficiently well understood that the signature was a mere *nom de plume*; and no little curiosity was excited as to the personality of the author unknown. This feeling was much deepened by the publication in 1858, by the Messrs Blackwood, of the novel of *Adam Bede*, which attained an immense success, and at once secured for the writer almost undisputed rank with the most eminent novelists of the day. This was followed, in 1859, by *The Mill on the Floss*, which amply sustained the reputation of the writer; and in 1861 by *Silas Marner, the Weaver of Raveloe*, a tale in one volume, which, as to art, is perhaps the most perfect of any of this series of works. In 1861, the *Scenes of Clerical Life* were republished from *Blackwood's Magazine*, to meet with a renewal of the favour with which they were originally received; and in 1863, *Romola*, an elaborate historical novel of Italian life, was published by Messrs Smith, Elder, & Co., in whose *Cornhill Magazine* it had previously from month to month appeared. This work has never had quite the popularity of its predecessors, but is considered by a selecter circle of readers—and perhaps on the whole with justice—the greatest intellectual effort of the author. Meantime—though the avowal has never in any formal fashion been made—it had by degrees become positively certain that Miss E. was the 'George Eliot' of these works; and by net a few competent critics a place had been frankly assigned her at the very summit of this branch of our literature. *Felix Holt, the Radical*, published in 1866 by Messrs Blackwood, was distinctly the book of the season, and was almost everywhere received with acclamation. *Middlemarch, a Study of English Provincial Life*, began to be published in divisions by Messrs Blackwood in 1871. It was completed in 8 divisions, the last of which was issued in 1872, and simultaneous with it the entire work appeared in 4 vols. The divisions had an enormous circulation, and enhanced Miss E.'s great reputation. *Daniel Deronda* was published in the same way in 1876. Miss E. has also published poetry of a high degree of merit. *The Spanish Gipsy* was published by Messrs Blackwood in 1868; in 1869 appeared *Agatha, a Poem*; *Macmillan's Magazine*, in 1870, contained the *Legend of Jubal*, a poem of great power; and in 1871, *Armgart, a Dramatic Poem*. In 1874, a collection of her poems was published, with the title, *Legend of Jubal, and other Poems*.

EXHIBITIONS, INDUSTRIAL. Since the article on this subject first appeared in the *Encyclopædia*, several international exhibitions have been held—one in 1862 in London; the next in 1865 in Dublin; the third in Paris in 1867; in 1873, the great universal exhibition of Vienna; that of Philadelphia in 1876; &c. That of 1862 was held in a vast brick building, lighted by a roof and two immense cupolas of glass, designed by Captain Fowke, R.E., and erected on a large space of land acquired by the Royal Commissioners of the Great Exhibition of 1851, adjoining the beautiful garden of the Horticultural Society at South Kensington. The space covered was 1,291,800 square feet, or about 17 acres, including some portions of the buildings of the garden, lent by the Horticultural Society, for refreshment-rooms, &c.

by objects exhibited, besides 20,000 square feet of wall and other vertical space made by internal partitions, &c.; to which must be added 93,220 of horizontal and vertical space occupied by works of art, arranged in one of the most admirably constructed galleries ever designed for such a purpose. The entire cost of this gigantic affair was £321,000. This was secured against all risk of failure by a voluntary guarantee entered into by 1152 gentlemen of all ranks, who pledged themselves in various sums amounting, in the aggregate, to £450,000. Notwithstanding much opposition and ill-feeling, the International Exhibition of 1862 proved a great success. Like its predecessor in 1851, it gave a vast impetus to trade generally, and it enabled the public to form correct opinions upon the progress of our manufactures, and their shortcomings when compared with others.

The next exhibition of importance was that held in Dublin in 1865, which was originated by a company, whose object was to establish the principle of decennial exhibitions, and, if possible, make this one pay the expense of erecting the magnificent building in which it was held, and thereby form a permanent home for such exhibitions and other useful purposes in future. This building was of brick, covered with stucco, and the roof of glass and iron, light but commodious galleries running entirely round the interior. The whole surface occupied by the structure was 5700 square yards. It was, in every respect, well adapted for the purposes for which it was raised, and had an extensive pleasure-garden nearly surrounding it. The exhibition was successful in everything but its pecuniary results. It was amply patronised both by foreign exhibitors and visitors, and like that of 1862 in London, and the previous ones of Dublin and Paris, it combined fine arts with the manufactures, mining, and other industries.—The year 1867 witnessed, in Paris, the greatest, up to that time, of all international exhibitions, both with respect to its extent, and to the scope of its plan. Its site was on the Champ-de-Mars, the great military parade-ground of Paris, and it occupied the enormous space of 37 acres. It consisted of a large building of an elliptical form, arranged in twelve concentric circles, with a small open central garden. The outer circle was much more lofty and broader than any of the others, was roofed with corrugated iron, and lighted with clerestory windows, and was devoted to Machinery of all kinds, and to the processes of manufacture in various branches of industry. Outside this circle were placed practical illustrations of the Food department, in the form of restaurants of all nations—the exhibition of specimens of food substances being in small courts within the outer wall, or back to back with the restaurants. The first circle within that for Machinery was for Metallurgy, Chemistry, Dyeing, &c.; then followed Textile Materials, Clothing, Household Furniture, Personal Ornaments, Plate, Porcelain, &c.; then matters relating to General and Special Education. Then came the Gallery of Fine Arts, in which the paintings, sculpture, and other fine-art works of all nations were exhibited; and within this circle, again, was another, in which an archaeological collection from each country was displayed, for the purpose of shewing the rise and progress of industrial art in every country. This was a novel and most valuable addition, admirably conceived and carried out. Another most important feature in the Paris Exhibition was the Park, or out-of-door portion, which occupied by far the larger part of the whole space. In this were shewn actual examples of the styles of domestic and palatial architecture

of various tribes, such as the Russians, Tartars, and Samoyeds of the Russian empire, the Bedouin Arabs, &c. The beasts of burden of different nations, such as horses, camels, &c., were also shewn, and all kinds of civil and military erections of general importance. The Exhibition had great and deserved success; it was visited by most of the principal monarchs of the world, and vast multitudes of people of all nations. For some reason, however, no reliable statistics have been published, and pecuniarily, it did not succeed.

Since the Paris Exhibition of 1867, there have been important ones held in Sweden, 1868; Moscow and Copenhagen in 1872; and the greatest of all exhibitions hitherto held, the Vienna Universal Exhibition of last year (1873). The two Scandinavian ones were confined to the products of Sweden, Norway, and Denmark. The Moscow Exhibition had a quasi-international character. It was organised by the Moscow Polytechnic Society, and merely patronised by the government. It was, however, on a large scale and admirably managed—its various buildings, &c., completely occupied the Alexandra gardens round two sides of the Kremlin, a length of over two English miles, and the great riding-school. In its arrangement the greatest skill was shewn, and its classification was the best and most scientific which has ever yet been attempted. Each special group of objects had separate buildings. Thus, for instance, medical science, which was fully represented, had a series of buildings, three model hospitals, besides those in the military department—all fully furnished—dispensaries, a pharmacist's shop, and a garden in which all the medicinal plants were growing; an exhibition of all kinds of surgical instruments and appliances, and a great variety of other matters appertaining to medicine and surgery; a dentist's establishment, with everything appertaining to dentistry, whether to the treatment of natural teeth, or the manufacture of artificial ones; and so on. Should ever a great international exhibition be carried out on the same grandly conceived plan, it will be the greatest educational effort possible.

The two Scandinavian ones in magnitude exceeded those held in Dublin; they were very interesting, and were under good management successful in all respects.

The Vienna Exhibition of 1873 far exceeded in magnitude any previous one, and although unfortunate in many respects, was, upon the whole, an event of which Austria has good cause to be proud; and its ultimate results, there is every reason to hope, may shew great commercial benefits, as it brought every civilised nation to Vienna, and doubtless will be the means of extending Austrian commerce, by making the general excellence and great variety of Austrian and Hungarian manufactures better known. The main building, which still remains, is the largest ever constructed, being nearly four times the size of that in which the Paris Exhibition of 1867 was held: it consists of a vast gallery or nave, 2980 feet in length, in the exact centre of which is placed a great central hall, 426 feet in diameter, covered with a conical iron roof and lantern rising to the height of 160 feet. At each extremity of the main avenue, another gallery, 660 feet in length, is placed transversely to the chief one, and another of similar length crosses the nave at a distance of 114 feet from each of these terminal transepts, whilst each of these pairs have their extremities connected by ranges of offices. Sixty-six feet from the central rotunda on each side is a similar transept connected by two others parallel to the line of the main avenue, and

by the terminal transepts at each end of the building, the two portions of the main avenue are crossed by ten other transepts 132 feet apart. These ten galleries are each 528 feet in length, and both these and those at the ends and centre are of the uniform width of 60 feet, whilst that of the nave is 82 feet. The height of all the galleries is about 50 feet. Vast as the extent of this structure is, it was found to be altogether insufficient, and halls had to be constructed for the fine arts, the machinery, and the agricultural exhibitions, besides numerous annexes and buildings for special exhibitions, altogether amounting to as much as the main building. The entire extent under roof is said to have exceeded sixty acres. A severe visitation of cholera, and a deplorable monetary crisis, occurred in Vienna during the exhibition, but nevertheless it was visited by the chief sovereigns of the world, and they and the official staffs of the various National Commissioners, and the juries, were treated with a liberal hospitality which has never been excelled. The next great International Exhibition was that of the United States of America, which was held in honour of the centenary anniversary of American independence, in Philadelphia in 1876. The main building was 1876 feet long, and 464 feet broad. The machinery-hall was 1400 feet long, and there were numerous other large buildings.

EYRE, EDWARD JOHN, a distinguished explorer and English colonial governor, is the son of the late Rev. A. Eyre, Vicar of Hornsea, and Rector of Long Reston in the East Riding of Yorkshire, and was born in 1817. He was educated at the grammar-schools of Louth and Sedbergh. He was originally intended for the army; but at the age of 17, he resolved to emigrate, and seek his fortune in Australia. After serving a short apprenticeship with a settler on the Hunter River in New South Wales, he became a squatter on his own account in the same colony, and invested in the business a capital of £400. The idea struck him, that cattle might be profitably driven overland by the Murray River from New South Wales to South Australia—thus saving the difficult and circuitous voyage from Sydney to Melbourne. He made the attempt; and it proved so successful that, with the profits, he was able to purchase an estate on the Lower Murray, where he took up his abode. He was appointed resident magistrate and protector of aborigines. The natives had been cruelly ill used by the colonists who had penetrated farthest inland, and had even been shot and poisoned with impunity. Mr E. sought to remedy these evils, and discharged the difficult task of settling the disputes between the settlers and natives in a manner admitted by all to have been most judicious, just, and humane. A movement was made, in 1839, to explore the unknown region between South and Western Australia, lying north of the Great Australian Bight. Two routes were suggested—one north of Lake Torrens, the other along the sea-coast. E. warmly advocated the former, and offered, if it were adopted, to head the expedition, and pay one-third of the expense; and the subscribers to the fund at Adelaide accepted his offer. In 1840, he set out with a company of four Englishmen and two native boys; but the expedition proved unsuccessful; and after wandering for months along the muddy or sandy shores of Lake Torrens, the party were compelled to return to Port Lincoln, whence they were conveyed to Adelaide by a vessel sent for their relief by the governor. Then E. determined to attempt the southern route. In February

named Barter and three aboriginal boys. Barter was killed, two of the boys deserted, and E. was left to complete the journey with one boy, named Wyllie, a native of Western Australia. For a week at a time, E. was without water, and he would have finally fallen a victim, like other Australian explorers, to fatigue and thirst, had he not obtained a fortnight's rest in a whaler anchored off the coast. He reached King George's Sound on the 7th July, having thus accomplished a journey of 1000 miles in four months in one of the most sterile regions known to exist. His journey proved that no route of any value can be opened up along the southern coast of Australia, and that no fertile spots break the waste—a fact of immediate importance so long as Western Australia remains a penal settlement. E. published a Journal of his Expedition, in which he included an account of the natives and their relations with Europeans. In 1845, he returned to England; and in the following year, he received the appointment of Lieutenant-governor of New Zealand, under the governor, Sir George Grey. It was his special duty to administer the government of the middle island. At the expiry of the customary six years' service of a colonial governor, E. returned to England, and received the appointment of Lieutenant-governor of St Vincent. In 1862, he was appointed governor of Jamaica, for which his success in dealing with the inferior races in Australia seemed pre-eminently to fit him. When, in October 1865, the negro disturbances broke out in Jamaica, E., acting in conformity with the almost universal feeling of the white population, and guided by his knowledge of the negro character, resolved to check the progress of disaffection among an ignorant and half-savage population by prompt and energetic measures. A general panic prevailed. Martial law was proclaimed under a local statute. A Mr Gordon, believed to have taken a leading part in the rebellion, was hurriedly tried on a Saturday, by court-martial, and hanged on the following Monday, after the sentence had been confirmed by Eyre. The insurrection was successfully repressed. Complaints, however, were made that Gordon had been condemned irregularly and on insufficient evidence; and that other excesses of severity had been committed. A commission sent out to inquire into the facts came to the conclusion that such was so far the case, and E. was recalled. He returned to England, and took up his abode at Adderley Hall, near Market-Drayton, Salop. English opinion was much divided as to the course he had taken. Those who disapproved of his conduct, represented by Mr John Stuart Mill, M.P., and Mr P. Taylor, M.P., resolved to prosecute him on a charge of murder. An Eyre Defence Fund was raised, and a committee appointed for his defence, in which the most prominent place was taken by Mr Thomas Carlyle and Sir Roderick Murchison. E. was summoned before a London police court, but declined to attend, on the ground of non-residence. On the 25th of March 1867, he appeared before the petty sessions at Market-Drayton, where the charge of murder made against him was dismissed by the magistrates. No one doubts that E. is a brave, kind-hearted, and honourable English gentleman; but it must be admitted that he committed a grave error of judgment in endorsing the sentence against Mr Gordon, without seeing that the evidence was sufficient, led away, as he no doubt was, by the panic around him.—See *Journal of Expedition of Discovery by Eyre, and Life of Eyre*, by Hamilton Hume (1867).



**FACTORY ACTS.** Important extensions and various modifications of the Factory Acts have recently been made. The acts 23 and 24 Vict. c. 78, 26 and 27 Vict. c. 38, and 27 and 28 Vict. c. 98, have extended the provisions of the Factory Acts to bleaching and dyeing works, calendering works, and works in

which the processes of finishing, hooking, or lapping, or of making and packing yarn or cloth of cotton, wool, silk, or flax, are carried on.

The provisions of the acts were applied to persons employed in lace factories by the act 24 and 25 Vict. c. 117. The Factory Acts Extension Act, 1864 (27 and 28 Vict. c. 48), refers specially to certain trades regarded as more than usually unwholesome—namely, the manufacture of earthenware (except common bricks and tiles), of lucifer-matches, of percussion-caps, of cartridges, paper-staining, and fustian-cutting. It provides that every factory to which it applies shall be kept in a cleanly state, and be ventilated in such a manner as to render harmless, so far as is practicable, the gases, dust, or other impurities generated in the process of manufacture that may be injurious to health; and it gives the manufacturers power to make special rules, with the sanction of the Home Secretary, for the guidance of the work-people, so as to prevent the requirements as to cleanliness and ventilation from being infringed. The Factory Acts Extension Act, 1867, extends the scope of the acts very considerably, making them apply to (1) blast-furnaces, or premises in which the process of smelting is carried on; (2) copper mills; (3) mills for converting iron or steel; (4) foundries for iron, copper, brass, or other metal; (5) premises in which mechanical power is used in the manufacture of machinery, of any article of metal, or in the manufacture of india-rubber or gutta-percha; (6) premises in which the manufacture of paper, of glass, or of tobacco, letter-press printing, or bookbinding is carried on; and lastly (7) any premises constituting one trade establishment in which fifty or more persons are employed in any manufacturing process. The act makes a number of modifications of the preceding acts, of which the principal only can be pointed out. It gives power to the Home Secretary, in all trades whose customs or exigencies require it, to authorise the occasional employment of males of 16 beyond the hours allowed by the Factory Acts; to authorise children, young persons, and women to be employed at different hours; to modify the regulations as to fencing machinery; and to modify the arrangements as to holidays, and as to working on Saturday afternoons. These powers the Home Secretary can exercise only within certain narrow limits. Power is also given to him to sanction certain deviations in regard to the hours of labour in some specified trades, such as letter-press printing and bookbinding. The Factory and Workshop Act, 1870, makes additional modifications of the act of 1867, and preceding acts applicable to print-works, bleaching and dyeing works, and works for preserving fruit or fish. A similar act, in 1871, makes modifications where the working of the factory

depends on the weather or season, and for brick and tile factories. It also contains an important provision placing the duty of enforcing the acts on the inspectors and sub-inspectors of factories. By the Act of 1874, the period during which a child, young person, or woman may be employed in a factory is between six in the morning and six in the evening, or seven in the morning and seven in the evening. Such persons shall not be employed continuously for more than 4½ hours without an interval of at least half an hour for a meal. On every day except Saturday two hours are allowed for meals, one hour at least being before 3 in the afternoon. No child, young person, or woman, can be employed on Saturday after half-past one in the afternoon, or for any purpose whatever after two. They cannot, after 1st January 1876, be employed in the recovery of lost time during any hours in which they cannot be employed under the act. After that date, a person of the age of 13 and under 14 shall be deemed to be a child and not a young person, and no child can be employed in any factory if he is under the age of ten. It is urgently necessary to consolidate at some early period all the acts relating to the employment of persons in factories. See WORKSHOP REGULATION ACT.

**FA'RNWORTH**, a town of Lancashire, two miles and a half south-east from Bolton-le-Moors, near the Tonge, a branch of the Irwell. It is a station on the Manchester and Bolton Railway. It has a picturesque embattled chapel, of the 15th century. The manufacture of sail-canvas, and the making of watches, files, &c., are carried on. Pop. (1871) 13,550.

**FARRAGUT, DAVID GLASCOE**, Vice-admiral of the American navy, was born near Knoxville, Tennessee, in 1801; and at the age of eleven years entered the navy as midshipman, under Captain David Porter, in the *Essex* frigate. At the age of 21, he was made lieutenant, and appointed to the Norfolk Navy-yard; in 1833, he commanded the *Natchez*, on the Brazil station, and in 1838, in the West Indies; in 1847, he was appointed to the sloop-of-war *Saratoga*; in 1851, made Assistant-inspector of Ordnance; in 1854, sent to construct a navy-yard in California; and in 1855, with the rank of captain, appointed to the steam-frigate *Brooklyn*, in the home squadron. In January 1862, he was appointed to the command of a naval expedition to act against the Confederates in the Gulf of Mexico; and on April 24, after a heavy cannonade, his squadron passed the forts at the mouth of the Mississippi, and on the 28th, he received the surrender of New Orleans. Ascending the Mississippi, he took Natchez; and aided by a fleet of gun-boats, which had descended the river, made an attack on Vicksburg, which failed; and he withdrew to Pensacola, and operated against the coast of Texas. Raised to the rank of vice-admiral in March 1863, he once more passed up the Mississippi, successfully ran past the heavy Confederate batteries of Fort Hudson, and aided General Grant in the combined attack on Vicksburg, which resulted in its capitulation, July 4. In August 1864, after a furious

monitor was sunk by a torpedo, with the loss of all on board, he succeeded in capturing the forts, which led to the fall of the city. In 1866, he attained the rank of admiral, and a purse of 50,000 dollars was presented to him by the New York merchants. F. died in 1870.

**FECHTER, CHARLES ALBERT**, an actor of some eminence, and formerly a manager of one of the London theatres, was born in London about 1823, his father being a German, and his mother an Englishwoman. When only three or four years old, he went with his parents to France, and was there educated as a sculptor. His predilections were, however, in favour of the stage; and, believing himself capable of interesting the public as an actor, he appeared for the first time at the Salle Molière, in a piece called *Le Mari de la Veuve*. Afterwards, he acted for some weeks at the Conservatoire, and then went with a travelling company, which performed in the principal cities. In 1846, F. performed in Berlin with considerable success; in the following year, at the Vaudeville in Paris, and the St James's Theatre, London. After this, he played by turns at the Ambigu, the *Variétés*, the *Théâtre Historique*, and the *Porte St Martin*. In 1853, he re-appeared at the Vaudeville, where he created the part of Duval in the *Dame aux Camélias*. His acting also brought success to the *Fils de la Nuit* at the *Porte St Martin*, and to *La Belle Gabrielle*, in the performance of which he met with an accident that almost cost him his life. F. was also the original performer in those two melodramas, *Les Frères Corses* and *Pauline*, since so celebrated on the English as well as the French stage. While making these preliminary essays, as if to qualify himself for a still higher class of impersonations, F. used to appear, as the season of the French plays in London came round year after year, at the St James's Theatre. At length he was announced to appear in an English version of *Ruy Blas* at the Princess's, on the 27th of October 1860. This being his first appearance on the English stage, there was considerable interest taken in the performance. F., however, passed through the ordeal triumphantly. He threw himself heart and soul into the character, and so perfectly identified himself with it, that people almost forgot his French accent, in admiring the energy and finish of his acting. On the 20th of March in the following year, he appeared in the character of Hamlet, the highest flight that can be attempted by any actor. There were prophecies of failure and prophecies of success, but neither of them came perfectly true. F., in the performance of this great character, while abandoning the traditions of the English stage, shewed himself capable of appreciating the difficulties he had to contend with, and in some measure of surmounting them. He was the scholar and the gentleman throughout; and it was certainly a curiosity for the English public to listen to an actor who, as it was said at the time, 'went straight from the book to the boards,' and gave a thoroughly independent conception of the character of the Danish prince. Of course, there was much in it that was to be condemned: there was both exaggeration and distortion; while many passages in the play which ought to have told with great effect, seemed to make little impression on him, and consequently little or none on the audience. Still, the impersonation was, upon the whole, one that marked F. as an actor of very high powers. The same may be said of his impersonation of Othello, in which he appeared in the following October. Subsequently, F. became the lessee of the Lyceum Theatre, where he produced

for their success upon dress, scenery, and situations. In 1870, F. paid a successful visit to the United States, whither he returned in 1872.

**FELANITCHE, or FELANITZ** (anc. *Canatic*), a town of the island of Majorca, 27 miles east-south-east from Palma. It is situated in a valley, surrounded by mountains, and is well built, with a number of squares and wide streets. It has a convent and a hospital. On a neighbouring hill, is an ancient Moorish castle, with subterranean vaults. Linen and woollen fabrics are manufactured; rope-making and brandy-distilling are also carried on. There is some trade in the products of the neighbouring country—rice, coffee, sugar, wine, brandy, fruit, and cattle. Pop. 8102.

**FENIAN SOCIETY**, a political association of Irish or Irish Americans, the object of which is the overthrow of the English authority in Ireland, and the establishment of a republic. The etymology of the name has been the subject of some discussion. It is traced to the ancient Irish military organisation called *Fionna Eirinn*, which took its appellation from the celebrated hero of Irish legend, Finn (or Fioan) MacCumbhail. The accounts of this renowned body, with which the bardic literature of Ireland abounds, are most curious. It was designed as a national militia, and its origin is ascribed, by Keating, to Sedna IL, who was monarch of Ireland about 400 years B. C. In time of peace it consisted of three bodies, each formed on the model of a Roman legion, and consisting of 3000 men; but in war, it was capable of being enlarged to any required limit. Candidates for enrolment were required to be of an honourable family, to be irreproachable in morals, and to bind themselves to observe the laws of justice and morality; they were required to be of a certain height, and strong, supple, and vigorous of body; each being submitted, before enrolment, to an ordeal, in which his powers of speed, strength, endurance, and courage were tested by trial with his future comrades. The bardic accounts of some of those conditions are extravagant and amusing in the highest degree, but the generally historical character of the institution is unquestionable; and it subsisted until the reign of Carbry, son of Cormac MacArt, by whom the body of *Fionna Eirinn* was disbanded, and the members having, in consequence, transferred their allegiance to Moorb, king of Munster, suffered an almost total extermination in the battle of Gavra, 284 A. D., which formed the theme of many a bardic poem from the days of Oisín (known in Gaelic legend as Ossian), son of Finn MacCumbhail, downwards.

Adopting the name of this ancient military association, the modern Fenians (or Finians) are a secret association for the purpose of overthrowing the alien ascendancy of the Saxon, and of restoring to the ancient Celtic population their legitimate status and influence in their native country. It had its first seat in America, where the Irish population has largely increased since the famine of 1846—1847. Many of the emigrants being driven from their homes by arbitrary ejection, or from inability to pay rent, carried with them a sense of fancied wrong, which prepared them for almost any enterprise which seemed to promise revenge. Others had been sympathisers, if not participators in the insurrection of 1848; and almost all were deeply imbued with general political and social discontent. By all these, the prospect of a secret organisation for the establishment of Irish independence was eagerly accepted. The most openly active seat of the organisation was in the western states, especially Chicago; but the



It was conducted by a senate, and consisted of 'circles,' each directed by a centre. The duty of the centres was to enrol members, who bound themselves, generally by oath, 'to be faithful to the Irish Republic as at present virtually established;' to instruct and practise them in military exercises; to raise funds for the purposes of the association, especially for the purchase of arms and munitions of war; and to extend the organisation by every means at their disposal. Agents were sent into Ireland, and to the chief seats of the Irish population in England; and while the work of secret enrolment was industriously carried on in Ireland, measures were openly concerted in America, as well for the raising of funds by private contributions, as for the purchase of arms and military stores. Opportunely, too, for the purposes of the enterprise, the termination of the civil war in America set free a large number of military adventurers who had served as privates or as officers in one or other of the American armies, and whose experience of service was turned secretly but most actively to account in the training of the young recruits enrolled in the Fenian conspiracy in Ireland. Newspapers, moreover, both in America and in Ireland, were established or subsidised for the purposes of the conspiracy; and journals, broadsides, ballads, and other inflammatory publications were largely circulated among the peasantry and artisans. Taverns, alehouses, and other places of entertainment were the ordinary places of meeting; and one of the most formidable of the plans of the conspiracy was an organised attempt to seduce the Irish soldiers from their allegiance, and to prepare the way for their deserting to the ranks of Fenianism, when it should have reached the expected degree of maturity. It became apparent, moreover, that in this, unlike almost all similar movements, pains were taken by the organisers to exclude the Catholic clergy, by whom the Fenian confederation had from the first been steadily resisted, from all knowledge of its character and objects, as well as of the names or number of its members in the several localities; and many of the most active of the leaders were distinguished by the freedom of their religious opinions, and by their unconcealed disregard of clerical authority.

For a time, these designs were carefully concealed, and even when a certain publicity was given to them, the scheme appeared so wild and impracticable that it was regarded as an attempt, on the part of a body of unprincipled adventurers, to practise upon the patriotic susceptibilities of the ignorant and excitable Irish, especially in America. By degrees, however, the movement acquired more solidity, and the government ascertained by reliable information that Fenianism, however corrupt in some of its sources, and however wild and extravagant in its aims, was nevertheless a reality with which it had become necessary to grapple. Measures were taken with great promptness and determination. The Habeas Corpus Act having been summarily suspended, all the known leaders in Dublin and in the provincial districts of Ireland (most of them Irish Americans) were at once placed under arrest. The chief journal of the conspiracy was suppressed and seized; additional troops were moved into Ireland, and other measures of repression were vigorously carried out. By these energetic measures, public tranquillity was maintained in Ireland; and although prosecutions were instituted, and a few individual conspirators convicted, so universally was the movement condemned by the public opinion of the country, that most of the prisoners were discharged, on condition of their leaving Ireland. But

the poorer peasantry and the working population of the towns; and a certain prestige was given to the fallen cause by the escape from prison, under circumstances of much mystery and a high degree of romance, of the most active and crafty of the leaders of the conspiracy. His return and that of other exiles to America renewed the agitation in that country. In the early summer of 1866, a raid was attempted into Canada, and although it proved so utter a failure as to cover its projectors with ridicule, an organisation was secretly pursued, both in America and in Ireland, which resulted, in the spring of 1867, in an insane and utterly abortive attempt at insurrection at home. The plan of the conspirators was to seize the castle and military stores at Chester, and, having cut off telegraphic communication, to convey these arms to Dublin, and effect, throughout the country, a simultaneous rising in concert with the enterprise at Chester. The attempt was defeated through the treachery of one of the conspirators, by whom the plot was revealed. A partial insurrection, however, took place concurrently with the intended attack on Chester, in the county of Kerry; and a few weeks later, a more extensive movement was attempted in the counties of Dublin, Louth, Tipperary, Limerick, and Cork. But the persons engaged in it were for the most part either American and Irish-American adventurers, or artisans, day-labourers, and mechanics, generally unprovided with arms, and in many cases scarcely beyond the years of boyhood. The only military enterprises undertaken by them consisted in a series of attacks on the barracks of the rural constabulary, in almost every instance unsuccessful; most of the parties dispersed, or were made prisoners after a single night's campaign. The rest betook themselves to the mountains, and after a few days of exposure and hardship, in which they managed to evade pursuit, and carefully avoided all encounter with the military, they were either captured or dispersed. The leaders were tried at a special commission held within the spring of the year 1867, and tranquillity for a time seemed to be restored in Ireland. Much discontent, however, still continued to exist; and as the foreign organisation was uncontrolled, and was still maintained, it remained as a standing element of danger, and a persisting incentive to domestic disaffection. Considerable alarm was created in England and Scotland by the extent and daring of the organisation among the Irish population of the large manufacturing towns. In September 1867, an attack was made, in open day, on a police-van in Manchester; the officer in charge was killed, and the prisoners, who were suspected Fenians, were released. A few weeks later, a still more daring attempt was made to blow down Clerkenwell Prison wall, with the same object. Alarms were circulated of intended burnings in the cities and towns; gunsmiths' shops and even government stores of fire-arms were broken open and pillaged; and a vague but wide-spread feeling of apprehension was for a time created. Much of this, however, has been removed by the better spirit produced by recent legislation in Ireland, as well as by the marked improvement in the condition of the smaller tenant-farmers, and the scale of wages of agricultural and other labourers. Agrarian outrages have notably decreased in number. The prisoners confined for political offences have all been released, with the exception of those who had been soldiers, whose detention is a standing grievance. The settlement of the Alabama claim is supposed to have taken out of the hands of the American Fenians one of the most powerful instruments of agitation

represented in a corporate form by the *Irish Government Association*, a more peaceable and constitutional body than the Society of Fenians.

**FERNANDO DE NORONHA**, a lonely island of the Southern Atlantic, in lat.  $3^{\circ} 50' S.$ , and long.  $32^{\circ} 25' W.$ , about 125 miles from the coast of Brazil, to which empire it belongs. It is about eight miles in length. The surface is rugged, and rises into a peak about 1000 feet high, the upper part of which is very steep, and on one side somewhat overhanging. The island is mostly covered with wood; but as little rain falls, there is not much of tropical luxuriance. It is used as a place of banishment for Brazilian criminals. No woman is allowed to land on the island. Pop. 2000, half of whom are convicts, who cultivate small farms.

**FEROZABAD**, a town of India, in the British district of Agra, North-west Provinces, 24 miles east from Agra. It is the principal place of a *pergunnah* of the same name. It was formerly named Chandwar, and was a place of much greater importance than at present. Its fine edifices are mostly deserted and in ruins; most of the inhabited houses being cottages thatched with straw. It is surrounded by a wall, outside of which are many mounds and shapeless ruins. Pop. (1871) 14,255.

**FESCH, JOSEPH**, Cardinal and Archbishop of Lyon, was born 3d January 1763 at Ajaccio. His father, a Swiss officer in the service of Genoa, had married a widow, whose daughter by a former husband, Letizia or Letitia Ramolino, became the mother of Napoleon Bonaparte. F. was thus the half-brother of Letizia, and the uncle of the future Emperor. He had entered the clerical profession, but left it at the outbreak of the French Revolution, and, in 1795, became commissary to the Army of the Alps under his nephew in Italy. The First Consul having resolved on the restoration of the Catholic worship, F. resumed the clerical habit, and was active in bringing about the concordat with Pope Pius VII in 1801. He was now (1802) raised to be Archbishop of Lyon, and in the following year to be cardinal. In 1804, he was sent as French ambassador to Rome, where he ingratiated himself with the pope by his adroit management and ultramontane sentiments, and contributed to induce the pope to undertake his mission to Paris to consecrate Napoleon as Emperor. F. accompanied the pope, and assisted at the coronation; and for his services at Rome, he was rewarded by the office of Grand Almoner and a seat in the senate. In 1806, the Archbishop of Regensburg, Arch-chancellor and first Prince Elector of the just-expiring German Empire, and about to become the Prince Primate of the nascent Confederation of the Rhine, chose F. to be his coadjutor and successor; and, along with all these dignities, he received a stipend of 150,000 florins a year. In 1809, Napoleon wished to invest him with the Archbishopric of Paris, but F. declined it, as he had long been dissatisfied with the Emperor's policy in regard to the papal chair. In 1810, he presided at a national conference of clergy assembled at Paris, and the views which he maintained there, with even more than usual keenness, brought him into disgrace with the Emperor, who was still further exasperated against him on account of a letter which F. wrote to the pope, then (1812) in captivity at Fontainebleau, and which was intercepted. He lost his imperial dignities and pension, and the prospects of the Primacy of the Rhine Confederation were also taken away by the appointment of Prince Eugene to be Grand Duke of Frankfurt. After this, F. lived in a sort of banish-

ment, and was allowed to return to France, where he was received with open arms by the pope. The return of Napoleon brought him back to France, and during the Hundred Days, he was nominated a member of the Chamber of Peers, though he never took his seat; but, after the battle of Waterloo, he had again to take refuge in Italy. The royalist clergy now persecuted him with accusations and lampoons which he in no way deserved. His resistance to the will of his nephew, and indeed his whole conduct, seem to have been actuated by sincere zeal for what he considered to be the interests of the church. When called upon by the Bourbons to resign his episcopal office, he obstinately refused; and it was not till 1825, after receiving a papal brief interdicting the exercise of his clerical functions, that he resigned the charge, but not the title. In 1837, an attempt was made to reinstate him, to which, however, the French government refused assent. He lived in the greatest friendship with his sister, Madame Mère, as she was styled, till his death. He died 13th May 1839. Of his famous and very large collection of paintings, he bequeathed a part to the city of Lyon, and the rest was disposed of in a series of auctions at Rome after his death.

**FEUILLEE**, a genus of plants of the natural order *Cucurbitaceae*, named in honour of Louis Feuillée, a French botanist and traveller in Chili. The species are generally half-shrubby climbers, natives of the warm parts of America. The seeds, at least of some of them, as *F. cordifolia* and *F. trilobata*, contain a great quantity of a bitter fixed oil, which is obtained by expression, and is used for lamps. It has also a high reputation in the West Indies and Brazil as a cure for serpent-bites, and an antidote to some kinds of vegetable poisons.

**FIELD, CYRUS WEST**, an American merchant, one of a family distinguished for ability, was born at Stockbridge, Massachusetts, November 30, 1819. At the age of 15, he went to New York, and entered upon a commercial career, which he pursued with such energy and success that he was enabled in 1853 to partly retire from business, to spend some time in South American travel, and then to engage with great enthusiasm in the promotion of the Atlantic telegraph, for which he secured a charter from the colonial government of Newfoundland for fifty years. Being joined by Peter Cooper, Moses Taylor, and other American capitalists, he organised, in 1854, the New York, Newfoundland, and London Telegraphic Company; and in 1856, the Atlantic Telegraph Company. Devoting himself entirely to the work of uniting the Old and New Worlds, he crossed the ocean nearly thirty times in its prosecution; and on the laying of the first cable, 1858, was received by his countrymen with enthusiastic plaudits. He continued his exertions; and on the success of the cable of 1865, received a gold medal at Liverpool, and a vote of thanks from the American Congress. In 1871, F. was one of the originators of the company which undertook to lay a cable across the Pacific Ocean *via* the Sandwich Islands to China and Japan. See ATLANTIC TELEGRAPH.

**FIGLIÑÉ**, or **FIGHINE**, a town of Central Italy, in the province of Florence, and 15 miles south-east from Florence, on the left bank of the Arno. It is surrounded by a rectangular wall, and is traversed by a fine street, through which passes the great road from Florence up the valley of the Arno. The silk of F. is the best in Tuscany. Pop. (1872) 5673.

**FIGUEIRA**, a town of Portugal, in the province of Beira, at the mouth of the Mondego, 23 miles west by south from Coimbra. Its harbour is a

carries on, however, a considerable trade. The chief exports are salt, wine, vinegar, oil, dried fruits, and oranges. The wine shipped from F. is known in England by the names of *Figueira* and *Bairrada Wine*. It is quite different both from port and from sherry. It is best when new, and does not bear keeping long. F. is much resorted to as a bathing-place. Pop. 6000.

**FILADELFIA**, a town of South Italy, in the province of Catanzaro, 18 miles west-south-west from Catanzaro, on the western side of the Apennines, and on a branch of the Angistola. Pop. 5600.

**FINALÈ**, a town of North Italy, in the province of Modena, on the Panaro, 22 miles north-east from Modena. It is surrounded by walls, has manufactures of linen and silk, and an active general trade. Pop. above 12,000.

**FIORENZUO'LA** (*Florentiola*), a town of Northern Italy, in the province of Piacenza, 22 miles west-north-west from Parma, on the Arda, in a beautiful and fertile plain. It is a station on the railway between Parma and Piacenza, and is also on the ancient Æmilian Way. It is well built, and a place of considerable activity. It formerly had numerous conventual and other ecclesiastical establishments. The principal church is still collegiate, and contains some curious relics of ancient art. There are some interesting relics of medieval times in Fiorenzuola. It is supposed to occupy the site of the ancient *Fidentia*. Pop. 6500.

**FIRBOLGS**, the name given in the fabulous early history of Ireland to a tribe said to have descended from the Nemedians, who, under their leader Nemedius, landed in the island about 2260 B.C.; and after 217 years, left it, on account of the oppression to which they were subjected by pirates called the Fomorians. The emigrating Nemedians formed three bands—one went to Thrace, and from them descended the F.; a second to the north of Europe or Lochlan, from whom descended the Tuatha de Danann; and the third to Alban or Scotland, from whom sprung the Britons. The F. returned to Ireland in three tribes, one of which more especially bore the name Firbolg; the others were called Firdomnan, and Firgailian. The three tribes, however, were under five leaders, by whom Ireland was divided into five provinces. With Slainge, the first Firbolg king, who began to reign 1934 B.C., and reigned only one year, the Irish historians begin their account of the Irish monarchy and list of kings. The F. were driven out, after they had been thirty-six years in Ireland, by their kinsmen, the Tuatha de Danann, from Scotland, they having previously passed over to that country from Lochlan; and these, in their turn, were expelled or conquered by the Milesians. The most recent investigators of the early history of Ireland regard the story of the F. as having some basis of truth, but no chronological accuracy; the different tribes having long subsisted in the country together, and with varying fortunes as to temporary superiority. See IRELAND.

**FIRMINY**, a town of France, in the dep. of Loire, six miles south-west from St Etienne, with which it is connected by a branch railway. Near it are rich coal-mines. It is a place of much activity, and has manufactures of silk, glass, and hardwares. Ribbons and nails are among the articles of manufacture most largely produced. Much lamp-black is also made. Pop. (1872) 8873.

**FIROLA**, a genus of gasteropodous molluscs, of the order *Heteropoda*, entirely destitute of shell—although there is a small branchial shell in the

surface of the water in calm weather, and are abundant in the warmer temperate and tropical seas. The oxygenation of the blood is supposed to take place in part through the delicate tissues, as there are no special breathing organs but a ciliated band.



Firola Frederici.

surface of the water in calm weather, and are abundant in the warmer temperate and tropical seas. The oxygenation of the blood is supposed to take place in part through the delicate tissues, as there are no special breathing organs but a ciliated band.

**FISHING**. The capture of fishes for food has been carried on in a variety of ways from the most remote antiquity, and is probably at least as ancient as the hunting or trapping of any kind of wild animal. The supply of food yielded to man by the waters seems always to have borne a very considerable proportion to that yielded by the land. Of all modes of capturing fish, the most simple and primitive is that of taking them with the hand, which is still an amusement of boys, who thus catch trout in small streams by groping below the stones where they hide. This is called in the east of Scotland *gumpig*, in the west *ginneling* or *guddling*. Even sea-fish are sometimes taken by the hand, approaching the shore in such dense shoals that the water seems almost to be filled with them. This is particularly the case on the north-western coast of North America, a region which appears to abound in fish more than any other part of the world; and there, besides the occasional use of the mere hand, the Indian often catches fish by means of a hand-net or a basket, paddling his canoe into the midst of the shoal, and, as it were, baling the fish out of the water. The use both of the net, in various forms, and of the hook and line, as well as also of the fishing-rod, are very ancient. Allusion is made in several places of the Old Testament to the use both of nets and hooks in the capture of fish. Some of the most important fisheries, as the herring-fishery, are carried on almost exclusively by the net. For different fisheries, however, nets of very different kinds are used. See FISHERIES and NETS; also HERRING-SALMON, and other articles on the most important kinds of fish. The capture of some very valuable kinds of fish—as cod, haddock, and others of the same family—takes place chiefly by means of the hook and line, and either by what is called the *long-line*, to which many hooks are attached, and which is extended horizontally over a bank frequented by the fish, its place being marked by floats, and drawn after the lapse of at least several hours; or by the *hand-line*, which, being let down over the side of a boat with a *sinker* proportioned to the strength of the current, is watched by a fisherman holding it in his hand, and hauled up immediately on a fish being felt to bite. The baits are, of course, various, according to the opportunity of procuring them and the kinds of fish. The use of the fishing-rod along with the hook and line is not so general for the capture of sea-fish as of fresh-water fish. See ANGLING. A rude fishing-rod, however, is often used for the capture of some sea-fish. The Pollack (q. v.) or lythe, the mackerel, and some other fish of the British seas, are often caught by

this, which is chiefly an amusement for boys in most parts of Britain, supplies no inconsiderable part of their food to the inhabitants of Orkney and Shetland. The shooting of fishes with arrows is practised by some of the South American Indians; some very large kinds of fish—as the Arapaima (q. v.)—are occasionally harpooned; and many large fish, both of the sea and of the fresh water, are killed by means of spears—a mode of fish-capture common enough in some parts of Scotland, and much employed by salmon-poachers, the spear—three-pronged—being known as a *leister*. Torches are also used by night in many parts of the world, both in sea and river fishing, to attract fishes by the light, which in this way has an almost certain effect. The poacher on a Scottish salmon-river conjoins the use of the torch with that of the leister, and this is popularly known as ‘burning the water.’ It is now wholly illegal, as is the use of the leister under any circumstances. The flying-fish is similarly attracted by torches on the coasts of the South Sea Islands, but a small net is used instead of a fish-spear. The inhabitants of the South Sea Islands take advantage of the habit of some fishes, of leaping out of the water when alarmed, to catch them by means of rafts in the shallow lagoons, encircling them so that they finally leap upon the rafts. The Indians of North-western America sometimes adopt a similar method of capturing the Viviparous Fish (q. v.) of their coasts. Other very peculiar modes of catching fish which are in use among them are described in the articles CANDLE-FISH and SALMON OF NORTH AMERICA in the SUPP., Vol. X. They also take the Vancouver Island herring (see HERRING, VANCOUVER ISLAND, in SUPP.) by constructing long dams of lattice-work on flats left dry by the retiring tide, in which the fish are caught which have come in with the tide. This method of taking herring, however, has long been known on the British coasts; and *cruires*, which are lattice-work constructions of a smaller size, have been used with great success in many places. *Cruires* are also very effective in the capture of salmon, a suitable place of the river being chosen for them, and they being so contrived that the fish readily get in, but do not readily get out. A very peculiar mode of taking fresh-water fishes is practised in Ceylon, by means of a funnel-shaped basket, open at both ends, which is suddenly plunged down, the wider end downwards, till it sticks in the mud, when, if a fish is felt to beat against the sides, it is taken out with the hand.

The capture of fresh-water fish by means of vegetable poisons of various kinds, is practised equally in the East Indies, in Africa, and in the warm parts of America. The poisons used do not render the fish poisonous. The poisoning of trouts and other river-fish with lime is too frequent in some parts of Britain, and is one of the worst kinds of poaching, all the fry, as well as the fish fit for the table, being destroyed, and the mischief often extending far farther down the stream than the perpetrators of it proceed in pursuit of their spoil.

Cormorants are trained by the Chinese for the capture of fish. Otters have also not unfrequently been trained and employed for the same purpose. For a full account of sea-fishing, and the apparatus employed, the reader is referred to *The Sea Fisherman*, by J. C. Wilcocks.

**FLAHAULT DE LA BILLARDERIE, AUGUSTE CHARLES JOSEPH, COMTE DE**, a French soldier and diplomatist, was born at Paris on 20th April 1785. He was destined for the army by his

rank of aide-de-camp of Napoleon. He distinguished himself in the Peninsular War and the Russian campaign; and in 1813, received the title of Count, and the rank of general of division in the new army. On the return of Napoleon from Elba, he was one of those who recommended him to abdicate in favour of his son. He became an exile after Waterloo; and while in England, married a Scotch heiress, Lady Keith, the proprietor of Tulliallan, in Clackmannanshire, and a British peeress in her own right. His name was afterwards removed from the list of exiles. After the revolution of 1830, F. returned to France, and was restored to his rank in the army. He entered the household of the king, and was appointed ambassador to Vienna, a post he held from 1842 to 1848. After the establishment of the second Empire, F. was called to the senate; and in 1860, sent as French ambassador to London, a post for which his acquaintance with this country, and connection through his wife with the higher classes in England, well fitted him, and which he retained until 1862. In 1864, he was named Grand Chancellor of the Legion of Honour. His daughter married the fourth Marquis of Lansdowne. He died in 1870.

**FLOATING-DOCKS.** So long as ships remained of a small size, no difficulty was found in effecting repairs on their hulls by the simple method of laying them on any convenient beach or sandbank at high water. The receding tide would leave them high and dry for a few hours at a time; and by actively working at the repairs during low-water, they could generally be accomplished, without any special contrivance for taking the vessel out of the water. Even now this plan is not unfrequently resorted to, the part of the beach on which it is to be carried out being laid with parallel rows of timber beams, called collectively a *gridiron*. The rise and fall of the tides is in many localities insufficient for the purpose of leaving the hull dry at low water, and the larger the ship the greater the risk

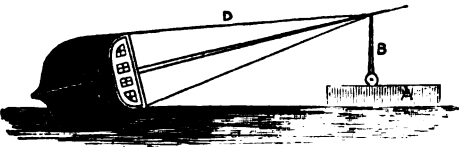

Fig. 1.

of ‘beaching.’ Numerous plans have been adopted for getting at the bottoms of large vessels. Fig. 1 represents a mode of heeling over ships which was at one time very extensively used. A is a lighter of sufficient size and weight, provided with very powerful ‘heaving-down tackle,’ consisting of strong ropes, B, passing through very large blocks. These tackles are made fast to the masts of the vessel, which are previously secured by extra stays, on the upper side at D; and then, by working the tackles, the hull of the vessel is heeled over until it assumes the position shewn in fig. 1. Of course, this plan necessitates the removal of the whole of the cargo. By hauling the vessel over first on one side, and then on the other, the whole of the hull can be got at without difficulty. Of course, still water is required to carry out this method with safety. When there is no rise and fall of tide, the lighter, A, is not required, as the tackle, B, can be made fast to the quay or pier. It was while being careened over that the *Royal George* went down at Spithead in 1782, with 600 men on board. Graving or

ships; but they are always very costly to construct, and in many localities sufficiently firm foundations are not attainable. Another common method of getting at the bottom of ships is by bringing them on to sloping ways, called *slips*, carried out from the yard a long distance under water, and then hauling them right up on to the shore end of the ways by means of suitable tackle, generally worked by hydraulic power. During the operation, the vessel rests upon a suitable carriage. Mr Morton of Leith, in 1818, invented a carriage for this purpose, which has contributed much to render this method of hauling up vessels easy.

Floating-docks have been in use for many years. Until of late years, they were built of timber, in the form of a large box with a flap-door falling down on strong hinges at one end. They are moored in still and shallow water, with a depth just sufficient to allow the vessel to float into them as they rest on the bottom. The flap-door is then raised up, and the water pumped out. These timber docks are incapable of being used in deep water, in consequence of their want of stability. If the vessel being docked happened to be so light that the dock began to float before the water was all pumped out of the dock, it was very apt to heel over, and thus cause the water to rush to one side, endangering both ship and dock. A considerable number of wooden floating-docks, of a size sufficient to dock large vessels, have been built in the United States of America. Some of these American docks have been built in sections—that is, a number of short docks are joined together to make a structure long enough to take in a long ship; but those wooden erections have little strength or durability.

It was not until the introduction of iron as the material for constructing them, that floating-docks were made capable of working in deep water, and able to take in the largest class of ships.

Mr R. W. Thomson, C.E., of Edinburgh, designed in 1859 a great iron floating-dock for the port of Sourabaya, Java. Contrary to the method which had always before been adopted, Mr Thomson determined to make every separate piece of the Sourabaya Dock from drawings, and to dispense altogether with the costly operation of building up in this country. Some idea may be formed of the skill and care required for the proper fulfilment of this undertaking, when it is stated that there were upwards of 75,000 separate plates, ribs, and angle-irons, every one of them shaped, punched with numerous holes, and ready in every respect to be riveted into their places without any further preparation. It was absolutely necessary that every one of the two millions of holes that were to be punched in all these plates and pieces of iron should be accurately in its right place. Mr Thomson succeeded in carrying out his system so completely, that there were only about 450 separate forms to be made for all the 75,000 different pieces. By systematising the work in this manner, it became possible to spend sufficient time and care on the making of drawings and templates for each of the separate 450 forms which composed the whole dock, to insure almost mathematical accuracy in the form of each piece, and in the positions of every hole in it. Another advantage of this method is the immense saving of labour in erecting the dock. Under the old plan of shaping each piece of iron so that it would fit only into one special place, it had to be searched for amid thousands of pieces similar to, and yet not capable of being substituted for it. The mere turning over of the innumerable plates and angle-irons in search for individual pieces becomes a source of great expense. Under Mr

the docks is discharged from the slips, each of the 450 classes of pieces is piled up by itself, and the workmen have nothing more to do than to take the piece on the top of the pile, perfectly sure that it will fit accurately any of the hundred possible positions to which its class belongs. All the iron for the Sourabaya Dock was used just as it came from the rolling-mills. The plates were all flat and rectangular, and the angle and T-iron all straight. The structure was so designed that no bending or heating of the pieces was required. It can easily be imagined that a dock so carefully planned would be cheaply made.

Fig. 2 represents an end view of the dock. The water-tight compartments, A, A', B, B', and C, were all completely under the command of the powerful centrifugal steam-pumps, so that they could be separately filled or emptied in a very short time. In fig. 2, the dock is shewn heeled over to one side, for the purpose of getting at the

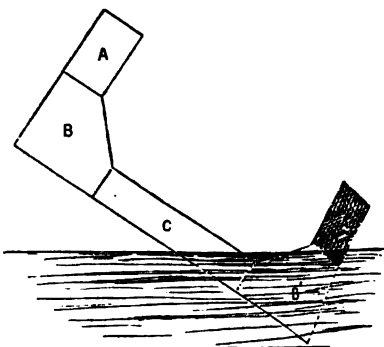

Fig. 2.

bottom for repairing or cleaning it. This tilting over could be accomplished by filling the compartment A', and emptying all the others. The water-tight compartments were divided in their longitudinal direction into five separate divisions, making in all 25 water-tight compartments, any one of which could be filled or emptied at pleasure; thus affording complete command over the dock, and admitting of its being put into any required level, notwithstanding any irregularity in the distribution of the weight resting on the dock.

The French government had to provide a dry dock at Saigon, in Cochin-China, for the use of the large steamers which had been subsidised by it to run between France and China. The soft muddy character of the soil at Saigon rendered the construction of a stone graving-dock impracticable. The French admiral, commander-in-chief of Cochin-China, hearing of the construction of the Sourabaya floating-dock, and having examined the plans of it, recommended his government to have a similar dock, on a much larger scale, constructed for Saigon.

Fig. 3 is a view of this dock, which was erected some years ago. The performances of the Saigon Dock are in every way most satisfactory; it has lifted, high and dry out of the water, the 70-gun frigate *Persévérante*. Another great dock on Mr Thomson's principle has been erected at Callao, and is likewise answering its purpose admirably. It has lifted out of the water many large vessels—among others, the United States man-of-war *Waterer*, and the Peruvian iron-clad *Independencia*. The latter ship weighed 3300 tons. As the Callao Dock floats in an open roadstead, some apprehension was felt

its work in the most satisfactory way. None of these iron docks have doors or gates for excluding the water. The bottom part is made of sufficient buoyancy to float the vessels clear out of the water, and the equilibrium of the dock is maintained during the time it is under water, for the purpose of admitting a vessel, by the great displacement offered by the hollow sides, AA' (fig. 2).

(west Indies) in 1867, and designed by Mr. Frederick J. Bramwell. It is 300 ft. long, 72 ft. wide clear between the sides, and has a double bottom 9 ft. 9 in. deep. The sides are open girders, not hollow boxes, as in the Sourabaya dock, and immense rectangular air-vessels called 'floats,' each about 47 ft. x 11 ft. x 5 ft., are placed between the side girders, and are capable of being moved up and

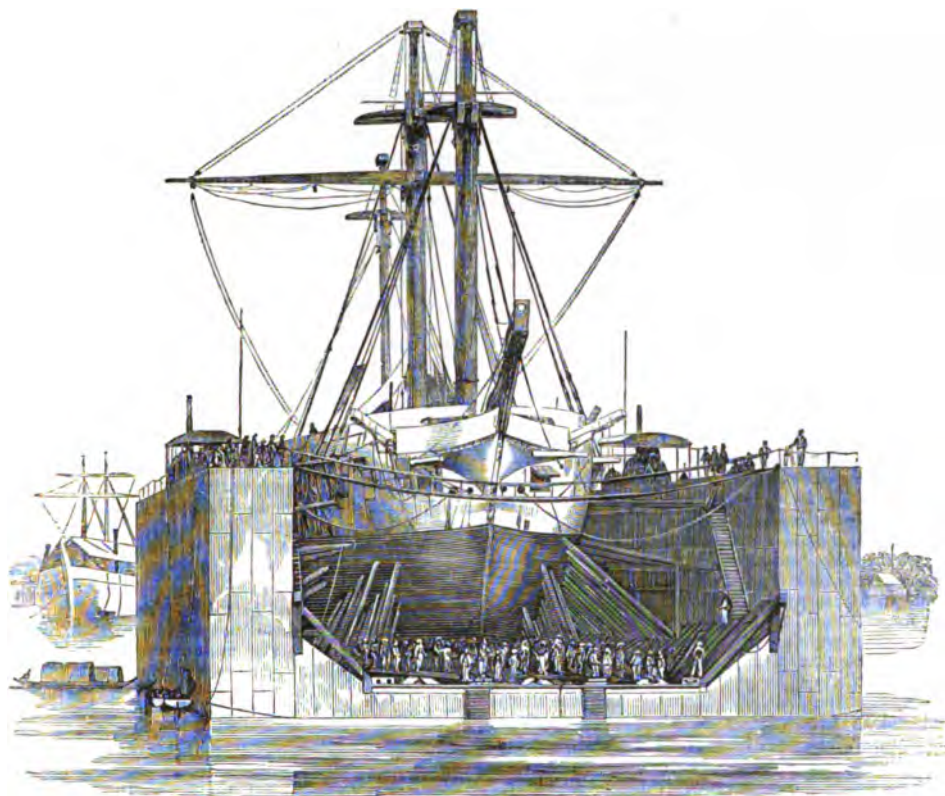

Fig. 3.—Floating-dock at Saigon, with the *Perséverante* of 70 guns. (From a Photograph.)

down by screws in order to preserve the stability of the whole while it is being raised or lowered. By an accident which happened very soon after its arrival at St Thomas, this dock was sunk, and a hurricane which followed close on its sinking, injured it still further. It remained under water for a long time, but was raised to the surface in January 1871, after operations which lasted a year and a half, and were quite unique in their way. This dock, as originally constructed, could take in and lift a vessel not drawing more than 24 ft., and not weighing more than 4000 tons. The weight of the dock itself, with the machinery all complete, is about 3400 tons. The docks made by the Messrs Rennie for Carthagena and Ferrol are even larger than the St Thomas Dock. The former weighs about 4400 tons, and has lifted the Spanish iron-clad *Numancia*, weighing 5600 tons, and supported it for 80 days.

**FLOATING WAREHOUSES.** The danger that attends the storing of petroleum and other inflammable and explosive chemicals has led in France to the construction of warehouses, store-

houses, or magazines that will float in a dock or basin, and can be moored at a distance from buildings on land. So far as concerns England, an act of parliament was passed in 1866, relating to the carriage and storing of dangerous substances: it applies more especially to nitro-glycerine, but it gives power to the Privy Council to apply the provisions to other dangerous substances. The precautions, however, go very little further than this, that all casks or packages containing the substance are to be marked 'specially dangerous;' and that every carrier and every warehouse-keeper may exercise a choice as to whether he will warehouse or carry the article or not. In France, as we have said, floating warehouses have been constructed, two being finished in 1864, and others added in later years. They, or some of them, are in a large commercial dock and entrepôt, established at St Ouen, between Paris and St Denis. The construction of the floating fabrics is remarkable. Each warehouse or magazine consists essentially of 100 hollow iron cylinders, arranged in four rows of

feet long by six or seven in diameter, has hemispherical ends, with a man-hole at one end. They are placed upright when in position, so as to be filled with petroleum, glycerine, gunpowder, or any other substance, through the man-hole. As they will hold 25 tons each, their united capacity is 2500 tons. There is a wooden covering to the top of the collected mass of cylinders, and round the sides as far down as the line of flotation, to shield the iron from fluctuations of temperature. This covering is made of thick planking, fastened to the cylinders by angle-irons which have been riveted to the latter. At the head and stern are large hawsers-holes, to admit hawsers for towing and mooring the floating fabric, bringing it into and taking it out of a basin or dock, and warping it to a quay or dock wall; or, when the vessel is moored in the middle of a basin, far away from buildings, a barge may deliver or receive the dangerous cargo, and thus the vessel be kept altogether away from quays and wharfs.

**FLORIDIA**, a town of Sicily, in the province of Syracuse, seven miles west-north-west from Syracuse. It stands in a wide plain, amidst vineyards, olive-groves, and corn-fields. The houses are mostly low and small. Pop. (1872) 8492.

**FLOTOW, FRIEDRICH VON**, a living operatic composer of Germany. Born at Tentendorf, in Mecklenburg, in 1812, he was at first intended for the diplomatic profession; but finding a musical career more congenial to him, he took lessons in composition from Reicha, in Paris. His earlier operas were refused by the managers of the Paris theatres; and his reputation was first established by his music to *Le Naufrage de la Méduse*, produced in 1839 at the Théâtre de la Renaissance, which was a great success. Since then, he has composed various light operas, including *Le Forestier*, *L'Esclave de Camoëns*, *Alessandro Stradella*, *L'Âme en Peine*, *Martha*, *Rübezahl*, and *Zilda*, which have attained considerable popularity in France and in Germany, and are characterised by easy and lively dramatic action, readiness of invention, pleasing melody, and graceful instrumentation. *Martha* has, since it was produced in London, become a great favourite in this country. F. was, in 1854, appointed intendant of the theatre at Schwerin, and was elected a corresponding member of the French Institute in 1864.

**FOKTCHA'NY, or FOKTSHAN**, a town of Walachia, on the Milkov, a branch of the Sereth, 105 miles north-east from Bucharest. The Milkov divides Walachia from Moldavia, and a large suburb of F. is in Moldavia. In 1789, F. was destroyed by the Russians. It was burned by the Turks in 1822. The inhabitants are mostly Greeks and Jews. Pop. of town and suburb nearly 40,000.

**FOOD.** The food of man is derived entirely from the vegetable and animal kingdoms.

Of animals used for food by man, the catalogue is very large. Savages, impelled by hunger, and unrestrained by any of those opposing considerations which are always powerful with civilised man, eagerly devour almost every animal on which they can lay their hands, vertebrate or invertebrate, and whether in a fresh state or far gone in putrefaction.

There is no vertebrate animal of which the flesh is known to be poisonous or positively unwholesome, except some species of fish, chiefly found in tropical seas. Of vertebrate animals, every class—Mammals, Birds, Reptiles, and Fishes—affords common and much esteemed articles of food. Of mammals, those principally used for this purpose are the herbivorous

flesh of some of the pachyderms is also used, particularly that of the hog; and that of some of the rodents, as the hare, rabbit, capybara, &c.—although the idea of eating others of the rodents, as mice and rats, would be rejected with disgust by all except savages. The flesh of monkeys is eaten in some parts of the world, although a strong aversion to it is more generally entertained, at least by civilised nations, probably on the ground of the animal's resemblance to the human form; for travellers who have been compelled to eat monkey-flesh, declare it to be very good. The flesh of whales and other ordinary Cetacea is scarcely used except by rude tribes; although that of porpoises was formerly in great request in England, especially during Lent, the porpoise passing for a fish. The flesh of the herbivorous Cetacea, as the manati and dugong of tropical seas, is esteemed. The flesh of some of the herbivorous marsupial quadrupeds, as the kangaroo, is eaten; but that of the carnivorous marsupials and of carnivorous quadrupeds generally is rejected.—The same general remark applies to birds: the flesh of birds of prey is rank, coarse, and unfit for human food; but that of almost all birds which feed on leaves, seeds, and other vegetable substances, or on insects, worms, molluscs, &c., is good for eating. Web-footed birds, particularly the *Anatide*, and gallinaceous birds (including pigeons), are more extensively used than any others; but birds of other orders are also eaten; and some of the small *Insectores*, as ortolans, bec-fins, larks, &c., are brought to market as delicacies.—Of reptiles, one order—that of Ophidian reptiles, or serpents—affords food only to savages; but some of the Chelonian reptiles—turtles—are in high esteem; the Batrachian order contains the frogs, which find a place on the most luxurious tables in some countries of Europe; and to the Saurian order, or lizard-like reptiles, belong species—as the iguanas of South America, creatures of sufficiently uncouth appearance—which, however disgusting to British readers in general may be the thought of eating them, many of their countrymen have learned to esteem as a delicacy. The eggs of turtles and iguanas are also used for food, as well as those of many kinds of birds. Of mammals, birds, and reptiles, the parts chiefly used for food are the muscles or flesh, and the fat; but other parts of some animals are also used, as the kidneys, the lungs, the livers, the stomachs of ruminants (*tripe*), the gizzards of birds, &c.—Very many kinds of fishes are excellent for food, both of cartilaginous and bony fishes; and they belong to many different families.

Of invertebrate animals, some of the molluscs are very generally used. It is unnecessary to do more than name oysters, mussels, and the snails of Italy as examples. Comparatively few molluscs, however, form articles of human food. The same remark applies to crustaceans, although crabs, lobsters, cray-fish, prawns, and shrimps are well-known exceptions. It may almost be said that no articulated animals of any other class are used for food except by savages; the occasional use of locusts and of the larvae of some coleopterous insects (*gru-gru* worms, &c.), scarcely requiring a qualification of the statement. And of the radiated animals, the same general statement may be made; the *Bêche-de-mer* or *Trepang*—of which, however, the use is almost confined to the Chinese—being the only considerable exception.

Honey, although collected and modified by insects, is rather a product of the vegetable than of the animal kingdom. The same remark applies to a very different substance, the sea-weed gelatine of

All the great divisions of the vegetable kingdom yield food for man—the phanerogamous, however, much more largely than cryptogamous plants. Of the latter, the mosses and *hepaticas* contain no species that is used for this purpose; the same may almost be said of lichens, notwithstanding the tripede-roche and Iceland moss; but numerous species of *Algae* and of *Fungi* are edible; and a few ferns supply unimportant articles of food. Of phanerogamous plants, it is perhaps impossible to say whether the endogenous or the exogenous are most important in this respect, notwithstanding the place of the cereal grasses among the former. The plants yielding food are also distributed among many natural orders, although some, as *Gramineae*, *Leguminosae*, and *Cruciferae*, contain a large number of the most useful species. The parts of plants which yield food are very various: the roots and tubers, bulbs, &c. of some; the stems of others; leaves; flowers; the fleshy part of fruits; the seed, &c. The part which man appropriates to himself is either used uncooked, or requires to be cooked in order to fit it for use. Sometimes, also, other previous preparations are necessary, as the grinding of corn, &c. Except in the case of ferns, when the cryptogamous or acotyledonous plants are used for food, the whole plant is used, e. g., mushrooms, carrageen, Iceland moss. Sometimes no part of the plant is itself fit for use, but it contains some substance which is, and which man extracts by suitable processes, as in the case of arrow-root, sago, and other kinds of starch, sugar, &c.

The first place among articles of vegetable food must be assigned to *corn*, the seeds of the *Cerealia* (q. v.). The next place, perhaps, belongs to the potato and yam, after which come the banana, cassava or mandioc, and the different kinds of pulse.

Regarded more botanically, the articles of food are—

1. Roots, properly so called, of which the turnip, carrot, parsnip, beet and mangold, cocco or eddoes, may be mentioned as among the most important; but the number of esculent roots and of roots yielding articles of food, is very great.

2. Tubers, of which the potato, yam, and batatas or sweet-potato, are the most important; with the cassava or mandioc and the arrow-root as yielding starch; but of which many others are also used, as the malloco (*ullacus*), the oca (*ozalis*), the earth-nut, &c.

3. Rhizomes, or root-stocks, of which some are simply boiled, whilst others are chiefly valued for the starch (arrow-root, &c.) which they yield.

4. Bulbs, as those of the onion, garlic, shallot, &c. The most important are alliaceous.

5. Stems, which, in some cases, are eaten along with the leaves, whether as salads or boiled vegetables; but of which some are more important as yielding sago and other kinds of starch. The eatable part of asparagus is a stem in the beginning of its growth, and the same statement applies to some other plants; the eatable part of kohlrabi is a peculiar swelling of the stem.

6. Leaves and leaf-buds, as those of kale and cabbage, with other *greens* of all sorts, spinach, lettuce and all the other salads; the terminal buds of palms (palm-cabbage), &c.

7. Flowers and adjoining parts, as in cauliflower and artichoke.

8. Fruit (exclusive of seeds), used either as a principal article of food, as in the case of the banana, and, to some extent, of gourds, or more generally as an article of luxury. See FRUIT.

which must be mentioned those of buckwheat, quinoa, the lotus of the Nile and other water-lilies, the nelumbo, the water-chestnut and other species of *Trapa*, many kinds of *pulse*, as peas, beans, lentils, kidney-beans, chick-peas, &c., and nuts of many kinds, some of which, as the chestnut and cocoa-nut, afford, in some countries, substantive and important articles of food, whilst the greater number are rather articles of occasional use and of luxury. There are also other seeds which are capable of being used, and are occasionally used as food.

Sugar, which may well be reckoned among important articles of food, is obtained from the juice of stems, as of the sugar-cane, some palms, and the sugar-maple, and of roots, as of the beet, &c. Alcoholic beverages are obtained from vegetable substances and juices which contain sugar, or which, by some artificial process, are, in the first instance, converted into sugar; as the juices of fruits (the grape, apple, &c.), the juices of stems (the sugar-cane, palms, &c.), the juices of roots and tubers (beet-root, potatoes, &c.), and the seeds of the cereal plants (barley, rice, &c.).

Besides the substantive articles of food, and beverages more or less generally used, there are very many condiments, which are obtained from the vegetable kingdom, and of which the botanical sources are almost equally various, as mustard, pepper, ginger, cloves, capers, &c.

FORTUNE, ROBERT, a distinguished botanist and traveller, was born in the county of Berwick in 1813. After completing his education at a Scotch parish school, he served an apprenticeship as a gardener, and obtained employment in the Royal Botanic Garden at Edinburgh. There he had good opportunities of obtaining a sound knowledge of botany and the higher departments of his own profession, so far as they relate to the cultivation of subtropical and tropical plants under glass in a temperate climate, and these opportunities he turned to good account. He afterwards obtained a situation in the gardens at Chiswick, where his abilities and acquirements attracted the attention of London naturalists. He was, in 1842, sent by the Botanical Society of London to Northern China to make a botanical exploration of the country. His journey was most successful, and he sent home a very large number of new and valuable plants. He gave an account of his adventures in his *Three Years' Wanderings in Northern China*, a work which places its author in the foremost rank of contemporary explorers. F., on his return to England, acted for a time as curator of the Physic Garden at Chelsea. In 1842, he was appointed by the East India Company to proceed to China to make investigations relative to the cultivation of the tea-plant; and on his return to England he published a work entitled *Two Visits to the Tea Countries of China*. He was afterwards employed by the American government to collect for them seeds, chiefly those of the tea-plant, in the East. The latest important work by F. was published in 1863. It is entitled *Yedo and Peking, a Narrative of a Journey to the Capitals of Japan and China*. It devotes special attention to the natural productions and agriculture of the districts visited.

FORT WAYNE, a flourishing town of the state of Indiana, North America, at the confluence of the St Joseph and St Mary rivers, which form the Maumee, and on the Wabash and Erie Canal, 122 miles east-north-east from Lafayette. It is a great railway centre, and its growth has been very rapid.



in 1794, and it continued to be a military post till 1819. Pop. (1860) 10,388; (1870) 17,718.

FOU'LA, or FOULAH, an island of Shetland, parish of Walls, from which it is distant 20 miles in a westerly direction. It extends 3 miles in length by  $1\frac{1}{2}$  in breadth, and rises to a height of 1369 feet



Fig. 1.—General Appearance of Foula from the Sea.

above the sea. It is solitary, and with it there is no regular communication. F. has about 250 inhabitants, who subsist by fishing and farming on a small scale. On the island, there is a school maintained by the Society for Propagating Christian Knowledge; there is also a chapel connected with the Church of Scotland, and a chapel with a missionary maintained by the Congregational Union of Scotland. F. is chiefly remarkable for its sublime cliffs of red sandstone on its north-western side, where the precipice rises from the sea-margin to a height of nearly 1200 feet, being the grandest thing of the kind in the British Islands. Among the sea-birds which occupy the cliffs is the Skua Gull, or Bonxie (*Leucis cataractes*). Of this powerful bird there are about 13 pairs, which are prized by the natives for their services in keeping down the numbers of the eagles on the cliffs. The landing-place on F. is at a scattered hamlet of wretched thatched huts on the south-east. Here there is a store, at which imported



Fig. 2.—A Foulah Hut.

commodities are bartered for fish and other articles, and at which an apartment is let to strangers, there being no inn. F., however, is rarely visited by strangers, and little is known of it even in Scotland.

FOURCHAMBOULT, a rapidly increasing town of France, in the department of Nièvre, five miles north-north-west from Nevers, near the right bank of the Loire, which is here crossed by a suspension bridge. It is a station on the railway between Orleans and Nevers. There are great iron-foundries, employing between 2000 and 3000 workmen. The manufacture of arms is extensively carried on. Pop. (1872) 5835.

FRA'GA, a town of Spain, in the province of Saragossa, 63 miles west by south from Saragossa, on the left bank of the Cinca, which is crossed by a suspension bridge. The town stands on a slope,

The small green figs of this district are celebrated as particularly delicious, and when dried form the chief article of export. F. is supposed to occupy the site of the ancient *Gallica Flavia*. Pop. 5028.

FREDERICK-CHARLES, a Prussian prince, son of Prince Charles (brother of King William), was born at Berlin, 20th March 1828. In his early youth, he manifested a great liking for warlike occupations; and the first Slesvig-Holstein war (1849) saw him in the field as captain, and not without honour to himself; in the campaign in Baden also he gathered laurels and honourable wounds; and in the second Slesvig-Holstein war his name became famous through the storm of the Düppel entrenchments. But his chief title to fame rests on the part he played in the campaign of 1866 against Austria, where he commanded one of the invading armies, and where his able generalship contributed not a little to the final success of the war. He has indeed been blamed for excess of caution in advancing through Bohemia to the rendezvous at Gitschin, where his more prompt appearance, it is said, would have saved the Silesian army from the danger of serious disaster which it encountered in passing the defiles; but it may, in fairness, be assumed that the caution was necessary until the contrary is proved. The prince is not only practically but theoretically distinguished in his profession. Besides his services in the reorganisation of the cavalry, he has written several military works of great merit; one of them entitled *How to Beat the French*. He commanded the second German army in the Franco-German war, and the investing forces when Metz capitulated, Oct. 27, 1870; and next day was made field-marshal by King William, now Emperor of Germany. He was married to Marie Anna, Princess of Anhalt, in 1854.

FREDERICK CITY, a city of Maryland, U. S., two miles west of the Monocacy River, 44 miles north-west of Washington, 65 by railroad west of Baltimore, on a branch of the Baltimore and Ohio Railroad; a handsome town with 12 churches, four banks, college, academy, seminaries, two newspapers, and manufactories of iron, wool, leather, flour, and tobacco. Pop. (1870) 8526.

FREDERICKSBURG, a city of Virginia, U. S., is built in a fertile valley on the right bank of the river Rappahannock, at the head of tide-water, 110 miles from Chesapeake Bay, 65 miles north of Richmond, and had, in 1870, the county buildings, five churches, several public schools, orphan asylum, extensive manufactories of flour and tobacco, and a population of 4046. December 13, 1862, it was the scene of a battle between the Federal army, commanded by General Burnside, and the Confederate army under General Lee, in which the former was repulsed, and driven back across the river with a loss of 12,321, while the Confederates, strongly posted on the hills south of the city, suffered but trifling damage; but the city itself was nearly destroyed.

FREDERICK - WILLIAM, Crown-prince of Prussia, only son of King William (q. v.) of Prussia and Queen Augusta, *née* Duchess of Weimar. Born 18th October 1831. His earnest character and eminent talents were early developed under the care of excellent masters, among others of Ernest Curtius (q. v.), who also accompanied him to the university of Bonn, where the prince was matriculated in the law faculty. After the completion of his education, the prince visited several foreign countries, among others, England, where it seems he became attached to the Princess Royal, eldest

of the two nations. Of the issue of this union, there are now living three sons (the eldest Frederick William, born 27th January 1859), and four daughters. Since his father ascended the throne, the Crown Prince has taken part in the more important affairs of state. He served in the Danish campaign in a subordinate capacity; nevertheless, he gave sufficient proofs of his great ability, to cause the king to intrust to him an important (according to some, *the most important*) task in the war with Austria in 1866, namely, the command of the left Prussian wing operating in and from Silesia. How ably the prince played his part, and how his timely appearance on the battle-field of Königgrätz decided the fortune of the day, is well known (see GERMANY, in SUPP., Vol. X.).

In the Franco-German war, 1870-1871, he acted a very conspicuous part as commander of the troops of Bavaria, Würtemberg, and Baden. He was present at Sedan, August 1870; and was made a field-marshal two months after by his father. F.-W. is heir-presumptive to the imperial crown of Germany, as well as the throne of Prussia.

**FREGENAL DE LA SIERRA**, a town of Spain, in the province of Badajoz, and 30 miles south-east from Badajoz. It stands in a valley among mountains on the right bank of the Martiga. The streets are wide and well paved, and the houses in general well built. There is an ancient castle, erected by the Templars, within which is the bull-ring, capable of containing 4000 people. Leather and linen fabrics are extensively manufactured. Pop. 6000.

**FREIRIRA**, a seaport of Chile, in the province of Atacama, at the mouth of the Guasco. It is a place of some trade. Pop. 10,000.

**FRESNILLO**, a mining town of Mexico, in the state of Zacatecas, 30 miles north-west from Zacatecas, on a feeder of the Santiago or Tololatlán. It has a spacious square, in the centre of which is a splendid fountain. In the neighbourhood are silver and copper mines, which are among the most productive in Mexico. Pop. 12,000.

**FREUDENSTADT**, a town in Würtemberg, and capital of a bailiwick of the same name, in the circle of the Black Forest, 40 miles south-west of Stuttgart, is situated on a rock which is washed by the Murg. It was founded in 1599 by Duke Frederic I., and peopled by Protestant refugees from Austria. It has a considerable trade in wood, cattle, and fruit. Cotton-spinning, weaving, bleaching, smith-work, especially making nails, &c., are the principal industries. The town is regularly built. It has a good market-place with arcades, and a grammar-school. The environs are beautiful, and present many interesting prospects. Pop. (1871) 5145, nearly all Protestants.

**FREYSTÄDEL**, **FREYSTADT**, or (Hung.) **GALGOCZ**, a town of Hungary, in the circle of Neutra, 84 miles north-west from Pesth, on a height above the left bank of the Waag, opposite to Leopoldstadt. The Waag is here crossed by a long bridge. F. contains a fine castle belonging to Count Erlody, situated on a steep limestone cliff, with fine gardens. There is also a curious round tower, supposed to have been a Turkish minaret. Various articles of wood are extensively manufactured. There are important cattle-markets. Pop. (1869) 6346.

**FRIE'DEBERG**, a walled town of Prussia, in the province of Brandenburg, 56 miles north-east from Frankfurt, on the Peza. Around it are several lakes. It has woollen manufactories and

**FUENTE ALAMO**, a town of Spain, in the province of Murcia, 18 miles south from Murcia, at the northern base of a range of hills, and at a short distance from the canal of Murcia. Pop. 6250.

**FUERTE DE ANDALGALA**, sometimes more briefly called **ANDALGALA**, a town of the Argentine Confederation, in the province of Catamarca, 72 miles north by west from Catamarca, in a mountainous district. Pop. 5500.

**FUERTE**, or **VILLA DEL FUERTE**, a town of Mexico, in the province of Sinaloa, 75 miles north by west from Sinaloa, on the Rio del Fuerte, which flows into the Gulf of California. It is a place of some commercial importance. Pop. 8000.

**FUNARIA**, a genus of Mosses, with terminal fruit-stalks, and oblique double peristome, both the inner and outer having sixteen teeth. A few species are found in Britain, one of which, *F. hygrometrica*, is an object of particular interest on account of the hygrometric properties of its fruit-stalk, which, if moistened in the lower part, twists several times round in one direction; and if moistened in the

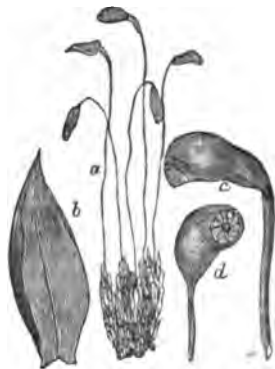

*Funaria hygrometrica* :

a, plant, natural size; b, leaf, magnified; c, capsule, magnified; d, capsule, magnified, with lid removed.

upper part, twists several times round in the opposite direction. This is owing to a peculiar arrangement of the cellular tissue, which is spiral in one direction at the base of the stalk, then straight, then spiral in the opposite direction. The structure of the fruit-stalk has been closely examined and commented on by Dr Lankester (*Annals of Nat. Hist.*, vol. iv.). *F. hygrometrica* has very concave, ovate, entire, spiculate leaves. It is very common on old buildings and on dry barren soils; and is said to be almost always found where a wood-fire has been burning on the ground, as on the site of gipsies' encampments, &c.

**FÜ'NFHAUS**, **FÜ'NFHÄUSEL**, or **HANGEN-DENLISSEN**, a town of Austria, in the circle of Unt, about 2 miles north from Vienna, of which it is a suburb. It has silk, satin, woollen, cotton, and red leather manufactures. Pop. (1869) 27,065.

**FUSARO LAKE**, a small lake of South Italy, in the province of Naples, 11 miles west from Naples, on the peninsula of Baia. It is not far from the site of the ancient Cumæ, of which it is supposed to have been the port. Numerous remains of massive buildings, villas, and tombs are still to be seen in the neighbourhood. At the southern extremity of the lake is a canal of Roman construction,

communicating with the sea, now known as the *Foce del Fusaro*. The water of the lake is brackish, more salt than fresh. The lake is famous for its oysters, which have been cultivated here (see OYSTER) since the times of the ancient Romans. They are larger and of finer flavour than those of the Bay of Naples. The lake is supposed to be the crater of an extinct volcano; and, in 1838, great quantities of noxious

gases were emitted, by which the oysters of the lake were killed. The lake of F. received from the ancients the name of *Acherusia Patus*, probably at first bestowed on it by the Greeks of Cumæ in consequence of its proximity to Avernus, and its crater-like character. In the later times of the Roman Empire, however, its banks were adorned with the villas of wealthy Romans.

## G



**ADJAT'CH**, or **GADIT'CH**, a town of South Russia, in the province of Poltava, and 65 miles north-by-west from Poltava, at the confluence of the Khoral with the Psiol. It has seven churches and a monastery, and an active trade in agricultural produce. Pop. (1867) 7110.

**GAJSIN**, or **GAJSSIN**, a town of South Russia, in the government of Podolia, 172 miles north-by-west from Odessa. Pop. (1867) 9671.

**GALLARATÉ**, a market-town of North Italy, in the province of Milan, and 24 miles north-west of the city of Milan. It is situated on the eastern side of the Somma Hills, at the commencement of the fertile region that extends to Milan, with which place it is connected by railway. It is well built, and surrounded by ancient walls; has extensive steam cotton-mills, and an active trade in agricultural produce. Pop. 4500.

**GALLIATÉ**, a town of North Italy, in the province of Novara, four miles east-north-east from Novara. It is rather a mean and dirty town, with an old castle and an old church. There are silk-mills here, and cotton-stuffs are also manufactured. G. has an annual fair, which lasts three days. Pop. about 6700.

**GAMBETTA**, **LÉON**, a French lawyer and statesman, was born on 30th October 1838 at Cahors. His family was of Genoese descent. He studied law; and in 1869 joined the Paris Bar. It was not till 1868 that his name came prominently before the public. He then acquired fame as counsel for defendants in political prosecutions. He shewed himself an able and determined enemy of the second empire. He was in consequence returned to the chamber, both at Paris and Marseilles, at the elections of 1869. On the 5th May 1870, he delivered a speech containing a panegyric of the republican form of government, which attracted great attention. After Sedan, he became Minister of the Interior, and he remained for some time in Paris after it was invested by the Germans; as he was anxious, however, to stir up the provinces, he contrived to escape from the city by a balloon. He came down at Amiens, and thence proceeded to Tours, where he was intrusted with the control of the war department. He assumed unlimited power, and made every effort to stir up the provinces in defence of Paris. He preached *guerre à outrance* against the Germans, denounced the capitulation of Metz as an act of treason on the part of Marshal Bazaine, and predicted that once rid of him, the French army would sustain no further defeat. When it was resolved to appoint a National Assembly, G. sought, by a decree dated 31st January 1871, to give the new body an exclusively republican

character by directing that no official connected with the second empire should take part in the election. The decree was, however, objected to by Prince Bismarck, and cancelled. G. then resigned office as minister, and went for a short time to Spain. He subsequently entered the assembly as a member for Paris, and became the leader of the extreme left. To the violence of a speech which G. subsequently delivered at Grenoble, was attributed to a great extent the reaction which in France set in against republican government, and the retirement of M. Thiers.

**GANGI**, a town of Sicily, in the province of Palermo, 53 miles south-east from Palermo. It occupies the summit and slopes of a steep and lofty hill. A more ancient town of the same name stood two miles to the south, and is supposed to have occupied the site of the ancient *Engusam*. The old town of G. was destroyed in 1299 by Frederick II., for the rebellion of Francesco Ventimiglia, its feudal lord. One of the best Sicilian painters of the 17th c., Giuseppe Salerno, was born here, and is generally known as *Lo Zoppo di Gangi*, from his lameness. One of the churches contains a much-admired painting of the 'Last Judgment,' from his hand. Pop. 10,600.

**GANGS**, **AGRICULTURAL**, a name specially given to companies of women, and boys and girls, brought together for labour in the fen-districts of England, or the low and level tracts which lie south of the Wash in the counties of Lincoln, Cambridge, Norfolk, Suffolk, and Rutland. Not many years ago, the part of the country referred to was a marsh. Dykes and canals have, however, been constructed to drain it, and it has been converted into one of the most fertile agricultural districts of England. It might have been expected that when covered with corn-fields, an agricultural population would have spread into it, and that houses would have been erected for their accommodation. This, however, is not the case. English landlords shunned the responsibility incurred under the poor-law, by the erection of houses for labourers. The reclaimed land was accordingly cultivated by labourers from the villages, which are numerous on the high ground that borders it. To save expense, they consisted, as much as possible, of women, girls, and boys. They worked in gangs, and as many as 27,000 persons were so employed. Among the last acts passed at the close of the session 1866—1867 was one for the regulation of agricultural gangs. It provided that no woman or child was to be employed in the same gang with men or boys, and that no woman or girl was to be employed in any gang under a male gang-master, unless a woman licensed to act as superintendent was also present with the gang. The act was received with hearty approval in the districts

## GANGUE—GAS-LIGHTING IN RAILWAY TRAINS.

chiefly concerned, and its effect has been most salutary. The inquiry which preceded it led to the appointment of a commission in 1867, to inquire into the employment of children and women in agriculture, with the view of ascertaining how far the principles of the Factory Acts can be applied to them, and especially with a view to the better education of the children. One result of the evidence obtained was the passing of the Agricultural Children Bill, on 5th August 1873, which directs that no child shall be employed in agriculture under the age of 8; that none shall be employed between the ages of 8 and 10, who cannot produce a certificate of 250 attendances at school in the previous year; and none between the ages of 10 and 13, who cannot produce a certificate of 150 attendances.

**GANGUE** (Ger. *Gang*, a vein), the stony matrix in which metallic ores occur. Quartz is the most common gangue, but calc-spar is also very frequent, sulphate of barytes and fluor-spar not unfrequent. Large portions of the gangue are generally worked and submitted to metallurgic processes for the sake of their contents.

**GAS-ENGINE.** Many attempts have been made to utilise, as a motive-power, the expansive force arising from the explosion of a mixture of common coal-gas, such as is in general use for illuminating purposes, and common air. The only attempt of this kind which has had any commercial success is that of Lenoir, a French inventor. The cut represents his engine. It resembles in its general features

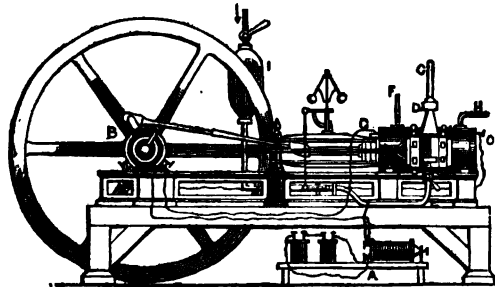

Gas-engine :

A, electric battery; B, distributor of electricity; C, electric igniters; D, admission of air (atmospheric); E, admission of gas (common coal-gas); F, exhaust pipe; G, water-pipe (inlet); H, water-pipe (outlet); I, India-rubber pouch.

an ordinary horizontal steam-engine. It has two slides, one on each side of the cylinder, which are opened and closed by eccentrics in the usual way. Through one of the slides, air and gas flow into the cylinder, in the proportions of about 11 of air to 1 of gas, until the cylinder is nearly half full, when the connection with the galvanic battery is made by the revolution of the shaft at B, causing a spark inside the cylinder, and consequent explosion of the mixture of air and gas. This explosion forces the piston from the middle of the cylinder to the further end. The products of the explosion then escape from the cylinder by the other slide-valve, which opens at the proper instant. The momentum which the fly-wheel has now acquired will carry the piston back to the middle of the cylinder, sucking in behind it, through openings, which are made by the action of the eccentric on the slide, a fresh supply of air and gas; and when the piston has reached to the middle of the cylinder, the further inflow of air and gas is stopped by the slide closing, and at the same instant a spark of electricity is sent into the air and gas, exploding it as before. The first half of the stroke of the piston is thus

employed in sucking in the requisite quantities of air and gas, and the last half of the stroke giving off the power arising from the explosion of the mixture of air and gas. The battery used by Lenoir is a Ruhmkorff's coil. Now, it is obvious that the wages saved by dispensing with a stoker will go far to pay the total cost of keeping the engine going. The difficulties attending the use of such an engine arise from the heat developed by the explosions in the cylinder, which burns the lubricating material necessarily used to make the piston slide easily on the cylinder. However, by keeping a current of cold water slowly circulating through the jacket of the cylinder, the heat is kept within moderate bounds; and for purposes where a very small power is required, not exceeding 2 or 3 horses, and where gas does not cost more than 4s. or 5s. per 1000 cubic feet, it is said that it can be kept going for less cost than a small steam-engine of equal power. In consequence of the piston doing useful work for one-half of the stroke only, the cylinder requires to be considerably larger than the cylinder of a steam-engine of equal power. A 2 horse-power gas-engine has a cylinder 8 inches diameter, and 16 inches stroke. A high-pressure steam-engine of this size would be 6 horse-power at least. Hujon's gas-engine is very similar to Lenoir's in general construction, but the explosive mixture is ignited by a gas jet instead of by an electric spark.

It is proper to mention here, in connection with engines working by explosion, that *gunpowder* engines were very early proposed; Papin designed one, and later on Cartwright, about 1790. The obvious danger attendant on the use of such a material as gunpowder, when worked for this purpose by even intelligent mechanics, prevented their succeeding. Gas-engines have also been designed in which the air was mixed with hydrogen or carbonic oxide instead of common coal-gas.

### GAS-LIGHTING IN RAILWAY TRAINS.

Many methods have been tried within the last few years for lighting railway carriages with ordinary street gas; but, although tolerable success has been obtained, no one plan has yet completely fulfilled all the conditions of the case.

The more prevalent schemes are those in which the gas is contained in an elastic receptacle. Mr Allen's plan, tried on some of the Scotch railways, is to place an india-rubber bag or box in the guard's compartment; it is protected by iron rods or bands, and weighted to press out the contents as the exhaustion goes on. The bag is filled with gas at the station from whence the train starts. A tube from the bag passes out by an opening from the van, and leads up to metal pipes that run along the roofs of the carriages. An india-rubber tube forms an elastic link from carriage to carriage; and small pipes bend down through the roof to supply burners in the interior of each carriage. The guard can regulate the supply, making the lights brighter or dimmer by easy apparatus under his control. The chief disadvantage of such plans as this is, that no carriages can be added to or deducted from the train without disturbing the arrangements, seeing that the tubing forms a connected system from end to end.

Mr Dalziel's plan, tried on the South-eastern and the Great Northern lines, enables each carriage to maintain its light irrespective of the others in the train. There is a reservoir underneath the floor of the carriage; consisting of a boiler-like wrought-iron vessel, nine or ten feet long by a foot and a half in diameter; it is invisible, and in no way incommodes the passengers. It is filled at the station, before the train starts, with gas enough to last all the burners in the carriage during a double

along the top to the spots where they bend down to supply the burners. The gradual exhaustion of the reservoir would produce a constantly decreasing pressure on the gas, and a consequent dimness of the light; but this is prevented by the use of an automatic compensating valve, which maintains the pressure equably. The gas, in the first instance, is forced into the reservoir at a pressure of 120 lbs. on the square inch.

The Metropolitan or Underground Railway, running for so great a part of its length through a dark tunnel, would be insupportably gloomy if the carriages were not well lighted. A system of gas-lighting is therefore adopted. Before the starting of each train, gas is conveyed from a gas-holder up through elastic tubes to the top of each carriage, where an oblong box extending from end to end receives enough of gas to last for two journeys. The brevity of the journeys renders practicable here a plan which would not be available for a journey of several hours. Railway companies generally have not yet seen reason to prefer gas; they are still experimenting on lamps fed with oil of various kinds.

**GEMONA**, a town of Venetia, 15 m. N.-by-W. from Udine, on a feeder of the Tagliamento. It lies in a deep basin among mountains, and is a well-built town, surrounded by walls. G. has a large transit-trade, and two important annual fairs. Pop. 6634.

**GENZA'NO**, or **GENSANO**, a town of the province of Rome, Italy, 17 m. S.-by-E. from Rome, in a district of hills and ravines. G. has several broad and straight streets, proceeding from a handsome square, which is ornamented with a beautiful fountain. On one of the hills above the town is the feudal mansion of the Cesarini family. G. is celebrated for an annual festival, held on the eighth day after *Corpus Christi*, called the *Infiorata di Genzano*, from the custom of strewing the streets with flowers, so as to represent arabesques, heraldic devices, figures, &c. On occasion of the festival, many visitors are attracted from Rome. Pop. 5000.

**GERANIA'CEÆ**, a natural order of exogenous plants, consisting of herbaceous plants and shrubs, of which about 500 species are known, distributed over the whole world, and particularly abundant in South Africa. The stems are jointed, usually tumid, and easily broken at the joints. The leaves are simple in some, divided in others, opposite, or alternate, with flower-stalks opposite to them; they have membranous stipules. The calyx consists of five persistent sepals; the corolla of five petals, which are clawed. The stamens are united by their filaments, hypogynous, twice or thrice as many as the petals. The ovary consists of five carpels, placed around a long awl-shaped *torus* or *carpophore*, to which the styles cohere; ripening into a fruit which consists of five small one-seeded shells, cohering around the base of a long beak, the indurated style of each carpel finally curling back from the base upward, and carrying the seed along with it. The indurated styles are in many species extremely hygroscopic, and their twistings and untwistings seem intended to move the seed after it has fallen, until it reach a fit place for its germination. See **GERANIUM**.

**GERMANY**. The important changes which have taken place within recent years in the political relations of the component parts of Germany having been but slightly touched upon in the article **GERMANY** in the body of this work, we purpose here to give some account of these changes, and of the wars which led to them. The immediate occasion of the war of 1866 was the difference that arose between

**SLESVIG** after the Convention of Gastein (1865). But the real grounds lay in that rivalry between the two states for the leadership of G., the germ of which is as old as the time of the Great Elector (see **FREDERICK-WILLIAM**), and which has shewn itself at many epochs of the history (see **GERMANY, History**). There can be little doubt that the feeling of the German people, as distinguished from the princes and bureaucracy, has, in recent times at least, been in favour of the purely German Prussia as their leader, rather than Austria, the great mass of whose population are Slaves and Magyars. And when the parliament of Frankfurt, in 1850, offered the imperial crown to the king of Prussia, the unity of G. might have been secured without bloodshed, had the monarch been resolute, or had he had a Bismark for his adviser. But that opportunity being let slip, and the incubus of the 'Bund' being restored, it became apparent that the knot must be cut by the sword.

By the treaty of Gastein, Austria and Prussia agreed to a joint occupation of the Elbe duchies; but to prevent collision, it was judged prudent that Austria should occupy Holstein, and Prussia Slesvig. Already a difference of policy had begun to shew itself: Prussia was believed to have the intention of annexing the duchies; while Austria began to favour the claims of Prince Frederick of Angustenburg, and wished to refer the disposal of the matter to the Bund. In the meantime, both nations were making ready for the struggle. In fact, the preparations of Prussia had been going on for two or three years; and the new organisation of her army, which had occasioned the protracted contest between the government and the house of deputies, had been made with a view to some such eventuality as was now to occur. The preparations of Austria were made more openly, as she could plead the necessity of meeting the warlike attitude of Italy; which power, looking upon the quarrel between Austria and Prussia as a precious opportunity, was actively arming, with a view to strike a blow for the liberation of Venetia, and had secretly entered into an alliance with Prussia.

At this crisis, England, France, and Russia invited the disputants to a conference. Prussia and Italy readily consented; but nothing came of it, through the obstinate pride of Austria, who would not allow her position in Italy to be even taken into consideration. Never, perhaps, was a greater blunder made. Had she at this moment ceded Venetia for a reasonable compensation, she would have replenished her empty treasury with a good many millions, have made Italy friendly, or at least neutral, and set free her best army of 80,000 veterans for the inevitable contest with her northern rival. A few weeks later, she made the concession with a bad grace, without compensation, and to no purpose.

On the failure of the conference, Benedek, commander-in-chief of the Austrian army of the north, issued an order of the day, dated 12th May, in which he announced that he had been appointed 'to lead the brave and faithful Austrian army against the unjust and wanton foes of the empire.' It only remained to find a formal ground for the declaration of war, and that ground was found in the Slesvig-Holstein question. In the sitting of the German diet, June 1, 1866, Austria, disregarding the Convention of Gastein, placed the whole matter at the disposal of the Bund, and then proceeded to convulse the states of Holstein 'to assist in the settlement of the future destination of the duchy.' Prussia protested against this as an insult and a violation of treaty; demanded the re-establishment of the joint

troops into Slesvig, marched troops of his own into Holstein. Instead of responding to this invitation, Austria withdrew her forces altogether from Holstein, under protest; and then, calling attention to this 'act of violence' on the part of Prussia, proposed that the diet should decree 'federal execution' against the enemy of the empire. This eventful resolution was carried by a great majority on the 14th June 1866; Hanover, Saxony, Hesse-Cassel, Hesse-Darmstadt, and the 16th Curie voting for it. The resolution having passed, the Prussian plenipotentiary, in the name of his government, declared the German Confederation dissolved for ever, and immediately withdrew.

When the news of the federal execution was received in Berlin, identical notes were sent to the courts of Saxony, Hanover, and Hesse-Cassel, demanding the reduction of their armies and assent to the convocation of a common German parliament; on which condition, Prussia would guarantee their territories and sovereign rights as her allies. Twenty-four hours were allowed for the decision; and when the term had expired without assent, the Prussian troops, which had previously been concentrated on the frontiers, crossed at once into the three kingdoms, and took military possession without resistance. The Saxon army retired into Bohemia, to join the Austrians; that of Hanover, after vainly trying to make its way south to join the army of the Bund, and bringing on the useless affair of Langensalza, was forced to lay down its arms, and return home.

Besides the moral advantage gained by this display of promptitude in paralysing her declared enemies and securing the adhesion of waverers, Prussia had by these occupations secured her rear, and, in Saxony, had won a favourable basis for operating against Austria. The Prussians now lost no time: war was declared against Austria; and, following the example set by Frederick the Great, the troops immediately began to march into Bohemia. To their own surprise, as well as that of all Europe, they were allowed to pass the easily-defended defiles without opposition, or even seeing an enemy. So great was the reputation of Benedek, that every one now began to look for some deep-laid plan by which the enemy was to be enticed into the heart of the country, only to be completely and at once overwhelmed. But, as it turned out, there was no plan at all. With their usual sluggishness, the Austrians were taken by surprise in a state of unreadiness—ill organised, ill equipped, ill provisioned; and although in actual engagement the soldiers fought bravely, they were animated with a very different spirit from their opponents. The Prussian people had at the outset been rather averse than otherwise to the war; and in some places, it required strong measures to make the Landwehr take the field. But once under arms, and as the object of the struggle became more apparent, they entered into it with enthusiasm, and manifested a rare combination of soldierly qualities, the results of a universally diffused education and military training, and while such was the quality of the men, seldom has an army taken the field so well organised, with the plan of the campaign so well laid, the arms so efficient, and the equipments in every way so complete.

The Prussian host invaded Bohemia at three several points: the central army, under Prince Frederick-Charles (q. v. in SUPP., Vol. X.), entered from Eastern Saxony, crossing the frontier range of the Erzgebirge by Krottau, Friedland, and Neustadt, towards Reichenberg; the western or 'Elbe' army, under General Herwarth von Bittenfeld, started from Dresden, and entered Bohemia by Neustadt

or 'Silesian' army, under the Crown-prince, Frederick-William (q. v. in SUPP., Vol. X.), invaded from Silesia by the Landshut and Nachod passes, marching towards Trautenau and Skalitz. The first of these armies numbered 72,000 infantry, 11,000 cavalry, and 294 guns; the second, 34,000 infantry, 3900 cavalry, and 132 guns; and the third, 92,000 infantry, 12,500 cavalry, and 348 guns—in all, 225,400 men, and 774 guns. To oppose these, the Austrians had 55,000 infantry, 5400 cavalry, and 172 guns (inclusive of the Saxon army, which had been withdrawn into Bohemia on the approach of the Prussians), under Count Clam-Gallas, stationed along the frontier north of Turnau and Leitmeritz; and 186,000 infantry, 16,000 cavalry, and 544 guns, under Marshal Benedek, the commander-in-chief, in Eastern Bohemia, behind the Riesengebirge—in all, 262,400 men, and 716 guns. As the Austrians expected the attack from Silesia, by far the greater portion of their army was stationed behind the Riesengebirge; so that when Von Bittenfeld and Prince Fr.-Karl crossed the Erzgebirge (June 24), they found themselves opposed by only the outlying brigades of Clam-Gallas, which they forced to retire towards Turnau and Münchengrätz, after defeating them in some insignificant combats at Reichenberg, Langenbrück, Liebenau, and Turnau, and in a severe struggle at Podol, which cost the Austrians in all 2400 in killed, wounded, and prisoners; the loss of the Prussians being only 124 men. The first and second Prussian armies, now united, advanced leisurely, driving the enemy before them towards Münchengrätz, where Clam-Gallas had strongly posted himself, and where, on June 28, he was attacked by the combined Prussian armies, and after a brief but severe contest, forced to retreat in haste. By several routes, the combined armies under Prince Friedrich-Karl now continued their onward march, routing the detached corps of Austrians and Saxons which attempted to bar their progress; and after a severe contest (June 29), which cost the Prussians 2000 men, and the Austrians about twice as many, took possession of Gitschin, and encamped on the following morning between that town and Horzitz, having established communications with the Crown-prince; while Clam-Gallas retired to join the main body under Benedek, after having, with a force only half as numerous as his opponents', and still more inferior in guns, compelled his antagonists to spend six days in making an advance of 40 English miles.

Meanwhile, the third Prussian army had advanced in two divisions, the right wing through the passes of the Riesengebirge by Landshut, towards Trautenau; the left by Glatz, towards Nachod and Skalitz; while the centre divisions crossed by Braunau, all crossing the frontier on June 26. The defiles were traversed without opposition, the Austrians being only posted at the mouths of the passes; but as the left wing under Steinmetz debouched towards Nachod, it was assailed (June 27) by Ramming's Austrian corps, and driven back into the pass. Steinmetz, however, persevered; and by the aid of his guns, and repeated charges of cavalry, succeeded, after a conflict of six hours, in extricating his corps from the defile, at a cost of 1191 killed and wounded, to 6000 on the part of the Austrians. Both armies being reinforced, the contest was renewed at Skalitz on the 28th; but, though long and bloody, it was on all sides favourable to Steinmetz, who beat the Austrians back upon Josephstadt, with a loss in killed and wounded of 5815, and 5850 prisoners, with five guns. The Prussian right wing, under Bonin, had also a double conflict with the Austrians, who were posted to receive them; for, after extricating themselves from the Landshut defile,

General Gablentz, and after a long and unfruitful fight, were driven back to their previous camping-ground, losing, however, only 1423 men, to about 3500 of the Austrians. Gablentz being much exhausted with his hardly-won victory, obtained reinforcements from Benedek; and the Prince of Würtemberg, with a corps of Guards, being sent by the Crown-prince (who marched with the centre, ready to afford support to either wing when necessary) to attack Gablentz by Eypel, fell upon him (June 28) while he was preparing to complete the defeat of Bonin, and, after a severe combat, or rather series of partial unconnected combats, the Austrians were this time defeated, with a loss of 4000 men, and an equal number of prisoners; the Prussian loss being only 834 killed and wounded. The three Prussian armies having thus effected a firm lodgment in Bohemia, moved steadily forward in lines, converging to a point north of the Austrian army, which was now concentrated between Josephstadt and Königgrätz; and the king of Prussia, who had arrived (July 1) at the head-quarters of the 1st and 2d armies, hearing of Benedek's intention to assault them before the Crown-prince's army could come to their aid, resolved to anticipate him, and ordered an attack on the Austrian position at 8 A.M. on July 3, at the same time sending off an urgent dispatch to hasten the arrival of the Crown-prince, whose host, at 8 A.M. on the 3d, was 15 miles off. The Prussians, at the commencement of the fight, believed they had to do with only the half of the Austrian army, but they were soon undeceived, for, after carrying the villages in front of the Austrian position, and advancing up the slope, they were met by such a crushing fire of artillery as completely stopped their further progress. Benedek then directed his reserves against the Prussian left, in order to cut it off from the Crown-prince, but all his endeavours to drive it permanently from its position failed. The conflict, which was mainly an artillery-fight, thus continued without intermission, and the Prussian left was almost on the point of giving way before the overwhelming numbers of its assailants, when the wavering of the Austrian right unmistakably shewed that a portion at least of the third army had arrived, and attacked them in flank. This new assailant becoming more formidable every minute, speedily rolled up the Austrian right wing; and the advance of the 1st and 2d armies, by partially enclosing the Austrians between two fires, threw them into great confusion. Their array was soon broken, and dissolved in precipitate flight; multitudes perished in the morasses, in the waters of the Elbe, and under the wheels of the fleeing baggage-wagons; but the undaunted attitude of the splendid Austrian cavalry, and the deficiency of the Prussians in that arm, greatly mitigated the horrors of the rout. The Prussians lost upwards of 9000 killed and wounded; the Austrian loss was 16,235 killed and wounded, and 22,634 prisoners. After this decisive defeat, which is known as the battle of Königgrätz, or Sadowa, all hope of staying the advance of the Prussians with the army of Benedek was at an end; a truce was asked for, but refused; and the victorious Prussians pushed forward towards Vienna, whither Benedek had drawn his beaten forces. At the same time, the southern army, which had been employed against the Italians, was collected at the capital, and every precaution was taken, by the erection of entrenchments, fortifications, &c., to insure the safety of Vienna, when, by the agency of the Emperor of the French, a truce was agreed to, which afterwards led to a treaty of peace.

A few days before this campaign had commenced,

from the yoke of the alien, and commencing with all the enthusiasm and heroic spirit of a young nation, no small portion of its overweening presumption, had assembled an army of 200,000 men, one half of which, under General Della Marmora, was destined to cross the Mincio between Peschiera and Mantua; while the other half was stationed round Bologna, to operate on the lower Po. To oppose this force, the Archduke Albert, the commander-in-chief in Venetia, had about 90,000 men near Verona, besides the garrisons of the Quadrilateral and Venice, which, of course, were not available for field-service. On June 23 (on which day it was notified to the Archduke that hostilities would be commenced), La Marmora's army crossed the Mincio, unopposed by the Austrians; and the Italian commander, not expecting attack, masked the fortresses of Peschiera and Mantua, and marched the rest of his army forward in a somewhat careless fashion. The Archduke, however, had been all along watching his opponent; and after having succeeded in getting him entangled between the river and the hills, he attacked him (June 24) with his whole force. The Italian left was speedily broken and driven back, and would have been wholly destroyed had not General Pianell, whose division was on the right bank of the Mincio, crossed the river, and held the assailants at bay during the rest of the day. The Austrian attack on the Italian right was, however, at first unsuccessful. In the centre, where were situated the village of Custoza and Monte Belvedere, the keys of the position, an obstinate struggle was maintained on both sides throughout the day, but towards 4 P.M. victory inclined to the Austrians, and soon after they gained possession of the position which decided the day. The Italians fell back, in fair order, towards the Mincio, unpursued by their exhausted opponents, and on the following day, were all again assembled on the right bank of the river. The Italians lost in killed, wounded, and prisoners, 8175 men, and several pieces of artillery; while the loss of the Austrians was about 8000 men. This plan of the campaign having failed, the Italian generals set about devising another, and spent more than a week in deliberation and discussion. At the end of this time, news came of the great defeat which the Austrians had sustained in the north, and of the cession of Venetia, by the Emperor of Austria, to the Emperor Napoleon. Though it was not for a moment in doubt that this cession was only a round-about way of surrendering the province to Italy, the Italian government, true to the Prussian alliance, refused to conclude a separate treaty; and (the Archduke's army having been, as before mentioned, withdrawn for the defence of Vienna) Cialdini's army crossed the Po (July 7), and occupied Padua, Vicenza, and Treviso; while Garibaldi, at the head of his volunteers, and General Medici, with a division of Cialdini's army, advanced up the Lake of Garda into the Trentino, the small body of Austrians in the district being wholly unable to offer a successful resistance to such an overwhelming attack. Not content, however, with attacking Austria by land, a fleet was equipped, and despatched, under Admiral Persano, to assail the Dalmatian coast, and retrieve for Italy by her navy the disgrace which had fallen upon her army; and, accordingly, Persano directed an attack on the island and forts of Lissa, and failed. News of this attack being communicated to Admiral Tegethoff, the commander of the Austrian fleet in the Adriatic, he sailed at once for the relief of Lissa; and though his ships were inferior in number, size, and weight of ordnance, and only 7 of them ironclads, to 12 more powerful vessels of the same sort in the Italian

surveyed or sunk two of the largest of the enemy's vessels, broke through his fleet, and took up a position in front of Lissa, ready to renew the fight if necessary. The Italian fleet, however, drew off, and on the following morning, was out of sight, making for Ancona.

Thus baffled both on land and sea, Italy, though vigorously professing her determination to go hand in hand with Prussia, was very loath to agree to the armistice signed by the two belligerent German powers at Nikolsburg, on July 26; and attempted to salve her chagrin by insisting upon the surrender by Austria to her of the Trentino. Prussia, however, having agreed with Italy only for the cession of Venetia, was not inclined to support this demand; and Italy, seeing that she must either make peace or fight for the Trentino, single-handed, against Austria, gave way reluctantly, and agreed to the armistice, August 12.

A third contest was, about the same time, in progress between Prussia and those minor states of Germany which had raised armies to support Austria, viz., Bavaria, Württemberg, Baden, and Hesse-Darmstadt. After the capture of the Hanoverian army, the Bavarians, who, under Prince Charles of Bavaria, had been advancing slowly to join them, took post, on June 30, at Suhl, in the valley of the Werra. A second army had been assembled under Prince Alexander of Hesse-Darmstadt, and had been drawn together in front of Frankfurt. To prevent the junction of these two armies, the Prussian general, Vogel von Falkenstein, who had 48,000 infantry, 3300 cavalry, and 96 guns, threw a part of his forces forward toward Fulda, and with the remainder attacked the Bavarians, who were inferior in number, and routed them at Dermbach, Kaltenordheim, and Hänfeld, driving them towards Kissingen; he then turned his superior force against Prince Alexander, whom he forced to retreat towards Darmstadt. The two armies were now completely separated, and Von Falkenstein found little difficulty in keeping them apart during the rest of the brief campaign, and in routing the Bavarians at Kissingen and Hammelburg, and the Darmstadters at Aschaffenburg, and driving the broken remnants of the two armies south of the Main. He then crossed the Main, and occupied Würzburg, in Bavaria. After some little delay, peace was concluded between these four minor states and Prussia; but, unlike Austria, of which they were merely the allies, some of them were forced to submit to a certain loss of territory.

The states north of the Main which had taken up arms against Prussia, were completely incorporated—viz., Hanover, Hesse-Cassel, Nassau, Frankfurt, and a small portion of Hesse-Darmstadt, as well as Slesvig-Holstein and Lauenburg; and the other states north of the Main were united with Prussia in a confederacy of a more intimate nature than before existed, called the *North German Confederation*.

Bavaria, Baden, Württemberg, the part of Hesse-Darmstadt south of the Main, and Liechtenstein were not included in this union, but were invited to reform their armies and enter into a closer mutual relationship, with a view to a military and political connection with the Confederation.

Saxony, which had prominently figured in the contest as an ally of Austria, was doomed by Count Bismark to incorporation; but Austria, supported by France, so steadily opposed this arrangement, that it was abandoned, and the little kingdom was admitted into the Confederation.

Austria, by the treaty of Prague (23d August 1866), was completely excluded from participation

to remain; agreed to the surrender of venetia to Italy, to the incorporation of Slesvig-Holstein with Prussia, and to the new arrangements made by Prussia in Germany. A portion of the fifth article of this treaty secured that, if the 'inhabitants of the northern districts of Slesvig declare, by a free vote, their desire to be united to Denmark, they shall be restored accordingly.' Though losing no territory to Prussia, Austria had to pay 40 millions of thalers for the expense of the war, after which payment the Prussian troops were to be withdrawn from the imperial territories.

Saxony resigned to Prussia the right of garrisoning Königstein, and of partially garrisoning Dresden, and paid ten million thalers of war-indemnity; Bavaria (by treaty of Berlin, 22d August) surrendered several districts of Lower Franconia to Prussia, and paid 30 millions of gulden for war-indemnity; Baden (by treaty of Berlin, 17th August) and Württemberg (by treaty of 13th August) surrendered no territory, but paid, the former six, and the latter eight, millions of gulden; while Hesse-Darmstadt (by treaty of Berlin, 3d September) surrendered various districts of the province of Ober-Hesse, receiving in return several districts formerly belonging to Electoral Hesse, Nassau, and Frankfurt, and paid three millions of gulden for war expenses; also the province of Ober-Hesse, into which were to be incorporated the districts ceded by Prussia, was to form a part of the North German Confederation, the other parts of the grand duchy south of the Main being unconnected with it. Even the little principality of Reuss had to pay 100,000 thalers into the fund for Prussian invalids.

The North German Confederation, as thus constituted, possessed a common parliament, elected by universal suffrage, in which each state was represented according to its population. The first or constituent parliament met early in 1867, and was employed in deliberating over the details of the proposed constitution for the Bund, which was drawn up and submitted to it by Count Bismarck. After some weeks' discussion, the draft, with a few modifications, was agreed to; the new elections then took place, and the first regular North German parliament met in September 1867. According to this constitution, there was to be a common army and fleet, under the sole command of Prussia; a common diplomatic representation abroad, of necessity little else than Prussian; and to Prussia also was intrusted the management of the posts and telegraphs in the Confederation.

The southern German states, which up to this point had not joined the Bund, were Bavaria, Baden, Württemberg, Hesse-Darmstadt, and Liechtenstein, with a joint area of 43,990 sq. m., and a total population (1866) of 8,524,460. But though these states were not formally members of the Bund, they were so practically, for they were bound to Prussia by treaties of alliance offensive and defensive, so that in the event of a war the king of Prussia would have at his disposal an armed force of upwards of 1,100,000 men.

In the spring of 1867, a war between Prussia and France seemed imminent, from difficulties arising out of the occupation of Luxembourg by the former; but by the good offices of the British government, a congress was assembled at London, at which representatives of the great powers (Italy included) were present, and an arrangement satisfactory to both nations was amicably agreed upon, the province under dispute remaining in the possession of the king of Holland. Though the outbreak of hostilities was thus averted for the present, neither



carried on.

During the next few years, the North German Confederation was employed in consolidating and strengthening itself, and in trying to induce the southern states to join the league. The Zollverein (q. v.) was remodelled and extended, until by the year 1868, every part of Germany was a member of it, with the exception of the cities of Hamburg and Bremen, and a small part of Baden. This paved the way for the formal entrance of the southern states into the confederation; but they still hung back, though it daily became more evident that a united Germany would soon be an accomplished fact.

In 1870, the long-threatened war between Prussia and France broke out. On July 4 of that year, the provisional government of Spain elected Prince Leopold of Hohenzollern, a relative of King William of Prussia, to fill their vacant throne. This step gave the greatest umbrage to the French government, and the Paris journals almost unanimously asserted that the accession of this prince to the Spanish throne would be tantamount to the re-establishment of the empire of Charles V., in favour of Prussia. M. Benedetti, French minister at Berlin, was instructed to ask explanations from King William; and, though by the advice of that monarch, Prince Leopold resigned his candidature, the French government was not satisfied, but demanded an assurance that Prussia would at no future period sanction his claims. This assurance the king refused to give; and on the 23d of July the emperor of the French proclaimed war against Prussia. Contrary to the expectation of France, the southern German states at once decided to support Prussia and the northern states, and placed their armies, which were eventually commanded by the Crown Prince of Prussia, at the disposal of King William.

Early in August the forces of both countries were congregated on the frontier. Napoleon, however, lost a fortnight in delays after the declaration of war, and it was discovered that the French army was by no means in a state of satisfactory preparation, while the Germans were splendidly organised, and much superior in number. The result was, that the French, instead of marching to Berlin as they anticipated, never crossed the Rhine, and had to fight at a disadvantage in Alsace and Lorraine.

On August 2, the French obtained some trifling success at Saarbruck, but on the 4th a brilliant victory was achieved by the army of the Crown Prince of Prussia at Weissenburg. This was followed by the victory of Wörth on the 6th, in which the French, under MacMahon, lost 4000 prisoners, and were pursued towards Metz. On the same day, the French under General Froissard were again defeated at Spicheren, and lost 2500 prisoners. On the 14th the Prussians occupied Nancy, and on the 16th the French army under the command of Bazaine was driven back on Mars-la-Tour. The battle of Gravelotte, in which King William commanded in person, was fought on the 18th; and, though the Germans suffered immense loss, they were again victorious, and forced Bazaine to shut himself up in Metz. The losses of the French in these last three days' fighting amounted in dead alone to upwards of 12,000 men. About 4000 prisoners were made at Gravelotte. The Emperor Napoleon and Marshal MacMahon in vain attempted to proceed to the relief of Bazaine. They were surrounded at Sedan, and completely defeated with heavy loss. The emperor surrendered on the 2d September, with his whole army, about 90,000 men, and was sent as a prisoner into Germany. By the 19th of September the Prussians

bombarded Metz with an army of 6000 officers and 173,000 men, 400 pieces of artillery, 100 mitrailleuses, and 53 eagles. Verdun capitulated on the 8th November; Thionville followed on the 24th; after which there were several capitulations of lesser importance.

The French made extraordinary efforts to raise armies and relieve Paris, but, with the exception of a momentary gleam of success on the Loire, they met with nothing but severe defeats. Of these may be mentioned the battle of Dec. 3 in the Forest of Orleans, and that of Le Mans, January 12, in which contests Prince Frederick Charles took altogether 30,000 prisoners. After numerous unsuccessful sorties, and enduring great sufferings from famine, Paris surrendered on the 29th of January, and the war was virtually at an end. The French army of the east, 80,000 strong, under Bourbaki, was compelled to retire to Switzerland on the 31st. France was condemned to pay a war indemnity of 5 milliards of francs, or £200,000,000; and the province of Alsace, along with the German part of Lorraine, was ceded to Germany.

A very important result of the war was to complete the fusion of the northern and southern states of Germany. As already stated, the southern states joined at once in the war against France, and in November of 1870, Baden and Hesse leading the way, they all became members of the German Confederation. Shortly after this, the king of Bavaria wrote to the king of Prussia, asking him to re-establish the German empire. The matter was thus brought under the notice of the Bund, and it was agreed that the empire should be restored, and the king of Prussia declared hereditary emperor of Germany. For an account of the present German empire, see GERMANY, Vol. IV.

The most memorable occurrence in Germany since the war, has been the struggle going on between the *Ultramontane* (q. v.) or extreme Roman Catholic party, and the *Alli Katholiken* (Old Catholics). The latter deny the papal infallibility, and wish for reforms in the church; while the former are strenuous upholders of the pope, and are, in political matters, opposed to the policy of the German emperor. In June 1872, Bismarck made a bold speech in the House of Deputies against the Ultramontanists; and before the year closed, the government came into active collision with that party. The conflict is still going on, and its ultimate issues cannot be predicted. See DOLLINGER in SUPP., Vol. X. The following table gives a list of the states composing the present German empire, with their areas and populations for 1871:

States.	Area in sq. m.	Pop. in 1871.
<b>KINGDOMS—</b>		
1. Prussia, . . . . .	133,929	24,606,533
Duchy of Lauenburg, . . . . .	453	49,546
2. Bavaria, . . . . .	29,280	4,832,026
3. Saxony, . . . . .	5,780	2,554,344
4. Württemberg, . . . . .	7,532	1,819,533
<b>GRAND-DUCHIES—</b>		
5. Baden, . . . . .	5,850	1,461,562
6. Hesse, . . . . .	2,962	852,894
7. Mecklenburg-Schwerin, . . . . .	5,136	557,497
8. Saxe-Weimar, . . . . .	1,403	286,158
9. Mecklenburg-Strelitz, . . . . .	1,180	96,963
10. Oldenburg, . . . . .	2,470	312,596
<b>DUCHIES—</b>		
11. Brunswick, . . . . .	1,425	311,764
12. Saxe-Meiningen, . . . . .	965	187,857
13. Saxe-Altenburg, . . . . .	510	142,122
14. Saxe-Coburg-Gotha, . . . . .	760	174,529
15. Anhalt, . . . . .	886	305,437

PRINCIPALITIES—		
16. Schwarzburg-Rudolstadt, . . .	367	75,523
17. Schwarzburg-Sonderhausen, . . .	332	67,191
18. Waldeck, . . . . .	438	56,324
19. Reuss (Ältere Linie), . . . . .	123	45,094
20. Reuss (Jüngere Linie), . . . . .	320	59,032
21. Schaumburg-Lippe, . . . . .	170	32,059
22. Lippe-Detmold, . . . . .	438	111,185
FREE TOWNS—		
23. Lübeck, . . . . .	110	52,158
24. Bremen, . . . . .	97	123,402
25. Hamburg, . . . . .	158	338,974
26. Alsace-Lorraine, . . . . .	5,590	1,549,587
Troops in France, 1871 (since withdrawn), . . . . .	..	48,643
Sailors at sea, . . . . .	..	2,054
	208,613	41,060,695

Christ' was exhibited; it was much canvassed by the critics, on the whole was received with favour, and ultimately was purchased by the state. This painting shewed an elevated taste and a noble ambition; the execution, too, was in many respects excellent, and the work greatly raised the author's reputation. In 1859, he exhibited his noble picture of Roman gladiators in the amphitheatre, with the motto: 'Cæsar, ave, Cæsar Imperator, morituri te salutant,' which raised to the highest pitch his reputation as a colourist and painter of the human figure, while making a profound impression by the success with which the human interest of the scene was rendered. With 'Phryne before her Judges,' exhibited in 1861, he won fresh honours as a colourist and draughtsman. In the same year, he exhibited, among other pictures, his 'Socrates searching for Alcibiades at the House of Aspasia;' 'Deux Augures non jamais pu se regarder sans rire;' and a portrait of Rachel. 'Louis XIV. and Molière,' 'The Prisoner,' and the 'Death of Cæsar' are among the best known of his subsequent works—the last, a finely conceived and nobly painted picture, which, for its architecture, its colour, and the subserviency of details very strikingly rendered to a definite human interest, demands the highest admiration. The 'Death of Cæsar,' the 'Phryne,' the 'Gladiators,' and 'Louis XIV. and Molière,' are among the pictures of G. which have been exhibited in London. G. has painted admirably several Eastern subjects; and of the mural pictures which he has executed for the city of Paris, one, the 'Plague at Marseille,' painted in one of the chapels of the church of St Severin, has received the highest encomiums. Though not to be ranked among painters of the first class, as a colourist and figure-painter he probably has no superior among living artists.

**GHOSTS, OPTICAL.** Many remarkable exhibitions have been introduced in recent years, based on certain simple laws of optics long known to scientific men. The mysterious phantom appearances have led to the designation of *ghosts*; but nothing necessarily either ghostly or ghastly attaches to the exhibition. No new principle has been discovered; it is nothing more than an ingenious application of mechanism to render visible to a body of spectators certain phenomena of reflection and transmission, by varying the intensity of light passing upon or through large plates of glass, and by adjusting the position of the actors with reference to the glass and to the spectators.

Mr Dircks, in a paper read before the British Association at Leeds in 1858, and afterwards embodied in a volume, said that his attention had long been directed to this matter. In 1838, he devised something which, under the name of a 'transparent mirror,' he thought likely to be productive of curious optical effects; but he abandoned the subject for nearly 20 years. In 1856, he happened accidentally to see a solid body so peculiarly placed as to appear to be transparent; and this led him to make a variety of experiments, to combine an object with its shadow or its reflection in such a way as to render their discrimination difficult. He supposed a theatre or room, with spectators placed on an elevated and darkened series of seats; and he shewed how they might see two illuminated figures on a stage, without knowing that one was a reality and the other a reflection. By following out the idea, he saw how an actor might get behind a plate of glass, and seem to communicate with the shadow or 'double' of a second actor—how, in other words, a living or solid figure might be so associated with a mere phantom, that the two could play a sort of drama together, suddenly terminated,

**Money, Weights, and Measures.**—By the law of 1873, provision is made for a uniform currency throughout the empire. The unit of reckoning is the Mark, approximately equal to one shilling English, or to one-third of the Prussian thaler (see DOLLAR). The mark is divided into 100 pfennigs. The standard is an imperial gold coin of 10 marks; there are also gold pieces of 20 and of 5 marks; and in silver, of 5, 2, and 1 mark. For the fractions of the mark, there are silver, nickel, and copper coins. A large amount of this new coinage has already been issued. For weights and measures, the French metrical system has been adopted.

**GERMERSHEIM**, a town of the Rhenish Palatinate, or Rhenish Bavaria, on the left bank of the Rhine, at the mouth of the Queich, eight miles south-west-by-south from Spire. The situation is marshy and unhealthy, but it was chosen by the Romans for a station and fortress, which was called Vicus Julius. The town was founded by the Emperor Rudolph I. in 1276. Having passed into the hands of the Electors Palatine, G. was taken by Leopold of Austria in 1622; and fell into the hands of the French in 1644, by whom it was restored to the Elector Palatine at the peace of Westphalia; but it was again taken by the French under Turenne in 1674, when the walls were demolished, and again in 1688. The peace of Ryswick restored G. to the Palatinate. There is some trade in corn, hemp, flax, &c., and a fishery. Pop. (1871) 6223.

**GEROME, JEAN-LÉON**, one of the most eminent of living French painters, was born in 1824 at Vesoul, where he received his early education. His father was a goldsmith. In his seventeenth year, he went to Paris, and entered the studio of Paul Delaroche, at the same time attending the School of the Fine Arts. He continued till 1844 the pupil of Delaroche, whom, in that year, he accompanied on a tour in Italy. In 1847, one of his pictures was exhibited at the Louvre. In 1851, he was commissioned to furnish a design for a vase which was to be manufactured at Sèvres in commemoration of the London Exhibition of that year. In 1853, he travelled in Turkey and upon the eastern waters of the Danube. He has since extended his knowledge of Eastern scenes by a journey in Egypt and the adjacent countries in 1856. In 1855, he received the Cross of the Legion of Honour; and in 1863, he was appointed Professor of Painting in the School of the Fine Arts, a position which he continues to hold. Many of his pictures have been exhibited in London, and there are few contemporary French painters whose works are so well known to the British public, or so high in favour with English critics. G. was decorated with the Prussian order of the Red Eagle in 1869. He first attempted a really great subject in 1855. In that year, his picture,

perhaps, by one of them fading away, and vanishing through the wall or furniture of the apartment.

Mr Dircks constructed a small box or model to illustrate the principle; and as it really contains the germ of most of the large subsequent exhibitions, we will describe it. The accompanying diagrams shew the outside view, the vertical section, and the ground-plan.

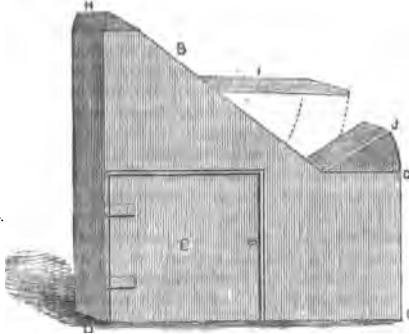

Fig. 1.—Outside View.

the other; F, G are two doors at the sides of the box; H, I, J are three flapped or hinged openings at the top of the box, H for the eye of the spectator, I to put in the models or figures, and J to admit light; KK is a transparent vertical plate of glass, forming a partition in the box; L, M are two compartments separated by this partition; N is an opaque screen, to shield a portion of the compartment L from the eye of the spectator. Now, with small figures or models, very curious optical effects can be presented in this box. Place two figures, Y and Z, in the two compartments, one in each. An eye at A will see the real figure Z, and the

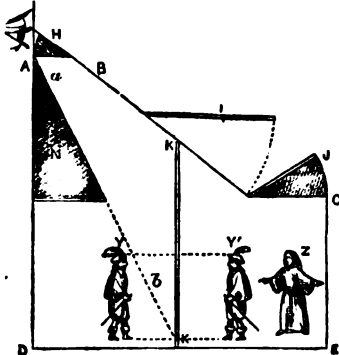

Fig. 2.—Vertical Section.

reflection Y' of the figure Y, but not Y itself; and both will appear to be in the same compartment. By opening in various degrees the flap J and the side-doors F and G, or by closing any one of the three, and opening the two others, the admission of light may be so regulated as greatly to modify the effects. In order that Y' may appear real, no solid body should be placed immediately before or behind it, or its transparency would at once be detected. If the apparatus were large enough for living performers, Z would not see Y', although he would see Y; but by a little rehearsal, Z and Y' might appear to act together. If, omitting Z, two figures exactly

alike, or two similar globes or cubes, were placed at Y and Y', then Y' would appear to a spectator like a substance and a phantom combined; and

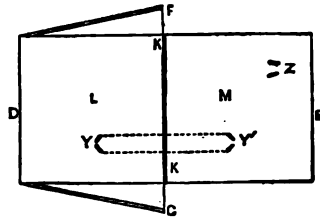

Fig. 3.—Ground-plan.

according to the mode of throwing the light more strongly on the one or the other, the substance might seem to dissolve away into the phantom, or the phantom into the substance. By supposing a small theatre or large room to be used instead of a box, living performers instead of model figures, and ranges of seats instead of an eye-hole, this apparatus would become a phantom exhibition for many spectators at once.

The exhibition of Messrs Dircks and Pepper, patented in 1863, gave celebrity and popularity to the subject, being shewn at the Polytechnic Institution, London. The main purpose, as described in the specification, is, 'to associate on the same stage living persons and phantoms to act together.' There is a stage like that of a theatre; and an under-stage at a level six feet or so lower, between it and the spectators. The stage can be seen by all the persons in the hall or theatre; but the under-stage (though nearer) is so managed, by means of screens, dimness of light, and dark baize lining, that its existence is scarcely even suspected by most of the spectators. There is a large plate of unsilvered glass nearly upright, between the under-stage and the stage, so artfully framed and adjusted as to be invisible, and allowing persons on the stage to be seen almost as clearly as if there were no glass there. An actor, whom we will call the hidden actor, is on the under-stage, entirely below the level of the real stage, and out of sight of the spectators. A strong light is thrown upon his face and figure, and is reflected from the front of the glass towards the spectators, who can thus see the reflected image, but not the hidden actor who produces it. For brevity's sake, we will call this reflected image the *phantom*. In order that the reflected light may come in a proper direction to the spectators, the glass is placed either upright or slightly leaning forward at the top, according to the height at which the seats of the spectators are placed. If the light is very strong on the hidden actor, and rather faint on the glass, the phantom appears with wonderful force and vividness. By means of a trap-door closing over the under-stage, the phantom may be made to disappear instantly; or by varying the intensity of the light, the phantom may seem to dissolve gradually. If the under-stage is too small for this, a small bust or model may take the place of the hidden actor; while, on the other hand, if the under-stage is very large, and all the arrangements planned on a complete scale, there may be a whole group of hidden actors and actresses carrying out the details of some story by being reflected into phantoms all at once, or one or two at a time; they may even dance and sing, making their phantom reflections appear to do the like. In all this, there is no mirror or silvered glass, nor is there any focussing lens. The visible actors on the visible stage may take up such positions

as to be near the phantoms, and combine with them to play a dramatic scene. By having a trap in the under-stage, up which a hidden actor may ascend, or one in the proper stage, up which a visible actor may ascend; by arranging the transparent sheet of glass in such a way that it may be varied in inclination, and either raised or lowered; and by throwing light of various colours on the hidden actors, the ghostly effects may be very strikingly diversified.

Most of the subsequent patents relate to extensions of this method, with certain minor additions. Munro's patent (1863) is concerned chiefly with placing between the lamps and the hidden actor screens and media of various kinds, so as to let light fall on some parts, and leave others in darkness. In this way a phantom may be shewn as if dismembered, head severed from the body, legs and arms separated, &c. By placing a movable mirror or silvered glass near the hidden actor, and shifting this while the action is going on, the phantom may be made to go up and down and across the transparent glass. By the aid of two or more mirrors, the phantom may be magnified or diminished in size. By other arrangements, the visible actor may seem to enter a solid cube, or may seem to give a bottle or a letter to the phantom—effects due, in fact, to the superposition of a reflected image upon an object seen by transmitted light. Maurice's patent (1865), instead of causing a hidden actor to be reflected as a phantom, makes the visible actor himself become a sort of phantom before the eyes of the spectators. The phantom of a hidden object is superposed upon the real form of the actor, by nice adjustment; and then, if the light is dimmed which falls upon the actor, and the light brightened which falls upon the hidden object, the former will appear to fade away into invisibility; or the arrangements may be so managed as to make him seem to go through a solid wall, or to be suspended in the air, or walking, or flying.

Without further describing particular arrangements, we may remark generally, that the most striking effects of these illusions are those which are due to the superposition of two pictures or scenes, one reflected from the glass screen, and the other seen through it. It is easy to see what room there is for the exercise of ingenuity in contriving combinations of effects. The details of dramatic scenes can be enacted by phantoms and real persons combined. Punch and Judy can be made to go through their vagaries and batter each other, one being a real figure, and the other a phantom; and it is not until Punch sinks through the solid floor that the spectator knows which was the phantom.

GIARRE, a town of Sicily, in the province of Catania, 42 miles south-west-by-south from Messina, on the slope of Mount Etna, and not much more than a mile from the sea. It is a rapidly increasing town. Many of its inhabitants are vine-growers and exporters of wine, the surrounding district being famous for its vineyards and the quality of their produce. Pop. above 18,000. The shipping port of G. is Riposto, about a mile distant; population 6530. It is a busy place, and many small craft are built. G. has a doubtful claim to be regarded as the ancient *Callipolis*. About five miles above the town, on the slope of Mount Etna, are the remains of the celebrated *Castagno de Cento Cavalli*, supposed to have been the greatest chestnut tree in the world. See CHESNUT.

GILL, JOHN, D.D., a Baptist minister, of some eminence as a theologian, and especially deserving of remembrance as one of the few English divines who have brought rabbinical learning to bear on the interpretation of Scripture, was born at Kettering,

Northamptonshire, November 23, 1697. His parents were in humble circumstances, but they placed him at the grammar-school at Kettering, from which, however, they were compelled to withdraw him before the completion of his course, on account of the enforcement of a rule requiring all the scholars to attend the parish church. He pursued his studies in private, and by his own unaided efforts, attained considerable proficiency in Latin, Greek, and Hebrew. He afterwards devoted himself much to the study of the rabbinical writers. Having begun to preach at an early age, he became, in 1719, pastor of a Baptist church at Horsleydown in Southwark; from which, in 1757, he removed to a new chapel in Carter-Lane, near London Bridge, and there continued to minister till his death, October 14, 1771. G. was a very voluminous author; many of his works were on controversial subjects, often of mere temporary interest, but he produced also some which are still studied or consulted by divines. His first important work was an *Exposition of the Song of Solomon* (fol. 1728), in which he vindicated the authenticity of that book against Whiston. His *Exposition of the New Testament* appeared in three folio vols. in 1746, 1747, and 1748; and his *Exposition of the Old Testament* subsequently at several dates in six folio vols. The complete work, a commentary on the whole Bible, has been since republished (9 vols. 4to, Lond. 1809—1810). G.'s other principal works are—*A Body of Doctrinal Divinity* (2 vols. 4to, Lond. 1769), and *A Body of Practical Divinity* (1 vol. 4to, Lond. 1770), which were afterwards republished together as one work (3 vols., Lond. 1795). He wrote also, as a controversialist, in defence of the doctrine of the Trinity and of Calvinism. He was a very high Calvinist. As a writer, he is extremely discursive and diffuse, by which the value of works full of thought and learning is much diminished. G. received the degree of D.D. from the Marischal College and University, Aberdeen, in 1748. He sent to Dr Kennicott a collection of quotations of the Old Testament in the Talmud, differing from the ordinarily received text, which Dr Kennicott made use of and acknowledged in his great work.

GILLS, or BRANCHLÆ, are the respiratory organs of those animals which obtain the oxygen necessary for their well-being not directly from the atmosphere, but from the air held in solution in the water in which they live. In animals modified for atmospheric respiration, the air enters the system to meet the blood, a peculiar set of movements, more or less complicated, being appointed for its constant renewal. In aquatic animals, on the other hand (excluding aquatic mammals), a different plan is required, in consequence of the small quantity of air contained in the water; and hence the aërating surface is extended outwardly, so as to yield a larger space than could be obtained in the interior. The blood is being perpetually driven along this surface, which is so constructed as to admit freely of the passage of air; and by the natural movements of the body, or by others of a special nature, a fresh supply of aërated water is constantly afforded. The chief forms of respiratory apparatus in different classes of animals are shewn in the accompanying diagram, borrowed from Dr Carpenter's *Comparative Physiology*. Let AB represent the general exterior surface of the body; then at *a* is shewn the character of a simple outward extension of it, forming a foliaceous gill, such as is seen in the lower Crustacea; and in like manner, *b* may represent a simple internal prolongation or reflection, such as that which forms the pulmonary sac of the air-breathing gasteropods. A higher form of branchial apparatus is shewn at *c*, the respiratory surface being extended

filaments, as we see in fishes; and a more elevated form of the pulmonary apparatus is seen at *d*, the membranous surface being extended by subdivision of the internal cavity, as in birds and mammals.

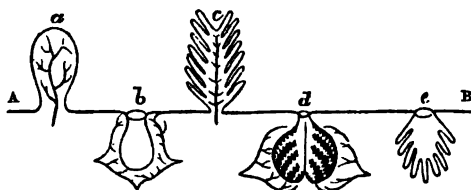

Fig. 1.

Lastly, at *e* is shewn a plan of one of the "pulmonary branchiæ" of the Arachnida, which forms a kind of transition between the two sets of organs—the extent of surface being given by gill-like plications of the membrane lining the interior of a pulmonic cavity.

We shall notice a few of the different forms of gills that occur in various classes. It is in the Annelida that we find the first distinct organs of this kind. Their blood is transmitted to a series of gill-tufts, which are composed of a delicate membrane prolonged from the extreme surface, and which may assume the form of branching trees or of delicate brushes made up of a bundle of separate filaments. These tufts are supplied freely with blood-vessels; and fresh portions of blood and of water are being constantly brought into contact by the natural movements both of the animal and the surrounding medium, and by the action of the cilia covering the respiratory organs. The tufts are sometimes attached at intervals along the whole length of the body, as in *Arenicola*, in which there are 13 pair (see ANNELIDA); while in other cases they occur about the head only. In the latter case, they are extremely beautiful, having the appearance of a flower endowed with the most brilliant tints. Two animals common in the aquarium, the *Serpula* and the *Terebella*, owe their resplendent beauty to these tufts (see figure under SERPULA). In all of the Crustacea, excepting some of the lowest forms, whose general surface is soft, gills are present. The *Branchiopoda*, belonging to the sessile-eyed Crustacea, or *Edriophthalma*, are so called because their fins or feet present the form of simple plates or flattened vesicles, which float in the surrounding fluid, and expose the blood to the oxygen which the water contains. The branchiæ may be appended to the thoracic limbs in the form of membranous plates (as in *Amphipoda*), or to the abdominal limbs as subdivided lamellæ (as in *Isopoda*), or the branchial plates may expand into vesicles attached to the thoracic feet (as in *Læmodipoda*). Amongst the Crustacea with eye-stalks, or *Podophthalma*, the respiratory organs, in the order *Stomapoda*, are external, and are appendages of distinct locomotive organs, each plate being divided into a series of small filaments or tubes, so as to resemble a broad feather. Their position is abdominal, as is seen in *Squilla*. Here the gills have begun to assume more of the character they present in fishes, the laminated or leaf-like form being replaced by one in which the surface is greatly extended by minute subdivisions into delicate filaments. In the order *Decapoda*, including the crab and lobster, the respiratory organs are of a more special character, and are lodged in branchial chambers protected by the carapace. A special apparatus is here found for the purpose of securing a constant current

in these animals are in the form of long, slender, quadrangular pyramids, and consist either of numerous thin plates or minute cylinders arranged perpendicular to the axis of the pyramid. There are 9 such branchial pyramids on each side in the crabs, while in the lobster there are 22. For further details on the respiratory organs of the Crustacea, the reader is referred to Professor Owen's *Lectures on the Comparative Anatomy and Physiology of the Invertebrate Animals*, 2d edit., 1855, pp. 320—322.

In the sub-kingdom Mollusca, we find several modifications of gills. In the *Lamellibranchiata*, or common bivalves, there are, as a general rule, two gills on each side. Here the gills are internal highly vascular folds of the mantle lining the valves, and are strengthened by delicate jointed filaments, which support several rows of vibratile cilia, whose constant motion gives rise to regular respiratory currents. This form of gill may be readily examined in the oyster or common mussel. In the *branchiferous gasteropoda*, the form and position of the gills are very variable. In the *Nudibranchiata* (see Alder and Hancock's splendid monograph on this order as occurring

in the British seas), they are disposed, as their name implies, without any protection, over various parts of the body, where they often form beautiful tufts of delicate leaf-like or arborecent appendages, as may be seen in *Doris* (q. v.). One of the arborecent processes forming the gills of *Doris Johnstoni* separated and magnified, is shewn in the accompanying fig. 2. The highest and most numerous subdivision of the branchiferous gasteropoda—the order *Pectinibranchiata*—derives its name from the peculiar comb-like arrangement of its gills, which have a special cavity at the fore part of the back, caused by an arching of the mantle. The gills of *Paludina vivipara* are shewn in fig. 3. Finally, in the highest class of mollusca—the *Cephalopoda*—the gills are the organs

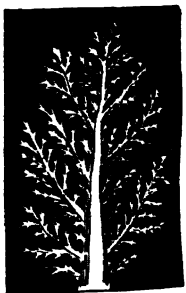

Fig. 2.—Gill-process of *Doris*, magnified.



Fig. 3.

The pectinated branchiæ alone are seen. The concave surface rests on the intestine.—The entire figure of *Paludina vivipara*, copied from Cuvier, is to be found in Carpenter's *Comparative Physiology*.

used for classification; there being two orders, viz., the *Tetrabranchiata*, with four gills, and the *Dibranchiata*, with two gills. The arrangement of these gills, and their relations to other organs, are seen in the accompanying figure of *Sepia* (fig. 4).

briefly noticed, but all details regarding them have been postponed to this article. The following

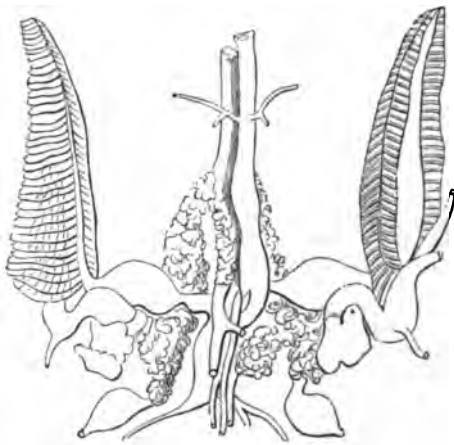

Fig. 4.—*Sepia officinalis*.

In the Dibranchiata, of which *Sepia* may be taken as an example, each gill consists of a number of triangular vascular laminae, extending transversely from either side of a fleshy glandular stem, and decreasing in size to the extremity of the gill. Each plate is composed of smaller transverse laminae, which are themselves similarly subdivided; the entire gill presenting the tripinnated structure, which affords an extensive though close-packed surface for the subdivision of blood-vessels. The number of plates in a gill varies in different genera; in *Sepia* there are thirty-six pairs. The stem of the gill is not only attached by its base, but by a thin membrane, through most of its length, to the mantle. The above description, and the figure, have been borrowed from Owen's *Lectures on the Comparative Anatomy and Physiology of the Invertebrate Animals*, 2d edition, p. 634. The original figure is due to Mr Spence Bata.

remarks on the gills of fishes are condensed from Professor Owen's *Anatomy of the Vertebrates*, vol. i. pp. 475—488. In the *Cyclostomi*, which, if we except the lancelet, constitute the lowest order of fishes, and include the genera *Myxine* and *Petromyzon*, of which the hag and lamprey are examples, the branchiæ or gills are saciform, with external spiracles, and six or seven in number on each side. Each gill-sac receives its proper artery either from the branchial artery or one of its branches. 'The leading condition of the gills in other fishes may be understood,' says Professor Owen, 'by supposing each compressed sac of a *Myxine* (*m* in figs. 5 and 7) to be split through its plane, and each half to be glued by its outer smooth side to an intermediate septum, which would then support the opposite halves of two distinct sacs, and expose their vascular mucous membrane to view. If the septum be attached by its entire margin, the condition of the



Fig. 5.—Two Gill-sacs of *Bdellostoma*.



Fig. 6.—Two Gill-sacs of Lamprey.

gill in the *Plagiostomi* (sharks, dog-fish, rays, skates, &c.) is effected. If the septum be liberated at the outer part of its circumference, and the

lamelligerous processes, tufts or filaments proceeding from the free arch, the gill of an ordinary osseous fish is formed. Such a gill is the homologue, not of a single gill-sac, but of the contiguous halves of two distinct gill-sacs, in the *Myxine*. Already, in the lampreys, the first stage of this bi-partition may be seen (fig. 6), and the next stage in the sharks and rays; consequently, in these fishes a different artery goes to the anterior branchial surface of each sac or fissure from that which supplies the posterior branchial surface of the same fissure; whilst one branchial artery is appropriated to each supporting septum or arch between the fissures, as it is to the liberated septum or branchial arch in the ordinary osseous fishes.—*Anatomy of Vertebrates*, vol. i. p. 476.

The lampreys, myxinoids, and plagiostomes (sharks and rays) are termed fishes with 'fixed gills,' because in them each supporting septum of the anterior and posterior branchial mucous surfaces is attached to the pharyngeal and dermal integument by its entire outer margin, and the streams of water flow out by the same number of fissures in the skin (as at *k*, in figs. 5 and 6) as those by which they enter from the pharynx, *f*. In the osseous and in the ganoid fishes there are 'free gills,' the outer border of the supporting branchial arch being unattached to the skin, and playing freely backwards and forwards, with its gill-surfaces, in a common gill-cavity, which has a single outlet, usually in the form of a vertical fissure.

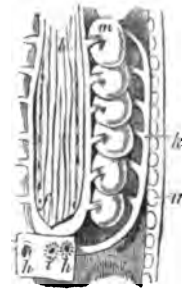

Fig. 7.—Branchial Organs of *Myxine*.

In the myxinoids (as the hag) there are (see fig. 7) six or seven branchial sacs, *m*, on either side, and their outlets are produced into short tubes, which open into a longitudinal canal, *k*, directed backwards, and discharging its contents by an orifice, *h*, near the middle line of the ventral surface; between the two outlets, *h*, *h*, is a third larger one, *i*, which communicates, by a short duct, with the end of the oesophagus, *l*, and admits the water, which passes from that tube by the lateral orifices, *f*, leading into the branchial sacs. These sacs, which are developed from the oesophagus, and which may be regarded as the simplest form of piscine gill, have a highly vascular, but not a ciliated, mucous membrane, which is arranged in radiating primary and secondary folds, so as to increase the surface. In the lampreys, there is a further separation of the respiratory from the digestive tract, for each internal blind duct communicates with a median canal, beneath and distinct from the oesophagus.

In all the higher fishes, the inlets to the branchial interspaces lie on each side of the fauces, and are equal in number with the interspaces; while, except in the plagiostomes, there is only one outlet on each side. These outlets vary extremely in size, being relatively largest in the herring and mackerel families, and smallest in the eels and lophioid fishes (as the Angler, q. v.). The length of time that different fishes can exist out of water depends on the modifications for retaining water in the branchial chambers. As a general rule, the chamber is largest when the outlet is smallest, as in the eels, blennies, and lophioids, and these are the fishes that survive the longest out of water, except in such cases as the Climbing Perch (q. v.) or *Anabas*, in which the branchial apparatus possesses complex labyrinthine appendages.

The main object of the gills of fishes being to expose the venous blood, in very thin-walled vessels, to streams of water, the branchial arteries rapidly subdivide into capillaries, which constitute a net-work in one layer, supported by an elastic plate, and

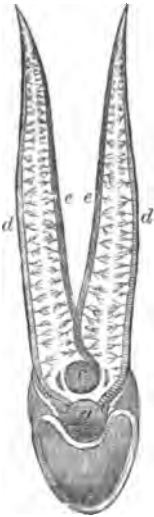

Fig. 8.—Diagram of the circulation of the Blood through the Branchial Leaflets.

covered by a tessellated but non-ciliated epithelium. This covering and the capillary wall are so thin as to admit free interchange to take place between the blood, loaded with carbonic acid, on the one hand, and the aerated water on the other. The extent of respiratory surface is increased in various ways, of which by far the most common is, 'by the production of the capillary-supporting plates from each side of long, compressed, slender, pointed processes, extending, like the teeth of a comb, but in a double row, from the convex side of each branchial arch.' In this figure, the course of the blood through a pair of branchial processes is shown: *a* is a section of the branchial artery; *d* is the branch going along the outer margin of the process; *e* is the vessel receiving the blood from the capillaries, after it has been changed, and returning it, along the inner border of the process, to the branchial vein, *c*. The number of vascular plates or lamellæ attached to each branchial process has been estimated at 135 in the carp, 700 in the eel, 1000 in the cod, 1400 in the salmon, and 1600 in the sturgeon.

From the above imperfect sketch of the beautiful structure of the ordinary type of gill in fishes, we pass on to the consideration of these organs in Amphibia or Batrachia. In the lower or perennibranchiate members of this order, the gills exist permanently, but in the great majority they are mere temporary organs. The subject is briefly noticed in the article *BATRACHIA*; but one or two additional observations may be made. In the newt (*Triton*), a little animal



Fig. 9.—Head and Branchial Appendages of the Larva of a Newt, magnified.

common in most parts of England, and readily kept in a vessel of fresh water, three pair of external gills are developed, at first as simple filaments, each with a capillary loop, but speedily expanding and giving off looplets. The gill is covered with ciliated

epithelium, which loses the cilia before the absorption of the organ, and this takes place after a few days of larval existence. In the larval frog, the gills, which are on a simpler plan, diminish about the 4th, and disappear on the 7th day. The parts of the branchial framework which supports the deciduous gills never get beyond the cartilaginous stage. They thus readily shrink, and become more internal as the head increases in size. As the gills of the perennibranchiate amphibians, in all essential points, resemble those already described, it is unnecessary to notice them.—The present article must be regarded as supplementary to *RESPIRATORY ORGANS AND PROCESS OF*, in which the comparative anatomy of the subject was altogether omitted.

**GIMIGNANO, SAN**, a very ancient town of Central Italy, in the province of Siena, and 22 miles south-south-west of Florence, is situated on the top of a hill 1220 feet above the sea. One of the most curious features of the town is the number, 14, of lofty square towers in so small a space, the largest of which is built on an arch under which passes a street, and was erected in 1298. Of the many churches and monasteries which the town once contained, most are in ruins. The principal of those still standing are the *Collegiata* or *Assunta*, which contains some fine old frescoes by various masters; the chapel of *St Fina*, with frescoes by D. Ghirlandajo; and the church of *St Augustin*, begun in the 13th, but not completed till the end of the 14th c., also containing frescoes. There has been of late years established in the suppressed monastery of San Domenico, a house of correction for convicted females, who are sent here from all parts of the surrounding country. Pop. 7425.

**GIOVANNI (SAN) IN FIORE**, a town of South Italy, in the province and 24 miles east of the town of Cosenza, is situated at the confluence of the Neto and Arvo, in the Sila Forest. Pop. 9200.

**GIOVANNI (SAN) ROTONDO**, a town of South Italy, in the province of Foggia, and 19 miles north-east of the town of that name, near Mount Gargana. There are manufactures of linen and woollen fabrics. Pop. 6900.

**GI'TSCHIN, or GICZIN**, a town of Bohemia, the capital of a district or circle, stands on the Cydlina, 48 miles north-east of Prague. It consists of the town proper and four suburbs, and has a population of about 6000. There are important corn-markets. The former Jesuits' college is now used as barracks; but there are a gymnasium and other schools. G. was once the capital of the duchy of Friedland. When Wallenstein chose it in 1637 for his residence, it was merely a collection of some 200 miserable hovels; his activity and munificence soon converted it into an elegant and prosperous city, in which he built (1630) a splendid palace. His body, in 1639, was laid in the neighbouring Carthusian monastery of Walditz; three years after the Swedish general Baner sent the head and right hand to Sweden; the remains lay neglected for a century, until they were removed by Count von Waldstein to Münchengrätz.

**GIUGLIA'NO**, a market-town of South Italy, eight miles north-west of Naples. It contains four churches, a castle, and a hospital. Pop. about 10,600.

**GLA'DBACH, or BERGISCH-GLADBACH**, a town of Rhenish Prussia, in the former duchy of Berg, and in the government of Cologne, eight miles north-east from Cologne. It is a place of considerable industrial activity, and has manufactures of nets, paper, and percussion caps. Pop. (1871) 6196.

**GLADBACH, or MÖNCHEN-GLADBACH**, a

town of Rhenish Prussia, in the government of Düsseldorf, 14 miles west from Düsseldorf, pleasantly situated on a rising ground near the left bank of the Niers. It is a principal seat of the manufacturing industry of Rhenish Prussia, and has increased very rapidly within the last twenty-five years. Besides being a station on the railway between Aix-la-Chapelle and Westphalia, it is connected by another line with Düsseldorf. Among the branches of manufacture carried on, are the weaving of linen and cotton, druggets and velvets. There are also extensive dye-works and bleachfields. Much flax is grown in the neighbourhood. G. is a very ancient town, having existed at least as early as the days of Charlemagne. It formerly contained a famous Benedictine abbey, founded by Archbishop Gers of Cologne, in 972. Pop. (1871) 26,326.

**GLADE-NET**, a kind of net used for the capture of birds in the glades of forests. It is much used both in England and in some parts of the continent of Europe for the capture of woodcocks. It is made of a breadth suitable to the glade in which it is to be suspended, through which the birds are known to be accustomed to pass; and is made of fine thread-netting, edged with cords, having weights attached to it below, so that when the rope by which it is held up is let go, it falls at once to the ground; a rope from the upper part of it passing over a pulley in a tree, and being held by the hand of the fowler. When the net is ready, the neighbouring parts of the wood are beaten, to disturb the woodcocks; and when they approach it, it is let down, or drawn up, as may be necessary. In England, the use of the glade-net is common chiefly among poachers and gamekeepers, who, without the knowledge of their employers, but tempted by the high price of woodcocks, resort to this method of obtaining money. Other birds and sometimes hares are also caught in the glade-net. In Siberia, the glade-net is employed for the capture of wild-fowl, and glades are opened, in order to its use, between one lake and another, or between a lake and a river near together.

**GLADOVA**, a town of European Turkey, principality of Servia, on the Danube, immediately below the 'Iron Gate' or rapids of that river, 110 miles east of Belgrade. The place is of little importance, except as being the chief quarters of the Danube Steam Navigation Company, its inhabitants conveying merchandise by land betwixt it and Orsova, about 13 miles further up the river. About 2½ miles below it are the remains of the bridge built by Trajan across the Danube.

**GLANDFORD BRIGG**, or **BRIGG**, a market-town of England, in the Parts of Lindsay, in the county of Lincoln, and 22 miles north-north-east of the city of Lincoln, on the navigable river Ancholme, which falls into the Humber about 10 miles from Glandford Brigg. It is a station on the Sheffield and Lincolnshire branch of the Great Northern Railway. The town is clean and regularly built, has a handsome modern church with a lofty spire, several other places of worship, a corn exchange, schools, &c. Its free grammar-school was founded in 1669. A considerable trade is carried on by means of the Ancholme, in corn, coal, and timber. The town relies mainly for its prosperity on the corn-market, which is one of the best in the county. The corn exchange is a large building, admirably adapted for the purpose for which it was erected. Formerly, a large business was done in the dressing of hare and rabbit skins for the use of hat manufacturers, but there was in 1867 only one establishment of the kind remaining. Pop. (1871) 2646.

**GLASS SNAKE** (*Ophisaurus*), a genus of reptiles, belonging to the group *Sauropsidia* of Gray, ranked by some naturalists among serpents, and by others among saurians. There is only one known species, a common native of the United States. It is serpent-like in form, and entirely destitute of limbs. The head is like that of a lizard. The eye has a movable lid, as in lizards. The length is sometimes three feet and a half. The body and tail are marked with transverse lines of black, green, and yellow, each scale exhibiting these three colours. The mouth is small, and the animal feeds on insects, molluscs, &c. It frequents dry places, and can neither climb nor swim. It is remarkable for the readiness with which the joints of the tail break off upon any irritation, so that it is very difficult to secure a perfect specimen. The joints thrown off are soon reproduced. The caudal muscles do not pass from one joint to another, so that the breaking of the tail involves no rupture of muscular fibres, but only a separation of one muscular plate from another.

**GLOSSOP**, a town of Derbyshire, England, 19 miles west-north-west from Sheffield, on a small river which falls into the Etherow, a branch of the Mersey. A branch railway, about a mile in length, connects it with the main line of the Manchester, Sheffield, and Lincolnshire Railway. It is situated in the midst of the beautiful scenery of the Peak, on a rising ground, above a deep valley, the Dinting Vale, over which the railway is carried by a viaduct of 16 arches. The suburb of Howard's Town exceeds the older town of G. in magnitude. G. is the chief seat of the cotton manufacture in Derbyshire. There are also woollen and paper mills, dye-works, print-fields, bleach-fields, and iron-foundries. The parish church of All-Saints' is an ancient edifice, recently enlarged and improved. Pop. (1871) 17,046.

**GMELI'NA**, a genus of trees of the natural order *Verbenaceæ*, having a small 4-5-toothed calyx, and a large, obliquely bell-shaped corolla. *G. arborea*, called **GOOMBAR**, or **KOOMBAR**, in India, is the most valuable for its timber. The tree attains a great size, and is widely diffused, both in Hindustan and the Eastern Peninsula. It has heart-shaped leaves and pannicled flowers. The wood resembles teak, but is closer in grain, and lighter. It bears exposure to water better than most kinds of timber. It is used for many purposes, as for foundations of buildings, decks of boats, Venetian blinds, picture-frames, &c.

**GMUNDEN**, a town of the Austrian Empire, in Upper Austria, 32 miles south-west from Linz. It is situated at the lower extremity of the Traunsee or Gmundensee, the Lake of Traun or Gmunden, where the river Traun issues from it, in the midst of scenery at once extremely grand and beautiful, and where a region of mountains, precipices, and gloomy pine-forests passes into one of gentle hills and rich cultivation. G. is a well-built town. It is connected by a branch-railway with the railway between Linz and Salzburg. The salt-mines of the vicinity give occupation to many of the inhabitants, and the town is a chief station of the salt-trade. Steam-boats ply upon the lake. Pop. (1869) 1408.

**GOHANUH**, a town of British India, in the district of Rohtuk, in the Punjab, 45 miles north-west of Delhi. It is situated on the Rohtuk branch of the Delhi Canal, and near the northern extremity of a great depression of the soil, extending about 50 miles southwards. Pop. 6668.

**GOLD—EXTRACTION BY SODIUM AMALGAMS.** Certain difficulties which attend the separation of gold by amalgamation—caused by the presence of other metals which frequently cover the gold with



a film of tarnish, and prevent the complete action of the mercury upon it—have led to the employment of sodium amalgamated with mercury in various proportions. This amalgam also restores the usefulness of mercury which has become *floured* or *sickened*. The compositions have been made the subjects of two patents, one by Dr Wurtz of New York in 1864, the other by Mr Crookes of London in 1865. Two kinds are now prepared in this country by Messrs Johnson, Matthey, and Co. of London, and are sent in large quantities to the various gold regions of the world, where their use is said to increase the yield of the precious metal by from 5 to 30 per cent. The separate compositions are known in commerce as Patent Amalgams, supplied in barrels of 2 to 5 cwt. each, or smaller quantities in tins or jars. These amalgams are of different compositions, the one containing 3, and the other (concentrated) 15 per cent. of sodium. Their prices are respectively 6s. 6d. and 8s. per lb. The average strength required for use with ordinary ores may be considered to be 10 lbs. of the three per cent. amalgam, to from 200 to 300 lbs. of mercury. The concentrated amalgam is used in the proportion of 10 lbs. to from 1000 to 1500 lbs. of mercury. When other metals besides sodium are used in these amalgams, they are generally zinc and tin. All amalgams containing sodium require to be preserved from damp in well-closed vessels.

GO'LDBERG, a town of Prussia, in the province of Silesia, and in the government of Liegnitz, 12 miles west-south-west from Liegnitz, on the Katzbach (q. v.), a branch of the Oder, famous in the history of the war of 1813. The town is situated on a rising ground, on the right bank of the stream. It is partly surrounded by walls, and protected by three forts. There are extensive manufactures of woollen cloths, hosiery, and gloves. Pop. (1871) 6716.

GONORRHOEA, described also as BLENNORRHOAGIA by some writers, is the most common form of venereal disease. It has been known from very remote times; it is generally believed that the sanitary measures inculcated in the 15th chapter of Leviticus have reference to this disorder as occurring amongst the Jews; and it was described by the Greek and Roman physicians. It consists in an inflammation of the mucous membrane of some part of the generative organs, producing a muco-purulent or purulent discharge from the diseased surface. Hence its name of gonorrhoea, which is formed on the erroneous supposition that the discharge consists of the spermatic fluid, is unsuitable, and the attempt to substitute blennorrhagia, which signifies 'a flow of mucous matter,' has been made. Although it is termed a venereal disease, it is totally distinct from Syphilis (q. v.). Although gonorrhoea is, in the great majority of cases, the result of direct contagion from sexual intercourse with a person who is similarly affected, there is no doubt that a very similar urethral discharge may arise from constitutional and other causes irrespective of contagion, as in scrofulous, gouty, or rheumatic subjects. Moreover, it is certain that this disease in the male may proceed from intercourse with a woman in whom no morbid change of the mucous membrane can be detected by the speculum. Ricord, a French physician of great authority in this department of medicine, lays down the proposition, that 'gonorrhoea often arises from intercourse with women who have not had the disease.' Diday, another high authority, maintains 'that from the very fact of a woman having a discharge, no matter what its origin, she is liable to give a discharge to a man.' English surgeons are gradually taking a similar

view, and admit that gonorrhoea may be the product of other causes than a specific poison. The fact of the disease being usually caused by impure intercourse is proof of the presence and action of the poison, but is no evidence of that poison being of a specific character; any poison capable of being generated by simple inflammation being probably sufficient to induce the disease.

Men are so much more liable to contract this disease than women, that we shall confine our remarks to gonorrhoea in the male. The symptoms usually appear in from three to five days after exposure to contagion. The patient feels an itching or tingling sensation at the extremity of the urethral passage, whose orifice has an abnormally florid appearance, and is usually closed by a viscid, colourless secretion. This premonitory stage may last for a day or two, when there is swelling of the parts, and a thick cream-like pus exudes from the urethra. The passage of the urine is accompanied by a smarting or scalding sensation, and takes place with considerable difficulty, in a contracted or twisted stream. At night, a painful condition of the parts, known as chordee, and due to spasm of the muscular fibres of the urethra, is apt to come on. This stage may last, with slight variations, for a space varying from one to three weeks, its length depending on the patient's mode of life, and the number of previous attacks, the first being always the worst, and each succeeding one being gradually milder. The disease having thus reached its height, gradually subsides; the various symptoms abate in severity, and after a period of uncertain length, the discharge either ceases or assumes an almost entirely mucous character. If it ceases, the patient may be regarded as cured; if the mucous discharge continue, it is known as *gleet*; and it is only to this condition that the term blennorrhagia is truly applicable. This gleet often remains, in defiance of all treatment, for months, and its presence often preys very unnecessarily upon the patient's mind, so as to derange his health, and to suggest unnecessary fears regarding the loss of his virile powers. It is from patients of this kind, who cannot be persuaded that the discharge is unaccompanied by any further mischief to themselves (further than possible annoyance arising from the fact that they should not marry so long as any discharge exists), and that it is sure in due time to cease, unless there is stricture or some other exciting cause, that advertising quacks draw their greatest profits.

There are considerable discrepancies of opinion amongst the highest medical authorities regarding the treatment of this disease. Various quack medicines, in the form of prophylactic washes, to be employed after exposure to possible contagion, are daily advertised in certain cheap and disreputable journals; but as Dr Druitt somewhat quaintly but very truly remarks: 'The only prophylactic to be relied on is chastity; next to this, soap and water, followed by an alum wash.' To these directions he might have added, that the urine should be discharged as soon as possible afterwards, so as to wash out the urethral passage. If the patient apply for advice on the first suspicion of the disease, before any acute inflammatory symptoms have set in, and if he can devote his whole time to his cure, he should keep a constantly recumbent position, should live on a farinaceous diet, avoiding meat, wine, and beer, and the abortive treatment should be tried. This consists in the injection into the urethra, every four or six hours, by means of a glass syringe, of a solution of two grains of nitrate of silver in eight ounces of distilled water. By about the second day, the discharge will begin to lessen, and the use of the injection must be stopped; and if any tinge of

blood has appeared in the discharge, the remedy must at once be discontinued. If the diminution extend in a few days to a total disappearance of the discharge, the patient is cured; if a slight discharge continue, a weak solution of sulphate of zinc (one grain to the ounce) may be injected two or three times daily for a few days. During this treatment, the bowels should be kept freely open by an antimonial saline mixture, and the patient should drink freely of barley-water, linseed-tea, and similar mucilaginous fluids. If this treatment be adopted at the very first, we can usually cut short, in a week, an affection that might possibly be troublesome for months; if it be tried after inflammation is fairly established, it is very apt to give rise to *stricture*. If a patient does not seek advice till the acute stage has set in, perfect rest in the recumbent position should be insisted on; but if, as is too often the case, the patient is unable to carry out this important regulation, all exercise must be avoided as far as possible, and the parts affected should be properly supported by a bandage, specially sold for that purpose, and termed a suspensory bandage. A very low, unstimulating diet must be insisted on, and all stimulating drinks strictly prohibited, while he should partake freely of mucilaginous diluents; and as a medicine, an alkaline saline diuretic should be prescribed, such as a combination of a scruple of acetate or bicarbonate of potash, half a drachm of tincture of henbane, and twenty minims of nitrous ether, with a little tartar emetic in urgent cases, administered in a small tumbler of water, containing a little gum in solution, or of barley-water, three times a day. As an outward local application, nothing is better or more soothing than water as hot as the patient can bear it. When, under these means, the scalding pain in micturition and the local swelling subside—but not till then—certain medicines which exert a special influence on inflamed mucous membranes—viz., copaiya and cubeb—should be administered. Copaiya may be administered in half-drachm doses three or four times daily; and after a few days, the dose may be increased, if necessary, to double that amount. Under no conditions can it be made an agreeable medicine. Some practitioners combine it into an emulsion with yolk of egg, liquor potasse, or gum-arabic; others recommend that it should be taken floating on a wine-glassful of water to which a little tincture of orange-peel has been added. If the gelatine capsules of copaiya can be depended on as being genuine, they afford an easy mode of taking this medicine. In whatever form it is taken, it is liable to produce an eruption of the skin, consisting of small red patches somewhat resembling nettle-rash. Although the rash is perfectly harmless, and speedily disappears on the discontinuance of the medicine, and the administration of one or two saline purgatives, it often causes great alarm to a patient who has not been duly warned of its possible occurrence. Cubeb is a less unpleasant medicine than copaiya. To be of service, at least a drachm of the powder should be taken three times a day suspended in milk. A confection formed by mixing powdered cubeb with balsam of copaiya, which may be swallowed as a bolus with an envelope of moistened rice-paper, is an efficacious form of prescribing these medicines. In the third stage, when the urgent symptoms are abating, the patient should continue the use of copaiya and cubeb, and should begin to use injections, commencing with one composed of a scruple of bismuth and half a grain of acetate of morphia in an ounce of water containing sufficient mucilage to keep the bismuth in suspension, to be used thrice daily. After a few days, it may be replaced by one of sulphate of zinc (one grain to an ounce of water), which may be

increased in strength if necessary. If a gleet remains, it must be treated with tonic medicine, especially tincture of iron, exercise in the open air, sea-bathing, good diet, &c.; and the under-side of the urethra may be painted with tincture of iodine, or in very obstinate cases, treated with a slip of blistering tissue. A well-marked case of gonorrhoea, when left entirely to itself, rarely runs a shorter course than from three to four months. Various forms and complications of gonorrhoea occur, into which it is unnecessary for us to enter in this work.

As has been mentioned in the article OPHTHALMIA, the purulent discharge of gonorrhoea, if brought in contact with the conjunctiva, may occasion destructive disease of the eye. There is also a troublesome affection, accompanied by pain, swelling, and tenderness of the joints, with feverishness, which is apt to supervene towards the decline of the discharge, which is known as *gonorrhoeal rheumatism*.

From what has been stated regarding the so-called *abortive* treatment, it is obvious that, by applying for medical aid on the earliest suspicion of contagion, the patient may save himself from a long and troublesome disease, which, if neglected or badly treated, may give rise to a serious local affection—namely, stricture of the urethra. As patients with diseases of these organs are apt to entertain remarkable and altogether erroneous views as to their constitutions being irretrievably ruined, and to the possible outbreak of secondary and tertiary symptoms, it is the duty of the practitioner always to impress upon them that, as a general rule, gonorrhoea is merely a local affection, and cannot give rise to any subsequent constitutional symptoms.

GOODSIR, JOHN, Professor of Anatomy in the university of Edinburgh from 1846 to 1867, was born in 1814, at Anstruther, Fifeshire, in which county his father and grandfather had, for many years, practised the profession of medicine with great repute. Very early in life, his studious habits and thoughtful disposition attracted attention, and when little more than a boy, he was sent to the university of St Andrews, where he passed through a four years' course of literary and philosophic study. He was afterwards apprenticed to Mr Nasmyth, dentist in Edinburgh, and during his apprenticeship, attended the medical classes both in the university and extra-mural school in that city. He studied anatomy under Dr Knox, and natural history under Professor Jameson, and was the intimate friend of Edward Forbes, George Wilson, Samuel Brown, and other young men, who have since made for themselves names as ardent students of the natural sciences.

The position of his native town on the sea-coast had very early caused his attention to be directed to marine zoology, and along with his younger brother, Harry, who was afterwards lost in the unfortunate Franklin Expedition, he had begun to dissect marine animals, and study their forms and structure, before he commenced his medical studies. His training as a dentist led him to undertake an investigation into the Development and Structure of the Teeth, which he afterwards published in an elaborate memoir, and in which he gave the first consistent account of the various stages through which these important organs pass. This Essay, published in 1839, at once caused him to be recognized as an observer of great originality and acuteness. On obtaining his diploma at the College of Surgeons, in Edinburgh, he returned to Anstruther, to assist his father in practice; and though actively engaged for some years in the arduous duties of a country doctor, he yet found time, not only to pursue numerous important pathological investigations, but to continue and extend his studies in anatomy and natural history. He formed at the same time an Anatomical Museum,

characterised by the great beauty of the preparations, which was afterwards acquired by the government for the use of the Queen's College, Cork.

He returned to Edinburgh about 1840; and on the conservatorship of the Museum of the Royal College of Surgeons becoming vacant, he applied for, and obtained, the office. Having now acquired a more extensive field for pathological research, he devoted much attention to the structure and mode of growth of tumours, and other products of disease; and in 1842—1843, delivered courses of lectures on the diseases of bone, cartilage, and of the various changes which take place in inflammation of these and other important organs. The improvements in the construction of the compound microscope, about this period, furnished him with a most valuable instrument for conducting his inquiries into the more recondite structural phenomena, which constitute the fundamental nature of the changes from a healthy to a diseased condition of tissues and organs. At the same time, he also investigated the minute structure of the healthy tissues, more especially with reference to the mode in which they performed their functions. He was one of the first observers who strongly insisted on the general diffusion, throughout the animal textures, of the minute bodies called *nuclei*; and he pointed out their importance in connection with the processes of growth, secretion, and nutrition. His Memoir on Secreting Structures, published in 1842, in the *Transactions of the Royal Society of Edinburgh*, shewed, in a most conclusive manner, the influence exercised by the cells within a gland on the secretion formed in its interior. In the same year, he published a description of a case, in which a very remarkable vegetable organism, now known as the *Sarcina ventriculi* (see *SARCINA*), was periodically discharged in the fluid ejected from the stomach during vomiting. In the following year, he communicated to the Royal Society of Edinburgh an account of the structure of the Human Placenta, which is regarded as a most important contribution to the anatomy of that complex organ. Many of his physiological and pathological essays were afterwards incorporated in a special volume, published in 1845, and the facts which they contain have contributed very materially to establish the important modern pathological doctrine of the origin of morbid products from changes in the pre-existing elements of the tissues of the body.

His studies in comparative anatomy and natural history were not, however, neglected during this period. He was an active member of the Wernerian Society, and, along with his friend, Edward Forbes, communicated both to it and other scientific bodies several papers on the Anatomy of Animals, new to science, which they had discovered. His papers on *Pelonia*, *Thalassema*, and *Amphioxus* attracted especial attention.

In 1844, he was appointed assistant to Dr. Monro, Professor of Anatomy in the university of Edinburgh. His enthusiasm and devotion to anatomical work rapidly gathered around him a large class of students, and on the resignation of Dr. Monro in 1846, he was appointed by the town-council to the Chair of Anatomy. His reputation as an anatomical teacher now became materially extended, numerous students were attracted to his class, and for many years the attendance each winter-session amounted to between 300 and 400. His great success as a teacher was due, not so much, perhaps, to any special aptitude for public speaking, but to the earnest and painstaking way in which he brought his subject before his students; to his thorough knowledge of anatomy, not only in its minute details, but in its relations to physiological and pathological processes; and to the influence exercised by his manly and straightforward

character. He devoted much of the time not occupied in the duties of his class to the extension of the Anatomical Museum of the university, and dissected and prepared a large number of specimens to illustrate the modifications, in form and structure, of the organs met with in the dissection of different kinds of animals. His preparations of the echinodermata, mollusca, and cetacea are especially worthy of notice.

He had a keen sense of the beauty and symmetry of organic forms, and his philosophic mind early led him to undertake an investigation into the constitution of the skeleton in the vertebrata, the general results of which he communicated, in the year 1856, to the British Association for the Advancement of Science.

His devotion to work, and his unremitting attention to the duties of his chair, at length began to tell on his robust frame; and for some years before his death, signs of failing health were visible. Early in 1867, he was obliged to withdraw from all active work; and he died at South Cottage, Wardie (near Edinburgh), March 6, in that year.

G.'s intellect was eminently comprehensive. He was not a mere technical anatomist, but studied his science in its relations to morphology, teleology, and pathology. In his philosophic grasp of principles, in the extent of his acquirements, and in his devotion to his science, he was a worthy disciple of his great compatriot, John Hunter. For a full account of his life, &c., see *Anatomical Memoirs of John Goodair*, published under the editorship of his successor in the chair of anatomy, Professor Turner (Longmans, 1865).

GOODYEAR, CHARLES, American inventor, was born at New Haven, Connecticut, December 29, 1800, the son of an iron-manufacturer, with whom, at the age of 21, he went into business in Philadelphia. Failing in the iron trade, his attention was attracted to the manufacture of india-rubber, and he expended all his means, and reduced his family to utter destitution, in experiments with various mixtures and processes, the most successful of which were with magnesia, lime, and nitric acid, to make it available for waterproof shoes, clothing, &c. His efforts were a series of failures, excepting a partial success in treating the surface of rubber goods with nitric acid, until he bought of one Hayward, a rival experimenter, an invention for mixing india-rubber with sulphur. The great secret of vulcanisation, in which the two substances, submitted to a high temperature, are converted into the elastic, enduring, and heat and cold defying fabrics now in use, was an accidental discovery made while standing by a stove, and idly subjecting a mixture of rubber and sulphur to its heat. This new product he patiently perfected, discovering new uses to which it could be applied, until it required sixty patents to secure his inventions. Some of these rights were secured by other persons in England, and in France they were forfeited by an informality; so that, by these means, and from expensive law-suits, he gathered little from ten years of toil and privations save the honours awarded to his skill and perseverance in giving to the world a staple now applied in different countries to 500 uses, and employing 60,000 workmen in its manufacture. He died in 1860.

GOOLAIREE or GOMUL PASS, an important pass in the north-west of India, across the Salmaan range from the Derajat into Cabul. It enters the mountains at their eastern base, in lat. 32° 6' N., and long. 70° E. It holds its course, which is very winding, by broken rugged roads, or rather the watercourses of the Gomul, through the wild and mountainous country of the Muzaree. It is of great importance, being the middle route from

Hindustan to Afghanistan, as the Khyber is the northern, and the Bolan the southern. Immense caravans, consisting principally of Lohani Afghans, every spring traverse it westward from the Indus and the adjacent countries, and returning in the autumn, winter in the Derajat. It is much infested by freebooters of the Vaziri Afghan tribe, and the caravans have often to fight their way with much loss of life and property.

**GORICA**, a town of the Austrian Empire, in Croatia, 10 miles south-south-east from Agram, in the valley of the Sava. Pop. 7902.

**GOSSELIES**, a town of Belgium, in the province of Hainaut, four miles north-by-west from Charleroi, and on the canal from Charleroi to Brussels. It has manufactures of woollen cloth, hats, nails, cutlery, soap, &c.; also bleach-fields and tanneries. There are coal-mines in the vicinity. Pop. (1870) about 7000.

**GOUGH, JOHN B.**, American temperance lecturer, was born at Sandgate, Kent, England, August 22, 1817; his father, a pensioner of the Peninsular War; and his mother, a village schoolmistress. At the age of 12, he went to America as an apprentice, and worked on a farm in Oneida county, New York. In 1831, he went to New York City, where he found employment in the binding department of the Methodist book establishment; but habits of dissipation lost him this employment, and reduced him to that of giving recitations and singing comic songs at low grog-shops. He was married in 1839; but his drunken habits reduced him to poverty and delirium tremens, and probably caused the death of his wife and child. A benevolent Quaker induced him to take the pledge; and he attended temperance meetings and related his experience with such effect as to influence many others. In 1842, he had a short relapse into drunkenness; but an eloquent confession restored him to favour, and he lectured in various parts of America with great success. In 1853, he was engaged by the London Temperance League to lecture two years in the United Kingdom, where he drew large crowds by his earnest, and by turns amusing and pathetic orations. An Autobiography, giving the details of his experience, and a volume of his Addresses, have had a wide circulation.

**GOUNOD, FELIX CHARLES**, an eminent French operatic composer. He was born in Paris in 1818, studied at the Conservatoire there under Halévy, and also under Lesueur and Pauer. Obtaining the first prize of the Institute in 1839, he was sent to Rome to complete his musical education; and while there, devoted himself chiefly to religious music. On his return to Paris, he was for a time attached to the church of the Missions Etrangères, where his earliest compositions were performed; one of them, a *Messe Solennelle*, was the first work which brought him into general notice. For a time, he contemplated taking orders, and went through part of the preliminary novitiate. His first opera, *Sapho*, was produced in 1851; in 1852, he wrote choruses for Ponsard's drama of *Ulysse*; and in 1854 appeared his opera of *La Nonne Sanglante*. His comic opera, *Le Médecin malgré lui*, produced in 1858, was a great success; it was followed in 1859 by *Faust*, which at once attained a widespread European popularity, and raised its composer to the foremost rank of contemporary musicians. *Phlémon et Baucis* followed in 1860; in 1862, *La Reine de Saba* (brought out afterwards in England as *Irene*), and *La Colombe*; in 1861, *Mireille*; and in 1867, *Romeo and Juliet*. The oratorio of *Tobias*, written in 1864, was first performed in London in 1866. In G.'s compositions are to be found deep musical science,

a profusion of new and original combinations, and an almost unequalled command of the resources of the orchestra. There is great dramatic power in his operas, and one of their marked features is the prominence given to declamation over melody.

**GRÄFRATH**, a town of Rhenish Prussia, in the government of Düsseldorf, and 12 miles east-by-south from Düsseldorf, on the Itter. It has manufactures of cotton goods, silk ribbons, and iron-ware; and has recently much increased in manufacturing industry, wealth, and population. Pop. (1871) 5420.

**GRAND-COMBE, LA**, a town of France, in the dep. of Gard, 35 miles north-west of Nîmes, with which it is connected by railway. Near it are some very important collieries, which supply the French steam-navy at Toulon. In the town are oil-mills and glass-works. Pop. (1872) 4720.

**GRANIER DE CASSAGNAC, BERNARD ADOLPHE**, a name well known among Parisian journalists, and not unknown in the Palais de Justice, was born at Aviron-Bergelle (dep. Gers), in 1808. He was educated at the college of Toulouse, and contributed for a short time to the southern press, but soon quitted the provinces for Paris, where Victor Hugo introduced him to the *Journal des Débats*, and *Revue de Paris*. Here his vehement style did not give satisfaction, and he was engaged by M. Girardin to write literary criticisms for *La Presse*. In 1840, he sailed for the Antilles, in hopes of political advancement, ingratiated himself with the planters, although he narrowly escaped being murdered by the blacks, married a Creole lady, Mademoiselle Beauvallon, and returned to Paris as deputy for Guadeloupe. Not being able to arrange a satisfactory engagement with *La Presse*, he founded the *Globe*, ultra-Orleanist, and violent to such a degree that the opposition journals agreed to ignore it (*la conspiration du silence*, as it was called). The *Globe* failed; and in 1845 G. de C. started *L'Epoque*, also violent, and also a failure. It was merged in the *Presse*, not, however, before its editor had been openly accused in the Chamber of Deputies of selling his influence with the government. Shortly before the Revolution, he was employed by M. Guizot to set up a ministerial paper at Rome. In 1848, he returned to France, and after a while reappeared in Paris, as an ardent supporter of the Prince President, and a bitter foe to his old patrons, the House of Orleans. He edited the *Pouvoir* (1850), and wrote for the *Constitutionnel* with an excess of zeal and a pretence of exclusive information which led to an *avertissement*. In 1852, he was elected as the government candidate for Mirande (Gers), for which he was re-elected in 1857 and 1863. In the Chamber, he spoke in favour of the Army Dotation Bill, advocated direct taxation on all descriptions of funded property, additional protection for the interests of literature, and the formation of a local railway in his department. On the 23d of May 1857, he was made Grand Officer of the Legion of Honour, and in the same year founded *Le Réveil*, a weekly religious organ, which died the next year. He afterwards became principal editor of the semi-official *Pays*, and in 1863 was manager of the *Nation*. In 1870, on the fall of the empire, he retired to Brussels; in 1876 he was selected a member of the National Assembly. The appearances of G. de C. before the courts of justice have been very numerous. In 1842, he was tried for a duel with M. Lacrosse, of whose father he had written disrespectfully, and whom he lamed for life. In 1845, he prosecuted M. Hilbey for libel in his pamphlet on the *Venality of the Press*. In 1847, he was mixed up in the duel in which his brother-in-law, Beauvallon, killed Dujarrier of *La Presse*, and about

which strange things were said. He was also sued by Delasalle for a debt which he declared he had paid. M. Delasalle gained his cause. In 1855, his publisher proceeded against him for non-delivery of a MS. on the Eastern War. The duel between Paul de C. of the *Pays* and a writer in the *Soleil* (in which G. de C. seconded his son), and the unseemly quarrel between the Cassagnacs and M. Vermoul of the *Courrier Français*, were matters of great notoriety. His most important works are: *A Voyage to the Antilles* (1844); *The Queen of the Prairies*, a romance (1845); *The Causes of the French Revolution of 1789* (1850); *The History of the Directory*, a reprint from the *Constitutionnel* (1851—1856); *The Fall of Louis Philippe* (1857); *The Girondins and the Massacres of September* (1860), &c. All his writings are remarkable for vigour of style, but the thorough-going partisanship of the author greatly impairs their historical value.

GRANMICHELE, a town of Sicily, in the province of Catania, and 30 miles south-west from Catania, on a mountain ridge, at an elevation of 1768 feet above the sea. Beautiful marbles are produced in the neighbourhood. The town was founded in the end of the 17th c. by the Branciforte family, and peopled with the inhabitants of the neighbouring town of Occhialà, which was destroyed by the earthquake of 1693. Pop. 10,058.

GRANT, FRANCIS, LORD CULLEN, a Scottish judge and political writer, was the son of Archibald Grant of Belinton, a cadet of the family of Grant of Grant, chief of the clan of that name. He was born about the year 1660, was educated first at Aberdeen, and afterwards at Leyden, adopted the profession of the law, and distinguished himself by his loyal zeal for the successive governments of William III., Queen Anne, and George I. He wrote in favour of the Union, on the Observance of the Sabbath, on the Law of Patronage in the Church, essays on Law, Religion, and Education, and Reflections on the Rebellion of 1715. For seventeen years, he filled the position of a judge with great ability and integrity. He died at Edinburgh in 1726.

GRANT, PATRICK, LORD ELCHIES, a Scottish judge, was born in 1690. He collected the Decisions of the Court of Session from 1733 to 1757, and wrote annotations on Lord Stair's Institutes. He was celebrated as an acute and learned lawyer. He died in 1763.—His son, JOHN GRANT, became one of the Barons of Exchequer in Scotland.

GRANT, JAMES, of Corrimony, in Inverness-shire, born in 1743, died in 1835, was author of *Essays on the Origin of Society*, 1785, and *Thoughts on the Origin and Descent of the Gael*, 1814. The latter is a learned and ingenious work, imbued with Celtic feeling and enthusiasm.

GRANT, MRS, of Carron, author of the popular song of *Roy's Wife of Aivalloch*, was born near Aberlour, in Banffshire, about the year 1745. She was twice married—first to her cousin, Mr Grant of Carron, near Elchies, on the river Spey; and secondly, to Dr Murray, a physician in Bath. She died at Bath about 1814.

GRANT, SIR WILLIAM, an eminent lawyer, was descended from the Grants of Baldornie, and was born at Elchies, in Strathspey, in 1754. He was some time Attorney-general in Canada, then M.P. for Shaftesbury, and subsequently for Banffshire; was sixteen years Master of the Rolls, from which he retired in 1817, and died in 1832. Lord Brougham describes him as the greatest magistrate that ever adorned the English bench; and Charles James Fox declared that he was the only man in the House of Commons whom he had any diffidence in replying

to. This arose from the fact, that Grant was a most logical debater and close reasoner.

GRANT, MRS ANNE, a miscellaneous writer, whose works were among the first to draw public attention to the romantic scenery and peculiar manners of the Scottish Highlands, was born in Glasgow in 1755. She was the daughter of a British officer named M'Vicar, who became barrack-master of Fort-Augustus. She married the Rev. James Grant, chaplain of the fort, and subsequently minister of Laggan. Left a widow in destitute circumstances, Mrs G. published by subscription a volume of *Poems* (1803), which were well received; in 1806, *Letters from the Mountains*—a highly popular work; in 1808, *Memoirs of an American Lady*; in 1811, *Essays on the Superstitions of the Highlanders of Scotland*; &c. In 1825, Mrs G. received from government a pension of £100 a year. She died in 1838.

GRANT, CHARLES, LORD GLENELG, was born in India, at Kidderpore, presidency of Bengal, in 1779. He was of a Highland family, the Grants of Shewglie. His grandfather (who was slain at the battle of Culloden) married one of the Macbeans of Kinchyle; and his father was born in Aldourie House, on the banks of Loch Ness, also the birthplace of Sir James Mackintosh. The father of Lord Glenelg (also Charles Grant) went early to India, became one of the most distinguished directors of the East India Company, represented for many years the county of Inverness in parliament, and was, along with Wilberforce, Thornton, Zachary Macaulay, and others, a leading member of the Clapham sect, described by Sir James Stephen in his *Ecclesiastical Essays*. He died in 1823, aged 77. Charles, his eldest son, was carefully educated, and distinguished himself at Magdalene College, Cambridge, where he took his degree of M.A. in 1804. In 1805, he published a poem on the *Restoration of Learning in the East*, which had carried the university prize awarded by Dr Claudius Buchanan. He was called to the bar in 1807, but never practised. In 1811, he was elected M.P. for the Inverness district of burghs; and afterwards succeeding his father in the county representation, he continued in the House of Commons for a period of 25 years, at the expiry of which he was raised to the peerage by letters-patent bearing date May 8, 1835. G. held for five years the office of a Lord of the Treasury; and in 1819, succeeded to the important appointment of Secretary for Ireland, which he continued to fill for about two years. He was the first Secretary for Ireland that sought to carry out conciliatory measures. He endeavoured to suppress the Orange demonstrations, to secure the impartial administration of justice, and to devise a system of national education adapted for Catholics as well as Protestants. Nearly all that has since been done was proposed by this enlightened statesman, and the future historians of Ireland will point to him as one of the genuine though ill-requited benefactors of that country. From 1823 to 1827, G. was Vice-president of the Board of Trade; from 1830 to 1834, President of the Board of Control; and from November 1834 to February 1839, Secretary of State for the Colonies. After this period, G. withdrew in a great measure from public affairs, but supported the Liberal party by his vote. He died at Cannes, in France, in 1866. Lord Brougham pronounced G. to be 'the purest statesman he had ever known.' He was an eloquent speaker, though partly from diffidence, and partly from indolence, he spoke but seldom. Some of his despatches as Colonial Secretary, on the rights of the natives in the colonies, on repressing idolatry, and abolishing slavery throughout the British



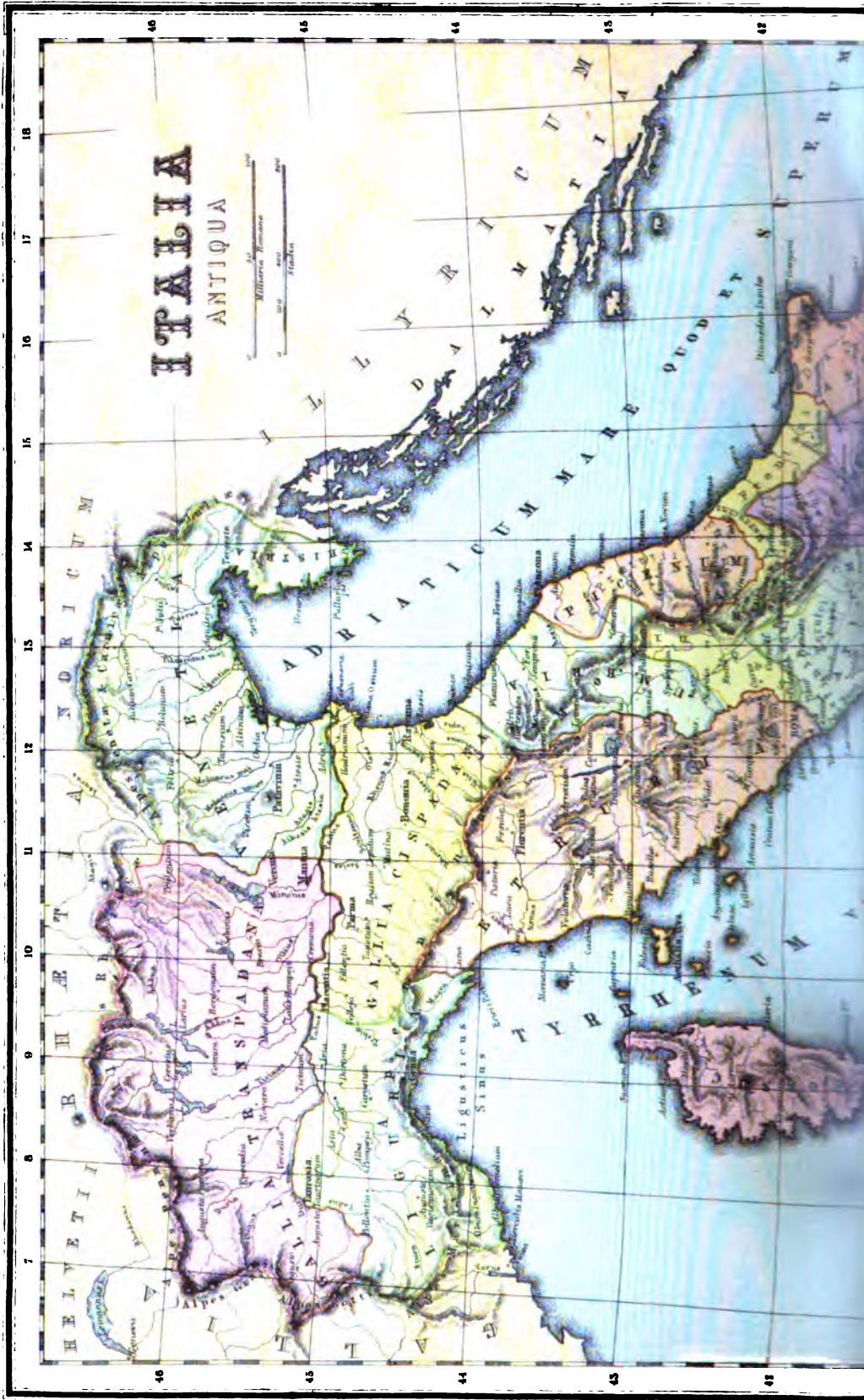



W & A Johnston Edinburgh

W & R CHAMBERS LONDON & EDINBURGH





possessions in South Africa, are models of elevated and just thought, and of fine impressive English.

GRANT, SIR ROBERT, governor of Bombay, brother of Lord Glenelg, was born in 1785. In 1801, the brothers took their degree of B.A. together in Cambridge, Charles being third, and Robert fourth wrangler, with the additional distinction of Charles being first, and Robert second medallist. The latter was called to the bar at Lincoln's Inn in 1807, sat for some time in the House of Commons as member for Inverness, and afterwards for Norwich and for Finsbury. In 1834, he was knighted, and appointed governor of Bombay. He died at Dapoorie in 1838. He was author of two treatises on Indian Affairs, and of several hymns and short poetical pieces, greatly admired, which were collected and published by Lord Glenelg in 1839.

GRANT, SIR FRANCIS, fourth son of Francis Grant of Kilgraston in Perthshire, was born in Edinburgh, 1803. He received his education at Harrow and at the university of Edinburgh, and was, it is said, originally intended for the Scottish bar, but soon abandoned all thoughts of legal honours, to follow his natural genius for painting. He studied drawing under Somerville, a local artist of some repute, and was enabled, by the kindness of Lord Elgin, to form his taste in that nobleman's gallery. A noble portrait by Velasquez is said to have exercised an especial influence over the young painter's future art-career. His first picture was exhibited in 1834, when he at once took rank among the best portrait-painters of the day, and was regarded as a worthy successor of the courtly Lawrence. His most famous works are those in which he has combined the likenesses of distinguished characters with scenes of English sport. The 'Meet of H.M. Stag-hounds,' painted in 1837 for Lord Chesterfield, and containing no less than 46 portraits; the 'Melton Hunt,' executed for the Duke of Wellington; and the 'Cottesmore,' for Sir R. Sutton, are the best known in this class. Among his other paintings, may be mentioned the equestrian portraits of the Queen and Prince Consort for Christ's Hospital; the picture of the beautiful Marchioness of Waterford; and those of Lords Palmerston, Russell, Gough, Macaulay, Hardinge, &c. In 1842, Mr G. was elected Associate, and in 1851, Academician. In 1855, he received one of the three gold medals awarded to British artists at the Paris Exhibition (for his 'Meet of H.M. Stag-hounds'), and was also elected Member of the Belgian Academy. In 1866, the President's chair in the Royal Academy having become vacant, through the death of Sir C. Eastlake, and neither Sir E. Landseer nor Maclise being desirous of the post, Mr G. was elected in February by 23 votes out of 29, and soon after received, according to ancient precedent, the honour of knighthood. In 1870, he received the degree of D.C.L. from Oxford. Sir Francis has been twice married. His first wife was a Miss Farquharson of Invercauld; his second, Isabella, daughter of Mr and Lady Elizabeth Norman, by whom he has a numerous family.

GRANT, ULYSSES SIMPSON, eighteenth president of the United States, was born at Point Pleasant, Clermont County; Ohio, April 27, 1822; graduated at the military academy of West Point in 1843, and served under General Taylor in the war with Mexico, 1846, up to the capture of Monterey. His regiment was then transferred to the expedition under General Scott, and he took part in every action from Vera Cruz to Mexico, and was brevetted first-lieutenant and captain for meritorious conduct at Molino del Rey and Chapultepec. In 1852, he served in Oregon; but, in 1854,

resigned his commission, and settled at St Louis, Missouri, whence, in 1859, he moved to Galena, Illinois, and engaged in the leather trade. At the beginning of the War of Secession in 1861, he volunteered his services, and was appointed colonel of an Illinois regiment. In August he was appointed brigadier-general, commanding the important post of Cairo, occupied Paducah, and led an expedition on the Mississippi. In February 1862, he distinguished himself in the capture of Fort Donelson, on the Tennessee River, and was made major-general. On the 6th of April following, after a preliminary defeat, he won a great battle over the Confederates at Pittsburg Landing, or Shiloh. Succeeding General Halleck in the west, he commanded the land-forces which, in conjunction with the navy, reduced Vicksburg, July 4, 1863, soon followed by the fall of Fort Hudson, and the opening of the Mississippi. He then took command of the army of Tennessee, and defeated General Bragg at Chickamauga, in September of the same year; and was, in 1864, appointed lieutenant-general and commander-in-chief, and personally directed the operations of the great final struggle in Virginia, in which the northern forces, though often repulsed with heavy losses, finally compelled the evacuation of Richmond, April 2, 1865, followed on the 9th by the surrender of the Confederate army under General Lee, and soon after of the entire Confederate forces. Congress, in recognition of his eminent services, passed an act reviving the grade of 'General of the Army of the United States,' to which G. was immediately appointed. In 1868, he was elected, on the 'republican' platform, president of the United States; and having, in 1872, been re-elected over a notable opponent, the late Horace Greeley of the *New York Tribune*, he retired in 1877 after his second term of office. In the latter year G. visited Europe, and in England and France received an enthusiastic welcome. Simple, reticent, earnest, and persevering in his character, he owed his military success not so much to strategy as to superior numbers and resources, and hard fighting, in which even a series of victories left his enemy less able to resist. During G.'s presidency a great reduction was made upon the national debt incurred during the civil war. The military government of the southern states in those years cannot be regarded as successful. The most important event connected with relations to foreign states was the settlement of the Alabama question by the 'joint high commission' in 1871.

GRAPE-HYACINTH (*Muscari*), a genus of bulbous-rooted plants, of the natural order *Liliaceae*, nearly allied to the hyacinths, but differing in the globose or subcylindrical perianth, contracted at the mouth, and 6-toothed. The species are natives chiefly of the countries near the Mediterranean, and the warmer temperate parts of Asia. Some of them are frequent in our flower-borders. *M. moschatum* has a smell of musk. *M. racemosum* is a somewhat doubtful native of the south of England. The flowers of the grape-hyacinths are mostly blue.

GRA'PHIS (Gr. *grapho*, to write), a genus of lichens, which gives its name to a tribe, *Graphideae*, remarkable for the resemblance which the fructification (*apothecia*, or *shields*) assumes to the forms of the letters of oriental alphabets. Hence, some of these little plants have received such names as *Scripture-wort*. A peculiar importance has recently been acquired by some of the *Graphideae*, from their being found only on the bark of particular species of *Cinchona*, so that they guide to the ready identification of some of the most valuable commercial barks.

GRAPHOTYPE is one among numerous modes invented within the last few years of producing an engraved surface from which printing can be effected by the ordinary press. Line-engraving, mezzotinto engraving, aquatint, and etching present the design or picture in *intaglio* on a metal plate, the lines being cut, and therefore below the surface of the plate; they cannot be printed by ordinary typography, because the ink-roller inks the parts that ought to be left clean, and leaves the lines of the device untouched. Wood-engravings, and stereotypes and electrotypes taken from them, can be printed side by side with type in the same page, and by the same operation; and hence the vast extension of this mode of illustrating books and newspapers. The inventors of *graphotype* are trying to introduce a cheap substitute for engraved wood-blocks. Mr De Witt Clinton Hitchcock, a draughtsman and wood-engraver, having occasion for a little enamel white powder, scraped some from the surface of a visiting-card, and then observed that the ink-lines remained just as distinct and prominent as before, not having been removed by the scraping. This slight incident suggested the new process—sketching the design on a chalky surface, and brushing away the chalk from between the lines. Mr Hitchcock's first experiments were partially successful, and he then received aid from others in establishing a *modus operandi*. In the latest form of the process, after many intermediate experiments, the block is superseded by a zinc plate covered with finely-pounded French chalk, brought to a hard and very fine texture by enormous pressure, with a glossy surface produced by an interposed steel plate. On this white surface, sized and dried, the picture is drawn with camel or sable hair pencils, dipped in an ink made of glue and lampblack. When dry, the white or uninked portions are rubbed down by means of a small fitch-hair brush, and pads covered with silk velvet. The rubbing is continued until the white is sunk sufficiently below the level of the inked picture or design. The plate is then saturated with liquid glass or silicate of soda, which converts the French chalk into a kind of marble. The success with which all the white is rubbed down between the inked lines, depends on a variety of circumstances—the hardness of the white, the evenness of the surface, the completeness of the petrifying action by the silicate, the protecting power of the ink or varnish, the quality of the brushes and rubbing-pads, and the careful management of the rubbing itself. Whether the fine lines of the device can be preserved from breaking up into saw-like irregularities, and whether the numerous requirements and qualities of a wood-engraving can be successfully realised, a long course of trial can alone shew. The matter has been taken up by a company.

GRAPPLE-PLANT (*Uncaria procumbens*), a procumbent plant of the same genus with the Gambir (q. v.), a native of South Africa. The seed-vessel has many hooked thorns, and clings most tenaciously to any animal—a provision for the distribution of the seed. When it lays hold of the mouth of an ox, Livingstone says, the animal stands and roars with pain and a sense of helplessness.

GRASS-MOTH (*Crambus*), a genus of small moths, allied to the Clothes-moths, of which the species are numerous, inhabiting pastures, where they are often seen to rise in great numbers when disturbed, and soon to settle again on the blades of grass. Their form, when their wings are closed, is long and narrow, pointed at the head, abruptly cut off at the opposite end. They are often brown and white, sometimes silvery and golden.

GRAY, JOHN EDWARD, naturalist, born at Walsall in the year 1800, was educated for the medical profession. In 1821, he assisted his father (who was author of *Supplement to the Pharmacopœia*, and other works) in the preparation of his *Natural Arrangement of British Plants*, in which, for the first time in the English language, the new method was adopted. In 1824, he entered the British Museum as assistant in the Natural History Department, where he found scope for the employment of his extensive knowledge and accuracy of observation, and in 1840 was appointed Keeper of the Zoological Collections. This important post he retained till his death, to the manifest advantage of zoological science, for the British Museum collections are the most complete in the world: a monument of his persevering activity throughout an active life. His success was partly due to his quickness in seizing the peculiar characteristics of animal forms, which rendered him a good classifier. The Royal Bavarian Academy of Sciences at Munich recognised his services to science by conferring on him the title of Ph.D. Dr G. wrote much on subjects connected with his department. The mere titles of his books and papers make a long list, numbering more than 500. His zoological and natural history catalogues are not mere lists, but are enriched with synonyms and ample notes, whereby study of particular subjects is greatly promoted. Dr G. did not confine his activity to his special department: he assisted in the formation of some of the most prosperous scientific societies of London: and he was a vice-president of the Zoological Society, and took an active part in its management. He, moreover, claimed to have anticipated Sir Rowland Hill in his proposal for a low uniform rate of postage. He, at various times, gave valuable evidence before parliamentary committees, on the management of the British Museum and other subjects; and he served on the juries of the Great Exhibitions of 1851 and 1862. Dr G. died at his residence in the British Museum, in 1875.

Dr G.'s principal works are: *Illustrations of Indian Zoology*, 2 vols. folio; *The Knowsley Menagerie*, 2 vols. folio; *Spicilegium Zoologicum—on Mammalia, Birds, Reptiles, Fishes, Mollusca, Shells*; a *Synopsis of the Contents of the British Museum*; besides Catalogues of the Specimens in the Zoological Department, which have greatly facilitated the study of those collections. He also wrote many scientific papers, which have been published in the *Philosophical Transactions*, the *Transactions of the Linnean Society*, the *Encyclopædia Metropolitana*, *Annals of Natural History*, and the *Reports of the British Association*; the whole comprising a mass of facts and principles highly valuable to naturalists.

In 1826, Dr G. married a lady who rendered him important aid in his studies, and is known as authoress of *Figures of Molluscous Animals, for the Use of Students*, a work in five volumes. In 1832, he was elected a Fellow of the Royal Society, and afterwards served on the Council. He was a member of some of the principal societies and academies in England and on the continent.—His late brother, GEORGE R. GRAY, who was an officer in the Zoological Department of the British Museum from 1831 till his death in 1872, was the author of many memoirs on zoology, but is best known as author of *The Genera of Birds*.

GREASE. Various kinds of tallow, fat, dripping, and kitchen-stuff receive the general name of grease, as applied to several manufacturing processes; but the name is now more technically given to the lubricating unguent employed for the rolling-stock of railway companies. While oil is the lubricator for the delicate parts of the locomotive, grease

## GREASE—GREAT EASTERN.

is necessary for the axles of the wheels. So vast is the quantity used, that the annual demand amounts to thousands of tons; and, as the quality is very important, most of the great companies make their own—establishing a marked distinction between the two kinds used for locomotives and for wagons.

*Locomotive grease* usually consists of tallow, oil, carbonate of soda, and water. Much depends on the consistency. If the grease is too thick, the axle-boxes become hot; if too thin, it is used up too quickly. Again, if there is too much alkali, there is a residue left in the boxes; if too little, the grease is too soft and wasteful. The grease is always yellow; but it is made of a thinner consistency for cold weather than for hot. The following are given as the constituents of two kinds that meet with approval, to produce one ton of each kind of grease, allowing a certain percentage for waste:

	WINTER.			SUMMER.		
	cwt.	qrs.	lbs.	cwt.	qrs.	lbs.
Tallow, . . . . .	3	3	0	4	3	0
Palm-oil, . . . . .	2	3	0	2	3	0
Sperm-oil, . . . . .	0	1	7	0	0	37
Alkali, . . . . .	1	0	14	1	0	5
Water, . . . . .	13	3	13	13	0	26

The manufacture is very simple. The tallow and oils are heated to 180° F.; the water and alkali to 200°; both are run off into wooden tubs, where they are well stirred till cold, with special precautions against the admission of any grit or dirt.

*Wagon grease* is coarser and cheaper in quality. The ingredients are chiefly some kind of resinous oil and caustic lime. When resin was cheap, wagon grease cost about half the price of locomotive grease, and was useful not only for wagon and carriage axles, but also for low-speed goods and mineral locomotives; but during the American war, the price of resin rose, and then attempts were made to use residues from paraffin, coal-tar, candle-making, cotton-seed oil, fish-oil, pitch-oil, and other substitutes.

It is said that 3000 tons of grease are made every year in the Tyne district, not exactly as a primary product, but as using up a residue from the distillation of resin.

**GREAT EASTERN.** The mightiest ship in the world has had an eventful history, marked in its earlier years by a large share of disaster. In 1852, an 'Eastern Steam Navigation Company' was formed, to maintain an ocean steam-route to the East round the Cape of Good Hope. In 1853, the directors came to a conclusion that, owing to the cost of maintaining coaling-stations on the way, such a route would not pay unless the ship could carry coal enough for the voyage out and home, besides a large number of passengers and a great cargo. Mr Brunel was employed to plan, and Mr Scott Russell to build, a vast steamer that would meet these requirements. The scheme was for a ship that would accommodate 1000 passengers, 5000 tons of merchandise, and 15,000 tons of coal for fuel. Its arrangements (setting aside later alterations) were briefly as follows: Length, 680 feet between perpendiculars, or 692 feet upper deck; breadth, 83 feet, or 118 over paddle-boxes; height of hull, 60 feet, or 70 to top of bulwarks. Bottom flat for 40 feet in width, without keel. Framework of 35 ribs or webs of plate-iron, 3 feet deep, immensely strengthened, and extending from end to end of the ship, at 3 to 5 feet apart; and cross-webs, of similar strength, connecting these at intervals. A double wall or skin of iron plate, outside and inside those ribs, thereby converting the whole hull into a cellular structure, like the top and bottom of the Menai Britannia Tubular Bridge. The plates for this purpose were 10,000 in number, some of them 28 feet

long. The cellular structure was continued along the bottom and about 5 feet up the side, and any one of the cells thus formed could be filled with water. Ten partitions of plate, crosswise of the ship, divided the interior into 11 watertight compartments, further subdivided by longitudinal partitions. The propelling power comprised both paddle and screw. The paddle-engines had 4 boilers, each with 400 brass flue-tubes; there were 4 engines (made by Scott Russell at Millwall), with cylinders of 14 feet stroke, and 74 inches diameter; the paddle-wheels were 56 feet diameter by 13 deep, with 30 spokes or radii. The screw-engines (made by Boulton and Watt at Soho) had 6 boilers; the 4 engines had cylinders, each 4 feet stroke by 84 inches diameter, with piston-rods 7½ inches thick; the propeller-shaft was 160 feet long, and in some parts 24 inches diameter, with a screw propeller at one end 24 feet in diameter. The coal-bunkers, to supply all the furnaces, would contain 14,000 tons; the smoke from the furnaces ascended 5 funnels, 100 feet high by 6 in diameter; each of the 10 boilers, when full of water, weighed 100 tons; the steam was conveyed from the boilers to the engines through a pipe 45 inches diameter. Setting aside the nominal power, all the 8 engines, at full force, were estimated to work up to 11,000 horse-power. There were 6 masts, 5 of them iron, carrying 7000 yards of sail as auxiliary to the steam-power; the masts, yards, gaffs, and large spars were mostly of iron plate, strengthened inside in various ways; the shrouds and standing-rigging were of iron-wire ropes; the anchors, 10 in number, were some of them 10 tons each; the chain-cables were, collectively, a mile long, with links of 50 lbs. each. The vast wall-sided compartments of the ship had facilities for conversion into cabins for 800 saloon passengers, 2000 second-class, 1200 third-class, and 400 officers and crew; or 5000 might have been accommodated in all, if emigrants or troops. The height of the 'tween decks was 13 feet; and all, whether for first, second, or third class passengers, were more lofty than known in any other ship. Such were the plans for the mighty ship; they were never fully carried out in all their details, owing to numerous alterations and refittings; nevertheless, the description faithfully conveys an idea of the general characteristics. The curvatures of the hull, in length, breadth, and height are shown by diagrams in SHIP-BUILDING.

Twenty years of the ship's history present a singular series of vicissitudes. During 1854—1857, the operations proceeded at Millwall, under frequent and heavy financial pressure, which taxed the resources of the Company severely; while the engineer and builder were frequently called upon to surmount difficulties of almost unparalleled kind. By November 1857, the ship had advanced to the launching condition. In order to avoid the danger of launching such a long vessel stern foremost, the ship was built with the broadside towards the river, on a timber foundation of immense strength, with sloping ways, or rails, down to the water. Either the ship was too heavy (12,000 tons), or the slope was too gradual; for it required various attempts, between November 3, 1857, and January 31, 1858, and an expenditure of £60,000, to effect the launching. During 1858 and 1859, the works continued as fast as the Company could supply money. Uncertain how far the original intention of a trade to and from Australia could be realised, the directors determined on a trial trip across the Atlantic. It was a disaster. The ship left the Thames, September 8, 1859; an explosion of steam-pipes took place off Hastings; seven persons were killed and several wounded; and the voyage abruptly came to an end

at Weymouth. Mr Brunel died immediately after his vast ship had made this her first but futile attempt to brave the ocean. After a winter and spring spent in costly repairs, acrimonious recriminations, and suits in law and equity, the ship started again on June 17, 1860. Leaving Southampton on that day, she crossed the Atlantic in eleven days, and reached New York on the 23th. During the remainder of 1860, and the greater part of 1861, she made many voyages to and fro, loaning money by the insufficiency of the receipts to meet the current expenses, and constantly required repairs. In December, when political relations with the United States looked ominous, the G. E. served as a troop-ship, carrying some battalions of Foot Guards over to Canada with a degree of comfort never before experienced by 2000 human beings in one ship.

The years 1862 to 1864 were nearly a blank as concerns the history of the *Great Eastern*. No attempt was made at a voyage to Australia and back; the trips across the Atlantic had not been remunerative; the government did not often require the services of so vast a fabric as a troop-ship; and the Company were always embarrassed by overhanging debts. In 1864 negotiations were entered into with the Atlantic Telegraph Company and the Telegraph Construction and Maintenance Company, for the employment of the G. E. as a cable-laying ship. The passenger accommodation was wholly removed from the interior, to make room for the enormous iron tanks in which the cable was stowed. The arrangement and services of the ship in 1865 and 1866, will be found briefly noticed under ATLANTIC TELEGRAPH in SUPP. Vol. X. In 1867, when the Paris International Exhibition was approaching completion, a body of speculators chartered the G. E. for a certain number of months, to convey visitors from New York to Havre and back again—under the expectation that the number of such visitors would be so vast as to defray the whole of the expenses, and yield a large profit. A great outlay was incurred to reconvert the vessel from a cable-laying to a passenger ship, and for extensive renewals of machinery. The ship started from Liverpool for New York in May; but the speculation proved an utter failure, there being neither wages for the seamen and engineers, nor profit for the speculators.

In 1868 a new arrangement was made, by which the ship was to be permanently chartered by the Telegraph Construction and Maintenance Company. The name, which had been changed from *Leviathan* to *Great Eastern*, and then to *Great Ship*, was again changed to *Great Eastern*. The passenger fittings, introduced in 1867, were removed, and everything arranged for the important work of submarine cable-laying. This has proved to be an advantageous mode of employment. Between 1869 and 1874 the *Great Eastern* successfully laid some of the most important telegraphic cables—across the Atlantic, in the Mediterranean, in the Red Sea, across the Indian Ocean, across the equator from Europe to Brazil, &c.

**GREENBACKS.** During the Civil War in America from 1861 to 1865, the immense expenditure of the United States government led to the printing of an unprecedented number of bank-notes, bonds, and currency papers of various kinds. These documents, from the colour presented by them, or some of them, obtained the name of *greenbacks*, a designation which became almost as familiarly used in Congress as among the general public. At first, the manufacture of these notes taxed the resources of the government in a very embarrassing way; and there was ample reason to suspect that forged notes

and bonds were abundantly in circulation; but, by degrees, a fine and large establishment was organised at Washington, under the immediate control of the Secretary to the Treasury. In this establishment, everything was conducted from first to last; rags, fibres, plates of steel, and colours were taken in, and finished notes were sent out. It was only under very rare circumstances that strangers were admitted to view the operations; but one such occasion, in 1864, led to a general description of the place being given in most of the newspapers, from which it was copied into some of the English scientific journals.

Speaking of the establishment as it was in 1864, and not touching upon any of the modifications which may since have been introduced, there were distinct and separate departments for mechanical repairs, paper-making, ink-making, paper-wetting, plate-engraving, printing, numbering and denominating, and cutting. In the paper-mill, all the paper for the greenbacks was made, with a degree of scrupulous attention and uniformity that cannot always be insured in a private establishment. It was necessary to have a paper that would wear well, would not split easily, and would be sufficiently non-photographic to baffle a forger. Dr Gwynn made many experiments, with a view to attain excellence on these points; and at length he produced a kind of paper nearly as strong as parchment and as smooth as satin. The nature of the material was known only to himself and the government. There was a fibre in the paper, quite moulded or felted into its substance, which could not be photographed without discolouring the sheet to which it was transferred, giving it the appearance of a coarse, black, spider-web, which would instantly have betrayed the forgery. In another department, the ink was made by means of grinding-machines, one for each of the several colours used in the various kinds of notes and bonds. While these operations of paper-making and ink-making were in progress, the engraving of the plates was conducted in another department. The steel-plates were engraved with the most minute and intricate devices which the hand and the eye of the artist could execute: it mattered little what device was selected, provided it were difficult for a forger to imitate. One particular note was, in its main features, an engraved copy of a picture in the rotunda of the Capitol at Washington; and the engraving is said to have occupied a whole year to execute. All the devices, of whatever kind, were made to co-operate with delicate water-lines in the paper, to render forgery difficult. As the plates were costly to engrave, and fitted to yield only a certain (though large) number of impressions each, a mode of multiplication was adopted which had for many years been largely used in England. The processes were thus connected: 1. The engraver executed the design on a smooth plate of soft steel. 2. The plate was hardened by well-known processes of heating and cooling. 3. A roller of soft steel was pressed with immense force over the hardened plate, and took upon its surface the device *in relief*: as the roller was equal in length to the length of the plate, and equal in circumference to its breadth, the curved surface exactly took in the whole of the device. 4. The roller was hardened. 5. The hardened roller was used as a matrix to produce any number of plates in soft steel, which had the device *in intaglio*, like the original plate. 6. These plates, when hardened, were used to print from.

The paper, the ink, and the plates being thus prepared, all was ready for the printing. In the earlier period of the working of the establishment, presses were used such as are generally employed by copper-plate printers; each press attended by a woman to

place and remove the paper, and a man to manage the inking and the pressure; but afterwards, a large room was filled with hydraulic printing-presses, which conducted the operations much more rapidly. The notes, as fast as printed, were interleaved with sheets of thin brown paper, to prevent blurring. In numbering and denominating the notes, a yellow mordant was employed, of such kind that the note could not be photographed without producing a black impression from the yellow portion. The numbering-machine was worked by a treadle; there were six discs with figures on their edges, and they so acted on each other by means of ratchets, that they could print any number from 1 to 999,999. For consecutive numbering, the machine adjusted its own figures after each printing. The notes were usually printed four on a sheet, and were afterwards severed and trimmed by a cutting-machine, which made them all precisely equal in size and shape. So complete was the check established in all the operations, that 'not even a blank sheet,' said a narrator, 'much less a printed one, is passed from one hand to another without being counted and receipted for; and unless there is collusion from one to another in every process through which the paper has to pass before it is finished, there cannot be an over-issue. The paper is issued from one room, and is re-issued from that room sixteen or eighteen times before it is put into circulation; being counted, charged, and receipted for each time, and recounted, recharged, and re-receipted for through each process that it passes after leaving that room.' For the English system, see BANK-NOTES.

**GREENSHANK** (*Totanus glottis*), a bird of the same genus with the redshank and some of those known as sandpipers, but differing from them in the stronger and slightly recurved bill. It is about the size of a woodcock, but has much longer legs. The bill is about two inches long. The tail



Greenshank (*Totanus glottis*).

is short. The lower part of the tibiae is naked. The plumage is mostly dusky brown on the upper parts, the feathers edged with yellowish white; the under parts are white. Small flocks of this bird are seen on the British coasts in the winter months, and sometimes near inland lakes and marshes. A few remain to breed in the Hebrides and north of Scotland, but the greater number repair to more northern regions. The geographic distribution of the species is extremely wide even for a bird of passage; from the arctic parts of Europe, Asia, and

America, it extends southward as far as Java and Jamaica.

**GRE'WIA**, a genus of trees belonging to the natural order *Tiliaceae*, having simple and more or less ovate leaves, and a drupaceous fruit containing four 2-celled and 2-seeded nuts. They are African and Asiatic, mostly tropical and subtropical. Some species, as *G. sapida* and *G. Asiatica*, natives of the warmer parts of India, yield pleasant fruits, much used in the manufacture of sherbet. By the inhabitants of the Himalaya, the inner bark or bast of *G. oppositifolia* is used for the same purposes as that of the lime tree in Europe; and the leaves of *G. didyma* and other species are given as fodder to cattle, and dried and stacked for winter use. The wood of *G. didyma* is used for boats. That of *G. elastica* is much valued for purposes requiring strength and elasticity, as for making bows and the shafts of carriages.

**GRIGORIO'POL**, a town of South Russia, in the government of Kherson, on the left bank of the Dniester, 78 miles north-west from Odessa. It is a fortified town, and regularly built, is inhabited chiefly by Armenians, and has manufactures of silk and cotton stuffs. Its Armenian inhabitants have received large grants of land in the vicinity, but neglect its cultivation, and are chiefly occupied in commercial pursuits. Pop. (1867) 6608.

**GRIVEGNÉE**, a town of Belgium, in the province of Liege, and about two miles south-east from Liege, on the right bank of the Ourthe. Steam-engines and other machinery are extensively manufactured; also nails, copper wire, and strings for musical instruments. G. has brickworks, and worsted and fulling mills. There are coal-mines in the vicinity. Pop. 6234.

**GRO'DEK**, or **GRUDEK**, a town of Austrian Galicia, 15 miles west-south-west of Lemberg, with which it is connected by railway, is situated partly on a hill between two small lakes, and partly on three small islands. Pop. (1869) 8000, consisting chiefly of German colonists, but including also a number of Jews.

**GROSSE'TO**, a town of Central Italy, capital of the Maremma (q. v.), on the Ombrone, about 10 miles from its mouth, and 70 miles south of Florence. The town is very unhealthy, but it is well built, and is regularly fortified, the walls forming a pentagon with brick bastions and two gates. It is the seat of a bishop, has a fine cathedral, two convents, hospital, &c., and in the centre of the square a colossal statue of Leopold II. There are manufactures of silk and woollen goods, glass, &c. About 6 miles from G. are the ruins of the very ancient Etruscan city of *Rusella*, the Cyclopean walls of which may still be traced. It was at one time so powerful as to be one of the twelve cities of the Etruscan league. Pop. 3000.

**GRO'TTÉ**, a town of Sicily, in the province, and 13 miles north-north-east, of Girgenti. It derives its name from the number of caves in the rocks around it, which prove it to have been an ancient site. It is supposed by some to be that of *Erbessus*, a town where the Romans deposited their military stores during their siege of Agrigentum, in 262 B.C., but which was seized by Hanno, the Carthaginian general. Sulphur is found largely in the neighbourhood. Pop. 7300.

**GUANONIEN**. Under this name, Du Chaillu, in his second volume of travels, entitled *A Visit to Ashango Land*, mentions a great bird of prey, inhabiting the tropical parts of Western Africa, hitherto unknown to naturalists, which he thinks may

probably rival in size the condor of South America. He failed, however, in all endeavours to procure a specimen, the bird being apparently very wary. He regards it as an eagle, and not as a vulture, and its habits shew this conjecture to be probable. The traveller says: 'Several times I have been startled in the forest by the sudden cry of anguish of a monkey who had been seized by this "leopard of the air," as the natives often call it, and then saw the bird, with its prey, disappear out of sight.' On one occasion, he saw a nest of this bird at the top of a gigantic tree, but the young had flown away. At the foot of the tree lay more than 100 skulls of monkeys, of different sizes, some of which must have been formidable animals.

**QUEBWILLER** (Ger. *Gebweiler*), a town in the province of Alsace-Lorraine, 15 miles S.S.W. of Colmar, on the right bank of the Lauch, at the foot of the Ballon de Guebwiller. The town is well built, has two handsome churches, one built in the 11th, and the other in the middle of last century. There are manufactures of tapes, ribbons, cottons, woollen cloths, gloves, nails, and refined sugar; there is also an extensive manufacture of spinning machinery. In the vicinity are coal-mines and slate-quarries; good white wine is abundantly produced in the district. Pop. (1871) 11,338.

**QUEUX**, or 'The Beggars,' the name assumed by the confederated nobles and other malcontents who opposed the tyrannical policy of Philip II. of Spain in the Low Countries. Philip having sent nine inquisitors to that country to put into execution the decrees of the Council of Trent, provoked by this act the bitter resentment of the Protestants, as well as of the Catholics and nobility, who saw in it an attempt to curtail their ancient liberties. A party of opposition was thus formed, and, headed by Counts Louis of Nassau and Henry de Brederode, declared in an act called the 'Compromise,' which was remitted (5th April 1566) to the Regent Margaret, their fixed determination to ignore utterly the authority of the inquisitors. On the admission of a deputation from them to an audience, the regent seemed somewhat unnerved by their bold front, and inclined to yield to their demands; when one of her council approached her, and whispered that she 'need not be afraid of these gatherings of beggars.' The remark having been overheard by some of the deputation, the abusive epithet was assumed as the title of their association. As a sign of fraternity, each of the 'beggars' wore a medal called the 'beggar's denier,' made of gold or silver, and stamped on the obverse with the image of Philip II., and the inscription, 'In everything faithful to the king;' and on the reverse with a wallet, such as the mendicant monks carried, held in two hands, with the words, 'even to the carrying of the wallet.' The 'beggars' maintained a long and vigorous contest against the despotic proceedings of Philip and his advisers, but were ultimately compelled to succumb to superior force. A branch of them, 'the Beggars of the Sea,' under the bold leadership of the savage Count de la Marck, were almost uniformly successful in their enterprises: they several times defeated the Spanish fleet, captured transports with supplies for Alva's army, captured several fortresses, and succoured besieged places along the coast.

**QUICOWAR**, or 'the Herdsman,' the designation of a powerful Mahratta prince, whose dominions at the present time include most of Guzerat (q. v.), with Baroda for capital. The G. originally, as the name denotes, was an officer in the establishment of the rajahs of Satara, the supreme rulers of the Mahrattas (q. v.), and after a time rose high in rank

from his military services, being ultimately appointed hereditary second in command of the Mahratta armies, of which the command-in-chief was vested in the family of Sindia. Pelajee, who became G. in 1721, by predatory excursions gradually acquired authority over Guzerat; and his son Damajee, who succeeded in 1732, still further extended the bounds of this ample dominion. The latter then threw off his allegiance to the Peishwa, but being taken prisoner by treachery, he was compelled to yield one half of his dominions, and do homage for the other half. Annund Rao, who ascended the throne in 1800, was the first prince of the line who had intercourse with the British Indian government; and it is worthy of remark that, down to the present time, the relations of the British with these Mahratta princes have been uninterruptedly friendly. The two powers came into contact on the occasion of a civil war between the reigning prince and an illegitimate brother who aspired to the throne; and in consideration of the aid afforded him by the Bombay government, the G. agreed by treaty to disband his Arab soldiers, and receive a British subsidiary force, 15th March 1802. This was effected, not without some disturbance on the part of the refractory soldiery; and various other agreements having been made from time to time, the whole of them were included in a treaty of general defensive alliance, 21st April 1805, by which a permanent British subsidiary force is maintained by the Guicowar. This prince held himself aloof from the disputes between the British government and the other four great Mahratta chiefs, but in 1816 he became involved in a quarrel with the Peishwa with respect to some districts claimed by each. The Peishwa caused the ambassador of the G., an able and upright minister, to be treacherously assassinated; and refusing the demand of the British Resident (who was bound by the treaty of 1805 to aid the G.), that his infamous agent should be given up, became involved in hostilities with the Calcutta government, which terminated in the destruction of his state and power. Syajee Rao, who ascended the throne in 1819, abolished suttee in 1840. See BARODA in Vol. I.

**GUISEBOROUGH**, a market-town of the North Riding of Yorkshire, 5 miles from the mouth of the Tees, and 40 miles north of York. It is connected with the Stockton and Darlington branch of the North-eastern Railway. The town lies at the foot of the Cleveland Hills, consists chiefly of one main street of good houses, has several churches, grammar and other schools, almshouses, and market-house. The earliest alum-works in England were established here about the year 1600. There is a trade in wool. Rope-making, brick and tile making, and tanning are carried on. The recent development of the ironstone mining in the neighbourhood has brought a large number of miners and others to reside in and about the town, so that, since 1861, the population has greatly increased. A rich monastery once stood here, of which a small part still remains, built in 1119 by Robert de Brus, lord of the town. At the time of the Reformation, this was one of the wealthiest and most magnificent monastic institutions in the kingdom. Recent excavations have brought to light many interesting antiquities. Among other objects, the workmen came upon the remains of an oak coffin, containing a skeleton, which was found to measure 6 feet 8 inches in length. Pop. (1871) 5202.

**GUISE**, a town of the department of Aisne, France, situated on the left bank of the Oise, 37 miles north-north-east from Soissons. It is walled, and otherwise fortified. It is an ancient town, and was of much consequence in the early wars of

France. Within the town are the ruins of a castle, from which the famous Dukes of Guise (q. v.) derived their title. G. is now a place of considerable commercial and industrial activity; has linen and cotton manufactures, tanneries, &c., weekly markets, and eight annual fairs. Pop. (1872) 5402.

**GUL'NOCHA** (*Cocculus cordifolius*), a plant of the same genus which yields Calumba (q. v.), extensively used in the East Indies as a tonic and febrifuge. It is largely cultivated in some parts. It is a climber, with heart-shaped leaves. It exhibits a wonderful tenacity of life. When it has acquired the diameter of half an inch, it is not unusual to cut from the main stem a portion of from 20 to 30 feet in length, when the part sustained by the branches of the tree sends down threads to the ground, which take root, and become new stems. To plant it, a few yards of the stem are merely made into a coil, and hung on the branch of a tree (Tennent's *Ceylon*).

**GUN-COTTON.** During the last few years, great improvements have been effected in the manufacture and application of this material, and in consequence, its use is rapidly extending, especially in Great Britain, where it is found of great advantage in mining operations, owing to its not producing smoke when exploded. For the improvements as well as the invention of gun-cotton, we are chiefly indebted to the Austrians, the most important improvement being that of Baron Lenk, consisting chiefly in the following precautions in the manufacture: 1. A perfect cleansing and drying of the cotton. 2. The use of the most concentrated and purest acids procurable commercially. 3. Steeping the cotton a second time in a mixture of the strong acids. 4. Continuance of this steep for forty-eight hours. 5. A thorough purification of the gun-cotton from free acid by washing in a running stream for several weeks. This may be supplemented by washing in a weak solution of potash, but is not absolutely necessary. The following are the important advantages insured by the new method of making gun-cotton:

*For Purposes of Artillery.*—1. The same initial velocity of the projectile can be obtained by a charge of gun-cotton one-fourth of the weight of gunpowder. 2. There is no smoke from the explosion of gun-cotton. 3. Gun-cotton does not foul the gun. 4. Gun-cotton does not heat the gun to the injurious degree of gunpowder. 5. Gun-cotton gives the same velocity to the projectile with much smaller recoil of the gun. 6. Gun-cotton will produce the same initial velocity of projectile with a shorter length of barrel. 7. In projectiles of the nature of explosive shells, gun-cotton has the advantage of breaking the shell more equally into much more numerous pieces than gunpowder. 8. When gun-cotton is used in shells instead of gunpowder, a quantity equal in weight to one-third of the latter produces double the explosive force.

*For Civil Engineering and Mining.*—9. In driving tunnels through hard rock, a charge of gun-cotton of given size exerts double the explosive force of gunpowder, so as to render a smaller number of holes necessary. 10. Gun-cotton also may be so used as, in its explosion, to reduce the rock to much smaller pieces than gunpowder, and so facilitate its removal. 11. As gun-cotton produces no smoke, the work can proceed much more rapidly, and with less injury to the health of the miners. 12. In working coal-mines, the advantages of bringing down much larger quantities of material with a given charge, and the absence of smoke in the explosion, enable a much greater quantity of work to be done in a given time at a given cost. 13. The weight of gun-

cotton required to produce a given effect in mining is only one-sixth part of the weight of gunpowder. 14. In blasting rock under water, the wider range and greater force of a given charge is a great element in cheapening the cost of submarine work. 15. The peculiar local action of gun-cotton, to which the effects of gunpowder shew no analogy, enables the engineer to destroy and remove submarine stones and rocks without the preliminary delay and expense of boring chambers for the charge.

*For Military Engineering.*—16. The smaller weight of gun-cotton offers great advantages in facility of transport, the weight being one-sixth that of gunpowder. 17. The peculiar localised action of gun-cotton enables the engineer to destroy bridges and palisades, and to remove every kind of obstacle with great facility. 18. For submarine explosion, either in attack or defence, gun-cotton has the advantage of a much wider range of destructive power than gunpowder. 19. For the same purpose, gun-cotton, from its lightness, has the advantage of keeping afloat the water-tight case in which it is contained, while gunpowder sinks it to the bottom.

*For Naval Warfare.*—20. Where guns are close together, as in the batteries of ships and casemated forts, the absence of smoke removes the great evil of the firing of one gun impeding the aim of the next, and thus gun-cotton facilitates rapid firing. 21. Between-decks also, the absence of smoke allows continuous rapid firing to be maintained. The absence of fouling and of heating are equally advantageous for naval as for military artillery.

*General Advantages.*—Time, damp, and exposure do not alter its qualities when carefully prepared. Being made in the form of rope, yarn, or, according to the most recent improvement, in compressed discs, accidents cannot arise from spilling as in gunpowder. It is also believed to be free from the danger of spontaneous combustion, but this is perhaps not the case under all circumstances.

The dreadful explosion at the Gun-Cotton Mills, Stowmarket, in August 1871, has thrown doubts on the safety of this substance. With respect to that particular accident, evidence was given to shew that sulphuric acid had been maliciously added to the gun-cotton, although this was not completely proved. Some minor accidents have happened since, caused, so far as we can learn, by carelessness in handling the material. However, the works at Stowmarket have been rebuilt, and gun-cotton appears to be more or less used for mining and quarrying in several parts of England.

**GURKFELD**, a town of Carniola, Austrian Empire, on the right bank of the Sava, 46 miles east-by-south from Laibach, at the base of a mountain-range. It is supposed to occupy the site of the Roman Noviodunum. The district produces much wine. There are thermal springs and baths in the town. It contains a Capuchin monastery. Pop. (1869) 6000.

**GURMUKTESWAR**, a town of British India, in the district of Meerut, on the route from the town of Meerut to Moradabad, and 31 miles south-east of the former. It is situated on the right bank of the Ganges, about 4 miles below the reunion of the Burha Ganga, or old course of the Ganges, with the present main channel, which, a mile and a half above the town, is crossed by a much-frequented ferry, on which 15 boats constantly ply. G. may be regarded as the port of Meerut and the adjoining district of the Doab. Pop. (1871) 7962.

**GYARMA-T-BALASSA**, or **BALASSA-GYARMAT**, a town of Hungary, in the county of Neograd, 42 miles north-by-east from Pesth, on the left bank of the Eipel or Ipoly. The surrounding district is



very beautiful and fertile, producing much excellent wheat. Near the town are the ruins of a castle, once belonging to the Balassa family, and famous as having been oftener than once heroically defended against the Turks. Pop. (1869) 6435.

**GYOMA**, a town of Hungary, in the county of Bekes, 89 miles south-east-by-east from Pesth, and on the railway between Pesth and Temeswar. It stands in a plain on the bank of the Körös, which is here crossed by a bridge. There is a Protestant church. Pop. (1869) 9907.

**GYPSY-WORT** (*Lycopus Europæus*), a perennial plant of the natural order *Labiata*, with stem about two feet high; opposite, ovato-lanceolate, scarcely stalked, almost pinnatifid, wrinkled leaves; and dense whorls of small whitish flowers with purple dots, the limb of the corolla 4-cleft and nearly equal; only two stamens perfect. It grows in ditches and wet places, in Britain and on the continent of Europe. It is a febrifuge. The juice stains cloth a permanent black colour, and gypsies are said to use it to give a dark hue to their skin, whence the English name gypsy-wort, and the French *Herbe des Bohémiens*.

**GYROSCOPE** (Greek) is the name given to an instrument for the exhibition of various properties of rotation and the composition of rotations. It differs from a top in having both ends of its axis supported. The invention is probably French or German, and in some of its forms it dates from about the end of last century; but no certain information can be obtained on these points. We will consider only two of its many applications.

First, if a mass be set in rotation about its principal axis of inertia of greatest or least moment, it will continue to revolve about it; and, unless extraneous force be applied, the direction of the axis will remain unchanged. Such, for instance, would be the case with the earth, were it not for the disturbances (see **NUSTATION** and **PRECESSION**) produced by the sun and moon: the direction of the axis would remain fixed in space (i. e., the pole-star would be always the same star), in spite of the earth's motion in its annual orbit. It is for this very reason that modern artillery is rifled, so that the projectile revolves about its axis. If, then, a mass of metal, as, for instance, a circular disc, loaded at the rim, and revolving in its own plane, be made to rotate rapidly about its axis of greatest moment of inertia, and if it be freely supported (in gimbals, like the box of a compass), the direction of its axis will be the same so long as the rotation lasts. It will therefore constantly point to the same star, and may, of course, be employed to shew that the apparent rotation of the stars about the earth is due to a real rotation of the earth itself in the opposite direction. This application was made by Foucault shortly after his celebrated Pendulum (q. v.) experiment, and he is generally looked upon as the inventor. The *Transactions of the Royal Scottish Society of Arts*, however, shew that this application of the gyroscope was made many years before (March 1836), by Mr E. Sang, C.E. It is, in practice, by no means so perfect a mode of proving the earth's rotation as the Foucault pendulum; but this arises solely from unavoidable defects of workmanship and materials—the mass of the gimbals, and the friction on the pivots. Professor Smyth, the Scottish Astronomer-Royal, has recently applied this property of the gyroscope to the improvement of our means of making astronomical observations at sea. A telescope, mounted on the same support as the ends of the axis of the gyroscope, will, of course, be almost unaltered in position by the rolling or pitching of a vessel; and a steady horizon, for

sextant observations of altitude, is procured by attaching a mirror to the support of the gyroscope, and setting it once for all by means of spirit-levels. The mechanical difficulties of construction have not yet been quite got over, but there seems to be little doubt that this application will some day be of very great practical value.

But the most singular phenomena shewn by the gyroscope are those depending on the composition of rotations. We have already seen (**ROTATION**) that any motion whatever of a body which has one point fixed is of the nature of a rotation about an axis passing through that point. Hence, simultaneous rotations about any two or more axes, being a motion of some kind, are equivalent to a rotation about a single axis. The effect, then, of impressing upon the frame in which the axis of the gyroscope is suspended a tendency to rotate about some axis, is to give the whole instrument a rotation about an intermediate axis; and this will coincide more nearly with that of the gyroscope itself, as the rate of its rotation is greater. It is hardly possible to explain to the non-mathematical reader the exact nature of the compound motion, which consists in the rolling of an imaginary cone fixed in the gyroscope upon another fixed in space; but the rotation of the axis of a top round the vertical (when it is not 'sleeping' in an upright position), and the precession of the earth's axis, are precisely similar phenomena. Thus, when the gyroscope is spinning, its axis being horizontal, a weight attached to the framework at one end of the axis (fig. *b*) makes the whole rotate about the vertical; attached to the other end, the rotation takes place in the opposite direction. And the framework may be lifted by a string attached near

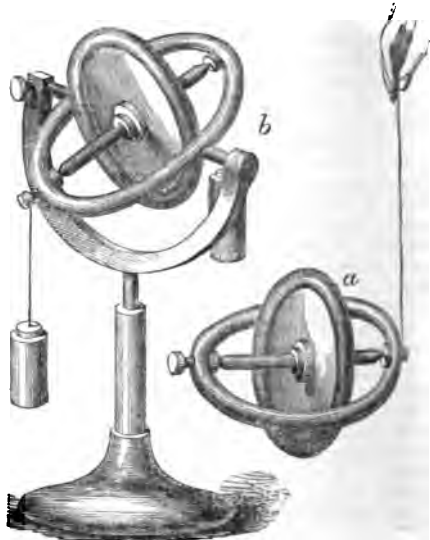

Gyroscope.

one end of the axis (fig. *a*) without the gyroscope's falling. Its axis still projects horizontally from the string, but it revolves as a whole round the string. Various other singular experiments may be made with this apparatus; and others, even more curious, with the gyrostat of W. Thomson (q. v.), which is simply a gyroscope enclosed in a rigid case, by which the ends of its axis are supported. When a gyrostat is made the bob of a pendulum under certain conditions, the plane of vibration of the pendulum turns, as in Foucault's celebrated experiment, but in general at a much greater rate.

## H

**H**AIDUCKS (i. e., Drivers, from the Hungarian *Hajdú*, plural *Hajdúk*), originally a designation of cattle-herds in Hungary. Afterwards, the word came to signify a class of mercenary foot-soldiers ready to accept pay from any one who would employ their services, but displaying great gallantry on the field of battle. The remarkable constancy with which they stood by Bocskai throughout the war of the revolution, was rewarded by that prince with a grant of a district as their own possession, and at the same time with the privileges of nobility. This grant was made by a public decree of 12th December 1605, and was confirmed by the diet in 1613. Except the privilege of exemption from taxes, which Charles III. took away, the Haiducks enjoy all the rights of nobles to the present day. Their residence, the Haiduck district, remains independent of the county authorities, and is under the direct administration of the national government. The Haiduck district lies within the county of North Bihar, between the Theiss and Transylvania, has an area of about 594 sq. m., and six principal Haiduck towns. The capital of the district used to be Bözörmény. The total pop. is about 63,000, all Magyars, and for the most part belonging to the Reformed Church. In 1876 this district was incorporated with portions of two adjoining districts into a new administrative division (called *Haidukencomitát*) with Debreczin for its capital. In course of the present century, the name Haiducks has begun to be applied to the mercenaries of Hungarian courts and the halberdiers of the Hungarian magnates; also to the lackeys and other attendants in German courts.

**HAINICHEN**, a town of Saxony, 23 miles south-west of Dresden, on a tributary of the Mulde. Wool-spinning, weaving, and the manufacture of cloth are carried on. Pop. (1871) 8331.

**HAL**, a town of Belgium, in the province of South Brabant, on the Senne and the Charleroi Canal, 10 miles south-east of Brussels. It is a station on the Mons Railway. The church of St Mary is a rich Gothic edifice, containing a chapel resorted to by pilgrims on account of a black miracle-working wooden image of the Virgin, two feet high, which has acquired enormous wealth from the offerings of pious devotees. The high altar has a marble retables, unequalled in the Netherlands, carved by Mone, a native artist, 1533. The town has breweries, tanneries, distilleries, several mills, and manufactures of wicker-work and articles of wood. Pop. (1870) about 8000.

**HALE, SARAH JOSEPHA**, American authoress, was born at Newport, New Hampshire, 1795; her maiden name was Buell. Married to David Hale, an eminent lawyer, about 1814, she pursued with him a regular course of study until his death in 1822, when she devoted herself to authorship, and produced her earliest work, *The Genius of Oblivion, and other Poems* (Concord, N. H., 1823), followed by *Northwood, a Tale of New England* (Boston, 1827). In 1828, she removed to Boston, and edited the *Ladies' Magazine*, monthly, until 1837, when it was united

with the *Ladies' Book*, Philadelphia, in which city she has since resided. Besides her labours as editor, she has written *Sketches of American Character; Traits of American Life; Flora's Interpreter; Good Housekeeping; Grosvenor, a Tragedy* (founded on the story of Colonel Hayne, a martyr of the Revolution); *The Judge, a Drama of American Life*; three metrical romances (entitled *Alice Ray; Three Hours, or The Vigil of Love; and Harry Grey*); and her most important work, *Woman's Record*, or sketches of all distinguished women from the creation to 1854 (2d edition, New York, 1855). All her works are characterised by good taste, and her tales and poems by vivid description and strong pathos.

**HALLÉ, CHARLES**, an eminent pianist, was born at Hagen, in Westphalia, in 1819; studied first at Darmstadt, and afterwards at Paris, where his reputation was established by his concerts of classical music. He afterwards settled in England, where his time has been principally divided between London and Manchester. In purity of style, he is considered almost without a rival, and the best living interpreter of Beethoven. His aim has ever been to raise the popular standard of musical taste, an object in which he is believed to have achieved no small success in London, Manchester, and elsewhere.

**HALLECK, FITZ-GREENE**, an American poet, born at Guilford, Connecticut, in 1795. By his mother, Mary Eliot, he was descended from John Eliot, 'the apostle of the Indians.' He became a clerk in a bank in New York in 1813, in which employment he remained for many years. He was afterwards for a considerable time the confidential agent of Mr John Jacob Astor in his commercial affairs, and was appointed by him one of the original trustees of the Astor Library in New York—a position which he held to the end of his life. In 1849, he retired from banking and mercantile pursuits, and took up his residence in his native place, where he spent the remainder of his days. From his boyhood, H. wrote verses, some of which he sent to newspapers; but in his collected poems, he has included nothing published earlier than his lines on *Twilight*, which appeared in a New York paper in 1818. In the following year, he became associated with Joseph Rodman Drake in contributing the humorous series of *The Croaker Papers* to the same journal. The illness of Drake soon put an end to these papers, and H. commemorated his friend's death in a very beautiful little poem. In 1849, H. wrote his longest poem, *Fanny*, a satire on the literature, fashions, and politics of the time, in the measure of *Don Juan*. It is said to have occupied less than three weeks in its composition, and derived its immediate and great popularity rather from the pungency of its allusions than from any higher merit. In 1822—1823, H. visited Europe; and in 1827, published an edition of his poems, in which were included several pieces suggested by the scenes and associations of the Old World, among which the lines on Alnwick Castle and on Burns particularly commanded admiration. H.'s style is spirited, flowing, and graceful; his versification almost always very smooth and harmonious. His poems display much geniality and tender feeling. Their humour is deli-

cate and refined. Few poets, and particularly few American poets, who have written well and acquired popularity like H., have written so little. His whole poems are included in a 12mo volume of very moderate size. H. died in November 1867.

HALLUIN, a town of France, in the dep. of Nord, 10 miles north-north-east of Lille. Weaving, bleaching, cotton-spinning, and brick-making are carried on, and there are manufactures of linen and calico. Pop. (1872) 8680.

HALOXYLIN, the name of a new kind of explosive material or blasting-powder, which has been invented in Styria by two brothers, and is described as incapable of spontaneous ignition, and as quite free from smoke and noxious gases. It is composed of non-resinous sawdust, charcoal, nitre, and ferrocyanide of potassium, and is twice the bulk of gunpowder, but one-half more powerful. For blasting and mining purposes, it is considered as preferable to gunpowder.

HAMAHA (Gr. *Epiphania*, and the *Hamath* of the Bible), a city of Syria, 120 miles north of Damascus. The town is built on both sides of the Orontes, which is here crossed by four bridges. A number of huge wheels, turned by the current, raise the water into aqueducts, which convey it to the houses and mosques of the town. The town is enclosed by walls, and the houses are built in the Damascus style of sun-dried bricks and wood. The principal structures are the governor's palace, many mosques, baths, bazaars, and the wheels and aqueducts already mentioned. There are manufactures of silk, cotton, and woollen fabrics, gold and silver thread. H. ranks among the oldest cities in the world. It was a noted place, and the capital of a little kingdom, when the Israelites came out of Egypt; and its name is mentioned in almost every passage in which reference is made to the northern border of the Promised Land. Pop. 30,000.

HANDICAPPING is the term used in various games and sports to denote the placing of competitors, good, bad, and indifferent, on such a footing that all shall have, as nearly as possible, an equal chance of winning. Thus, in horse-racing, when the speed of one horse has been ascertained to be greatly superior to that of another, the swifter of the two, in a handicap race, is made to carry extra weight to an amount that shall be deemed sufficient to reduce its speed to a level with that of its antagonist. Where the public performances of a horse have been exceptionally good, and when both speed and endurance are found to be of an unusually high character, the penalty inflicted in all future handicaps is very great, amounting sometimes to a weight several stones above that of very inferior competitors. The *beau idéal* of a handicap would thus be one in which the merits of the animals should be so nicely discriminated, and the weights so accurately adjusted, that all the competitors should pass the winning-post at the same time, and thus run a 'dead-heat.' This is, of course, impossible in practice, but it is nevertheless the ideal at which the handicapper must aim; and the nearer he approaches to it, the more perfect is his work. In racing, no jockey with his saddle, &c., must weigh less than five stone seven pounds, but the maximum is left in the hands of the handicapper, who apportions to each horse a weight corresponding to its public performances, age, and sex. No appeal is allowed from his decision, nor can he be called upon to give the reasons that may have actuated him in allocating weights. Vested with such arbitrary power, he should be a person of sound judgment, unquestionable integrity, and thorough experience. His usual mode of constructing a

handicap is to select the best and the worst horse entered for a race, placing such a weight upon the former as he supposes shall bring it down to a level with the latter's minimum of five stone seven pounds. He then proceeds to adjust the weights of the intermediate horses according to their varied merits.

When the handicaps have been published, no alteration can take place in the relative weights of the horses entered, unless one of these should prove a winner during the time intervening between the issue of the handicap and the period of its decision; in which case, extra weight, varying from three pounds and upwards, may have to be carried by the winning horse, as a penalty for his intermediate victory. Each jockey, with his saddle, &c., is weighed prior to starting, the exact extra weight to be carried being made up by lead strips let into the saddle-flaps. He is also weighed *after* the race, to prevent the possibility of his having carried either more or less than his proper weight; a precaution, moreover, that is rigorously observed after every kind of race, whether handicap or otherwise.

Though principally pertaining to horse-racing, handicapping is resorted to in many other sports. In pigeon-shooting from traps, the shooter stands, as a rule, 21 yards from the traps, that being the distance usually allowed to average performers. The more skillful the shooter, the further back has he to stand from the traps; the distance allowed by an acknowledged 'crack' shot to his inferiors ranging from 1 to 10 or even 15 yards. In games such as chess and draughts, certain 'men' are allowed to the inferior player; in billiards, the better of two allows his antagonist a certain number of 'points,' so as to equalise or handicap their respective games; at cricket, an eleven, such as the eleven of All England, will sometimes play against twenty-two others, the competition being at times very close. In swimming and in pedestrianism, the inferior competitors are allowed a certain 'law,' or start; in yachting, the vessel of greater tonnage is handicapped with lesser ones, by allowing them extra time for the performance of the race. For instance, a fifty and a thirty ton yacht start for a race, the former allowing the latter, say, five minutes. They *start together*, and the heavier yacht reaches home, say, three minutes ahead of the lighter; in that case, the lighter yacht's handicap of five minutes gives her the race by two minutes, though she was last to reach home. The principle of handicapping is the same, whether applied to field-sports or horse amusements; it is the art of endeavouring to equalise, by certain penalties, the good, bad, and indifferent.

HANLEY, a town of Staffordshire, England, in the district known as *The Potteries*, and included in the parliamentary borough of Stoke-upon-Trent (q. v.). It is two miles and a half from Newcastle-under-Lyme, about one mile from Stoke, and one mile from the North Staffordshire Railway station and canal offices. The principal portion of the town has an elevated site. The streets are not very regular, but they are wide and well paved; and many of the houses are well built. There are several commodious market-places. There are numerous places of worship of the Church of England and other denominations. Among the public institutions is an infirmary.—Contiguous to H. is *SHELTON*, which may be regarded as forming with it one town. The manufacture of earthenware and china is the principal employment of the inhabitants of both. At Shelton is a villa called *Etruria*, erected by Josiah Wedgwood, remarkable for the Etruscan vases with which it is ornamented, imitations of ancient vases found in Italy, and the study of which was of

## HARAR—HARVEST-FLY.

great use to him in his endeavours to improve the manufacture of earthenware. The pop. of H. in 1871 was 39,976.

**HARAR**, a city of East Africa, in the country of the Gallas, the ancient metropolis of the Hadyah Empire, about 219 miles south-west of Berbera, which lies opposite to Aden, at the mouth of the Red Sea; lat. 9° 20', long. 42° 17'. The city, which is about 5500 feet above sea-level, lies upon the slope of a hill from west to east; in the latter direction are plantations of bananas, citrons, limes, the coffee-tree, the khat—a thine plant well known in Arabia—wars or 'bastard saffron' (safflower), and sugar-cane; westward are gardens and orchards on a terraced slope; northward is a hill covered with tombs; and to the south, the city falls into a valley or ravine. It is about one mile long by half a mile broad. The streets and alleys are like mountain-roads, strewed with rubbish and with heaps of rocks; and the abodes, built of sandstone and granite, cemented with a reddish clay, present a dingy appearance. H. is surrounded by an irregular wall, pierced with five large gates, and defended by rudely-built oval turrets. The men are very unprepossessing in appearance; but the women are much better looking, and appear to be of a different type. The men are engaged in trade; while the women spin, weave, and cultivate the gardens. Morals are very lax, and the people are much addicted to intoxication with mead and Abyssinian beer. The language of the inhabitants is Arabian, mixed with some apparently indigenous African dialect, and is spoken nowhere else. H. is celebrated for sanctity, erudition, and fanaticism, none but the purely religious sciences being studied. The people are extremely bigoted, and hold all foreigners, but particularly Christians, in hatred and contempt. The city is governed by an emir, whose will is law, who demands the utmost obsequiousness from all under him, but who administers his will with a certain amount of rude but prompt justice. Murderers are given up to the nearest kin, and their throats publicly cut with a butcher's knife. H. is essentially a commercial town. It is the grand dépôt for the coffee, the war-dye, the cotton, the gums, the tobacco, and the grain of the Galla country, the produce of which is conveyed to Berbera three times a year in immense caravans. There is also an enormous slave-trade carried on, H. being a rendezvous for slave-caravans from all the surrounding countries. The imports are American cottons, shawls, silks, brass, copper, cutlery, dates, rice, sugar, gunpowder, and paper. Provisions are exceedingly cheap, 120 fowls, according to Burton, being purchased for a dollar, and the same sum sufficing to provide a man with bread for a year. The only coin is a bit of brass, coarsely stamped, equal to the 66th part of a dollar; and the emir imprisons all subjects who possess any other money.

H. was founded by Arab invaders, who, in the 7th c., conquered and colonised the tract between the Red Sea and the Abyssinian mountains. Pop. 10,000, inclusive of a considerable number of Gallas and other Bedouins. It was visited in 1855, at great risk, by the fearless and indefatigable Burton (q. v. in SUPP., Vol. X.), to whose interesting account we are indebted for most of our information.—See Burton's *First Footsteps in Eastern Africa* (Longman, 1856).

**HARELD** (*Harelda*), a genus or sub-genus of ducks of the oceanic section (see DUCK), nearly allied to pochards, scaups, &c.; having a short, thick bill, high at the base, the laminae projecting at the edge of the mandibles, a high forehead, a thick neck, and two feathers of the middle of the

tail in the males greatly elongated; whilst the females have the tail short and rounded.—The **LONG-TAILED DUCK**, or H. (*H. glacialis*), inhabits the arctic regions both of the old and new worlds, remaining on the seas of the north as long as any



Long-tailed Duck, Female and Male (*Harelda glacialis*).

water remains unfrozen, and then betaking itself to more southern regions. It is plentiful, during winter, in the inlets of Orkney and Shetland, but is rather rare in the southern parts of the British Islands. It is sometimes brought to the London market. Its winter migrations in America extend as far south as Texas. The male, particularly in its summer plumage, is a very beautiful bird. It is about 17 inches long, without the long tail-feathers; with them, 22 or 24. It is a very lively and noisy bird; flies swiftly, and is a most expert diver. It lines its nest with down, which is said to be equal to that of the eider, but has not yet become an article of commerce.

**HAROLD'S CROSS**, a village-suburb of Dublin, situated on the Grand Canal, three miles south-by-west from the centre of the city, and now included in Rathmines and Rathgar township. It is built nearly in the form of a square, within which lies a spacious green, anciently the scene of periodical village festivals. It is the seat of a cotton-factory; and although the village is poor, there are many handsome villas in the vicinity, as also the handsome cemetery of Mount Jerome. H. C. also contains two convents of nuns, to which are attached free schools for the female children of the village.

**HARVEST-FLY**, the popular name in the U. S. for species of *Cicada* (q. v.) which are common in that country, and make their appearance as winged insects in the season of harvest. *C. septemdecim* is called the *Seventeen Years' Locust*, from a popular belief that



Harvest-fly (*Cicada septemdecim*).

it lives for that period in its larval state, a belief which seems to have arisen from the appearance of these insects in unusual numbers at intervals of about seventeen years. Its colour is black, the

wings and wing-covers veined with orange red. Near the tips of the wing-covers there is a dusky zigzag line in the form of the letter W, on account of which the appearance of this fly in great numbers is superstitiously regarded as indicative of approaching war.

**HAUPUR**, a town of British India, in the North-west Provinces, in the district of Meerut, 20 miles south of the town of that name. It is of considerable size, and had a population in 1871 of 14,294. Government has a breeding-stud here, which has obtained celebrity for the character of the horses passed into the different branches of the service.

**HAWKS, FRANCIS LISTER, D.D., LL.D.**, American clergyman and author, was born at Newbern, North Carolina, June 10, 1798; educated at the university of North Carolina; admitted to the bar in 1817; in 1819, elected to the state legislature; but being drawn to the church, he was ordained, in 1827, a clergyman of the Episcopal Church, and was engaged at New Haven, Philadelphia, and St Thomas's Church in New York, until 1843. During this period he was appointed historiographer of the Episcopal Church in America, and visited England in search of documents. In 1837, he founded, with Dr Henry, the *New York Review*, and established St Thomas's Hall, a high school, at Flushing, Long Island, which involved him in heavy pecuniary liabilities, charges based upon which were brought against him on his election in 1843 as Bishop of Mississippi. He was acquitted of the charges brought against him, but declined the bishopric. In 1844, he became rector of Christ's Church, in New Orleans, and president of the university of Louisiana. In 1849, he declined the bishopric of Rhode Island, and became rector of Calvary Church, New York. In this busy career he published *Reports of the Supreme Court of North Carolina* (4 vols., 1823—1823), *Contributions to the Ecclesiastical History of the United States* (2 vols., 1836—1840), *Egypt and its Monuments* (1849), *Auricular Confession in the Protestant Episcopal Church* (1850), a translation of Rovero and Tschudi's *Antiquities of Peru* (1854), and edited the papers of General Alexander Hamilton, biographical works, several juvenile books, *Commodore Perry's Expedition to the China Seas and Japan in 1852—1854*, and a portion of a *History of North Carolina*. He died in New York, September 27, 1866.

**HAYES, AUGUSTUS ALLEN**, American chemist, was born at Windsor, Vermont, February 28, 1806; educated at the military academy in his native town; studied chemistry under Professor Dana of Dartmouth College; and in 1825, distinguished himself by his researches into the proximate elements of American medicinal plants, discovering the organic alkaloid Sanguinaria; and in 1827, investigated the compounds of chromium. In 1828—having removed to Boston—in connection with the growing manufactures of New England, he devoted himself to the chemistry of commerce, of dyeing, and the manufacture of copper and iron. His numerous papers were published in the *Proceedings of the Boston Society of Natural History*, *American Journal of Science*, *Annual of Scientific Discovery*, &c. In 1837, his investigations into the generation of steam and economy of fuel, led to the construction of improved furnaces and boilers. He also discovered the process of reducing pig to malleable iron without loss by the use of the oxides of iron; new processes in copper-smelting, the decomposition of alcohol, and formation of chloroform; and the oxidation of alcohol in the human system. As state assayer of Massachusetts, and in the employ of the Federal government, he made important investigations into the

properties of guano; examined the constitution of sea-water at various depths, and its effects on the copper-sheathing of vessels; and by a series of useful studies and experiments has added to the national wealth and the domain of science.

**HAYES, ISAAC I., M.D.**, American explorer, was born about 1830, educated to the medical profession, and appointed surgeon to the Arctic expedition under Dr Kane, with which he returned to the United States in 1855, convinced that there existed an open sea around the north pole, and anxious to head an expedition for its exploration. In this project he was aided by Mr Henry Grinnell, by the American Geographical and Statistical Society, and by Sir R. I. Murchison and the Geographical Society of London. In June 1860, he fitted out a schooner of 133 tons, and sailed from New York; July 6, 1860, penetrated to 82° 45' N. lat., making extensive explorations and observations of the coasts and their inhabitants, and returned to Boston October 1861. In 1867 he published *The Open Polar Sea, a Narrative of a Voyage of Discovery toward the North Pole, in the Schooner United States*; in recognition of which he was awarded a gold medal by the Royal Geographical Society of London, and a similar honour by the Geographical Society of Paris. In 1869 H. again visited Greenland, and explored the southern coasts of that country.

**HEDGEHOG PLANT**, a name given to those species of medick (*Medicago*) which have the pods spirally twisted and rolled up into a ball, beset with spines. The peculiar appearance of the pods makes them objects of interest, on which account they sometimes find a place in flower-borders; and like the other Medicks (q. v.), they are useful in the countries in which they abound, as affording excellent food for sheep and cattle. They are particularly plentiful on sandy grounds near the sea in some parts of South America, and their pods are too plentiful in the South American wool imported into Britain.

**HELIOTYPOGRAPHY** (otherwise *Photoheliography*; from Gr. *helios*, the sun). Mr De la Rue, in the Observatory at Kew, has produced, on sheets of paper, pictures in which the solar spots are represented without the aid of drawing or engraving of any kind. In one form of operation (noticed in the *Proceedings of the Royal Astronomical Society*), the sun's spots were viewed through a Newtonian reflector of 18-inch diameter, and 10 feet focal length, producing an image that would have made the sun's disc three feet diameter. By a nice adjustment, the image of a portion of the disc was received on a glass-plate rendered sensitive by collodion. The first part of the process was then complete—the sun painting a picture of his own spots on a piece of glass. Then came the transfer of this negative to a positive, by the usual photographic means of printing, but with a varnish of very complex chemical nature on the positive plate. This completed the second stage—photography producing a very faint picture on the positive plate. Then came chemistry: by dissolving away certain constituents of the varnish, which had been more affected than the rest by the actinic force of the sun's light, the surface of the positive plate became a series of ridges and hollows, *relievi* and *intagli*, extremely minute in their differences of level, but still sufficiently marked to convey the notion of a kind of engraving. Next came electrotype, or galvanography. The plate, in the state just described, served as a matrix or foundation on which an electrotype cast could be taken. By Pretsch's process, this cast may be so varied as to be available either for surface-printing or for printing on the

copper-plate plan. Other solar phenomena, such as the corona, and the appearance presented during annular and total eclipses, have been made to reproduce themselves in a similar way. See also PHOTOGRAPHIC ENGRAVING and PHOTOGRAPHY.

**HELMET-SHELL** (*Cassia*), a genus of gastropodous molluscs of the family *Buccinidae*; the animal much resembling the common Whelk (q. v.), with which it also nearly agrees in habits; the shell swollen, rather thick and solid, with bold ridges, a short spire and a long aperture, the outer lip toothed, the canal recurved. The species, which are pretty numerous, are all natives of tropical seas. Most of them are beautiful; and they are used by engravers for making cameos, the differently coloured layers producing exquisite effects when skillfully cut.

**HELMOND**, a town in the Netherlands, province of North Brabant, lies 21 miles south-east from Bois-le-Duc, on the Aa and South Willemvaart. It has a good haven. The principal industries are the manufacture of cotton, woollen, and linen fabrics, cotton-printing, dyeing, calendering, beer-brewing, &c. The pop. is nearly 7000.

**HELSINGBORG**, an ancient fortified seaport town of South Sweden, 33 miles north-north-west of the town Malmö, on the Sound, opposite Elsinore. Steamers leave H. almost daily for Copenhagen, Malmö, Elsinore, and other places. There is a good harbour. Earthenware and iron goods are manufactured. Pop. about 6600.

**HEMP PALM** (*Chamærops excelsa*; see **CHAMÆROPS**), a palm of China and Japan, the fibre of the leaves of which is much employed in these countries for making cordage. Hats are also made of its leaves, and even cloaks and other garments for wet weather.

**HENLEY-ON-THAMES**, a town of Oxfordshire, England, on the left bank of the Thames, 35 miles west from London. The Thames is here crossed by a handsome bridge. H. is on a branch of the Great Western Railway. There are several charities, and a reading-room and valuable library, open to all ratepayers, bequeathed by Dean Aldrich of Henley, who died in 1757. Malting is a principal branch of industry; there are also breweries; and there is a considerable trade in corn, flour, and timber. Pop. (1871) 4523.

**HERI, HERI-RUD**, or **HURI**, a river of Central Asia, which rises in the Hindu Kush Mountains, about 150 miles west from Cabul, pursues a western course through Afghanistan, for more than 300 miles through a fertile and beautiful valley, in which stands the city of Herat (q. v.); then bending suddenly to the northward along the boundary between Persia and Turkestan, and afterwards north-west through Turkestan, it has a further course of fully 400 miles, till it terminates in the swamp of Tejend, 150 miles to the east of the Caspian Sea. After entering Turkestan, the H. soon begins to lose its water in the sand of the desert, and the latter part of its course for hundreds of miles is dry, except at certain seasons of the year.

**HERMES, GEORGE**, a Roman Catholic philosopher and divine of Germany, whose system has been the occasion of a long and acrimonious controversy, was born at Dreyerwalde, in the diocese of Paderborn, in Westphalia, April 22, 1775. Having received his early education from his parish priest, H. entered the gymnasium of Rheina, and thence was transferred, in 1792, as a theological candidate, to the university of Münster, where he speedily distinguished himself, as well by his ability and

acuteness, as by his piety and exemplary life. In 1798, he was appointed Professor in the gymnasium of Münster; and after nine years, he was named Professor of Theology in the university of the same place. His lectures being of a popular character, and addressed mainly to the examination of the modern philosophical systems, and thus bearing on revelation, attracted many hearers, and established for H. a high reputation in Germany; and when, in 1819, the new mixed university of Bonn was established, H. was appointed to a professorship of theology. His early reputation attended him here, and students flocked to his lectures from all parts of Germany, and even from the Low Countries. In this office he continued until his death, which occurred May 26, 1831.

The great object which H. appears to have proposed to himself was to counteract the influence of the philosophical systems, which, when he entered on his career as a professor, were in the enjoyment of their full popularity, and especially that of Kant; and with this view, he sought to deduce the foundations of all philosophical inquiry from the same first principles from which the Kantian philosophy takes its departure. His system, therefore, presupposes in the mind, as the starting-point of all rational inquiry, a blank condition, which, as variously described by friends and enemies, is either simply the absence of all previous conviction, or a state of positive doubt, analogous to the so-called Pyrrhonism of the ancient schools. The Hermesian method of investigation, in like manner discards, in the first stages, and so far as investigation is permitted to extend, all principle of authority; and in the details of metaphysical inquiry, in the selection of the arguments of the existence of God, and of the nature of divine attributes, he departed widely from the old text-books of the schools; although in the general sum of the doctrines of the Roman Catholic Church, his orthodoxy does not appear to have been in any degree called into question. The objections which arose lay rather against his method than against its actual doctrinal results.

It is remarkable, too, that although his work, *Einführung in die Christ-Katholische Theologie* (Introduction to Christian-Catholic Theology), was published in 1819, and again in 1831, it was not until after H.'s death that the controversy regarding his system took a definite form, and eventually, at the instance of Clement Augustus Droote-Vischering, Archbishop of Cologne, was referred to Rome. It would be out of place here to enter into the particulars of the controversy which ensued, the chief assailant of the system being a learned Italian professor of the Collegio Romano, the Jesuit, Father Perrone; while its defenders were almost exclusively Germans, most of them H.'s own friends and pupils. The controversy was a very protracted one; and a very large, although, it must be confessed, excessively dull and misty literature, has grown out of the subject. It will be enough to say, that after a protracted examination, the doctrine of H. was condemned by a brief, dated September 26, 1835. The German partisans of H., who had at their command a theological journal of considerable circulation, the *Journal of Bonn*, protested from the first against this condemnation, to which they applied, at least practically, the well-known distinction of 'fact' and 'right,' which had been long ago employed by the Jansenists; contending, that although the doctrines contemplated by the brief were rightly condemned, as being unsound and untenable, yet no such doctrines were taught by H., or contained in his book. Two of the leaders of the party, Professors Braun and Elvanich, went to Rome to urge a reconsideration of the condemnatory decree; but their

mission was unavailing, and the decision was ordered to be enforced without reserve. The Archbishop of Cologne accordingly insisted on unqualified submission; and the troubles which arose from the opposition which he encountered, tended much to complicate the difficulties of a conflict which arose between him and the Prussian government, as to the question of 'mixed marriages,' and which led eventually to his arrest and deprivation by the crown. The controversy was continued, as well in Rome as in Germany, for a considerable time; by degrees, however, the Hermesian party fell away. The professors of various universities, individually or in bodies, accepted the papal condemnation; and although some have still persevered in their resistance down to a comparatively late period, they have been almost exclusively of that extreme party, many of whom openly seceded from Rome, under the name of the German Catholic Church, and whose principles go even beyond orthodox Lutheranism, and may be regarded as verging on the most advanced borders of Rationalism.

**HERMOSILLO**, a city in the north-west of Mexico, in the state of Sonora, on a river of the same name, about 60 miles east from the Californian Gulf, and 90 north of the port of Guaymas. The town lies in a valley, 10 miles long by 4 broad. The climate is dry and very hot, but the place is nevertheless considered healthy, being free from the epidemics which often accompany very high temperatures. The valley is very fertile, and produces grapes, melons, figs, oranges, limes, lemons, citron, peaches, and pomegranates in great abundance. The vine, however, is the principal object of cultivation, not less than 1500 barrels of brandy being annually made. The town has a large trade with Guaymas, being the principal entrepôt for the trade with the interior. Pop. about 18,000, including about 3000 Yaqui Indians, who are the labourers of the town.

**HERRING, VANCOUVER ISLAND** (*Meletta cerulea*), a fish of the same family with the herring, and much resembling it both in appearance and otherwise. The genus *Meletta* differs from *Clupea*, to which the herring belongs, chiefly in having no teeth, except that name may be given to a rough band on the tongue. The Vancouver Island herring abounds on the north-western coast of North America. It is generally about ten inches in length. Its colour is bright steel blue, shading away on the sides to brilliant silvery white, the fins yellowish white. Immense shoals of these herrings appear on the coast at different seasons from February to July; often pursued by dogfish, so that fleeing from the enemy, they even rush upon the shore, where great numbers die among the pebbles. They afford a chief part of the sea-harvest of the Indians, who take them by various means—by the rake, such as is used for the Candle-fish (q. v.), for the shoals often so fill the water that it may be employed; by hand-nets; and by long dams of lattice-work, along the outside of great mud-flats left dry by the retiring tide. The spawn of this fish is also a favourite article of food of the Indians, and is obtained by placing great quantities of fir branches in the mud over the flats, within the dams used for catching the herring. The spawn gets entangled among the branches, and is removed to be dried in the sun. Great numbers of the herring caught by the Indians are used only for the extraction of oil. The Vancouver Island herring seems likely to acquire a great commercial importance.

**HERZ, HENRI**, a pianist and composer for the pianoforte. He was born, of Jewish parentage, at Vienna, in 1806, and educated principally in

Paris, where his talent was early recognised; and his compositions became popular over Europe. He was received with great applause on visiting England in 1834, and America in 1846. In 1837, he received the decoration of the Legion of Honour; and in 1843 he became professor of music at the Conservatoire. In 1865, he published, in the *Moniteur*, *Mes Voyages en Amérique*. He also carries on the business of a piano manufacturer. H.'s music is characterised by elegance and a certain originality, and holds an important place among works written for the pianoforte.

**HEYWOOD**, a large and populous town of Lancashire, England, 8 m. N. of Manchester, on the left bank of the Roach, a branch of the Irwell. It is connected with the Rochdale Canal by a branch canal; and it is on the Lancashire and Yorkshire Railway. H. has recently increased with great rapidity, both in population and wealth, partly in consequence of extensive coal-mines in the neighbourhood, and partly through manufactures of various kinds. It has become an important seat of the cotton manufacture. Fustians, calicoes, nankeens, ticks, and other cotton fabrics are produced. Iron-founding, boiler-making, and the manufacture of power-looms are also extensively carried on. Pop. (1871) 21,248.

**HILDEN**, a town of Rhenish Prussia, nine miles east-south-east from Düsseldorf, on the Itterbach. It is a rapidly-increasing place, with woollen and linen manufactures. Pop. (1871) 6342.

**HILVERSUM**, a beautifully situated village in North Holland, lies 15 miles south-east from Amsterdam, in the midst of undulating corn-fields, variegated with woodlands. The chief industries are agriculture, the manufacture of strong striped white cottons, carpets, and horse-cloths, spinning and dyeing wool. There are two public schools, with 600 pupils, an institute for young ladies, and another for young gentlemen, a Reformed Church, a Roman Catholic Church, and a Jewish synagogue. Pop. about 6300.

**HINDLEY**, a town of Lancashire, England, three miles south-east from Wigan, with which it is connected by railway, on the Manchester Road. Its growth has of late years been rapid. There are numerous coal-works in the vicinity; cotton-spinning and the manufacture of cotton goods are also extensively prosecuted. There are places of worship belonging to the Church of England, and to a number of other denominations; a free grammar-school, and numerous other schools. Pop. (1861) 8477; (1871) 10,627.

**HIPPOPHAGY** (Gr. *horse-eating*). The adoption of horse-flesh as food for man has at various times occupied the attention of physicians. That semi-civilised nations eat horse-flesh is well known. Witness Sir John Chardin's Account of the Crime-Tartars. In Spain, a banquet, comprising roasted horse-flesh among the viands, was given in the time of Charles V.; and foal's flesh is eaten in some of the hill districts at the present day.

In 1855 and 1856, there was a good deal of discussion in Paris relative to the formal introduction of horse-flesh into the meat-markets. M. Geoffrey St Hilaire delivered a lecture declaratory of the wholesome character of this food; and some of the more enthusiastic advocates of the plan formed themselves into a so-called Hippophagic, or Horse-eating Society. The French are famous for their skill in so modifying the operations of cookery as to obtain as many varieties of flavour as possible with any and every kind of meat; and this skill was exercised abundantly in disguising (if not removing) the somewhat coarse taste and odour of horse-flesh. The journals of the time spoke of banquets held by

the Hippophagi, in which the principal dishes were horse-flesh, variously cooked and diversified.

In 1866, there was official recognition of the introduction of this kind of food into the market, under such restrictions as were deemed suitable. According to a statement in the *Journal of the Society of Arts*, the Prefect of the Seine issued an ordonnance in June of that year, recognising horse-flesh as human food, establishing special slaughter-houses or abattoirs for it, and laying down detailed regulations. No ordinary horse-slaughterers, but only those specially appointed, are to engage in the trade. The animals are to be killed in presence of a veterinary inspector, who is also to stamp or seal every distinct joint of meat after inspection. Unhealthy horses are excluded from the supply; they may be old, and worn out for work, but still healthy (the supply mostly comes from Normandy). All restaurateurs who use horse-flesh in their potages, bouillies, &c., are to acquaint their customers distinctly with the fact. Within a few weeks after the issue of the ordonnance, there were establishments for horse-flesh bouilli and soup, and others for horse-flesh sausages, in Paris, avowedly sanctioned by the authorities. The decision pronounced upon the better portion of horse-flesh, by the medical men of Paris, is, that it bears some such relation to ox-beef as brown bread does to wheat—quite as wholesome, but not so pleasant in taste. During the French International Exhibition of 1867, some of the humbler restaurants of Paris made great use of horse-flesh; so that when, during the siege of Paris in 1870—1871, horse-flesh was so extensively used as food, it was by no means a novelty to the Parisians.

In London, a dinner was given, in 1868, to 160 guests at the Langham Hotel, to test the qualities of horse-meat. It was devised by Mr Bicknell, cooked by M. Castel, and presided over by Mr Forsyth, Q.C. Known by their French names, the horse element in the dishes comprised 'consommé de cheval,' 'huile hippophagique' (as a sauce for sole), 'terrines de fois maigre chevalines,' 'saucissons de cheval,' 'aloyau de cheval faroi,' 'culotte de cheval braisée,' 'petits pâtés à la mœlle Bucéphale,' 'poulets garnis à l'hippogriffe,' 'langues de cheval,' 'gelée de pied de cheval au Marasquin,' 'zéphirs sautées à l'huile chevaleresque,' 'gâteau vétérinaire.' Under plain English names were collared horse-head, a baron of horse (weighing 280 lbs.), and boiled withers. In most of the French dishes the taste of horse was almost hidden by condiments, &c.; but in the baron it was left nearly unchanged—something between beef and venison. The best was done that could be done; but hippophagy does not seem to be any more popular in England than before that experimental banquet was given.

During 1866 and 1867, the Parisians did not avail themselves largely of the official permission to establish abattoirs and shops for the sale of horse-flesh; but by the beginning of 1868 there were twenty butchers' shops in which nothing but horse-flesh was sold; and thus the sale had become considerable, at prices far below that of beef. During the siege of Paris by the Germans, in the later weeks of 1870 and early in 1871, the magnificent Halles Centrales displayed more horse-flesh than any other kind of food. Horse-broth formed the basis of all the soups, even at the most expensive hotels and restaurants. A horse-steak at an ordinary restaurant was charged four francs.

There has been something achieved also in France in feeding poultry with this kind of diet. One establishment was described, in 1864 (in the *Journal* above quoted), as covering 30 acres, furnishing accommodation for 100,000 pullets at one time.

The horses were slaughtered in abattoirs built for the purpose; the hides, hoofs, heads, marrow, bones, hair, intestines, tendons, and blood were sold to various manufacturers; the flesh was boiled, and chopped into small pieces as poultry food; and the refuse was saleable as a rich manure.

HITCHIN, a town of Hertfordshire, England, 14 miles north-west from Hertford, on the Hiz, a branch of the Ivel, and feeder of the Ouse, 420 feet above the sea. It is a station on the Great Northern Railway, and from it important lines of railway branch off to Bedford and other places on the north-west, and to Cambridge, &c. on the north-east. The town is irregularly laid out, but generally well built, with spacious streets. The principal trade is in corn, malt, and flour. There are several large breweries. Many females are employed in straw-plaiting. There are lavender farms in the neighbourhood. H. was a place of some consequence in the days of King Alfred. Pop. (1871) 7630.

HOAZIN, or TOURACO (*Opisthocomus cristatus*), a bird nearly as large as a peacock, which it somewhat resembles in its gait and manners; a native of Guiana and Brazil; generally referred by



Hoazin (*Opisthocomus cristatus*).

naturalists to the family *Cracidae* (with curassows and guans) and the gallinaceous order; but by some regarded as of the order *Insectorae*, and as allied to the plantain-eaters. Its anatomy is remarkable: it has an enormous crop, whilst the gizzard is very small. It is gregarious, and frequents marshy situations.

HOFFMANN, ERNEST THEOD. AMADEUS, properly WILHELM, one of the most original German story-tellers, was born 24th January 1776, at Königsberg in Prussia. He studied law there, and then found employment in the government offices at Grossglogau and in Berlin. In 1800, he became assessor to the government in Posen; but in consequence of some able caricatures of his, which General Zastrow and others in high positions applied to themselves, he was removed in 1802, as councillor, to Plock, and 1803, in the same capacity to Warsaw, where the entrance of the French ended his career. Without prospects or fortune, he made use of his knowledge of music as a means of livelihood, and, though sometimes reduced to great straits, managed to support himself by giving music-lessons, and by contributing to the *Musical Gazette* of Leipzig. In 1813, he went to Dresden as music director to a company of players alternating between Dresden and Leipzig, and continued to conduct the orchestra of the company till 1815. In 1816, he was again appointed by Prussia to be councillor in the Royal Supreme Court of Judicature at Berlin, where, before long, he was seized with a disease in his back,



the consequence of his irregular life, and after much suffering, died 24th July 1822. From his youth, he had devoted all his leisure hours to the study of music. In Posen, he brought Goethe's vaudeville, *Scherz, List, und Rache*, on the stage, and composed at Warsaw the music for numerous pieces at other theatres. The request for a collection of his compositions which had appeared in the *Musical Gazette*, induced him to publish his *Phantasiestücke in Calcol's Manier* (4 vols. Bamb. 1814; 3d ed. 2 vols. Leip. 1825). These were followed by *Élixir des Teufels* (Berl. 1816), *Nachstücke* (2 vols. Berl. 1817), and *Die Scrapionsbrüder* (4 vols. Berl. 1819—1821, along with a supplement, 1825, containing H.'s last stories); *Lebensansichten des Kater Murr* (Views of Life, by Kater Murr, 2 vols. Berl. 1821—1822), *Der Doppelgänger* (The Double-goer, Brunn, 1824), and a few shorter stories. H. was a man of thorough originality, and gifted with the rarest talents; wild, licentious, and yet an excellent man of business and lawyer, who performed the duties of his office well. He had a keen understanding, which speedily detected the weaknesses and absurdities of everything. At the same time he showed himself full of fantastic ideas, and a believer in demons. His character was made up of incongruities: he was bitterly sceptical, and yet visionary to insanity; epicurean to effeminacy, and stoical to rigidity. Between these contradictory extremes range his novels, which, like his whole character, betray something diabolical. In his humorous flights, he reminds us of Jean Paul, whom he perhaps surpasses in real interest and in inventive power, but whom he falls far short of in depth of humour, purity, and power of language. H.'s fancy revelled in mysterious caricatures, presenting a frightful contrast between jest and earnest. The wonderful apparitions which he introduced into his stories, as taking part in daily life, were part of his ordinary way of thinking. However, although these fantastic creations are often amusing and interesting, it is neither on these nor on his larger novels, so often wild and odd, that his fame rests, but more on his novelettes, which are masterpieces in miniature, such as *Meister Martin und Seine Gesellen*; *Das Majorat*; *Fräulein Scudry*; *Doge u. Dogaresse*; &c., which are not mixed up with spectral machinery. H.'s talents were most wonderfully various; he not only distinguished himself as a poet and composer, but as an able sketcher of caricatures; and many of the most popular caricatures of Napoleon were from his pencil. He handled language in a masterly way, although not free from mannerism. A collection of his choice works, *Ausgewählte Schriften*, appeared in Berlin (10 vols., 1827—1828). His widow, Micheline, born Rover, added five supplementary volumes (new ed. Stuttg. 1839). There is an excellent biography of H. by his friend J. E. Hitzig, in his work *Aus H.'s Leben und Nachlass* (2 vols. Berl. 1823). In foreign countries, particularly in France, H. has been repeatedly translated and imitated.

HOFFMANN, AUG. HEINRICH, commonly called HOFFMANN VON FALLERSLEBEN, a distinguished German poet and meritorious philologist, was born 2d April 1798, at Fallersleben, in the district of Luneburg, where his father was a merchant and burgomeister. Having received his elementary education in Helmstedt and Brunswick, he went, in 1816, to the university of Göttingen, which, in 1819, he left for Bonn. He soon gave up theology, which his father had destined him to, and occupied himself exclusively with philological and literary studies, which, from his first acquaintance with the Brothers Grimm (1818), turned more and more to his native language and literature. After travelling through the Rhine countries and Holland in search

of popular poetry, and living for some time in Berlin, he was made keeper of the university library of Brealau in 1823, Extraordinary Professor of the university there in 1830, and Ordinary Professor of the German Language and Literature in 1835. The publication of his *Unpolitische Lieder* (Unpolitical Lays) led to his being deprived of his office, 20th December 1842. For some years afterwards, H., thrown entirely upon literary work for his support, led a wandering life through the whole of Germany, Switzerland, and Italy, the subject of laudation on the one hand, or of vituperation on the other, and at times kept under the surveillance of the police. In 1845, he was naturalised in Mecklenburg. Restored to his rights in Prussia 1848, he drew from that time his statutory salary as a pension. He married in 1849, and settled on the Rhine, first in Bingerbrück, then, 1851, in Neuwied, until, in 1854, he went to Weimar, and for some years edited the *Weimar Annual*. In 1860, he became librarian at the Duke of Ratibor at the castle of Korvei, on the Weser, where he died in 1874. H.'s literary productions are partly scientific, partly poetical. Through the first, he ranks among the most distinguished investigators in the department of German language and literature. The following writings deserve special mention: *Horæ Belgicæ* (vols. 1—8, Leip. and Berl. 1830—1837); *Reineke Vos* (Berl. 1834, 2d ed. 1852); *Monumenta Etkonenensia* (Gent. 1837); *Geschichte des Deutschen Kirchenlieds bis auf Luther* (History of German Hymnology, Breal. 1832, 2d ed. 1853); *Altddeutsche Blätter* (Old German Fragments, 2 vols. Leip. 1835—1840); *Politische Gedichte aus Deutscher Vorzeit* (Political Poems from German Antiquity, Leip. 1843); *Deutsche Gesellschaftslieder des 16 und 17 Jahrhunderts* (German Social Songs of the 16th c. and 17th c., Leip. 1844); *Spenden zur Deutschen Literaturgeschichte* (Contributions to the History of German Literature, 2 vols. Leip. 1845); *Theophilus* (Han. 1853); *Die Deutsche Philologie im Grundriss* (German Philology in Outline, Berl. 1836). H.'s own poetry has a close alliance to popular song, and hits the tone of genuine simplicity, tenderness, and pathos to a degree that scarcely any other poet of recent times has succeeded in doing. Many of these songs actually circulate among the people from mouth to mouth. It is also remarkable that H., although not a cultivated musician, set his songs to the most delightful tunes himself, which only require artistic finishing. His juvenile songs are especially charming; his love-songs are not less tender; and his poetical pictures of the life and way of thinking of the German people, such as the drinking and rustic songs, are unique in their kind. The following collections may be particularly mentioned: *Allemannische Lieder* (Allemannic Songs, 5th ed., Manh. 1843); *Gedichte* (Poems, 2 vols. Leip. 1834, 6th ed. Han. 1864); *Rheinleben* (Rhine-life, Mainz, 1851; Neuwied, 1865); *Soldatenlieder* (Soldiers' Songs, Mainz, 1851); *Fünfzig Kinderlieder* (Fifty Children's Songs, Leip. 1843); *Fünfzig neue Kinderlieder* (Fifty New Children's Songs, 1845); *Viersig Kinderlieder* (Forty Children's Songs, 1847); *Deutsches Volksesangsbuch* (German Popular Song-book, 1848). Of a different kind, but also popular by their airs, are the *Unpolitische Lieder* (Unpolitical Lays, 1840—1841), which excited great attention. With these are connected *Deutsche Lieder aus der Schweiz* (Swiss German Songs, 1843); *Deutsches Liederbuch* (German Song-book, 2d ed. 1850). He wrote an autobiography in 6 vols. (*Mein Leben*, 1862—1868).

HOG-GUM, the name given in the West Indies to a resinous substance, which is there extensively used as a substitute for pitch, to tar boats and ropes, also for strengthening-plasters, &c., and

internally as a diuretic, laxative, and stimulant medicine. It is still disputed what tree produces the true hog-gum; some ascribing it to *Moronoba coccinea*, of the natural order *Guttifera*; some to *Rhus metopium*, a species of sumach, of the order *Anacardiaceae*; and some to *Helwigia balsamifera*, of the order *Amyridaceae*. The probability seems to be that all these—and perhaps other—trees yield resinous substances of very similar quality, and commonly designated by the same name.

**HÖHESCHEID**, a town of Rhenish Prussia, 17 miles east-by-south from Düsseldorf. It has extensive lead-works and iron-works. Pop. (1871) 9654.

**HOLLOW-WARE**. There are two classes of iron goods so called—viz., cast-iron hollow-ware, and wrought-iron hollow-ware. Both kinds include cooking and other vessels for domestic use, and comprise also some other articles, such as coffee-mills, which are moulded and finished in a similar way. Wrought-iron hollow-ware is largely made by the process of Stamping (q. v.), but a great deal is also made by the older way of joining pieces together. Vessels of this kind not intended for cooking are generally coated with zinc, while those which are, have usually a coating of tin. Both metals are put on the iron by immersion. There is also a process in use for coating the surface with silicious enamel, which will be described presently. Since the introduction of these methods of protecting and beautifying the surface of iron, domestic vessels of this metal have greatly taken the place of those made from copper and brass.

Cast-iron hollow-ware is finished in three ways—some of it is enamelled, some tinned, and some of it is left black, or untinned; but there is comparatively little of the last now used. The process by which tinned hollow-ware is made was patented by Jonathan Taylor, a Birmingham workman, in 1779. It is conducted as follows: A vessel, such as a saucupan or goblet, is cast in a mould prepared in the ordinary way from an iron or a brass pattern. See **FOUNDING**. The vessel is then Annealed (q. v.), so as to soften the cast-iron preparatory to turning, and such articles are then turned quite smooth on the inside, by means of a common lathe when they are circular, and by an oval lathe when they are oval like fish-pans, a workman holding and directing the tool in both cases. Self-acting lathes have been tried, but hitherto without any saving in the cost. The operation of tinning follows next, and is performed by the workman pouring small quantities of melted tin on the inside of the vessel, which he rubs on with a piece of cork, gradually going over the whole surface. A little sal-ammoniac is thrown in during the process to make the tin adhere. Handles of malleable iron are then put upon such vessels as require them, and a final finish is given to them by coating the outside with a black varnish which is dried in a stove. The covers of saucupans are made of tin-plate, those for tea-kettles of cast-iron.

With respect to the enamelling of cast hollow-ware, a patent was taken out for this as far back as 1799; but the process then introduced, in which the enamel contained lead and tin, was ultimately abandoned. The subsequent patent of Messrs T. and C. Clark of Wolverhampton, taken out in 1839, has been more successful. Their enamel is applied to the cast-iron in two coatings, one of which forms the body of the enamel, and the other the glaze, both being free from metallic oxides. It is especially desirable to avoid the oxide of lead, as it does not resist the action of acid substances in culinary operations. As iron, in common with most metals, differs from any vitreous enamel in the rate

of its expansibility by heat, there is of course a difficulty in securing the permanent adhesion of the two substances, especially with such an article as a cooking-vessel. In the case of cast-iron vessels, however, the difficulty has been practically overcome.

In England, cast hollow-ware is made chiefly in the Midland hardware district, of which Birmingham and Wolverhampton are the centres. Eight manufactories make tinned, and two enamelled hollow-ware. A few more make the black or untinned kind. About 2500 hands are employed, and the quantity of materials annually consumed is estimated at 12,000 tons of pig-iron, 1000 tons of wrought-iron, 177 tons of tin, and 23,000 tons of cooke and coal. In Scotland, there are six manufactories of tinned hollow-ware—that of the Carron Company, whose goods have long been famous; the Shotts Iron Company; the Falkirk Iron Company; and three in Glasgow. Wrought-iron hollow-ware is made principally in Birmingham and the surrounding district, and the number of hands employed upon it is probably nearly the same as for cast-iron goods of this kind.

English hollow-ware is sent to most civilised countries, but for export trade the best markets are found in the British colonies. Little or none is taken by France, and scarcely any by the United States since the outbreak of the civil war, on account of the high duties.

With regard to the comparative merits of the different varieties of hollow-ware, there is no doubt that the kind made of enamelled cast-iron is, on the whole, the best for cooking purposes, although it is about one-fifth dearer than when merely tinned, and is, moreover, not liked by cooks for any but small-sized vessels, on account of its being somewhat heavy. Enamelled wrought-iron cooking-vessels are much lighter to handle, but then upon them the enamel does not stand nearly so well, very probably because the comparatively rapid heating up of the thin iron of which they are made, more rapidly destroys the adherence of the two substances. A great deal of cast-iron tinned hollow-ware is now made without being turned, an omission easily detected by the uneven surface which the inside of such vessels presents. Articles so finished are, of course, cheaper than when they are smoothed on the lathe; but for look, durability of the tinned surface, and least trouble of cleaning, those which are turned are decidedly preferable.

**HOLY FIRE**, in the Church of Rome, a light kindled at Easter, by sparks struck from a flint, in remembrance—according to the missal—of Christ as the great corner-stone, and hailed by kneeling ecclesiastics with the words 'Light of Christ' (*Lumen Christi*). The ceremony takes place on Holy Saturday, of which day's service it forms a striking part; and at Rome, it takes place in the presence of the pope himself; all the lights in the chapel having been previously extinguished, to be rekindled at the new fire.—The kindling of the Holy Fire in the Church of the Holy Sepulchre at Jerusalem, at the Easter of the Oriental Church, is represented as miraculous. The Greek and Armenian clergy combine on this occasion, and amidst processions, solemnities, an excited multitude, and scenes disgraceful not only to the name of religion but to human nature, the expected fire makes its appearance from within an apartment in which a Greek and an Armenian bishop have looked themselves.

**HOP FROTH-FLY**, or **HOP FROG-FLY** (*Amblycephalus interruptus*), a species of Froth-fly (q. v.) which sometimes appears in great numbers in

hop-grounds, and does considerable mischief. The perfect insect is about a quarter of an inch long, of a yellow colour, variegated with black. It frequents hedges and grassy places as well as hop-plantations.

**HÖRDE**, a town of Prussian Westphalia, on the Emsche, 33 miles south from Münster, with which it is connected by railway. Near it are productive coal-mines, and the town has recently increased with great rapidity. Nail-making is carried on. Pop. (1871) 12,268.

**HORNBOOK**, the primer or apparatus for learning the elements of reading, used in England before the days of printing, and common down to the time of George II. It consisted of a single leaf, containing on one side the alphabet large and small, in black-letter or in Roman, with perhaps a small regiment of monosyllables. Then followed a form of exorcism and the Lord's Prayer, and as a finale, the Roman numerals. The leaf was usually set in a frame of wood, with a slice of transparent horn in front—hence the name of *horn-book*. There was a handle to hold it by, and usually this handle had a hole for a string, whereby the apparatus was slung to the girdle of the scholar. Sometimes the leaf was simply pasted against a slice of horn. At first, the leaf was of vellum, with the characters in writing; latterly, of paper, and printed. The horn-

of them are now exceedingly rare. The annexed representation is copied from one given by Mr Halliwell, as taken from a black-letter example which was found some years ago in pulling down an old farmhouse at Middleton, in Derbyshire. A portrait of King Charles I. in armour on horseback was upon the reverse, affording us an approximation to the date. In *Notices of Fugitive Tracts*, printed for the Percy Society (1849), Mr Halliwell figures a more perfect specimen, which he assigns to the time of Elizabeth. Allusions to the hornbook abound in the older writers; Shenstone, e.g., in *The School-mistress*, tells us of the children, how

'Their books of stature small they take in hand,  
Which with pellucid horn secured are,  
To save from fingers wet the letters fair.'

**HORODENKA**, a town of the Austrian Empire, in the province of East Galicia, on an affluent of the Dniester, 106 miles south-east from Lemberg. Pop. (1869) 10,000.

**HOTCH-POTCH**, a Scottish dish, may be defined as a kind of mutton-broth in which green peas take the place of barley or rice. This is a dish only to be obtained in perfection in summer, when green peas are in season. Put on two quarts of water, and when it boils, put in three pounds of the back-ribs of mutton or lamb, paring off the fat if there be too much. Put in with the meat two or three carrots cut into squares, and two grated, also three or four sweet young turnips in squares, a cauliflower and a lettuce cut down, a few young onions shred, a little parsley, and about a pint of sweet young peas. Boil this for an hour and a half, then take out the meat, and cut it in chops, laying it aside. Add another pint of young peas, seasoning with pepper and salt; and when these peas are done, put in the chops. In a few minutes afterwards, serve up the whole in a tureen. Instead of cutting the meat into chops, it is not unusual to keep it whole, and serve it separately. Neck of mutton makes excellent hotch-potch. The composition of the mess may be varied by the addition of beans, white cabbage sliced, or asparagus points. Some boil the empty hulls of the peas in a little water apart, and add the strained liquor to the rest, which gives additional sweetness. Hotch-potch is considered the *chef-d'œuvre* of Scottish cookery.

**HOU'GHTON-LE-SPRING**, a town of the county of Durham, England, nearly 7 miles north-east from Durham, on the Great Northern Railway. The town of H. has recently much increased, and owes its prosperity mainly to the numerous coal-mines of the neighbourhood, the coal produced by which is of the most excellent quality. Pop. (1871) 5276. The surrounding district is very populous, and contains numerous villages.

**HUBERTUSBURG**, a royal hunting-seat, not far from Leipzig, built in 1721 by Augustus III, then prince, afterwards king and elector. It was much injured during the Seven Years' War, and has a historic celebrity on account of the treaty by which that war was ended, called the Peace of Hubertusburg. This treaty of peace was signed here on 15th February 1763, by the representatives of Prussia, Austria, and Saxony; and by it the position of Prussia was established amongst the great powers of Europe. Maria Theresa relinquished all claim to the provinces which had been acquired by Prussia; and Frederick the Great restored his electorate to the king of Poland, Elector of Saxony.

**HUFELAND**, CHRISTOPHER WILLIAM, one of the most distinguished physicians of modern times, was born on 12th August 1763, at Langensala in



Hornbook—17th century.

book was prefaced and otherwise ornamented with figures of the cross, and hence came to be often called Christ Cross Row, or Cross Cross Row. Common as hornbooks at one time were, copies

Thuringia. After having completed a general and medical education at the best schools in Germany, he was appointed physician in ordinary at the court of Weimar, where his father and his grandfather had previously filled the same office. Retaining this honorary title, he removed in 1793 to Jena, to be ordinary professor of medicine there; and after refusing a number of invitations to other places, he went from Jena to Berlin in 1798 with a number of very honourable professional appointments. On the foundation of the university of Berlin in 1809, he became one of its professors. He died 25th August 1836. He had a very high reputation for skill and tenderness as a physician, and he was equally esteemed for his intellectual abilities and his noble and benevolent character. A number of benevolent societies and institutions owed their existence to him, and many others found in him a zealous and liberal supporter. His published works are numerous, chiefly on medical and physiological subjects. His *Makroböthik*, or the Art of Prolonging Life, originally published in 1796, was translated into almost all the languages of Europe. Translations exist in Servian, Hungarian, and Hebrew. Amongst his most important works are one on Scrofula, *Ueber die Ursachen, Erkenntnisse, und Heilung der Skrofulkrankheit* (Berlin, 1795), which has gone through several editions, and has been translated into several languages; an advice to mothers on the Physical Treatment of Children, published in 1799; and his *Enchiridion Medicum*, or Introduction to the Practice of Medicine, published in 1836.

HUGHES, THOMAS, English author and politician, second son of John Hughes, Esq. of Donington Priory, Newbury, Berkshire, was born at Uffington, Berks, in 1823. He was educated at Rugby under the celebrated Dr Arnold; entered Oriel College, Oxford, in 1841, and took his degree of B.A. in 1845; was called to the bar at Lincoln's Inn in 1848, and became a member of the Chancery Bar. In 1856, he gave to the world *Tom Brown's School-days*—a picture of life at a public school, evidently written from the author's own personal experience, and recording the vivid and enduring impressions he brought with him from Rugby. This work attained great popularity both in England and America, especially among the young. It was followed, in 1858, by *The Scouring of the White Horse*; in 1861, by *Tom Brown at Oxford*, in which the mental history of his hero is continued, with sketches of college life and incidents; and in 1869, by *Alfred the Great*. H. pursued meanwhile the study and practice of the law. He gained the confidence and good-will of the working-classes by endeavouring to promote a better understanding between masters and men, and by teaching the latter the value of co-operation as a means of social elevation. He has, however, never failed courageously to rebuke the narrow prejudices and mischievous views held by certain members of trades-unions. At the general election for Lambeth in 1865, he was placed at the head of the poll, the working-men being especially enthusiastic in securing his return. He was returned for Frome in 1868, which he continued to represent till 1874, and always took a prominent part in debates relating to the combinations of trades-unions, and the amendment of the law of master and servant. He was appointed Queen's Counsel in 1869. H. has written various pamphlets and articles in reviews.

HUMMEL, JOHANN NEPOMUK, an eminent pianist and composer, born at Presburg in 1778. His earliest musical instructions were derived from his father, the director of the Imperial School of military music; after which he went to Vienna,

where Mozart, forming a high opinion of his talents, took him under his tuition. He appeared in public in 1787, being then but nine years of age, at a concert given by Mozart in Dresden; after which he gave concerts in Germany, Denmark, England, and Holland. In London, H. had the advantage of Clementi's instructions in 1791; and in Vienna, in 1793, he took lessons from Albrechtsberger in composition, and from Salieri in dramatic writing. From 1803 to 1811, he held the post of Kapellmeister to Prince Nicholas Esterhazy; and he was at a later period Kapellmeister at Stuttgart and Weimar. He visited Paris for the first time in 1822; and in 1833 became conductor of the German Opera at the King's Theatre in London. He died at Weimar in 1837. H.'s pianoforte works rank among the purest and most classical compositions for that instrument—his concertos are full of artistic skill; he has besides composed masses, which are in high esteem, and several now nearly forgotten operas and cantatas. His playing was characterised by the same solid qualities as appear in his compositions.

HUSCH, a town of Moldavia, on a feeder of the Pruth, 40 miles south-east from Jassy. It is the capital of a district. Here the treaty between the Russians and Turks was signed in 1711. Pop. about 12,000.

HUXLEY, THOMAS HEWRY, naturalist and comparative anatomist, born at Ealing, Middlesex, in 1825, was educated at the school in that town, and afterwards studied medicine in the Medical School of Charing Cross Hospital. In 1846, he entered the medical service of the royal navy, and did duty at Haalar, under the late Sir John Richardson, until the winter of the same year, when he was appointed assistant-surgeon on board the *Rattlemate*. This vessel, commanded by Captain Owen Stanley, was commissioned to survey the intricate passage within the Barrier Reef skirting the eastern shores of Australia, and to explore the sea lying between the northern end of that reef and New Guinea and the Louisiade Archipelago. Imbued with a passion for natural history, Mr H. devoted himself with zeal and intelligence to the study of the numerous marine animals collected from time to time during the survey, and made them the subjects of scientific papers, which he sent home, diffident as to their value. They were published, however, by the Royal Society and the Linnean Society, and made their author known, while yet a young man, to the naturalists of Europe. Towards the end of 1850, the *Rattlemate* returned to England, and Mr H. had the gratification to find that his paper on *the Anatomy and Affinities of the Family of the Medusa* had been published in the *Philosophical Transactions*. Thus encouraged, he set to work to arrange his large accumulation of facts and observations, with a hope (which was disappointed) that the Admiralty would contribute towards the cost of their publication. In 1851, papers on other branches of the same subject were printed in the *Philosophical Transactions*; and in the same year Mr H. was elected a Fellow of the Royal Society. In 1852, one of the two Royal Medals annually given by the Society was awarded to him, in recognition of the scientific value of the papers above referred to. In those papers, much light was thrown on the structure of a number of animals before unknown, or but little known, to British naturalists. In 1854, Mr H. was appointed Professor of Natural History in the Royal School of Mines, in place of Professor Edward Forbes, and, among his lectures in that institution, has delivered courses to working-men with beneficial results. In 1857, jointly with Dr Tyndall, he wrote a paper, *Observations on Glaciers*, which was printed

in the *Philosophical Transactions*; and in the following year he delivered the Royal Society's Croonian lecture, *On the Theory of the Vertebrate Skull*, in which a highly important anatomical question was discussed. In 1859, his large work on *The Oceanic Hydrozoa; a Description of the Calycophoridae and Physophoridae* observed during his voyage, was published by the Ray Society with illustrative plates. He has since published papers on the Glyptodon, and the Osteology of that genus; and in papers on the Mollusca, has shewn that those animals have a common type or plan, similarly to the Annulosa and Vertebrata. Mr H. contributed largely to the *English Cyclopaedia*; and papers by him have appeared in the journals of the Royal, the Linnæan, the Geological, the Zoological, and other learned societies. *Man's Place in Nature* appeared in 1863; *Lectures on Comparative Anatomy*, in 1864; *Lessons in Elementary Physiology*, in 1866; *An Introduction to the Classification of Animals*, in 1869; *Lay Sermons, Addresses, and Reviews*, in 1870; and *Critiques and Addresses*, in 1873. Professor H. was a prominent member of the London School Board, especially as an opponent of denominational teaching; he retired in 1872. He is Professor of Natural History in the Royal School of Mines, and Hunterian Professor of Anatomy to the Royal College of Surgeons; an LL.D. of Edinburgh; and was in 1872 elected Lord Rector of the university of Aberdeen.

HYDNORA, a genus of plants of the natural order *Rhizanthaceae*. *H. Africana* is a native of South Africa, where it is called *Jackal's Kost*. It is a parasite chiefly on the roots of large succulent

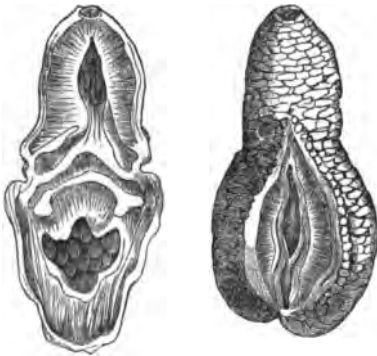

Hydnora.

spurges, and is a plant of most extraordinary appearance and structure, resembling a fungus rather than a phanerogamous plant. Its flowers and fruit are entirely concealed in its interior. It has a smell like that of a fungus, or of decaying roast-beef. The South African savages roast and eat it.

HYDRASTIS, or WARNERIA, a genus of plants of the natural order *Ranunculaceae*, allied to *Anemone*, but having flowers destitute of petals, and succulent or baccate fruit, collected into a head. The only known species, *H. Canadensis*, a perennial herbaceous plant, with tuberous roots, and head of fruit resembling a raspberry, is common in watery places in Canada, and among the Alleghanies, as far south as Carolina. Its root is used for dyeing yellow, and also in medicine as a tonic. YELLOW ROOT and ORANGE ROOT are its American names.

HYDRAULIC CRANES have come into very extensive use within the past few years. Wherever a large number of cranes have to be worked near

each other, water-pressure is by far the most manageable, economical, and convenient mode of working them. Sir W. Armstrong & Co., of Newcastle, have taken the lead in introducing this kind of machinery. They have fitted up a great many railway goods-stations with complete systems of hydraulic cranes.

Fig. 1 represents one of the simplest forms of hydraulic cranes, such as are in use for loading goods in a railway station. It is made entirely of iron, and consists of two upright cheeks, A, between which there is fixed a hydraulic ram (similar to that used in the hydraulic press), occupying the lower

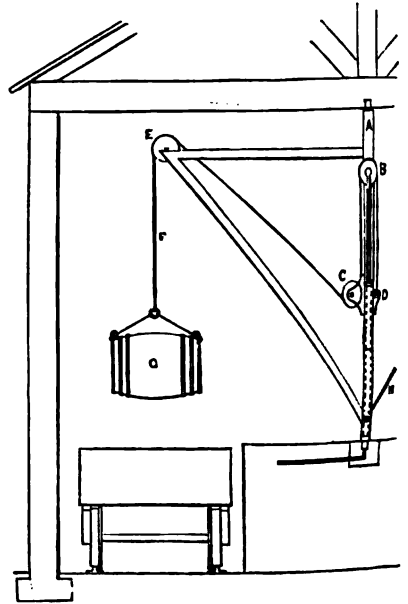

Fig. 1.

half of the upright frame A. The upper end of this ram carries a pulley B. A similar pulley is fixed to the upright frame at C. A chain is secured to a bracket, D, on the upright frame. This chain passes up over the pulley B, down and under the pulley C, and then over the pulley E, on the end of the jib of the crane. It is obvious that the rising and falling of the ram will cause the chain, F, to ascend and descend with its load G.

The ram is forced to ascend by the admission of water under great pressure by the handle H, which serves also to allow the water to flow out after it has done its work, and the ram descends by its own weight, allowing the chain, F, to run down with or without a load on it.

The pressure usually employed in working hydraulic cranes is greatly in excess of the pressure admissible in the case of steam. Six or seven hundred pounds to the square inch is usually employed as the working-pressure. It is got up to this great pressure by means of an arrangement called an accumulator, which consists of a large hydraulic ram of 16 or 18 inches in diameter, A, fig. 2, carrying a wrought-iron cylinder, B. This cylinder is filled with stones or gravel to the weight of 60 or 70 tons. A powerful horizontal steam-engine forces water into the cylinder C, and slowly raises the ram, A, with its enormous load. Pipes lead away from the cylinder to the cranes in the different parts of the station, and are thus supplied with water under the great pressure caused by the load B, fig. 2, forcing the ram A, fig. 2, into the cylinder.

The load B, fig. 2, is constantly rising and falling a little as the cranes draw their supplies from the cylinder C, fig. 2. If the cranes were supplied direct

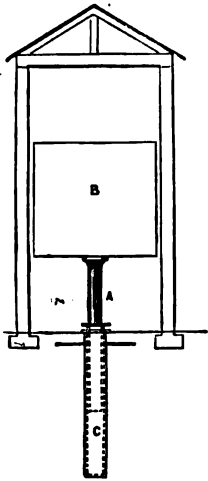

Fig. 2.

from the force-pumps of the steam-engine, without the intervention of this accumulator, their action would be jerky and unsteady. The accumulator acts as a reservoir of power, and when it happens that a great number of cranes are drawing off water at the same moment, and in excess of what the engine force-pumps can supply, the ram descends, keeping up the while the full 700 lbs. pressure; and then, when the cranes are demanding less abundant supplies, the engine overtakes its work, and sends the ram up again.

When it arrives at the top, it touches a lever communicating with the throttle-valve of the engine, and thus slows or stops the engine when the accumulator has mounted to its maximum height. The moment it begins to descend, the lever is relieved, the throttle-valve opens, and the engine goes on again with such speed as the work demands. It is easily seen that when the pulley B, fig. 1, rises any given distance, the weight G will, at the same time, rise double that distance, because B raises a double length of chain; and, in the same way, by passing the chain twice, thrice, or any greater number of times over pulleys at B and C, fig. 1, the weight G, fig. 1, can be made to travel any number of times further than the ram. It is, in fact, the reverse action of a block and tackle. If the block is made to move, the fall will move further than the block in proportion to the number of times the rope passes over the sheaves. This kind of arrangement is adopted when it is desired to lift anything to a considerable height, such as grain to upper floors of a warehouse. There is, of course, a diminution in the weight the machine can hoist, in proportion to the excess of travel of the load to that of the ram.

The hydraulic lifts, or ascending rooms, now in use in many large hotels, are constructed on the same plan as the accumulator, fig. 2. A cylinder, C, is sunk 60 or 70 feet into the ground, thus admitting a ram, A, of nearly equal length to rise out of it, on a sufficient pressure of water being forced into it by a steam-engine. The ascending room takes the place of the loaded cylinder B. Balance weights are attached to the ascending room, to steady its movements, and to guard against any failure in the mechanism. A rope passing from bottom to top of the channel, through which the ascending room rises, affords to the person in the room the means of regulating its movements.

HYDRAULIC ENGINES are sometimes used where water under high pressure is obtainable. They do not differ in any essential particular from a steam-engine. As the pressure under which they work is from five to ten times greater than that of a steam-engine, they are much smaller. One form

of hydraulic engine is described under the head of WATER-POWER. Another common form is that of three small cylinders in which three plungers work. The water is admitted into the cylinders by means of valves, and forces the plungers outwards. These plungers are connected with a three-throw crank; and when they have completed their outward travel, or working stroke, the water is allowed to escape from the cylinder; the plunger then slides inwards, to be again forced outwards by a fresh rush of water admitted at the proper instant into the cylinder by the action of the valve.

HYPNUM, a genus of mosses, which contains many of the most common British species, growing on moist ground, in woods, on old trees, &c. Many species have stems of considerable length and much



Hypnum dendroides:

a, plant about half natural size; b, leaf magnified; c and d, capsule magnified.

branched. The fruit-stalk springs from a lateral tubercle. The peristome (see Mosses) is double, the exterior of 16 teeth, the interior a membrane divided into 16 segments, with alternate cilia.

HYTHE (A.-S. *haven*), a parliamentary and municipal borough and market-town of England, and one of the Cinque Ports (q. v.), in the county of Kent, 14 miles south of Canterbury, and about half a mile from the coast of the English Channel, at the east end of Romney Marsh. Lympne or Limne (the *Portus Lemanis* of the Romans), the ancient castle and harbour, about 2½ miles west of H., is now about two miles from the coast, the sea having gradually retired, first, to West Hythe, and then to the present haven, which is still silting up. The town stands chiefly at the foot of a cliff, and consists of one main street, running parallel to the sea, with smaller ones branching off. It has an interesting church, partly Norman and partly Early English. Under the chancel of the church is an extraordinary collection of human skulls and bones—many of the skulls having deep cuts in them—the age and origin of which are altogether uncertain. H. is now a place of great resort in the bathing season. The parliamentary borough of H. includes Folkstone, Sandgate, and some smaller places. Pop. of municipal borough, which includes West Hythe (1871), 3383. H. is about a mile from the Folkstone and Dover Railway.

# I

**I**CICA, a genus of trees of the natural order *Amyridaceæ*, having pinnate leaves with an odd terminal leaflet, and white flowers in paniced racemes: the flowers having a small 5-toothed calyx, 5 petals, 10 stamens, and a cup-shaped disc with 10 crenatures on the margin, the fruit 'a drupe.—*I. icicariba* yields the American Elemi (q. v.).—*I. heterophylla*, a tree of Guiana, yields a yellow aromatic balsam, which long retains its fluidity, and is used as an application to wounds. The resinous seeds are very fragrant.—*I. heptaphylla* and *I. Guianensis*, also natives of Guiana, yield very fragrant balsams, which harden into a gray resin, used as incense in churches and for other purposes, and esteemed useful as a medicine in dysentery.—*I. altissima* is a tree 100 feet high, a native of Guiana, of which the wood is known as *White Cedar* and *Red Cedar*, and as *Acyort*, *Samaria*, *Mara*, and *Curana Wood*, is used for furniture and housecarpentry, and for canoes.

**I**CO, a town of Brazil, in the province of Ceara, on the Salgado, 210 m. N.W. of Parahiba. The greater part of the inhabitants are shopkeepers, who supply the interior with articles of European manufacture, receiving produce in return, which they send down to the coast. Pop. 6000.

**I**DAHO, a N.W. territory of the United States, bounded N. by British America, E. by Montana and Wyoming, S. by Utah and Nevada, and W. by Oregon and Washington. Area, 86,294 square miles. The surface is generally elevated, and the soil capable of high cultivation. Agriculture, however, has been little prosecuted; and the main source of the wealth of the territory consists in its gold, silver, and other minerals. Pop. (1870) 14,999. Capital, Boise City. Organised as a territory in 1863, I. was afterwards diminished in area by the abstraction of Montana to form a separate territory.

**ILHA'VO**, a fishing-town of Portugal, in the province of Beira, near the Atlantic. Pop. 8000.

**IMO'SCHI**, a town of the Austrian empire, in Dalmatia, in N. lat. 43° 30', E. long. 17° 15'. It has markets twice a week, which are much frequented by Turks. Pop. (probably including a district) 22,000.

**IMPOON** (*Antelope* or *Cephalopus mergens*), a



Impoon (*Cephalopus mergens*).

small species of antelope, very plentiful in South Africa, in wooded districts. It is about 21 inches

high at the shoulder, of a brownish-yellow colour, with white belly. The horns are short and conical, set far back, and inclined backwards. It lives solitary, or in pairs. From its habit of plunging amongst bushes when pursued, standing on its hind legs at intervals to observe its pursuers, and disappearing again, the I. is called *Duyker-bok* (Diverbuck) by the Dutch colonists of South Africa, among whom its flesh is in great esteem.

**INAJA' PALM** (*Maximiliana regia*), a South American palm, common in the countries near the Amazon; having a lofty, massive stem; very long,



Inaja Palm (*Maximiliana regia*).

drooping, pinnate leaves, with leaflets in groups of three, four, or five at intervals along the midrib, from which they stand out in different directions; numerous spadices; large woody spathes; and densely clustered elongate fruit, with a hard stony seed, a layer of soft pulp, and a tough skin. The leaves are sometimes more than 50 feet long. The great woody spathes are used by hunters to cook meat in, and with water in them, they stand the fire well enough for the purpose. They are also used as baskets and as cradles by the Indians. The fruit is eaten by the Indians, and is particularly attractive to monkeys and some kinds of birds.

**INCUMBERED ESTATES COURTS** are tribunals, established under recent statutes, for the purpose of disposing more readily than the ordinary judicial machinery will permit, of landed property subject to incumbrances, or legal claims at the instance of other persons than the proprietors. The want of such courts was first felt in Ireland. A quarter of a century ago, the rents of many Irish estates did not suffice to pay the interest

of the debts created over them, and the number of such incumbered properties was increased by the abolition of the corn-laws in 1846, which lessened the demand for those products of tillage which had rendered the cultivation of the soil possible by cottier tenants. It was believed that Ireland must become a grazing country; but that it could only do so in the hands of capitalist farmers, or landlords farming their own lands, and that a complete revolution in tenure was required to put them in possession of the soil. The sluggish and expensive procedure of the Court of Chancery made it impossible to effect this; and it became necessary to call into existence some more simple machinery by which property could be transferred from the old to a new class of proprietors. An auction-mart rather than a legal tribunal was wanted, under the control of officers able to scrutinise titles and adjust claims on landed property with care, yet without undue delay, and authorised to sell incumbered estates in the open market, to hand over a good and simple title to the purchasers, and to divide the sum realised among the proprietors, mortgagees, and others concerned, according to their interests. To accomplish this, an act (11 and 12 Vict. c. 48) was passed in 1848; but, owing to defective construction, it was found inoperative. It was followed, in 1849, by a second act (12 and 13 Vict. c. 77), the object of which was to enable any owner of land, or of a lease of land for not less than 63 years unexpired, subject to incumbrance, to apply to commissioners, appointed under it, and forming a court of record, to direct a sale. The total number of petitions presented in the eight years ending 1857 was 4413, of which 1363 were lodged by owners. The number of absolute orders for sale during the same period was 3547. The gross amount produced by sales from the foundation of the court up to August 1859 was £25,190,839, of which there was distributed to creditors £24,229,027, including £3,692,611, allowed to incumbrancers who became purchasers. A sum of £961,809 remained in hand to satisfy unadjusted claims. At this period, however, the business before the court had almost ceased. There were, in fact, no longer mortgages exasperated by long-suffering left to petition; all the incumbered land had been sold, and everybody with claims on it had been paid. It was then determined that the new tribunal should, with wider functions, be rendered permanent. The Landed Estates (Ireland) Act (21 and 22 Vict. c. 72), passed in 1858, abolished the Incumbered Estates Court, and transferred the judges and officers to the Landed Estates Court, a permanent tribunal, with the wider functions required, and with various other powers connected with the declaration of title, partitions, exchanges, and redistribution of land. The Record of Title Office, the counterpart of the Land Registry Office in England, has been since placed under the direction of the Landed Estates Court. Since the passing of the act in 1865 to November 1871, 493 estates had been registered, valued at £1,715,870, the amount of mortgages recorded being £177,344. Between the 1st November 1858 and 31st January 1862, the amount realised by sales made by the Landed Estates Court was £5,940,990; and the approximate capital value of estates brought under its jurisdiction, but remaining unsold, £3,664,996. The rental and value of the estates sold in 1869, 1870, and 1871 are indicated in the following summary :

	1869.	1870.	1871.
Net rental of estates sold, . . .	£87,968	£46,369	£53,754
Amount of purchase-money, . . .	£1,168,857	£757,318	£1,008,524
Number of sales, . . .	209	201	200

There can be no doubt that the statutes calling into

existence these courts have facilitated a great revolution in the tenure of the land in Ireland. They supplied the means by which a very great part of the soil passed rapidly from cottier tenants (i. e., labourers paying rents determined by competition) and an embarrassed and non-resident gentry, to capitalist farmers and to landlords who cultivated the soil themselves, and under whom the country rapidly increased in agricultural prosperity. There can be as little doubt, however, that the process inflicted grievous injury on the tenants. It had never been usual in Ireland, as in other countries, for the landlord to bear the expense of permanent improvements. These were carried out by the tenant, who trusted to make an arrangement with regard to rent which would compensate him for his expenditure of labour or money. The sales under the Incumbered and Landed Estates Acts deprived the tenant of all power to make such claims. Increased rents were demanded under pain of eviction, and the result was that small farmers were obliged to emigrate, to remove to the towns in search of work, or remain as servants on their old farms. The Irish peasantry were not a class likely to submit quietly to such changes. Acts of retaliation and widespread discontent were the consequences, and it was found necessary to reconsider the whole subject of land tenure in Ireland. The conclusion came to was that exceptional legislation was necessary for this part of the United Kingdom; and accordingly, on 1st August 1870, the Irish Land Act was passed, which effectually checked what was described as the grievous wrong and injustice to tenants by the purchasers in the land courts. It would at present be premature to express any opinion as to the ultimate effect of the new land law on the political and social condition of the Irish people.—See *The Story of the Incumbered Estates Court*, by Percy Fitzgerald, 1862; article on the New Irish Land Law, in *Fraser's Magazine* for March 1872; and Thom's *Irish Almanac*, which gives annually a summary of the information contained in the Return made to the House of Commons.

In 1854, the West Indian Incumbered Estates Court was established under the statute 17 and 18 Vict. c. 117, entitled 'An Act to facilitate the Sale and Transfer of Incumbered Estates in the West Indies.' The purposes and regulations were similar to those of the Irish Incumbered Estates Act, the court of the chief commission being held, however, in Westminster, where it still sits.

INDIGO BIRD (*Cyanospiza cyanea*), a North American bird of the Finch family (*Fringillidae*), a native of the United States, as far north as the Missouri, which it visits in summer, and of Central America, where it spends the winter. It is about 5½ inches in length, of a beautiful blue colour, variously tinged and shaded, the lores and angles of the chin velvet black. It frequents open places on the edges of woods, and delights to sit singing on the top of a high tree. Its song is very sweet. It is easily domesticated, and is much in request as a cage-bird.

INGRES, JEAN DOMINIQUE AUGUSTE, one of the most eminent painters of the French school, was born at Montauban, September 15, 1781. A casual view of a copy of one of Raphael's pictures, inspired him (so it is said), at the age of ten, with the ambition to become a painter: he forthwith began to study drawing; and after having been successively the pupil of a M. Roques and of M. Briant, a landscape-painter, he went to Paris in his 17th year, and entered the studio of the great painter David. He remained with David as a pupil for four years. He carried off the second prize for



painting at the Academy of the Fine Arts in 1800; and in the following year, he took the first—an honour which has scarcely, in any other case, been awarded to so young an artist. The picture which gained for him this high distinction was 'The Arrival of the Intercessors at the Tent of Achilles.' It is now at the School of Fine Arts, and unquestionably it compares well with many of the works which have made him famous. In 1802, he exhibited two portraits, which still rank among his finest works of this class; in 1804, he exhibited a portrait of the First Consul, and also a portrait of himself. He again painted Napoleon, now become Emperor, in 1806, and the picture was bought for the Hôpital des Invalides. In 1806, he set out for Rome, where he continued to live for many years. He seems to have made a reputation in Italy early, and the commissions he received, including several from the pope, prove that his reputation stood very high. From his countrymen, however, the pictures which he sent to Paris, for many years met only with neglect or ridicule. It was at Florence, where he resided from 1820 to 1824, that he painted a picture which at length gained him a party of enthusiastic admirers among the Parisians. The picture was 'Le Vœu de Louis XIII.' It was exhibited at the Louvre in 1824, and though much decried as well as much admired, it still raised L., previously almost unnoticed, at a bound to the chief place among French idealist painters of that time. He received from Louis XVIII the Cross of the Legion of Honour; and he was forthwith appointed to succeed Baron Denon as Professor at the Academy of the Fine Arts.

Now that he had become the acknowledged head and representative of a school of art, it was natural that his work should be subjected to a searching criticism, more eager to detect faults than discover merits. He brought upon himself a perfect tempest of discussion in 1827 by a work called 'L'Apothéose d'Homère,' which his admirers declared to be a masterpiece; while the party of his detractors—then numerous and influential—condemned it as bad in drawing, as poor in colouring, and especially as being ungraceful, coarse, and even vulgar in conception. The French critics seem now to be agreed not only that this was L.'s finest attempt at epic painting, but that it places him at the head of the French school, and on the level of the greatest painters the world has seen. Many foreign judges, however, are disposed to hold that the strictures originally made upon it were to a large extent well founded. The discussion which it originated ranged over all the painter's work; it was renewed year after year, and the bitter expressions of some of his critics made such an impression upon L., that from 1832 to 1834, he exhibited nothing but two portraits, and in the latter year embraced an opportunity which offered of again establishing himself in Italy. He became Director of the French Academy at Rome, a post which has been held by many distinguished artists, and in which his predecessor was Horace Vernet. This time, he remained in Italy for about ten years. During these years, he sent many pictures to be exhibited at Paris: these gradually wrought upon the public taste; and when he returned, he found his countrymen unanimous and enthusiastic in admiration of him, and in raptures about his latest composition—'Cherubini [the composer] Inspired by the Muse.' Since then, it has been treason in Paris to breathe a doubt about the greatness of Ingres. The state ratified the decision of the public by the liberality with which it bestowed its honours upon him. He was made an Officer of the Legion of Honour in 1841, a Commander in 1845, and Grand Officer in 1855; he was named a

senator on May 25, 1862; and he was soon after appointed a member of the Imperial Council of Public Instruction. He became a member of the Institute in 1825. Many of his works are now in public collections. At the Paris Exhibition of 1855, a room was set apart for his pictures, and one of two grand medals of honour was awarded to him—Eugene Delacroix getting the other. He continued to exercise his art almost to the close of his life; and whatever may be thought of the success of his higher aims, he shewed himself to the last what he had always been, the most painstaking, conscientious, and learned of painters. The *Naiad* which he painted in 1861 ('*La Source*'), and which was his solitary contribution to the London Exhibition of 1862, is considered the finest of his later works; it was enthusiastically admired, even by those who strongly dissented from the praises lavished by his countrymen upon his more ambitious undertakings. He died, after a short illness, January 14, 1867. During the summer, an exhibition of his works took place in Paris, at which almost all his pictures and the cartoons for his works in stained glass and mural paintings, were brought together.

'L'Apothéose d'Homère,' 'Le Martyre de St Symphonea,' 'La Naissance de Venus Anadyomène,' 'La Source,' 'L'Odalique,' and the portrait of M. Bertin, *atq.*, may be mentioned as among the most characteristic—they are certainly among the most admired—of the works of Ingres. His admirers—who are at present the whole body of his countrymen—recognise in him, among modern painters, the most faithful and persevering, and the most successful student of the traditions of the Renaissance; they declare his paintings equal in power and fidelity to the best works of the great masters. On the other hand, it is maintained by his censurers or detractors that L. was deficient in invention and refinement; that all the good things in his works have been borrowed from ancient pictures; and that, moreover, he copied badly from his models, and often spoiled what he borrowed by his setting of it. Such censures appear greatly exaggerated; but it may be confidently said that L. is at present worshipped by his countrymen with a somewhat blind veneration; and that they would do well to expend upon a few really great works the admiration which they lavish upon everything that proceeded from him.

INJECTOR, GIFFARD'S, is now in general use for feeding water into steam-boilers, particularly locomotive boilers. Feed-pumps are difficult to keep in order when driven at high speed. The very rapid action of the valves severely tries their durability. In the case of locomotives, inconvenience was often occasioned by the fact, that their feed-pumps acted only when they were running; and thus, if an engine happened to stand still for any length of time, the water occasionally got too low in the boiler. The injector acts equally well whether the engine is running or at rest.

The diagram fig. 1 will give an idea of the essential parts of the injector. A is the steam-boiler, B being the water-level, CDF a pipe into which steam is admitted: this pipe terminates in a cone DF, which is enclosed in a larger cone HH. In the cone DF, the pointed plug E can be raised or lowered so as to increase or diminish the area of the aperture at its lower end F. G is a pipe communicating with the water-cistern, and admitting water into the external cone HH. K is a pipe communicating with the boiler under the water-level. On opening communications between the boiler and this apparatus, it might be expected that steam would rush out at F, and water at K, both currents meeting with great force, and escaping into

## INJECTOR—INNES.

the atmosphere between the two openings. Paradoxical as it may appear, the outflowing stream of

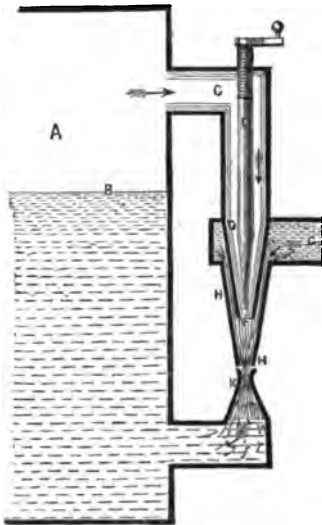

Fig. 1.

water at K, although it is actually flowing under a greater pressure than the current of steam escaping at F, due to the head of water arising from the

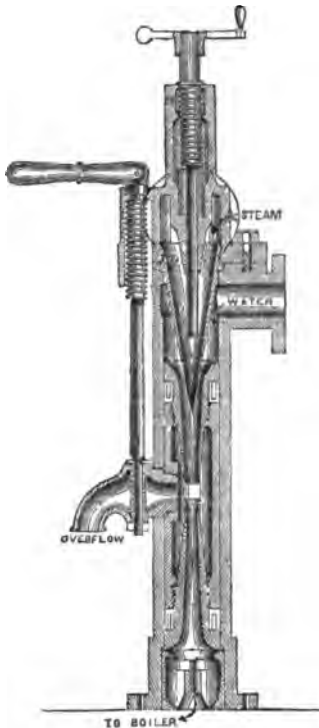

Fig. 2.

difference of level between the aperture at K and the water-level at B, is overpowered, and driven back into the boiler; and not only is the outflowing current of steam at F able to drive back the stream

of water trying to escape at K, but the torrent of steam drags with it a large quantity of water with which it comes into contact as it is passing through the cone HH. This water finds its way into the cone HH, through the pipe G, from the tender or cistern, and constitutes the feed-water. The steam rushing from the aperture at F will necessarily be condensed by the cold water with which it comes into contact in the cone HH. The explanation offered of the action of this apparatus is as follows. The opening at F, through which the steam escapes, has nearly twice the area of the opening into which the water is to be forced at K. The opening in the cone HH is also larger than the aperture at K, and it appears that the mechanical power contained in the flow of steam from F is, as it were, transformed from a large area to a smaller, with a corresponding increase in its intensity. This diminution of its volume arises from its condensation by the cold water through which it has to rush in the cone HH. We get thus the mechanical power due to a column of large area concentrated into a small area, with a corresponding increase in its velocity, and to this increase of velocity is due the fact, that a current issuing at FH will enter at K, in spite of the counter-pressure at K. The injector for feeding boilers is rather an expensive apparatus, in consequence of the number of adjustable parts required to be provided. Variations in the pressure of steam require alterations in the area of the steam-passage, and in the distances between the mouths of the conical openings for the outflow and inflow of steam and water.

Fig. 2 shows in section an injector such as is now in common use.

Fig. 3 shows in section a simple form of injector for raising water. Steam issuing from the pipe S, into the vessel WR, will draw the water through the pipe T, and force it up through the narrow neck below R, to a height of about one foot for every pound of pressure per square inch. It is doubtful if these injectors can work so economically, as regards expenditure of steam, as ordinary slow-moving pumps; but they possess many conveniences and advantages, which are bringing them into use.

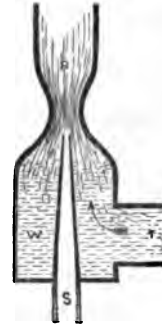

Fig. 3.

INNES, THOMAS, the author of *A Critical Essay on the Ancient Inhabitants of Scotland*, was the second son of James Innes of Drumgask, in the parish of Aboyne, and county of Aberdeen. He was born at Drumgask in the year 1662, and at the age of 15, was sent by his father, a zealous Roman Catholic, to be educated at the university of Paris. He was ordained priest in 1691, and took his degree as Master of Arts in 1694. He continued in France for some years, discharging his ecclesiastical duties, and assisting his elder brother, Lewis, Principal of the Scots College at Paris, in arranging the valuable records which had been deposited there by James Beaton, the last Roman Catholic archbishop of Glasgow. In 1698, L returned to Scotland, and officiated as a missionary priest at Inveravon, in the old diocese of Murray. He again went to Paris in 1701, and passed the rest of his life at the Scots College, with the exception of one or more visits which he made to Britain. The great object of his life was to write the true history of Scotland, and to refute the fabulous narratives which had been hitherto generally received by his countrymen. The latter part of his task was fully accomplished

by his *Critical Essay*, which was published at London in 1729, in 2 vols. He had prepared himself for the work by a careful study of all the materials which he could find in the libraries of France, and of the books, whether printed or in manuscript, which he was able to consult during his journeys to England and Scotland. In the winter of 1724, he was seen by Wodrow, who had one feeling at least in common with him, and who thus refers to him in his *Analecta*: 'There is one Father Innes, a priest, brother to Father Innes of the Scots College at Paris, who has been in Edinburgh all this winter, and mostly in the Advocates' Library in the hours when open, looking books and manuscripts. He is not engaged in politics, so far as can be guessed; and is a monkish, bookish person, who meddles with nothing but literature.' In the *Critical Essay*, I examined the authorities on which depended what was then generally received as the history of Scotland, and shewed how little reliance was to be placed upon them. But not content with overthrowing fable, he pointed out what the true history was, and where it was to be found. The difficulties in the way of this inquiry were very great. Even at the present day, when most of the materials for Scottish history have been printed, it is no easy matter for the student to examine them. In L.'s time, they were for the most part in manuscripts, whose very existence was unknown except to a few antiquaries. Every subsequent writer on this portion of Scottish history has admitted the high merit and the practical usefulness of L.'s work. He gave his ready assistance to all who were engaged in pursuits similar to his own, particularly to Bishop Keith in his *History of Scotland* and his *Catalogue of Scottish Bishops*, and to Dr Wilkins in his *Concilia Magna Britannia et Hibernia*. To this last work he also contributed a valuable Letter on the ancient form of holding synods in Scotland. I died at Paris on January 28, 1744, in the 82d year of his age. The *Critical Essay* has now become a comparatively scarce work, but has never been reprinted. It was intended by its author to be an introduction to a *Civil and Ecclesiastical History of Scotland*. One volume of this *History* was prepared by its author for the press, extending from the introduction of Christianity to the death of St Columba in 597; and another volume was also left in an incomplete state, bringing down the narrative to the year 821. The whole was printed in one volume by the Spalding Club in 1863, under the editorship of Mr Grub. Imperfect as it is, it forms a valuable addition to our historical literature, being distinguished by the same learning, acuteness, and moderation for which the *Critical Essay* is so remarkable. As has recently been observed, its author loved truth better even than he loved his church. A full biographical notice of L., and an account of his various works, will be found in the preface to his *Civil and Ecclesiastical History*.

IRETON, HENRY, an English general of the period of the Commonwealth, was the eldest son of German Ireton, of Attenton, in Nottinghamshire, and was born in 1610. He studied law at Oxford, but on the breaking out of the Civil War, offered his services to the Parliament. His connection with Cromwell, whose daughter, Bridget, he married in 1646, greatly advanced his interests. At Naseby, he was taken prisoner by Rupert, but rescued some hours after, when Cromwell's Ironsides decided the fortune of the day. I was one of the most implacable enemies of the king, and signed the warrant for his execution. When Cromwell passed over to Ireland to subdue that country, he was accompanied by his son-in-law, on whose vigour, judgment, and tact he placed much reliance. Cromwell's presence, however, was soon required in Scotland, and

the complete subjugation of Ireland was intrusted to Ireton. His career was brief, but successful. He was, however, unsparring in his severity. On the 15th November 1651, he died of the plague before the walls of Limerick. His remains were conveyed to England, and interred in Westminster Abbey; but after the Restoration, they were disinterred, and burned at Tyburn. I left one son and four daughters.

ISABELLA II. (MARIA ISABEL LUISA), ex-queen of Spain, the elder daughter of Ferdinand VII by his fourth wife, Maria Christina, of the Two Sicilies, was born at Madrid, October 10, 1830, and by a decree which set aside the Salic law in Spain, and was confirmed by the Cortes, March 29, 1830, became the heiress-apparent to the throne, which she ascended on the death of her father in September 1833, her mother being appointed queen-regent. An insurrection in favour of her uncle, Don Carlos (q. v.), who, according to the Salic law, would have succeeded to the throne, immediately broke out in the north-eastern provinces, and raged with great violence for seven years, but was ultimately suppressed by the aid of Britain, France, and Portugal. During this tumultuous epoch, effective internal administration was impossible, and it was necessary to conciliate as far as possible all parties, in order to prevent desertions to the Carlists. Before the revolt had been crushed, which was conclusively effected in 1839, politicians had begun to divide into two classes, the *Moderados*, or 'conservatives,' and the *Exaltados*, or 'liberals;' and though the queen-regent sided with the former party, she found it necessary to enlarge the liberal constitution of 1834, and ultimately (1837) to re-establish the constitution of 1812. The attempts of the Moderados to inaugurate a more narrow policy in 1839 failed, and Maria Christina was forced to flee to France, leaving the regency and the care of the young queen to Espartero (q. v.). On November 8, 1843, the queen was declared by the Cortes to have attained her majority; and this was followed soon after by the return of the queen-mother, the military dictatorship of Narvaez, and an anti-liberal policy. The question known as the 'Spanish Marriages,' which at that time agitated the different courts of Europe, was settled by French influence, the queen marrying her cousin, Don Francisco d'Assisi, eldest son of Ferdinand VII's youngest brother (October 10, 1846); while her sister, Maria Ferdinand Luisa, espoused the Duke of Montpensier, the fifth son of Louis Philippe. This marriage of the queen, based wholly upon the political interests of the party in power, has been fruitful of domestic annoyances, estrangements and reconciliations rapidly succeeding each other. After eight years of authority, during which he had repressed all liberalism with an iron hand, and foiled the intrigues both of the Carlists and the king-consort, Narvaez gave place to Murillo (January 1851), who began by promising liberal reforms, and agreed to a concordat with the pope. A change to almost purely absolute government in 1853, was followed by the banishment of many chiefs of the constitutional party, and a formidable rising of the army took place. The queen-mother fled to France, and Espartero was once more put at the head of an administration in which liberal principles held sway. But the queen disapproving of his policy, he resigned in favour of O'Donnell, July 14, 1856, who was soon after supplanted by Narvaez; and the latter, in turn, had (October 1857) to make way for a liberal government. In July 1868, O'Donnell was restored to power, and with the exception of a brief interval in June 1865, in which Narvaez was president of the council, maintained himself in the premiership till his death,

November 1867. The chief foreign events of I.'s reign were—repeated negotiations of the United States with Spain, with the view of purchasing the island of Cuba; the rectification of the Pyrenean frontier; the successful war with Morocco (q. v.); the annexation and subsequent evacuation of St Domingo (see HAYTI); and the discreditable squabbles with the republics of Chili and Peru. The nation became more and more impatient under the despotic rule of the last years of I.'s reign; and at length, in September 1868, a revolution broke out, which ended in the formation of a Republican provisional government, and the flight of I. to France. In 1870, she renounced her claim to the throne in favour of her son, Alfonso Francisco (born 1857), who was chosen king of Spain in 1874.

ISKELIB, or ESKILUP, a town of Asiatic Turkey, in the vilayet of Anatolia, near the Kizil-Irmak, about 260 miles east of Scutari. There are several mosques and a ruinous castle on the top of a bold and naked limestone rock. In the neighbourhood are sepulchral caverns, some of which are sculptured. Pop. estimated at 9000.

ISLES, LORDS OF THE. The Lords of the Isles are famous in poetry and romance, but no proper historical account of them has yet been written, and it is difficult to discriminate between truth and fable in the various notices which have been preserved. The Western Islands of Scotland, or Hebrides, as they were afterwards called, originally a portion of the domains of the Scots and Picts, were afterwards subdued by the Norwegians. When Scotland became consolidated into one monarchy, its kings endeavoured to wrest the islands from the Norsemen; and during the contest which ensued, the various chiefs sometimes professed allegiance to the king of Scotland, and sometimes to the king of Norway, or their own more immediate superior, who ruled in Man. The Scottish supremacy was finally established by the victory of Largs, in the reign of Alexander III., and the final cession of the islands by Magnus, son of Haco, king of Norway, made in the year 1266. By that treaty, all the islands of the Scottish seas, except those of Orkney and Zetland, were surrendered to Scotland. Man was conquered by the English during the wars of the succession, but the other islands remained subject to the Scottish sovereigns. The first name which generally appears in the lists of the Lords of the Isles, as distinct from the kings of Man, is Somerled; and the great chiefs who afterwards held the islands and portions of the mainland near them, claimed descent from this powerful lord. He appears prominently in Scottish history in the middle of the 12th c., during the reigns of David I., and his grandson and successor, Malcolm IV. How he acquired his great authority, is not precisely known. Even the race to which he belonged is uncertain; probably, like most of his subjects, he was of mixed descent, Norwegian and Celtic. His sister was married to Malcolm Mac-Heth, the head of the great Celtic family of Murray, who has been confounded by most Scottish writers with the impostor Wilmund, and whose true history has been explained by Mr E. W. Robertson in his *Scotland under her Early Kings*. In the year 1164, Somerled landed on the coast of Renfrew, at the head of his subjects of Argyle and the Isles, and was defeated and slain. His dominions seem to have been divided among three of his sons—Dugal, Angus, and Reginald or Ronald. The descendants of Dugal became Lords of Argyle and Lorn; and those of Reginald, Lords of the Isles. Reginald is said to have been succeeded by Donald, and Donald by Angus Mor, who was the father of Angus Og.

We know from Barbour that Angus of the Isles, 'Lord and Leader of Kintyre,' gave his fealty to Bruce when most hardly pressed at the beginning of his reign, receiving him into his castle of Dunaverty, and that he afterwards fought under the great king at Bannockburn. This chief is the hero of *The Lord of the Isles*, but his name, as Scott tells us, 'has been, *euphonia gratia*, exchanged for that of Ronald.' John of the Isles, son of Angus, married, first, his cousin, Amy of the Isles, and secondly, Margaret, daughter of King Robert II.; and among his descendants by these marriages are said to be the M'Donalds of Sleat, Keppoch, Glengarry, and Clanranald. During the troubled and disastrous reign of David II., John of the Isles was able to maintain himself in a state of practical independence of the Scottish crown. He was at last, however, obliged to submit. He met David at Inverness in 1369, and gave hostages for his fidelity. His successor was Donald, his eldest son by Margaret of Scotland, and the most powerful of all the island lords. He set the kings of Scotland at defiance, and made treaties as an independent sovereign with the kings of England. He married Margaret, daughter of Euphemia, Countess of Ross. Margaret's brother, Alexander, Earl of Ross, by his marriage with a daughter of the Regent Albany, left an only child, who became a nun. Donald claimed the earldom in his wife's right; and when this claim was refused by the regent, he prepared to maintain it by force. Taking possession of Ross, he marched at the head of a large army from Inverness, through Murray and Strathgogie, entered the Garioch, and threatened to destroy the burgh of Aberdeen. At Harlaw (q. v.), near Inverury, he was encountered on St James's eve, 1411, by a Lowland army much inferior in number, commanded by Alexander Stewart, Earl of Mar. The action was fiercely contested, and, though not decisive in itself, the Lord of the Isles retreated, and all the advantages of the combat remained with Mar. This engagement, famous in history and song, probably saved the Lowlands of Scotland from Celtic supremacy. Donald was soon afterwards obliged to surrender the earldom of Ross, and to submit to the Regent. He was succeeded by his son, Alexander. This lord, like other great Scottish nobles, was seized and imprisoned by James I., who was determined to allow no rule in Scotland except his own. When restored to liberty, he again broke out into insurrection, but his army was routed; and in order to obtain pardon, he appeared at the altar of the church of Holyrood, and kneeling half clothed before the king, presented his sword, and implored forgiveness. After a short imprisonment, he was again pardoned. Upon his mother's death, he assumed the style of Earl of Ross, and seems to have been in possession of the earldom. He was succeeded as Earl of Ross and Lord of the Isles by John, his eldest son. John, like his predecessors, acted as if he were an independent sovereign rather than a vassal of the king of Scots. He entered into a confederacy with the earls of Douglas and Crawford, the one, the most powerful nobleman in the south, the other, in the centre of Scotland; and had they acted together with promptness and determination, the House of Stewart might have ceased to reign. In October 1461, at his castle of Ardmorish, on the coast of Argyle, he granted a commission to his kinsman Ronald, and Duncan, Archdeacon of the Isles, to enter into a treaty with Edward IV. of England. By that treaty, which was concluded in the following year, he agreed to become liegman to Edward, and to assist him in conquering Scotland. He was attainted more than once, and finally was obliged

to resign the earldom of Ross, which was annexed to the crown. This took place on the 10th day of July 1476, and John was at the same time created Lord of the Isles. He is said to have died in 1498. After his decease, the title of Lord of the Isles was assumed by Donald the Bastard, son of Angus of the Isles, an illegitimate son of John, Lord of the Isles; and several chiefs were attainted in 1503 and 1506 for supporting his claims. In July 1545, another Donald, styling himself Earl of Ross and Lord of the Isles, preading in a sort of Highland parliament, granted commission to the Bishop Elect of the Isles and another person to enter into a treaty with the Earl of Lennox, then acting for Henry VIII. of England. This document is given by Mr Tytler, the historian of Scotland, who remarks that 'it is a diplomatic curiosity, not one of the Highland chieftains, eighteen in number, being able to write his name.' In a paper addressed by the Highland Commissioners to the Privy Council of England, they speak of their constituents as 'the auld enemies to the realm of Scotland,' the very name by which the Scottish Parliament was wont to speak of the English. Various persons, claiming to be descendants of John, Earl of Ross, assumed the style of Lord of the Isles; but the title does not appear to have been recognised after his decease, except as annexed to the crown. The eldest son of the Scottish sovereign has generally used the style of Lord of the Isles, along with his other titles.

ISMAILIS is the name of a very advanced 'free-thinking' Mohammedan sect, of the Shiite branch of Islam (see SHIITES), which sprang up in the 9th c. A.D., and spread throughout Mohammedanism. Recognising Ali alone as the rightful successor of the Prophet, they held Abu Bekr, Omar, Othman, Moawia, to be usurpers, and counted their Imams, or representative prophets, from Ali only. The seventh Imam was one Ismail, who lived about 150 Hedjrah (772 A.D.), the son of Jafar Assadik, or rather of his son, Mohammed. He was supposed to be the righteous Prophet, the only orthodox, spiritual head. The notion of the Imam, in general, is that of an ever-living, though, at times, hidden, supreme guide of the people, who, after a time, is restored to humanity, or at least to the believing part of it. A prayer, preserved to us by Ibn Chaldun, will best shew the peculiar notion connected with this belief, to which no small part of Islam confessed. Every evening, a certain number of Imamihs prayed: 'O Imam, appear unto us! Humanity is awaiting thee; for righteousness and truth have perished, and the world is gone down in darkness and violence. Appear unto us, that we may, through thee, return unto God's mercy.' It was thought, in fact, that Ali himself had reappeared in every Imam, and that he would descend again, some day, 'from the clouds,' to unite all believers, and to restore the pure faith. The real importance of this sect, which had existed unobserved for some time, dates from Abdallah Ibn Maimun, whose father had been executed for professing materialistic doctrines, and trying to turn people away from the doctrines of Islam. Abdallah seems to have practically carried out his father's notions, but more cautiously. He is described by the Arabic writers as an utterly irreligious and unscrupulous materialist or 'Zendik.' The Messiah, whom he preached, stood higher than Mohammed himself, and though he did not exactly reject the Koran *en bloc*, he yet contrived to allegorise and symbolise away nearly all its narratives and precepts. But the systematic way in which Abdallah went to work, in trying to undermine, and eventually to abrogate, all Islam, and, as his biographers have it, to replace it by materialism, atheism, and immorality, is very remarkable indeed.

He established missionary schools; and the instructions given to the young missionaries were artfully designed to win over not merely all the different Mohammedan sects, both Sunnites and Shiites, but also Jews and Christians. The missionary's (dal's) first task was to win for himself the perfect confidence of the proselyte to be, by the affectation of great orthodoxy, and by a vast display of pious learning, chiefly Koranic. The disciple is by degrees to be cross-examined on difficult passages, on their 'spiritual meaning,' and on some points touched upon belonging to the physical sciences. Only matters of acknowledged obscurity and uncertainty are chosen as subjects of discourse, matters, the real understanding of which belongs exclusively to the 'aristocracy of learning.' Generally, the youth is so deeply impressed with the erudition displayed, the expectations raised, the mystery, and the rest, that he will follow gladly to the end. But, at times, the missionary meets with a less docile subject, a man who may be accustomed to discussions on these topics, who may have pondered over these things himself: the dal shall appear to accommodate himself to such a one's views, applaud all he says, and thus ingratiate himself with him; all the while taking care to shew himself well informed on those points which may be in favour with his disciple, and that mode of faith which he professes. All this is to be done very carefully, lest the other might 'suspect and betray.' The ordinary individual, on the other hand, is, after the first preliminaries, to be told that religion is a secret science, that most people know nothing of it, or utterly misunderstand it, that if the Moslems knew what degree of science God has imparted to the Imams, by quite a special favour, there would no longer be any dissensions among them. The disciple, whose curiosity has by that time been fully roused, is then to be instructed in a few allegorical interpretations of both the practice and theory of the Koran; and when he is convinced of the desirability to know more, and everything that the master knows, the latter is merely to point out to him that all this knowledge belonged of right to all Islam, but that the wickedness and perverseness of those who followed the wrong successor, has caused all dissension and infidelity in the community of the believers. It is the Imams who are the dispensers of the right interpretation, not people's own reason and judgment.

For the religion of Mohammed, they were to tell the disciple at this stage, was not a thing easy to comprehend. It did not mean to flatter the senses, or to dazzle by outward signs. It was, on the contrary, a difficult, the most difficult matter. Only angels of the first rank, or a prophet specially chosen, or a faithful servant whose heart God had searched and found true, were worthy of bearing this most precious of all burdens. By these and other speeches, the ordinary disciple is soon brought to revere and to admire the dal beyond all other men around him, upon whom he henceforth only looks as inferior beings and infidels, and his desire of knowing more or all becomes passionate. But hitherto the procedure has been discreet. All that was desired in this first preliminary stage, was to unsettle the man's faith. The preparatory questions put to the neophyte were so contrived as completely to puzzle and bewilder him (e. g.—Why did God take seven days to the creation of the world? Why are there twelve wells and twelve months? What is the figure of your soul?); and if the missionaries themselves proceeded to answer them, it was by allegorising interpretations of the Koran, the Sunnah, and the Laws. But they used the common artifice of stopping short just in the middle of an explanation, for they said, when pressed to

continue. 'These things are not lightly to be communicated; God always requires a pledge first. If you will swear into my hands, with the most solemn and inviolable oaths, never to divulge our secret, never to give any assistance to our adversaries, never to lay a trap for us, and never to speak to us unless for the purpose of telling us the truth, then I will tell you more.' When, if the neophyte has taken the requisite oath—and it is only at the very commencement of the initiation that oaths are of any moment to the Ismaili—he is further asked to contribute a certain sum of money, as a pledge for his sincerity. Should the convert, however, exhibit the slightest degree of reluctance either in swearing or in paying, he is instantly given up by the dal—'a prey to the never-to-be-solved doubts of his heart.'

Thus far the *first* preliminary degree. In the *second*, the missionary begins to initiate the neophyte's mind into the doctrines of the Imam—i. e., to prove to him, by arguments and proofs best adapted to his mind, how the understanding of God's religion can only be accomplished by following the revelations given to and communicated by certain special delegates; whose names are communicated to him in the *third* degree. There are, he is told, seven such Imams, as there are (according to the Koran, Sur. 65, 12) seven planets, seven heavens, seven earths—viz., Ali, Hassan, Husein, Ali Zein Alabidin, Mohammed Albakir, Jafar Assadik, Ismail. In the *fourth* degree, the proselyte learns that the number of the prophets whose task it was to abrogate at different periods the ancient forms of faith, and to substitute new laws, is also seven, like that of the Imams; that each of them had a 'companion,' to whom he confided his whole dispensation and its sacred meanings, and that the latter communicated the same in a secret manner, and by oral tradition, to another man after him, who again handed it down to a successor; until, after a string of seven such 'successors,' or *samet* (silent ones), in contradistinction to the prophet (*natik*) or speaking, teaching one, a new Imam is born. The traditional chain has thus never been broken. After seven times seven such successions of prophets and their 'silent' successors—during which seven religions were successively abrogated—there appeared the last and crowning prophet, who abrogated all the religions that were before him, and who is the 'chief of the last century'—the last *natik*. These seven are: (1) Adam, with his companion ('Soos') Seth; (2) Noah, with Sem; (3) Abraham, with Ismael; (4) Moses, with Aaron. The last of the seven 'silent ones' that followed him was John, the son of Zachariah. The 5th is Jesus, the son of Mary, with Simon 'Kepha'—by them supposed to be Arabic = purity. The 6th of the 'speaking prophets' is Mohammed, the son of Abdallah; with him was Ali, the son of Abu Talib; and he was followed by six other 'silent ones,' who transmitted to each other the secret mysteries of his religion; the last of whom was Ismail, the son of Jafar Sadik. The 7th of the prophets is the 'Chief' or 'Master of the century.' In him culminate and are completed all those sciences which are called 'the Sciences of the Primeval Ones.' It is he who has first fully opened up the inner and mystic meaning of the words of faith; from him, to the exclusion of every one else, their explanation is to be received. He, and he alone, is to be followed, obeyed, and trusted in all things. By utterly submitting to his words and teachings alone, man is in the right path. All the prophets and all their teachings without exception before him are abrogated through him and by him.

In the *fifth* degree, the Koran and its precepts

are made the subjects of discussion. It is proved to the convert how utterly wrong and foolish it is to interpret the words in their usual sense. Here, again, great subtlety is brought to bear upon the disciple. If he be a Persian, he is told that the Arabs are the oppressors of his country, upon which, with other humiliations, they have also imposed the slavish worship of this book. If he be an Arab, his mind is wrought up against the Persians, who, he is told, have appropriated to themselves the pontificate and the sovereignty, that by rights belonged to the Arabs. He is then instructed in a multitude of mystical relations of things depending upon numbers.

The practical religious instruction begins with the *sixth* degree, into which the neophyte only enters when fully prepared in his mind to deny all positive religion, and when he has given the most undoubted pledges of his discretion and silence. Every Koranic precept is now allegorised. Prayer, tithes, pilgrimage, legal purity, and other religious observances, are cautiously and systematically interpreted to mean certain spiritual things only. These precepts, the missionary explains, have only been established 'as enigmas by the philosophical prophets and Imams, who saw in them the only means of keeping the common people in dependence, of exciting them to actions useful to society, of preventing them from hurting each other, and to commit gross crimes.' But by slow degrees, the philosophers, Plato, Aristotle, Pythagoras, and their systems are introduced to the neophyte. They and their systems are contrasted with the Prophet and the Imams, and their dicta. The result is represented as by no means flattering to the latter. He is distinctly shewn the absurdity of a blind belief in so-called historical traditions; it is made clear to him how hearsays and legends differ from reason and the full and free action of the logical faculties: in this way the open contempt with which the Imams themselves are then spoken of, no longer shocks the disciple to any very great extent.

The *seventh* degree paves the way for the negation of God's unity, which is fully carried out in the *eighth*. Here the Demiurgos, i. e., a second god, but little inferior to the Supreme Being, is the real creator of all things. The first Cause, or the 'Pre-existing,' has neither hands nor attributes; no one is to talk of Him, or to render Him any worship. Much as this part of the doctrine has given cause to discussions within the bosom of the I. themselves, it is yet scarcely doubtful that it is the notion of the Demiurgos that has crept in here. Hamza himself speaks of this 'pre-existence' as the Word, or *Logos* (q. v.), although nothing can be more obscure than the manner in which this most abstruse dogma is either explained or denied by the different doctors. The Koran and the 'Word of God' are then taken in hand, and explained to the proselyte in a fashion very different from the one he had been accustomed to before. The resurrection, the end of the world, the supreme judgment, the distribution of rewards and punishments, are treated as allegorical or mystical symbols of the revolutions of the stars and the universe, which follow each other periodically, and of the destruction and reproduction of all things terrestrial, such as physical science and philosophy teach. The *ninth* and concluding degree of initiation frees the proselyte from all and every restraint with regard to his belief. He may, and some do, adopt the system of Manes (see LABES), of the Magi (q. v.), of Aristotle or Plato, or he may proceed eclectically with them all. As to the notions previously instilled into his mind with regard to the prophets or the Imams, he is now led to look upon all those 'inspired' people as without exception inferior to Mohammed ben Ismail,

the chief and doctor of the last period. The disciple learns, at this stage, that no miracle has ever been performed by any one of them; that the prophet is merely a man distinguished by his purity and the perfection of his intelligence, and that this purity of his intelligence is precisely what is called 'prophecy.' God throws into the prophet's mind what pleases Him, and that is what is understood by 'Word of God.' The prophet clothes this word afterwards with flesh and bones, and communicates it to the creatures. He establishes by this means the systems of religious institutions which appear to him the most advantageous for the ruling of men; but these institutions and behests are but temporary, and intended for the preservation of order and worldly interests. No man who *knows* need practise any single one of them; to him, his *knowledge* suffices.

As to Mohammed, the son of Ismail, of whom the proselyte is told at first that he will reappear in this world—he is afterwards represented to him as merely destined to reappear in his doctrine, by means of the propagation of his pure philosophy by the mouth of his disciples and apostles. As to the Arabs themselves, the missionaries teach that God abhors them, on account of their having killed Husein, the son of Ali, and that he has therefore taken from the califs the Imam, as he took from the Israelites the prophetic succession, when they had killed their prophets.

Thus the creed of the I. had been gradually built up. Many changes were introduced into it at different times, and among them, this very important one: That the person of Mohammed, the son of Ismail, itself was changed for another, a descendant of Abdallah, the son of Maimun Kaddah.

The two principal writers on this subject are Makrizi and Nowairi; to the latter of whom the greater part of the foregoing information is due. He has preserved for us at length the very curious oath imposed upon the proselytes at the beginning of the initiation; and also certain instructions reserved for the missionary himself, which simply teach him to 'be all things to all men.' The following is a characteristic sample: 'Then, again, there will be those to whom you must preach the belief in a living Imam. Say Mohammed ben Ismail is alive at this moment. Be very gentle and very modest with them; pretend to despise gold and silver; make them recite fifty prayers a day; recommend them to abstain from lying and other vices, also from wine. These people are of the utmost use to us. Leave them in their special creed, only just telling them some of the mysteries of the number Seven; but break their spirit by the surcharge of prayer. These will be our best proofs against any assertions of an advanced disciple, if he should betray us. Furthermore, these people, when properly managed, are sure to leave you at their death all their money, as they would, during their lifetime, give you everything they possessed without a murmur. The more advanced, you may at once inform of the abrogation of Mohammedanism by our Imam—of the worthlessness of the Koran and its laws in their literal sense. To the still higher disciples, you may confide the entirely spiritual nature of the Imam's "life" in such a manner that their belief in the dogma of the resurrection is practically destroyed by it. From this stage you will conduct some to the renunciation of the belief in the existence of those heavenly beings, the "angels," and the creation of Adam as the first man on earth, while there were many before him. Having arrived at this point, you will find it marvellously easy to destroy the dogma of the existence of God and the mission of angels to

the prophets, and to substitute for all this our own truth—i. e., the eternity of the universe. The last step is the abolition of both Mohammed ben Ismail and Ismail, who are only the "gates" to knowledge.'

So far the doctrines of the I., who, doubtless, aimed—apart from an original desire of purifying and allegorising Mohammedanism, and elevating it to a philosophical system—at political power. How far one of their principal branches, the KARMA-THIANS, succeeded in this, will be found under that heading. See Makrizi, Nowairi, Silvestre de Sacy, *Religion des Druses*, &c.

ITRI, a town of South Italy, in the province of Caserta, six miles north-west of Gaeta, picturesquely situated on a lofty isolated hill, surrounded by a ruined castle. I. was the birthplace of the celebrated bandit, Fra Diavolo. Pop. above 6000.

ITU, a town of Brazil, in the province of San Paulo, and 40 miles north-west of the town of San Paulo, on the Tiete, in one of the most fertile districts of the province, and surrounded by lofty hills. Most of the houses are built of earth or mud in a framework of wood. Sugar-cane is extensively cultivated in the surrounding district. Pop. 10,000.

ITURBIDE, DON AUGUSTIN DE, Emperor of Mexico, was the son of a Biscayan nobleman and a rich Creole, and was born at Valladolid, in Mexico, in 1784, or, according to others, in 1790. On occasion of the first insurrections in Mexico, he was appointed by the viceroy, Apodaca, to the command of the militia of his province, and was successful against the insurgents; but he afterwards inclined more to their cause, and being intrusted by the viceroy with the command of the army in 1821, he went over to them, when he found it impossible to obtain a separate constitution for Mexico. In May 1822, he ascended the throne of Mexico as emperor, under the name of Augustin I., and the Congress declared the crown hereditary in his family. He seemed to aim at ruling well, but rather as a despotic than a constitutional sovereign. His reign was full of trouble, and came to an end in less than a year by his abdication on March 20, 1823. He received a pension of 25,000 piastres from the Congress on condition of his residing in Italy, and went with his family to Leghorn. Having resided a few months in that city, he repaired to England, where he organised an expedition for the recovery of the empire which he had surrendered; and issued a declaration that he would employ whatever influence he might obtain on his return to Mexico for the introduction of the political institutions of England into that country. He embarked May 11, 1824; landed in disguise at the port of Soto-la-Marina, 14th July; was arrested on the 17th, and shot at Padilla on the 19th of the same month. The Mexican Congress made a provision for his family. His son was adopted by the late Emperor Maximilian of Mexico as his heir, Maximilian himself being childless. The overthrow of the Mexican Empire, however, has cut off his prospect of a throne. See *A Statement of some of the Principal Events in the Public Life of Augustin de Iturbide, written by himself*; translated by M. J. Quin (1824).

IVANOVO, a town of Russia, in the government of Vladimir, 160 miles west-north-west of Moscow, on the river Ouvod. The name of I. is found in the annals of the 16th century. In 1741, it came into possession of the Counts Sheremetieff, to whom, at the present day, belongs the territory of I., the pop. of which amounts to 24,000. The pop. of the town proper is about 5500. I. is the centre of the Russian cotton manufacture, which gives employment to a great part of the inhabitants, not only of the town,

JACITARA PALM—JAVA.

but also of the surrounding district. There are also large cotton-printing establishments in the town. The cotton-manufacture of I has increased to a very considerable extent since 1812, in which year, on account of the French invasion, the greater part

of the workmen left Moscow, and settled here. The connection of I, by means of a branch, with the Moscow and Nijni-Novgorod Railway, has given a fresh impulse to the industry and commerce of the place.

J

**JACITARA PALM** (*Desmoncus macroacanthus*), a palm found in the forests of the low lands of the Amazon district in South America. It has a slender flexible stem (see *Desmoncus*), often 60 or 70 feet long. The outer part of the stem, cut into long strips, is much used for making those very strong and elastic plaited cylinders in which the grated root of the mandioc (cassava or tapioca) is squeezed, to free it from its poisonous juice. It might probably be found useful for many other purposes, and seems eminently suitable for many kinds of wicker-work.

**JACOVA**, or **YAKOVA**, a town of European Turkey, Albania, in the pashalic of Scutari, on the White Drin, 20 miles north-west of Prizrend. Pop. 18,000.

**JANKOVACZ**, a town of the Austrian Empire, in the county of Bacu, 81 miles south-south-east from Pesth. The surrounding country is level and fertile. Pop. (1869) 7890.

**JAULNA**, a town of India, in the Deccan, Nizam's dominions, situated on a gently sloping declivity, in a rugged country, 38 miles east of Arungabad. It has a fort and cantonment for British troops. The climate is healthy, and favourable for the production of vegetables and fruits. On the opposite bank is the old town of J., now much decayed, but formerly large and flourishing, having enjoyed an extensive trade in grain and silks. It yet possesses to some extent a manufacture of silks for native use. Pop. 10,000, of whom about a fifth are Mussulmans.

**JAVA, THE ISLAND OF.** In addition to the information given in the general and special articles on J., the following details seem desirable. On 1st Jan. 1874, the pop. of the residencies or governmental divisions amounted to:

Residencies.	Natives.	Euro-peans.	Chinese.	Arabs, &c.	Total.
Bagalen, . . .	1,151,145	441	2,549	106	1,154,241
Banjoemaas, . . .	916,005	456	3,567	154	920,182
Banjoewangi, . . .	86,685	163	235	337	87,410
Bantam, . . .	711,277	270	1,699	594	713,840
Batavia, . . .	907,426	6,081	69,397	964	983,868
Buitenzorg, } . . .					
Bezoeki, . . .	387,046	384	866	385	388,681
Cheribon, . . .	1,092,465	761	15,140	1,511	1,109,867
Djokjokarta, . . .	413,126	1,242	1,839	123	416,330
Japara, . . .	791,991	509	10,110	628	803,238
Kadoe, . . .	688,650	377	5,118	68	694,213
Kediri, . . .	604,377	664	5,681	....	610,672
Krawang, . . .	243,284	272	3,228	22	246,806
Madloet, } . . .					
Patjitan, } . . .					
Paseroewan, . . .	595,373	1,240	4,234	1,778	602,585
Pekalongan, . . .	485,435	487	4,463	933	491,308
Preanger Regencies, . . .	1,163,271	649	934	58	1,164,912
Probolinggo, . . .	406,127	653	1,647	1,159	409,586
Samarang, . . .	1,298,646	3,060	15,185	3,097	1,319,978
Surabaya, . . .	1,507,367	5,348	10,618	2,924	1,526,148
Surakarta, . . .	819,277	1,906	5,167	210	826,560
Tagal, . . .	844,928	518	5,364	802	851,612
Total, . . .	16,826,312	26,531	185,056	16,898	17,064,797
Madura, Island of, . . .	719,238	478	5,547	6,058	731,321

In 1864, the pop. of Java and Madura was 13,917,368; in 1874, it had risen to 17,786,118.

Banjoewangi, Buitenzorg, Krawang, and Patjitan are assistant-residencies; Djokjokarta and Surakarta are called the Vorstenlanden (Lands of the Princes), the former having a native sultan, the latter an emperor, who are vassals of the Dutch.

On the 10th of June 1867, an earthquake caused the loss of about 300 lives and a vast amount of property in several of the residencies, especially in Djokjokarta. The mountains are chiefly volcanic. The highest are Sméru or Mahaméru, in the residency Paseroewan, which is 12,250 feet high, and Slamet in Tagal, 11,320. Sulphur, almost pure, is abundant.

Bagalen is one of the most fertile residencies, and produces coffee, indigo, tea, cinnamon, rice, tobacco, sugar, maize, cotton, cocoa-nuts, and a great variety of fruits. The forests contain much fine teak. Besides agriculture, the principal industries are weaving, dyeing blue, rope-spinning, making pottery, nets, paper, and mats. In 1874, there were belonging to the government, 17,333,011 coffee-trees producing 47,526 cwts. of coffee. Tea and cinnamon are also largely grown, and indigo manufactured.

Banjoemaas (oe, pron. o) is very mountainous towards the north and north-east. Banjoemaas, the capital of the residency, situated in a valley on the left bank of the Serajo, in 109° 19' 20" E. long, and 7° 33' 45" S. lat., is a regularly built town.

Banjoewangi, an assistant-residency, in the eastern part of the island, is mountainous, well wooded, and fertile. The forests abound in fine timber-trees. Banjoewangi, the capital, lies on the Strait of Bali, in 114° 26' E. long, and 8° 12' 40" S. lat., and is a beautiful little town of 8000 inhabitants.

Bantam, a residency in the west corner of J., is low and marshy on the north coast. Towards the interior, it gradually becomes mountainous, with the most beautiful valleys between the heights. The south coast is wild and rocky, and on the west side are impassable wildernesses, swarming with wild beasts. The soil is generally fertile, producing the usual crops of the island. Bantam, the former capital of the once powerful kingdom of that name, is now little more than a village, in which the remains of former grandeur are to be seen. The resident has his seat at Serang, a large village, in 106° 8' 37" E. long., and 6° 6' 45" S. lat.

Bezoeki, on the east coast, is mountainous, and clothed with a luxuriant vegetation.

Buitenzorg, an assistant-residency, is very healthy, and often has a favourable influence on the sick from other districts of J., especially of Batavia, to which it is contiguous. Buitenzorg, the capital, is 883 feet above the sea-level, and is one of the most pleasant places in the island.

Cheribon is a very extensive and beautiful residency, and derives its name from that of the capital, which is a corruption of Tji-ribon, or river Ribon, on which it is built. Cheribon, the capital, in 108° 38' E. long., and 6° 45' S. lat., was once a flourishing place, but has been for some time retrograding.

Djokjokarta produces the usual crops. The natives are much addicted to the use of opium.



The productive power of the population is therefore less than in other districts of the island. Djokjokarta, the capital, is situated on the right bank of the Oepak, in 110° 21' 30" E. long., and 7° 46' S. lat., at the south-south-west base of the mountain Merapi. The city is large, and regularly built. It is the seat of the sultan, the resident, and assistant-resident. Pop. 50,000, of whom 600 are Europeans.

Japara, on the north coast, has a very warm climate in the interior, and though vegetation is in general luxuriant, yet scarcity of water is sometimes felt. The resident has his seat at Pati, in 110° 56' 7" E. long., and 6° 45' 30" S. lat., which is regularly built, and has a pop. of 10,000.

Kadoe—i. e., hollow—is a large basin formed by lofty mountains, of which Soembing is 10,911 feet high, and the Sindoro 10,312. It is one of the smallest residencies of J., but densely peopled. Its fertility is increased by the abundance of water flowing from the surrounding mountains. The amount of coffee produced is very great; in 1874, the fruit-bearing trees numbered 32,903,125, producing 90,271 cwts. of coffee. Beautiful marble is found in great quantities. The capital is Magelang, situated on the east bank of the Progo, in 110° 10' 7" E. long., and 7° 29' S. lat. Pop. 34,000.

Kediri consists of a plain bounded by mountains on the north, east, and west. The navigable river Brantas, which flows through a great part of the residency before falling into the sea at Surabaya, affords great trading facilities. The people, however, are low in the scale of activity and morality, which may partly result from Kediri having been, under the former Javan princes, a penal colony. They are greater slaves to opium than any other people in the Indian Archipelago. Kediri, the seat of the resident, is situated on the right bank of the river Kediri, 600 feet broad, which higher up is called the Brantas. The streets are broad and planted on both sides with tamarind trees.

Pasoeroewan, which is washed by the Strait of Madura, has important fisheries, and is famed for its race of horses. Pasoeroewan, the capital of the residency, is situated near the sea, on the river Gemboug, in 112° 55' 2" E. long., and 7° 38' 40" S. lat.

The Preanger Regencies are partly occupied with mountains, forming two chains. Between these are many extensive valleys of the richest soil. The mountains are of basalt. There are many rivers, of which five are navigable. The numerous lakes give good supplies of fish and water-fowls. The bays on the coast are also frequented by fishing-boats. The mountains are covered with coffee plantations to 3000 feet above the sea-level, while the low and marshy grounds produce rice abundantly, and the villages are hid with cocoa-nut palms and other fruit-trees. In no other residency is the tea-culture so extensive. The forests produce good timber, the bamboo attaining a height of 80 feet. There are rhinoceroses, tigers, harts, wild swine, &c., and birds of great variety and beauty. The natives are honourable, simple, and obedient, and subsist from the growing of coffee, rice, fruits, &c., the rearing of horses and buffaloes, making spinning-wheels, mats, gold and silver work, &c. The women weave very beautiful cotton cloth. Coffee and tea, and later, also cinchona, are the only products raised for the government.

Probolinggo, in 1874, produced 400,686 cwts. sugar and 43,359 cwts. coffee. Forests containing many teak trees cover the south coast. There are tigers, wild dogs, monkeys, squirrels, &c. Probolinggo, the capital, lies on the coast, in 109° 21' 45" E. long., and 7° 23' 22" S. lat., and is extensive and populous. From this port, much of the produce of the land is shipped for the Netherlands.

Rembang produces the usual crops. The northern parts are dry and sandy; and in the south are extensive forests, abounding in teak and other valuable timber trees. The residency is washed by the Java Sea, and the people on the coast find their living by trade, fishing, and ship-building. Rembang, the capital, is regularly built, and besides the public offices, has a small Protestant church, a government school, and an institution for the education of girls.

See SAMARANG, SURABAYA, and SURAKARTA.

Tagal is very fertile. It is washed on the north by the Java Sea, and the fisheries are important. In the south of the residency is the volcano Slamet, 11,320 feet high, which is clothed with forest to the height of 8500 feet, and on the southern side descends by regular terraces to the bed of the river Serajoe. Tagal, the capital, is a small but neatly built town, with a considerable coasting-trade. The natives are industrious and good handicraftsmen.

JAWOROW, a town of the Austrian Empire, in the province of East Galicia, 28 miles north-west from Lemberg, on the Krakowska, an affluent of the San, which itself is a branch of the Vistula. Close by the town is a lake, abounding in fish. J. is built in the form of a square, and has extensive suburbs. It has mineral springs. Near it are large paper-mills. Many of the inhabitants are Jews. Pop. (1869) 8699.

JAY, WILLIAM, an English Independent or Congregational minister, of much celebrity for his pulpit eloquence, and as a voluminous writer of devotional, practical, and other religious works. He was born, May 8, 1769, at Tisbury, in Wiltshire. His father was a stone-cutter and mason, and young Jay's first employment was that of a mason's boy; but whilst still young he was sent to Marlborough Academy, an institution of the Congregationalists for the training of young men for the ministry. According to a custom prevalent amongst the Congregationalists, he was sent out to preach in country villages almost in his boyhood—in fact, before he was 16 years of age. His education being completed, he officiated for a year in a chapel at Clifton; and in 1791, was settled as pastor of a 'church' in Bath, which position he occupied for 62 years. He retired from it in January 1853, and died on December 27 of the same year, at the age of 84. Mr Jay's published works, in general, attained to a rapid and very extensive popularity. Among them are *Sermons*, *Family Prayers*, *Morning and Evening Exercises*, *Mornings with Jesus*, an *Essay on Marriage*, *Memoirs of the Rev. Cornelius Winter*, *Memoirs of the Rev. John Clark*, *Lectures on Female Scripture Characters*, and an *Autobiography*. A collected edition of his works, in 12 vols., revised by himself, was published in 1841, but is of course incomplete, some of his works being of more recent date.

JEISK, or EISK, a town of Russia, in the country of the Kuban Cossacks, or Black Sea Cossacks, on the eastern shore of the Sea of Azov, 60 miles south-west from Azov. It stands on the shore of a small land-locked bay, into which flows the river Jeisk. It was founded by imperial ukase in 1848, with a view to its being a trading seaport, and an entrepôt for the agricultural produce of the surrounding country. Considerable privileges were guaranteed to its inhabitants, and it has rapidly sprung into importance. Pop. (1867) 28,070.

JE'SI, or IESI (anc. *Esium*, or *Esia*), a prosperous manufacturing town of Central Italy, in the province of Ancona, and 15 miles south-west of the city of Ancona, on the left bank of the river Esina. It is surrounded by walls, has a cathedral, and several other churches and convents. It has manufactures of paper, silk, and

woollen hosiery and linen, and a large trade in wine and olives. J. is the birthplace of the German emperor Frederick II. Pop. about 20,000.

**JEW'S EAR** (*Exidium auricula Judee*), a fungus, one of the *Hymenomycetes*, which grows on decaying parts of living trees, particularly alders. It is a native of Britain. In size and form it bears some resemblance to a human ear. It is soft but cartilaginous, wrinkled, and generally brown. It is stemless. The spores are produced on the upper surface. The under surface is fibrous and downy. J. E. was formerly in repute as a topical discutient and astringent. It may be kept long in a dried state. It is still sold in the shops, but *Polyporus versicolor* is often substituted for it. The genuine J. E., after being dried, swells when immersed in water; the *Polyporus* does not.

**JIKA'DAZE**, or **SHIKATZE**, a town of Tibet, capital of the district Zang, on the right bank of the Zangbo, 190 miles west of Lassa. Pop. estimated at 100,000.

**JIMENA**, or **XIMENA**, a town of Spain, in the province, and 50 miles east of Cadiz, on the east declivity of the Sierra de Gazules. The town is regularly built, the streets steep, but clean. There are several churches and schools, a prison, town-house, &c. There are manufactures of leather, linen, earthenware, &c., and a trade in fruit and wine. Pop. 5878.

**JO'ACHIM**, **JOSEPH**, an eminent Hungarian violinist, was born in the neighbourhood of Presburg in 1831, received his early instruction at Pesth under Szervawinsky, director of the orchestra at the theatre there, and made his debut in public at the age of seven. He afterwards became the pupil of Böhm at Vienna, and at Leipzig studied counterpoint under Hauptmann, and made the friendship of Mendelssohn. His first appearance in London was in 1844, when, though only in his 14th year, he was at once allowed to be one of the most distinguished of contemporary violinists. His performances at Vienna, Pesth, Paris, and London have since established for him the position of the first violinist of the day. In power and brilliancy of execution, and all the mechanical qualities of playing, he is little if at all behind Paganini. His works, which include overtures, Hebrew melodies and other songs, and compositions for the violin, are pervaded by the same tenderness and depth of musical feeling that characterise his playing. In 1869, J. became a member of the senate of the Berlin Academy, and was appointed a director in the Conservatory of Music there. In 1877, J. received the degree of Mus. Doc. from the university of Oxford.

**JO'ACHIMSTHAL**, a town of Bohemia, near the frontier of Saxony, 69 miles west-north-west from Prague. It is situated in a valley, on the Weseritz, a feeder of the Eger, which itself flows into the Elbe, near the eastern opening of a remarkable gorge or pass among the lofty Erzgebirge, and at an elevation of 2366 feet above the sea. The town has a strange antique appearance, and the Rathhaus is a very remarkable building. J. was formerly of greater importance than now, owing to its mines of silver, which are still wrought, but are not so productive as they once were. The produce of the silver-mines of J. in the 16th c. was, at an average, 21,897 marks. For about a century before 1852, the average produce was only 3181 marks; and from 1852 to 1862, it was 3232 marks. Silver-mines have been wrought at J. from a very remote period; one mine is 300 fathoms deep. The whole number of miners employed at J. in the 16th c. was about 12,000, with 400 overseers and other

officials, and 800 surveyors. Besides the silver obtained from the mines of this neighbourhood, it produces also lead, tin, and iron to a considerable amount. J. is the seat of offices and courts of mines. Dollars (*thalers*) were first coined here, and hence their name (see **DOLLAR**). Goitre and cretinism are lamentably prevalent at Joachimsthal. Much coarse lace is made in the surrounding mountainous district. Pop. (1869) 6586.

**JOE MILLER'S JESTS**, or the **WIT'S VADE-MECUM**, a well-known collection of facetiae, first published in 1739. A great proportion of the good things which this book contained appears to have been the product of the period immediately preceding its publication. They are more often humorous than witty, and they seem to have been all the more popular on account of a profusion of coarseness and indecency, such as the taste of the present age could not endure. A second edition of the *Jests* was called for in the year of the first publication; they came to a fourth edition in the following year; and the work, growing in size at every fresh appearance, had reached its 14th edition by 1760. Innumerable issues of it, or of works founded upon it, bearing the same or similar titles, have since been published in England and America. It has, in many cases, been modified more or less, to suit the growing nicety of the public—with detriment, it must be said, to the quality of its humour; and, indeed, it would almost seem as if humour flourished upon obscenity as flowers do upon manure. A lithographic fac-simile of the first edition, which is now exceedingly rare—there is no copy in the British Museum—was published in 1861. The exact title was as follows: '*Joe Miller's Jests, or the Wit's Vade-mecum; being a Collection of the most Brilliant Jests, the Politest Repartees, the most Elegant Bons-mots, and most Pleasant Short Stories in the English Language.*' First carefully collected in the Company, and many of them transcribed from the Mouth, of the Facetious Gentleman whose name they bear; and now set forth and published by his Lamentable Friend and Former Companion, Elijah Jenkins, Esq.; most humbly inscribed to those Choice Spirits of the Age, Captain Bodens, Mr Alexander Pope, Mr Professor Lacy, Mr Orator Henley, and Job Baker, the Kettle-drummer. London, T. Read, Dogwell Court, Whitefriars, Fleet Street, 1739.'

The Joe Miller whose name has been handed down in connection with this compilation of jests was Joseph Miller, an eminent comic actor, reputed among the tavern-haunters of his time as a fellow of infinite humour. He was born, it is believed, in London, in 1684; he died in London in 1738, and was buried in the churchyard of St Clement Danes in the Strand, where there is a tombstone erected to his memory, bearing an epitaph by Stephen Duck. He was a great favourite with the public, and is said to have contributed by his acting to the popularity of Congreve's plays. Ben in *Love for Love*, Sir Joseph Wittol in the *Old Bachelor*, and Teague in the *Committee*, were the characters in which he was most successful; his portrait was painted in the last two of these. The compiler of the *Jests* was John Mottley, an author of no great reputation, who is said to have amused himself by writing down or dictating them at a time when he was laid up with the gout. Mottley was the son of a Colonel Mottley, who, having been high in favour with James II., followed James into exile, got a command in the service of Louis XIV., and was killed at the battle of Turin in 1708. Colonel Mottley had married before the Revolution a Gloucestershire lady of considerable fortune. His wife—her family being zealous for the Revolution—

refused to accompany him to St Germain. Three or four years later, he made a stay of considerable length in England upon a secret commission from James; and his son, the compiler of the *Jests*, was born in London in 1692. Mottley was educated at St Martin's Library-school in London; and, through the influence of Viscount Howe, who was a connection of his mother, he got, at the age of sixteen, a place in the Excise Office. This place he lost in 1720, apparently through some involvement in the bubble speculations of that year; and afterwards, though he had promises both from Lord Halifax and from Sir Robert Walpole, he never succeeded in obtaining an office. He had to live by his wits, and he produced five or six plays—the first of them named the *Imperial Captive*—which met with some success. He seems to have owed not a little to the patronage he received from people of fashion and from the court. In 1739, the year in which he produced *Joe Miller's Jests*, he also published a *Life of the great Czar Peter*, in 3 vols. 8vo. This work was published by subscription, and had the support of the royal family, and of a great number of the nobility and gentry. He followed it up in 1744 with the *History of the Life and Reign of the Empress Catharine of Russia*, 2 vols. 8vo. These works were mere compilations from the journals and other publications of the time; but with the lapse of time they have acquired some value, through the scarcity or disappearance of the authorities upon which they were founded. Mottley died on the 3d of October 1750.

JOHNSON, ANDREW, seventeenth President of the United States of America, was born at Raleigh, North Carolina, December 29, 1806. At the age of four years, he lost his father, who was drowned in attempting to save the life of a friend; and when ten years old, he was apprenticed to a tailor, whom he served for seven years, receiving no schooling. A visitor to the shop where he worked used to read aloud from a collection of speeches of British statesmen. This aroused young J.'s interest and ambition; he learned the alphabet, borrowed the book, and with the aid of a journeyman, learned to read, working at it two or three hours every night. At the expiration of his apprenticeship, he worked for two years as a journeyman at Laurens Court House, South Carolina; but a love-disappointment, caused by his humble position, induced him in 1826 to emigrate to Greenville, Tennessee, where he soon after married, and his wife taught him writing and arithmetic. In 1828, he was elected to his first office—alderman of the village; in 1830, he was chosen mayor, and twice re-elected; in 1835, he was elected to the state legislature, and again in 1839; in 1840, he was a presidential elector, and canvassed the state for Mr Van Buren, the Democratic candidate; in 1841, he was elected to the state senate; and in 1843, to the Congress of the United States, where for ten years he supported the policy of the Democratic party. In 1853, he was elected governor of Tennessee, and again in 1855. In 1857, he was elected by the legislature a member of the United States Senate, in which he advocated the union policy of the Republican party; and on the occupation of Nashville by the Federals, 1862, was appointed by President Lincoln military governor of Tennessee. In this position he gave so much satisfaction to the North, that in 1864 he was nominated by the Republican party for the office of vice-president, and was elected with President Lincoln, then re-elected for his second term, and took the oath of office, March 4, 1865. On the 14th of April, by the assassination of President Lincoln, he succeeded to the presidency, but soon disappointed his party by taking a

moderate, conservative course, scrupulously respecting his oath to support the constitution. In 1866, his policy appeared for a time likely to meet with popular favour; but some indiscreet and violent speeches, during a tour to Chicago and St Louis, turned the tide against him, and in the congressional elections his opponents triumphed by increased majorities. His vetoes were generally nullified by the two-thirds votes of both Houses. In 1867, J. suspended Mr Stanton, secretary of war, who was reinstated by the Senate the following year. An attempted *coup d'état* to gain possession of the War Office during this quarrel, led to the impeachment of the President in 1868, but he was acquitted. His term of office expired in 1869; and afterwards J. unsuccessfully sought to be governor of Tennessee and United States senator. He died in 1875. See *Life of Andrew Johnson* (New York, 1866); *The Trial of Andrew Johnson* (official), 3 vols., 1868.

JOONAGHUR, a town of India, province of Gujerat, on the peninsula of Kattywar, 235 miles north-west of Bombay. It is advantageously situated on a ridge of sandstone, is surrounded by walls five miles in circumference, and has a citadel and a mosque. The town is ill built and dirty, and only about a half of the space within the walls is occupied. The trade is insignificant. Pop. variously estimated at from 5000 to 30,000.

JUAREZ, BENITO, late President of the Mexican Republic, was born at Ixtlan, of Indian parents, about the year 1807. Notwithstanding disadvantages of birth, he succeeded in establishing a reputation as an advocate, became governor of his native state, Oaxaca (1848—1852), and an active member of the liberal party. Exiled during the dictatorship of Santa Anna, he returned when the republic was restored, was elected to the new congress (1856), and appointed President of the Supreme Court in 1857, and consequently, in case of vacancy by death or default, President *ad interim* of the republic.

On the overthrow of the liberal President, Comafort, by Zuloaga and the clerical party (January 1858), J. refused to recognise the usurper, and finally established himself at Vera Cruz, by holding which he secured the receipt of the customs dues—in other words, of the larger half of the entire state revenue. Here he set up a provisional government, styling himself Constitutional President, and issuing decrees for the confiscation of the property of the church, the institution of civil marriage, &c. in accordance with the reforms carried by Comafort in 1857. Meanwhile, Miramon, who had superseded Zuloaga (January 1859), prepared to take the field against his rival. His movements were, however, delayed by a counter-rising of Juarista in Mexico; and before he again advanced, J. had secured recognition from the United States by conceding the protectorate (refused to them by Miramon) over the proposed transit routes in the north and in the isthmus of Tehuantepec. Early in 1860, Miramon besieged Vera Cruz, but his army suffered from want of supplies, his transports were intercepted by the United States ship-of-war *Saratoga*, and after a few weeks, he was compelled to retire with loss. J. now assumed the offensive. At San Miguelito, Miramon was totally defeated by Ortega, and fled to Europe. His rival entered Mexico (January 1861), caused himself in June to be formally elected president for four years, and proceeded to execute the decrees against the clergy with great severity. But the finances of Mexico were now in a state of disorder, which even the wholesale confiscation of church lands could not remedy. In July 1861, the government decreed

suspension of payment for two years of the indemnities due to England and France, and formally secured by the hypothecation of the customs dues. This act, coming at the end of a long series of outrages (mainly the work of Miramon and his faction), led to the intervention of the allied powers, and the occupation of Vera Cruz by England, France, and Spain. But it soon appeared that the French aimed at more than a simple redress of grievances. The appearance of the clerical chiefs Miramon and Almonte in their camp, and the extravagant demands of M. de Soligny, rendered any arrangement impossible. The failure of the negotiations at Soledad (February 1862) was followed by the conference of Orizaba (April 9), in which England and Spain formally withdrew. France now threw off the mask, and J. appealed to the country, proclaiming a guerrilla war, and concluding a loan of 25,000,000 dollars with the American minister, Corwyn. The victory of Zaragoza at Puebla (May 5, 1862) raised the hopes of the Mexicans; but fresh troops arrived from France. Puebla fell (May 18, 1863), after a gallant resistance. Mexico and San Luis de Potosi followed, and in 1864 the republican government was removed to Monterey. The arrival of Maximilian in May was succeeded by further losses from battle and desertion. In August, J. sent his family to New Orleans, but 'le petit Indien' himself still held on, although forced back on Chihuahua, and thence a year after across the frontier. His four years of office had also expired, and Maximilian availed himself of these events to issue the fatal decree of October 1865, in which he declared the republic extinct *de jure et de facto*, and sentenced to death all Juarist leaders taken in arms. J. proclaimed in answer that he held office until the expulsion of the invaders rendered a fresh election practicable. By this time the complete pacification of the Southern States enabled the Washington cabinet (which had persistently recognised J.) to interfere effectually on his behalf. Under diplomatic pressure (1866), Napoleon withdrew his troops, and the positions evacuated by the French were immediately occupied by the republicans. The unhappy Maximilian made a final stand in Queretaro, but was betrayed by Lopez, and shot (June 19, 1867) by order of court-martial—an ungenerous but not unjustifiable act of reprisal which J., it is said, would have been unable to prevent. Mexico and Vera Cruz were reoccupied shortly after, and the triumph of the liberals was consummated by the re-election of J. to the presidency (October 1867), after a ten years' struggle, in which he had successfully maintained the constitution of 1857, under which he took office, against domestic treason and foreign intervention. He was re-elected President in October 1871, and held office till he died, June 18, 1872. J., as governor of Oaxaca, was universally esteemed, and his honesty as a reformer has been attested by the British chargé d'affaires (Mr Mathew's Report, 1861), and by all the leading men in the United States.

JUJUY, a town of the Argentine Confederation, South America, on a river and in a province of the same name, about 300 miles north-north-west of Santiago. It is said to be a place of some trade, being on the main route from Salta across the mountains into Bolivia. Pop. about 7000.

JULALPUR, a town of India, capital of the pergunnah of the same name, 100 miles south-west of Lucknow, on the river Betwa. It is said to be a place of some importance, and to contain a pop. of 10,000. The country to the south is wild and sterile, being much cut up by ravines.

JULIA, the only child of the Roman emperor Augustus, was his daughter by his second wife, Scribonia, and was born 39 B.C. She was only a few days old when her mother was divorced. She was educated with great strictness; was distinguished for her beauty, talents, accomplishments, and agreeable manners; and was married at a very early age, 25 B.C., to her cousin, Marcus Claudius Marcellus, the sister's son of Augustus. After his death, she was again married, when little more than 17 years of age, to Marcus Vipsanius Agrippa, to whom she bore three sons and two daughters. He dying, 12 B.C., J. was given in marriage, 11 B.C., to Tiberius; his mother, Livia, the stepmother of J., persuading Augustus to this, in order to secure the succession of Tiberius to the throne. The marriage was an unhappy one, and the conduct of J. far from irreproachable; but Livia's hatred induced her to make exaggerated accusations to Augustus, and she so wrought upon his mind, that he astonished all Rome by suddenly declaring, 2 B.C., that his daughter had so far forgotten herself as to be guilty of the most shameless adulteries, making even the Forum the scene of her nightly vice. In this charge there seems to have been too much truth; but it is doubtful if there was any truth in the allegation further made that J. and her paramours had entered into a conspiracy against the life of the emperor. J. was banished to the isle of Pandataria (now Ventotiene), near Naples, and a number of persons of high rank were put to death or banished for their alleged participation in her guilt. From Pandataria, whither her mother, Scribonia, accompanied her, she was removed to Rhegium (now Reggio), where she was allowed by Tiberius to remain destitute even of common comforts, till her death, 14 A.D. Her son, Agrippa, was put to death by Tiberius in 14 A.D., shortly before the death of his mother. Her other sons died in early age. Her daughters survived her. The elder, Julia, died, 28 A.D., in the isle of Trimetus, on the coast of Apulia, whither she had been banished by Augustus twenty years before for adultery. The younger, the virtuous Agrippina (q. v.) died in 33 A.D., in Pandataria, to which she had been banished by Tiberius.

JÜLICH, or, in the French form of the name, JULIERS, a town of Rhenish Prussia, 16 miles north-east from Aix-la-Chapelle, on the Roer. J. is situated in a fertile plain, but surrounded by marshes, which make it very unhealthy. It is said to be of Roman origin, and was strongly fortified till 1860, when the fortifications were demolished. The principal branch of industry is the manufacture of leather. Pop. (1871) 3000.—J. was long the capital of an independent duchy; and J. and Berg (q. v.) were united as possessions of the same family. On the death of the Duke of J. in 1609, began a dispute as to the succession, which was not settled till 1666, when a decision was given in favour of the House of Pfalz-Neuburg—the Elector of Brandenburg obtaining Cleves and some of the other territories formerly united with J. and Berg. The Pfalz-Neuburg family becoming extinct in 1742, J. passed to the Pfalz-Salzbach branch, afterwards electors of Bavaria. By the peace of Luneville, it was annexed to France, as part of the dep. of Roer; and in 1814, was assigned to Prussia by the Congress of Vienna.

JUMPING HARE (*Pedetes* or *Helamys Capensis*), a South African rodent, *Spring Haas* of the Dutch colonists, generally placed near the jerboas in systems of zoology, but very considerably differing from them. The head much resembles that of

## JUNGLE—JUTE MANUFACTURES.

a hare, although the ears are shorter; the form of the body is also like that of a hare, but the hind-legs are very long and strong, like those of a kangaroo, and the toes both of fore and hind feet are armed with great claws. Its powers of leaping are



Jumping Hare (*Helamys Capensis*).

extraordinary; it clears 20 or 30 feet at a bound. Night is its time of activity, and it makes mischievous inroads on fields and gardens. Its flesh is eaten.

**JUNGLE**, a term now fully adopted into the English language, but of Bengalese origin, and employed to designate those thickets of trees, shrubs, and reeds, which abound in many parts of India, and particularly in the unhealthy tract called Terai or Tarayani, along the southern base of the Himalaya; and in the Sunderbunds (q. v.) at the mouth of the Ganges. The jungles are often impassable, from the thick growth of underwood, tall grasses, and climbing plants. The soil is generally swampy, and fever and other diseases abound. Tigers, and other beasts of prey, elephants, boars, deer, and other quadrupeds are found in great numbers in these thickets, with gigantic snakes, and multitudes of monkeys. The jungle flora and fauna are very peculiar, and the moisture and heat carry a tropical vegetation beyond its usual limits northward to the lower valleys of the Himalaya.

**JUNGLY GAU** (*Bos Sylhetanus*), a species of ox, inhabiting Sylhet and other mountainous parts of the north-east of India. It is nearly allied to the Gayal (q. v.) and to the common ox, and has more the appearance of some of the European domesticated breeds of ox than any of the other wild oxen of Asia. The J. G., although in a wild state it is only to be seen in places remote from the habitations of man, and flees from the encroachments of cultivation, is easily domesticated. Its milk is very abundant, and of excellent quality.

**JUTE MANUFACTURES.** The extensive and daily increasing use of jute as a textile material, has induced us to give a brief notice of its manufacture into fabrics, by way of supplementing what has been already said under the head **JUTE**. This now gigantic industry has sprung up so rapidly, one might almost say so stealthily, that comparatively few persons are aware of its importance, and many have never even heard of the fibre at all. For some thirty years back, the Dundee mill-owners have been gradually employing it more and more to mix with flax, until there is scarcely one of them who does not use it largely, and the majority now use it entirely. Jute is more brittle than flax, and will

not spin so fine, nor wear so well; but then it is only about half the price, and when woven, is attractive enough in appearance. In India, it has been manufactured by the natives into gunny-cloth for centuries.

The jute-plant is very largely cultivated in Bengal, and the fibre is prepared there for exportation by the process of water-retting. Jute of a fine glossy appearance brings the highest price in the market. It is spun by processes similar to those employed for flax, but as it is from 10 to 15 feet long, it is necessary to cut it into 3-feet lengths before it can be heckled. The fibre also requires to be saturated with whale-oil and water, so as to soften and render it more elastic, preparatory to spinning. Heckling is the first of the spinning operations, and its object is to remove the coarser portions of the jute, and lay the fibres in parallel order. The heckle is a kind of comb, with sharp-pointed steel teeth, from one to two inches in length. Formerly, the process was done by hand, but now heckling-machines are used. The heckled stricks are next taken to the *spreader*, or first drawing-frame, where they are spread upon an endless creeping-sheet, so as to supply the jute continuously to another part of the machine, where, by a peculiar arrangement of rollers, it is drawn out, through combs of closely-ranged steel pins, into a continuous ribbon, called a *sliver*. A number—say, 14—of these slivers are then taken to another drawing-machine, with steel combs, and drawn out into one. In like manner, some 20 of these slivers are again drawn into one. The first sliver from the spreader has thus, so to speak, been drawn out 280



*Jute* (*Corchorus capsularis*):  
a, capsule; b, flower.

times its original length; and by continuing this doubling and drawing, the fibres become thoroughly parallel and equalised. The sliver from the last drawing-frame is still further drawn out, and at the same time receives a slight twist in the roving-frame. Finally, the bobbins of 'rove' are taken to the spinning-frame, and spun into yarn upon the 'throstle' principle.

Just as in the case of flax, the jute tow from the heckling process is also spun into yarn, in which

case it is first carded by means of a 'breaker' and 'finisher' card, and then *drawn, roved, and spun*, as above described. Indeed, a great deal of jute, as imported, is treated in this way without being heckled at all.

The larger portion of jute fabrics are woven from yarn of the natural colour; but for some purposes it is bleached; and when used for carpets, it is dyed various colours. It bleaches with difficulty, but it is easily dyed. Among the various kinds of jute-cloth made, Hessian sheetings for packing all kinds of merchandise are most largely produced; but sackings, baggings, osnaburges, ducks, carpetings, mattings, and several other stuffs are likewise extensively manufactured. It is also intermixed with flax, cotton, and wool for various union fabrics. Jute carpets are produced at a wonderfully low price. The better qualities of these are comfortable, and even beautiful, so long as they keep their colour; but herein lies their great defect, since most dyes have hitherto been found to be comparatively fugitive upon jute. It is affirmed that some colours can now be rendered permanent when dyed by complex and somewhat expensive processes.

For many years after the introduction of jute in 1833, Dundee was the only place in Great Britain where it was manufactured; but now, considerable

quantities of jute goods are made in London, Manchester, and Glasgow. The manufacture has also spread over the continent of Europe. Of late, several large works have been erected in Calcutta for spinning and weaving jute by English machinery. Dundee is still, however, the great centre of the trade; and there the consumpt of the raw material, which, in 1836, was only 300 tons, amounted in 1873 to 143,150 tons, or fully 1,000,000 bales. The number of persons employed in its manufacture in that town is upwards of 40,000, and it will give an idea of the vast size of some of the larger jute-mills to state that the one belonging to Messrs Cox Brothers occupies 14 acres of ground, the aggregate power of the steam-engines is 1350 horses, and the hands employed amount to between three and four thousand. In one of the weaving-rooms of this mill there are 800 power-looms; and like several of the large Dundee factories, it contains within itself an iron foundry, a smithy, fitting-shops, and, in short, all the departments of an extensive engineering establishment. The total quantity of jute imported into Great Britain in 1875 was 170,850 tons, valued at £2,576,525. After opium, jute now forms the next great staple of the maritime trade of Calcutta, which exports jute to the value of 4½ millions annually.

K

**K**ADO'M, a town of Russia, in the government of Tambov, and 140 miles north-north-east of the town of Tambov, on the river Moshka. The houses are built chiefly of wood, and the principal trade is in honey. Pop., mostly of Tartar descent, (1867) 6507.

**KAKAPO**, or **OWL PARROT** (*Strigops habroptilus*), a remarkable bird, a native of New Zealand, belonging to the Parrot family (*Psittacidae*), but of very owl-like appearance, and,

gloomy weather. The K. takes possession of a hole, where one exists, among stones or the roots of trees, but seems also to have the power of making a burrow for itself. Dogs take it in its hole, although it makes some resistance; but, after a little experience, they learn how to deal with it. It is also pursued and taken by dogs when running on the ground. The flesh of the K. is more pleasant and delicate than that of any other parrot. This interesting bird has almost disappeared from the northern island of New Zealand, and is much more rare in the middle island than it was not many years ago. It will probably soon be extinct, unless means are adopted for its protection. It is the only known bird having large wings which does not use them for flight.

**KANGAROO APPLE**, a species of Solanum (q. v.), (*S. laciniatum*), with a somewhat shrubby succulent stem, smooth pinnatifid or entire leaves, and lateral racemes of flowers; a native of Peru, New Zealand, Australia, and Tasmania, in which latter countries its fruit is called kangaroo apple, and is used as food. When unripe, it is acid, and produces a burning sensation in the throat; but when perfectly ripe, it is wholesome.

**KA'NIZSA**, the name of two towns in Hungary. —Nagy (or Gross) K., a market-town, and once an important fortress, in the county of Szalad, 120 miles south of Vienna, with which it is connected by railway. It has several churches, a monastery, town-house, &c. There is a considerable trade in cattle. Pop. (1869) 11,128. —K. Magyar, a market-town in the county of Bacsa, in a fertile district on the Theiss, 15 miles south-south-east of Szegedin. It has several churches, a synagogue, high school, &c., and a trade in corn and cattle. Pop. 8855.

**KA'NKARI**, a town of Asia Minor, in the pashalic of Anatolia, 65 miles north-east of Angora, on an affluent of the Kizil-Irmak. There are

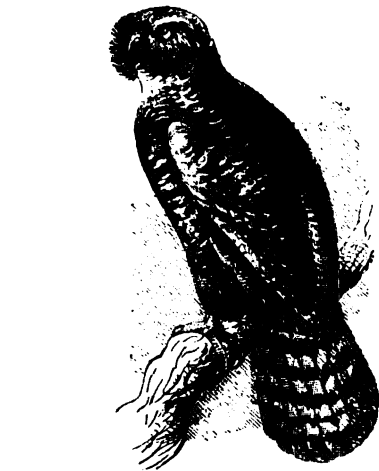

Kakapo (*Strigops habroptilus*).

like the owls, nocturnal, or nearly so, concealing itself in holes during the day, except in very

barracks, and a castle on a neighbouring height. Pop. about 18,000.

**KARMATHIANS** (Carmathians), so called from Abu Said Al-Jenabi, surnamed Al-Karmata, a Mohammedan sect which sprang up in the 9th c. A.D., under the califate of Al-Motamed, and which, by a combination of extraordinary circumstances, succeeded in establishing itself for a time as a political power which threatened to overturn the califate itself. What we have said of the particular creed and tendencies of the Ismailis, under that heading in the SUPPLEMENT, began first to be fully realised and developed about the middle of the 2d c. of the Hedjrah, through one Abdallah Ibn Maimun, an oculist (kaddah) by profession, and a Persian by birth. It was he first who, aided by favourable circumstances, matured a plan which, for the boldness and genius of conception, and for the energy and vigour with which it was carried out, has not many parallels in history. Nothing less was contemplated than the union of the Arabic conquerors and the many races they had subjected since Mohammed's death, and the enthronement of what afterwards was called 'Pure Reason' as the sole deity to be worshipped. The advanced should be free of all so-called religious fetters, which, as symbols and allegorical actions, should be laid all the heavier on the necks of the less advanced strata of society. The 'Believers' and 'Conquerors' were to be made missionaries for unbelief, and the implements for the destruction of their own empire. Whatever the ultimate plans of Abdallah may have been, there can be no doubt about the astute way in which he set to work for the new faith. With an extraordinary knowledge of the human heart and human weakness, he offered devotion to the believer; liberty, if not licence, to the 'free in spirit'; philosophy to the 'strong-minded'; mystic hopes to the fanatics; miracles to the masses. To the Jews, he offered a Messiah; to the Christians, a Paraclete; to the Moslems, a Mahdi; and to the Persian and Syrian 'pagans,' a philosophical theology. His practical exertions, and their wonderful results, soon attracted the attention of the authorities. Obligated to flee from place to place, he sought refuge successively in Karaj, in Ispahan, in Ahwaz, in Basra, finally, in Salamia, in Syria, where he died, leaving his son Ahmed his successor as chief of the sect of the Ismailis. This Ahmed, warned by the fate of his father, proceeded with greater caution, more especially with regard to the name of the Imam or Great Prophet, which he left rather uncertain.

Among the missionaries he sent to Irak, there was one named Husein Ahwazi. In the province of Kufa, this missionary, according to some of the authorities, met a man named Hamdan Karmat, whom he converted to the new faith, and at his death laid his mission upon Karmat's shoulders, whom he had previously initiated into the whole extent of the faith. According to others, however, it was Husein himself, who from some cause received the name of Karamita or Karmat, a word the meaning of which is rather uncertain—indicating, according to some, a man who, having short feet, makes small steps; according to others, a man who has red eyes, &c.

Whoever Karmat was, he was the fittest man to carry out the original intentions of the founder. He very soon succeeded in gaining the full confidence of his flock, which increased daily, and in making them blind instruments of his will. He introduced, according to some of the authorities, absolute communism, not only of property, but even of wives, among them, and founded one particular colony, consisting of chosen converts, around

his own house in Kufa. This residence of his, called the House of Refuge, became the centre of an immense conspiracy. From this place all the missionaries were sent out, and all the threads of the great movement were directed. Amongst the most noted of those missionaries was one Abu Said, who was sent first to Southern Persia, and afterwards to Bahrein, in the Persian Gulf.

The inhabitants of Bahrein, which had formerly been a province of Persia, were partly Jews, partly Persians, who had capitulated with Mohammed, and had been allowed to retain their own creeds. After the Prophet's death, they had at once shaken off the unwelcome yoke, which, however, had again been put upon them by Omar. The interior of the country was inhabited by certain Arabs, highly disaffected against Islam, the innumerable precepts of which they disliked with an intense dislike. No wonder that Abu Said made the most marvellous strides in his conversions. In less than two years, he had brought over a great part of the people of Bahrein. In 287 (Hedjrah) the calif sent an army of 10,000 men against Abu Said and his followers, but the latter remained victorious, and made the calif's own general prisoner. He now gained undisputed possession of the whole country, part of which he had only conquered as yet, and having destroyed the old capital Hajjar, made Lahsa, his own residence, the capital of the country. While the court of Bagdad was threatened with destruction by this newly established power on one side, two chiefs of another Karmathian branch appeared, the one in the neighbourhood of Kufa, the other in Syria. The first was defeated, captured, and tortured to death; the other was more successful. The governor of Damascus, who marched against him, was beaten most ignominiously. This Karmathian triumph, however, though followed by a few others, was of but short duration. A decisive victory (294 Hedjrah), won by the calif's general, Wasif, for ever put an end to this branch of the Karmathians.

Meanwhile, both Karmat and Abu Said had become—by what means, is matter of great obscurity—faithless to their own creed. We have no certain dates about the death of Karmat. Abu Said was killed, together with some of his principal officers, in the bath in his own castle at Lahsa, in 301 Hedjrah, by one of his eunuchs; and four years later, his son, Abu Tahir, became his successor, and he has left his name indelibly stamped upon the annals of Islam. In 311, he seized the town of Basra. In the next year, he pillaged the caravan which went to Mecca, and ransacked Kufa. In 315, he once more reappeared in Kufa and in Irak, and gained so decided a victory over the calif's troops that Bagdad began to tremble before him. In 317 (930 A. D.), the great and decisive blow against Mohammedanism was struck. When the great caravan of pilgrims for the annual pilgrimage had arrived at Mecca, the news suddenly spread that Abu Tahir, the terror of Islam, had appeared at the head of an army in the holy city itself. All attempts to buy him off failed, and a massacre of the most fearful description ensued. With barbarous irony, he asked the victims what had become of the sacred protection of the place. Every one, they had always been told, was safe and inviolable at Mecca. Why was he allowed thus easily to kill them—the race of donkeys? According to some, for 6 days, to others, for 11 or 17, the massacre lasted. The numbers killed within the precincts of the temple itself are variously given. The holy places were desecrated, irredeemably almost. But not satisfied with this, Abu Tahir laid hands on the supreme Palladium, the black stone itself.

Yet he was apparently mistaken in his calculations. So far from turning the hearts of the faithful from a worship which God did not seem to have defended, the remaining Moslems clung all the more fervently to it. God's decree had certainly permitted all those indignities to be put upon His house, but it was not for them to murmur. The stone gone, they covered the place where it had lain with their kisses. As often as Abu Tahir did not distinctly hinder them by force, the caravans went on their usual annual pilgrimage. In the year 327, the emir of the pilgrimage, Abu Tahir's own personal friend, first succeeded in persuading him to conclude a treaty by which the pilgrimage was allowed again, on payment of five denars for every camel, and seven for every horse. Yet the black stone, notwithstanding all efforts on the part of the court of Bagdad, was not returned. Abu Tahir seems altogether to have been a man of extraordinary abilities. Of his valour, with which he also knew how to imbue his followers, the following is told. When he had taken away the black stone, and desecrated the holy places, he marched, with 500 horse, upon Bagdad. The Calif Moktader sent 30,000 men, under his best general, to meet him. Having ascertained how small were the rebel's resources, the calif sent a friendly message to him by the general himself, adjuring him, by their previous friendship, to desist from his insane attempt, and to make good his escape in time. Whereupon he asked the messenger of how many the calif's forces consisted. 'Thirty thousand,' was the answer. 'Then go,' he said, 'and tell your master that he has just sent three men too little.' And calling for three of his own men, he commanded one of them to stab himself, the second to throw himself into the Tigris, and the third to jump over a precipice; all of which was instantly done. 'You see,' he continued, 'what my warriors are like, and what numbers mean against such as these.' The following night, he made a sudden attack upon the enemy, routed them completely, and took the general himself prisoner.

Regarding the special form of belief of the K., as far as it has been preserved to us, it seems in the beginning—before Islamism became that mixture of 'naturalism,' 'materialism,' of whilom Sabæism, and of Indian incarnations and transmigrations of later days—to have only been a kind of 'reformed' Islam. The prophet Karmat, it was held, had brought a new Law into the world. By this, many of the Mohammedan tenets are altered, many ancient ceremonies are abrogated, new forms of prayer are introduced, and an entirely new kind of fast is inculcated. Wine is permitted, as well as a few other things prohibited by the Koran. Certain other of the precepts met in this book are turned into mere allegories. Instead of tithes, they gave the fifth part of their property to the Imam. Prayer is but the symbol of obedience to their Imam. Fasting is the symbol of silence, or rather of concealment of the religious doctrine from the stranger.

Abu Tahir died almost absolute master of Arabia, Syria, and Irak, in 332 Hedjrah. It was not until seven years later (950 A.D.), under the reign of two of his brothers who had succeeded him, that the 'black stone' was returned to Mecca for an enormous ransom, and fixed there, on the seventh pillar of the mosque called Rahmat (God's mercy), in the presence of the emir of the mosque and others, a Spaniard amongst them. Yet the K. were accused of not having returned the stone itself, or, at all events, of having broken it. Forty camels, it was also said, had been unable to carry it away; while a single one had brought it back, one, moreover,

that had been lean when it started, and had become fat when it had reached Mecca.

From that time forth, however, the star of the K. began to wane. Little is heard of them of any import till 375, when they were defeated before Kufa—an event which seems to have put an end to their dominion in Irak and Syria. In 378, they were further defeated in battle by Asfar, and their chief lost his life. They retreated to Lahsa, where they fortified themselves; whereupon Asfar marched to Elkatif, took it, and carried away all the baggage, slaves, and animals of the K. of that town, and retired to Basra. This seems to have finally ruined the already weak band of that once formidable power, and nothing further is heard of them in history, although they retained Lahsa down to 430, and later still. Even to this day there exist, according to Palgrave, some disaffected remnants of them at Hass (the modern name of their whilom centre and stronghold), and other tracts of the peninsula; and their antagonism against Mohammedanism, which they have utterly abrogated among themselves, so far from being abated, bids fair to break out anew into open rebellion at the first opportunity.—See Weil, *Gesch. d. Chalifen*; De Goeje, *Mémoire sur les Carmathes*, &c.; Silvestre de Sacy, *Religion des Druses*; Sale, *Koran*; Palgrave, *Arabia*, &c.

KARR, JEAN ALPHONSE, a French literary man of considerable eminence, was born at Paris on the 24th of November 1808. After getting his preliminary education at home from his father, who was a distinguished pianist, he passed with much distinction through the curriculum of the College Bourbon, in which he afterwards, while very young, became a teacher. While employed in this institution, he fell in love, and began to cultivate the muses; and a copy of verses which he sent to the satirical journal, the *Figaro*, formed his introduction to the literary career. His verses were not accepted by the *Figaro*, but its editor asked him to send something in prose, and the result was that he became a regular contributor to the journal. Disappointed in his attachment, he revealed to the world the story of his grief in a novel entitled *Sous les Tilleuls* (1832, 2 vols. 8vo). A youthful desire to astonish, a determination to seem original, made many ignore the real originality of this work; and the curious blending of irony and sentiment, of good sense and nonsense, which form the author's manner, was puzzling to simple people; but the critics declared the book charming; and the public, to whom youthful traits in a novel are never unpleasing, on the whole concurred in the verdict. Encouraged by the success he had met with, K. soon produced a second novel, which did not diminish his reputation (*Une Heure trop Tard*, 1833); and thereafter, year after year, he produced new works, until he has become a prolific author, and a recognised popular favourite. *Fa Dièze* appeared in 1834; *Vendredi Soir* in 1835; *Le Chemin plus Court* in 1836, the last a work in which he again rehearsed the experiences of his youth—at least, it is popularly believed that in it he told the world his own story. He has since published *Étincelles* (1838); *Geneviève* (1838, 2 vols.); *Clotilde* (1839); *Hortense* (1842); *Am Rauchen* (1842); *Pour ne pas être Treize* and *De Midi à quatorze Heures* (1842); *Feu Bressier* (1845, 2 vols.), originally published in the *Revue des Deux Mondes*; *Voyage autour de mon Jardin* (1845, 2 vols.); *La Famille Alain* (1848, 3 vols.); *Histoire de Rose et de Jean Duchemin* (1849); *Les Fées de la Mer* (1850); *Clovis Gosselin* (1851); *Contes et Nouvelles* (1852). *Agathe et Cecile*; *Fort en Thème*; *Soirées de Sainte-Adresse*; *Les Femmes*; *Raoul*; *Lettres écrites de mon Jardin*; *Au Bord de la Mer*,



appeared between 1852 and 1855; *Promenades hors de mon Jardin* was published in 1857; *La Penelope Normande* in 1858; *La Pêche en Eau douce et en Eau salée*, and the *Dictionnaire du Pêcheur*, in 1860. The publication of a complete edition of his works commenced in 1860. The letters and sketches which he has from time to time written from Nice, his place of residence in later years—upon horticulture, and flowers, and fishes—the pleasures of the country and the seaside—have been among the most delightful and popular of his works.

In 1839, M. K. became chief editor of the *Figaro*, and in the same year he founded a monthly satirical journal called *Les Guêpes*, which he long conducted with the most brilliant success, gaining for himself a very high reputation as a wit and satirist, but making, as was natural, many enemies, of whom one, a lady, made an attempt upon his life, which happily proved abortive. Several volumes of *Les Guêpes* have been reprinted; so also have been three volumes of sketches, which, under the title of *Bourdonnements*, he began to contribute to the *Sicéle* in 1852. M. K. has contributed very largely to periodicals, from which, indeed, many of his works have been republished. At Nice, where he has lived for many years past, he has occupied himself—combining the man of business with the enthusiast—with the growth of flowers and fruits; and the most beautiful bouquets sold in Paris are made up of the produce of his garden. Several new varieties of flowers, especially a dahlia, bear his name.

KA'RSHI (anc. *Nakhsh*), the second city in size and commercial importance of the khanat of Bokhara, Central Asia, is situated on the Shehri Sebz river, 90 miles south-east of Bokhara city. K. is surrounded by cultivated land and numerous gardens. It consists of the city proper and a weakly fortified citadel, has ten caravanserais and a well-supplied bazaar, and is considered likely to be of great importance in the transit-trade organised between Bokhara, Cabul, and India. K. is distinguished for the fabrication of knives of various kinds, which are exported to all parts of Central Asia, as also to Persia, Arabia, and Turkey, where they realise three or four times the cost price. According to Vámbéry, one kind, with Damascus blades, and handles with gold and silver inlaid, are worked with great taste, and might, both for durability and temper, put to shame the most famous produce of Sheffield and Birmingham. The inhabitants, estimated at about 25,000, are for the most part Usbeks, with a mixture of Tadjiks, Indians, Afghans, and Jews; they are distinguished by their cheerfulness and light-heartedness. The Jews have the privilege of riding even in the interior of the city, which they are not allowed to do in any other part of Bokhara.—See Vámbéry's *Travels in Central Asia* (1864).

KASANLIK, or KEZANLIK, a town of European Turkey, at the base of the Balkan Mountains, 85 miles north-west of Adrianople, on the Tundja, an affluent of the Maritza. It has an extensive manufacture of attar of roses. Pop. 10,000.

KASHI'N, a town of Russia, in the government of Tver, and 80 miles east of Tver, on the Kashinka, a tributary of the Volga. Great part of the town is old and ill built, but it is a place of much activity, rapidly increasing in prosperity and population. Tanning is a principal branch of trade. A kind of paint for the toilet is also largely manufactured. K. is celebrated for the extraordinary number of its churches and other ecclesiastical buildings. Pop. (1867) 7346.

KATUNGA, or EYEO, a town of Gando, West

Africa, 25 miles from the mouth of a tributary of the Niger, and about 200 miles north-east of Abomey. It is surrounded by a mud wall and a ditch. There is a brisk trade in yams, corn, goats, sheep, fowls, native cloth, &c. Pop. supposed to be about 15,000.

KEBLE, JOHN, son of the Rev. John Keble of Coln St Alwynda, Gloucestershire, and Sarah Maule, a lady of Scotch descent, was born at Fairford, three miles from his father's living, April 25, 1792. The elder Keble, a divine of the school of Ken, educated his son at home, and with such success, that at the early age of 15, he was elected scholar of Corpus Christi, Oxford, then a small college composed wholly of members on the foundation, but numbering among its scholars such names as Coleridge (Sir J. T.) and Arnold of Rugby. In 1810, K. took a first class in Classics and Mathematics; and in the next year was elected to a fellowship at Oriel, one of the highest honours in the university. In 1812, he gained both the Latin and English prize essays, was ordained deacon in 1815, and priest in 1816. Even then, he had chosen his career. Neither the prospect of emolument at Oxford, nor the intellectual attractions of the Oriel common-room, of which Whately and Copleston were then members, and to which Arnold, Pusey, and Newman were soon afterwards added, could charm him from his first love, the life of an English parish priest. For a while he remained at Oxford as tutor and examiner, but soon took active clerical duty, principally assisting his father. In June 1827, in deference to the wishes of his friends, he published *The Christian Year, or Thoughts in Verse for the Sundays and Holydays throughout the Year*, portions of which had been written as early as 1819. The success of the small volume, and its influence on religious thought in England, can hardly be over-rated. The number of editions sold (some of 3000 copies) is marvellous. Although of unequal merit, many of the pieces being evidently written to complete the original plan, it is a work of genuine inspiration, combining with rare depth and fulness of religious feeling, the tenderest sensibility, and a poet's appreciation of nature in her more sympathetic and human aspects. In 1831, K. succeeded Milman as Professor of Poetry. His official prelections are ingenious in theory, and composed in elegant Latin prose. But the time had come when he must quit the pleasant paths of poetry for the tumult of theological controversy. It was a period of peril for the English Church. Within, was apathy and want of spiritual life, save only in the extreme Evangelicals, from whose defects of learning and taste Oxford naturally revolted. Without, a reformed parliament had already suppressed three Irish bishoprics, and seemed not reluctant to lay hands upon the church at home. In his sermon on National Apostasy (1833), K. gave the signal for the Tractarian movement—a movement remarkable for the learning and ascetic saintliness of its promoters, and whose principles were deep submission to authority, implicit reverence for Catholic tradition, with firm belief in the divine prerogatives of the priesthood, the real nature of the Sacraments, and the danger of independent speculation. Early in 1835, old Mr Keble died, and at the close of the same year the poet married Miss Charlotte Clark, the daughter of an old friend of his father, and quitted Fairford for Hursley, a living in the gift of Sir W. Heathcote, M.P. When Newman seceded to Rome, K., less logical perhaps, but with a truer instinct of fidelity to the Anglican Church, remained firm, and amidst the general dismay, exerted himself to the utmost to confirm those who wavered. From this period till his death, his

## KEITH—KENT'S CAVERN.

influence, though comparatively unseen, was not less felt. When smarting under adverse decisions of courts, and hostile measures in parliament, his party always sought for K.'s opinion, and it was given with a conscientiousness that spared no pains, and a singular clearness of judgment even in matters not strictly clerical. His second volume of poems, *The Lyra Innocentium*, was published in 1846, in aid of the fund for rebuilding Hursley Church. Its popularity has never equalled that of *The Christian Year*, to which, indeed, it is inferior both in poetical merit and in catholicity of tone. In the winter of 1865, the health both of husband and wife was seriously impaired. They were compelled to winter at Bournemouth, and there, in the ensuing spring, they died; K. on the 29th of March, at the age of 74; his wife a few weeks later. Besides his poems, K. was the author of a *Life of Wilson*, Bishop of Sodor and Man; an edition of Hooker, usually considered the standard; and several lesser contributions to periodical literature, among others, a *Review of the Life of Scott*, rather famous in its day, originally published in the *British Critic*.

KEITH, JAMES, best known as MARSHAL KEITH, second son of William, ninth Earl Marischal of Scotland, and Lady Mary Drummond, daughter of the Earl of Perth, was born at the castle of Inverurie, in Aberdeenshire, on the 14th of June 1696. He and his elder brother, George, Earl Marischal, had for their preceptor their kinsman, Robert Keith, afterwards a bishop in the Scottish Episcopal Church, and author of two valuable historical works. The brothers took part, on the side of the House of Stewart, in the insurrection of 1715, and after its suppression, were attainted (see KEITH, THE FAMILY OF). Having effected his escape, K. remained in France for some years, improving his knowledge of the military profession, and waiting for an opportunity of obtaining service. In 1719, along with his brother and other Scottish noblemen, he sailed on board the fleet which was fitted out by Cardinal Alberoni and the Spanish court for the invasion of Scotland. The Jacobites were defeated at Glenshiel by the royal army, under General Wightman, and obliged to retreat. The Spanish auxiliaries were ready to renew the battle, but the Highlanders dispersed, and K., after lurking for some time among the mountains, got across the country to Peterhead, and again escaped to the continent. He continued in the Spanish service, but all his expectations of promotion were disappointed, in consequence of his firm attachment to the Protestant Episcopal Church. In 1727, he made an application for the colonelcy of an Irish regiment, and received, as he himself tells us, the following answer from the king of Spain, 'that how soon he knew I was Roman Catholic, I should not only have what I asked, but that he would take care of my fortune.' In consequence of this, he applied for a recommendation to the Russian government, which was immediately given, and he received from the Czar Peter II. a commission as major-general. He distinguished himself in the wars with the Turks and Swedes, particularly at the siege of Oczakoff, and the reduction of the islands of Aland; but finding the Russian service in various respects disagreeable, he entered that of Prussia in 1747. King Frederick knew his merits, and gave him the rank of field-marshal. From this time his name is associated with that of the king of Prussia, who relied as much on the military genius of K., as he did on the diplomatic ability of his brother the Earl Marischal. K.'s talents became still more conspicuous upon the breaking out of the Seven Years' War. He shared the doubtful fortunes of the king before Prague, and was present at the

great victory of Rosebach, and at the retreat from Olmütz. His last battle was not far distant. The Austrians under Daun, and the Prussians under their king, met at Hochkirch on the 14th of October 1758, K. commanding the right wing. The Prussian army was beaten, and K., surrounded and overwhelmed by numbers, while endeavouring to force his way at the bayonet-point, was shot through the heart. His body was recognised by Count Lacy, formerly his own scholar in the art of war, and was buried at Hochkirch. The rest may be given in the words of Frederick's historian: 'Four months after, by royal order, Keith's body was conveyed to Berlin; reinterred in Berlin, in a still more solemn public manner, with all the honours, all the regrets; and Keith sleeps now in the Garrison-Kirche—far from bonny Inverurie; the hoarse sea-winds and caverns of Dunnottar singing vague requiem to his honourable line and him, in the imaginations of some few. . . . In Hochkirch Church there is still, not in the churchyard, as formerly, a fine, modestly impressive monument to Keith; modest urn of black marble on a pedestal of gray—and, in gold letters, an inscription not easily surpassable in the lapidary way: . . . "Dum in prælio, non procul hinc, inclinatam suorum aciem, mente, manu, voce, et exemplo restituebat, pugnant ut heros decet occubuit." K. wrote a brief but interesting fragment of a memoir of his own life, commencing with the year 1714, and ending in 1734, which was printed in 1843 by the Spalding Club. For his military career after entering the Prussian service, reference may be made to Mr Carlyle's *History of Frederick the Great*.

KEMPEN, the name of two towns in Prussia.—1. A town in Prussian Poland, in the government of Posen, on the border of Silesia, 43 miles east-north-east of Breslau. It has two churches, a beautiful synagogue, and a hospital. Wax-refining, tanning, and brewing are carried on, and there is a trade in horses. Pop. (1871) 6051, more than half of whom are Jews.—2. A town of Rhenish Prussia, in the government of Düsseldorf, and 20 miles north-west of the town of Düsseldorf, near the Niers. There are manufactures of silk and woollen goods, of articles of wood, stockings, and candles. It is said to be the birthplace of Thomas à Kempis (q. v.). Pop. (1871) 8767.

KENT'S CAVERN, or KENT'S HOLE, a celebrated bone-cave, situated in a small, wooded, limestone hill, at the junction of two valleys, about a mile eastward from Torquay harbour, and half a mile from the northern shore of Torbay. It consists of two parallel series of chambers and galleries, having an approximately north and south direction. The aggregate length of the eastern series is upwards of 250 feet, and the western is probably longer. It has two narrow external openings or entrances, in the face of one and the same low natural cliff, on the eastern side of the hill, and both opening into the eastern suite of apartments. They are nearly on the same level, about 60 feet apart, 70 feet above the bottom of the valley immediately beneath, and from 180 to 190 feet above the level of mean tide.

Nothing is known respecting the origin of its name, and tradition fails to reach back to the date of the discovery of the cavern. The earliest known mention of it is in *A Tour through the Island of Great Britain*, 1778. At that time, it appears to have been much visited by the curious; but it did not attract the attention of scientific inquirers until September 1824, when Mr Northmore visited it with the 'double object of discovering organic remains, and of ascertaining the existence of a temple of Mithras.' He declared

himself 'happy to say that he was successful in both objects.'

In 1825, the Rev. J. M'Enery commenced those researches, which extended at intervals over fully four years, and has for ever associated his name with the cavern. He made arrangements for the publication of an illustrated narrative of his labours; but the intention was unfortunately abandoned. After his decease, it was feared that his MSS. had been lost or destroyed; but after a variety of fortune, they ultimately became the property of the Torquay Natural History Society, and were published *in extenso* by Mr Pengelly in 1869, in the *Transactions* of the Devonshire Association.

Mr M'Enery's labours may be thus summed up: (1) In the cave-earth, beneath a thick floor of stalagmite, he discovered remains of upwards of 20 species of extinct and recent animals commingled. Amongst them were a few teeth of *Machairodus laidens*; a species not met with elsewhere in Britain, and which many palæontologists hesitated to place in the cave fauna. Mixed up with those remains, and under precisely the same conditions, he found a considerable number of human flint 'implements.'

Though the inoculation of human industrial remains with the bones of extinct mammals was confirmed by the subsequent researches of Mr Godwin-Austen in the same cavern, and later still by those of the Torquay Natural History Society, even scientific men were unprepared for it, and it was either discredited or explained away. In 1858, however, a virgin cavern was discovered at Brixham, on the opposite side of Torbay, and was systematically and carefully explored by a committee, under the auspices of the Royal and Geological Societies of London. The results obtained were so perfectly trustworthy, and so strictly confirmatory of the statements which from time to time had been reported from Kent's Hole, that it began to be generally suspected that the latter were, after all, worthy of credence.

As a result of this feeling, the British Association, in 1864, appointed a committee—consisting of Sir C. Lyell, Sir J. Lubbock, Mr Evans, Mr Pengelly, Professor Phillips, and Mr Vivian; to whom Mr Buak, Mr Boyd Dawkins, Mr Sanford, and Mr Lee have since been added—to make a complete and systematic exploration of so much of Kent's Cavern as still remained intact. The committee have carried on their researches without intermission, and presented full annual Reports from 1865 onwards. The work is placed under the superintendence of two of the members, who visit the cavern daily. The method of exploration is so simple as to be easily carried on by the workmen, and so accurate as to render it easy to determine the exact position in which every object was found.

The walls of the cavern, in some of its branches, display traces of the long-continued action of water running in a sensibly horizontal direction. These, however, may be regarded as indications of the agency by which the cave was formed, but not necessarily by which the deposits were introduced.

In descending order, the deposits were: (1) Huge blocks of limestone, which from time to time had fallen from the roof. In some instances, two or more blocks lay one on another. Sheets of stalagmite sometimes lay between them, or invested the whole, so as to form a dome-shaped mass; whilst others were without any trace of this material. (2) Black mould, from 3 to 12 inches deep. (3) Stalagmitic floor, from a mere film to upwards of five feet thick; but commonly ranging from 16 to 20 inches. From its prevalent texture, it was termed the *Granular Stalagmite*, to distinguish it from another and

older floor of the same material. It contained numerous fragments and blocks of limestone, and graduated downwards into an extremely hard concrete or breccia. (4) A black band, of irregular outline, from 2 to 6 inches thick, and mainly composed of bits of charcoal. This band was exceptional, being found only in one spot, from 30 to 40 feet from one of the cavern entrances, where it covered about 100 square feet only. Throughout about half this area, it was in immediate contact with the nether surface of the stalagmitic floor, from which, elsewhere, it was separated by a layer of red loam, which never exceeded 6 inches in thickness. (5) Red cave-earth, with angular fragments of limestone, from mere splinters to blocks almost as large as those lying on the surface. Typically, this deposit consists of about equal parts of red earth and of stones; but in some places, the former greatly preponderates, whilst in others the latter is most prevalent. Comparatively small well-rounded fragments of rocks, not derivable from the cavern hill, occasionally present themselves. The materials of the cave-earth have no approach to stratification or symmetrical arrangement, and the stones lie at all angles. Small thin films of stalagmite occur at all depths, sometimes encrusting bones or stones, or cementing them into a firm breccia. The depth of this deposit is generally unknown; it in most places exceeds 4 feet—the depth to which the excavation is restricted at present—but in others it does not attain to this, and occasionally there is none. (6) Where the bottom of the cave-earth has been reached, a second floor of stalagmite occurs beneath it. It is generally of greater thickness than the granular floor, and in one instance is little short of 12 feet. On account of its structure, it is known as the *Crystalline Stalagmite*. (7) Under this again is a mechanical deposit, consisting of subangular and rounded pieces of red grit, not derivable from the cavern hill, embedded in a sandy paste of the same colour, and denominated breccia.

The objects found in the black mould form a large and very miscellaneous collection, including objects extending from the present day back to mediæval and even pre-Roman times. The most important are stones of various kinds, well rounded, and occasionally perforated by marine organisms; potsherds representing a large number of vessels; curvilinear plates of slate, probably covers for earthenware utensils; 'spindle whorls'; amber beads; an awl, a spoon, a wedge, and a chisel, all formed of bone; bone combs, which may be likened to small shoe-lifters having teeth in the broad end; a spear-head, a socketed celt, a spoon, a fibula, and rings, all of bronze; lumps of smelted copper; marine shells, such as still exist in Torbay; and bones and teeth of various animals, of existing species, including man.

The comparatively few objects found in the granular stalagmitic floor include pebbles of various kinds, flint implements, marine shells, pieces of charcoal, impressions of ferns, and remains of extinct and recent animals, including man, and the mammoth, cave rhinoceros, hyæna, and bear.

The black band beneath the floor was extremely rich in objects, of which the principal were remains of the ordinary extinct and recent cave mammals; flint implements and chips; a bone awl; a bone fish-spear, or 'harpoon,' barbed on one side only; a bone needle or bodkin, with a well-formed eye; and burnt bones. The flint specimens were keen-edged, brittle, and chalk-like in colour and texture. They averaged about ten in every cubic foot of material.

Throughout the entire depth yet excavated, the

cave-earth contained bones of recent and extinct mammals and birds—chiefly the former; faecal matter, almost exclusively finely comminuted bone; coprolites, *ovate* and *lanceolate* flint implements, and flint chips; two bone 'harpoons'; a bone pin; small pieces of burned bone; 'whetstones,' and a stone hammer, or crusher. The bones are very abundant: most of them are of an almost chalk-like whiteness, whilst a few are discoloured; many are merely small splinters; a considerable number have been fractured, and gnawed precisely after the manner of modern hyenas; several are split longitudinally, in such a way as to betoken human agency; and as if to furnish laths of bone for tools; those immediately under heavy blocks of limestone are crushed; they are all characterised by a specific gravity greater than that of those found above the stalagmite; on the tongue being applied to them, they all adhere to it; in no instance have the elements of an entire skeleton, or anything approaching to it, been found together; and remains of many different kinds of animals are often lying in contact. Certain branches of the cavern appear to be richer than others in bones; but wherever the cave-earth occurs, with its usual accompaniment of limestone fragments, they may be expected in average abundance, irrespective of depth below the stalagmite. The bone 'harpoons' and pin have the same chemical condition as the bones—they both adhere firmly to the tongue. The 'whetstones' are long narrow pieces of greenish grit, and are similar in form and material to those found in the Bruniquel caves in France. The 'stone hammer' is a small ellipsoidal pebble of coarse, hard, red sandstone. According to a Report furnished by Messrs Boyd Dawkins and Sanford, in 1869, the following species of mammals occur in the cave-earth: cave-lion, a *Felis* of the size of lynx, wild-cat, cave hyena, wolf, fox, *Canis vulpes* var. *spelæus*, *Canis* of the size of *isatis*, glutton, badger, cave-bear, grizzly bear, brown bear, mammoth, *Rhinoceros tichorhinus*, horse, urus or wild bull, bison, 'Irish elk,' red-deer, reindeer, hare, cave-pika, water-vole, field-vole, bank-vole, *Arvicola gulelmi*, and beaver; and in 1872 Mr Peggelly added *Machairodus latidens*, and thus disposed of all scepticism respecting the occurrence of this species in the cavern.

The animal remains found in the crystalline stalagmite and the breccia beneath are exclusively those of bear. There is no trace of the hyena, the most prevalent species of the cave-earth—none of his bones or teeth, no bones broken after his well-known pattern, none bearing his teeth-marks, and none of his coprolites—and these lower deposits belong apparently to an era earlier than that of his arrival in Britain. But here, too, there are flint implements. They resemble those of the cave-earth in being without a trace of polish, but differ from them in being less symmetrical in form, ruder, and more massive.

Though it would be premature to venture on a general interpretation of the facts disclosed before the exploration is completed, the meaning of a few of them cannot be misunderstood or qualified.

From the crushed character of the bones immediately beneath blocks of limestone, it may be inferred that the cave-earth, on which they lay, was firm, unyielding, and capable of offering a resistance to the huge blocks as they fell from the roof; and hence it may be concluded, also, that the flint-tools did not, as Mantell and others supposed, by sinking through the red earth, reach a depth greater than that which they primarily occupied.

Whilst it is possible that objects belonging to different eras may be commingled in the cave-earth, it is certain that the most modern thing it contains is more ancient than the oldest article in the

stalagmite formed on it; and as human tools have been found in the cave-earth, and bones of extinct mammals in the stalagmite, the contemporaneity of man with these extinct forms may be regarded as certainly established.

It is no doubt true that a very large amount of labour has been expended on Kent's Cavern without the discovery of any portion of the human skeleton in the cave-earth. The fact is one of considerable interest, but it does not warrant a doubt respecting man's existence, especially in the presence of such positive facts as bone-tools and burned bones, to say nothing of the flint implements. Moreover, the stalagmite floor, with its extinct mammals, has yielded a portion of man's osseous system—part of an upper jaw, containing four teeth. In their Reports, the exploring committee remark, that, amongst other results of their investigation, so many instances of the valuelessness of merely negative evidence have presented themselves, as to encourage the hope that remains of man, though probably in but sparing numbers, may yet be found in the cave-earth.

**KE'RKI**, a town of Bokhara, Central Asia, about 120 miles south of Bokhara city, on the left bank of the Jihoon or Oxus. K. is a place of considerable importance, being a frontier fortress, and the key to Bokhara on the side of Herat. The town, which is spread around the fortress, consists of 150 houses, 3 mosques, a small bazaar, and a caravanserai; it is also defended by a good wall and deep ditch. The inhabitants are Uzbegs and Turkomans, employed a little in trade, but more in agriculture.

**KERN**, J. CONRAD, a Swiss statesman, was born in 1808, near Arenenberg, in Thurgau. He studied theology at Bâle; but he abandoned his intention of entering the church, and turned his attention to law, which he studied successively at Berlin, Heidelberg, and Paris. On his return to his native canton, he was appointed to the presidency of the Supreme Court and of the Council of Public Instruction; and in these offices he made himself remarkable by his talent for public speaking, and his great legal and administrative sagacity. When in 1838 the French government demanded the extradition of Prince Napoleon, K. took the most prominent part at the Diet in stirring up the Swiss to refuse to be intimidated. In 1848, K. took an active part in the preparation of the federal constitution. He afterwards established the Polytechnic School of Zürich, one of the most admirable institutions of its kind in Europe. In 1857 he was selected to complete the negotiations regarding the dispute with Prussia; and at the conferences of Paris between the great powers, K. represented Switzerland.

**KEY ISLANDS** lie to the south of New Guinea, between 5° 12'—6° 4' S. lat., and 132° 40'—133° 18' E. long. They consist of Great Key, Little Key, Key Watela, and a number of small islands. In 1853, two new islets appeared in connection with earthquakes which occurred on the 26th of November.

**KHAFALOUN**, or **KHAPALU**, a town of Western or Little Tibet, in the territory of Gholab Singh, on the Shayook, a short distance above its junction with the Indus, 110 miles north-east of Serinagur. Pop. 12,000.

**KHANPU'R**, a flourishing commercial town of North-western Hindustan, on a canal which connects it with the Indus, 400 miles west of Delhi, in lat. 28° 35' N., long. 70° 41' E. It was formerly of much greater importance than it is now, although it still has considerable trade. Pop. 20,000.

**KHO'L**, a town of Northern Persia, province of

Azerbaijan, on the Kotonra, a feeder of the Araxes, 50 miles north-west of Tabriz, and about 20 miles north of Lake Urumeyah. Pop. 30,000.

**KHURJA**, a town of British India, in the district of Boolundshuhur, the principal place of the pergunnah of the same name, 54 miles south of Meerut, about two miles west of the Ganges Canal. Pop. (1872) 24,584.

**KIKINDA**, **NAGY-KIKINDA**, or **GROSS-KIKINDA**, a town of the Austrian Empire, in the Temeser Banat, 134 miles south-east from Pesth. It is situated in a level fertile country. Pop. (1869) 18,834.

**KIMPOLUNG**, a town of Walachia, 80 miles north-west from Bucharest. Pop. about 8500.

**KINCHOW**, a city of China, in the province of Hoo-pee, on the left bank of the Yang-tze-Kiang, in lat. 30° 26' 40" N., long. 112° 8' E., about 150 miles west of Hankow. K. is surrounded by a strong wall, and is considered one of the keys of the empire. Pop. estimated at 600,000.

**KINDERGARTEN**, the name of a new kind of school or training-place for young children—name and thing imported from Germany. The principle was first propounded and the system invented by Friedrich Fröbel, born 1782, died 1852. He was early impressed with the insufficiency of the teaching and training given in the ordinary infant-school, and with the fact that the loving instinct of the mother remained merely an instinct, which required, for the training of the child, thoughtful guidance and direction. He saw that the teaching in the infant-school was to a large extent traditional; that the selection of subjects and exercises depended on fashion, or upon the likings or prejudices of the teacher, and not upon a genuine knowledge of the nature of children; and that the whole procedure was based upon an induction of facts and phenomena which had been hastily made, and rested upon no firm ground of principle. He therefore set to work to study the ways and doings of infants from their birth, and to note down systematically what kind of mental food and what kind of bodily activity Nature prompted them at each stage of their existence to prefer. He also reached the following principles: (a) that Education means a harmonious development of all the bodily and mental powers; (b) that the *spontaneous* is the raw material and the only element that is valuable in education, and, that the teacher must connect all his instruction with these, and graft it upon the spontaneous activity of the child; (c) that the work of the teacher is not to give knowledge *ab extra*, but to supply material, means, and opportunities in a rational and harmonious order for the child's mind spontaneously to work upon; and (d) that in the presentation of their materials or occupations, there must be no break (*In Naturâ non datur saltus*), because all occupations which train must be developed out of each other. The early materials for instruction are called *gifts*, because they are presented to the child only when his nature and stage of development call for them. The province of the educator is to map out the world of early childhood, and to engineer—that is, to give each step in—the paths to knowledge or power in each subject; the province of the teacher is to apply this general knowledge to particular cases, and with loving care and delighted patience to provide the right mental food—the most suitable activities for each hour and stage of development. His complete aim is the systematic cultivation of all the powers in complete equilibrium. Hence, while the infant-school goes too much into work and drill, Fröbel's system calls for attention to the

individual child; he weaves the work into 'play' (spontaneous activity), and he evolves 'drill' out of the free individual desire for society. Hence Fröbel's large use of song and dance. He respects freedom and the right order of development so much that he would not give a *word* to a child until a mental necessity and desire had been created by an ordered set of experiences for that word; and he cultivates the senses and the hand with the utmost care, so that perfectly accurate perception and comparison may produce true and clear conceptions, which again give rise to true and just judgments. 'All the byways to untruth,' says Miss Shirreff (*Kinder-Garten*, Chapman and Hall, 1876), 'such as exaggeration, confusedness of mind, inaccuracy of speech, are cut off.' The child is not taught, but led by a set of ordered experiences to the perception of the principles of number (*Arithmetic*) and of space (*Geometry*); and his senses and powers of hand and eye are cultivated by an elaborate series of exercises. The steps in Fröbel's system are: (1) *Spontaneity* or *Play*, which, however, in a child is always serious, and never frivolous; (2) direction of this towards external fact and truth; (3) weaving of spontaneous powers into ordinary occupations; (4) development into self-culture, independent action, a love of knowledge, beauty, and society. The process, like the process of Nature, is slow, tranquil, and organic; but no part of it requires to be undone. The child sees, imitates, or reproduces and invents new forms: these are the three steps in each subject for each pupil. Its most earnest disciples give to it the name of *The New Education*.

The system has made great way in America, and is now making way in England. There is a Fröbel Society, which consists of a large number of thinkers and workers in education. The London and Birmingham school boards have introduced the system; and several training-colleges are working upon its lines. The best English books as yet on the subject are Laurie's *Kinder-garten Manual*; Miss Shirreff's *Kinder-Garten*; Heerwart's *Music for the Kinder-Garten*; Köhler's *Praxis*, translated by Miss Gurney.

**KING-TE-CH'ING**, a town of China, in the province of Kiang-si, 240 miles south-west of Hangchow, on a small river which falls into Lake Poyang. It is the principal seat of the manufacture of porcelain in China, for which, it is said, 500 furnaces are employed. Pop. above 500,000.

**KING-WOOD**, a very beautiful wood, in small pieces, used for ornamental work. It is brought from Brazil, and is believed to be the wood of a species of *Triptolomia* (natural order *Leguminosæ*, sub-order *Papilionaceæ*).

**KIRCHHEIM**, a town of Württemberg, 15 miles south-east from Stuttgart. Pop. (1871) 5863, nearly all Protestants.

**KIRK-KILISSIA** (the 'forty churches'), a town of European Turkey, 104 miles north-west of Constantinople. The pop. is variously estimated at from 16,000 to 28,000, and consists chiefly of a mixed race of Bulgarians, Greeks, and Turks.

**KISHENAU**, or **KICHENEV**, a town of Russia, capital of the government of Bessarabia, 95 miles north-west of Odessa. Until 1812, when it came into the possession of Russia, it was a place of no consequence; since then, however, it has rapidly increased in size and prosperity. Pop. (1833) 13,000; (1858) 85,547; (1867) 103,998, composed of Russians, Jews, Cossacks, Poles, Germans, Armenians, Bulgarians, Greeks, gipsies, and many other nationalities.

**KLEENÉ BOC** (Dutch, little goat), or **CAPE**

**GUEVEI** (*Antilope perpusilla* or *pygmaea*, or *Cephalopus pygmaea*), a very small species of antelope, very plentiful in South Africa. It is only about a foot high at the shoulder; the limbs are slender,



Kleene Boc (*Antilope perpusilla*).

the head long and pointed, the horns very short; the colour slaty brown. It lives singly or in pairs, in bushy districts, and is very nimble and active. Similar species are found in Western Africa.

**KLIPSPRINGER** (Dutch, cliff-springer), or **KAINSI** (*Antilope oreotragus*, or *Oreotragus saltatrix*), a species of antelope, about equal in size to the chamois, and resembling it in habits, found in the highest mountainous districts of South Africa. It is of a yellowish-gray colour, and the hair is long, and stands out from the skin so as to make a rough



Klipspringer (*Antilope oreotragus*).

fur. The legs and the general form are more robust than in most species of antelope. The flesh of the K. is particularly esteemed; the hair is also valued for stuffing saddles; and it has therefore become rare in localities where it was once common. The pinnacles and precipices in which it delights, unake hunting it with dogs impossible, but to get within rifle-shot of it is not difficult.

**KNEADING BY MACHINERY.** Every person who has witnessed the making of bread by the ordinary process, must have felt the necessity of some means for avoiding the contact of hands, often not too clean, with the dough, and the very laborious exertions requisite for kneading it thoroughly. On the continent, where bread-making is treated in a much more scientific way than in Britain, every operation is now conducted on a large scale by the aid of admirable machinery; and the forms of kneading-machines are very various—the general

principle being, however, the same in all. In France, where they are called *Pétrisseurs*, that shewn in the engraving is preferred. It consists of an iron cylinder, in which an axle works, and around which are set a number of curved, blunt metal blades. The upper half of the cylinder opens (as seen in the

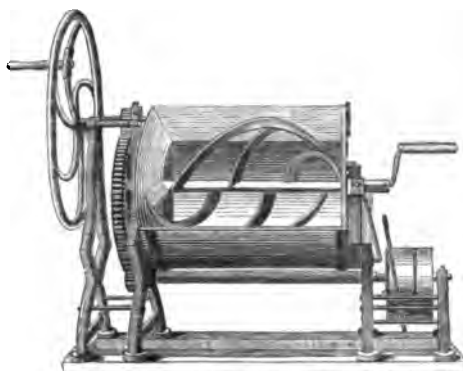

Kneading-machine.

figure), for the supply and removal of the dough. In the large bakeries, they are worked by steam-power; in the smaller ones, by hand. Kneading-machines are now becoming common in England.

**KNOT** (*Tringa canutus*), a bird of the family *Scolopacidae*, and of the same genus with the dunlin, stints, &c. It is sometimes called the **RED SAND-PIPER**. Its whole length is about ten inches. The general colour, in summer, is reddish brown, finely mingled with black, gray, and white; in winter, the plumage becomes mostly ash-gray, and on the under parts white. The K. frequents high northern latitudes in summer, and breeds there; but migrates southwards in winter, and is then found, sometimes in large flocks, in Europe, Asia, and America, as far south as the West Indies, chiefly on flat sandy shores. It runs about with

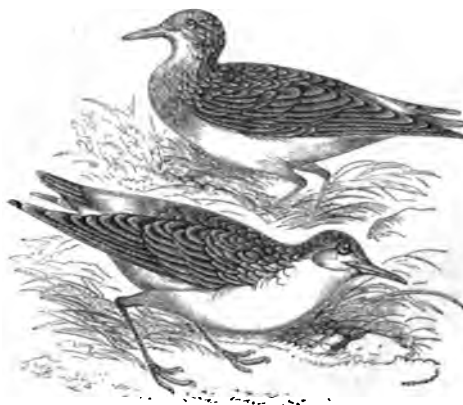

Knot (*Tringa canutus*).

great activity as the wave retires, seeking its food on the sands. Its food consists in great part of small bivalve molluscs, which it swallows shell and all. It is in high esteem for the table.

**KO'BRIN**, or **KO'BRYN**, a town of Russian Poland, in the government of Grodno, 139 miles east from Warsaw, on the right bank of the

Machazica, a tributary of the Northern Bug. It is favourably situated for commerce, the Machazica, and along with it the Bug and Vistula, being here connected by a canal with the Pripet, and thus with the Dnieper. There is a Greek abbey here. Pop. (1867) 7128.

KÖNIGSWART, a town of Bohemia, on a feeder of the Beraun, a branch of the Elbe, 79 miles west-south-west from Prague. It is situated in a romantic valley, has a fine castle, belonging to Prince Metternich, mineral springs, and a bathing establishment. The old fortress was destroyed by the Swedes in the Thirty Years' War, and the site having been purchased by the imperial general, Count Metternich, in 1618, he built a castle in the Italian style, surrounded it with a fine park, and collected in it a fine library, with great treasures of paintings, antiquities, and objects of natural history. The altar of the richly-adorned chapel of the castle possesses many bones and other relics of saints to which pilgrimages are made. Pop. (1869) 1700.

KORO'TCHA, or KAROTCHA, a town of Russia, on a small river of the same name, in the government of Kursk, 75 miles south-east of the town of Kursk. The town is well built, and has several churches. Saltpetre is manufactured, and a trade in apples carried on. Pop. (1867) 6449.

KRAPINA, a town of the Austrian Empire, in the province of Croatia, on a river of the same name, a branch of the Sava, at the southern base of the Ivanica Mountains, 140 miles south-south-east from Vienna. The surrounding country is very fertile, abounding in corn and wine; and the town has of late rapidly increased in size.

KREMSIER, one of the prettiest towns of Moravia, 88 miles north-east of Olmütz, on the March. It is the summer residence of the Archbishop of Olmütz, who has here a fine palace, containing a picture-gallery and a library of 30,000 volumes. During the revolutionary disturbances at Vienna in 1849, K. was the seat of the Austrian government and imperial councils. Pop. (1869) 9823.

KRIS, a dagger or poniard, the universal weapon of the inhabitants of the Malayan Archipelago. It is made of many different forms, short or long,



Kris, or Malay Dagger.

straight or crooked. The hilt and scabbard are often much ornamented. Men of all ranks wear this weapon; and those of high rank, when in full-dress, sometimes carry three or four. In Java, women sometimes wear it.

KRO'NENBERG, a town of Rhenish Prussia, three miles south-east from Elberfeld, in the industrial activity and prosperity of which it has partaken. Manufactures of linen and cotton are carried on, also of articles of iron and steel. Pop. (1871) 7900.

KRUPP'S STEEL. The widespread reputation of the steel produced in the great works of Herr Krupp, at Essen, in Prussia, has induced us to give it a brief notice. His manufactory, always a large one, has been gradually increasing in size during the last half century, until it now covers nearly 1000 acres, and gives employment to some 14,000 persons. For large metallurgical works, Essen is favourably situated, being in the centre of a coal-bearing area, where coal of the purest kind can be comparatively

cheaply procured. There is also at hand the manufacturing iron ores of Prussia, which have been found so excellently adapted for the manufacture of steel; but it is believed that the admirable organization of every part of his manufactory has conducted, as much as anything, to the great success of Krupp. With labourers and mechanics who have passed the regulation-time in the Prussian army, overseers trained in the German technical schools, and a small staff of experienced analytical chemists, he has obviously a great advantage in conducting operations where order, system, and skill are of paramount importance. But even with these benefits, Krupp's productions would not have gained their celebrity, were it not for the scrupulous care with which he performs every manipulation.

In the article IRON, we have described the manufacture of steel by the *Cementation* and *Bessemer* processes, but there are several other methods of making it, and one of these is by the decarburisation of cast-iron in the puddling furnace. This is the process by which Krupp makes his steel, in the first instance; and the material he most largely employs is *Spiegeleisen*, or specular cast-iron, a highly crystalline variety, usually containing about 4 per cent of manganese. This iron is admirably suited for conversion into steel. The puddling process for steel is similar to that employed for Iron (q. v.), except that the former is conducted at a lower temperature, and requires nicer management; but in the case of steel, the cast-iron to be operated upon is never previously refined. Cast-iron to the extent of about 4 cwts. is melted in the puddling furnace, mixed with a quantity of slag or cinder (chiefly silicate of iron), and stirred with a rabble. During this operation, the carbon in the cast-iron (usually about 5 per cent.) is gradually oxidised by the oxygen present in the cinder; carbonic oxide is produced, and as it escapes, what is technically termed 'boiling' takes place. When the ebullition becomes active, the temperature is raised until the appearance of incipient solidification occurs; the heat is then lowered, and the ordinary process of balling proceeded with. Steel thus produced usually contains from 0.5 to 1 per cent of carbon; but if the temperature is not skilfully regulated, the carbon becomes wholly burned away, and malleable iron instead of steel is produced.

Puddled steel, although useful for most purposes in the arts (except cutlery), nevertheless wants homogeneity, on account of a certain intermixture of cinder, which is difficult to get rid of without fusion—a defect which is apt to prevent it from welding perfectly. In Krupp's works, the puddled steel is remelted into crucibles, in order to convert it into cast-steel; and it is the wonderful uniformity of quality with which he manufactures this in very large masses, that constitutes the superiority of, and gives so great an interest to his productions. The crucibles employed are made with extreme care, mainly from fire-clay, to which a little plumbago is added; their capacity varies from 50 to 100 lbs., and it is reported that as many as 100,000 are kept drying at the same time. After being once used, the crucibles are broken up, and mixed with other material, to make new ones.

In the casting-house where the large ingots are run, the furnaces, which contain about 1200 crucibles, are arranged along the sides of the building; and in the central portion, the steel moulds, varying in capacity from 100 lbs. to 40 tons, are disposed in line between two pair of rails, upon which runs a movable crane. It is in the casting of such an enormous ingot as 40 tons of steel (the largest yet produced) from crucibles of small capacity,

that the perfect organisation of Krupp's establishment becomes most strikingly apparent. At a given signal, one gang of workmen remove the crucibles from the furnaces, while another seize them with tongs for the purpose, and pour their contents into narrow canals of wrought-iron, lined with fire-clay, which converge into the opening by which the mould is filled. This is the critical stage of the operation, the difficulty being to deposit in the mould a continuous stream of melted steel of about the same degree of heat, so as to cool uniformly, and to solidify into a perfectly homogeneous mass. Of such uniform soundness are some of Krupp's large steel ingots, that one—shewn in the London Exhibition of 1862, 9 feet high, 44 inches in diameter, and weighing 21 tons—when broken across, did not shew the slightest flaw, even when examined with a lens.

In order to manipulate these extraordinary masses of steel, there is a steam hammer, weighing 50 tons—the mechanical marvel of the works at Essen—which has a cylinder nearly 6 feet in diameter. It has a 50-ton crane at each of its four corners, and behind each of these again, there are four heating furnaces. A movable bench on low massive wheels serves to remove a large ingot from any of the furnaces, which is then, by means of the powerful cranes, and a system of pulleys and crabs, placed on the anvil, and worked into any desired shape. The anvil-face weighs 185 tons.

The quantity of steel manufactured by Herr Krupp annually amounts to about 125,000 tons, representing a value of about £3,000,000. It consists chiefly of rails, tires, crank-axes, shafts, mining pump-rods, and guns—the proportion of ordnance being about two-fifths of the whole. Guns have been made at Essen for the Prussians, Austrians, Belgians, Dutch, Italians, Turks, Japanese, and also for the English, although not directly ordered by the government. In 1874 the works included 1100 smelting and other furnaces, 275 coke-ovens, 264 forges, 300 steam-boilers, 71 steam-hammers, 286 steam-engines of 10,000 horsepower, 1056 machine tools, 30 miles of railway, 80 telegraph stations, a chemical laboratory, and photographic, lithographic, printing, and bookbinding establishments. There is a fire-brigade of 70 men, besides 166 watchmen. In 1872 the consumption of coal was 500,000 tons; coke, 125,000 tons; gas, 155,000,000 cubic feet for 16,500 burners. Krupp has built good houses, hospitals, &c. for his men. Besides the works at Essen, the firm possesses several mines and smelting-works. In the Paris Exhibition of 1867, Krupp shewed a huge gun intended for a coast battery to defend the attacks of plated ships. It was made entirely of cast-steel, weighs 50 tons, and could propel a shot weighing 1080 lbs. It took 16 months, working day and night without interruption, to manufacture. The price of the gun alone was £15,750, and of its carriage and turn-table, which weighed respectively 15 and 25 tons, £6000 more. In the Vienna Exhibition of 1873, Krupp shewed, in a pavilion by themselves, a number of most interesting objects in steel. Among them were a huge gun like that shewn at Paris, about 4 feet 6 inches in its greatest diameter; an octagonal ingot, weighing fully 50 tons; a marine-engine shaft, 15 inches in diameter; and some locomotive wheels and axles.

KRUSENSTERN, ADAM JOHN, CHEVALIER VON, a distinguished Russian voyager, was born 8th November 1770, at Haggud in Esthonia. He served for some time in the British navy. The Emperor Alexander, when he ascended the Russian throne, took up a plan proposed by K. for the promotion of the American fur-trade, and consequently intrusted

him with the command of an expedition at once for scientific and mercantile objects. K. sailed from Cronstadt with two ships, 7th August 1803, and returned 19th August 1806, and was the first to conduct a Russian expedition round the world. He failed in one of the objects for which he was sent out—the reopening of the Russian trade with Japan, but made some interesting geographical discoveries; and his careful explorations of coasts made his voyage very important for the progress of geographical science. He published an account of this voyage (3 vols., Petersb. 1810—1812, with a volume of maps and plates), which was soon translated into all the principal languages of Europe. The contributions to natural history resulting from the expedition were the subject of a separate work by Tilesius (Petersb. and Leip. 1813); and K. himself subsequently published a work called *Contributions to the Hydrography of the Pacific Ocean* (1819), and several other works on the same subject. K. died in 1846 at Asz, in Esthonia, where he had an estate.

KRYLOV, IVAN ANDREJEVITCH, a celebrated Russian fabulist, born 13th February 1768, at Moscow, was the son of a poor officer in the army, received the elements of his education at Tver from his mother, and learned French from a French tutor who was resident in the house of the governor of Tver. K. read indiscriminately all books which fell into his hands. Dramatical works made the greatest impression on him, and in his 15th year he wrote an opera called the *Kafesimias* (The Coffee Fortune-teller), which was never represented, but attracted considerable notice in Tver, and procured patrons for him, who got him an appointment, in 1785, in a public office in St Petersburg. A bookseller gave him 60 roubles for the manuscript of his opera, which he spent in buying the works of Racine, Molière, and Boileau. In 1786, he wrote another tragedy, *Philomela*, which, although never represented, was printed in the collection called *The Russian Theatre*. After the death of his mother, 1788, to whom he was much attached, K. received a post in the imperial cabinet, which he resigned two years afterwards, in order to devote himself to literary work. For two or three years, beginning in 1789, he occupied himself partly with journalism, but soon gave it up. He now produced a succession of prose comedies, among which were *The Crazy Family* (1793), *The Mocking-bird*, and *The Poet in the Anteroom* (1794), which brought him under the Empress Catharine's notice. In 1801, he was appointed secretary to Galitzin, the governor of Riga, who, after a time, invited him to his country-house at Saratov, where he spent some years in entire leisure. He then returned to St Petersburg in 1806, where he brought several very successful plays on the stage, *The Milliner's Shop*, *The Lesson to Ladies*, &c. It was at this time, when about 40 years of age, that he turned his attention to that kind of writing which was to immortalise him. K. having translated some of Lafontaine's fables, the poet Dmitriev was so struck with their felicity, that he encouraged him to persevere in that line. In 1808, the first collection of his Fables (23 in number) appeared, which met with great success. Others followed in 1811 and in 1816. In 1811, he was made member of the Petersburg Academy; in 1812, an official in the Imperial Library; in 1830, councillor of state; and in course of time he was so overwhelmed with honours and pensions, that, in 1841, when he resigned his public office, he drew from the state and the imperial treasury the sum of 11,700 roubles. On the occasion of his 70th birthday, homage flowed in on him from all quarters. K. died on the 21st November 1844. Soon afterwards, a national



subscription, to which children eagerly contributed their share, was set on foot to raise a monument to his memory; and towards the end of the reign of the Emperor Nicholas, his statue in bronze, by Kloth, was placed in the Summer Garden at St Petersburg. Many stories are current of his eccentricities. Owing to the genuine national spirit, the joyousness, simplicity, wit, and good humour that pervade them, his Fables are the most popular of Russian books, and many single sentences of them have become proverbs. They are generally the first reading-book put in the hands of children, and thus many thousand copies, both in dear and cheap editions, are in circulation among all classes. He produced in all nearly 200 fables, of which more than three-fourths are original, and the rest are imitations. Translations have been made by Ralston (English, 1871), Eimerling (French, 1845), Torney and Löwe (German, 1842 and 1874), &c. There are numerous Italian and French imitations.

**KUNNOJ**, or **KUNNOUJ**, a decayed town of British India, capital of the pergunnah of the same name, in the district of Furruckabad, 65 miles north-west of Lucknow, on the Kali Nuddi River, about three miles from its junction with the Ganges. At present, the place is little more than an expanse of ruins, whole mountains of which meet the eye in every direction, upon a space of ground much larger, it is said, than the site of London. The greatest part of the standing buildings are uninhabited, and tottering to decay. The few poor people now in

the place live in mud huts built up against the old walls. The present town is about a mile long, and half a mile broad, with a ruinous fort of no great antiquity. The most remarkable buildings are two handsome Mohammedan mausoleums. K. was formerly one of the greatest of Indian cities; and according to some, ranks second in respect of antiquity. One authority considers the town to have existed before the first introduction of Brahmanism from the West. Until about the 12th c. A.D., it continued to be the chief city of India; but in 1194, it was attacked by Shahabuddin Mohammed, sovereign of Ghoor, who defeated the king of K., and overthrew that monarchy. After this, the history of the place consists only of a succession of disasters. In 1871, this once celebrated place contained only 17,577 inhabitants, living in great indigence.

**KUPPERWUNJ**, a fortified town of British India, in the presidency of Bombay, 32 miles east of Ahmedabad, on a tributary of the river Sabarmuttee. It has some trade, and manufactures of soap and pottery. Pop. 13,000.

**KURNAL**, a town of British India, in the district of the same name, in the Punjab, on the right bank of the Delhi Canal, 78 miles north-east of Delhi city. The town is surrounded by a ruinous wall, and is excessively filthy. It has, however, a handsome mosque. Adjoining the town is a military cantonment. Pop. (1868) 29,000.

## L

**L****ABEDOYÈRE**, CHARLES ANGLIQUE HUCHET, COUNT DE, a victim of the reaction of 1815 in France, was descended from an ancient family in Bretagne, and was born in Paris on 17th April 1786. He early entered the army; was adjutant to Marshal Lannes in Spain, in 1808, and received a severe wound at Tudela; joined the army in Germany after his recovery; distinguished himself at the capture of Ratisbon, and was Murat's adjutant at the battle of Esslingen. On the evening before the battle of Lützen, Napoleon promoted him to the command of a regiment of infantry. Returning to France again severely wounded, in the autumn of 1813, he married a lady of a family very much attached to the Bourbons; and receiving the command of a regiment, was posted near Vizelle when Napoleon returned from Elba. He immediately joined him, and was made a lieutenant-general and peer of France. He fought with great gallantry at Waterloo; and after the battle hastened to Paris, when he spoke with great violence against the Bourbons in the stormy sitting of the Chamber of Peers, on 22d June 1815. After the capitulation, he thought to have escaped to America, but was taken prisoner, condemned to death, and notwithstanding every effort that could be made on his behalf, shot on 19th August 1815. He was a man of a chivalrous character, and devotedly attached to the emperor.

**LABLACHE**, LUIGI, a celebrated operatic singer, was born in Naples in 1795, whither his father and mother, who were French, had fled from Paris

during the horrors of the Revolution. His first engagement as a singer was at the San Carlo Theatre at Naples, in 1812; he afterwards sang, with much success, in La Scala, Milan, and in Vienna; singing also at the San Carlo, at Naples, during the intervals of the Vienna season. On his first appearance in London in 1830, he created a great public sensation; and for a number of years, he resided alternately in the French and English capitals, singing both in the Paris and London seasons. He died at Naples in 1858. His voice, a deep bass, has hardly ever been equalled either in volume or quality; and his acting, particularly in the characters of 'Figaro' and 'Leporello,' was almost as remarkable as his singing. He was the author of a treatise on singing, published in 1843; and he long gave instructions in singing to Queen Victoria.

**LACROIX**, SYLVESTRE-FRANÇOIS, a French mathematician, was born in Paris in 1765; and though of poor parentage, succeeded through indomitable zeal in acquiring so great a knowledge of elementary mathematics, that, at the age of 17, he obtained, by the recommendation of Mouton (q. v.), the professorship of mathematics in the Naval School at Rochefort. He was successively promoted to a corresponding position in the Ecole Normale, Ecole Polytechnique, the Sorbonne, and the College of France; was chosen member of the Academy of Sciences in room of Borda in 1799; and throughout his long life zealously pursued his duties as a teacher, widely disseminating a taste for the mathematical sciences by the numerous elementary works which were the fruit of his leisure hours. L. is not remarkable for original discovery in mathematical science;

but he deserves to be gratefully remembered for his *Traité du Calcul Différentiel et Intégral* (Paris, 1797), a work on which he spent immense labour, in order to make it a complete and harmonious compilation of the results of all previous research. The value of such a work may be estimated by Laplace's statement, that it cost him ten years' labour to supply for himself the want of such a work. L.'s other writings are treatises on Arithmetic, Algebra, Geometry, Trigonometry, Probabilities, Land-surveying; Geography, Mathematical and Physical, &c.

LA CROSSE is the name of a field game played with a ball. The Iroquois Indians have been long accustomed to play it in Canada; and some of them exhibited their skill in the game in presence of the Prince of Wales, when he was in that colony in 1860. The game was introduced to this country by 18 of those Indians who came to play it in 1867; and in 1876, teams of Canadian gentlemen and Indians visited England and Scotland for the same purpose.

In what way La Crosse differs from golf, hockey, foot-ball, and other games, may be briefly explained. Every player is provided with a kind of large battledore. This consists of a long stick of light hickory, bent at the top like a bishop's crozier; strings of deer-skin are stretched diagonally across the hooked portion in different directions, forming a network—not so tightly as in a regular battledore or racquet-bat, nor so loosely as to form a bag. As the battledore, called the *crosse*, is five or

obtain a mastery over the ball, and convey it to the opponents' goal. When scooped up from the ground, it is carried horizontally on the *crosse*, the player running towards one of the goals, trying to elude the vigilance of his antagonists. If it seems prudent, he pitches the ball off his *crosse* towards a colleague, who may be in a better position to convey it towards the goal. The ball is not touched by the hand, except under special and clearly-defined circumstances. If the ball be accidentally driven through the red goal by one of the reds, the blues win the game; and *vice versa*. The players must not strike, trip up, or grasp one another; nor must any one lay hold of the *crosse* of another. One player strikes the ball off an opponent's *crosse* with his own *crosse*, and not by any other means. Two players on the same side may fling or carry the ball consecutively.

It will thus be seen that there is a little of football, of hockey, and of racquet in La Crosse. The goals resemble those of football and hockey; the occasional struggle for the ball is like the 'scrimmage' of football, though not so rough and dangerous; the general mode of play may be compared to hockey; while the battledore claims some resemblance to the racquet-bat. There is nevertheless sufficient originality in the game to render it wholly a distinct one. La Crosse Clubs have been established at Richmond, Blackheath, Glasgow, and other places in Great Britain.

LADY FERN (*Athyrium filix femina*, or *Asplenium filix femina*), a beautiful fern, common in moist woods in Britain, with bipinnate fronds sometimes two feet long. The whole plant has an extremely graceful appearance. It is said to possess the same anthelmintic properties as the male fern.

LA'GOS, a town and island of Africa, on the coast of Upper Guinea. The island lies at the entrance to a lagoon of the Bight of Benin, near the mouth of the river Ogun; the town is at the west end of the island, 150 miles west of Benin. A number of English and other traders reside here, and the town contains many good houses built in the English style. L. was formerly a notorious seat of the slave-traffic. It was captured and destroyed by the British in December 1851, and a treaty was concluded by which the ruler guaranteed freedom of commerce, the protection of Christianity, and the abolition of the slave-trade and of human sacrifices. Pop. of the island (1871) 62,021. L., since 1861, has been a British possession. Value of imports (1873), £258,884; exports, £406,986.

LALITA-PATA'N, or PATAN, a town of Nepal, four miles south from Khatmandu, from which it is separated by the Bogmutty. L. was formerly the capital of a small independent state. It is a neat town, and has some good public buildings. It has manufactures of cotton, copper, and brass. Pop. supposed about 24,000.

LALLY-TOLENDAL, THOMAS ARTHUR, COUNT DE, a French general, of historic note as the victor

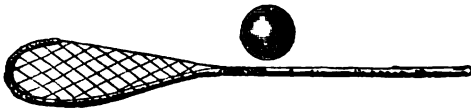

The Crosse and Ball.

six feet long, there is great leverage power in handling it. Only one ball is employed, made of india-rubber, and eight or nine inches in circumference. Posts or poles about six feet high, with a small flag at the top of each, complete the equipment. The players divide themselves into two parties, the reds and the blues; their number, as well as the size of the play-field, are nearly optional, more players being needed as the area is larger. Red predominates in the dress of one party, and blue in that of the other, for facility in distinguishing colleagues from opponents. To prepare for the game, a red goal is set up at one end of the field, consisting of two small red flags on posts, about six feet high and six feet apart; a similar goal, but blue in colour, is set up at the opposite end of the field. Now, the object of the game is, for the blues to drive the ball through the red goal, and the reds to drive it through the blue goal; and each party, of course, strives to frustrate the plan of the other. The ball is not thrown by the hand, but is hooked up from the grass by the bent end of the *crosse* or battledore; it is borne on the netting horizontally, while the player runs, and is dexterously thrown off the *crosse* when the exigencies of the game require such a manoeuvre. No player is allowed to wear spiked shoes; but a good hold of the ground is obtained by wearing moccasins, which the Indians prefer, for the purpose, to regular shoes.

In the arrangement of the men on each side, the *goal-keeper* defends the goal; *point* is the first man out from the goal; *cover-point* is a little in advance of point; *centre* is in the centre of the field; *home* is the player nearest to the opponents' goal; while the *fielders* comprise the rest of the players. Beginning near the centre of the field, the players struggle to



Frond of the Lady Fern (*Athyrium filix femina*).

of a judicial murder, was born in Dauphiné in 1698. His father, Sir Gerard Lally, was an Irish Jacobite refugee, and commander of an Irish regiment. L. distinguished himself much as a soldier in Flanders; accompanied Prince Charles Edward to Scotland in 1745; and in 1756, was made a lieutenant-general and appointed commander-in-chief in the French East Indian settlements. He commenced hostilities against the British in India, took many places, and besieged Madras itself; but sustained a severe defeat under the walls of Vindarachi, and was compelled to retreat to Pondicherry, which was attacked in March 1760 by land and sea by a greatly superior British force. Lally, however, held out for ten months; and before Pondicherry fell, on 16th January 1761, the sufferings of its defenders were terrible. L. was conveyed as a prisoner of war to England; but hearing that he had been accused in France of betraying his trust in India, he obtained leave to proceed to France for the vindication of his character. An investigation was promised, but no step was taken for a year, and then Lally was only thrown into the Bastille, where he remained 19 months before his trial took place. The parliament of Paris at last, on 6th May 1766, condemned him to death for betraying the interests of the king and the Indian Company, and the sentence was executed three days after. But his son, supported by the powerful assistance of Voltaire, procured a royal decree on 21st May 1778, declaring the condemnation unjust, and restoring all the forfeited honours.—The son, TROPHIMUS GERARD, MARQUIS DE LALLY-TOLENDAL, was born in Paris, 5th March 1751. He was one of those nobles who, in the States General, in 1789, united with the Third Estate; but alarmed at the democratic tendencies of the National Assembly, he afterwards allied himself more with the court. He laboured to procure for France a constitution with two chambers and a privileged aristocracy. He earnestly sought to protect the king, but was himself obliged to flee to England. After the Revolution of 18th Brumaire, he returned to France and lived at Bordeaux. Louis XVIII. made him a peer; but he remained true to his political principles, and defended constitutional liberty. He died on 11th March 1830. He was the author of a Defence of the French Emigrants, which made a great sensation in France at the time of its appearance, and of many other pamphlets.

**LAMBAYEQUÉ**, a town of Peru, in the dep. of Libertad, near the mouth of the river Lambayeque, 425 miles north-west from Lima. It is about five miles from the sea; but has some trade, although its roadstead is very bad, and fully a mile from the shore. L. has a church and several chapels. It has manufactures of cotton fabrics. Pop. 8000.

**LAMO'V**, or **LOMOV**, the name of two towns of European Russia, in the government of Penza, and on the river Lamov, a branch of the Mokscha, which itself is, through the Oka, a feeder of the Volga. Verknii L. (Old, or Upper L.) is about 64 miles west-north-west from Penza. It has seven churches. Pop. (1867) 8072.—Nijni L. (New, or Lower L.) is nine miles south-west from Verknii L., further down the river. It has three churches, and an annual fair, which attracts traders from all parts of Russia. Pop. (1867) 9514.

**LAMPEDU'SA** (anc. *Pelagia*), a small uninhabited island in the Mediterranean Sea, about midway between Malta and the coast of Tunisia. It belongs to the kingdom of Italy, having been formerly a dependency of Sicily. It is about seven miles in length, and in most places not quite one mile in breadth, its circuit being about 13 miles. The western part of the island is covered

with dwarf olives; and these and other shrubs supply great quantities of firewood, both to Tripoli and Malta. Great numbers of wild goats inhabit the island. L. was at one time inhabited. Near it are the two islets of Lampiona and Linosa.

**LANDED ESTATES' COURT.** See INCUMBERED ESTATES' COURTS.

**LANDERNEAU**, a small seaport town of the dep. of Finistère, France, 13 miles north-east from Brest. Only a few small vessels belong to the town, although about 700 enter and clear the port annually. The harbour admits vessels of 400 tons. Pop. (1872) 6285.

**LA'NDSKRONA**, a fortified seaport town of Sweden, on a tongue of land which projects into the Sound, 18 miles north-north-east from Copenhagen. The harbour is very good. Ship-building is carried on. Corn, fish, tar, pitch, timber, and alum are the principal exports. Pop. about 7300.

**LANGENBECK**, **BERNHARD VON**, Professor of Surgery in the University of Berlin, director of the Royal Clinical Hospital, and general staff physician of the army, is cousin of the famous surgeon, Max Langenbeck, of Göttingen. Having been appointed (1847) successor to the great operator, Dieffenbach, in Berlin, he was not long in acquiring an equally high celebrity, especially through his great skill and success in the operation for harelip, as well as in the replacement of noses, eyelids, and lips. He likewise earned a great reputation through his execution of the operation of Resection (q. v.), in which the diseased or injured part only of a bone is removed, instead of the whole limb perhaps being amputated. During the late wars in Germany, a great field opened itself for this kind of operation, and hundreds of the wounded who came under the knife of L. have to thank him for the preservation of their limbs. On account of his eminent services, he was ennobled, and received the highest medical rank in the Prussian army.

L. is a man of prepossessing appearance; and instead of that bluff harshness which, whether natural or assumed, has characterised so many great surgeons, he is eminently tender and sympathetic with his patients. As a teacher, he is highly successful; and the Clinical Hospital in Berlin, under his personal direction, is the resort of patients from all countries of the world.

**LA'NGNAU**, a town of the canton of Bern, Switzerland, 15 miles east from Bern, in the Emmenthal. It is situated on the Ilfis, a branch of the Emmen. Weaving is carried on to some extent, and L. is the principal mart for the cheese and linen thread of the Emmenthal. Pop. (1870) 6214.

**LAP-DOG**, a name common to all those diminutive varieties of dog which are kept as drawing-room pets, and which ladies take with them in their carriages. Most of them are Spaniels (q. v.), as the King Charles's Spaniel, the Maltese Dog, &c. Gentleness of disposition, large ears, and long hair, are among the approved characteristics of lap-dogs. The very smallest of the race is the MEXICAN LAP-DOG.

**LAPÉROUSE**, **JEAN FRANÇOIS DE GALAUP**, COUNT DE, a famous French voyager, born near Albi, in Languedoc, now in the dep. of Tarn, in 1741; attained the rank of captain in the French navy; and was sent, in 1782, to destroy the British forts or settlements in Hudson's Bay. In this expedition he shewed a remarkable power of contending with difficulties, and accomplished his object notwithstanding the storminess of the sea and the ice in which it abounded. He signalled himself also by his humanity towards the occupants

of the forts which he destroyed. He was now chosen to command an expedition of discovery sent out by the French government. He sailed, in August 1785, with two ships, visited the north-west coast of America, explored the north-eastern coasts of Asia, and made important discoveries in that region, although he failed to discover that object of so many expeditions, the North-west Passage. In February 1788, he anchored in Botany Bay, after which no trace of him was obtained, although the French government offered a reward of 10,000 francs for information, and sent out an expedition under D'Entrecasteaux, in 1791, to search for him, until, in 1826, the captain of an English vessel, Captain Dillon, found on the island of Tucoopia, to the N. of the New Hebrides, a number of things which had belonged to L.'s ships, and which had been obtained from the inhabitants of Mallicollo, one of the New Hebrides. Investigation being made by the East India Company, which sent Captain Dillon for this purpose, and, subsequently, by the French government, which sent out an expedition under Dumont d'Urville, eye-witnesses were found of the destruction of two French ships on the coast of Mallicollo, and five French cannons and other remains of the expedition were found there. It was fully ascertained that both of L.'s ships had been wrecked in a storm on a coral reef, and that all on board had perished. Dumont d'Urville erected a simple monument with a brief inscription in memory of his ill-fated countrymen. The account of L.'s voyage, published under the title of *Voyage autour du Monde* (4 vols., Paris, 1797, with atlas), was prepared by order of the French government, from the journals which were sent home by him from Kamtschatka. But the collections and notebooks of the naturalists who accompanied the expedition, perished along with themselves.

**LARNE**, a market and seaport town of Ireland, in the county of Antrim, on Lough Larne. A mail-steamers sails daily between L., which is connected with the Northern Counties Railway, and Stranraer, in Scotland. L. possesses two large flour-mills, and extensive bleaching-grounds. Pop. (1871) 3343.

**LARNICA**, or **LARNAKA** (anc. *Cittium*), a town of Cyprus, in N. lat. 34° 55', and E. long. 33° 37', about a mile from the S. coast of the island. Owing to its filthy condition and the neighbouring marshes, L. is very unhealthy. Water is very scarce. L. is, however, the chief seat of the commerce of the island, and the residence of European merchants and consuls. There is regular steam-boat communication with Constantinople, Smyrna, Alexandria, and Marseille, and occasionally with Liverpool. Value of exports (chiefly grain, cotton, silk, wool, and drugs) in 1874, £318,625; of imports, £100,262. There are many remains of antiquity about the town. Pop. 10,000.

**LATREILLE**, **PIERRE-ANDRÉ**, an eminent naturalist, particularly distinguished as an entomologist, born in 1762, at Brive, in the dep. of Corrèze, France. He was descended of a noble family, but was left an orphan at an early age, and with very slender means of subsistence. In 1778, he was placed in the college of Cardinal Lemoine, at Paris, to be educated for the church. Whilst here, he acquired the friendship of Haüy (q. v.). He now began to devote himself almost exclusively to the study of insects. He completed his education for the church, and received ordination—a circumstance which afterwards, in the days of the Revolution, exposed him to much hardship and danger. He gave himself, however, chiefly to entomological studies. His first publication was on the *Mutillas* of France, insects of the order *Elymenoptera* (1792); which was followed by very

many other works of the same kind, articles in encyclopædias, magazines, &c. In 1796, he published, at Brive, his first great work, *Précis des Caractères Génériques des Insectes, disposés dans un Ordre Naturel*. It was an important step towards a truly natural system of entomology, although really a mere sketch of a system. An interesting incident falls here to be mentioned. During the fury of the French Revolution, L. was condemned to *déportation*, and sent to prison at Bordeaux, awaiting the execution of his sentence. The surgeon who visited the prison observing the prisoner attentively looking at a small insect (*Necrobia ruficollis*), was informed by him that it was very rare, and that he wished to transmit it to two young naturalists in Bordeaux. His wish was gratified, and the young naturalists—MM. Dargelas and Bory de Saint-Vincent—exerted themselves to obtain his release, in which they ultimately succeeded. L. always remembered this with great gratitude, and has commemorated the incident in some of his works. A figure of the insect is engraved on his tomb. L. was again in danger in 1797, when he was proscribed as an *émigré*; but again he escaped through the influence of friends. Having, after the Revolution, relinquished all thoughts of the church, he entirely devoted himself to natural history; was received as a corresponding member of the Institute; and was employed in the arranging of insects in the Museum of Natural History. He died at Paris, 6th February 1833, at the age of 70. His works on natural history are very numerous. The most important, besides those already noticed, are: *Histoire des Salamandres* (Par. 1800); *Histoire Naturelle des Singes* (2 tom., Par. 1801); *Essai sur l'Histoire des Fourmis* (Par. 1802); *Histoire Naturelle des Reptiles* (4 tom., Par. 1802); *Genera Crustaceorum et Insectorum* (4 tom., Par. 1806—1809); *Considérations sur l'Ordre Naturel des Animaux*, &c. (Par. 1810); *Familles Naturelles du Règne Animal* (Par. 1825); *Cours d'Entomologie* (2 tom., Par. 1831—1833). L. contributed greatly to the present natural system of entomology; and his labours in other departments of natural history were not inconsiderable.

**LAUENBURG**, a town of Prussia, in the province of Pomerania, 38 miles west-north-west from Danzig. Manufactures of woollen and linen cloth, and of white and common leather, are carried on. Pop. (1871) 6764.

**LAURIA**, a town of Italy, in the province of Potenza (formerly Basilicata), 98 miles south-east-by-east from Naples, and about five miles from the shore of the Gulf of Policastro. Opposite to it is the imposing mass of Monte Sirino. L. is an ancient town, but still of considerable prosperity. Woollen manufactures are carried on. Population of L. Superiore, 4791, and of L. Inferiore, 4258; total, 9049.

**LAURVIG**, a seaport town of Norway, situated at the head of a small fiord, which branches off from Christiania Fiord. The town of L. has of late rapidly increased in population and prosperity. It carries on a considerable trade with foreign countries, and particularly with Britain. Very extensive iron-works—the Fritzo iron-works—are situated near the town. A cannon-foundry gives employment to many operatives. There are also snuff-manufactories and distilleries. The harbour is excellent, and suitable for the largest vessels. Pop. 4944.

**LA VILLEMARQUÉ**, **THÉODORE-CLAUDE-HENRI HERSART**, **VICOMTE DE**, a Breton antiquary and Celtic scholar, was born at Quimperlé, in Bretagne, on the 6th July 1815. Representing an old

family of his native province, his attention was early turned to its antiquities and its peculiar language and literature. His first important work was a collection of popular Breton songs and melodies, published in 1839, with a French translation and notes, under the title of *Barzaz-Breiz*. Three years afterwards appeared his *Popular Tales of Bretagne*, to which was prefixed a dissertation on the story of the Round Table. His next work was a collection of the poems of the Celtic bards of the 6th c., with a French translation, and explanatory and critical notes (1850). This publication made the labours of La V. widely known. He was appointed a correspondent of the Academy of Berlin, and a member of the French Institute (Academy of Inscriptions and Belles-Lettres). La V. has since published a work entitled the Celtic Legends (*La Légende Celtique*) of Ireland, Cambria, and Bretagne, which contain such of the original texts—Irish, Welsh, or Breton—as are rare or unpublished. La V. is the author or editor of several other works connected with the Celtic literature and languages, among which are a *Breton Grammar*, a *Breton and French Dictionary*, *Bretagne Ancient and Modern*, and *The Great Mystery of Jesus*, with a dissertation on the dramatic literature of the Celts.

LAWN TENNIS, a modified form of the old game of Tennis (q. v.), has recently become a popular pastime alike for ladies and gentlemen. The ground on which it is played is a strip of turf (sometimes asphalt), 78 feet in length by 30 in width at the extremities. Across the centre extends a net 5 feet high, stretched from poles 24 feet asunder. Lines are drawn marking the boundaries, and dividing each of the portions of ground separated by the net lengthwise into a right court and a left court. Any number of players may join; but the best game is played by two or four persons. The player who begins stands just on the back boundary of the right court on his side, throws up the ball, and on its rebound strikes it with the racket so that it shall fall over the net into the nearer part of the right court diagonally opposite him. His opponent there is bound to strike back the ball either before it reaches the ground or after the first rebound. It is then returned again by the first player, who continues to play till he fails to return the ball, sends it without the boundaries, or commits some of the other 'faults' recognised by the rules; when his opponent takes his turn.

LAWRENCE, SIR WILLIAM, a distinguished surgeon, was born at Cirencester, in Gloucestershire, in July 1783. In 1800 he went to London, and was apprenticed to Mr Abernethy, by whom before the end of three years he was appointed demonstrator in anatomy to Bartholomew's Hospital. In 1813 he was made surgeon to the hospital, and was chosen fellow of the Royal Society; and after holding various important surgical appointments, he became in 1815 one of the professors of anatomy to the Royal College of Surgeons. In 1828—1829, he succeeded his teacher, Mr Abernethy, as lecturer on surgery to St Bartholomew's. From this period, L. took an active share in the great questions of reform, which divided the medical world as much as the political, and played the part alternately of an advocate and an opponent of innovation. He made many enemies, but continued to enhance his reputation as a surgeon and his position as a practitioner, and contributed many valuable works to the literature of his profession. He succeeded Sir Benjamin Brodie as sergeant-surgeon to the Queen, on which occasion he received his baronetcy. He died of paralysis, at the age of 83, in Whitehall on the 5th July 1867. His writings, which

are very numerous, are chiefly the following: *A Description of the Arteries of the Human Body, reduced into the form of Tables*, translated from the Latin of Adolphus Murray, Professor of Anatomy at Upsal; *The Treatment of Hernia*; *An Introduction to Comparative Anatomy and Physiology, being the Introductory Lecture delivered at the Royal College of Surgeons in 1819*; *A Treatise on the Venereal Diseases of the Eye*; and *A Treatise on the Diseases of the Eye*, in general, &c. Of these works, the most important for his reputation and for the profession are those on the venereal diseases of the eye, and on hernia.

LAYAMON, also LAWEMAN, author of the *Brut*, a metrical chronicle of Britain from the arrival of the fabulous Brutus to the death of King Cadwallader, 689 A.D., was, he himself tells us, a priest at Ernely, on the Severn, in Worcestershire, and appears to have flourished about the beginning of the 13th century. Nothing more is known concerning him. The value of the *Brut* is not so much literary as linguistic. It has no high pretensions to originality, being confessedly a compilation from Bede, St Augustine (of England), St Albin, and more particularly Wace, the Anglo-Norman poet, of whose *Brut d'Angleterre* it is in fact mainly an amplified translation. But Wace's performance is itself only a translation, with additions, from Geoffrey of Monmouth's Latin *Historia Brittonum*; and that again at least declares itself to be in turn a translation from a Welsh or Breton original (see GEOFFREY OF MONMOUTH). It will thus be seen that L.'s work is only a third reproduction of a Celtic story; but in justice to the author, it must be stated that his version is more poetical and dramatic than those of his predecessors. The great value of the poem, however, is, as we have said, linguistic rather than literary. It shows us the Anglo-Saxon changing or changed into Early English, and a study of its peculiarities of grammar and phraseology enables us to trace the process by which the Saxon of Alfred and the Chronicle became transformed into the English of Chaucer and Wicliffe. One curious and important fact is determined by it—viz., that 200 years after the Norman Conquest, the use of words of French origin—so marked a feature of Chaucer's diction—had scarcely begun. In the 32,250 lines which the poem contains, there are not more than 50 such words. The versification is very arbitrary, exhibiting sometimes the alliteration of Anglo-Saxon, and sometimes the rhyme of French poetry. The work was edited (with a literal translation, notes, and a grammatical glossary) for the Society of Antiquaries of London by Sir Fred. Madden (Lond. 3 vols. 1847).

LEAPING-FISH (*Salaria tridactylus*), a curious little fish of the Blenny family, abounding on the coast of Ceylon, and remarkable for leaving the water to visit every place washed by the surf. By the aid of the pectoral and ventral fins, and the gill-covers, it moves across the damp sand, ascends the roots of mangroves, and runs up wet rocks in quest of flies. 'These little creatures are so nimble,' says Sir J. E. Tennent, 'that it is almost impossible to lay hold of them, as they scramble to the edge, and plunge into the sea on the slightest attempt to molest them.' They are three or four inches long, and of a dark brown colour.

LEATHER-CLOTH is one among many names given to manufactured fabrics intended to possess most of the good qualities of leather, without being so costly. As far back as 1849, a material under this name was invented in America; and many specimens of it were placed in the Great Exhibition of 1851. In 1855, a factory for making it was

established at West Ham, in Essex, and the operations were organised there on a scale equal to the production of 10,000 or 20,000 square yards per day. Linseed oil is heated in large coppers to a certain high temperature, then removed to cool; then mixed with other ingredients, two of which are turpentine and lampblack. This composition is used as a kind of varnish to be applied to the surface of unbleached cotton. The cotton, woven to various widths and lengths, is calendered to make it smooth, and then passed over a roller; the composition is applied to it, and a peculiar kind of knife scrapes the layer to an equable thickness and a smooth surface. After being dried in a heated oven, the cloth is passed between rollers covered with pumice-dust, to rub the composition smooth. These processes are repeated four or five times. The cloth is next painted three or four times with a kind of enamel paint. Some kinds are grained like morocco leather, by being passed between rollers peculiarly grooved on the surface; others receive a pattern in relief by passing between embossing rollers; while the specimens intended for furniture-hangings and table-covers are printed in gold and colours. The uses of this leather-cloth are numerous. The United States army, in 1862, had capes, leggings, and knapsacks made of it.

The leather-cloth made on Seager's patent is in fact leather, not cloth. It consists of leather parings and shavings, reduced to a pulpy mass, and moulded to any useful or ornamental forms, such as machinery-bands, buckets, architectural ornaments, picture-frames, &c. It may be made either hard or pliant, according to the mode or degree of pulping. Messrs Spill's *vegetable leather* is made chiefly of caoutchouc and naphtha; the smell of the latter is removed by chemical treatment; and the sheets made are thickened to any degree by successive backings of canvas. The material is tough, resists damp, and takes a polish, and is available for bookbinding, library table covers, carriage aprons, soldiers' belts, harness, and other purposes. Szerelmy's *leather-cloth* is, like some other kinds, an application of oily pigments to cloth; according to the nature of the textile used as a backing (cotton, linen, woollen, silk, or alpaca), and to the mode of applying the surface composition, the material becomes an imitation of morocco, of calfskin, of enamel leather, or of waterproof cloth. Le Jeune's *leather substitute* consists of a cement or mastic of caoutchouc or of gutta percha on cloth, felt, or leather, pressed by rollers, and then pressed upon a layer of leather. By a peculiar splitting machine, a thin sheet is produced with an extremely thin layer of leather upon it. Another cloth is then cemented to the remaining leather, followed by another splitting; and so on till the leather is exhausted. The cloth enables the leather to be split thinner than would be otherwise practicable. The resulting substance, therefore, is really leather on one side, and may be dyed and embossed in various ways; the intervening caoutchouc or gutta percha renders it waterproof. Beard and Downing's *Artificial Leather* consists of an open linen fabric, upon which a fleece of cotton or wool fibres is cemented by a composition of oil and resin, pressed down by rollers; two or more successive layers of fleece and cement thicken the substance. Ground leather is sometimes mixed with the fleece, and the surface will receive any of the usual oil colours.

These various substances, it will be seen, are intended in most cases as substitutes for leather, but in others as a kind of floor-cloth. There are differences between all of them and Kamptulicon (q. v.) and Linoleum (q. v. in SUPP., Vol. X.).

LEBRJA (anc. *Nebriasa-Veneria*), a town of Spain, in the province of Seville, 34 miles south by west from Seville, on an affluent of the Guadalquivir, and on the railway between Seville and Cadiz. It is pleasantly situated on a slight eminence, which overlooks a plain liable to be overflowed by the Guadalquivir and its branches. A large church, originally a mosque, exhibits a strange combination of the Arabic, Roman, and Gothic styles. L. is famous for its oil. There are manufactures of woollen cloth, hempen fabrics, glass, pottery, bricks, tiles, and soap. Pop. 12,000.

LECTIONARY (Lat. *Lectionarium*), one of the service-books of the mediæval church, so called because it contained the lessons (*lectiones*) of the church-service. Of these there are two which deserve special notice. The first is the so-called 'Roman Lectionary,' which contained the epistles and gospels of the Roman missal, and sometimes all the lessons of all the various services in use in the Roman Church, in which case it was named the *Plenarium*. The most ancient form of the Roman Lectionary was called 'Comes' or 'Liber Comitis.' Its compilation was attributed to St Jerome, and it appears certain that it belongs in substance, although not in form or in details, to that age. The collection was revised and remodelled in the 8th century. The second of the ancient lectionaries is that known as the Gallican Lectionary, which was published by Mabillon from a MS. of the monastery of Luxeuil, and which is believed to represent the rite of the ancient Gallican Church, chiefly because one of the few saints' offices which it contains is that of the peculiarly French saint, Geneviève. It is interesting as shewing that the Gallican liturgy had three lessons, and not two, as in the Roman missal. Unfortunately, Mabillon's MS. of this highly interesting relic of ancient Gaulish Christianity is imperfect, and no other has since been discovered.

LEER, a town of Prussia, Hanover, in East Friesland, 32 miles west-north-west from Oldenburg, on the right bank of the Leda, near its junction with the Ems. There are manufactures of linen, hosiery, &c.; breweries and distilleries; and ship-building yards. A railway, opened in 1856, runs northwards to Emden, and southwards to Papenburg, Osnabrück, and Münster. Pop. (1871) 8932.

LEGNA'GO, a fortified town of Northern Italy, in the province of Verona, on the left bank of the Adige, 22 m. S.S.E. from Verona. It has manufactures of hats and leather, and a considerable trade in wheat and rice. The cultivation of rice is extensively prosecuted in the neighbourhood, and tends to increase its natural unhealthiness. The country is swampy, and intermittent fevers prevail. L. is one of the fortresses in the famous Quadrilateral (q. v.). Pop. 3514.

LEIPA, or LEIPPA, a town of Bohemia, 42 m. N.N.E. from Prague, situated not far from the right bank of the Polzen, a branch of the Elbe. L. has an Augustine monastery. It is a place of considerable industrial activity, having manufactures of woollens, cotton, glass, and earthenware. Pop. (1869) 9244.

LEITMERITZ, or LITOMIERCZICZE, an old walled town of Bohemia, on the right bank of the Elbe, 34 miles north-north-west from Prague. The situation of the town is beautiful, on the slope of a hill which rises from the river. One of the churches has a tower shaped like a cup, a curious memorial of the fierce religious contests which raged in Bohemia in the 16th c., and in which the question of the use of the cup by the laity in the sacrament of the Lord's Supper had so great prominence. Much of the Bohemian glass is polished in L., and

it has an active trade in corn, wine, fruit, and fish. Straw hats and chicory are also among its articles of produce. It is celebrated for a kind of apple called the *Borsdorf*, which is sent in large quantities both to Berlin and St Petersburg. Pop. (1869) 10,023.

**LEITOMISCHL**, or **LEUTOMISCHEL**, a town of Bohemia, 84 miles east-south-east from Prague. It stands on the left bank of the Launche, an affluent of the Elbe. A castle, erected in the 16th c., is esteemed one of the finest buildings of its kind in Bohemia. L. has manufactures of linen, and an active trade in corn, fish, and wine. Pop. (1869) 7021.

**LENNEP**, a town of Rhenish Prussia, 22 miles east-south-east from Düsseldorf, in a beautiful valley, on the Lennep, an affluent of the Rhine. It is a principal seat of the woollen manufacture, and the cotton manufacture is also carried on. Pop. (1871) 7722.

**LENS** (anc. *Elena* or *Lenense*), a town of France, in the dep. of Pas-de-Calais, on the Souchez, a feeder of the Scheldt, 17 miles south-west from Lille. It is a place of great antiquity, and was once strongly fortified. It is famous for the great victory gained by the Prince of Condé over the Germans and Spaniards, under its walls, in 1648. In the neighbourhood of L. are coal-mines, lime-works, and brick-works. Pop. (1872) 7298.

**LEPI'SMA**, a genus of wingless insects, of the order *Thysanura*. The best known species is *L. saccharina*, sometimes called the *Sugar Louse*, because it is often found about old sugar barrels. It is said to have been introduced into Britain from America. All the species of *L.* and of the family *Lepismida* inhabit moist places, and feed on decaying vegetable substances. They have a flattened, spindle-shaped body, terminating in three long bristles. They run swiftly. They are mostly covered with silvery scales, which are much used as test objects for the microscope.

**LERCA'RA DE' FREDDI**, a town of Sicily, in the province of Palermo, 30 miles south-south-west from Palermo, in an inland mountainous district. Most of the inhabitants are employed in the sulphur mines of the vicinity; and the road to Palermo is much occupied by carts carrying sulphur for exportation. Pop. above 9000.

**LESSON** (Lat. *lectio*, Fr. *leçon*, a reading, called by the Greeks *anagnoma*), in Liturgical Literature, means a portion of the church service appointed to be read, chiefly with a view to instruction and exhortation, not couched in the form of a prayer, nor, even when found in the mass or the communion service, directly bearing upon the consecration of the Eucharistic elements. The lessons of the Eucharistic service in the Roman Catholic Church are always taken from the books of the Old or New Testament (including the Apocrypha); but in some of the other services of the Roman, Greek, and Oriental churches, portions of the writings of the Fathers, lives of saints, and occasionally short narratives from church history, are employed. The very earliest notices which we have of the liturgical services of the first Christians, allude to the usage of reading portions of sacred Scripture publicly in the church. The practice existed among the Jews in their synagogues (Luke iv. 16), and St Paul frequently alludes to its use also in Christian assemblies, in his epistles to the infant churches of Colosse, Laodicea, and Thessalonica. It is even more circumstantially referred to by Tertullian (*Apolog.* c. 39; and again, *Prescript.* c. 36), and by Justin the Martyr in his *Apology* (1 *Apol.* n. 67). Our information regarding the liturgy of this early period is too

scanty to enable us to say what order was followed, and what principles were adopted in selecting the portions of Scripture for these solemn readings; but from the Fathers of the 4th and later centuries, it is plain that the selection was in some degree regulated by the seasons; and, at all events, that it was not left to the determination of each individual minister or even church. It would seem that in general the extracts were so disposed as to present the several books of Scripture in succession; but at particular times, portions were chosen which seemed appropriate to these times. Thus, the lessons at and after Easter were the Gospel narratives of the Resurrection; between Easter and Pentecost, the Acts of the Apostles; in Lent, they were taken from Genesis and the other books of the Pentateuch; in Passion-tide, from the Book of Job. In the modern Greek Church, so strictly is this order observed, that the Sundays of certain periods are known by the names of the Evangelists read at that time—as the first, second, or third 'Matthew-Sunday,' 'Mark-Sunday,' &c. In the Roman missal, the distribution of the Gospel lessons is regulated more by the subjects than by the authors; and in addition to the distribution according to time, there is another which is regulated by the nature of the festivals, or the special characteristics of the saints to whose offices they are appropriated. The time and the origin of this distribution are uncertain; but it is commonly ascribed, at least in part, to St Jerome, and distinct traces of it are found in several writers of the 5th and following centuries.

In the service-books of the Roman Catholic Church, the lessons of the missal are always from Holy Scripture; and they are, unless in a few exceptional cases, two in number, the first called (as being ordinarily taken from one of the Epistles of St Paul, or the canonical epistles) the 'Epistle;' the other, the 'Gospel.' A second Gospel is commonly read, which is taken from the 1st chapter of St John. The Epistle is taken either from the canonical epistles of the New Testament, or, less frequently, from one of the books of the Old Testament, including the Apocrypha (generally from Wisdom, Ecclesiastes, Ecclesiasticus, or Proverbs), but occasionally from the books of the Pentateuch and other historical books. On a few exceptional occasions, chiefly in Advent and Lent, or at the Quarter Tenses (as the Ember-days are named in the language of the Roman Church calendar), more than one Epistle occurs. The distinction of the 'Epistle Lesson' and the 'Gospel Lesson' is at least as ancient as the time of St Augustine (see Aug. Serm. 176). In the solemn or high mass, each of these lessons is chanted or recited by a separate minister—the Epistle by the sub-deacon, the Gospel by the deacon; the former being chanted at the right side, the latter at the left side of the altar. In the low mass, both are read by the priest; but the same difference of position in reciting them is observed by the single priest. Anciently, one or both were chanted from an elevated platform or pulpit called *ambo*, and in Gothic churches, from a gallery attached to the rood-screen. The recitation from the *ambo* is retained in the Ambrosian rite as still practised in the Milan Cathedral. In the several Eastern rites, the lessons are more numerous than those corresponding to the Roman Epistle, being chosen from the Old Testament, from the Acts of the Apostles, from St Paul's Epistles, and from the Catholic epistles. The Gospel-lessons are, of course, taken from the several Evangelists. In the Greek Church, the former is read by the *anagnostes* or *lector*; the latter by the deacon. In the other Eastern churches, both are read by the deacon, with the exception of the Syrian Church, in which the

Gospel is read, not by the deacon, but by the priest.

The 'lessons' of the Roman breviary are more varied. They occur only in matins, with the exception of a 'short lesson' which is found in Prime and also in Compline. The lessons of matins are sometimes three, sometimes nine in number, according as the matins consist of one or of three 'nocturns.' See BREVIARY. When there are three nocturns, the lessons of the first are commonly from the Holy Scriptures, the books of which are so distributed throughout the seasons, that portions of every book shall be read during the year. The lessons of the second nocturn consist either of a narrative of the life of a saint, or of the circumstances of a festival, or of a sermon or other discourse from a holy Father; and those of the third are generally from a homily of one of the Fathers upon the Gospel appropriate to the festival. The 'short lessons' of Prime and Compline consist of sentences from Holy Scripture.

In the public and solemn offices, the lessons are chanted, the tones being reputed of ancient origin; and the chanting of the Gospel especially being accompanied with special marks of reverence for the word of God, as the incensation of the book of the Gospel, signing it with the sign of the cross, and the bearing of lights during the singing—a practice which was already ancient as early as the days of St Jerome's controversy with Vigilantius. When the pope officiates solemnly, the Epistle and Gospel are chanted in Greek as well as in Latin, in order to denote the union of both the rites in one Catholic Church; and at the coronation of at least one of the popes (Alexander V.), the Gospel was sung in Latin, Greek, and Hebrew.

In the Church of England the term is used only of the portions of Scripture appointed to be read at morning and evening prayer, and at the service for the burial of the dead. The enlargement of this part of the service formed a great feature of the Reformed liturgy, and was a return to the more ancient use, entire chapters being substituted for short selected passages. Four lessons are appointed for every day, two at morning and two at evening prayer. The first lesson, at each service, is taken from the Old Testament—which is read through, in course, once a year (the order of the books being only departed from in the reservation of Isaiah for the season of Advent)—and from certain books of the Apocrypha, viz., Tobit, Judith, Wisdom, Ecclesiasticus, Baruch, and the histories of Susanna and of Bel and the Dragon, which are read for the reasons quoted from St Jerome, in the Sixth Article of Religion, viz., 'for example of life and instruction of manners,' but not 'to establish any doctrine.' The second lessons are from the New Testament, which is read through three times in the year—that in the morning from the Gospels and Acts of the Apostles, that in the evening from the Epistles. 'Proper,' i. e., special first lessons, are appointed for all Sundays and holidays; those for Sundays were fixed at the restoration of the Reformed liturgy under Elizabeth, and consist of chapters selected from the various books, so arranged as to follow the seasons of the Church—a. g., those during Advent are taken from Isaiah, those from Septuagesima to Easter from Genesis and Exodus, so that the account of the institution of the Passover, and the going out from Egypt, falls on Easter Day. The general purpose of the Sunday proper lessons, seems to be that of representing the divine dealings with the Church of the Old Testament. The first lessons, on the minor holy-days, are taken, in course, from the didactic books of the Old Testament and Apocrypha. Except on the chief festivals, there are no proper second lessons, the New Testament

being ordinarily read through, in course, on Sundays and week-days, so causing the fixed first lesson to combine with the varying second lesson, in a manner which sometimes throws much light on both. Parts of Leviticus and Joshua, and the two books of Chronicles, are omitted; and the Apocalypse is resorted to, only to supply the second lessons for the feast of St John the Evangelist, and at evening service on All Saints' Day. The lessons for each service are ascertained by reference to a calendar, prefixed to the Book of Common Prayer—the proper lessons, which always supersede the others, being given in separate tables. When a lesson is directed to be read to any verse, it is always *exclusive* of that verse. The lessons are allowed to be read by persons not in holy orders, but are directed to be so read 'as may best be heard of all present.' Each lesson is followed by a canticle or psalm, after the manner of the old responsory, and on the principle that every revelation of the divine character and dealings affords fresh material for His praise.

**LEUCORRHOEA** (Gr. *leukos*, white, and *rheo*, I flow) is a female disease, in which the most prominent symptom is the discharge of a glairy fluid, often in a considerable quantity. For the special character of this complaint, we must refer to medical treatises; it is sufficient here to say that its general treatment consists in fomentations, the application of emollients, and in the administration of tonics and astringents.

**LEUTSCHAU** (Hung. *Lőcse*), a town of Hungary, in the county of Zips, 126 miles north-east from Pesth. L. has the oldest Lutheran college in Hungary. The inhabitants, three-eighths of whom are Protestants, are mostly occupied in agricultural pursuits. A peculiar kind of mead made here has a large sale not only in Hungary, but in Poland and Silesia. Pop. (1869) 6887.

**LEUZE**, a town of Belgium, in the province of Hainault, 17 miles north-west from Mons, on the right bank of the Dender, and not many miles from its source. Dyeing, bleaching, brewing, and distilling are actively carried on; also salt-refining and the expressing of oil. Woollen and cotton hosiery and lace are manufactured. Pop. (1870) about 6100.

**LE VAILLANT, FRANÇOIS**, a distinguished traveller and naturalist, particularly eminent as an ornithologist, was born in 1753 at Paramaribo, in Dutch Guiana, where his father, a rich French merchant, was then French consul. When he was ten years of age, his father returned to Europe, and settled at Metz, his native place. Young Le V. received a good education. Beginning as a mere sportsman, he soon became an ornithologist. In 1777, he visited Paris, and inspected the rich collections of natural history there. He was now seized with a strong desire to visit unexplored countries, and embarked, at Amsterdam, in a Dutch vessel for the Cape of Good Hope. Owing to the accidents of war, which had broken out between Britain and Holland, Le V. found himself at the Cape with nothing but his fowling-piece, ten ducks, and the clothes he had on. He found friends, however, in some of the Dutch officials, who assisted him, and provided him with the means of carrying out his intention of South African explorations. He made two principal excursions: the first from December 1781 to April 1782, eastward, at no great distance from the coast, to the Great Fish River, whence he returned by a more northern route through mountainous regions; the second, in 1783 and 1784, northwards from Cape Town as far as the Tropic of Capricorn. In both journeys, his love of adventure was sufficiently gratified, and in the second he endured hardships not inconsiderable.



Finding that his health suffered from fatigue and from the climate, he wisely relinquished further projects of travel, and returned to Europe, taking up his abode in Paris, where he devoted himself to the stuffing of his collection of skins of birds and other animals, an art in which he excelled, and to the preparation of works giving an account of his travels and of his discoveries in natural history. In 1793, during the Reign of Terror, he was thrown into prison, and only escaped the guillotine through the fall of Robespierre. He now retired to a small property at La Noué, near Sezanne, where he chiefly resided during the remainder of his life. He died 22d November 1824, at the age of 71.

Le V.'s chief works are his Travels (*Voyage dans l'Intérieur de l'Afrique*, Paris, 1 vol. 4to, or 2 vols. 8vo, 1790; and *Second Voyage dans l'Intérieur de l'Afrique*, 2 vols. 4to, Paris, 1796), which were speedily translated into English and other languages, and are remarkable for their spirited narration of incident, and the interest with which every subject is invested; and his *Natural History of the Birds of Africa* (6 vols. 4to, Paris, 1796—1812). He published also several works on particular departments of ornithology, as a *Natural History of Parrots*, a *Natural History of Birds of Paradise*, &c. He made many discoveries in various departments of natural history, but chiefly in ornithology.

LEVICO, a town of the Tyrol, Austrian Empire, 9 m. S.E. by E. from Trient (*Trent*), in the upper part of the valley of the Brenta, and near the small lake of Levico, where that river rises. Mulberry trees are cultivated, and the care of the silkworm and spinning of silk employ many of the people. Pop. (1869) 6250.

LEYDEN, JOHN, a poet and orientalist of some celebrity, was born at Denholm, a village of Roxburghshire, Scotland, 8th September 1775. His parents were in humble circumstances; but seeing his desire for learning, they made an effort for his education; and after passing through the ordinary course of study in the university of Edinburgh, he was licensed as a preacher or 'probationer' of the Church of Scotland. During the years of his university course, he had, however, learned much that formed no necessary part of it, and in particular, several of the languages of modern Europe, and some of the oriental languages. He was a most ardent and enthusiastic student. His varied gifts and attainments soon recommended him to the attention of some of the most eminent men of the time in Edinburgh. In 1799, his first work issued from the press, *A Historical Account of the Discoveries and Settlements of Europeans in Northern and Western Africa*. About this time also he contributed many translations from the northern and oriental languages, and original poems to the *Edinburgh Magazine*. He contributed to Lewis's *Tales of Wonder*, and aided Scott in amassing materials for his *Minstrelsy of the Scottish Border*. He was editor for one year of the *Scots Magazine*. In order to obtain opportunity of gratifying the strong desire which he felt to visit oriental countries, he studied medicine, and in 1802, sailed for India, having received the appointment of assistant-surgeon on the Madras establishment. Before leaving his native country, he completed his *Scenes of Infancy*, a poem containing much that is beautiful; but on which, however, his reputation does not rest so much as on his minor pieces, and particularly his ballads. After his arrival at Madras, his health soon gave way, and he was compelled to remove to Penang, where he ardently prosecuted the study of the language, literature, history, &c. of the Indo-Chinese tribes. Having resided for a time in

Penang, he left it for Calcutta, on being appointed a Professor in the Bengal College; and he soon afterwards exchanged this office for that of a judge at Calcutta. When the expedition against Java was undertaken, L. obtained leave to accompany the governor-general thither; and at Batavia, in the exploration of a library which contained many Indian manuscripts in its musty recesses, he contracted a fever, of which he died, after a few days' illness, Aug. 28, 1811. L.'s versification is soft and musical; but 'he is an elegant rather than a forcible poet.' His attainments as an orientalist were extraordinary. The chief evidence extant of them, however, is an *Essay on the Languages and Literature of the Indo-Chinese Nations*, published in the *Asiatic Researches*. His *Poetical Remains* were published in 1819; and a new edition of his *Poems and Ballads*, with Memoir by Sir W. Scott, in 1858. A monument to L. was erected in Denholm. In 1875—his centenary—two new editions of his poems appeared.

LI, the name of a Chinese measure of length. The li = 577 Fr. kilomètre = 358 (rather more than one-third) English mile.

LIBRI-CARRUCCI, GUILLAUME BRUTUS ICIUS TIMOLEON, COUNT, French mathematician and bibliographer, son of an Italian refugee, who was condemned at Lyon in 1816 for forgery, was born at Florence 2d January 1803. Having early devoted himself to the study of mathematics, he became professor in the university of Pisa, where he contributed to the Transactions of scientific societies a number of remarkable papers on *The Theory of Numbers* (1820); *Some Points of Analysis* (1823); *The General Resolution of Indeterminate Equations of the First Degree* (1826); &c.

After 1830, having been compromised in the political movements, he was obliged to leave Tuscany, and went to France as refugee. He there found a patron in Arago (whom he afterwards attacked in the most spiteful manner); was naturalised, and in a short time elected Member of the Academy of Sciences, Professor of Analytics at the Sorbonne, Chief Inspector of Public Instruction, and Superintendent of the State Libraries. He was decorated with the Legion of Honour, and appointed editor of the *Journal des Savants*, &c. L.'s works at this period are varied and numerous. In particular may be mentioned his *History of Mathematical Science in Italy from the Renaissance to the End of the 17th Century* (1838—1841, 4 vols. 8vo), in which he displayed much acuteness and erudition. He was, besides, a most determined bibliomaniac, and found means of collecting a library for himself, which contained such a rich stock of *incunabula* of all kinds, and of the greatest typographical curiosities, that several public sales, which he got up for his own benefit, and of which each realised from £4000 to £5000, did not in the least degree diminish his collection. In consequence of the remarkable phenomenon of a library remaining complete in spite of repeated sales, L. began to be suspected of making use of his special position to abstract books and valuable MSS. from the public libraries. A report had even been secretly prepared on the subject by the public procurator, and communicated to M. Guizot to await his decision. The objects abstracted between 1842 and 1847 were approximately valued at £20,000. This document was dated 4th February 1848, and was found in the Foreign Office when the Revolution broke out in that month. The case was immediately taken up by the courts, and after a long and careful examination, the accused, who, in the meantime, had fled to England, was condemned, June 1850, to ten years' imprisonment, to degradation, and the loss of his employments. This process

created a great sensation, and gave rise to an immense deal of writing for and against the condemned. The most important is an article by P. Merimée, *Le Procès Libri*, in the *Revue des Deux Mondes* (1852), for which the writer was imprisoned, as having, in defence of a 'book-stealer,' slandered and insulted the French judicature.

L. continued for two or three years to address letters and pamphlets to persons in France exclaiming against his condemnation in the highest tones of injured innocence. The efforts of M. Merimée in behalf of L., and a petition in his favour, addressed to the senate in 1861, only had the effect of bringing out still more damatory facts regarding both him and his family. He died 28th September 1869.

**LIFE MORTARS AND ROCKETS.** When a lifeboat is not at hand, or a raging sea and a shoal coast render its use impracticable, a distressed ship may often receive help from shore, provided the distance be not too great for the throwing of a rope. A small rope may draw a thicker, and that a hawser, and the hawser may sustain a slinging apparatus for bringing the crew on shore. For short distances, Captain Ward's *heaving-stick* (fig. 1)

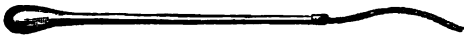

Fig. 1.—Captain Ward's Heaving-stick.

has been found useful: it is a piece of stout cane two feet long, loaded at one end with 2 lbs. of lead, and at the other attached to a thin line. It is whirled round vertically two or three times, and then let go; but it cannot be relied on for more than fifty yards. Kites of various kinds have been employed, but are not found to be certain enough in action. The firing by gunpowder of some kind of missile, with a line or rope attached to it, is the method which has been attended with most success. In 1791, Sergeant Bell, of the Royal Artillery, devised a mode of firing a shot and line from a distressed ship to the shore. It was afterwards found to be more practically useful to fire from the shore to the ship. In 1807, Captain Manby invented his *life-mortar* (see MANSBY in SUPP., Vol. X.). His mortar was an ordinary 5½-inch 24-pounder cohorn, fixed at a certain angle in a thick block of wood. The missile discharged from it was a shot with curved barbs (fig. 2), something like the flukes of an



Fig. 2.—Captain Manby's Life-shot.

anchor, to catch hold of the rigging or bulwarks of a ship. How to fasten the shot to the rope was at first a difficulty: chains were not found to answer; but at length strips of raw hide were found suitable. To assist in descrying the exact position of a distressed ship on a dark night, in order to aim the mortar-rope correctly, Manby used a chemical composition as a firework, which would shine out in brilliant stars when it had risen to a certain height. A third contrivance of his, for replacing the shot by a shell filled with combustibles, in order to produce a light which would render the rope visible to the crew, was not so successful.

Many variations have been made in the line-throwing apparatus. Colonel Boxer has recently substituted a *bolt* (fig. 3), for the shot, with four holes at the end; fuses thrust into these holes shed a

light which marks the passage of the bolt through the air. Trengrove's rocket-apparatus, invented in



Fig. 3.—Colonel Boxer's Life-bolt.

1821, consisted of an ordinary 8-oz. sky-rocket (see ROCKET). Certain practical difficulties, however, affected it, and it did not come much into use. In 1832, Dennett's apparatus was invented. It nearly resembled the old sky-rocket, but with an iron case instead of a paper one, and a pole eight feet long instead of a mere stick: it weighed 23 lbs., was propelled by 9 lbs. of composition, and had a range of 250 yards. A ship's crew having been saved by the aid of this rocket at Bembridge in the Isle of Wight, the Board of Customs caused many of the coastguard stations to be supplied with the apparatus in 1834. Carte's apparatus, brought forward in 1842, depended on the use of a Congreve rocket (see ROCKET) instead of an ordinary sky-rocket. It does not appear that this apparatus was ever adopted by the authorities. Mr Dennett next sought to improve the power of his apparatus, by placing two rockets side by side, attached to the same stick; and it certainly did increase the range to 400 yards; but as the simultaneous and equal action of the rockets could not be always insured, the scheme was abandoned. Colonel Delvigne, of the French army, invented a *life-arrow* (fig. 4), to be fired



Fig. 4.—Colonel Delvigne's Life-arrow.

from an ordinary musket. It is a stick of mahogany, shaped something like a billiard cue; the thicker end presses on the powder; while the thinner end, loaded with lead, is fitted with loops of string; a line or thin rope is attached to the loops, and the thin end of the stick projects beyond the barrel. The jerk, when the arrow or stick is fired, causes the loops to run down the stick to the thick end: this action has an effect like that of a spring, preventing the stick from darting forward so suddenly as to snap the line. The apparatus will send an arrow of 18 oz. to a distance of 80 yards, with a mackerel line attached. Another French contrivance, Tremblay's rocket with a barbed head, was soon adopted for the Emperor's yacht; but as it is to be fired from the ship to the shore, it partakes of the same defects as Sergeant Bell's original invention.

The most effective apparatus yet invented is Colonel Boxer's. Finding that Dennett's parallel rockets on one stick do not work well, he succeeded after many trials in a mode of placing two rockets in one tube, one behind the other (fig. 5). The head is



Fig. 5.—Colonel Boxer's Double Rocket (section).

of hard wood; there is a wrought-iron case, with a partition between the two rockets. When fired, the foremost rocket carries the case and the attached line to its maximum distance, and the rearmost rocket then gives these a further impetus. The

effect is found to be greater than if the two rockets were placed side by side, and also greater than if the quantity of composition for the two rockets were made up into one of larger size. The rocket is fired from a triangular stand, and is lighted by fuse, port-fire, or percussion-tube; the elevation is determined by a quadrant or some similar instrument.

The lines used with these several projectiles have varied greatly; but the best is found to be Italian hemp, spun loosely. It is very elastic, and when thick enough for the purpose, 500 yards weigh 46 lbs. In Boxer's rocket, the line passes through the tail of the stick, then through the head, where it is tied in a knot, with india-rubber washers or buffers to lessen the jerk. The line is carefully wound on a reel, or coiled in a tub, or faked in a box provided with pins ranged round the interior—to enable the line to run out quickly without kinking or entangling. Dennett's faking-box for this purpose is the one now generally adopted.

Life belts, jackets, and buoys of numerous kinds are used, made of cork, inflated india-rubber, &c.; but one apparatus now employed in conjunction with the life-rockets is known by the curious name of *petticoat-breeches*, or more simply, *sling life-buoy*.

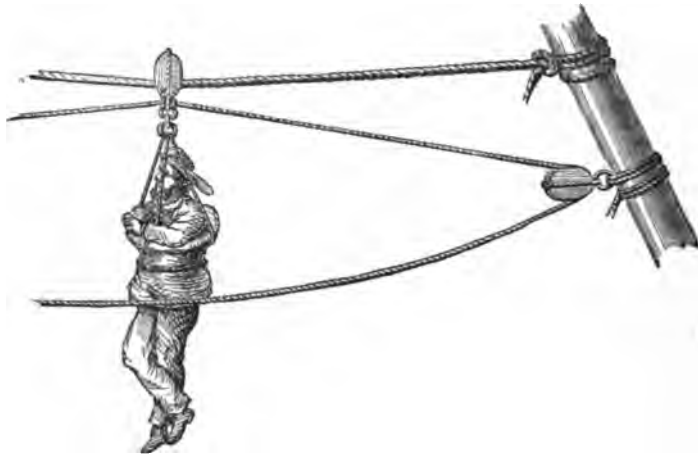

Fig. 6.—Lieutenant Kisbee's Sling Life-buoy, or Petticoat-breeches.

It is not strictly either a belt or a buoy, but a garment in which a man may be slung clear out of the water. When a rocket has been fired, and a line has reached the distressed ship, signals are exchanged between the ship and the shore; a thicker rope is pulled over to the ship by means of the line, and a hawser by means of the rope. When all is stretched taut, by fastening to the masts, &c., articles can be slung and drawn to and fro. The petticoat-breeches, invented by Lieutenant Kisbee, consists of a circular cork life-buoy forming the top ring of a pair of canvas breeches; one of these is hauled over from the shore to the ship; a man gets into it, his legs protruding below the breeches, and his arm-pits resting on the buoy; and he is hauled ashore by block-tackle. The crew of a wrecked ship can thus one by one be relieved. To prevent losing the hawser and other apparatus, when the last man has left the ship, an apparatus called a hawser-cutter is used, working in the ship, but worked from the shore. Other apparatus will be found noticed in LIFE PRESERVERS.

After the destruction of the *Northfleet* in 1873,

off Dungeness, an exhibition was organised at the London Tavern, to which the inventors of new life-saving appliances were invited to contribute. Among the apparatus were Hurst's *life-raft*, consisting of a double pontoon, bridged over, stowed outside a ship, and lowered by simply cutting the lashings; Christie's *life-raft*, a large rectangular framework, rendered buoyant by numerous air-tight spaces, some of which are available for stowing water and provisions; and Parratt's *tubular life-raft*, composed of cylindrical air-bags made of painted canvas, supporting a flooring of sail-cloth and netting, and rendered rigid by poles fixed in various directions. Many other novelties were displayed at the London Tavern, and also at a similar collection in the annual International Exhibition, in the forms of life-boats, rafts, garments, belts, buoys, &c.; but nothing new and important in connection with life mortars and rockets (the more immediate subject of this article).

LIFE-ROCKET DEPARTMENT, or rather, that branch of the Marine Department of the Board of Trade which has the management of life-rockets, mortars, lines, buoys, and belts, divides with the National Life-boat Institution the labours connected with the prevention of shipwreck, and the rescue of shipwrecked persons. This has been the arrangement since 1855. Until that year, the life-mortars in use were partly under the control of the Admiralty, partly under the Board of Customs, partly under the institution just named, and partly belonging to private individuals.

The Merchant Shipping Act, passed in 1854, and put in force in the following year, placed the whole under a different organisation.

To work out properly the rocket and life-saving system, a topographical organisation is in the first instance adopted. The coasts of the United Kingdom are classified into 69 coastguard divisions or wreck-registrars' districts; and the coastguard inspector of each division

or district has control over all the rockets, mortars, buoys, belts, and lines kept at the various seaside stations in his district. There were in 1874 about 300 such stations; some supplied with mortars, some with rockets as well as mortars, but the greater number with rockets only. Most of the mortars are Boxer's improvement on Manby's; and most of the rockets are Boxer's improvement on Dennett's. Boxer's rockets, found more effective than mortars, are made at the Royal Laboratory at Woolwich, and are supplied by the War Department to the stations, on requisition from the Board of Trade; as are likewise mortar-shot and shells, fuses, portfires, signal-lights, gunpowder, &c. At each station is kept a cart, expressly made to contain all the requisites for the rocket-apparatus, ready packed. Eighteen rockets are supplied with each apparatus; and a new supply is obtained before these are exhausted. The main store of apparatus is kept at Woolwich, whence it is sent to 12 depots on the coast, and from these depots to the stations, by the coastguard cruisers. Simpler apparatus, consisting of life-belts and life-lines, is

kept at a much greater number of stations. The system is worked by the coast-guard, the men being paid so much for periodical drilling, and so much for regular service. Special services are rewarded with gifts of money, medals, &c.

**LIGHTING OF BEACONS AND BUOYS AT SEA.** Some interesting experiments have recently been made under the direction of Messrs Stevenson of Edinburgh, the engineers to the Commissioners of Northern Light-houses, 'in order to test the practicability of illuminating beacons and buoys by electricity,' the success of which warrants a practical trial, and it is understood this is about to be proceeded with. At various times since the discovery of the electric light by Sir H. Davy in 1813, suggestions have been made pointing out the advantages which might be derived from its use upon light-houses. It has long been plain, indeed, that for a purpose of this kind it had properties which placed it far in advance of all other lights—such as its near approach to sunlight in brightness, its great power of penetrating fogs, and its total independence of atmospheric air, which enables it to be produced in a vacuum or under water. Unfortunately, its production is attended with great trouble; it also requires rare skill to keep it in perfect order, and even where this is at hand, we cannot yet place absolute reliance upon its steadiness. It has nevertheless been in use at Dungeness, in the south of England, since 1862, and at La Heve in France since 1863, and at both places the light has been practically successful. The reader will find an interesting parliamentary paper on this subject, dated May 30, 1866. Since then the electric light has been introduced at Soutar's Point, Tyne-mouth, and at South Foreland. Whether or not the electric light is to be ultimately adopted for properly constructed light-houses, there can be little doubt that for the illumination of beacons, where no light-keeper is to be constantly on the spot, electricity must in some way be employed as the agent to produce the light. As far as can be at present seen, the ordinary Electric Light (q. v.) may be dismissed as unsuitable for beacons. It will at least require to be greatly simplified before it can be used for such a purpose. In the article INDUCTION OF ELECTRIC CURRENTS will be found a description of the method of producing sparks by means of an induction coil. These sparks can be made to follow each other so quickly as to appear like a flash surrounded by a luminous haze. This, then, is the kind of light with which, when placed inside some convenient form of optical apparatus (see LIGHT-HOUSE), it is now intended to illuminate beacons.

It is probable that several different arrangements of electrical apparatus—all, however, producing the same kind of light—will be tried; but it will suffice to give an idea of their general plan if we explain one of the methods proposed by Mr Thomas Stevenson, by which, with the aid of instruments constructed by Mr Hart of Edinburgh, this flashing light was successfully produced at Newhaven pier in 1866. In this particular experiment, the electric current passed through a wire 800 feet long. Suppose a beacon to be situated at some distance from the shore, as shown upon the annexed diagram (fig. 1). A galvanic battery, consisting of, say, six Bunsen cells, is placed at B in a house upon the shore. From this, the electrical current is conveyed along a submarine cable to the beacon, and returns by earth-plates at E, E, in the usual manner, to complete the circuit; its course being indicated on the diagram by arrows. The induction coil is placed upon the beacon at C, and properly connected with the conducting wire of the cable, so as to make the current generated by the battery traverse

its primary coil. A wire from each end of its secondary coil is then conveyed to the focus of the optical apparatus, the ends of the two wires being here brought within half-an-inch of each other, and furnished with indestructible points of platinum.



Fig. 1.

The induced or secondary current, in crossing this narrow space, produces the succession of sparks which constitute the light, but as explained under the head INDUCTION OF ELECTRIC CURRENTS, it only does so at the moment the current is interrupted or broken. It is consequently necessary to have some means of completing and breaking the galvanic circuit in rapid alternations, so as to produce the flashes in quick succession. The break for this purpose is placed at I, near the battery.

In the experiments already tried, a great deal was found to depend upon the peculiar way the current was broken. None of the breaks in use giving a successful result, Mr Hart devised a new one of an ingenious construction, which produced a more constant and powerful light. Fig. 2 shews

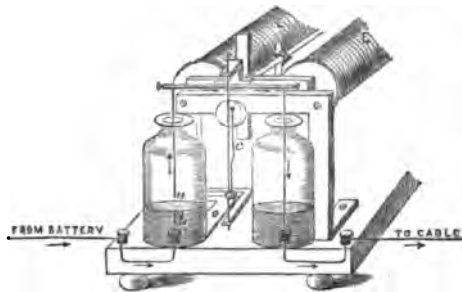

Fig. 2.

this instrument. The difference between it and other mercury or spring breaks lies in the fact, that with them the current is off and on for nearly equal spaces of time; but this one is so contrived that the wire at *a* is three times longer in the mercury, *b*, than it is out of it; consequently, the current is three times longer on than it is off, and so allows the soft iron core of the induction coil to be more fully magnetised. The result of this is a secondary current of comparatively high intensity, and of course the production of more brilliant sparks between its two terminals. We may explain, that the moment the wire at *a* touches the mercury, the current passes, and the moment it is removed the current stops—the direction it takes being indicated in the figure by the arrows. The wire at *a* alternately dips and rises by the action of an ordinary electro-magnet, EE, turning the crank *c*; the second bottle of mercury is not used to break contact, but only to continue the current, for which a spring would answer as well.

By the use of more than one induction coil, the light can be materially increased, so that there is

now a certainty of being able to produce it powerful enough to be seen at the distance of a few miles—a result which, when actually in operation, cannot fail to be of incalculable advantage to the mariner. Strong hopes are entertained that some means will be found of succeeding with the induction coil upon the shore instead of on the beacon, in which case there will probably be little difficulty in illuminating buoys as well as beacons. The use of vacuum tubes, as suggested by Mr T. Stevenson, may facilitate this most desirable application of the electric spark. This gentleman has also suggested the employment of electricity to ring bells, so as to give warning to sailors in foggy weather.

**LIGHTNING, ACCIDENTS FROM.** According to the Registrar-General's Report of Births, Deaths, and Marriages for the year 1871, it appears that during that year 28 persons were killed in England by lightning: none in London, 5 in the South-eastern Division, 6 in the South Midland, 1 in the Eastern, 1 in the South-western, 2 in the West Midland, 6 in the North Midland, 4 in the North-western, 2 in Yorkshire, and 1 in the Northern Division. All except 5 were men, and chiefly labourers in the open air. In 1875 there died in all 17 persons from the effects of lightning. Of 24 deaths from this cause in a previous report, 11 took place in summer, 10 in spring, 2 in autumn, and 10 in winter. Out of 103 deaths in five years (1852—1856), there were 38 in July, and 22 in August.

A person struck by lightning is more or less stunned and deprived of consciousness for a time, often, no doubt, by mere fright, in which case the effect is transient; but sometimes in consequence of a shock given to the brain, in which latter case there is a certain amount of paralysis of motion and sensation. In a case recorded by Boudin in his *Géographie Médicale*, 1857, a gentleman, who had been struck by lightning, remained for an hour and a quarter apparently devoid of any indication of life; and the paralysis, which usually affects the lower limbs, may last for many months. Mr Holmes, in his article on Accidents from Lightning, in his *System of Surgery*, gives the following list of other affections caused by lightning: 'Burns, more or less extensive; eruptions of erythema or of urticaria, which are said by one author to have re-appeared with each succeeding thunder-storm; loss of hair over parts or the whole of the body; wounds; hæmorrhage from the mouth, nose, or ears; loss of sight, smell, speech, hearing, and taste; or, in rare cases, exaltation of these special senses; cataract; imbecility; abortion.' Another curious effect of lightning is that described under the head of **LIGHTNING-PRINTS**. In reference to the occasional loss of hair, M. Boudin (*op. cit.*) relates that the captain of a French frigate, who was struck by lightning on board his ship, could not shave himself on the following day, the razor not cutting but tearing out his hair. From that day, the beard disappeared, and the hair of the scalp, eyebrows, &c. gradually fell off, leaving him entirely bald. The nails of the fingers also scaled away. Sir B. Brodie tells a curious story of two bullocks, pied white and red, which were struck in different storms: in both cases the white hairs were consumed, while the red ones escaped. As a general rule, it seems that persons not killed on the spot usually recover. The burns present every degree of intensity; in some (probably exaggerated) cases, we hear of men and animals being reduced to ashes, while in ordinary cases they vary from deep burns, difficult in healing, to mere vesications: they must be treated in the ordinary method. It was believed until recently that the burns are caused by the ignition of the clothes; it appears, however, from

various cases collected by Dr Taylor (*Med. Jurisp.*, 1865, p. 737), that burns, at all events in some cases, are the direct result of the electricity. One case is so singular that we shall give a few details regarding it. Mr Fisher of Dudley was called in to see a man who sixteen hours previously had been struck by lightning while milking a cow. The cow was killed on the spot, and the man was much injured, there being a severe burn extending from his right hip to his shoulder, and covering a large portion of the front and side of the body. His mind was wandering; there were symptoms of inflammatory fever, and he was confined to bed for 17 days, at the end of which time the healing process was not complete. On examining his dress, it was found that the right sleeve of his shirt was burned to shreds, but there was no material burning of any other part of his dress. Hence it is obvious that the dress may be burned without the surface of the body being simultaneously injured; and further, that a serious burn may be produced on the body although the clothes covering the part may have escaped combustion.

The appearances after death vary extremely. The body sometimes retains the position which it occupied when struck; while in other cases it may be dashed to a considerable distance. The clothes are often burned or torn, and have a peculiar singed smell; and metallic substances about the person present signs of fusion, while such as are composed of steel become magnetic. There are generally marks of contusion or laceration; or if they are absent, extreme Ecchymosis (q. v.) at the spot where the current entered or emerged. In addition to wounds and burns, fractures have also been noticed.

The treatment must be directed to the special symptoms, which are liable to great variations. Sir B. Brodie's advice is as follows: 'Expose the body to a moderate warmth, so as to prevent the loss of animal heat, to which it is always liable when the functions of the brain are suspended or impaired, and inflate the lungs, so as to imitate natural respiration as nearly as possible.' These means should be fully tried, as respiratory action has been restored after more than an hour's suspension. Mr Holmes additionally recommends cold affusion, stimulating enemata, and stimulants by the mouth; and recovery (he states) is apparently hastened by the administration of tonics, especially quinine, and gentle action on the skin by means of baths.

**LIMOUX** (anc. *Limosum*), a town of France, in the dep. of Aude, in the centre of a fertile valley, on the left bank of the Aude, 52 miles south-east from Toulouse. There are manufactures of fine broadcloths, yarn factories, tanneries, dye-works, &c. The neighbourhood produces a much-esteemed white sparkling wine, known as *Blanquette de Limoux*, which rivals Champagne in excellence. Diligences ply regularly to Toulouse, Carcassonne, and Foix. Pop. (1872) 4263.

**LINARÉS**, a town of Spain, in the province of Jaen, 24 miles north-north-east from Jaen. The neighbourhood was celebrated in ancient times for its mines of copper and lead, which are still very productive. A fine fountain which adorns the town is supposed to be Roman. Pop. 15,000 to 18,000.

**LINCOLN COLLEGE, OXFORD**, was founded in 1427 by Richard Fleming, Bishop of Lincoln, for a Rector and 7 Fellows, and afterwards greatly augmented by Thomas Rotherham, Bishop of Lincoln, Archbishop of York, and Lord High Chancellor of England, who added 5 fellowships, and gave a new body of statutes in 1479, in which the election of Fellows was limited to the dioceses of Lincoln.

York and Wells. These limitations were abolished, however, by an act of parliament, 17 and 18 Vict. The foundation at present consists of a Rector, 10 Fellows, and 14 Scholars. Other scholarships are added from time to time from the proceeds of two suspended fellowships; 12 were founded by Dr Hutchins, Lord Crewe, Bishop of Durham, and Dr Radford, rectors. The patronage consists of 9 benefices, in the counties of Oxford, Lincoln, Essex, Dorset, and Bucks, of the annual value of £5414. In 1872, this college had 143 members of convocation, and 255 members on the books.

**LINDSAY, THE FAMILY OF.** This Scottish historical House is of Norman extraction. One of the race obtained lands in England from the Conqueror; another, Sir Walter de Lindsay, settling in Scotland under David I., acquired Erildoun, and Luffness in East Lothian. The descendant of the latter, William Lindsay of Erildoun, High Justiciary of Lothian in the latter half of the 12th c., acquired the lands of Crawford in Clydesdale, which the family continued to hold till about the close of the 15th century. He married Princess Marjory, sister of King William the Lion, and had three sons. The eldest inherited Crawford; and the descendants of the second were the House of Lamberton, who for a time eclipsed their elder brethren; but the line of both ended in heiresses; and Crawford eventually came to the descendants of William of Luffness, third son of the Justiciary, who, in the 14th c., added largely to their estates by marriage with a coheirress of Lord Abernethy. Sir James Lindsay of Crawford was one of the most notable of the Scotch barons engaged in the battle of Otterburn.

**EARLS OF CRAWFORD AND DUKE OF MONTROSE.**—Sir Alexander Lindsay, younger brother of Sir James of Crawford, the hero of Otterburn, acquired large estates in the counties of Angus and Inverness by marriage with the heiress of Stirling of Gleneak and Edzell; and his son David, who, on failure of the line of his uncle, became chief of the family, married the sister of Robert III., and was raised by that king, in 1398, to the dignity of Earl of Crawford. In the 15th c., the earls of Crawford were among the most powerful of the Scotch nobility: they assumed a regal state, had their heralds, and were attended by pages of noble birth. Their domains were widely extended over Scotland, but their chief seat was Finhaven, in Angus. David, third earl, entered into an alliance, offensive and defensive, with the eighth Earl of Douglas and Macdonald of the Isles, Earl of Ross, and wielded for a time, during James II.'s minority, an authority far exceeding that of royalty. He was slain at Arbroath in a private feud with the Ogilvies. His son, nicknamed 'Beardie,' or the 'Tiger Earl,' renewed the league with Douglas. On James having treacherously stabbed Douglas at an interview at Stirling, he rose in rebellion; and the Earl of Huntly, lieutenant-general of the kingdom, who had aided the Ogilvies at Arbroath, took up arms against him. Earl Beardie was defeated at Brechin, and forfeited; but he was afterwards restored to his lands and dignities, and to royal favour, and entertained James at Finhaven, who flung down a loose stone from the castle battlement in fulfilment of a vow which he had taken to make the highest stone of the castle the lowest. The family attained their climax of power and wealth under David, fifth earl, a faithful friend of James III., and employed by him in his most important foreign embassies, who was made Duke of Montrose in 1488, a title which had never before been bestowed in Scotland but on princes of the blood-royal. On the accession of James IV., an act rescissory was passed of all grants and titles conferred by his predecessor during the

last eight months of his reign; but soon afterwards, a new charter of the dukedom of Montrose was granted on a recital of the duke's good services to the king and his predecessor. David, eighth earl of Crawford, nephew of the Duke of Montrose, had the misfortune to have a son known for his crimes and enormities as 'The Wicked Master;' his conduct led his aged father to consent to a transfer of the earldom to David Lindsay of Edzell, the next heir. The ninth earl, who succeeded under this conveyance, moved with pity for the rightful heir, son of the 'Wicked Master,' obtained a re-conveyance of the earldom to him after his own decease. From that time, the fortunes of the family began to decline. The 12th earl was imprisoned by his relatives as a spendthrift. The 16th earl, a companion in arms of the great Montrose, having no issue, through the influence of a powerful cadet of the family, Lord Lindsay of the Byres, a new patent of the earldom was obtained from Charles I., bringing in his branch of the House before the descendants of the uncle of the 16th earl, who had been created Lord Spynie, or the intermediate cadets of Edzell and Balcarra.

**LORD LINDSAY OF THE BYRES, VISCOUNT GARNOCK.**—Sir William Lindsay, younger brother of the first Earl of Crawford, acquired extensive estates with his wife, a daughter of Sir William Mure of Abercorn. He was hereditary bailie and seneschal of the regality of the archbishopric of St Andrews, an office which remained in his family till the middle of last century. His grandson was made Lord Lindsay of the Byres, county Haddington, in 1445. The Lords Lindsay of the Byres were sturdy champions of popular rights and of the Presbyterian faith; their principal residence was Struthers Castle in Fife. The fourth lord endeavoured in vain to dissuade James IV. from his fatal expedition to England in 1613; in consequence of which, James vowed that, on his return, he would hang him on his own gate, a threat, of course, rendered futile by the fatal result of Flodden. The fifth lord was one of the four noblemen to whom the charge of the infant Queen Mary was committed on the death of her father. The sixth lord, the fiercest and most bigoted of the Lords of the Congregation, was deputed by the rest to obtain Mary's compulsory resignation at Lochleven, an office which he is said to have discharged in a severe and repulsive manner; and the seventh lord bearded James VI. in the presence-chamber regarding the changes he was effecting in ecclesiastical polity. The tenth Lord Lindsay of the Byres was in 1644 created Earl of Lindsay; and in virtue of Charles I.'s above-mentioned patent, he became 17th Earl of Crawford, a dignity enjoyed by his descendants till their extinction. He held the offices of High Treasurer of Scotland, and an Extraordinary Lord of Session; and though a warm partisan of the Covenant, he was a loyal and consistent adherent of the Stuarts. In 1648, he entered with zeal into the proposal to raise an army to effect the king's rescue; and in 1657, while forwarding Charles II.'s plan of marching into England, he was arrested, carried to London, and detained a prisoner in the Tower and Windsor Castle. He was released by the Long Parliament in 1660, on the recall of the secluded members, and was reinstated in his offices and dignities at the Restoration. We find him afterwards making a strong effort to dissuade Charles from introducing Episcopacy in Scotland. The Treasurer's grandson by a younger son was created Viscount Garnock in 1703. The fourth Viscount Garnock succeeded as 21st Earl of Crawford; his son, the 22d earl, was the last of the direct line of the Byres; and at his decease in 1808,

the Crawford earldom returned, in terms of the patent of Charles I., to the line of Balcarres, while the Crawford Lindsay estates went to heirs-female. A claim by an alleged descendant of this branch of the House to both peerage and estates, was long a matter of public interest and notoriety: it eventually collapsed from the discovery that the principal documents founded on were ingeniously contrived forgeries.

Sir David Lindsay of the Mount, Lyon King of Arms, the courtly knight, poet, and philosopher, and friend of the Reformation in its earlier stages, was descended from a natural son of the first Sir William Lindsay of the Byres.

**EARL OF BALCARRES AND CRAWFORD.**—The Lindsays of Balcarres, in Fife, were a branch, and eventually the representatives of the Lindsays of Edzell, who, as already seen, had temporarily possessed the earldom of Crawford on the attainder of the 'Wicked Master.' The first of them was Lord Menmuir, a Lord of Session and Secretary of State to James VI., possessed of accomplishments and cultivation rare in his age. His son David was created Lord Lindsay of Balcarres in 1633, and his grandson, Alexander, Earl of Balcarres, in 1651, in reward of their steady support of the royal cause. The sixth Earl of Balcarres became *de jure* Earl of Crawford on the death of the 22d earl, the last of the Byres line; and that title has been recognised by the House of Lords to belong to his son, James, seventh Earl of Balcarres, and 23d Earl of Crawford, father of the present representative of the family. The Earl of Crawford further preferred without success a claim to the dukedom of Montrose, conferred by James III. Alexander William Crawford, since 1869 Earl of Crawford and Balcarres, is author of *Sketches of the History of Christian Art* (1847); *Scepticism* (1861); *On the Theory of the English Hexameter*; *Abstemiousness in relation to the Church of England* (1870); and (1849) *Lives of the Lindsays*, a family memoir, combining to a rare extent genealogical research with biographical interest, to which reference is made for further particulars regarding the Lindsays.—See also Jervise, *Land of the Lindsays*.

**LINGUAGROSSA**, a town of Sicily, in the province of Catania, on the north-eastern slope of Mount Etna, 1725 feet above the sea, 37 miles south-west from Messina. The name is also frequently spelt Linguaglossa. The population of the town at the census of 1871 was close on 8500.

**LINGULA**, a genus of brachiopodous molluscs, exhibiting the remarkable peculiarity of a long fleshy pedicle supporting a bivalve shell, and passing between the beaks of the valves. They live attached to rocks in the seas of warm climates, particularly of the Indian Archipelago and Polynesia. The genus is interesting, because, although few recent species are known, fossil species are numerous, and are found in the fossiliferous beds of Britain and other countries, the seas of which now produce none of their congeners.

**LINOÏLEUM** is, as its name is intended to denote, a peculiar preparation of linseed oil. In 1849, Nielsén and Rochelder independently discovered that chloride of sulphur will solidify oil, and render it usable in many new ways. In 1859, M. Perra communicated to the Académie des Sciences the details of a mode of effecting this by mixing and melting the ingredients, and pouring the mixture out in a thin layer. By varying the proportions, the resulting substance assumes varying degrees of consistency. Thus, 100 linseed oil + 25 chloride of sulphur, produces a hard and tough substance; 100 oil + 15 chloride, a supple substance like india-rubber; and 100 oil + 5 chloride, a thick pasty

mass. This third kind dissolves well in oil of turpentine. Mr Walton afterwards found that, by the application of heat, linseed oil will become hard without the addition of chloride of sulphur. He conceives that it is not a mere drying, but a real oxidising. Linseed oil, first boiled, is applied as a layer to a surface of wood or glass, then dried; then another layer; and so on till the required thickness is produced. The sheet is then removed, and is found to be very much like india-rubber in elasticity; in fact, the production of a layer by this means is analogous to the smearing of clay-moulds with caoutchouc juice to produce india-rubber, as practised in South America. See CAOUTCHOUC. The drying is a little expedited by adding a small portion of oxide of lead. The solid oil is crushed, and worked thoroughly between heated rollers; and, when treated either with shellac or with naphtha, it becomes applicable in various manufacturing forms. The term *Linoleum* properly applies to the hardened or oxidised oil itself, but it is chiefly used as a designation for one of the substances made from or with it, a kind of floor-cloth. When the oxidised oil is rolled into sheets, it becomes a substitute for india-rubber or gutta-percha. When dissolved as a varnish or mastic, and applied to cloth, it is useful for water-proof textiles, felt carpets, carriage-aprons, wagon and cart sheets, nursing-aprons, water-beds, tank-linings, table-covers, &c., according to the mode of treatment. When used as a paint, it is useful for iron, for wood, and for ships' bottoms. When used as a cement, it possesses some of the useful properties of marine glue. When vulcanised or rendered quite hard by heat, it may be filed, planed, turned, carved, and polished like wood, and used for knife and fork handles, mouldings, &c. When brought by certain treatment to the consistency of dough or putty, it may be pressed into embossed moulds for ornamental articles. When used as a grinding-wheel, touched with emery, it becomes a good cutter. Lastly, when mixed with ground cork, pressed on canvas by rollers, the canvas coated at the back with a layer of the same oil in the state of paint, and the upper or principal surface painted and printed, it becomes the *linoleum* floor-cloth, for the production of which a factory has been established at Staines. Dunn's patented fabric for similar purposes has no oil in it: it is a mixture of cork-shavings, cotton or wool fibres, and caoutchouc, spread upon a cotton or canvas back, and embossed with patterns; it is a kind of KAMPTULICON (q. v.).

**LIPPSTADT**, a town of Prussian Westphalia, on the left bank of the Lippe, 78 miles north-east from Cologne. It is walled and fortified, and has five gates. L. has manufactures of woollens, leather, vinegar, and starch, brandy distilleries, &c. Pop. (1871) 7728.

**LIRIA**, a town of Spain, in the province of Valencia, and 12 miles north-west from Valencia. The plain in which it stands is luxuriant with vines and olives. On the summit of a hill in the vicinity is the *Collegio de San Miguel*, an ancient and venerable monastic pile. Pop. 8500.

**LITTRÉ, MAXIMILIEN PAUL EMILE**, a French journalist and philologist, member of the Academy, was born in Paris, 1st February 1801. He distinguished himself in his studies, and obtained various honours at the grand competition. He began the study of medicine, and pursued it so far with distinction; he did not, however, take the degree of Doctor, nor enter on practice, but gave himself up to researches in philology, mastering the principal ancient and modern languages, and in the history of

medicine. At the same time that L. took an active part in editing various journals and literary collections, he prepared an edition and translation of the Works of Hippocrates (*Œuvres d'Hippocrate*, 1839—1861, 10 vols. 8vo.), a publication which immediately opened for him the doors of the Academy of Inscriptions (February 1839).

L., who held democratic opinions, and had distinguished himself among the combatants of July, became afterwards connected with the *National*, and was one of the principal editors of it till 1861. When M. Auguste Comte's new philosophical and social doctrine appeared under the name of Positive Philosophy, L., attracted by the scientific character of the doctrine, took it up with great ardour, and in 1845, wrote a lucid and clever summary of it (*De la Philosophie Positive*), and afterwards defended it in pamphlets and in journal articles. He looked upon the revolution of 1848 as the advent of his opinions; but soon undeceived, he retired from active politics in October 1848, resigning even his office of municipal councillor of the city of Paris. He had ere this declined the decoration of the Legion of Honour. Returning to a life of study, L. continued his researches in medicine, at the same time working ardently at the history of the French language. Already master of the old forms of the French language, he published in the *Revue des Deux Mondes*—to which he has contributed at different times several papers equally ingenious and learned—an article called, The Homeric Poetry and the Ancient French Poetry (*La Poésie Homérique et l'ancienne Poésie Française*, 1st July 1847), which attracted great attention. In it he attempted the translation of the first book of the *Iliad* in the style of the Trouvères. The Academy of Inscriptions chose him, in place of Fauriel (1844), to be one of the commission charged with continuing *L'Histoire Littéraire de France* (The Literary History of France), and he is one of the authors of vols. xxi., xxii., xxiii. In 1854, he was appointed editor of the *Journal des Savants*, and he has since contributed many articles to that collection. L.'s principal work is his *Dictionnaire de la Langue Française*, containing, in addition to the usual information in French dictionaries, examples of the several meanings of the words, with exact reference to the classical works from which they are taken, besides the history of the usage of each word in documents anterior to the 17th century. Not only are all questions of grammar and lexicography (including etymology—a subject in which French dictionaries have hitherto been singularly deficient) fully discussed, but historical allusions are explained, and numerous details given regarding the arts and sciences, rendering the work a kind of cyclopædia. In preparation for many years, it began to appear in 1863, and was completed in 1873. This splendid work, which is the real *thesaurus* of the French language, so long a desideratum, did not prevent the French Academy in 1863 from rejecting the author, whom M. Dupanloup denounced publicly as holding immoral and impious doctrines. L. has also published an excellent French translation of Strauss's *Life of Jesus* (1839—1840, 2d ed. 1855); and a translation of Pliny's *Natural History*. In 1832 he published a paper on cholera. As editor or collaborator, L. was connected with the *Dictionnaire de Médecine*, the *Gazette Médicale de Paris*, and the surgical journal called *L'Expérience*. We may also notice from his pen—*Histoire de la Langue Française* (1862, 2 vols. 8vo.), *Paroles de Philosophie Positive* (1859), *Auguste Comte et la Philosophie Positive* (1863), and *Auguste Comte et Stuart Mill* (1866). He published in 1857

the *Œuvres Complètes d'Armand Carrel*. In 1870, he contributed to the *Revue Positiviste* an article *Des Origines organiques de la Morale*, which attracted great notice, and furnished with new argument the Catholic theologians, who accused him of atheism. Three months before, L. had opposed the publication of M. Comte's later works as being unworthy of him. Just before the siege of Paris, L.'s friends compelled him to quit the capital. In January 1871, M. Gambetta appointed L. professor of history and geography at the *École Polytechnique*. Next month he was chosen representative of the Seine department in the National Assembly, where he sat with the party of the left. At its sitting of the 30th December 1871, the French Academy at last admitted him to membership, choosing him to fill the place of M. Villeman. On this occasion, M. Dupanloup, bishop of Orleans, failing by his utmost efforts to prevent L.'s election, thought fit solemnly to resign his connection with the Academy. *Médecine et Médecine* was published by L. in 1872.

LIVINGSTON, EDWARD, an American jurist and statesman, was born on 26th May 1764 at Livingston (afterwards Claremont), in the state of New York. He belonged to a family which, for nearly a century, had been of the greatest weight and distinction in the colony. L. was the son of Robert Livingston, judge of the Supreme Court of New York, and the youngest of a very numerous family. After leaving the college of Princeton, he studied law under his brother Robert, eighteen years his senior (see below), and devoted special attention to Roman jurisprudence. On being called to the bar, he soon obtained an extensive practice. He had spent his youth among the founders of American independence, all of whom he had known as visitors of his father, and he at once attained a prominent position. He was elected a member of Congress in 1794; federal attorney and mayor of New York in 1801; and he would probably have been known only as a prosperous lawyer, had not a great misfortune at this period befallen him. L., as federal attorney, was intrusted with the collection of debts to the state recovered by legal proceedings. He had the greatest aversion to accounts, and intrusted this part of his duty to a clerk, a Frenchman, who appropriated the funds to his own purposes. When L. discovered what had happened, he at once ascertained the balance due to the state, handed over his whole property to his creditors, threw up his appointment, and resolved to quit New York. No entreaty on the part of his fellow-citizens could induce him to remain. Louisiana had just been annexed to the United States, thanks to negotiations conducted by his brother at Paris, and he resolved to settle in the new state. He joined the New Orleans bar in 1804, and at once obtained lucrative practice. He had great difficulties to encounter. The business had to be conducted partly in French and Spanish. The law administered was a strange compound of municipal regulations, Spanish and French law, and the Roman law of the civilians. A proposal was made to introduce the common law of England, and this would have been much to the pecuniary advantage of L., but he opposed the scheme in an eloquent and convincing speech to the Louisiana Chambers, and it was decided that the law of the state should remain based upon the civil rather than the common law. In the dispute with England in 1814 and 1815, L. became aide-de-camp and secretary to General Jackson, and attracted much notice by the admirable bulletins he wrote during the campaign. In 1820, he was appointed to draw up a code of civil procedure for Louisiana. It was the simplest



known up to that time, was found to work admirably, and received the warmest approval from Bentham and other jurists. L. was then employed in reducing to system the civil laws of Louisiana. He had to aid him in the task the French and other modern codes, the nomenclature of Scotch law, and a familiar acquaintance with all that is most valuable in English jurisprudence, and the work produced, the 'Civil Code of Louisiana,' is undoubtedly the most successful adaptation of the civil law to the conditions of modern society. It was adopted in Louisiana in 1823, and has since become the law of many other states. L. was then employed to prepare a new criminal code, and in a preliminary treatise he laid down the principles on which he was to proceed. He proposed the abolition of the punishment of death, and a penitentiary system, which at once drew general attention to his labours. His book was reprinted in London, translated into French, and made a sensation all over Europe, and the author received the congratulations of the most eminent publicists and politicians of England, France, and Germany. His code of crimes and punishments was completed, but not adopted without modifications. L. was elected in 1829 member for Louisiana of the American Senate, and in 1831 appointed Secretary of State for Foreign Affairs. Two years later, he went to France as Minister Plenipotentiary to support a demand of a million sterling made by the United States government for indemnity on account of French spoliations, and he succeeded in securing payment. He had married a lady of New Orleans, of French family and education, had been long conversant with the French language, in which he had been accustomed to plead before the courts of New Orleans, and he became intimately acquainted with the leading jurists and politicians of France. He was admitted an associate of the Academy of Moral and Political Sciences, and received the warmest tribute of respect as one of the greatest philosophical lawyers of his time, although his distinction at home had been chiefly won as a careful and painstaking man of business. L. died on 23d May 1836, at his own estate on the Hudson, in consequence of drinking cold water when very hot.—See notices of his life in French by M. Taillandier and by M. Mignet, and a long biography by Mr H. Hunt, with introduction by S. Bancroft.

LIVINGSTON, ROBERT R., brother of the preceding, an eminent lawyer and politician, was born in New York in 1746. He was one of the five members of the committee charged with drawing up the declaration of independence. When the constitution of the state of New York was settled, he was appointed chief judge, a dignity he retained till 1801. He was then sent to Paris as Minister Plenipotentiary to negotiate the cession of Louisiana to the United States, a duty he discharged with rare ability. He enabled Fulton to construct his first steamer, and introduced in America the use of sulphate of lime as a manure, and the merino sheep, and in many other ways distinguished himself as a national benefactor. He died on 28th March 1813.

The Livingstons whose lives have just been recorded, belong to an American family remarkable for hereditary talent and the large number of its members who have distinguished themselves in the United States as eminent men of letters, magistrates, lawyers, and divines. They descend lineally from the fifth Lord Livingston, who was intrusted with the guardianship of Mary, Queen of Scots, and from the Rev. John Livingston, minister of Ancrum, in Teviotdale, the grandson of the nobleman, one of the most distinguished of the Presbyterian divines. John Livingston was born at Kilsyth on the 21st

June 1603, preached with great success in Ireland, and was one of two commissioners sent by the Scotch king to Breda, in Holland, to treat with Charles II. Refusing to take the oath of allegiance, he was banished, and, in 1663, went to Holland, where, as pastor of the Scotch kirk at Rotterdam, he spent the last years of his life. He was the author of several works, the best known of which is his autobiography, frequently published.—See Chambers's *Biographical Dictionary of Eminent Scotsmen*. His son Robert was born at Ancrum in 1654, went to Holland when young, and while still a lad, emigrated to America, and settled in the Dutch village of Albany, in the region of the upper Hudson. He married Alida Schuyler, the widow of a Dutch clergyman, and bought from the Indians a vast tract of land on the banks of the river, embracing upwards of 160,000 acres. Robert Livingston, proud of his ancient lineage, had this property erected into the lordship and manor of Livingston, and from it have proceeded the numerous and wide-spreading race who have perpetuated his name, and the lives of many of whom will be found in the American and French biographical dictionaries.

LIXURI, a town of the island of Cephalonia, on the west shore of the Gulf of Argostoli, a long narrow arm of the sea, and 4 miles west-north-west from Argostoli. It is a Greek bishop's see. The surrounding country is very productive of wine and currants, which are brought to L. for exportation, so that it has a considerable trade. Pop. 7000.

LLERENA, a town of Spain, in the province of Badajoz, and 63 miles south-east from Badajoz, near the ridge of the Sierra de Constantina. It is well built, and has some good churches and other public buildings; it is surrounded by walls, which are flanked with towers, and have numerous gates. The inhabitants are mostly employed in agriculture; but there are some manufactures of linen and woollen fabrics, leather, &c. Pop. 6000. Near L. Lord Combermere with his cavalry routed, on April 11, 1812, a French force of 2500 cavalry and 10,000 infantry, the rear-guard of Soult, under Drouot, retiring after the capture of Badajoz.

LLOYD'S BONDS, the name given to a species of securities introduced by Mr John Horatio Lloyd, the eminent barrister, and much employed by railway and other companies, whose power of borrowing money on mortgage or bond is derived from and limited by acts of parliament. A Lloyd's Bond is an admission under seal of a debt being due by the company issuing the bond to the person in whose favour it is executed, with a covenant to pay the sum due at a time fixed, and to pay interest at a certain rate from the time of issue until payment. The covenant is made by the company, their successors and assigns, with the obligee, his executors and administrators; so that a Lloyd's Bond on the face of it is not assignable, and is not, properly speaking, a negotiable instrument. The value of it consists in its converting a simple contract or ordinary debt into a specialty debt, by which the holder gains a preference over ordinary creditors; and in its enabling the holder, armed with this preference, to raise money upon the faith of the debt, either by assigning his interest in it, or by depositing the bond as a security for advances. A valid Lloyd's Bond, as a security, appears to be inferior to a debenture issued under statutory authority in no respect except that its validity can be put in question.

As railway and other companies which have come into existence under parliamentary authority, have no powers except those which parliament has conferred upon them, their power of borrowing is

limited to the amounts, and must be exercised in the manner which parliament has prescribed. By the Act 7 and 8 Vict. c. 85, s. 19, it is declared illegal for them to grant any loan-notes, or other negotiable or assignable instrument, in security of money advanced, except so far as they are authorised by statute. In general, they have statutory authority to borrow only when a certain portion (usually the whole) of their capital has been subscribed, and a certain portion of it has been paid up. And the statute 8 and 9 Vict. c. 16 (The Companies' Clauses Consolidation Act) provides that their power of borrowing must be exercised under the authority of a general meeting. Previous to the introduction of Lloyd's Bonds, these restrictions upon borrowing really limited the liabilities of companies. They were severely felt by companies whose works were being made or being extended; which often were in need of money, which it was impossible or impolitic to raise by means of calls, and whose borrowing powers had not come into operation, or could not conveniently be resorted to. Mr Lloyd relieved such companies from their difficulties, and to a certain extent defeated the intentions of parliament by taking advantage of the fact that companies, if they were prevented from borrowing, were not prohibited from getting into debt in any other way, and granting acknowledgments of their indebtedness in any form except perhaps that of a negotiable instrument. For work done, for goods delivered, for anything except money advanced, the directors of a company might grant admissions of indebtedness; and Mr Lloyd supplied a form in which such admissions would become almost as binding on a company as a statutory debenture, in which they could be sufficiently marketable, in which they could be conveniently granted by directors on account of all the important objects for the sake of which they could desire to borrow to any extent, without the sanction of a general meeting of the shareholders. The only drawback upon the usefulness (for their purpose) of Lloyd's Bonds has been, that they have only been negotiable at high rates of discount; but this has not prevented companies from using them, in many cases to a dangerous extent. There are instances in which lines have been, for the most part, made by means of Lloyd's Bonds; and they have constantly been used simply as a colourable means of eluding the statutory restrictions upon borrowing. On the other hand, they have been of considerable service to companies in the first period of their existence; and that, on the whole, they are thought to have been useful may perhaps be inferred from the legislature, in framing the Railway Securities Act of 1866 (29 and 30 Vict. c. 108), not adopting the recommendation made in 1864 by a committee of the House of Lords, that nothing should be recovered upon these securities out of the proceeds of the traffic of an embarrassed company until the claims of debenture-holders had been satisfied.

It results, from what has been stated, that a Lloyd's Bond cannot be granted for money lent, but can be granted for any other antecedent debt. It cannot be granted for money lent, though the money has actually been used in paying off debts for which bonds might have been granted. The bond should state the origin of the debt on account of which it is granted, but this is not essential. The courts will in no case assume that a Lloyd's Bond has been issued in breach of statutory provisions; but evidence of an intention to defeat such provisions will invalidate a bond. If there have been no actual debt (as may happen, when a company's accounts with a contractor are unsettled), the instrument will not create one; and in that case, the obligee or holder will not be able to recover, even

though the obligee *bond fide* believed that a debt existed; but it is for the company to prove that the debt did not exist. A Lloyd's Bond must be duly sealed with the seal of the company issuing it, by order of the directors, given at a meeting of the directors attended by a quorum. Directors are not personally responsible upon a Lloyd's Bond improperly issued. The leading case upon this subject is that of *Chambers v. The Manchester and Milford-Haven Railway Company* (5 Best and Smith's Rep., 588), decided by the Court of Queen's Bench in June 1864. The form of this instrument (which must be duly stamped) is as follows: 'The A. and B. Railway Company do hereby acknowledge that they stand indebted to C. D. in the sum of £1000 for money due and owing from the said Company to the said C. D., in respect of work and labour done for the said Company by the said C. D. And the said Company for themselves, their successors and assigns, hereby covenant with the said C. D., his executors and administrators, to pay to him, his executors, administrators, and assigns, the said sum of £1000 upon the 1st day of May 1869, and also interest thereon at the rate of 5 per cent. per annum from the date hereof until payment; such interest to be payable half-yearly, on the 1st day of January and the 1st day of July in each year.—Given under the common seal of the said Company, the 1st day of May 1866.—X. Y., Secretary.'

LLUMAYO'R, or LLUCH-MAYOR, a town of the island of Majorca, in an inland situation, among mountains, 15 miles south-east from Palma. It has manufactures of linen and woollen fabrics. Wine and brandy are also produced. Pop. 7000.

LÖ'BAU, a town of Saxony, 40 miles east of Dresden. Near it are mineral springs and bathing establishments. It has tanneries, mills, and bleach-fields. In the ancient *Rathhaus*, the deputies of the six towns of Lusatia met from 1310 to 1814. 'L. diamonds' are crystals found here. Pop. (1871) 5852.

LO'BOS ISLANDS, two small groups of rocky islands on the coast of Peru, famous for the great quantity of guano which they produce. The southern point of the northern group, *Lobos de Tierra*, is in S. lat. 6° 29'; the southern group, *Lobos de Afuera*, is 25 miles further south. The northern group is about 12 miles from the mainland. The principal island of this group is about 5 miles long, and two miles broad. The southern group consists chiefly of two islands, separated by a narrow channel, the largest being about two miles long.

LODZ (Russ. *Lodsi*), a town of Poland, in the government of Piotrkow, and 75 miles south-west from Warsaw. It is situated in a level fertile country, on a small feeder of the Ner, a branch of the Vistula. After Warsaw itself, L. is the largest town in Poland, and is remarkable for the activity with which different branches of industry are prosecuted, particularly the manufacture of cloth and other woollen stuffs. There is also a considerable trade, which is likely to be much promoted by a branch railway, opened in 1865, connecting L. with the great Warsaw and Vienna line. The inhabitants of L. are mostly Germans, or of German origin. Its pop. has of late increased with great rapidity. At the beginning of the 19th c., the town had only a few hundred inhabitants; in 1854, the pop. had increased to 23,302; in 1860, to 31,564; and in 1867 it had risen to 34,328.

LOLL BAZAAR, an inconsiderable town of Northern India, in the district of Cush Behar, between the rivers Durlah and Tista, in N. lat. 26° 4', and E. long. 89° 18'. It partly occupies the site of the ruined city of Komotapur, a 'most stupendous monument of rude labour,' the walls of

which were 19 miles in circumference in the inside of the inner ditch. Massive ruins are still to be seen.

**LONGTON**, a town of Staffordshire, England, in the district of the Potteries. L. was incorporated as a municipal borough in 1865. It is about two miles south-east from Stoke, on a small stream, which falls into the Trent, and is on the line of the North Staffordshire Railway. Part of the town is known as **LANE-END**. The growth of the town has been rapid, and is entirely due to the manufacture of china and earthenware, in which the inhabitants are chiefly employed. Pop. (1861) 16,690; (1871) 19,748.

**LOULÉ**, a town of Portugal, in the province of Algarve, six miles north-by-west from Faro, and 120 miles south-east from Lisbon. It is pleasantly situated on a hill amidst groves of cork trees and pomegranates. The remains of a Moorish castle form a conspicuous feature in the scene. L. is one of the most thriving places in Portugal, and has more than doubled its population within the last forty years. Baskets of aloe-thread are a principal article of manufacture. Pop. about 13,000.

**LOVER, SAMUEL**, artist, novelist, song-writer, and composer, was the son of a stockbroker in Dublin, and was born in that city in 1797. At an early age, he shewed a great desire to become an artist, and with genius and perseverance, succeeded so far that, in 1823, he was elected a member of the Royal Hibernian Society of Arts. In 1833, he exhibited at the Royal Academy a portrait of Paganini, which is said to have brought him some reputation as a portrait-painter. As a miniature-painter, in Dublin, he took likenesses of the principal aristocracy and leaders of Irish society. But while thus engaged, he discovered that he possessed a genius for authorship as well as for art, and was encouraged to make some attempts in that direction by the favourable opinion of Thomas Moore. In 1832, he published a collection of short pieces, entitled *Legends and Stories of Ireland, by Samuel Lover, R.H.A., with six Etchings by the Author* (12mo, Dublin), which was favourably received, and followed by a Second Series, published in London in 1834. In 1837, Mr L. settled in London, and having made authorship his profession, contributed largely to the periodical literature of the day. He also wrote *Rory O'More*, a romance of Irish life, which immediately became popular. Its production on the stage, with the excellent acting of Power in the principal character, made the author still more known. His next publication was *Handy Andy*, commenced, but not completed, in *Bentley's Miscellany*; the entire work, with illustrations by the author, appearing in 1842. In 1844, Mr L. published *Treasure Trove, the first of a series of Accounts of Irish Heirs, &c.; with twenty-six Illustrations on Steel by the Author*. This was originally published in numbers, under the title of *L. S. D., or Accounts of Irish Heirs, &c.* As a writer of songs, Mr L. holds a well-earned reputation: his *Rory O'More*, *Molly Bawn*, *Low-backed Car*, *Molly Carew*, and others, have long been established favourites with the public. In 1839, Mr L. published a collection of his *Songs and Ballads*, with the words only; but considerably more than 100 of his songs have been separately published with music, composed or adapted by the author himself. In 1844, Mr L. projected an entertainment called 'Irish Evenings,' which was very popular both in London and the provinces. Its success encouraged him to visit the United States, where his entertainment was also well received. He returned from America in 1848, when he made his experiences there the

material for a new entertainment, which he gave in London. Mr L. was for some years in the receipt of a pension from the crown, in recognition of his literary merits. Besides the works already mentioned, and his numerous songs, Mr L. was author of *Metrical Tales, and other Poems*, published in 1860. He was also the editor of a well-selected compilation of songs and ballads, by various authors, entitled *The Lyrics of Ireland*, published in 1858. He died 6th July 1868.

**LOW ARCHIPELAGO**, or **PAUMOTA ISLANDS**, a very extensive group of small coral islands, lying to the eastward of the Society Islands, and southward from the Marquesas Islands. This group or archipelago extends from 15°—25° S. lat., and from 134°—148° W. long. The navigation of this part of the ocean is, as may readily be supposed, dangerous. Some of the islands are in minor groups, others are quite solitary. The whole pop. is estimated at about 10,000.

**LOWE, RIGHT HON. ROBERT**, English politician, born 1811, at the rectory of Bingham, Notts, of which parish his father, the Rev. Robert Lowe, was rector. He was educated at Winchester, and University College, Oxford, where he was first-class in classics, and second-class in mathematics, in 1833. He remained at Oxford, was elected Fellow of Magdalen in 1835, devoted himself to tuition, and obtained the reputation of being one of the best private tutors in the university. In 1836, he married, and gave up his fellowship. He was called to the bar, by the Honourable Society of Lincoln's Inn, in 1842, and went to Australia to push his fortune. He soon attained a lucrative practice at the Sydney bar. He also took a leading part in the political struggles of the colony. In 1843, he was nominated one of the Legislative Council. In 1848, he was elected member for Sydney. Some successful land speculations put him in possession of a moderate competency; and he returned to England, in 1850, with the design of entering upon a parliamentary career. Returned in 1852 for Kidderminster as an independent member with Conservative tendencies, he, in 1853, took office under Lord Aberdeen, as Secretary to the Board of Control. He went out with Lord Aberdeen's government, but in August 1855 he accepted from Lord Palmerston the post of Vice-president of the Board of Trade. At the general election in March 1857, he was invited to offer himself for Manchester, but he preferred to remain at Kidderminster. Here, however, he became unpopular with the working-classes. He gained his seat, but not without an election riot, in which he was severely injured. In 1859, he exchanged this turbulent constituency for the borough of Calne, where the influence of the Marquis of Lansdowne procured his return. He sat for Calne till 1868, when, at the general election, he was returned for the London University, which he still (1877) represents. In June 1859, he became virtual Minister for Education in Lord Palmerston's second administration; and he held this office until April 1864, when the House of Commons, on the motion of Lord Salisbury, then Lord R. Cecil, having condemned an alleged practice of the Privy Council Office in tampering with the reports of the Education inspectors, L. unnecessarily, as it was thought, resigned office. The introduction of the Revised Code of 1860, with its principle of 'payment by results,' signalled his administration of the education department. Time has shown that this was a valuable reform, but it brought upon him much obloquy, which his personal characteristics by no means tended to avert or mitigate. His emancipa-

tion from the restraints of office exhibited Mr L. in a new phase. No speaker, during the session of 1865, was so logical, so original, and so daring. In 1866, on the introduction of the Whig Reform Bill, L. delivered the first of a series of powerful speeches, which largely contributed to insure its rejection. He was, with other members of what was called the party of 'Adullamites,' offered a post in the Derby government, but he declined to leave the Liberal party, though describing himself as an outcast from it. When the Derby government, in 1867, attempted to deal with the reform question, L., in a series of speeches, vindicated his consistency as an opponent of all reduction of the suffrage. Circumstances had, however, changed, and the successful opponent of the comparatively moderate Whig measure found himself almost alone in protesting against the establishment of household suffrage. In 1868, L.'s feud with the Liberal party was made up, or rather, was forgotten, in the strenuous aid he gave the Liberal leaders in carrying resolutions in the House of Commons for the disestablishment of the Irish Church. Accordingly, in December of that year, when a general election brought the Liberal party into power, with Mr Gladstone as prime-minister, Mr L. obtained in the Liberal ministry the office of Chancellor of the Exchequer. This post he filled till September 1873, when he exchanged it for that of Home Secretary. He went out of office with the Gladstone government in February 1874, when it became plain that the chances of a general election had given the Conservatives a majority. He was Home Secretary for too short a period to test his fitness for that trying office. As Chancellor of the Exchequer, he was not deemed decidedly successful. The chief reforms effected by him during his tenure of office, were the substitution of licence duties for the assessed taxes, a change in the time of collecting the income-tax, and in the assessment of that tax on small incomes, and a great reduction of the sugar duties. He did himself much harm with his first budget by proposing a tax on matches—a proposal easily put in ludicrous lights and which excited strong opposition. During his occupancy of this office, however, the annual surpluses were large almost beyond example. This was due partly to economical management, but much more to the prosperous state of the country. L. exerted himself earnestly to keep down the public expenditure. It was considered, however, that his regard for the public purse was pushed to the verge of parsimony, and of injustice to individuals; and his curt and ungracious treatment of all claimants of public money, undoubtedly brought much odium upon himself and the government to which he belonged. Some faults of administration came to light in the later days of his administration, which were naturally made the most of, and they probably had to do with his retirement from the Exchequer. In the House of Commons, while Chancellor of the Exchequer, he confined himself for the most part to the business of his department, but he was undoubtedly the second personage on the Treasury Bench. L.'s oratory is deficient in passion; but in acuteness, in felicity of illustration, and in cogency of argument, he is almost unequalled among the public speakers of his day. His elocution is rapid, and his manner nervous and embarrassed; but his great intellectual power always commands the attention and admiration of the House of Commons.

LÜDENSCHIED, a town of Prussian Westphalia, 33 miles north-east from Cologne, in a mountainous district, not far from the right bank of the Volme, a branch of the Rhine. It has cotton-

mills, and manufactures of cutlery, buttons, files, and other articles of hardware. There are calamine mines in the neighbourhood. It has of late increased rapidly in population and prosperity. Pop. (1871) 7546.

LU'GO, a town of Central Italy, in the province of Ravenna, 32 miles south-east from Ferrara. It is supposed to be the site of the ancient *Lucus Diana*. L. is an important provincial town. There is an annual fair which lasts from the 1st to the 19th of September, and is the occasion of a great concourse. L. has a very considerable trade in hemp, flax, rice, wine, brandy, &c. Pop. about 8600.

LU'GOS, a market-town of the Austrian Empire, in the Banat, on the Temeş, a branch of the Danube, 32 miles east-south-east from Temeswar. It consists, strictly speaking, of two contiguous towns, the inhabitants of the one, DEUTSCH-L., being mostly of German race, and those of the other, ROUMANISCH-L., or WALLACHISCH-L., being Roumanian. Pop. of former (1869), 3350; of latter, 8304.

LUNAWAU'RA, a small state of India, under British protection, in the Rewa Caunta division of Guzerat. It is situated on the confines of Guzerat, and is a continuation of the mountain tract which forms the extreme north-east of that province. The capital, from which the state derives its name, is 160 miles north-west from Indore, on the left bank of the Mahi, or Myhee, a river which flows into the Gulf of Cambay, and is in N. lat. 23° 8', E. long. 73° 37'. It is a fortified town, the fortifications and town together being about three miles in circumference; and is a place of considerable trade. Area of state, 150 sq. m.; pop. (1872) about 75,000.

LU'NDY ISLE, an island of Devonshire, England, in the mouth of the Bristol Channel. It is about three miles in length from north to south, and one mile in breadth, having an area of 1800 acres. Its south point is about 12 miles from Hartland Point, on the coast of Devonshire, and its north end about 29 miles from St Gowan's Head, in Wales. Its shores are rocky and precipitous, and approach to them is rendered dangerous by numerous detached or insular rocks. There is only one landing-place, which is on the south side, and near it are dangerous reefs and insulated rocks. The pop. in 1871 was 144. Near the southern end of the island is a light-house, on a height 567 feet above the sea. At an early date, this island is said to have belonged to a family named Morisco, one of whom having conspired against the life of Henry III., fled hither, and became a pirate. L. I. was the scene of a remarkable occurrence in the reign of William and Mary. A party of Frenchmen landed from a ship of war under Dutch colours, on pretence of desiring to bury one of the crew in consecrated ground, the coffin being really filled with arms, with which the party armed themselves in the church, having requested the islanders to leave them alone to their own funeral rites, and issuing forth, they desolated the island, hamstringing the horses and bullocks, flinging the sheep and goats over the cliffs, and stripping the inhabitants even of their clothes. The cliffs of L. I. are the resort of multitudes of gannets, or solan geese. Granite is the rock chiefly prevailing in the island, but slate appears at its south end.

LUTE (Ger. *Laut*, sound), an obsolete stringed musical instrument, which has been superseded by the harp and guitar. It consisted of a table of fir; a body or belly, composed of 9 (sometimes 10) convex ribs of fir or cedar; a neck, or finger-board, of hard wood, on which were 9 (or 10) frets, stops, or divisions, marked with catgut strings; a head, or cross, on which were placed the pegs or screws that tightened or relaxed the strings in tuning; and a

bridge, to which the strings were attached at one end, the other end being fastened to a piece of ivory, between the head and neck. The number of strings, originally 6, of which 5 were doubled, so as to make 11, was gradually increased till they numbered 24. The performer used his left hand to press the stops, and struck the strings with his right. A peculiar description of notation, called *tablature*, was employed in music written for the lute. The strings were represented by parallel lines, on which were placed letters of the alphabet, referring to the frets: thus, A, marked that the string was to be struck open (or without pressing any of the stops); B, that the first stop was to be pressed; C, the second, and so on: while over the letters were placed hooked marks, corresponding to the minim, crotchet, quaver, &c., to indicate time. So carelessly and inaccurately was lute-music generally written, that it is no easy matter to render it into the ordinary notation. The lute was formerly in high favour all over Europe as a chamber-instrument; and it was used in dramatic music to accompany the recitative. In the time of Handel, there was a lute in the Italian Opera in London; and there was a lutanist in the King's Chapel down to the middle of last century.—For a minute account of the lute, and how to play it, see Mace's *Musick's Monument* (Lond. 1676).

**LÜTTRINGHAUSEN**, a prosperous manufacturing town of Rhenish Prussia, 18 miles south-east from Düsseldorf. Woollen, linen, and cotton manufactures are carried on; also manufactures of hardware and cutlery. Pop. (1871) 9100.

**LU'ZULA**, a genus of plants of the natural order *Juncaceæ*, differing from rushes in having a 3-seeded instead of a many-seeded capsule, and in having soft plane leaves, which are generally covered with thinly-scattered longish hairs. They do not grow in wet places, like rushes, but in woods, pastures, and elevated mountainous situations. The English name, **WOOD-RUSH**, has sometimes been given to the whole genus, but is only appropriate to some, of which it is the popular name, as *L. sylvatica* and *L. pilosa*, common British species. Perhaps there is

no more common British plant than the **FIELD-RUSH** (*L. campestris*), a plant of very humble growth; the flowering spikes of which, congregated into a close head, their dark colour relieved by the



Wood-rush (*Luzula sylvatica*): a, a flower.

whitish yellow of the anthers, profusely adorn dry pastures in spring. It is of little agricultural value. The species which grow under the shade of trees are valuable, as preserving their verdure in winter, adding to the beauty of the scene, and improving the cover for game.

## M

**MARSKA**, or **MARKASKA**, a town of the Austrian Empire, in Dalmatia, on a small bay of the Adriatic, near the mouth of the Narenta, and 34 miles south-east from Spalatro. The plague carried off half the inhabitants in 1815 and 1816, and the place has not yet completely recovered its prosperity. It carries on some trade, but the greater number of the inhabitants are employed in agriculture and fishing. Pop. 7386.

**MACCALUBA**, an interesting mud-volcano or air-volcano of Sicily, situated not far from the road between Girgenti and Aragona. It is known to have been in a state of frequent activity for the last 15 centuries. It consists of a large truncated cone of barren argillaceous earth, elevated about 200 feet above the surrounding plain, with wide cracks in all directions, and numerous little hillocks with craters, which at times emit a hollow rumbling noise, and throw up a fine cold mud mixed with water, a little

petroleum and sulphureous gas. Reports like the discharge of artillery are occasionally heard; slight local earthquakes are felt, and mud and stones are thrown up to a height of thirty feet or more.

**MACFARREN**, **GEORGE ALEXANDER**, **Mus.D.** an English musical composer and essayist of high reputation, son of George Macfarren, a dramatic author and musician. He was born in London, March 2, 1813, and his education was conducted at the Royal Academy of Music, at which institution he became a Professor in 1834. As an operatic composer, Mr M. is the most characteristic representative of the national English school—his aim being to revive the old English music in modern opera. His earliest dramatic work, *The Devil's Opera*, was produced in 1838; *Don Quixote* followed in 1846; and *King Charles II.* in 1849, which first brought out Miss Louisa Pyne in English opera. A cantata, *The Sleeper Awakened*, was brought out at the National Concerts in 1850, *Lenore* in 1852, *May-day* in 1856, and *Christmas* in 1860. The opera of *Robin Hood* followed in the same year, which attained a

popularity far beyond its predecessors, and was performed during a whole season to overflowing houses. The *opera di camera* of *Jessy Lea* followed in 1863; *She Stoops to Conquer* and *Helvellyn* in 1864. The oratorio of *John the Baptist* appeared in 1873. Mr M.'s works comprise numerous other small dramatic pieces, as well as chamber music, vocal and instrumental, and several symphonies and overtures. He has also contributed largely to the literature of music. His *Rudiments of Harmony* were published in 1860; *Six Lectures on Harmony*, in 1867. In 1875, he became Principal of the Royal Academy of Music, and Professor of Music at Cambridge University, receiving the degree of Doctor of Music.

MACLEOD, NORMAN, D.D., a divine of the Church of Scotland, eminent for his pulpit oratory, his writings, and his liberal Christianity, was born at Campbeltown, in Argyshire, in 1812. He was educated at the university of Glasgow, and entering the church, became successively minister of London in Ayrshire, Dalkeith, near Edinburgh, and the important Barony Church, Glasgow. He gained the degree of D.D. in 1858, was appointed one of the Queen's Chaplains in Scotland, and in 1869 was Moderator of the General Assembly of the Church. In 1850, he visited Canada, and in 1867, India, on missions connected with the business of the Church of Scotland. From 1850 to 1860 he edited the *Edinburgh Christian Magazine*, and from 1860 onwards was the conductor of *Good Words*, to which he contributed numerous tales, essays, verses, &c., many being republished. Among the most important and popular of his works are *Reminiscences of a Highland Parish*, *The Old Lieutenant and his Son*, *Eastward*, *The Gold Thread*, *The Starling*, *The Earnest Student*, *The Home Education*, *Sermons*, &c. Dr M. died at Glasgow on June 16, 1872. See *Memoir*, by his brother, the Rev. Donald Macleod (1876).

MACLURE, SIR ROBERT JOHN LE MESURIER, the discoverer of the North-west Passage, was born at Wexford in January 1807, and was sent for his education first to Eton, and afterwards to Sandhurst. Intended for the military profession, but having no great love for it, he secretly left Sandhurst, and through the good offices of a friend, was entered as a midshipman on board the *Victory*. He volunteered for the Arctic Expedition in H.M.S. *Terror*, Captain Back, in 1836, returning to England in 1837. In November 1837, he received his commission as a lieutenant; and on the 18th June 1842, was appointed to the command of the *Romney* receiving-ship at the Havana, where he remained until the early part of 1846. In 1848, he joined Sir James Ross's expedition in search of Franklin; and upon its return in 1849, he was promoted to the rank of Commander. This expedition had barely returned to England when it was resolved by the Admiralty to despatch the vessels composing it—viz., the *Enterprise* and the *Investigator*—on a fresh search for the Franklin party by way of Behring's Strait. Accordingly, Captain Richard Collinson, C.B., was appointed as senior officer to the *Enterprise*, and Commander M. to the *Investigator*. On the 20th of January 1850, the vessels set sail, with instructions to make the best of their way to Cape Virgins, in order to arrive at Behring's Strait in July. The *Investigator* could not keep up with the *Enterprise*, which was towed through the Strait of Magellan by a steamer, some time before the *Investigator* got there. After rounding Cape Horn, the *Investigator* met with her consort lying at anchor in Fortescue Bay; but soon again they separated, and met no more during the voyage. Captain M. now proceeded alone, in the *Investigator*, towards the ice-

regions. On the 2d of August, after passing through Behring's Strait, he spied, in lat. 72° N., ice right ahead. On the 8th, his men first met with Esquimaux, close to Point Pitt, where a party was sent ashore to erect a cairn, and place a notice of the *Investigator* having passed. These Esquimaux encouraged them in the belief that, as they proceeded eastward, they would find an open channel. As they proceeded, however, along the coast of America, the ice became troublesome and even threatening. There were also numerous shoals, which made the navigation intricate and dangerous. On the 31st of August, the *Investigator* reached Cape Bathurst, from which she continued to advance for several days in a north-easterly direction. On the 11th September, unmistakable signs of winter presented themselves. On the 17th, the *Investigator* reached her most advanced position, in lat. 73° 10' N., and long. 117° 10' W., about 30 miles from the waters of that series of straits called Melville, Barrow, and Lancaster, communicating with Baffin's Bay. The ice now almost hemmed the vessel in on every side; and Captain M. determined to winter in his present position. The *Investigator* became finally fixed in the ice, in lat. 72° 50' N., and long. 117° 55' W. On the 22d October, Captain M. determined to reach the sea, if possible, by a sledge-journey. He accordingly set out with a party of men and officers; and after sustaining much fatigue and privation, was at last rewarded, on the 26th, by a sight of the North-west Passage. The position of Mount Observation, from which the important discovery had been made, was ascertained to be in lat. (observed) 73° 30' 39" N., long. 114° 39' W., and by lunar 114° 14' W. After this discovery, the party returned to the *Investigator*; but that vessel was not destined herself to sail homewards through the passage discovered by her commander. All that winter and spring, she remained frozen up in the ice. In July, she began to move again, but the nearest she could get to the passage was 73° 43' 43" N. lat., and long. 115° 32' 30", 25 miles from the waters of Barrow Strait. This was on August 15, 1851. On the following day, Commander M. resolved to abandon this course, go round the south end of Banks' Land, and endeavour, by passing to the westward of it, to reach Melville Island by that route. For 300 miles and more, the *Investigator* sailed in this direction, without being once checked by ice. On August 19, however, a sudden change came; the ice pressed against both sides of the vessel, and immense masses threatened to topple over, and sink her with their weight. By September 1, the *Investigator* became completely ice-bound about 50 yards from the shore. On the 10th, however, there was another change; the ice broke from the coast, carrying the *Investigator* with it, and she slowly sailed along for several days, until eventually she settled in a bay, where Commander M. resolved to winter. To this bay he gave the name of Bay of Mercy, in gratitude for the escape of the ship and crew from numerous dangers, as also because the neighbouring land abounded in reindeer, hares, and other animals, which gave them good supply of food. In this bay, they passed their second Christmas, and the time wore on until April 1852, when Commander M. visited Melville Island with a sledge-party, in the hope of finding some of Captain Austin's ships, or at least a dépôt of provisions; but was disappointed. He returned to the vessel, where all were still well; but in May, the scurvy broke out among his crew, and increased during the summer. August came, and still there was no open channel, and in the following month, it became clear that they must pass a third winter in the ice.

## MACROOM—MAESHOWE.

It now became necessary to decide what they should do for the future, as provisions were failing; and accordingly, Commander M. announced to his men that, in the following April, he would send away 30 of the crew to make their way homewards in two parties—one by way of North America up the Mackenzie River; the other by way of Cape Spencer, Beechey Island; while he himself, with the remainder of the officers and crew, would stay by the ship, spend a fourth winter, and then, if not relieved, endeavour to retreat upon Lancaster Sound. The men cheerfully acquiesced; and when April came, the sledges were got ready for the retreating parties. On the 6th of that month, Commander M. and his first-lieutenant were walking near the ship conversing, when they perceived a figure rapidly approaching them from the rough ice at the entrance of the bay. When within a hundred yards of them, he shouted and gesticulated, but without enabling them to guess who it could be. At length, he came up to them, and to their joy and astonishment, announced himself thus: 'I am Lieutenant Pim, late of the *Herald*, and now in the *Resolute*. Captain Kellett is in her at Dealy Island.' Pim had

come from Melville Island, in consequence of one of Captain Kellett's parties having discovered an inscription left by Commander M. on Parry's famous sandstone rock in Winter Harbour. Commander M. now resolved, although reluctantly, to abandon his ship altogether, and return with Captain Kellett to England. He reached England on September 28, 1854. His first reward was to receive his commission of Post-captain, dated back to the day of his discovery of the North-west Passage. Shortly afterwards, he received from her Majesty the honour of knighthood. A reward of £10,000 was also granted to the officers and crew of the *Investigator*, as a token of national approbation of the men who had discovered a North-west Passage from the Pacific to the Atlantic Ocean. In March 1856, Sir Robert M. was appointed to the command of H.M. steam-corvette *Esk*, serving in the East Indies and China, but which returned to England in 1861. He died 17th October 1873.

**MACROOM**, a post and market town of the county of Cork, Ireland, situated on the river Suflane, 21 miles west from Cork, with which it is connected by railway. The pop. in 1871 was 3193. The town consists merely of a single street, nearly a mile long, and contains some good houses and shops, but the great majority of the dwellings are mean and poverty-stricken.

**MAD-APPLE**, a name sometimes given to the Apple of Sodom (*Solanum Sodomense*), sometimes to the fruit of the Egg-plant (q. v.), and sometimes to the large Galls (q. v.) known as *Mecca* or *Bussorah Galls*, and which are also called Apples of Sodom.

**MAESHOWE**, an artificial mound with an interior chamber, of unknown antiquity, situated on the mainland of Orkney, about nine miles in a westerly direction from Kirkwall, and little more than a mile from the famed Standing Stones of

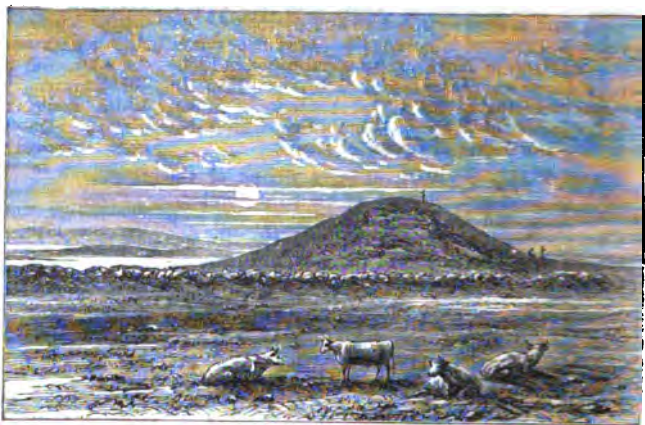

Fig. 1.—Maeshowe: Exterior View.

Stennis. M. is described as follows by a recent visitor (W. Chambers) in *My Holidays*, a privately circulated work (1867): 'It is situated in an open

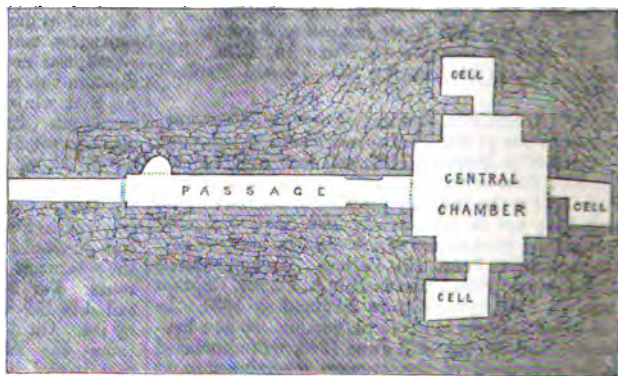

Fig. 2.—Maeshowe: Ground-plan.

heathy spot; outwardly, there is little to be seen—only a circular grassy tumulus, or barrow, as it is called by antiquaries, measuring 36 feet high, and about 92 feet in diameter at the base, at which a low door presents itself. Made aware of



Fig. 3.—Runes, interior of Maeshowe.

our errand, a girl from the neighbouring farmhouse arrives with the key of the door, a couple of candles, and a box of lucifer-matches. We have also bits of candles with us; and with the whole lighted, we enter the aperture, crouching as we advance along

a passage varying from a width of 2 feet 4 inches at the entrance, to 3 feet 4 inches at the opening into the interior chamber. The height, low at first, expands to 4 feet 8 inches. The passage is formed by slabs of stone, above, below, and along the sides. On issuing into the central chamber, our candles at first feebly enable us to comprehend its dimensions. These we are at length discover. We are in a vault built of slabs of stone, measuring 15 feet square, except at the corners where there are buttresses. The height is 13 feet. On each of the sides, except that with the entrance, at a height of 3 feet from the floor, there is a square opening to a cell or recess, the largest of which is 7 feet in length by 4 feet 6 inches in breadth. The roof of the vault had originally been constructed with slabs advancing successively layer above layer to the centre; but as a result of recent repairs, when the structure was cleared out and restored to something like its former condition, the roof is now partly composed of arched masonry, with an aperture for ventilation. As can be easily supposed, this strange subterranean chamber is cold and clammy. The slabs of stone are wet with damp, and nothing induces a protracted stay but the wish to examine certain Runic inscriptions and emblematic or fanciful figures carved on a few of the stones. These carvings were discovered only at the opening and repairing the chamber, an operation undertaken at the instance of Mr James Farrer, M.P., a learned and enthusiastic antiquary. In a privately circulated work on Macshowe, by Mr Farrer, and also in a work by Mr J. M. Mitchell, the carvings have been explained partly through the assistance of Norwegian scholars. All refer to Vikings and other Scandinavian heroes, or to transactions in the middle ages. Fig. 3 represents one of these inscriptions. According to Mr Farrer's interpretation, it signifies: "Molf Kolbainson carved these Runes to Ghaut"—Ghaut being possibly a comrade who fell in battle. Mr Mitchell's translation runs thus: "Thofe Kobainson cut these Runes (on) this cave." Such is a pretty fair specimen of the interpretations of the different inscriptions; scarcely two persons agreeing in the signification. [We have reason to believe that the diversity here referred to arises from the fact that imperfect transcriptions of the Runes had been submitted to the foreign scholars who acted as interpreters. We are sorry to learn that damp is likely soon to deface these interesting inscriptions.] Several purport to refer to hidden treasure, a circumstance which throws a degree of ridicule over the whole, for no one carves inscriptions on stones telling the world where money is secretly deposited. Of the emblematic or fanciful figures, nothing can be made. One is a figure of a horse with an animal like an otter in its mouth, a second is a winged dragon, and a third is a worm knot. These figures may represent the names of ships, or may be whimsicalities signifying nothing.

There is nothing in these Runes to explain the origin or use of the structure. We are left to conjecture that it was erected as a sepulchral vault in extremely remote times; and being opened by Scandinavian rovers, in the hope of discovering hidden treasure, they used it as a resort or hiding-place, and carved the inscriptions which still remain to attest their visits. Obviously, the building and the passage communicating with it were erected on the open plain, and then covered with the earth which forms the tumulus. There is at some distance an environing mound and ditch, still pretty entire. The whole structure bears a resemblance to the vaulted tumuli in other parts of the British Islands. In one at Newgrange, on the banks of the Boyne, near Drogheda, the walls are composed of

tall blocks set on end; whereas, at Macshowe, the slabs are built one above another (without mortar), as in an ordinary wall. This general resemblance points to a common origin. We have yet to learn, however, why this part of Orkney should be so rich in memorials of an extreme antiquity.—For a very minute account of M., we refer to a paper by Mr John Stuart, Secretary of the Society of Scottish Antiquaries, circulated as a pamphlet, 1867.

MAGDA'LA, a town of Abyssinia, about 120 miles south-east of Gondar, on the left bank of the Bachilo, a feeder of the Blue Nile, at an elevation of about 9000 feet above the level of the sea, and within a few miles of the mountains of the Falls country, the peaks of which are covered with snow for nine months of the year. M. was a small town, having a pop. of only 3000 or 4000, but it recently acquired note as the place of residence of the Negus or king of Abyssinia, and as the place of captivity of the British prisoners, for whose rescue an expedition was at last sent out, in 1867, by the British government. Its rock fortress, approachable only by a narrow path up a steep ascent of 300 feet, and through a double line of defence, was regarded by the Abyssinians as impregnable; but it was forced, after a short but brave defence on the part of the few attendants who up to the last remained faithful to Theodore, on the 13th April 1868. The town was found to be of the meanest description, the church and royal palace being in nowise exceptions to the prevailing dirtiness. The wealth of M. was insignificant. Before the departure of the English troops, the town was burned, and its defences thoroughly destroyed.

MAGNESIUM AND THE MAGNESIUM LIGHT. Although the discovery of the metal magnesium was made by Sir H. Davy in 1808, it was looked upon as little more than a chemical curiosity for about half a century. In 1830, a French chemist, Bussy, obtained globules of the metal by fusing globules of potassium, in a glass tube, with anhydrous chloride of magnesium. Bussy's labours were followed by somewhat improved methods, adopted by Bunsen, and subsequently by Matthiessen, who succeeded in pressing some grains of the metal into wire. The first great advance on Bussy's labours was in 1856, when Deville and Caron effected the reduction of the pure chloride of magnesium by mixing it with fused chloride of sodium in clay crucibles, using fluoride of calcium as a flux, and throwing in fragments of sodium; they thus obtained magnesium on a larger scale than any of their predecessors. The most important part of their investigations was the discovery of the volatility of the metal. All these were, however, mere laboratory experiments. In 1859, Bunsen of Heidelberg, and Roscoe (now of Manchester), published a Memoir on the great importance of magnesium for photographic purposes, owing to the high refrangibility and the great actinic power of the light emitted by burning magnesium-wire. The study of this Memoir led Mr Sonstadt to consider whether, the magnesium salts being so abundant, the metal might not be obtained, on a comparatively large scale, at a moderate price. After a prolonged series of expensive experiments, he succeeded, in 1862, in producing specimens of the metal, varying from the size of a pin's head to that of a hen's egg. Although it burned freely enough, it was still wanting in ductility and malleability, in consequence of the presence of certain impurities; but by May 1863, these difficulties were overcome by a process of purification by distillation; and by the close of that year, he considered it safe to begin manufacturing. The Magnesium Metal Company was



## MAGNESIUM AND THE MAGNESIUM LIGHT.

consequently organised, and operations commenced at Manchester. One great advantage of his method is its simplicity: it can be accomplished by the hands of ordinary workmen ignorant of all chemical knowledge. The process of manufacture may be thus described: 1. An anhydrous chloride of magnesium is prepared by saturating lumps of rock-magnesia (carbonate of magnesia) with hydrochloric acid, and then evaporating the solution to dryness. 2. One part of metallic sodium cut in small pieces is placed in an iron crucible, and covered with five parts of the chloride. The crucible is covered, and heated to redness, when the chlorine leaves the magnesium, and unites with the sodium, for which it has a stronger affinity. When the crucible has cooled, and its contents are removed *en masse*, and broken, the magnesium—in that state known as crude magnesium—is seen in nuggets of various sizes, varying from granules to masses as large as a hen's egg. 3. The distillation of the crude metal is effected in a crucible through which a tube ascends to within an inch of the lid. The tube opens at the bottom into an iron box, placed beneath the bars of the furnace, where, on the completion of the operation, magnesium is found in the form of a heap of drippings, which may be melted and cast into ingots or any desired form. The difficulty of obtaining a metal with so little ductility in the form of wire—the only form that was originally used for yielding light—had still to be overcome; and after various partially successful attempts to press small quantities into wire by Matthiessen and others, Mr Mather of Salford devised a piece of machinery by which the metal is pressed into wire of various thickness. Mr Mather also was the first who obtained the metal in ribbons, in which form, from the larger exposed surface, combustion takes place more completely. To the same gentleman is also due the credit of having constructed the first magnesium lamp, in which the end of the wire or ribbon is presented to the flame of a spirit-lamp. As the wire or ribbon consumed, it was paid off by hand from a reel, and propelled between rollers through a tube which conducted it to the flame. A concave reflector diffused the light forwards, and protected the eyes of the operator.

The first time that a photograph was ever taken by this light was at Manchester in the spring of 1864 by Mr Brothers and Dr Roscoe. That the magnesium light, in a more or less modified form, must prove of extreme value to photography, cannot be called in question. Besides overcoming the obstacle of unsuitable weather for the employment of sunlight, it may be applied both for the exploration and the photography of various dim structures, underground regions, &c., such as the interior of the Pyramids, of catacombs, natural caverns, &c., which could not otherwise be examined or photographed. Professor Piazzi Smyth, the Scottish Astronomer-royal, dating from the East Tomb, Great Pyramid, February 2, 1865, writes as follows: 'With any number of wax-candles which we have yet taken into either the King's Chamber or the Grand Gallery, the impression left on the mind is merely seeing the candles, and whatever is very close to them, so that you have small idea whether you are in a palace or a cottage; but burn a triple strand of magnesium wire, and in a moment you see the whole apartment, and appreciate the grandeur of its size and the beauty of its proportions.' According to the writer of an excellent article in the *Technologist* for 1865, 'M. Madar is said to be engaged on a series of photographs of the Catacombs of Paris; various artists are busy practising on monuments in obscure recesses of continental churches; and Mr Brothers, we believe, contemplates undertaking the

caves of Derbyshire.' For portraiture, it is found to be less successful than was at first expected, owing to the intense light within a few feet of the sitters eyes causing a contraction of the facial muscles.

One of the peculiarities of the magnesium light is, that it displays colours as they are seen in sunshine. This may be tested, and a very interesting effect produced, by burning some wire in a garden or conservatory at night. This peculiarity is being turned to practical account. The magnesium lamp, says a writer in the *British Journal of Photography*, promises quickly to become a regular article of furniture in every silk-mercero's show-room. 'The strength of the magnesium light, coupled with its easy production, qualifies it for extensive employment in commerce and war. Unlike the electric and oxyhydrogen lights, it involves no cumbrous and troublesome apparatus. With a coil of the wire in his waistcoat pocket, and a few matches, an Alpine explorer has instant means for making his whereabouts known at night. The light has been seen at a distance of twenty-eight miles at sea; how much further, remains to be determined. Commissions under several governments are investigating its capabilities, and there is reason to believe that it will very soon be adopted for ship-signals and light-houses.'—*Technologist*, *op. cit.* In surgery, the light has been successfully employed in connection with the laryngoscope; and by this means not only can the slightest sore in the upper part of the respiratory organs be discovered, but the same may be rendered visible to a numerous audience. How far the magnesium light can be applied to the ordinary purposes of illuminating streets, public buildings, &c., is not yet determined. The objectors to such applications of the light maintain that, while light in which carbon constitutes the ignitable solid possesses a power of diffusibility which renders objects not directly opposed to the course of the rays more or less distinctly visible, the electric, lime, and magnesium lights possess none of this diffusiveness; their rays being apparently projected with a force and velocity which deprive them of the power of diffusion. An object placed in the direct course of the rays is splendidly illuminated, and the rays are projected to an immense distance; but the shadows cast by intervening objects are intensely black, and the rays seem to pass through the atmosphere without producing much effect, except upon that part which is in the course of the stream of light. 'And herein,' observes Mr Willmitt, who does not adopt these objections, 'would appear to reside the supposed cause of failure of the application of this light to ordinary illumination.'—*Pharm. Journ.* for April 1865.

It is found by experiment that 2½ oz. of magnesium wire will give out as much light as 20 lbs. of the best stearine candles, and at this rate, the magnesium light is not much dearer than that of the best candles. Mr Grant, the well-known photographer, has ascertained that certain alloys into which magnesium enters largely, afford nearly as brilliant a light as pure magnesium, with various tinges of colour; thus, one part of zinc and two of magnesium produce an alloy which burns with a slightly blue tinge; one part of copper and three of magnesium give a green light; while one part of strontium and two of magnesium give a red light. Such modifications of the light may prove highly serviceable in signalling, besides being much less expensive in most cases than the pure light.

Various forms of the magnesium lamp have been devised, the best of which is Larkins's Magnesium Powder-lamp, in which arrangement a mixture of finely divided sand and powdered magnesium is

## MAGNESIUM AND THE MAGNESIUM LIGHT—MAGNETO-ELECTRIC MACHINE.

projected in a graduated stream, and is submitted to combustion, in place of a wire or ribbon of the pure metal. It is simple in construction, small in size, and very portable; and the light is continuous, and quite under control. It is easily ignited, and as easily extinguished; and as the magnesium is burned in powder, all clock-work, &c. is dispensed with. Amongst the advantages of the light, in addition to its intensity, may be mentioned—(1) that it gives off no compounds unpleasant or injurious to man or his surroundings, such as plate, fur, paper-hangings, books, &c.; (2) that it is altogether unattended with danger from explosion, the whole chemical process involved being a union of the metal with the oxygen of the air, and the only result being oxide of magnesium or magnesia; and (3) the portability of the materials.

The great drawback to the more general application of this light is its price.

From information directly obtained from the agents of the Magnesium Metal Company (Messrs Johnson, Matthey, & Co., London), we learn that the wholesale price of the pure metal, in the form of wire or ribbon, of the ordinary sizes for burning, is 10s. per oz.; and in the form of plates, ingots, or powder, is 7s. 6d. per oz., while the crude metal sells at 5s. per oz. The respective retail prices are 12s., 9s., and 6s. per oz. It may also be mentioned that the present wholesale price of pure sodium, on which the expense of the magnesium solely depends, is 8s. per lb. Any quantity of wire or metal less than one ounce is sold at the rate of 16s. per oz.; and as the ordinary series of wire run from 80 to 200 feet per oz., and those of ribbon from 80 to 150 feet per oz., a very simple calculation gives the present price of the wire per foot.

It was about the year 1864 that magnesium was first made on a commercial scale, and it is found that the demand for it, although not decreasing, is scarcely at all extending. It is almost wholly used for burning in photographic lamps, for flash lights, and for fire-works. It has been attempted to make magnesium useful for other purposes. Various alloys have of late years been made with it and other metals, such as lead, tin, zinc, cadmium, and silver; but they are all very brittle and liable to change. It is very doubtful, therefore, if any of these alloys will become useful in the arts, and the metal itself is scarcely more likely to be available in the construction of objects of ornament or utility, since, when exposed to damp, it soon becomes coated with a film of hydrate of magnesium.

**MAGNETO-ELECTRIC MACHINE** (More recent forms of). Of late years, quite a new era has arisen in the construction of magneto-electric machines. The compactness, simplicity of construction, and marvellous power which the new machines possess, give them quite a novel importance in practical electricity. The names chiefly associated with the new improvements are Wilde of Manchester, Siemens and Wheatstone, and Gramme of Paris. Mr H. Wilde, in 1866, patented a magneto-electric machine, founded on the principle that a current or a magnet indefinitely weak can be made to induce a current or a magnet of indefinite strength. A general description will best shew how this is proved and applied.

Wilde's original machine is shewn in front elevation, fig. 1. It consists of two machines very similar to each other, the upper one MM', and the lower EE'. The upper and smaller machine consists of sixteen permanent magnets, placed one behind the other. The front one only is seen. The poles of these are fixed at *g, g* (fig. 2), to what is termed the magnet cylinder. This consists of a

hollow tube, made up of heavy masses of cast-iron, *c, c*, at each side, separated from each other by brass rods, *b, b*, the whole being knit firmly together, above and below, by brass bolts at *r, r'*. The cast-iron side pieces thus form the poles of the magnetic battery. The armature, which revolves within the tube of the magnet cylinder, is a long piece of soft iron, *aa*, and in section resembles an H. In the hollows of the H the wire is turned longitudinally. This armature is shewn separately in fig. 3, part of the wooden tops which cover in the wire being removed to shew how the wire is turned. This form of armature was first constructed by Siemens. The ends of the armature wire are soldered to two insulated iron rings, *n, n'* (fig. 3), against which the springs, *s, s* (fig. 1), press, which convey the current

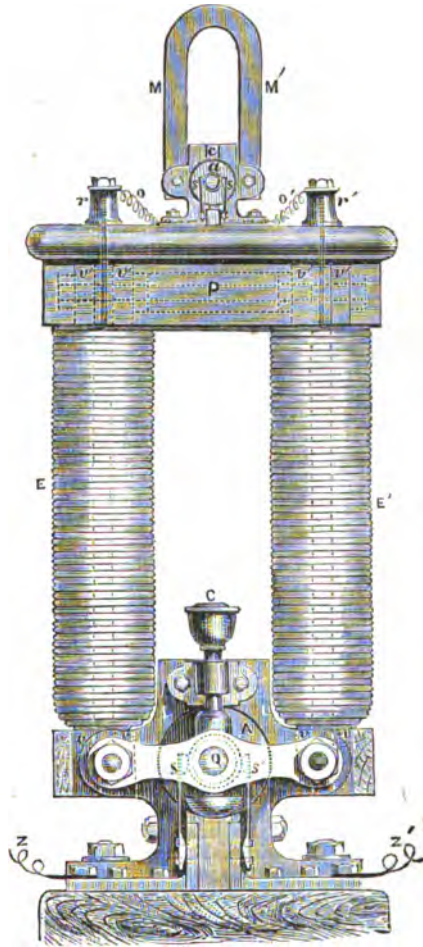

Fig. 1.

from the revolving armature; *m* is the pulley of the driving-belt. If the cross-bar of the H stand upright (it lies horizontally in the figure), and the armature be turned round, while wires leading from the binding-screws, *r, r'* (fig. 1), are connected with a galvanometer, it will be found that the current induced by the motion is in the same direction till the cross is again upright, but inverted. If the motion be continued beyond that point, a current in the opposite direction will ensue,

## MAGNETO-ELECTRIC MACHINE.

lasting till the cross-bar is in its first position. The right half of the armature gives off always one kind of electricity, and the left the other. The right and

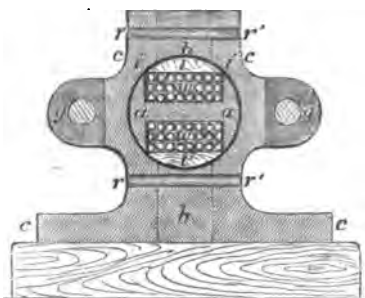

Fig. 2

left springs, *a, a'*, are thus always like poles, for they change from *n* to *n'* (fig. 3), when the current in the armature changes. We come now to describe the singular peculiarity and merit of Wilde's machine.

The current got from the magneto-electric machine is not directly made use of, but is employed to generate an electro-magnet some hundreds of times more powerful than the magnetic battery originally employed, by means of which a corresponding increase of electricity may be obtained. This electro-magnet, *EE'* (fig. 1), forms the lower part of the figure, and by far the most bulky portion of the entire machine. It is of the horse-shoe form, *E* and *E'* forming the two limbs of it. The core of each of these, shewn by the dotted lines, is formed by a plate of rolled iron, 36 inches in height, 26 inches in length, and 1 inch in thickness. Each is surrounded by a coil of insulated copper-wire (No. 10), 1650 feet long, wound round lengthwise in seven layers. The current has thus, in passing from the insulated binding-screw *r*, to the similar screw *r'*, to make a circuit of 3300 feet. Each limb of the electro-magnet is thus a flat reel of covered wire wrapped round a sheet of iron, the rounded ends alone of which are seen in the figure. The upright iron plates are joined above by a bridge, *P*, built up also of iron-plate, and are fixed below the whole way along with the iron bars *v, v'* to the sides of a magnet-cylinder of precisely the same construction as the one already described. The iron framework of the electro-magnet is shewn by the dotted lines. The depth of the bridge is the same as the breadth of the bars *v, v'*, which are of the same size as the bars *v, v'*. The various surfaces of juncture in the framework are planed, so as to insure perfect metallic contact. The upper and lower machine are in action precisely alike, only the upper magnet is a permanent magnet, and the lower one an electro-



Fig. 3

magnet. We have the same magnet-cylinder, *I, I*, the same armature, *A*, and springs, *S, S'*, and the same poles, *Z, Z'*; the size is, however, different; the calibre of the magnet-cylinder is 7 inches. The diameter of the lower armature gives the name to the machine—viz., a 7-inch machine. Figs. 2 and 3 are on the scale of the lower machine (fig. 1). The length of wire on the lower armature is 350 feet. It is 35 inches in length, and is made to rotate 1800 times a minute. The cross framework attached at *gg* to the magnet-cylinder, in which the front journal, *f*, of the armature rotates (at *Q*), is shewn in the lower machine (fig. 1). When the machine is in action, both armatures are driven simultaneously by belts from the same counter-shaft. For the electric light, the currents conveyed to the springs, *S* and *S'*, need not be sent in the same direction. In that case, the separation between *a* and *n'* is vertical; and each spring presses against only one ring during the whole revolution, receiving and transmitting each revolution two opposite currents. Oil for the journal and commutator is supplied from the cup *C*.

A Wilde's machine  $1\frac{1}{2}$  ton in weight, measuring about 5 feet in length and height, and 20 inches wide, driven by a steam-engine, produces a most brilliant electric light, and exhibits the most astonishing heating powers.

Wheatstone and Siemens gave a new interpretation to Wilde's principle. Their important discovery is of the following nature: Suppose the upper machine in fig. 1 removed, and that we have nothing but the electro-magnet and armature left. If the wires proceeding from the binding-screws of the armature be joined up with the electro-magnet, we might fancy that, there being no permanent magnetism, no result would follow on the armature being moved. Such, however, is not the case. If the armature be moved at any velocity, it will soon be brought to a halt by the mutual action ensuing. In the electro-magnet there is always some magnetism left. This induces a feeble current in the coil, but this is sufficient to make the magnet stronger and able to induce a stronger current, and this reciprocal action continues until it grows to an enormous intensity. So great indeed would it become, that if we had sufficient mechanical energy at our disposal to persist in the motion, the coils of armature and electro-magnet would be melted, and the machine destroyed. This startling discovery may, however, be thought of little value, as a machine that consumes its own electricity is of no external use. All machines now work on this reciprocal principle, and a description of them will best shew how it is turned to account. Ladd was the first to construct a machine on Wheatstone and Siemens' principle. Fig. 4 (much smaller in scale than the preceding figures) gives a



Fig. 4

view of the armature. In it there are two coils, *A* and *B*; *A* the larger for furnishing the external current, *B* the smaller for exciting the electro-magnet. These two coils revolve together, the one at right angles to the other, in the same magnet-cylinder. In large machines he uses two magnet-cylinders, one at each end of the electro-magnet; or rather, he uses two electro-magnets, and the two armatures complete the magnetic circuit. Ferguson of Edinburgh alters Ladd's arrangement in using only one piece of iron for the armature of the machine with

two grooves cut in it (fig. 5), a larger one for the coil giving the external current, and a smaller one for the exciting current. This offers the advantage



Fig. 5.

that the heating of the solid iron of the armature by repeated magnetism is lessened by being transformed into an electric current. The electro-magnet is thus fed by a current obtained not by an additional expenditure of energy, but by the utilisation of force that would be otherwise converted into useless or even hurtful heat.

The great drawback of all the forms of the machine just described is the enormous velocity at which they rotate; some 2000 or more revolutions in the minute. At this speed a machine soon wears itself done. Another disadvantage is the heating of the armatures in Wilde and Ladd's machine. Ferguson's has never been tried on a large scale. It is found necessary to keep the armatures cool by a flow of cold water. This heat, however removed, is manifestly a mere squandering of the energy of motion, and a loss to the current given off. A third objection is the loss that always takes place when the side-springs change from the one ring to the other, sparks more or less bright accompanying the change. For the electric light, however, the alternate currents are used, and this source of loss is not experienced. These defects are removed in the latest form of the electro-magnetic machine by Gramme of Paris. In it, instead of a solid armature of iron, a ring is employed on which a great number of bobbins of wire are set. Fig. 6

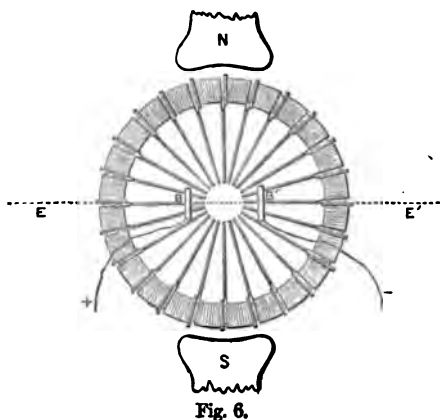

Fig. 6.

is intended to explain the rudimentary principle of it. The ends of the wires of two contiguous bobbins are soldered to strips of metal called sectors. These are shewn as radii in the figure. In the machine itself they are first brought down radially, then turned at right angles so as to be parallel to the axis of the machine. They are very numerous (though few in the figure), and being separated from each other by sheets of silk, form a compact whole. Metallic brushes, B, B, rub on the end face of the sectors, and form the poles of the revolving armature. The principle of action may be thus understood. Suppose we first ascertain what takes place in the coil of one bobbin as it revolves in the presence of the magnetic poles, F, N. If we start from the equatorial line, EE', and go by successive impulses, we find that, when the bobbin

is joined with a galvanometer, the current induced is always in one direction until we come again to the equatorial line; but when we pass this, the current is reversed on the other side. This is much the same as what is found in the Siemens armature. But there is this difference here. The armature wire with the sectors is continuous from end to end. On each side of the equatorial line, we have two equal and opposite electric forces or batteries, and these, if left alone, would neutralise each other. But if, in the equatorial line, we introduce brushes to act as poles, we have, as it were, two galvanic batteries joined up, as it is called, in quantity, with both positive poles together and also both negative. The brushes embrace several sectors at once, so there is no spark when they leave any particular sector, contact being established with the others. The conditions of the machine never alter, and hence the current is perfectly steady, and the sectors being always of the same sign at the points where the brushes rub, the current is always in the same direction. Siemens and Wheatstone's principle is employed in Gramme machines. There are two fixed electro-magnets, and two armatures on the same spindle; one electro-magnet and one armature being set apart for exciting both electro-magnets, and the other armature and electro-magnet for sending out the external current. Astonishing as were the effects produced by Wilde's machine, those obtained from Gramme's seem quite to eclipse them. In comparing two magneto-electric machines, we must take into account the kind of wire used for the revolving armature. For tension purposes, a thin and long wire gives the best results; for quantity or heating purposes, a short and thick wire does best. To compare a tension with a quantity armature, the same test even in the same machine would give most contradictory results. But comparing, so far as possible, machines intended for the same purpose, Gramme seems to have the advantage of all others. In the first place, the speed of revolution seldom exceeds 800 revolutions per minute; 300 is sufficient for most purposes. A Gramme machine driven by the hand will melt 10 inches of an iron wire  $\frac{1}{4}$  of an inch in diameter, a feat not accomplished by any other arrangement. The electric light got by a 3 horse-power engine working a machine a ton in weight is equal to upwards of 8000 sperm candles. A signal-light of this kind has been constructed for the House of Lords, under the superintendence of the eminent engineer, Conrad W. Cooke, who has rendered no small service in perfecting the machine. The carbons consumed last for four hours, and when burned done are instantaneously replaced. A Gramme machine adapted for electro-plating, and worked by a 1 horse-power engine, deposits nearly 27 oz. of silver per hour, an achievement far transcending the similar performance of other machines. Among the heating wonders of the Gramme machine we are told of a file half an inch in diameter being burnt up in 5 minutes, of 15 feet of No. 18 platinum wire being brought to a glowing heat, and of 8 feet of iron wire  $\frac{1}{64}$  inch in diameter being fused.

MAHIM, a town of the island of Bombay, and seven miles north of the city of Bombay, to which it is joined by railway. It is situated on the south side of the channel separating the island from Salsette, and at the point where they are connected by a road running partly on arches of masonry, partly on a causeway. The passage is commanded by a fort. The town is ill built, and inhabited chiefly by Christians of Portuguese descent, who have here a church and some other relics of their former prosperity. The inhabitants are chiefly employed in fishing, the place being famous for its oysters. Pop. 9000.

**MAITLAND**, a town of New South Wales, in the county of Northumberland, on the Hunter river, 95 miles north of Sydney, and 20 miles north-west of Newcastle, to which it is joined by railway. It is divided by the river into East and West Maitland. Pop. of M. (1861) 7528; (1871) 13,642. In either division are handsome banks, churches, and other public buildings. In West M. (much the more populous part of M.) are several coach-building factories, tobacco manufactories, and three mills (including a paper-mill). Good coal abounds in the neighbourhood. The district has been called the 'Granary of New South Wales.'

**MA'LDAAH**, a town of British India, in Bengal, the chief town of a district of the same name, is situated on the left bank of the Mahununda, about 190 m. N. of Calcutta. In the rainy season, it is nearly insulated. It is a wretched place, consisting of ruined houses, forming narrow irregular streets. Pop. (1871) 5262.

**MALLET**, CLAUDE FRANÇOIS DE, born 28th June 1754, at Dôle in Franche-Comté, became an eager supporter of the Revolution, rose to the rank of a brigadier-general in 1799, was intrusted with the government of Pavia in 1805, but was removed from his office because of his extreme republicanism. He returned to Paris, and was engaged in a number of republican plots. Being, in June 1812, thrown into confinement along with some royalists, he formed with them a scheme for overthrowing the empire during Napoleon's campaign in Russia. He made his escape from prison on the night of 23d—24th October, along with the Abbé Lafon, and entering the barracks, informed the soldiers that the tyrant had perished in Russia. He proceeded to liberate Generals Guidal and Lahorie from prison; and having previously gained the support of a battalion of the Parisian Guards, he called them to arms, and went to the residence of Hullin, the commandant of the city, whilst Lafon went with a platoon to the prefecture. He told Hullin of the death of the Emperor, and the establishment of a provisional government, and on his manifesting doubt, drew a pistol and fired it in his face, wounding but not killing him; whereupon the adjutant, Laborde, rushing in, Hullin and he together overpowered M., and took him prisoner. When interrogated, he declared that he would have made all France and all Europe his debtors, if his enterprise had been successful, and maintained the same resolute coolness to the last. He was shot, along with his principal fellow-conspirators, 29th October 1812.

**MANA'GUA**, a town of Central America, the capital of Nicaragua, in a healthy and fertile district, on the south shore of Lake Managua or Leon. It owes its position chiefly to the rivalries of the cities of Granada and Leon, but partly also to its central situation.

**MANBY**, GEORGE WILLIAM, favourably known for his exertions in saving the lives of persons in danger of shipwreck, was born in 1765, at Hilgay, near Downham Market in Suffolk. After studying for the army, he served seven years in the militia. Receiving the appointment of barrack-master at Yarmouth in 1803, he had frequent opportunities of witnessing the ravages produced by storms on the coast of Norfolk and Suffolk. A dreadful series of shipwrecks on a particular day in 1807, when H.M. gun-brig *Snipe* was wrecked within 60 yards of the shore, and 67 lives lost, and when 147 dead bodies were found on about 30 miles of coast, drew his attention forcibly to the subject, and led him to experiments which resulted in the invention of the apparatus known by his name (see LIFE MORTARS AND ROCKETS in SUPP., Vol. X.) On February 12,

1808, he succeeded in saving the lives of the crew of the brig *Elizabeth*, which was stranded at 150 yards from the shore; he sent a rope over to them by means of a shot, and this rope was the means of pulling a boat from the shore to the brig. A career of usefulness was thus commenced, which he followed for the remaining 46 years of his life. In 1810, a committee of the House of Commons voted £2000 to M., as a token of recognition of his services. Being appointed to report on the dangers of the Norfolk and Suffolk coasts, he recommended the establishment of mortar-stations at certain intervals. This recommendation was adopted by the House of Commons and the government; and by the year 1815, there were nearly 60 such stations. Captain M. received a further grant from parliament in 1823 of £5000; to which were added honorary distinctions from many foreign governments. It was estimated that, by the time of his death, nearly 1000 persons had been rescued from stranded ships by means of his apparatus. He wrote two works on his favourite subject, *An Essay on the Preservation of Shipwrecked Persons, with a descriptive account of the Apparatus, &c.* (1812); and *Practical Observations on the Preservation of Mariners from Stranded Vessels, and the Prevention of Shipwreck* (1827). In what manner his system has since been superseded by one of a more effective kind, is described under LIFE MORTARS AND ROCKETS. Captain M. died November 18, 1854.

**MANDALAY**, MANDELAY, or PATTAWAPURA, the present capital of the kingdom of Burmah, lies 3 miles from the Irrawaddy River, a little N. of the former capital Amarsapura (q. v.), and 350 m. N. of Rangoon. In 1856, its site was occupied by cultivated fields; but having been chosen by the king as the position for a new capital, was in the following year ready to receive the court. The city is laid out in three parallelograms, of which the inner two are walled. Within the innermost are the palace, and offices of government; in the second inclosure are the houses of the civil and military officers, and the quarter of the soldiers; while the outer city is inhabited by merchants, mechanics, &c. Pop. about 90,000.

**MANDU'**, an extensive deserted city of India, in the state of Dhar, in Malwa, in lat. 22° 20' N., long. 75° 27' E. The circumference of the ramparts is said to be 37 miles. The greatest and least injured of the ruined buildings is the Jama Masjid, or Great Mosque, the area of which is raised several yards above the ground, and is reached by a handsome flight of stairs. The mausoleum of Hoshung Ghori, king of Malwa, is a massive building of white marble. According to Malcolm, M. was founded 313 A.D.

**MANRESA**, a town of Spain, in the province, and 30 m. N.W. of the city, of Barcelona. It is situated in a fertile and well-irrigated district, on the left bank of the Cardonet. M. has manufactures of cotton and silk fabrics, broadcloths, &c. In 1811, it was set on fire by Marshal Macdonald, when more than 800 houses, with churches and manufactories, were burned down. Pop. 15,264.

**MANSEL**, THE REV. HENRY LONGUEVILLE, B.D. Waynflete Professor of Moral and Metaphysical Philosophy in Oxford, was born at Cogrove, Northamptonshire, in 1820, his father being rector of the parish. He was educated at Merchant Taylors' School, and at St John's College, Oxford; and graduated in 1843. In 1855, he was appointed Reader in Moral and Metaphysical Philosophy, in Magdalen College; and in 1859, became Waynflete Professor. In 1867, he received the appointments of Regius Professor of Ecclesiastical History, and Canon of Christ Church, Oxford. His published

works are: Aldrich's *Logic*, with *Notes* (1849); *Prolegomena Logica* (1851); article *Metaphysics*, in 8th edition of the *Encyclopædia Britannica* (1857), afterwards published separately; *Bampton Lectures—The Limits of Religious Thought* (1858); *The Philosophy of the Conditioned* (1866), in reply to Mill's *Review of Hamilton's Philosophy*. He was co-editor, with Professor Veitch, of Sir William Hamilton's *Lectures*.—Mr M. is considered as belonging to the school of Sir W. Hamilton. He was well versed in the erudition of Metaphysical Philosophy, and wrote in a clear and elegant style. His *Bampton Lectures* occasioned much controversy, both theological and philosophical. See **CONDITIONED**. He died 30th July 1871.

**MANTES** (anc. *Medunia*), a town of France, in the dep. of Seine-et-Oise, beautifully situated on the left bank of the Seine, 29 miles west-north-west from Paris, on the railway between Paris and Rouen. M. is a place of great antiquity, and of much historic interest. It was a town of the Celts, from which the Druids were expelled by Julius Cæsar. William the Conqueror took it by assault in 1087, put the inhabitants to the sword, razed the fortifications, and burned three-fourths of the houses; but here he received the injury, through the starting of his horse, which caused his death in a few days. M. has a considerable trade in wheat, large tanneries, and saltpetre manufactories. Pop. (1872) 5332. On the opposite side of the river, connected with M. by bridges and an island, is the village of Limay, with a pop. of 1304.

**MARCH**, a market-town of Cambridgeshire, England, 29 miles north from Cambridge, on both sides of the Old Nen, which is here navigable for boats, and on the East Anglian Railway. There is a junction of five railways at March. There is a large square market-place in the centre of the town, and a splendid court-house, in which the meetings of the Middle Level Drainage Commissioners are held. Pop. (1871) 5854. In the neighbourhood is *March Wet Fen*, a drained fen with an area of 3600 acres, from which the water is pumped off by steam-engines.

**MARGAY** (*Felis tigrina*), a species of cat or tiger-cat; a native of the forests of Brazil and Guiana; about the same size with the wild cat of Europe; of a pale fawn colour, with black bands on the fore-parts, and leopard-like spots on the hind-parts, and on the rather long thick bushy tail. It has been erroneously represented as untamable, being, in fact, capable of a complete domestication, and of being made very useful in rat-killing.

**MARIA'NNA**, or **MARIANA**, an episcopal city of Brazil, in the province of Minas-Geraes, about 12 miles east of Ouro Preto. In the neighbourhood are gold, silver, and lead mines. Pop. 8000.

**MARIENBERG**, a town of Saxony, in the circle of Zwickau, 38 miles south-west of Dresden. It has manufactures of linen, lace, and steam-engines, and the neighbouring mines give employment to a great number of the inhabitants. M. has mineral baths, and an establishment for the cold-water cure. Pop. (1871) 5617.

**MARINE'O**, a town of Sicily, in the province of Palermo, and 11 miles south of the town of Palermo, near a small river which flows into the Gulf of Palermo. Pop. 8360.

**MARINO** (anc. *Bovilla*), a market-town of Central Italy, in the Comarca, and 12 miles south-east of the city of Rome, near Lake Albano. M. is situated on a high hill above a plain, and is surrounded by strong walls and towers, which were erected by the Colonna in 1490, and add much to

its picturesque beauty. According to the writer of Murray's Handbook, the long street called the Corso, the piazza of the Duomo, and the fountain, would do credit to many towns of more importance. At the foot of the hill of Marino, lying between it and the ridge of Alba Longa, is a deep glen beautifully wooded, called the *Parco di Colonna*. This valley is highly interesting as the site of the *Aqua Ferentina*, memorable as the spot on which the Latin tribes held their general assemblies, from the destruction of Alba to the consulship of P. Decius Mus, 338 B.C. M. is also interesting in the history of the middle ages as the stronghold of the Orsini family, who first appear in the 13th c. in connection with their castle of Marino. In the 15th c., it became the property of the Colonna family, who have retained it almost without interruption to the present time. Pop. 6000.

**MARKING-NUT**, the fruit of *Semecarpus anacardium*, a tree of the natural order *Anacardiaceæ*, a native of the mountains of India. It is a large tree, with oblong leaves, and terminal panicles of flowers. The fruit is a heart-shaped nut, seated on a large swollen receptacle. The receptacle, when ripe, is roasted and eaten, and resembles a roasted apple; although, when raw, it is astringent and acrid. The nut is black, and between the two coats of its shell there is a black acrid juice, much in use for marking cotton-cloths, a mixture of quick-lime and water being applied, to prevent it from running, and to brighten the colour. It is also used as an external application in rheumatism.

**MARSIVAN**, or **MARSOVAN**, a village of Asia Minor, in the pashalic of Sivas, and 120 miles north-west of the town of that name, in a wide undulating plain. M. is a post station of the first class, has many mosques and fountains, and some manufactures of cotton stuffs. Its Greek name is Merziphone.

**MASAY'A**, one of the oldest towns of Nicaragua, Central America, close to a lake of the same name, 40 miles north-north-west of Nicaragua city, and eight miles from the north shore of the lake of Nicaragua, near the volcano of Masaya—a broad, low mountain, about 3500 feet high, with one large and several minor craters. The last great eruption of this mountain was in 1870, when the lava spread in a northern direction to a distance of more than 20 miles. This great lava-field is said to resemble an ocean of ink suddenly congealed in a storm. In 1860, the mountain shewed signs of renewed activity. The town is the centre of a very fertile district, and has a pop. of 16,000, chiefly Indians, who are said to be thrifty and industrious.

**MASCARA'**, a very old town of Algeria, in the province of Oran, and 50 miles south-east of the town of that name, on a slope of the Atlas Mountains. M. was built by the Turks upon the site of a Roman colony. During the first years of the French occupation, it was a favourite residence of Abd-el-Kader, but was taken by the French in 1835. Pop. about 9000, of whom more than a half are natives.

**MASHE'NA**, a town of Bornu, Central Africa, in lat. 13° 3' N., long. 10° 2' E., about 240 miles west of Lake Tchad. It lies on the gentle southern slope of an eminence, the top of which is crowned with a rocky crest, and is surrounded with a clay wall. According to Barth, it is a considerable place for this country, having a pop. of certainly not less than 10,000, but without the least sign of industry.

**MA'SSOWAH**, or **MASOUA**, an islet and town on the west coast of the Red Sea, in lat. 15° 36' N., and long. 39° 21' E., close to the boundary between

Nubia and Abyssinia. At present, it is politically connected with Nubia rather than with Abyssinia, being in the possession of the Viceroy of Egypt, and ruled by a governor appointed by him. The island is of coral, the soil partly formed from the rock, partly from sand and broken shells. It is only about a mile and a quarter in circumference, and is distant from the mainland only about 200 yards. It is almost wholly occupied by the town, and contains a pop. of about 8000, mostly Arabs. The Abyssinian coast is very destitute of harbours, and M. is of great importance as a seat of commerce. It carries on a large trade by sea with Bombay and with the Arabian coast, particularly with Jiddah and Yembo; and a large trade also by caravans with Cairo on the one hand, and with Gondar and the whole interior of Abyssinia on the other. Caravans start at all seasons for Cairo and for Gondar; but most numerously in January, at the end of the rains, and in June, before the swelling of the waters. Wheat, rice, maize, durra, salt, tobacco, gunpowder, sugar, cotton and silk goods, scarlet cloth, glass wares, arms, and hardwares are among the principal imports from the more distant parts of the world. From Abyssinia and the coasts of the Red Sea, M. receives and exports ivory, rhinoceros' horns, wax, ostrich-feathers, tortoise-shell, myrrh, senna, pearls, &c. M. has all the worst characteristics of an oriental town. Its streets are mere lanes, and excessively dirty. M. was originally chosen as the place of debarkation of the British expedition to Abyssinia (1867), and the starting-point of its operations; but it was soon found unsuitable, and Annesley Bay, about 15 miles further to the south—the deepest inlet on the Abyssinian coast—was chosen for that purpose instead.

**MASTER AND SERVANT.** There having been reason to complain that the Act 4 Geo. IV. c. 34, under which disputes between masters and servants were generally determined, was a one-sided measure, a parliamentary committee investigated the matter in 1865 and 1866. The result was a bill, introduced by Lord Elcho into the House of Commons, which passed, and forms the Act 30 and 31 Vict. c. 141, called The Master and Servant Act, 1867. This statute provides that a party aggrieved, whether master or servant, may lay his information before a justice, or (except in certain districts) a stipendiary magistrate, or (in Scotland) before a sheriff; and thereupon a summons is issued, calling on the alleged offender to appear and answer the charge. After trial, the court may, according to circumstances, either declare the whole or a part of the servant's wages to be forfeited; or else, may order the master or the servant, as the case may be, to fulfil the contract, and (if thought right) to find security for doing so; or else, it may annul the contract, and apportion the wages due under it; or it may fine the offender in a sum not exceeding £20; or fix a sum due to the offended party for compensation for the injury caused by the conduct of the other party. When a fine is imposed, or damages awarded, the money is to be recovered by execution against the offender's goods; but, in default of payment being had in that way, the offender may be imprisoned (without hard labour) for not more than three months. The possibility of these provisions being insufficient, in the case of the occurrence of any of those aggravated offences which formed the excuse for the more rigorous law which has been superseded, is recognised, and whenever it appears that any injury inflicted on the person or property of the party complaining has been of an aggravated character, and has not arisen in the exercise of a legal right existing, or reasonably and *bona fide* supposed to exist, the court may commit the

offender to prison, with or without hard labour, for a term not exceeding three months. In all proceedings under the act, the parties themselves are admissible as witnesses. The act entirely remodelled the statute law of master and servant. Previously, the law, while regarding a breach of contract committed by a master as only a civil wrong, had treated as criminal a breach of contract committed by a servant. Now masters and servants are on the same footing before the law, like offences, whether committed by one or the other, being dealt with in the same way. Nevertheless, the working of the act has caused such irritation among the working-classes, and on their behalf it is now sought to make the breach of a contract of service a matter incurring only civil damages. Where the sentence of the magistrate makes imprisonment the consequence of the non-payment of a fine, working-men are in a large proportion of cases sent to prison, while employers can nearly always pay the fine. Hence it is contended that the Master and Servant Act, while appearing to give the same treatment to employers and employed, presses hardly upon the latter.

**MASTS, IRON AND STEEL.** As far back as 1838, the City of Dublin Steam-packet Company had a steamer with hollow iron masts, the masts acting also as ventilating funnels for the cabins. From that time, iron has been frequently employed for lower masts, in sailing-ships as well as in steamers. The plan has usually been to make them of plates bent to the proper curvature, jointed by internal strips, and strengthened by an internal cross flange of plates secured by angle-irons; but sometimes the plates are lapped. The plates vary from  $\frac{3}{4}$  to  $\frac{1}{2}$  inch in thickness. Mr Grantham (*Iron-shipbuilding*) states that iron masts are 'lighter and stronger than timber masts; and when compared with the built-up masts of large vessels, are rather less expensive. For vessels of the same tonnage, the difference of weight is nearly two to three in favour of iron.'

Iron is used for yards as well as masts. An iron yard was made in 1847 for the Australian clipper-ship *Schomberg*, 112 feet long, and varying in diameter from 14 to 28 inches; it weighed 7 $\frac{1}{2}$  tons. It was calculated that a timber yard of the same size would weigh 12 $\frac{1}{2}$  tons. Iron masts have since that time been employed in many ships in the royal navy, made of three vertical ranges of plates bent to the required curvature, with butt joints, and riveted to three T-irons which cover the joints on the inside.

Captain Cowper Coles (drowned in the *Captain*, a martyr to his own inventiveness, 1870), the inventor of the turret system for ships of war, introduced tripod iron masts. The real mast is strengthened and upheld by two others, the three forming a tripod. The central tube, or real mast, is carried up to form the topmast; while the side tubes are carried up only to the height of the lower yard. The main tube rests upon the keelson; while the side tubes, which are on either side of it and behind it, rest upon parts of the bottom-framing; but all three are fastened to the deck as they pass through. The lower mast only forms the tripod, and is self-supporting, without shrouds, &c.; the topmast is secured with stays, backstays, and outriggers. Captain Coles enumerated many advantages which he believed this construction to possess.

Since the use of steel in shipbuilding has become recognised, the employment of the same metal for masts has engaged attention; steel plates, we know, can now be made almost as easily as plates of iron; and it becomes a question of increased efficiency against increased cost as to which metal shall be adopted. Steel being a stronger metal than iron, masts of equal strength would weigh less if

constructed of the former than of the latter metal. The great, and not altogether unfounded distrust felt towards steel in the present state of its manufacture, has prevented its adoption from making such rapid progress as it was once thought it would.



Tripod Masts of Iron.

Actual use in war and in stormy weather will be necessary, however, to determine all the relative advantages of iron and steel for masts.

The subject of the stability of iron masts is treated with much fulness by Mr Lamport, in a Paper read before the Institute of Naval Architects in 1863.

**MATIN DOG**, a large kind of dog, now almost peculiarly French; but supposed to have been introduced into France from the north of Europe. It is allied to the Danish dog. It has rough hair; a rather flat forehead; a rather pointed muzzle; the ears erect, but bent down at the tips. It is generally of a whitish colour, clouded with brown. It is fierce, but not very courageous. Buffon, without reason, imagined it to be the original of many kinds of dog.

**MA'TSUMAI**, a town and port of Japan, and the largest centre of commerce and population in the island of Yesso. It is on the south coast, about 60 miles west of Hakodadi, and contains, it is said, 60,000 inhabitants. It extends along the margin of an open bay, facing which is an island with a beacon, sheltering a harbour capable of receiving the largest ships.

**MAURICE** (DUKE and afterwards ELECTOR) OF SAXONY, eldest son of Duke Henry of the Albertine line (see SAXONY), and nephew of Duke George (q. v.) the Bearded, the most bitter opponent of the Reformation, was born at Freiberg, 21st March 1521; espoused, in 1541, Agnes, daughter of the Landgraf Philip of Hesse; and later in the same year, succeeded his father in the duchy of Saxony and its dependencies. He was hardly well established in his dominions, till a dispute arose between him and his cousin, the Elector John Frederic, regarding their respective rights over the bishopric of Meissen, which was the common property of the Ernestine and Albertine lines; but by the influence of Luther

and of the Landgraf Philip, a temporary reconciliation was effected. M. took part in the campaign of 1542 against the Turks in Hungary, and gave such signal proof of military talent, that the Emperor on his return eagerly pressed him to accept a command in the armies on the western frontier of Germany. M. was nothing loath to continue his military career, but insisted on obtaining the protectorate of the bishoprics of Magdeburg and Halberstadt, in recompense of his services; a stipulation to which Charles would not consent. M. accordingly returned to his duchy, and though still on the most friendly terms with the Emperor, took part in the deliberations of the Protestant League of Schmalkald (q. v.), being himself a professed Protestant, and the son-in-law of one of the chiefs of the League. He refused, however, though agreeing with the objects of the League, to become a member; and the judicious gift to him by the Emperor of the much-coveted protectorate above mentioned, and subsequently (19th June 1546), a solemn deed of the Emperor at Ratisbon, by which the Ernestine portion of Saxony and the electoral title were transferred from John Frederic to M., secured the latter's energetic support. When Charles, at the commencement of the war, was cooped up in Southern Germany by the army of the League, M., by invading the Saxon electorate, compelled the Protestants to retire northwards, thus relieving the emperor, and enabling him to subdue Swabia and the Upper Rhine districts. But by this manoeuvre he drew an overwhelming attack upon himself, and was driven by the incensed John Frederic from the electorate, deprived of his own dominions, and reduced to extremity. At this critical moment, the Emperor came to his aid; and M. and the Duke of Alva (see ALBA), at the battle of Muhlberg, annihilated the elector's army, and took himself prisoner. M. was now, in accordance with the previous agreement, ruler of the whole of Saxony, with the electoral dignity; and having obtained from the Emperor all the gratification of his ambitious desires which could be hoped for from that quarter, their friendly relations became more dependent upon the course of events. The retention in confinement of Philip of Hesse, whom M. had prevailed upon to submit to the Emperor, was the first cause of estrangement; the incessant attempts of the Emperor to increase, by modifications of the imperial system, his own preponderance in Germany, supplied another; and though the new elector zealously supported the Interim (q. v.) of Augsberg in 1547, he gradually came to see that his close alliance with the Emperor was alienating from him the affections of his Protestant subjects. He accordingly at once abandoned the cause of the Emperor with as little scruple as he had formerly sacrificed the interests of his relatives and co-religionists; and, in common with the princes of Kulmbach and Hesse, secretly sent (May 1551) agents to Paris and London to negotiate an alliance against Charles V., while he leisurely carried on the siege of the rebellious city of Magdeburg, in order to have a pretext for keeping an army afoot. Meanwhile, Charles, at Innsbruck, was employing himself in building up vast schemes of ambition, little dreaming of the mine which the man whom he most of all confided in was preparing to spring under his feet; till the manifesto, or rather ultimatum of the Protestant princes, in which they demanded the release of Philip of Hesse, and the total abolition of the arbitrary authority of the imperial government; and the capture by them of Augsberg, while their allies, the French, took Metz; rudely drew away the veil from his eyes. Without money, without troops, without allies, nothing but a secret flight from Innsbruck appeared open to him; but he had only got as



far as Füssen (a town on the Lech, on the borders of Bavaria and the Tyrol), when the news that M. was marching in this direction, forced him to hasten again to Innsbruck. On April 18, by the mediation of Ferdinand, king of the Romans, a treaty was concluded at Linz granting the demands of the Protestants; but as it was not to take effect till May 26, M. employed himself in attacking (May 18) the camp of Reitti, in which soldiers were being assembled for the Emperor, defeated and wholly dispersed the imperialists, and advanced on Innsbruck with the view of taking Charles captive, when his progress was stopped by a mutiny in his army; and the Emperor escaped. His advance on Innsbruck so alarmed the members of the Council of Trent, that they fled from the town, and the sittings were thenceforth suspended for some years. Finally, at a convocation of the electors and princes of the empire at Passau, the terms of a treaty of peace were discussed, M. directing the cause of the Protestants, and Ferdinand attending to the imperial interests; and it was ultimately agreed that Protestants were free to exercise their mode of worship; that the imperial chamber, from which Lutherans were not to be excluded, should render justice irrespective of religion; and that the Aulic Council should be composed exclusively of German ministers. These conditions, which in political matters secured 'Germany for the Germans,' and in religious affairs permanently established the principles of toleration, were embodied in the agreement called the *Peace of Passau* (22d August 1552). The bitter dislike conceived by the Emperor towards M. on account of these transactions, prompted him to entertain the idea of deposing him from the electorate, and reponing John Frederic; of which scheme, M. being apprised, he, with his usual subtlety and address, patched up a reconciliation with the Emperor, and went to take part in the campaign of 1553 against the Turks, who were gradually gaining ground in Hungary. Returning soon, he found that one of his former allies, Albert, Markgraf of Kulmbach, had refused to accede to the treaty of Passau, and continued the war on his own account, making raids on the ecclesiastical princes of the Rhine and Franconia. M. speedily discovered that the markgraf's apparent obstinacy was the fruit of a secret understanding with the Emperor, who was anxious to secure the services of a general and army capable of wreaking his vengeance on the perfidious Saxon prince. So, about midsummer of 1553, M., putting himself at the head of 20,000 men, marched to protect his bishopric of Magdeburg against the ecclesiastical spoliator, and falling in with him at Sievershausen, completely defeated him (9th July), but received in the conflict a bullet-wound which proved fatal, July 11, 1553. Thus fell, at the early age of 32, a prince who had already established his reputation as one of the ablest generals and diplomatists of his time. So thoughtful and reticent, so enterprising and energetic, so correct in judgment and unflinching in action, and at the same time so wholly devoid of moral sentiment, he is one of the most prominent instances of power without principle which the world's history has ever presented. His calculating, plotting mind was concealed under a jovial exterior, and a genuine fondness for the favourite pastimes of the age. Yet this unprincipled dissimulator's states were the best governed of the empire; the great vassal was equal with the meanest peasant in the courts of justice; great advances were made in education; and though the least religious man of the time (in fact, honest only in this point, that he did not pretend to a piety which he did not feel), the rights of the various religious sects were strictly maintained. He died at an epoch

which was big with the fate of Germany; for his settled programme of action was, after defeating the markgraf, to march upon the Low Countries, unite with the French, with whom he had formed a firm alliance against the Emperor, and then attack the latter. Charles V. would have had apparently little chance of offering a successful resistance to such an overwhelming attack.—See the biographies of this remarkable man by Reutter, Camerarius, Arnold, Schleukert, and Langenn.

His surviving daughter, Anne, became the wife of William of Orange, the liberator of the Netherlands.

**MAXIMILIAN, EMPEROR OF MEXICO**, otherwise FERDINAND MAXIMILIAN JOSEPH, Archduke of Austria, was born on July 6, 1832. He was the son of the Archduke Francis Charles, and the younger brother of Francis Joseph I, who became Emperor of Austria in 1848, by virtue of acts of abdication and renunciation by his uncle and father. M., who received a careful education, and showed himself an apt pupil, entered the Austrian navy, and while in that service, visited Italy, Spain, Algeria, Albania, and Madeira, all of which are admirably described by him in a work mentioned below. He married on July 27, 1857, Charlotte Marie Amélie, born June 7, 1840, a daughter of Leopold I, king of the Belgians. After holding for a time the rank of vice-admiral, he abandoned the navy, and became governor of the Lombard Venetian Kingdom. In this post, he became a popular idol—thanks to his fine person, affable and graceful manners, and the conscientious manner in which he discharged his arduous duties. In 1861, he was named President of the Upper House; but he resigned the office in the same year, and shortly afterwards visited England. At this period, events were taking place in America destined to bring him into more prominent notice. In 1860, the office of President of Mexico had devolved upon Benito Juarez, as chief judge in the supreme court. He had just triumphed over the clerical party, after a struggle of three years' duration. The confiscation of church property, and the suspension of the payment of European debts—measures now admitted to have been unavoidable—served as a pretext for an appeal on behalf of the Mexican clergy for European assistance. The French were induced to interfere, perhaps in the belief that the whole population was opposed to the liberal government. The French general, with the heads of the Mexican church and army, when the city of Mexico had been taken, called together what they described as an Assembly of Notables; and this body, in July 1863, decided that a monarchy, not a republic, was the form of government best suited to the interests and character of the people of Mexico. M. was pointed out as the European prince who by his birth and character would most worthily wear the crown, and a deputation was appointed to offer it to him. Few expected that he would entertain the proposal, but he did so on consideration of duty. He insisted, however, on having evidence that the population were in his favour. This was easily obtained, the political and municipal offices having been filled by Conservatives appointed by the French; and the scruples of M. were overcome. On April 9, 1864, he signed a family pact, by which he renounced, under certain conditions, his rights as an Austrian prince; and on the following day, he solemnly accepted the crown of Mexico. On the 14th, he set sail for his dominions. On June 12, he entered Mexico. He was of course warmly welcomed by the clergy and the army; but he soon found that they and he could not agree. They expected him to sanction abuses which he felt bound,

as an honest man and enlightened prince, to condemn openly as gross scandals. The Liberals, on the other hand, found him an ardent supporter of all the principles they had for a generation been contending for, and he gained their support. He formed a Liberal cabinet, including even some of those who had been ministers under Juarez. His laborious habits, practical acquaintance with administration, and exemplary life, secured the esteem and support of many persons who had stood aloof from party disputes; and his position was still further improved by the influence of the empress with the educated classes of the capital. For a time, all went well, and M. devoted his whole energy to inquiries into grievances, the promotion of banking and railway projects, and a scientific commission in which he took a deep and special interest. The great mistake he made was to hear and attempt to reconcile Mexican parties, who had no other object in view than power and place. He could not restore to the clergy their confiscated estates, but he sought to appease them, and was pronounced a traitor. Then all reform of the finances was prevented by the French demands for compensation, and this difficulty brought him into collision with the Liberals. Their opposition was unfortunately confirmed by a proclamation he was induced to make on October 2, 1865, threatening to punish with death under the laws of war all who offered resistance to the government, the republic having ceased not only by the will of the nation, but by the expiration of the administration of Juarez, and his flight to the United States. This decree he was told was asked for merely to suppress brigandage, but it was employed both by the Imperialist and French commanders as a sanguinary edict, under which many estimable Liberal officers were cruelly shot as robbers. The northern states of Mexico had always retained a sort of independence before the foreign occupation of the southern provinces, and the French had not reduced them to subjection. There Juarez and his followers again raised the standard of independence, and harassed the French army. At the same time, the success of the North in the American war, and the dissatisfaction of the French people with the cost of the Mexican expedition, compelled Louis Napoleon to contemplate the withdrawal of his troops. In vain the empress went to Europe to enlist support for her husband, who had lost all his private fortune. She found that he had proved too honest for some of his old friends, and her reason gave way under the continued grief and excitement brought on by disappointment. The Belgians and Austrians would have replaced the French legions, but the threats of America compelled them to abandon the enterprise. The French, too, were compelled to retire, and they were undoubtedly most anxious that M. should leave with their troops; but he felt bound as a man of honour to remain, and share the fate of his followers. In doing so, he placed himself at the head of a Mexican faction without the excuse of subjection to the French. At the head of 10,000 men, he made a brave defence of Queretaro against a Liberal army under Escobedo. On the night of May 14, 1867, General Lopez betrayed him. This man whom he believed to be his dearest friend, gave up to Escobedo one night the strongest position in the imperial encampment—that where the emperor slept. The Mexican officer who took possession tried to induce M. to escape as a civilian; but he declined to do so, at the risk of compromising even an enemy. The Liberal Minister of War ordered M. and Generals Miramon and Mejia to be tried by court-martial; and it was in vain the European ministers protested against this breach of the

laws of civilised warfare. How far Juarez interfered on behalf of M. is not well ascertained, but certain it is that he at length acquiesced in the decision of his cabinet. The court-martial consisted of a president, aged 23, and six other members, between the ages of 18 and 20. The trial was of course a mere farce, and the charges chiefly rested on the proclamation above referred to and the executions which followed it. At seven in the morning of July 19, the three prisoners were removed in carriages to the place of execution. Four soldiers were detailed for each prisoner, and it was arranged that all should be shot at the same time. M. said to those present that he forgave all, as he hoped to be forgiven, and that he trusted his blood would be for the good of Mexico. He then placed his hand on his breast, to shew the soldiers where to fire, and opened his arms. The soldiers fired at once. Miramon died immediately. The emperor was wounded by the four balls; but he did not die till three unavailing attempts had been made to terminate his sufferings. The poor Indians who were present at the execution wept aloud, and rushing forward, wiped up every drop of blood which fell. The account given of the execution by the emperor's servant Tudos, and confirmed by other eye-witnesses, filled Europe with indignation, and exposed the Mexican Liberals to abuse not altogether merited. Since the death of M., his writings have been collected, and published under the title of *Aus Meinem Leben, Reiseskizzen, Aphorismen Gedichte, &c.* (7 vols. 1867). This work is remarkable for its elegance of style, and it gives ample evidence of the ability and varied attainments of the author, of his good sense, enlightenment, candour, generosity, and scorn for every kind of meanness. After some delay, the body of M. was given up to his relatives, and was conveyed to Europe in an Austrian frigate.

MAYMEMÉ, a city of Bokhara, capital of a khanat of the same name, about 200 miles north of Herat, on a river flowing north towards the Jihun, but only part of which has as yet been traced. It consists of about 1500 mud huts, a frail bazaar built of brick, three mosques of mud, and two *medresse*, or colleges, of brick. It is considered by the natives to be a powerful stronghold, but its only defences are a simple wall of earth around the city, 12 feet high, and 5 feet broad; and a citadel surrounded by a fosse, and situated upon a conspicuous hill of steep ascent. The people of the town, as well as those of the khanat, are bold and fearless riders, and of resolute, warlike character. According to Vámbéry, he who would wish to take Bokhara must destroy M., or be sure of its friendly feeling.—Vámbéry's *Travels in Central Asia*.

MAYOTTA, one of the Comoro Isles (q. v.), ceded to France in 1843, lies in lat. 12° 34'—13° 4' S., and long. 44° 59' 15"—45° 23' E. It is of irregular form, and measures 21 miles from north to south, with an average breadth of six or seven miles: if, however, the dangerous coral reefs which surround the island be included, the whole occupies a space of 30 miles north and south, and 24 miles east and west. The surface of M. is very uneven, and is studded with volcanic-looking peaks, some of which exceed 2000 feet in height. The shores of the island are in some places lined with mangrove swamps, which are uncovered at low water, and are productive of malaria and fever. The island is in most parts capable of cultivation, and contains several sugar plantations. In 1865, there were produced 39,079 cwts. of sugar; and the total exports for that year were valued at £45,359. It is principally sugar that is exported; and the supply of food

grown on the island is insufficient for the use of the inhabitants. The total imports for the year 1865 were only in value £21,954. As a colony, M. has certainly not fulfilled the expectations entertained by the French at the time of its occupation, notwithstanding the unusually liberal terms held out to the colonists. The French establishment is on the island of Zaondzi, inside the chain of reefs on the east side of M., and consists of a governor, colonial officer, some artificers and seamen, and about 100 soldiers, besides a few native ones. There are several substantial government buildings and store-houses, and numerous huts. There is a good roadstead, and the fort has been recently fortified. M. is the only refuge for French ships in the Indian Ocean. It is the principal market for the neighbouring islands. Pop. about 8000.

**MAZAMET**, a town of France, dep. of Tarn, 43 miles east-south-east of Toulouse, on the Arnette, a feeder of the Tarn. It has extensive woollen manufactures and cloth-fairs. Pop. (1872) 10,500.

**MAZARRON**, or **ALMAZARRON**, a seaport town of Spain, in the province of Murcia, 27 miles west-south-west of Cartagena, on the coast of the Mediterranean. The inhabitants are employed in fishing and mining—silver ores and alum being found in the neighbouring hills. Much barilla is made here. From the number of ruins found in the vicinity, this is supposed to have been the site of an important Carthaginian settlement. Pop. about 7000.

**MAZUFURABAD**, a town of India, in the Punjab, about 200 miles north-north-west of Lahore, at the confluence of the Jhelum and its great tributary, the Kishengunga, over both which rivers there are ferries. It is of importance chiefly on account of its commanding position at the entrance of the Baramula Pass into Cashmere. The Emperor Aurungzebe built a fort here, which was subsequently replaced by one of greater strength, erected by the Afghan governor, Ata Mahomed.

**MEDE'AH**, a town of Algeria, 43 miles south-west of the town of Algiers, consists of a walled town and suburbs. It is considered as, on the whole, one of the finest towns in Algeria. There is an Arab market held every Friday. Under the Romans, M. was a military station. Pop. within the walls, 2100; without the walls, 5700; total, 7800.

**MEDINA DE RIO SECO** (anc. *Forum Equestrorum*), a town of Spain, in the province of Valladolid, 22 miles north-west of the city of Valladolid, on the Sequillo, an affluent of the Douro. This place was a famous emporium in the 14th c., when its cloth and linen fairs were amongst the greatest in the kingdom; it is now a place of little or no importance whatever. There still exist some remains of its former greatness, in its arcades, arches, ruins of a palace, &c. In 1808, the town was given up to pillage by Bessieres. Pop. 5100.

**MEERANE**, a prosperous manufacturing town of Saxony, in the circle of Zwickau, ten miles north of the town of Zwickau. Until within the last few years, it was an unimportant, small country town; but it has recently increased rapidly in size and importance, through the development of its industrial resources. Its pop. in 1849, was 7345; 1858, 11,147; 1861, 13,626; 1871, 19,187. The manufactures produce, almost exclusively, woollen and mixed fabrics; and employ about 15,000 looms, of which about 3000 are in the town itself, and the rest elsewhere. There are upwards of 100 manufactories, the yearly products of which are estimated at upwards of £2,000,000. A large export trade is carried on with England, France,

and America, three of the principal firms having set up establishments in New York. There are some large tanneries in Meerane. The town itself has within the last few years been very much improved.

**MEIAPONTE**, a town of Brazil, in the province of Goyaz, about 80 miles east-north-east of the town of Goyaz, on the river Almas. In the neighbourhood are some gold mines; and the district produces millet, barley, cotton, tobacco, and sugar. Pop. 8000.

**MEKLONG**, a town of Siam, at the confluence of the Meklong river with the west mouth of the Menam, 30 miles south-west of Bangkok. Pop. estimated at 10,000. The province furnishes salt for all the kingdom.

**MELA-ROSA**, a fruit of the genus *Citrus*, and probably a variety of the Lime (q. v.), cultivated in Italy. It receives its name from its fragrance being thought to resemble that of the rose. It is a small flattened fruit, with a protuberance at the tip, from which many raised ribs proceed in a star-like form to the circumference. The skin is yellow, thin, and adheres closely to the pulp.

**MELFI**, an ancient episcopal town of Southern Italy, in the province of Potenza, 32 miles south of Foggia, on a feeder of the Ofanto (anc. *Asipides*). It is situated on a bed of lava to the north-east of the lofty (3000 feet) volcanic Monte Vulture, now extinct, from which it is separated by a deep ravine. The once magnificent cathedral, erected in 1155, was almost entirely destroyed by an earthquake in 1861, which at the same time levelled many fine buildings, public and private, and destroyed about 1000 persons. The only evidences of volcanic action are the severity of the earthquakes which occasionally desolate the district, and the emission at times of carbonic acid and other gases from the lakes in the old crater of the volcano, throwing up columns of water, accompanied by internal rumblings. This phenomenon generally takes place when Vesuvius is in a state of activity. The district around the city is celebrated for its wine. Pop. 11,225.

**MELIPOCOA**, a genus of trees or shrubs of the natural order *Sapindaceae*, one of which, *M. bijuga*, a native of the West Indies, is there universally cultivated for its fruit. It is called the **HONEY BERRY**, and the **Jamaica Bullace Plum**; by the Spaniards, *Monos*, and by the Dutch, *Kaprac*. It is from 16 to 20 feet high. The fruit is jet black, about the size of a bullace. The seeds are roasted, and eaten like chestnuts. Other species of *M.* yield eatable fruits.

**MENFI**, or **MENFRIGI**, a town of Sicily, in the province of Girgenti, 43 miles south-south-west of Palermo, crowns a long bare height, about three miles from the coast. Pop. 9900.

**MENHADEN** (*Aloea menhaden*), a fish of the same genus with the Shad (q. v.), which is caught in great quantities on the coasts of New York and New England during the summer months, when it visits them for the purpose of spawning. Its length is from 8 to 14 inches; the colour of the upper parts is greenish brown, the belly silvery, a black spot on the shoulder, the whole surface iridescent. The *M.* is not a very palatable fish, but is rich in oil, which is used by painters, and is considered superior to linseed oil. Great quantities of this fish are taken in some seasons, and are sold for manure, one fish being considered equal to a shovelful of barn-yard manure, and 2500 sufficient for an acre of land.

**MERCHANT SHIPPING ACT** of 1854 (stat. 17 and 18 Vict. c. 104), a measure which in many important respects amended, and at the

## MERCHANT SHIPPING ACT.

same time consolidated, the law of this country relative to merchant shipping. By the Merchant Shipping Repeal Act of the same year (stat. 17 and 18 Vict. c. 120), the statutes relative to merchant shipping previously in force were, with one or two unimportant exceptions, repealed; the new act, which formed an almost complete code of the laws affecting merchant-ships, coming in their place. No fewer than nine acts have since been passed, some amending, others supplementing, the act of 1854—viz., the Merchant Shipping Act Amendment Acts, 1855 and 1862 (18 and 19 Vict. c. 91, and 25 and 26 Vict. c. 93); the Merchant Shipping Act, 1867 (30 and 31 Vict. c. 124); the Colonial Shipping Act, 1868 (31 and 32 Vict. c. 129); the Merchant Shipping (Colonial) Act, 1869 (32 and 33 Vict. c. 11); the Merchant Shipping Act, 1871 (34 and 35 Vict. c. 110); the Merchant Shipping Act, 1872 (35 and 36 Vict. c. 73); the Merchant Shipping Act, 1873 (36 and 37 Vict. c. 85); the Merchant Shipping Act, 1875 (38 and 39 Vict. c. 89). A bill to consolidate and amend the law relating to merchant shipping has been brought before the House of Commons, but has not been proceeded with. The act of 1854 is divided into 11 parts; and the principal provisions of the amendment acts are referred to the part of the principal act to which they severally belong, so as to facilitate the reading of the acts conjointly. The act of 1867, with the exception of two unimportant clauses, is occupied with a single subject—the enforcement of proper sanitary conditions on board ships. The acts of 1868 and 1869, relating to colonial shipping, are not of general importance.

The general superintendence of matters relating to merchant-ships and seamen is, by the act of 1854, Part I., intrusted to the Board of Trade, which is invested with powers for compelling local bodies, and shipowners or shipmasters, to perform the duties which the Shipping Acts impose upon them.

British ships, their ownership, measurement, and registry, is the subject of Part II. of the act of 1854. And it is provided that no ship shall be deemed a British ship unless she belong wholly to owners who are of one of the following descriptions: 1. Natural-born subjects; 2. Persons made denizens, or persons naturalised in terms of an act of parliament, or an act of the legislative authority of some British possession; 3. Bodies corporate established under, subject to the laws of, and having their principal place of business in the United Kingdom, or some British possession. Every British ship, with a few unimportant exceptions, must be registered; and a ship, unless registered, though subject to all the ordinary liabilities, is not to be recognised as a British ship. The registration is to be made by the principal officer of Customs for the time being at any port or place in the United Kingdom approved by the Board of Trade for the registry of ships; and by certain specified officers in the colonies and possessions abroad. The registration is to comprise the name of the ship, which cannot afterwards be changed without permission of the Board of Trade, and the names and descriptions of the owners; also the tonnage, as ascertained by specified rules, the build, and description of the vessel, the particulars of her origin, and the name of the master. A certificate of registry, containing all the particulars registered, is given by the registrar to the master. On this certificate, changes in the ownership and changes of the master are endorsed as they occur; and a new certificate may be granted, after certain formalities, in exchange for a former one, or in the event of a former certificate being lost. The master is the person entitled to the custody of this document, and it is a penal offence to detain it from him, upon whatever pretence of right or title. The

certificate is given up to the registrar on the ship being lost, or ceasing to be British. The acts of 1871, 1873, and 1875 require certain particulars to be marked on ships in specified ways—viz., the name, the official number, the registered tonnage, a scale denoting the draught of water, the deck-line, and the load-line; and besides that there are penalties for defacing, or not maintaining such marks, and for making them inaccurately, the ship may be detained until the requirements of the law are complied with. In any case or class of cases, the Board of Trade may direct that the draught of water, and also the extent of the clear side of a sea-going ship be recorded by the officers of Customs, and the record preserved, and also marked in the official log-book. The act of 1873 provides that where a British ship has ceased, for any reason other than capture or transference to a foreign owner, to be registered, she shall not be again put upon the register without a survey to test whether she is seaworthy.

The property in every ship is, for purposes of registration, divided into sixty-four shares. No person is entitled to be registered as owner of any fractional part of a share; but any number of persons not exceeding five may be registered as joint-owners of a share. Counting joint-owners, who are not entitled to dispose in severalty of their respective interests, as constituting one person only, not more than thirty-two persons can be registered at the same time as owners of a ship. The power of disposing of the ship or its shares is vested exclusively in registered owners. Notwithstanding this, persons beneficially or equitably interested are to have their interests protected upon application to the proper court. When a registered ship, or any share therein, is disposed of to persons qualified to be owners of British ships, the transfer must be made by a bill of sale under seal, according to a form prescribed, and the names of the transferees are to be entered on the register as owners of the ship or share. Mortgages also must be in a form prescribed, and are to be recorded by the registrar upon production to him in each case of the mortgage deed.

In Part III., under the heading 'Masters and Seamen,' it is provided that local marine boards shall be established at certain ports of the United Kingdom; and that each of these shall consist of two *ex officio* members—the mayor or provost, and the stipendiary magistrate of the place—four members appointed by the Board of Trade, and six elected annually by the owners of foreign-going ships and of home-trade passenger-ships. The local marine board is required to establish an office (called the Shipping Office in the act of 1854, but now, under the act of 1862, called the Mercantile Marine Office) or offices, under the management of a superintendent (originally called shipping-master), whose duty it is to afford facilities for engaging seamen, by keeping registries of their names and character; to superintend and facilitate their engagement and discharge; to provide means for securing the presence on board at the proper time of men who are so engaged; to facilitate the making of apprenticeships to the sea-service; and to perform such other duties relating to merchant-seamen and merchant-ships as shall be committed to them by the Board of Trade. The local marine boards are also required to hold examinations for persons who intend to become masters or mates of foreign-going ships or home-trade passenger-ships. And no person can be employed in a foreign-going ship as master, or first, or second, or only mate, or in a home-trade passenger-ship as master, or first or only mate, unless he holds a certificate of competency obtained at such an examination; or else a certificate of service

## MERCHANT SHIPPING ACT.

obtained in virtue of his having held a certain rank in the royal navy, or certain employment in the merchant service previous to the passing of the act of 1854, as specified in the act. The act of 1862 extended the requirement of a certificate from the Board of Trade to engineers employed in steamships. There are first and second class engineers' certificates, and an engineer cannot be employed unless he holds the one or the other—according to his employment and the engine-power of the ship—obtained at an examination, or else in consideration of his service previous to 1862, or of the rank he has held in the royal navy.

The master of every ship, excepting ships of less than eighty tons burden, exclusively employed in the coasting-trade, is required to enter into an agreement—in a form prescribed by the Board of Trade—with every seaman whom he takes to sea from any part of the United Kingdom. This document, which must be signed by the master and by the seaman, sets forth the nature and duration of the voyage; the number and description of the crew; the time at which each seaman is to be on board, or to begin work; the capacity in which he is to serve; the amount of his wages; a scale of provisions; regulations as to conduct; and such punishments for misconduct as the Board of Trade shall have sanctioned, and as the parties shall have agreed to adopt. In the case of foreign-going ships, the agreement must be made before, and be attested by the superintendent of the Mercantile Marine Office; and seamen engaged abroad must be engaged, if at a colonial port, in the presence of a shipping-master or Customs officer; if at a foreign port, in the presence of the consul. The discharge of the crews of foreign-going ships must be made at the Mercantile Marine Office before the superintendent, to whom the ship-master must deliver a full account of the wages due to each seaman, and of all deductions made from them. It is enacted that no right to wages shall be dependent on the earning of freight; and that every stipulation on the part of the seaman for abandoning his right to wages in the event of the loss of the ship, shall be inoperative. Previous to 1872, time agreements with seamen in home-trade ships could not be made for a longer period than six months. This provision was repealed by the act of that year. The act of 1873 provided that in an agreement with seamen, it should only be necessary to state the maximum period which the agreement is to cover, and the places or parts of the world, if any, to which the voyage is not to extend. Some provision was made in the act of 1854 as to the amount of space to be set apart for the accommodation of every seaman, as to the maintenance of the sleeping-places in a proper state of order and ventilation, and as to the supply of medicines for the voyage; but the clauses of that act relating to these subjects have been repealed, and fuller provision for them has been made by the act of 1867. In this act, special precautions have been taken to insure that ships take to sea with them a sufficient supply of lime-juice and other anti-scorbutics; and the local marine boards are empowered to appoint medical inspectors to examine seamen applying for employment, if the ship-master desires it.

The act of 1854 provided for the establishment in the port of London of a general register and record office for seamen, under the management of a registrar-general of seamen; and required returns to be made to this official by the officers of Customs, and through superintendents of mercantile marine offices, by masters of ships both in the home and in the foreign trade, from which a general view might be had as to the state of our mercantile marine. Official log-books, in forms prescribed,

are required to be kept in every ship, other than those exclusively employed in the coasting-trade, either in connection with or distinct from the ordinary log-book; and in these, entries must be made of numerous specified occurrences. Provision is made for the punishment of offences against discipline and good-conduct committed either by seamen or by ship-masters, and for the trial in this country of persons charged with any crime committed upon the high seas. The act of 1871 provides that where seamen are charged with deserting or refusing to join a ship, or refusing to go to sea, and a fourth of the crew, or five or more of the crew, if the number of the crew is twenty, allege that the ship is from any cause, as unseaworthiness, overloading, improper loading, or defective equipment, not in a fit condition to proceed to sea, or that the accommodation of the ship is insufficient, the court before which they are charged may order the ship to be surveyed, and unless the opinions of the surveyor be disproved, shall act upon them; the shipowner or the accused paying the cost of the survey, according as the defence is sustained or overruled. Where the defence is sustained, the court may, under the act of 1873, make an order for compensation to be paid by the ship-owner or ship-master to the seamen. The Board of Trade may suspend or cancel the certificate (whether of competency or of service) of any master or mate (1) if, after investigation, he is reported to be incompetent, or to have been guilty of any gross act of misconduct, drunkenness, or tyranny; (2) if, after investigation, it is reported that the loss or abandonment of, or serious damage to any ship, or loss of life, has been caused by his wrongful act or default; (3) if he is superseded by the order of any Admiralty court, or naval court held abroad under the provisions of the act; or (4) if he is shown to have been convicted of any offence.

In Part IV., under the head of 'Safety and Prevention of Accidents,' rules are laid down as to the boats and life-buoys which are to be carried by sea-going ships; and it is provided that the officers of Customs shall not grant a clearance to any vessel by which those rules have not been complied with. As to the use of lights and fog-signals on board ships at sea, the regulations now in force are contained in the schedules of the act of 1862; where is also laid down the rule of the road for preventing collisions between ships meeting each other at sea. Under the acts of 1871 and 1873, ships which come into collision are required to exchange names, and give other information necessary for identification; and if, after the collision, one of the vessels does not stay by and give assistance to the other, it is deemed to have been in the wrong. The person in charge of it may be prosecuted for a misdemeanour, and have his certificate cancelled. Wherever one of two vessels which have been in collision has infringed the regulations of the Shipping Acts, it is to be deemed in the wrong unless circumstances are adduced which disprove this presumption. Certain stringent provisions are made as to the build and equipment, and also as to the surveying and certificating of steam-ships. The act of 1872, which transfers to the Board of Trade the powers exercised under the Passenger Acts by the Emigration Commissioners, and, in certain cases, by the Home Secretary, requires that passenger-steamers should undergo survey at least once a year. Under the acts of 1871, 1873, and 1875, the Board of Trade is enabled, either on the information of complainants, or of its own motion, to order any vessel to be surveyed, and after survey to declare it unseaworthy, and to make an order for its detention, or for its release, only on the fulfilment of such

conditions as the Board may prescribe. The owner or master of the vessel must be furnished with a copy of the surveyor's report on which the order of the Board of Trade has proceeded, and he may appeal to the local court having Admiralty jurisdiction, the decision of which is final. The owner of a vessel detained pays the cost of the survey, and complainant whose case has not been substantiated, pays the cost of the survey, and is liable in compensation to the owner of the vessel; the Board of Trade also is liable in compensation to the owner when it has acted of its own motion, and unseaworthiness has not been established. The act of 1875 also contains the following provision (s. 4): 'Every person who sends to sea, or is a party to any attempt to do so, and every master who knowingly takes to sea, a ship in such unseaworthy state, that the life of any person would be likely to be thereby endangered, shall be guilty of a misdemeanour. Burden laid on the accused of proving that he did all he could to insure seaworthiness, or the ship going to sea in such unseaworthy state was, in the circumstances, reasonable and justifiable.' Any person prosecuted under this provision is enabled to give evidence on his own behalf. The act of 1873 contains provisions as to the carriage of dangerous goods, and goods suspected of being dangerous; and the act of 1875 provides for the carrying of grain.

For the provisions as to pilotage, in Part V., we refer to the acts themselves. See also *PILOT*.

Part VI. deals with the subject of light-houses. See *LIGHT-HOUSE*; *TRINITY HOUSE*; and *NORTHERN LIGHT-HOUSES* in *SUPPLEMENT*, Vol. X.

Part VII. relates to the Mercantile Marine Fund.

Part VIII. makes provision for cases of wreck, casualties, and salvage. An inquiry is to be made whenever any ship is lost, abandoned, or materially damaged on or near the coasts of the United Kingdom; or causes loss or material damage to any other ship on or near such coasts; whenever, by reason of any casualty on board of any ship, on or near such coasts, loss of life ensues; and whenever any such loss, abandonment, damage, or casualty happens elsewhere, and any competent witnesses thereof arrive at any place in the United Kingdom. This inquiry is to be made by the inspecting officer of the Coastguard, or the principal officer of Customs of the place at which the occurrence in question happened, or of the place at which competent witnesses of it arrive, if it has happened abroad, or can be conveniently examined; or by some other person appointed for the purpose by the Board of Trade. Such officer or person, if he thinks fit, or if the Board of Trade so directs, may have the matter formally investigated before two justices or a stipendiary magistrate; and the Board of Trade may appoint some person of nautical skill and knowledge to act as assessor to such justices or magistrate. If the conduct of any master or mate is in question, the magistrates may require him to deliver up his certificate pending the inquiry; and the certificate may be cancelled or suspended by the Board of Trade upon their report. The Board of Trade has the general superintendence of all matters relating to wreck, and has power to appoint a receiver of wreck in any district.

Part IX. relates to the liability of shipowners; and the provisions of the principal act have here been materially altered by the act of 1862. Under the act of 1862, the owners of any ship, whether British or foreign, are not answerable in damages for any loss of life or personal injury to persons carried in the ship; for any damage or loss caused to any goods on board the ship; for any loss of life or personal injury by reason of the improper navigation of the ship caused to any person carried in any

other ship; or for any loss or damage similarly caused to any other ship, or the goods on board of it, when such loss, or injury, or damage happens without their actual fault or privity, except as follows: Where loss of life or personal injury has occurred either alone or together with loss or damage to ships and merchandise, they are liable to the extent of £15 for each ton of the ship's tonnage; where there is loss or damage only of ships or merchandise, they are liable to the extent of £3 per ton. The tonnage, on account of which the liability in these cases is to be calculated, is, in the case of sailing-ships, the registered tonnage, and, in the case of steamships, the gross tonnage, without deduction on account of the engine-room; and the tonnage of foreign ships is to be estimated according to the rules of measurement laid down for British ships. The act of 1854, however, provided that the owners of sea-going ships should be liable in respect of every loss of life, personal injury, loss of or damage to goods which may arise on distinct occasions, to the same extent as if no other loss, injury, or damage had arisen; and this provision is still in force. In cases of loss of life or personal injury, the act of 1854 empowers the Board of Trade to institute an inquiry, and provides in detail for the recovery of damages before the sheriff and a jury. The damages are to be assessed at not more than £30 for each case of death or personal injury. These are to be paid to her Majesty's Paymaster-general, and to be distributed by him as the Board of Trade directs; the Board having power to direct payment of such compensation, not exceeding the statutory amount, as may be thought fit. A person dissatisfied with the amount of damages awarded to him may bring his action in the ordinary courts, but he is liable in the costs of the action unless he recover a sum exceeding double the statutory amount.

Part X. of the act of 1854 lays down the legal procedure to be taken in cases arising under the act; and part XI. deals with several miscellaneous matters of no general importance. The act of 1862 provided that foreign ships within British jurisdiction shall be subject to the rules for preventing collisions applicable to British ships. The final issue of Mr Plimsoll's indefatigable labours was the passing of the Act to amend the Merchant Shipping Acts, which became law in August 1876. Here provision is made for the detection of unseaworthy ships, to prevent overloading, to secure that all deck cargoes shall be included in the tonnage, and that grain cargoes shall not be carried loose in bulk, but shall be kept from shifting either by boards or bulkheads or by being carried in sacks. The act of 1873 provides for the application, by order in Council, of all the provisions of the Merchant Shipping Acts to foreign vessels, the states to which they belong assenting. The act of 1862 contains the law on the subject of delivery of goods and lien for freight (for which see *LIEN*).

**MERIDA**, a town of Venezuela, South America, capital of a province of the same name, about 60 miles south of the lake of Maracaybo. It was formerly the largest and one of the most important cities of Venezuela; but in 1812 it was almost wholly destroyed by an earthquake, from which misfortune it has somewhat recovered, and is again in a flourishing condition. Pop. 6000.

**MERIMÉE**, **PROSPER**, novelist, historian, and archæologist, was born at Paris, September 28, 1803. His father, Jean François Leonore, was a painter of distinction, and secretary to the *École des Beaux Arts*. The son entered the College of Charlemagne, kept terms as a law-student, and

became early acquainted with English and Spanish literature. The influence of Shakspeare, Calderon, and Goethe was then making itself felt in France, and the Romantic School, headed by Victor Hugo, was contending for the possession of the stage against the classic traditions of Racine. M., a devotee of the new sect, published under a double disguise his first work, *Le Théâtre de Clara Gazul*, a collection of studies for the stage, professing to be translated from the Spanish by a certain Joseph L'Estrange. This work raised great expectations, which were never realised. M. did not become a dramatist, and one of these pieces failed when represented in 1850. His next publication, also pseudonymous, *La Gazul*, by *Hyacinthe Maglanovitch*, was an effort to embody the spirit of the popular lays of Illyria and Montenegro. It was written to meet the then prevailing rage for Slavonic poetry, and the materials were taken at second-hand. It was, however, admired in Germany, and received the approval of Goethe. M. now became a regular contributor to the *Revue de Paris* and the *Revue des Deux Mondes*; and after one or two more anonymous efforts, signed his name to *Tamango*. After the revolution of July, he entered public life, and before long was made Inspector of Historical Monuments, and in that capacity visited many parts of France, publishing the results of his researches in a series of Reports. During all this time, he continued to write for his favourite *Revue*s a series of romantic tales, in which terrible, almost repulsive subjects are handled with wonderful realistic power, and in a style singularly clear, condensed, and vigorous. This series, in which the *Etruscan Vase* and the *Capture of the Redoubt* are especially noteworthy, culminated in *Colomba* (1841), written by him when fresh from Corsica, and its tale of vengeance. After this, his greatest and (with the exception of *Arène Guillot*, and *Carmen*) his last romance, M. applied himself to historical researches. The *Conspiracy of Catiline* and the *Social War*, studies of Roman history, preliminary to a *Life of Cæsar*, on which he is said to have been occupied many years, appeared in 1844. In this year, he was elected to the chair in the Academy vacated by the death of C. Nodier. His *History of Dom Pedro the Cruel* (1848), dedicated to the Countess of Montijo, the mother of the Empress Eugénie, has been translated into English (1850), and reviewed in the *Edinburgh*. After the fall of the Orleans dynasty, he was placed on the Commission to draw up an inventory of the art treasures left by them in France. In 1854, he published his *Falsé Demetris*, an episode of early Russian history, the preface to which was written in prison, where he was sent for criticising, in the *Revue des Deux Mondes* (1852), the sentence passed on his old acquaintance, M. Libri (q. v.), a sentence which he tried to get reversed in the senate, June 11, 1861. M. has also translated from Pushkin and Nicolas Gogol. Among his latest writings may be mentioned an introduction to Marino Vretro's *Poetry of Modern Greece* (1855), two brief articles in the *Revue des Deux Mondes* (1864); and *Lettres à une Inconnue* (1873; Eng. trans. 1874). M. was made a senator in 1853; president of the commission for reorganising the Bibliothèque Impériale in 1858; Commander of the Legion of Honour, April 12, 1860. He was also one of the ten *membres libres* of the Académie des Inscriptions. He died October 1870.

MESTRE, a town of Northern Italy, in the province of Venice, and 5 miles north-west of the city of Venice, on the margin of a lagoon. It is connected with Venice, Padua, and other places by railway. There are many villas around the town

and along the road to Padua, reaching almost to that city. M. has a considerable transit-trade. Pop. 8500.

**METEORS.** The whole subject of meteors was treated in the body of the work under the head of **ASTROLITES**. The subject, however, has since occupied a great deal of attention, and there is at present a tendency on the part of astronomers and physicists to separate that class of meteors known as 'shooting-stars' from the group of *meteorolites* (which includes *aéro-siderites*, or masses of meteoric iron; *siderolites*, which are conglomerates of iron and stone; and *astrolites*, which are wholly of stone), on the grounds, that the most prominent appearances of the former are *periodic*, while the latter seem to occur at irregular intervals, and that the former have hitherto not been proved to leave any traces of their visit on the earth's surface. We are, however, hardly as yet in a position to decide as to the similarity or dissimilarity of the two classes of bodies.

Popular interest has been largely aroused respecting 'shooting-stars,' by reason of the brilliant display of them which took place on the night of November 13, 1866. This 'star-shower,' the grandest that has ever been observed in Britain, was confidently predicted, from the occurrence of a similar shower at the corresponding date in 1799, 1833, and 1834; and the extremely favourable state of the atmosphere rewarded those who were on the watch with a complete view of one of nature's most magnificent displays. The shower commenced about 11½ P. M., with the appearance at brief intervals of single meteors; then they came in twos and threes, steadily and rapidly increasing in number till 1½. 13m. A. M. on November 14, when no fewer than 57 appeared in one minute. From this time, the intensity of the shower diminished gradually, wholly ceasing about 4 A. M. The total number of meteors which at that time came within the limits of the earth's atmosphere was estimated at about 240,000, and the number seen at each of the several observatories in Britain averaged nearly 6000. This star-shower, like those of 1833 and 1834, seemed to proceed from the region of the heavens marked by the stars ζ and γ in the constellation *Leo*; and it has been shewn by astronomers that this was the point towards which the earth in her orbit was moving at the time; consequently, she had either overtaken the meteoric shower, or had 'met' it proceeding in a contrary direction. The meteors on that occasion presented the usual variety of colour, size, and duration; the great majority were white, with a bluish or yellowish tinge; a considerable number were red and orange; and a few were blue; many surpassed the fixed stars in lustre, and some were even brighter than *Venus* (the most brilliant planet as seen from the earth) at her maximum. Most of the meteors left trains of vivid green light 5–15' in length, which marked their course through the heavens, and endured for 3" on an average, then becoming dissipated; though some of the trains were almost 40' in length, and remained in sight for several minutes. Professor *Airy* observed that the direction of the meteors' flight was little influenced by the earth's attraction.

On the morning of November 14, 1867, a star-shower equal in magnitude to that of 1866 was observed in France and America, but was almost wholly invisible in Britain, on account of the cloudy state of the atmosphere.

The brilliant display of 1866 gave a vigorous impulse to the astronomical investigation of shooting stars, and it is now generally agreed that the November meteors move in an orbit round the sun, inclined at about 7° to that of the earth,

## METEORS—METHYLENE.

and that, in all probability, this orbit forms a ring or belt of innumerable small fragments of matter, distributed with very variable density of grouping along it, thus corresponding so far to the Planetoid (q. v.) group between Mars and Jupiter. It is also agreed that the motion of this meteor ring round the sun is retrograde; that the earth's orbit at that point where she is situated on November 13—14, intersects this ring; and that, probably, in 1799, 1833—1834, and 1866—1867, it is the same group of meteors which has been observed; and the last-mentioned hypothesis has been made the foundation of a calculation of the probable orbit and periodic time of this meteor-ring. The fact that a November star-shower generally occurs for two years in succession, and then recurs at an interval of 32 or 33 years, seems to indicate that though the earth may pass through the meteor-orbit every year, the meteors are so grouped at intervals along the ring, and their periodic time differs so much from that of the earth, that it requires 32—33 years before this accumulating difference amounts to a complete revolution of either the earth or the ring, and a repetition of the star-shower becomes possible.

Professor Newton of Yale College, America, who entered into an elaborate investigation of the subject, concluded that the 5 possible periodic times (the earth's being taken as unity) of the meteor-ring were  $2 \pm \frac{1}{12.25}$ ,  $1 \pm \frac{1}{12.25}$ , and  $\frac{1}{12.25}$ , and that of these, the fourth,  $1 - \frac{1}{12.25}$ , or 364.62 days, is the actual period of its revolution round the sun, and that, consequently, it has described 34 revolutions while the earth has described 33, the cycle of 34 meteor revolutions differing from 33 years by only 3.17 days; and in accordance with this estimate, he calculated its orbit and the approximate extent (seeing the meteor shower generally occurs in two successive years) of the meteor-group which produces the November showers. His conclusions have, however, been vigorously opposed by other eminent astronomers, such as Professor Adams (q. v.) and Mr Alexander Herschel, both of whom hold that the first four of the possible periods given by Professor Newton are impossible, and that the last,  $\frac{1}{12.25}$  (i. e., that the meteor-ring makes  $\frac{1}{12.25}$  of a solar revolution in a year, and one complete revolution round the sun in 33.25 years), is the correct estimate. If this view be correct, the meteor-group must be so much extended along its ring or orbit as to take more than a year to cross the earth's orbit, and a long time must necessarily elapse before a fair estimate of this extent can be obtained. A periodic time of 33½ years, and an orbit which at the same time approaches so near the sun as to intersect that of the earth, indicate a path of great ellipticity, akin to those of the comets; and the idea of the cometary nature of these meteors derives support from two remarkable facts, the one discovered by Schiaparelli of Milan, that this assumed orbit coincides very nearly with that of the great comet of 1862 (Professor Adams connects this comet with the August meteors), and the other by C. F. W. Peters of Altona, that it coincides with that of Tempel's comet.

Mr Alexander Herschel also maintains that the meteors are of recent origin, probably fragments from some of the great luminous bodies, and that though at present assembled in a comparatively dense group, the difference of their relative velocities will have the effect of gradually distributing them all over the meteoric ring, when a November shower will occur every year. Mr Herschel also carefully observed 20 meteors with the view of calculating their weight, from the rate of their motion and the amount of heat (as shown by their brightness) evolved in the destruction of their velocity, by the

resistance of the atmosphere, and found their weight to vary from 30 grains to 7½ lbs.

The cause of the luminosity of meteors was long a point in dispute, the two chief suppositions being, that the resistance of the atmosphere to a body dashing through it at about 30 miles per second, generated so much heat as to produce ignition; while the other was the action of terrestrial magnetism. The point most strongly urged against the first supposition, by the supporters of the second, was, that the height at which meteors were occasionally seen rendered any action of the atmosphere impossible; but as this objection was founded on the purely hypothetical opinion that the atmosphere did not extend more than about 50 miles from the earth's surface, it was not very cogent. This problem was handled by Sir John Herschel in an able paper published in the *Edinburgh Review* (January 1848), in which he clearly shewed that the very high latent heat of the air in the higher and rarer parts of the atmosphere, would be sufficient to cause an enormous development of heat in the event of the air being compressed before a body advancing into it with a 'planetary' velocity. This opinion is now held by almost all eminent men of science. The enormous heat to which the meteor is thus subject produces incandescence, after which, with more or less facility, according to the nature of the materials of which the meteor is composed, the outer portion becomes liquid, and, by the powerful resistance of the air to the meteor's rapid course, is thrown off in a long stream, forming the tail, which, after rapidly losing its velocity, is precipitated to the earth as a fine dust like volcanic ash; while the meteor thus rapidly and constantly diminishing as it flies along in its headlong course, either becomes wholly dissipated into 'tail,' falls to the earth, or makes its way out beyond the limits of the earth's atmosphere, and continues its course. This supposition of exclusive atmospheric agency also gives a plausible explanation of the phenomenon of meteors 'bursting,' this being caused by the sudden heating and consequent expansion of the outer part, while the interior was still in the state of intense cold acquired while in interplanetary space.

While astronomers and physicists in general have been thus trying to reduce the phenomena of meteors to a system, their chemical brethren have not been idle. Public collections of meteoric bodies have been made at Vienna, the British Museum, Paris, Berlin; and private ones by Mr Greg of Manchester, Baron Reichenbach in Austria, and Professor Shepard in America; and opportunities have thus been afforded of determining the nature of their composition.

METHYLENE, BICHLORIDE OF ( $C_2H_2Cl_2$ ), is an organic compound which has recently attracted much attention from its value as an anæsthetic agent. Dr Richardson, who has long been studying the physiological properties of the methyl-compounds, with the view of finding amongst them a safer compound than chloroform, believes, from his experiments on animals, that in the subject of this article he has found such a compound. As the deaths from chloroform may be computed, according to him, at one in 1500 administrations, it is obvious that there is reason for searching for a still safer anæsthetic agent. Dr Snow, as is well known, thought that he had discovered an almost positively safe agent in amylene ( $C_{10}H_{16}$ ); but the value of more than 200 safe administrations was at once destroyed by two rapidly succeeding deaths; and hence a large number of successful cases of the new agent must be reported before it will displace chloroform from its present well-deserved position.



## METHYLENE.

In the article on METHYL (q. v.), we have shewn that the composition of hydride of methyl (or marsh gas) is expressed by  $C_2H_6$ , H, which may be written  $C_2H_5HH$ . Now, according to the theory of substitutions, one, two, three, or even all four of the atoms of hydrogen may be replaced by a corresponding number of atoms of chlorine. Thus, (a) if one atom of H be replaced by one atom of Cl, we have *chloride of methyl*,  $C_2H_5Cl$ ; (b) if two atoms of H are replaced by two atoms of Cl, the resulting compound is *bichloride of methylene*,  $C_2H_4Cl_2$ , the  $C_2H_4$  here representing a new radical termed methylene, of which very little is known; (c) if three atoms of H are replaced by three atoms of Cl, the resulting compound is *terchloride of formyle*,  $C_2HCl_3$ , or common chloroform, another radical, viz., formyle,  $C_2H$ , now appearing; (d) if the whole of the H is replaced by Cl, the resulting compound is *tetrachloride of carbon*,  $CCl_4$ . We thus have four new bodies which may be constructed step by step out of hydride of methyl or marsh gas, and similarly, by starting with tetrachloride of carbon, the chemist may retrace the individual stages till he gets back to marsh gas. All these derivatives of marsh gas possess the power of producing anaesthesia when they are inhaled as vapour by men and animals. That the latter two—viz., chloroform and tetrachloride of carbon—possess this power, has been long known, Dr P. Smith having especially directed attention to the properties of the last-named compound; but that the first two also exert the same influence is a fact new to science, for which we are indebted to Dr Richardson. 'I discovered,' he observes, 'that chloride of methyl was a certain and gentle anaesthetic in July [1867] last, and this led me to hope that something more stable and manageable could be obtained—something that should stand between the chloride of methyl and chloroform. That substance is now found in the bichloride of methylene. That this compound would produce rapid, safe, and easy general anaesthesia, I discovered by experiment on August 30th of the present year.'—*Med. Times*, October 19, 1867.

It is a colourless fluid, having an odour like that of chloroform; and is pleasant to inhale, as it causes little irritation to the mucous membrane. It boils at  $88^\circ$ , and has a spec. gr. of 1.344, while that of its vapour is 2.937 (or nearly three times that of air). Hence, it boils at a lower temperature than other anaesthetics; while its specific gravity, both as a liquid and a vapour, is lower than that of chloroform, but much higher than that of ether; hence, from its easier evaporation, it requires more free administration than chloroform, and, from its greater vapour-density, it should be given less freely than ether. It mixes readily with absolute ether, and this combination yields a vapour containing corresponding proportions of each, their boiling-points only differing at most by  $4^\circ$ . It also combines with chloroform in all proportions. It should have a neutral reaction to test-paper. If a trace of acid be present—which is possible, but not probable—its inhalation might prove dangerous. To prevent decomposition, it should, like chloroform, be well guarded from the action of light.

Pigeons are the animals which Dr Richardson most employs for experiments on anaesthetic agents generally. They present various advantages over most other animals; one of the most important being that they die with singular readiness under the influence of these agents. On exposing three pigeons to the action of the vapour of a drachm of chloroform, bichloride of methylene, and tetrachloride of carbon, the peculiarity in the action of the bichloride is the absence, in the sleep it

produces, of the so-called second degree of narcotism. The bird glides from the first degree directly into the third, or that of absolute insensibility. The bichloride enters the circulation freely, and sustains the insensibility so well, that intervals of many minutes may be allowed to pass without readministration; while, from its being transformed altogether into vapour at a temperature lower than that of the body, it can be more readily eliminated from the system than chloroform, or tetrachloride of carbon, when its administration is withheld. On animals, it acts more evenly on the respiration and circulation than any other of the various substances which Dr Richardson has tried; and the only drawback, yet observed, is, that it sometimes produces vomiting; but this misadventure, so far as we know, has not yet been observed when it has been administered to the human subject, and pigeons are known to vomit on slight provocation. The numbers of the respirations and of the pulse rise and fall together, which 'is a good point, because there is no condition more perilous than disturbed balance of the circulating and respiratory systems.'

All anaesthetics given by inhalation after a certain dose destroy life; but that the destructive power of this new agent is less than that of either chloroform or tetrachloride of carbon, seems proved.

On trying the vapour upon himself, after ascertaining that it could be safely given to the lower animals, Dr Richardson inhaled it until it produced insensibility. 'I found the vapour very pleasant to breathe and little irritating, while drowsiness came on and unconsciousness without any noise in the head or oppression. I recovered also, as the animals seemed to recover, at once and completely. I felt as though I had merely shut my eyes, and had opened them again. In the meantime, I had, however, performed certain acts of a motor kind unconsciously; for I inhaled the vapour in the laboratory, and there went to sleep, but I awoke in the yard adjoining. This was on September 28th last, when I inhaled from a cup-shaped sponge. Since then, I have inhaled the vapour in smaller quantities from several instruments, with the effect of proving that there is little difference required for its administration and that of chloroform. A little more bichloride is required in the earlier stages than would be required if chloroform were being used, the fluid being more vaporisable. One drachm of bichloride to forty minims ( $\frac{1}{4}$  of a drachm) of chloroform, represents the difference required; but when the narcotism is well set up, less of the bichloride is required to sustain the effect.'

The materials on which this article is based are taken from a lecture delivered by Dr Richardson on the 8th of October 1867. Since that date, he has tested the action of this compound on the human subject in five long and severe operations, four of which were cases of ovariectomy; and on the whole, the results have fully realised his expectations. One of the ladies operated on had once been under chloroform administered to her by the late Dr Snow; she was therefore able to compare the effects of the two, and she decided strongly in favour of the new agent, on the grounds, that 'it caused no sense of suffocation, no ringing sounds in the head, no nausea, and no after-depressing effect whatever, as chloroform in her case did; but it allowed her to drop into sleep precisely as in natural sleep, and to wake with all her senses aroused, as after natural sleep.' The quantity used averaged a little more than a fluid drachm every five minutes; two drachms being first used. The anaesthesia was, on an average, complete in five minutes, and was prolonged for six or seven minutes without readministration. In the *Medical Times and Gazette* for November 2, 1867,

it is reported that Mr Marshall, of Bedford Square, has administered this fluid in another case of ovariectomy, besides using it in several smaller operations; and Mr Gamgee, of Birmingham, has administered it twice, one of his patients being an infant ten weeks old.\* As yet, no bad symptoms have been recorded. Mr Spencer Wells has suggested for this new agent the name of 'Chloromethyl,' which will probably meet with general approval.

*Chloride of Methyl*, the first of the compounds derived by substitution from hydride of methyl, although not so likely to come into general medical use as bichloride of methylene, is likely, according to Dr Richardson, to obtain 'a most useful and important place in our remedial treasury.' Half an ounce of it, diluted with water, and with the addition of a little sugar, acts as a pleasant but potent intoxicator. In smaller doses, it might be useful as a soothing and refrigerating agent.

MEUDON, a town of France, in the dep. of Seine-et-Oise, 5 miles west of Paris, on the Versailles and Paris Railway. The *château*, approached by a fine avenue of four rows of lime-trees, was built by the side of an older *château*, the work of Philibert Delorme, by the Grand Dauphin, son of Louis XIV., in 1699. During the Revolution, it was converted into a factory for warlike engines, and surrounded with a permanent camp, to keep out spies. The *château*, as it exists at present, was fitted up for Marie Louise by Napoleon, in 1812. It has a fine terrace, gardens beautifully laid out, and commands a very fine prospect. The Forêt de Meudon is a favourite holiday resort of the Parisians. Near it has been erected an expiatory chapel, dedicated to Notre Dame des Flammes, marking the spot where a terrible railway accident occurred in May 1842, in which more than 100 persons were burned alive. Whiting is manufactured to a considerable extent, and there are numerous bleach-fields. Rabelais was curé of M. for a long time. The *château* has lately become a summer residence of Prince Napoleon. Pop. (1872) 5101.

MEULEBEKÉ, a town of Belgium, in the province of West Flanders, 20 miles south-west of Ghent, on the Mandel, a tributary of the Lys. Weaving is carried on, and there are several breweries. It is near a railway, which connects it with Bruges and other places. Pop. 8300.

MEXICO. After the declaration of war against Juarez by the French, they issued a proclamation to the Mexican people, April 16, 1862, setting forth that one of the objects of the contest was to rescue them from the tyranny of the President, and put the government of the country on a stable footing. Little faith, however, seems to have been put in these professions; and the invaders, though joined by Marquez, the military leader of the clerical party, met with little success till the arrival of General Forey with a reinforcement from France in September. Forey then took the command in chief, addressed a proclamation to the Mexicans, promising them perfect liberty in the choice of a new government in room of that of Juarez; and

in the spring of 1863, concentrated the French troops, and marched on Mexico. On his way, he took the strongly fortified city of Puebla after a two months' siege, capturing its defender, Ortega, and his whole force (May 18); and, Juarez having fled from the capital, and transferred the seat of his government to San Luis Potosi at their approach, the French entered Mexico on June 10. A fortnight afterwards, a provisional government, headed by General Almonte, was established, and an 'Assembly of Notables,' which was called (June 24) to deliberate upon the best form of government, decided in July, by a vote of 231 to 19, in favour of a 'Limited Hereditary Monarchy,' with a Catholic prince for sovereign, under the title of 'Emperor of Mexico,' and resolved in the first place to offer the crown to the Archduke Ferdinand Maximilian (q. v.) of Austria, failing whom, to request the good offices of the Emperor Napoleon in obtaining another monarch. That this resolution was the fruit of a general earnest wish on the part of the Mexican notables, the feeble and almost unwilling support most of them accorded to their chosen emperor after his desertion by the French, will not allow us to suppose; but, on the other hand, we have not the slightest reason for believing that anything approaching intimidation or undue influence was exercised by the French. Most of them doubtless argued that a government supported by France would be sufficiently powerful to maintain the country in a state of tranquillity, and in the hope of this long-wished-for result, cast in their lot for empire. These changes were, of course, vigorously protested against by the republican assembly at San Luis, and the two parties prepared with eagerness to try the fortune of war. On October 1, Forey departed from Mexico, and General Bazaine took the command of the French forces, and commenced the campaign with vigour. The result of the winter's struggle was that in spring the imperialists were in possession of the whole country, with the exception of the four northern provinces. On October 3, 1863, the Archduke Maximilian had given audience at his *château* of Miramar, near Trieste, to a deputation which was sent to offer him the crown, and had accepted it. On May 29, the emperor and empress landed at Vera Cruz, and on June 12, made their public entry into the capital; and soon after the middle of the year, the imperialists had gained possession of every state in the kingdom, Juarez fleeing in August to the United States. As small parties of the republicans still maintained a species of guerrilla warfare in various districts, Maximilian, on October 2, 1865, published a proclamation, menacing with death, according to the laws of war, all who were found in armed opposition to his government; the republic having ceased, not only by the express wish of the nation, but also by the expiry (November 22, 1864) of Juarez's term of office, and his flight beyond the frontiers; an amnesty, however, being accorded to such as submitted before November 15. In accordance with this edict, Generals Arteaga and Salazar, who were defeated and captured, October 13, were shot on the 21st; and many hundreds of captured republicans were dealt with under the terms of the same order.

This contest in M. had from the commencement excited the liveliest interest in the United States, though the civil war, raging there also, prevented any active interference in the affairs of its neighbour. A general impression existed that France had taken advantage of the troubles of the United States to establish its authority firmly on the American continent; and this belief, along with the violation of the 'Monroe doctrine' by the establishment of

\* Since this article was written, additional cases have been described in the *Medical Times and Gazette*, of November 9, 1867. In one of these—in which a large fatty tumour, weighing 20 lbs., was removed from the abdomen—the patient was kept insensible for an hour and a quarter, and from 10 to 12 drachms were administered. In the *Lancet* for November 23, Mr Barnes of Liverpool records the case of its application to a boy, aged eight years, whose hip-joint was to be excised. The operation lasted 30 minutes, during the whole of which time the boy was in the deepest sleep.

imperialism in M., induced the United States to give all their sympathy and diplomatic aid to Juarez and his supporters. In November 6, 1865, Secretary Seward forwarded a dispatch to Paris, in which it was stated that the presence of the French army in M. was a source of 'grave reflection' to the government of the United States, and that the latter could on no account allow the establishment of an imperial government, based on foreign aid, in M., or recognise in that country other than republican institutions. This dispatch led to an interchange of diplomatic notes during the following six months; the Americans holding firmly to their first statements, and even insinuating the probability of an armed interference on behalf of Juarez; till the French emperor, who was wearied with a contest so expensive and, though successful, so barren of lasting fruits, ultimately agreed, in the summer of 1866, to withdraw his troops from Mexico. The Belgian legion and some Austrian levies, however, were not included in this arrangement. Accordingly, from the autumn of 1866 till Feb. 1867, the French troops by degrees evacuated M., and their departure was the signal for a fresh rising on the part of the Juarista. See MAXIMILIAN and JUAREZ in SUPP., Vol. X. The political condition of M. is still far from satisfactory.

MEZIERES, a fortified town of France, capital of the dep. of Ardennes, on the right bank of the Meuse, on the isthmus of a promontory formed by the river, which washes its walls on two sides, and separates it from Charleville (q. v.). It was strongly fortified by Vauban, and is defended by a citadel. It communicates with Charleville by a suspension-bridge. In 1815, the town held out for two months against the Allies, who besieged it after the battle of Waterloo. Over the north aisle of the church is a bomb-shell, which has been sticking there ever since the town capitulated. In 1520, the Chevalier Bayard, with 2000 men, successfully defended it against 40,000 Spaniards under Charles V. The banner of Bayard is said to be still preserved in the Hôtel de Ville. Pop. (1872) 4031.

MEZQUITE, the name of two Mexican trees or shrubs, of the natural order *Leguminosæ*, suborder *Papilionaceæ*, bearing pods filled with a nutritious pulp. The COMMON M. (*Algarobia glandulosa*) is a small shrub, with stems often decumbent, and armed with strong straight spines. It is found in great profusion throughout vast regions, chiefly consisting of dry and elevated plains. In dry seasons, it exudes a great quantity of gum (*Gum Mezquite*), similar in quality to gum-arabic, which seems likely to become a considerable article of commerce, and which has begun to be exported to San Francisco from the Mexican ports on the Pacific.—The CURLY M., or SCREW M. (*Strombocarpa pubescens*), also called SCREW BEAN and TOURNIL, although only a shrub or small tree, is of great value in the wild and desert regions of the western part of North America, where it occurs along with willow-bushes near springs of water. Its wood is used as fuel, and the pulp of its pods for food. The pods are spirally twisted into compact rigid cylinders, from an inch to an inch and a half in length.

MEZZOJU'SO (Arab. *Menell-Jusanf*, village of Joseph), a town of Sicily, in the province of Palermo, 18 miles south-south-east of Palermo city. It is one of the four colonies of Albanians, who, on the death of Scanderbeg, in the 15th c., fled to Sicily, to avoid the oppression of the Turks. They preserve their language to a great extent, and follow the Greek ritual, their priests being allowed to marry; but, except on fête-days, they are not to be distinguished in feature or dress from the peasantry of the rest of Sicily. Pop. 5700.

MGLIN, a town of Russia, in the government of Tchernigov, 126 miles north-north-east of the town of Tchernigov. There is a large cloth-factory, and a considerable number of German families. Pop. (1867) 5842.

MHENDIGU'NJ, a town of British India, in the territory of Oude, 90 miles south-east of Lucknow, 3 miles south of the right bank of the river Sae. It is a busy, thriving place, with a pop. estimated at 20,000.

MHOW, a town of British India, in the territory of Indore, 13 miles south-west of the town of Indore, near the Vindhyan Mountains, on an eminence on the Gumber river. Near it are the cantonments, which have altogether the appearance of a European town, having a church with steeple on an eminence, a spacious lecture-room, a well-furnished library, and a theatre. They are situated at an elevation of 2019 feet above the sea, and are occupied by a considerable force. On the 1st July 1857, the sepoys mutinied here, during the great rebellion of that year.

MIA'VA, a market-town of North-west Hungary, on the Miava, an affluent of the Morava, 48 miles east-north-east of Presburg city. There are manufactures of woollen cloth and bagging, and hemp and flax are cultivated. Pop. (1869) 9637.

MICROZA'MIA, a genus of plants of the natural order *Cycadaceæ*. They are widely diffused over Australia. The fronds resemble those of palms, and are used in the Roman Catholic Church on Palm Sunday. The underground stem is large and turnip-like, but covered with scales or leaf-scars, and contains a substance resembling tragacanth. The nuts of *M. spiralis* are edible, but are only used in times of scarcity.

MIDDLE LEVEL. Under the heading BEDFORD LEVEL, a remarkable district, covering 400,000 acres, is described, bounding the Wash on all sides except seaward, extending landward nearly to Brandon, Cambridge, Peterborough, and Bovingbroke, and embracing portions of the six counties of Northampton, Huntingdon, Cambridge, Lincoln, Norfolk, and Suffolk. It nearly coincides in area with what is popularly known as the Fens. The whole region was, centuries ago, converted into an unprofitable marsh by repeated incursions of the sea, coupled with obstructions to the outward flow of the rivers Nene, Cam, Ouse, Welland, &c. Vast operations have been carried on ever since the time of Charles I., by digging new channels and outfalls, and employing windmills and steam-engines to pump the water from the marshes and ponds into these artificial channels. The Bedford Level is divided into the *North*, the *Middle*, and the *South Levels*, managed by commissioners, whose powers are derived from special acts of parliament. The improved value of the land is the fund out of which the expense of the engineering works is defrayed. It was in one of these districts (the Middle Level, between the Nene and the Old Bedford River) that an irruption took place in 1862, which strikingly illustrates the dependence of the safety of the whole region on well-formed and well-maintained embankments. There was a sluice, called St Germain's Sluice, situated at the confluence of the Middle Level main outfall drain with the river Ouse, near the upper end of another artificial channel, known as the Eau Brink Cut. The drain was made in 1847, and was enlarged ten years afterwards to a bottom-width of 48 feet, a side-slope of 2 to 1, and a level of 7 feet below low-water spring-tide in the river; the rise of high-water spring-tide at that point was 19 feet, and the

sill of the sluice was 6 feet below low-water spring-tide.

On the 4th of May 1862, this sluice gave way without the slightest warning; the tidal waters undermined the brickwork, and formed a hole in the bed of the river, into which the works of the sluice sank. The tidal waters rushed up the opening, and ebbed and flowed throughout a distance of 20 miles. The commissioners of the Middle Level applied to Mr Hawkshaw, the engineer, to devise means for repairing the disaster. An earth and cradle-dam was attempted to be thrown across the drain, at about 500 yards from the fallen sluice; but this was relinquished in favour of a permanent coffer-dam of pile-work, at a distance of half a mile from the sluice; and after incessant exertions from May 16 to June 19, the tidal waters were at length effectually shut out by a strong dam. The failure of the St Germain's Sluice was not the only irruption that had to be battled with; eight days after that failure, under the pressure of a high spring-tide, the west bank of the drain gave way, on May 12, at a point about 4 miles from the sluice; the bank had been built only to resist upland waters, and not a rush and a pressure of the sea. The rupture carried away 70 yards of the bank, scouring out a hole 10 feet deep at the spot, and admitting a rush of water which covered 6000 acres of fertile land to a depth of 2 or 3 feet, increased at successive high-tides to 10,000 acres.

When the finishing of the dam had enabled Mr Hawkshaw to shut out the tidal waters, means had to be devised for getting rid of the flooding waters, and providing an outlet for the usual rivers and land-drainage of the Middle Level. It was resolved to utilise some of the old outlets at other spots, and to supplement their action by enormous syphons, placed over the coffer-dam. Sixteen syphons were provided. They were made of cast iron, 3 feet 6 inches internal diameter, and somewhat over 1 inch thick; they rested on the top of the dam, and on inclined framework supported by piles at the sides. The valves were so arranged, that the syphons could be put in operation, either by exhausting the air or by filling them with water. When only six of the syphons were in position, they carried 50,000 gallons of water per minute over the dam.—For more minute details of the dam and the syphons, see Mr Hawkshaw's paper read before the Institute of Civil Engineers in 1863.

There are large items both of cost and of compensation in works of this kind. Nearly the whole of the Middle Level is 15 feet below high-water spring-tides; it is difficult to keep out the sea-water, and at the same time to preserve an outlet for the land-water, especially Whittlesea Mere; there are 130,000 acres to be drained somehow or other; but as the land is rich for farming, the commissioners, in past years, did not hesitate to spend £400,000 on 11 miles of drain, and £30,000 on the sluice. The drain runs through a district called *Marshland*, between Lynn and Wisbeach; and as the bursting of the bank caused this district to be deluged with water, the commissioners have had to compensate the Marshland farmers and others; the amount of this compensation was frequently litigated between 1862 and 1867. As concerns the land itself, it is found to be more fertile after such inundations than before, owing to the amount of silt deposited on the fields. After repairing the breach in the bank, the 10,000 inundated acres were drained without much difficulty, through the Marshland, Smeeth, and Fen drain, and the Marshland sewer; the syphons are permanent channels, to carry off the usual land-waters regularly. The syphons were subjected to a severe trial in January 1867, by the

ice which accumulated around their lower ends; but iron gratings effectually resisted the entrance of the ice into the syphons.

**MIKA'NIA**, a genus of plants of the natural order *Compositæ*, nearly allied to *Eupatorium* (q. v.). The heads of flowers are 4-flowered, and have four involucreal leaves. *M. officinalis* is a Brazilian species, with erect stem, and heart-shaped leaves, abounding in a bitter principle and an aromatic oil, and valuable as a tonic and febrifuge. *M. Guaco* and *M. opifera*, also natives of the warm parts of South America, are among the plants which have acquired a high reputation—deserved or undeserved—for the cure of snake-bites. They are twining herbaceous plants. *M. Guaco* is remarkable for the large indigo-blue spots on the under side of its ovate leaves. The mode of using this plant, which is one of those called GUACO, or HUACO, by the Indians, is by dropping the juice of the fresh leaves into the wound made by a serpent; or little cakes are formed of the bruised plants, which are said to retain their power for a long time. The whole subject requires investigation.

**MIKLOS (St) TOROK**, a town of Hungary, in the county of Heves, near the Theiss, about 70 miles south-east of Pesth, with which it is connected by railway. Pop. (1869) 13,024, chiefly employed in rearing horses and cattle, and in fishing.

**MI'NDSEENT**, a town of Hungary, in the county of Csongrad, near the left bank of the Theiss, and just below the mouth of the Saros, 19 miles north from Szegedin. Pop. (1869) 9414.

**MINE'O**, a town of the island of Sicily, in the province of Catania, 82 miles south-west of Messina. It is supposed to occupy the site of the ancient *Mena*, founded by Ducetius, 459 B.C. Pop. 9500.

**MINK** (*Mustela lutreola*), a species of weasel, inhabiting the northern parts of Europe and Asia; very similar to which in characters and habits is another species, by some regarded as only a variety of the same, the *M. or VISON* (*M. vison*) of North America, abundant in almost every part of that continent. Both inhabit the neighbourhood of streams, lakes, and marshes; have semi-palmated feet, are expert swimmers and divers, and prey on fishes, frogs, and other aquatic animals, as well as on birds, rats, mice, &c. They are covered with a downy fur, interspersed with longer and stronger hairs: the colour is brown, with more or less of white on the under parts. The American *M.* is generally larger than that of the Old World, being often more than eighteen inches from the nose to the root of the tail, whilst the latter is seldom more than twelve. It has also a more bushy tail. It is very active and bold, and often commits great depredations in poultry-yards, carrying off a fowl with great ease. Unlike most of its congeners, it is easily tamed, and becomes much attached to those who care for it. In domestication, it ceases to regard the inmates of the poultry-yard as prey. It emits an unpleasant odour only when irritated or alarmed. The fur of the *M.* is valuable.

**MI'RTA**, a town of India, in the Rajpoot state of Jodhpur, stands on high ground near the source of a tributary of the Luni, 230 miles south-west of Delhi. *M.* is supplied with good water from three large tanks. Pop. estimated at 25,950.

**MISHMEE BITTER**, the root of *Coptis Teeta* (see *COPTIS*), a plant found in the mountainous regions on the borders of India and China; of the same genus with the Golden Thread of the northern parts of the world, and not unlike it. The root is in much use and esteem in some parts of the East

as a stomachic and tonic, and has begun to be known in Europe.—The root of *C. trifoliata* is also used as a bitter.

**MISILMERI** (corrupted from *Menzil-al-Amir*, Village of the Emir), a town of the island of Sicily, in the province of Palermo, 7 miles south-east of Palermo city. It is a straggling, poverty-stricken town. It was at M. that Garibaldi, in May 1860, joined the Sicilian insurgents; and it was by a short cut from M. to Palermo, through the Pass of Mezzagna, that he advanced on the latter city and took it by a *coup de main*. M. used to be a notorious harbour of banditti. Pop. 7250.

**MITTWEIDA**, a town of Saxony, in the circle of Zwickau, 35 miles south-east of Leipzig. For centuries, M. has been noted for its industry. The principal branches of industry are spinning, cotton-weaving, manufacture of fustian, &c., together with dyeworks and bleach-fields. Pop. (1871) 8845.

**MOFFAT, ROBERT**, a distinguished missionary, was born at Ormiston, East Lothian, on the 21st of December 1795. Having resolved to become a missionary to the heathen, he offered his services to the London Missionary Society, was accepted, and sent by them to South Africa. Arriving at Cape Town in 1817, he immediately proceeded beyond the boundaries of Cape Colony to Namaqualand, where he entered upon his labours at the kraal of Africaner, a chief whose name had long been a terror to the people of the neighbouring districts of the colony, on account of the audacious raids which he made among their settlements, and his ferocious character, but who had lately become a convert to Christianity, and now shewed a warm desire for its promotion. Here M. laboured for three or four years with great success, Christianity and civilisation advancing together. But the situation, on account of the drought and sterility of the country, and its very thinly scattered population, being unsuitable for a principal mission-station, he set out in search of a better locality, and laboured at several stations in succession in the countries to the north and north-east of Cape Colony. Wherever he went, the gospel was gladly received by some of those who heard it, and in some places by many. In every place he also guided the people in the arts of civilised life. He made several missionary tours, and his adventures were very remarkable, and are graphically described in his work, *Missionary Labours and Scenes in Southern Africa* (Lond. 1842), which he wrote and published during a visit of several years to Britain, rendered necessary by the state of his health. This publication, and his many speeches and sermons during his stay in his native country, did much to animate missionary zeal, and to direct it towards Africa. In 1842, M. returned to his labours in that country, and came back to England in 1870. His daughter was the wife of the celebrated missionary and traveller, Dr Livingstone.

**MOGUE'R** (Arab. 'caves,' of which there are many in the neighbourhood), a town of Spain, in the province of Huelva, 43 miles west-south-west of Seville, rises gently above the Rio Tinto, near the mouth of which is its port, Palos. The streets are generally broad and straight, but both the town and castle are much dilapidated. The old Franciscan convent was ordered in 1846 to be preserved as a national memorial, but it is now fast going to ruin, and the wood of the cells stripped off. It was here, in 1484, that Columbus, craving charity, was received by the prior, Juan Perez de Marchena, by whose influence he was enabled to prosecute his discoveries, setting out from the port of Palos on August 3, 1492. It was to this port also that he returned, March 15, 1493, after having accomplished

the great end of his expedition. Here likewise did Cortes land in May 1528, after the conquest of Mexico, and lodged in the same convent which gave shelter to Columbus. Palos is now a poor decayed fishing-port. M. has some trade in wine and fruit. Pop. 6600.

**MOHAMMEDAN SECTS.** 'My community,' Mohammed is reported to have said, 'will separate itself into seventy-three sects; one only will be saved, all the others shall perish.' This prophecy has been largely fulfilled. Even during the illness, and immediately after the death of the founder, many differences of opinion arose among his earliest adherents. We have endeavoured to shew, both under **KORAN** and **MOHAMMEDANISM**, how the fundamental book of Islam left certain points undecided by the very fact of its poetical wording, and how, further, the peculiarity of the Arabic idiom at times allowed many interpretations to be put upon one cardinal and dogmatic sentence. To add to this uncertainty, a vast number of oral traditions sprang up and circulated as an expansive corollary to the Koran. Political causes soon came to assist the confusion and contest, and religion was made the pretext for faction-fights, which in reality had their origin in the ambition of certain men of influence. Thus 'sects' increased in far larger numbers even than the Prophet had foretold, and though their existence was but short-lived in most instances, they yet deserve attention, were it only as signs and tokens of the ever-fresh life of the human spirit, which, though fettered a thousand times by narrow and hard formulas, will break these fetters as often, and prove its everlasting right to freedom of thought and action.

The bewildering mass of these currents of controversy, has by the Arabic historians been brought under four chief heads or fundamental bases. The first of these relates to the divine attributes and unity. Which of these attributes are essential or eternal? Is the omnipotence of God absolute? If not, what are its limits? Further, as to the doctrine of God's predestination and man's liberty—a question of no small purport, and one which has been controverted in nearly all 'revealed' religions—How far is God's decree influenced by man's own will? How far can God countenance evil? and questions of a similar kind belonging to this province. The third is perhaps the most comprehensive 'basis,' and the one that bears most directly upon practical doctrines—viz., the promises and threats, and the names of God, together with various other questions chiefly relating to faith, repentance, infidelity, and error. The fourth is the one that concerns itself with the influence of reason and history upon the transcendental realm of faith. To this chapter belong the mission of prophets, the office of Imam, or Head of the Church, and such intricate subtleties as to what constitutes goodness and badness; how far actions are to be condemned on the ground of reason or the 'Law;' &c.

One broad line, however, came to be drawn, in the course of time, among these innumerable religious divisions, a line that separated them all into orthodox sects and heterodox sects; orthodox being those only who adopted the oral traditions, or Sunna (see **SUNNITES**).

Much more numerous than the orthodox divisions are the heterodox ones. Immediately after Mohammed's death, and during the early conquests, the contest was chiefly confined to the question of the Imamate. But no sooner were the first days of warfare over, than thinking minds began to direct themselves to a closer examination of the faith itself, for which and through which the world

was to be conquered, and to the book which preached it, the Koran. The earliest germs of a religious dissension are found in the revolt of the Kharejites against Ali, in the 37th year of the Hedjrah; and several doctors shortly afterwards broached heterodox opinions about predestination and the good and evil to be ascribed to God. These new doctrines were boldly, and in a very advanced form, openly preached by Wásil Ibn Atá, who, for uttering a moderate opinion in the matter of the 'sinner', had been expelled from the rigorous school of Basra. He then formed a school of his own—that of the Separatists or Motazilites (q. v. in SUPP., Vol. X.), who, together with a number of other 'heretical' groups, are variously counted as one, four, or seven sects.

We now come to the second great heretic group, the Sefatians. The Sefatians (attributionists) held a precisely contrary view to that of the Motazilites. With them, God's attributes, whether essential or operative, or what they afterwards called declarative or historical, i. e., used in historical narration (eyes, face, hand), anthropomorphisms, in fact, were considered eternal. But here, again, lay the germs for more dissensions and more sects in their own midst. Some taking this notion of God's attributes in a strictly literal sense, assumed a likeness between God and created things; others giving it a more allegorical interpretation, without, however, entering into any particulars beyond the reiterated doctrine, that God had no companion or similitude. The different sects into which they split were, first, the Aharians, so called from Abul Hasan al Ashari, who, at first a Motazilite, disagreed with his masters on the point of God's being bound to do always that which is best. He became the founder of a new school, which held (1) that God's attributes are to be held distinct from his essence, and that any literal understanding of the words that stand for God's limbs in the Koran is reprehensible. (2) That predestination must be taken in its most literal meaning, i. e., that God preordains everything. The opinions on this point of man's free will are, however, much divided, as indeed to combine a predestination which ordains every act with man's free choice is not easy; and the older authors hold it is well not to inquire too minutely into these things, lest all precepts, both positive and negative, be argued away. The middle path, adopted by the greater number of the doctors, is expressed in this formula: There is neither compulsion nor free liberty, but the way lies between the two; the power and will being both created by God, though the merit or guilt be imputed to man. Regarding mortal sin, it was held by this sect, that if a believer die guilty of it without repentance, he will not, for all that, always remain a denizen of hell. God will either pardon him, or the Prophet will intercede on his behalf, as he says in the Koran: 'My intercession shall be employed for those among my people who shall have been guilty of grievous crimes;' and further, that he in whose heart there is faith but of the weight of an ant, shall be delivered from hell-fire. From this more philosophical opinion, however, departed a number of other Sefatian sects, who, taking the Koranic words more literally, transformed God's attributes into grossly corporeal things, like the Mosshabehites, or Assimilators, who conceived God to be a figure composed of limbs like those of created beings, either of a bodily or spiritual nature, capable of local motion, ascent, or descent, &c. The notions of some actually went so far as to declare God to be 'hollow from the crown of the head to the breast, and solid from the breast downward'; he also had black curled hair.' Another sub-

division of this sect were the Jabarians, who deny to man all free agency, and make all his deeds dependent on God. Their name indicates their religious tendency sufficiently, meaning 'Necessitarians.'

The third principal division of 'heretical sects' is formed by the Kharejites, or 'Rebels' from the lawful Prince—i. e., Ali—the first of whom were the 12,000 men who fell away from him after having fought under him at the battle of Saffin, taking offence at his submitting the decision of his right to the califate (against Moawiyah) to arbitration. Their 'heresy' consisted, first, in their holding that any man might be called to the Imamatus though he did not belong to the Koreish, nor was even a freeman, provided he was a just and pious man, and fit in every other respect. It also followed that an unrighteous Imam might be deposed, or even put to death; and further, that there was no absolute necessity for any Imam in the world.

Of the fourth principal sect, the Shiites, or 'Secretaries,' the followers of Ali Ibn Abi Taleb, we have spoken under that special heading.

It remains only to mention a few of the many pseudo-prophets who arose from time to time in the bosom of Islam, drawing a certain number of adherents around them, and threatening to undermine the church founded by Mohammed, by either declaring themselves his legal successors, or completely renouncing his doctrines. The first, and most prominent among these, was Mosaylima (q. v. in SUPP., Vol. X.). Next to him stands Al-Aswad, originally called Aihala, of the tribe of Ans, of which, as well as of that of a number of other tribes, he was governor. He pretended to receive certain revelations from two angels, Sohaik and Shoraik. Certain feats of legerdemain, and a natural eloquence, procured him a number of followers, by whose aid he made himself master of several provinces. A counter-revolution, however, broke out the night before Mohammed's death, and Al-Aswad's head was cut off; whereby an end was put to a rebellion of exactly four months' duration, but already assuming large proportions. In the same year (11 Hedjrah), but after Mohammed's death, a man named Toleiha set up as prophet, but with very little success. He, his tribe, and followers were met in open battle by Khalid, at the head of the troops of the Faithful, and being beaten, had all finally to submit to Islam.

A few words ought also to be said regarding the 'Veiled Prophet,' Al-Mokanna, or Borkai, whose real name was Hakem Ibn Hashem, at the time of Al-Mohdi, the third Abbaside calif. He used to hide the deformity of his face (he had also but one eye) by a gilded mask, a circumstance which his followers explained by the splendour of his countenance being too brilliant (like that of Moses) to be borne by ordinary mortals. Being a proficient in jugglery besides, which went for the power of working miracles, he soon drew many disciples and followers around him. At last he arrogated the office of the Deity itself, which by continual transmigrations from Adam downwards, had at last resided in the body of Abu Moslem, the governor of Khorassan, whose secretary this new prophet had been. The calif, finding him growing more and more formidable every day, sent a force against him, which finally drove him back into one of his strongest fortresses, where he first poisoned and then burned all his family; after which he threw himself into the flames, which consumed him completely, except his hair. He had left a message, however, to the effect that he would reappear in the shape of a gray man riding on a gray beast, and many of his

followers for many years after expected his reappearance. They wore, as a distinguishing mark, nothing but white garments. He died about the middle of the 2d c. Hedjrah.

Of the Karmathians and the Ismailis, we have spoken under these special headings. We can scarcely enumerate among the prophets Abul Teyeb Ahmed Al-Motanebbi, one of the most celebrated Arabic poets, who mistook, or pretended to mistake, his poetical inspirations for the divine afflatus, and caused several tribes to style him prophet, as his surname indicates, and to acknowledge his mission. The governor of his province, Lalû, took the promptest steps to stifle any such pretensions in the bud, by imprisoning him, and making him formally renounce all absurd pretensions to a prophetic office. The poet did so with all speed. He was richly rewarded by the court and many princes for his minstrelsy, to which henceforth he clung exclusively; but the riches he thus accumulated became the cause of his death. Robbers attacked him while he was returning to his home in Kufa, there to live upon the treasure bestowed upon him by Adado'ddawla, Sultan of Persia.—The last of these new prophets to be mentioned is Baba, who appeared in Amasia, in Natolia, in 638 Hedjrah, and who had immense success, chiefly with the Turkmans, his own nation, so that at last he found himself at the head of nearly a million men, horse and foot. Their war-cry was, God is God, and Baba—not Mohammed—is his prophet. It was not until both Christians and Mohammedans combined for the purpose of self-defence, that this new and most formidable power was annihilated, its armies being routed and put to the sword, while the two chiefs were decapitated by the executioner.

MO'LESKIN AND CORDUROY are varieties of FUSTIAN (q. v.), a term which is used in a generic sense to include also velveteen, velveret, thick-set, thick-set cord, beaverteen, and other stout cotton cloths for men's apparel—a class of goods largely manufactured in Lancashire. The general structure of these fabrics is described under FUSTIAN and VELVET. They are, in point of fact, all of the nature of velvet, with a *nap* or *pile* on the surface, and most of them are twilled.

When cloth of this kind leaves the loom, its surface is covered with loops like Brussels carpet, and these are then cut open with a ripping-knife of a peculiar shape, which the operatives learn to use with great dexterity. The hairy and uneven appearance which the cloth acquires in this operation is subsequently improved by the shearing process. The cloth is next steeped in hot water, to get rid of the paste used in dressing the yarn, and is then ready to be passed through the brushing or teasing machine, which consists of blocks of wood with concave surfaces covered with card-brushes, working backwards and forwards in a lateral direction against wooden rollers, encased in tin-plate, over which the cloth passes. The tin-plate is made rough with the burs of punched holes. In the next operation, the fustian is singed by passing the nap side quickly over a red-hot metal cylinder. The brushing and singeing are repeated three and occasionally four times, to give the cloth a smooth appearance. It is then washed, bleached with chloride of lime, and dyed—usually of some shade of olive, slate, or other quiet colour.

The different names given to fustian cloths depend upon their degree of fineness, and the manner in which they are woven and finished. Thus, smooth kinds, of a strong twilled texture, are called *mole-skins* when shorn before dyeing, and *beaverteens* when cropped after dyeing. Corduroy, or king's cord, is produced by a peculiar disposition of the pile-

threads. In all fustians, there is a warp and weft thread, independent of the additional weft-thread forming the pile; but in corduroys, the pile-thread is only 'thrown in' where the corded portions are, and is absent in the narrow spaces between them.

Until a comparatively recent period, the quantity of fustian cloths annually consumed in the British Islands must have been very large, but the increased price of cotton, and the introduction of cheap woollen fabrics, have now very much curtailed the use of them. They are still, however, largely worn by certain classes of mechanics and labourers.

MO'LOCH, a genus of saurian reptiles, of the family *Agamida* (see AGAMA). *M. horridus*, an Australian species, is perhaps the most ugly and repulsive in appearance of all the saurian tribes. The whole surface of the body is covered with

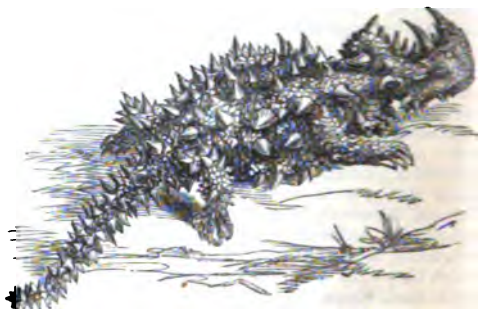

Moloch horridus.

irregular plates and strong sharp spines; the upper surface of the head is crowned with two very large spines; and on the back of the neck are large rounded protuberances, covered with granular scales and spines. The *M.* is, however, a perfectly inoffensive creature.

MOLTKE, HELLMUTH, COUNT VON, Field-Marshal of the German empire, and chief of the general staff, who planned the Prussian campaign of 1866 against Austria, and the German campaign of 1870—1871 against France. He belongs to an old family, who had their seat for centuries in Mecklenburg, where *M.* was born, 26th October 1800. Soon after his birth, his father, a military officer, left Mecklenburg, and acquired an estate in Holstein. He and his brother were sent to the military academy in Copenhagen, where iron discipline and military frugality laid the foundation of his later character. In 1822, he entered the Prussian army as cornet. His parents having by this time lost all their fortune, he was left without any means whatever, and had to undergo many hardships to maintain himself in his position, from the very modest pay the Prussian officers receive; yet he managed to save enough to take lessons in modern languages, which afterwards proved of great advantage to him. His eminent abilities soon procured him a place in the general staff. The time between 1835 and 1839, he spent in Turkey and Asia Minor, whither he was sent by the Prussian government to report on the war between that country and Mehemet Ali. Several anonymous publications of his, descriptive of the country and the war, are worthy of notice. After his return, he rapidly advanced through the different stages to the rank of general, continuing, however, on the general staff. His wonderful strategical powers were of immense service in the wars with Denmark (1863—1864), Austria (1866),

and France (1870—1871); bringing them all to triumphant issues. At the end of the Austrian war he was rewarded with the order of the Black Eagle, in 1870 he was created a count, and in 1871 he was raised to the rank of field-marshal. He published a work on the Franco-German War. M. is a man of great modesty and simplicity; he is reserved, and so little given to talk, that he has acquired the surname of 'the Silent.' The same composure and equanimity that he possesses in council, he also preserves in the heat of battle. See GERMANY, in SUPP., Vol. X.

**MOMBA'SSA**, or **MOMBAZ**, a seaport town of East Africa, in the territory of the Sultan of Zanzibar, on a small coralline island off the coast, in the middle of an estuary formed by two small rivers, in lat. 4° 4' S., and long. 39° 43' E., about 150 miles north of Zanzibar island. The shores of the island are rocky and abrupt; and although the channel may be forded at low water, the attempt is attended with danger. The town has the usual Arab characteristics of ruin, neglect, and filth in a striking degree. The only object of interest is an extensive fort, built on a rock, cut perpendicularly, in 1596, by the Portuguese, and restored by them in 1635, as an inscription over the principal gateway indicates. It is a work of considerable pretension, with upwards of one hundred guns in position, but in a ruinous condition. The inhabitants, the majority of whom are sunk in abject poverty, mostly live in wretched hovels, scattered among what remains of the once magnificent buildings. The town and island of M., as well as the surrounding district, is inhabited by the Wanika tribe. The harbour is still good, and is commodious and safe. M. was visited by Vasco da Gama in 1497, when he found it to be a large and very prosperous town. It was held by the Portuguese during the greater part of the period from 1529 to 1720, when it appears to have become independent. The English held it from 1824 to 1826, when they resigned it. Since then, it appears to have been possessed by the Sultan of Zanzibar, and apparently is considered a place of some importance. Burton says that the inhabitants of M. 'are justly taxed with pride, bigotry, evil-speaking, insolence, turbulence, and treachery by other Arabs.' Pop. 13,000 to 15,000.

**MONASTIR**, a seaport town of North Africa, in the dominion of Tunisia, 80 miles south-south-east of the city of that name, on the Gulf of Sidra. Woollen and camel fabrics are manufactured, and there is some maritime trade. Pop. 12,000.

**MONSELIÇÉ**, a walled town of North Italy, 13 miles south-east of Padua, on the canal of Monselice, which extends from Padua to Este. M. was a place of importance in the middle ages. It has several silk-mills. Pop. 3160.

**MONTBRISON**, a town of France, capital of the dep. of Loire, 37 miles south-west of Lyon, on the Vizezy, a feeder of the Loire, stands at the base of a lofty and precipitous rock. In the vicinity are mineral springs. Pop. (1872) 5386.

**MONT-DE-MARSAN**, a town of France, capital of the dep. of Landes, at the junction of two streams—the Midou and Douze—which, when united, take the name of Midouze, and join the Adour. It is 65 miles south of Bordeaux, with which and with other places it is connected by railway. The town has of late years made great progress. It has a communal college, and mineral warm baths. There are manufactures of common woollen cloths, blankets, sail-cloth, and leather. Pop. (1872) 6964.

**MOQUEGUA**, a town of Peru, capital of a province of the same name, 68 miles north-west of Tacna, on the great route west of the Cordilleras.

In the province are many large vineyards, which produce great quantities of wine and brandy. Pop. 9000.

**MORADABAD**, a town of British India, capital of a district of the same name, is situated on a slightly elevated ridge between the Ramgunga and the Ganges, 90 miles east-north-east of Delhi. There is a large jail, capable of holding 1800, for native convicts. West of the town, and separated from it by the jail, are the cantonments for the troops, agreeably situated amid luxuriant trees; the chief duty of the troops is to guard the convicts. Pop. (at census of N.W. Provinces, 1872) 62,417.

**MORELIA**, or **VALLADOLID**, a town of Mexico, capital of the state of Michoacan, in a fine valley, surrounded by high mountains, 125 miles west-north-west of Mexico. There is a magnificent aqueduct for the supply of water. It was the birthplace of Iturbide, the short-lived emperor of Mexico. Pop. 25,000.

**MORELLA** (anc. *Castra Alia*, the winter-quarters of Sertorius), a town and important fortress of Spain, in the province of Castellon, about 80 miles north of Valencia. M. was the chief stronghold of Cabrera, who scaled the castle by ropes furnished by a partisan within, on the night of the 25th January 1838. It was retaken in 1840 by Espartero, after a brave defence. There are some interesting Roman and Moorish antiquities. Pop. 6300.

**MOSAIC WOOL**, or **WOOL MOSAIC**, is a remarkable application of the principle of mosaic-work to the production of woollen or worsted rugs and carpets, having a definite design or pattern, independent of the ordinary processes of printing and weaving. Many attempts in this direction have been made, chiefly on the continent; but the most successful is that of Messrs Crossley, in whose extensive carpet factory at Halifax the mosaic wool is produced as a regular department of manufacture.

In the first place, well-spun worsted threads are dyed to every colour and almost every shade or tint, amounting to a hundred varieties in all. An artist prepares a full-sized drawing of the pattern or design, ruled all over with cross-lines; this is copied on lined paper by girls, each of whom takes as much of the pattern as will fill a square foot. A workman (or woman) having a good eye for colour, examines each square piece of drawing in detail, and selects the proper colour of thread suitable to every portion of it; the threads are a little over 200 inches long each, or about 17 feet, and are numerous enough to pack closely together into a mass of one square foot in width and depth. A strong iron framework, 17 feet long, is so arranged that all these threads can be stretched on it horizontally, tied at one end, and weighted with 4 lbs. to each thread at the other. Girls, under the direction of the workwoman who selects the colours, arrange these threads one by one, tying them at one end, weighting them at the other, and supporting them on a steel bar in the middle. This being done, the mass of 17 feet in length is cut up into blocks of 20 inches long each, for convenience in after-operations. All these processes are for one square foot only of the pattern, and they have to be repeated as many times as there are square feet in it. Supposing a rug 6 feet by 2, with a lion, tiger, or other device occupying the greater part of the surface: there must be twelve masses prepared, and as each mass contains 50,000 threads, there will be 600,000 altogether. Blocks are cut from each mass, and are placed in an iron box or frame, side by side; thus forming a quadrangular solid 6 feet by 2, and 20 inches deep, with the threads arranged vertically.



Now, to convert this into a great number of separate rugs, the pattern of which is seen represented on the upper surface, formed by the ends of the coloured threads, india-rubber is dissolved in camphine to the consistence of carpenters' glue, and brushed well over the top, so that every individual thread shall receive its portion; this being dried, a second coating is applied; and afterwards a third. A backing of canvas, or of some kind of strong cloth, is cemented down upon the mass of threads by a glue of the same kind, and is scraped and rubbed until it adheres to every individual fibre. When dry, the mass of threads is raised up three-sixteenths of an inch, by a screw acting upon a movable bottom to the box. A very keen circular cutter, 12 feet in diameter, and rotating 170 times per minute, quickly severs a horizontal slice three-sixteenths of an inch thick, the box of threads being caused by an endless screw to travel onwards to meet the cutter. This slice, when turned up, presents the picture complete, in a beautifully soft nap or pile of woollen threads, supported by a canvas or woollen backing. It is a mere question of hand-work to convert this into a rug, carpet, coverlet, or wrapper of any kind. A second repetition of the same processes converts another slice into a second rug; and so on, until the mass of 20 inches in depth has been cut up into about a hundred slices, each forming one rug. As the blocks of 20 inches were originally cut from a mass of 200 inches, the whole mass produces about a thousand rugs, all exactly the same pattern. It is this power of repetition which makes the process pay; for the great preparatory labour of selecting and arranging (say) 600,000 distinct threads could not otherwise be compensated for.

MOSAYLIMA (Little Moslem), one of the most important rivals of Mohammed, belonged to the clan Dâl, a division of the tribe of the Bani Hanifah, of Yamâma in Nedjed. The traditions about his life and age are extremely contradictory and legendary. It appears, however, tolerably certain that he had risen to a certain eminence in his tribe, probably as a religious teacher only at first, before Mohammed assumed his prophetic office. The name he was known by among his friends was Rahmân, the Benignant or Merciful; a term which Mohammed adopted as a designation of God himself. This word, which is Aramaic, was a common divine epithet among the Jews, from whom Mohammed took it, together with a vast bulk of dogmas, and ceremonies, and legends. If, however, M., as is supposed by some, assumed that name in the meaning of Messiah, Saviour, it would prove that he had anticipated Mohammed in the apostleship, which is commonly denied. It was in the ninth year of the Hedjrah that M., at the head of an embassy sent by his tribe, appeared before Mohammed, in order to settle certain points of dispute. The traditions are very contradictory on the circumstance whether or not M. was then already the recognised spiritual leader of his tribe. When they were introduced to Mohammed in the mosque, they greeted him with the orthodox salutation of Moslems—viz., 'Salâm alayk' (Peace upon thee), and after a brief parley, recited the confession of faith. Shortly after this event, M. openly professed himself to be a prophet, as well as Mohammed. The latter sent a messenger to him, as soon as he heard of this, to request him to reiterate publicly his profession of Islam. M.'s answer was a request that Mohammed should share his power with him. 'From Mosaylima, the Apostle of God,' he wrote, according to Abufeda, 'to Mohammed, the Apostle of God. Now let the earth be half mine, and half thine.' Mohammed speedily replied: 'From Mohammed, the Apostle of God, to Mosaylima, the liar. The earth is God's: He giveth

the same for inheritance unto such of his servants as He pleases, and the happy issue shall attend those who fear Him.' Yet notwithstanding these testimonies, of probably late dates, it seems, on the other hand, perfectly certain that Mohammed made very great concessions to his rival—concessions that point to his having secretly nominated M. his successor, and that he by this means bought M.'s open allegiance during his lifetime. It was not a question of dogmas, though they each had special revelations, but a question of supremacy, which was thus settled amicably. 'Mohammed,' M. said, 'is appointed by God to settle the principal points of faith, and I to supplement them.' He further had a revelation, in accordance with Mohammed's: 'We have sent to every nation its own prophet,' to the effect: 'We have given unto thee [M.] a number of people; keep them to thyself, and advance. But be cautious, and desire not too much; and do not enter into rival fights.'

When Mohammed was at the point of death, he desired to write his will. Whatever he may have wished to ordain, is uncertain; it is well known, at all events, that his friends did not obey his order, and refused to furnish him with writing-materials, very probably because they did not like to be bound by his last injunctions. Sprenger supposes that he wished formally to appoint M. his successor, and that it was just this which his surrounding relations feared. M. then openly declared against Islam, and many parodies of the Koran sprang up in the Nedjed, ascribed to him. In the 11th year of the Hedjrah, it at last came to an open breach between the two rival powers. Abu Bekr, the calif, sent Khalid, 'the Sword of the Faith,' with a number of choice troops, to compel M. to submission. M. awaited the enemy at Rowdah, a village in the Wadi Hanifah. So formidable indeed was M.'s force, that Walid is said to have hesitated for a whole day and night before he undertook an assault unanimously disapproved of by his council. On the second morning, however, he advanced, and in a battle which lasted until the evening, contrived, with fearful losses of his own, to gain the victory. M. fell by the hands of a negro slave, and his head was cut off by the conqueror, and placed at the head of a spear, to convince both friends and foes of his death. Khalid then advanced to the slain prophet's birthplace, in order to slay all its inhabitants. They, however, by a clever stratagem contrived to conclude an honourable peace, but had to embrace Islam. The Mosleyman 'heresy' was thus stamped out, and only a few scattered remnants of the new faith contrived to escape to Hass and Basrah, where they may have laid the foundation of the later Karmathian creed.

It is extremely difficult to come to any clear notion of M.'s real doctrines, as all the accounts that have survived of them come from vicious adversaries—adversaries who have not hesitated to invent the most scandalous stories about him. Thus, a love-adventure between M. and the prophetess Sajâh, the wife of a soothsayer of Yamâma, who is supposed to have stayed three days in his tent, is told with great minuteness, even to the obscene conversation that is supposed to have taken place between them during that time; the fact being that this story, which is still told with much relish by the natives, is without the slightest foundation. From the same source, we learn that M. tried to deceive his followers by conjuring-tricks. It seems, on the contrary, that M. was of much higher moral standing than Mohammed himself. Thus, he is said to have enjoined the highest chastity even among married people: unless there was hope of begetting children, there should be restriction of

conjugal duty. Even the nickname, 'Little Moslem,' given to him seems to indicate that he, too, preached the unity of God, or Islam, as the fundamental doctrine of faith. How far his religion had a socialist tendency, and offered less show of dignity and outward morality to its followers, or whether it rejected fatalism, contained an idea of incarnation, and invested its preachers and teachers with a semi-mediatorial character, as the latest explorer of the Nedjed, Mr Palgrave, tells us, we have no means of judging. But we must receive these conclusions, probably drawn from the information of the natives, with all the greater caution, as that story of the prophetess Sajáh, whom he reports, after his informants, not only to have been properly married to M., but to have, after his death, become a devout partisan of Islam, and to have entered an 'orthodox alliance,' does not, as we said before, deserve the slightest credence.

MOSKWA, a river of European Russia, a branch of the Oka, which is itself a branch of the Volga. It is celebrated in history for the great battle, called the battle of Borodino (q. v.), fought on its banks, 7th September 1812, from which Ney (q. v.) obtained his title Prince of Moskwa. The M. rises in a marsh in the government of Smolensk, passes close by the towns of Moshaisk and Svenigrod, passes through the city of Moscow, and joins the Oka near Kolomna, in the government of Moscow. The whole length of its course is about 290 miles. A considerable commerce is carried on by boats on the M., and it is directly connected with the Volga by the *M. Canal*.

MOTAZILITES, or MUTAZALITES, a 'heretical' Mohammedan sect, dating a few generations after Mohammed, of which brief mention has been made under the heading MOHAMMEDAN SECTS. Their name is derived from an Arabic word, denoting 'to separate one's self,' and originally applied to any special sect or union of men; but the M. becoming the most important and dangerous in Islam, they received this denomination by way of eminence. They were also called Moattalites—i. e., those who divest God of His attributes—and Kadarija, i. e., 'those who hold that man has a free will, and deny the strict doctrine of predestination.' The first beginnings of this sect are traced to Mabud, who, in the time of Mohammed himself, already began to question predestination, by pointing out how kings carry on unjust wars, kill men, and steal their goods, and all the while pretend to be merely executing God's decrees. The real founder of the sect, as such, however, is Wasil b. Ata. He denied God's 'qualities,' such as knowledge, power, will, life, as leading to, if not directly implying, polytheism. As to predestination itself, this he only allowed to exist with regard to the outward good or evil that befalls man, such as illness or recovery, death or life, but man's actions he held to be entirely in his own hands. God, he said, had given commandments to mankind, and it was not to be supposed that He had, at the same time, preordained that some should disobey these commandments, and that, further, they should be punished for it. Man alone was the agent in his good or evil actions, in his belief or unbelief, obedience or disobedience, and he is rewarded according to his deeds. These doctrines were further developed by his disciple, Abu-l-Hudail, who did not deny so absolutely God's 'qualities,' but modified their meaning in the manner of the Greek philosophers, viz., that every quality was also God's essence. The attributes are thus not without but within Him, and so far from being a multiplicity, they merely designate the various ways of the manifestations of the Godhead. God's will he declared to be a

peculiar kind of knowledge, through which God did what He foresaw to be salutary in the end. Man's freedom of action is only possible in this world. In the next, all will be according to necessary laws immutably preordained. The righteous will enjoy everlasting bliss; and for the wicked, everlasting punishment will be decreed. Another very dangerous doctrine of his system was the assumption that, before the Koran had been revealed, man had already come to the conclusion of right and wrong. By his inner intellect, he held, everybody must and does know—even without the aid of the divinely given commandments—whether the thing he is doing be right or wrong, just or unjust, true or false. He is further supposed to have held, that unless a man be killed by violent means, his life would neither be prolonged nor shortened by 'supernatural' agencies. His belief in the traditions was also by no means an absolute one. There was no special security, he said, in a long, unbroken chain of witnesses, considering that one fallible man among them could corrupt the whole truth.

Many were the branches of these Motazilites. There were, apart from the disciples of Abu-l-Hudail, of whom we have just spoken, the Jobbaisans, who adopted Abu Ali Al-Wahhab's (Al-Jobbá's) opinion, to the effect, that the knowledge ascribed to God was not an 'attribute;' nor was his knowing 'necessary;' nor did sin prove anything as to the belief or unbelief of him who committed it, who would anyhow be subjected to eternal punishment if he died in it, &c.—Besides these, there were the disciples of Abu Hashem—the Hashemites, who held that an infidel was not the creation of God, who could not produce evil.—Another branch of the M. were the disciples of Ahmed Ibn Hayet, who held that Christ was the eternal word *incarnate*, and assumed a real body; that there were two gods, or creators, one eternal, viz., the Most High God, and the other not eternal, viz., Christ—not unlike the Socinian and Arian theories on this subject; that there is a successive transmigration of the soul from one body into another, and that the last body will enjoy the reward or suffer the punishments due to each soul; and that God will be seen at the resurrection with the eyes of understanding, not of the body.

Four more divisions of this sect are mentioned, viz., the Jâhedhians, whose master's notion about the Koran was, that it was 'a body that might grow into a man, and sometimes into a beast, or to have, as others put it, two faces—one human, the other that of an animal, according to the different interpretations.' He further taught them, that the damned would become fire, and thus be attracted by hell; also, that the mere belief in God and the Prophet constituted a 'faithful.'—Of rather different tendencies was Al-Mozdar, the founder of the branch of the Mozdarians. He not only held the Koran to be uncreated and eternal, but so far from denying God the power of doing evil, he declared it to be possible for God to be a liar and unjust.—Another branch was formed by the Pasharians, who, while they carried man's free agency rather to excess, yet held that God might doom even an infant to eternal punishment—all the while granting that He would be unjust in so doing.—The last of these Motazilite sectarians we shall mention are the Thamamians, who held, after their master, Thamâna, that sinners would undergo eternal damnation and punishment; that free actions have no producing author; and that, at the resurrection, all infidels, atheists, Jews, Christians, Magians, and heretics should be returned to dust. We cannot, in this place, enlarge upon the different schools

founded by the M., nor upon their subsequent fate. The vast scientific development, however, which their doctrines begot, and which resulted in the encyclopaedic labours called 'The Treatises of the Sincere Brethren and True Friends,' are touched upon under *SINCERE BROTHERN* (q. v. in SUPP., Vol. X.).—See Weil, *Geschichte der Khalifen*; Sale's *Koran*; Steiner, *Mutaziliten*; Dieterici, *Transactions of the German Oriental Society*, &c.

**MOUNTMELICK**, a market-town and seat of poor-law union, in Queen's County, province of Leinster, Ireland. It is situated on the river Owenass, a branch of the Barrow, 47 miles directly west-south-west from Dublin. The pop. in 1871 was 3315. The town has long been a chief seat of the Society of Friends, who established a manufactory of coarse woollen friezes and tweeds, by which many poor children are employed. M. was also the seat of other manufactures, especially a foundry, a machine-factory, and a beet-root sugar factory, the results of which, however, were disappointing.

**MOUSA**, an island of Shetland, remarkable for an object of antiquity styled Burgh-Mousa, which consists of a round tower of the class known in the north of Scotland as Pictish towers. Burgh-Mousa occupies a knoll close upon the rocky sea-beach, from which materials for its construction had been taken. The whole fabric is composed of flat slabs of clay-slate, which have been easily piled together in a compact mass without the aid of mortar. In exterior figure, the tower is round, inclining inwards about

lighted by apertures to the interior; such dismal holes being all that we find in the way of apertures. It is customary to speak of an outer and inner wall; but the two walls, if we so distinguish them, are so firmly bound together by the stair and otherwise, as to afford a united resistance to assault. Obviously, the structure was used as a retreat in case of attack from foreign enemies, against whom missiles could be showered down from the species of battlement formed by the top of the well-knit walls. According to tradition, the tower of Mousa was occupied by Erland, a Norwegian Jarl, about 1154, when it successfully endured a siege that was undertaken to recover a runaway lady; but how any lady could have found accommodation in such miserable quarters, it is difficult to conjecture. The Society of Scottish Antiquaries deserves thanks for having repaired this fine memorial of a former state of society in Shetland. From its comparatively complete state, Burgh-Mousa is considered a good specimen of the Pictish towers, so called.

**MOVILLE**, a small market-town of Ireland, in the county of Donegal, on Lough Foyle, 18 miles N.N.E. of Londonderry. It is a calling-station of the Transatlantic steam-packets of the Anchor and Allan lines. Pop. (1871) 1208.

**MOZDO'K**, a town and fortress of South Russia, in the government of Caucasus, about 142 m. north of Tiflis. Pop. (1867) 8543, chiefly Armenians.

**MUCH WOOLTON** (i. e., *Great Woolton*), a town of Lancashire, England, six miles from Liver-

pool. The town is rapidly increasing in size on account of the proximity of a branch of the North-Western Railway, which runs within two miles. M. W. has long been noted for a stone obtained from a neighbouring quarry, which gives employment to a considerable number of men. Pop. (1871) 4643. Near M. W. is the village of Little Woolton, with a pop. of about 1000.

**MUCKERS**, the popular name of an extraordinary sect, which sprung up at Königsberg, in Germany, in 1835. The movement seems to have originated in the dualistic and Gnostic views of John Henry Schönher (who was born at Memel in 1771, and died at Königsberg in 1826) concerning the origination of the universe by the combination of two spiritual and sensual principles. His followers carried out his system much more completely

than himself. The most notable of them were two clergymen, Ebel and Diestel, the former an arch-deacon. By them, sexual connection would seem to have been elevated into an act of worship, and the chief means of the sanctification of the flesh, by which the paradisiac state was to be restored. Ebel and Diestel founded a society, to which women—some of noble birth—attached themselves. Three ladies lived in Ebel's house, who were popularly regarded as his three wives; and Mr Hepworth Dixon, in his work entitled *Spiritual Wives* (1863), tells us that one of them, a young widowed countess, whose beloved husband had fallen on the field of Lützen, and whom he enticed from the seclusion and deep melancholy in which she lived, was described by him as representing to him the principle of Light (*Licht-natur*); another of the ladies represented the principle of Darkness (*Finsteris-natur*);



Burgh-Mousa.

half-way up, and then bulging out near the top. Near the foundation, its circumference is 158 feet, and it measures about 40 feet in height. On the side next the sea, there is a doorway, and that is the only exterior aperture. If there were ever any door-posts, they have disappeared; it is feebly conjectured, however, that instead of employing a door, the inmates had, on emergencies, built up the opening, for which there is an abundance of loose materials at hand. Entering the doorway, we find the wall sixteen feet thick, and looking upwards, feel as if we were at the bottom of a well, for the circular interior has no flooring, and the top is open to the sky. Opposite the doorway, there is an entrance to a passage and stair, which wind upwards, within the thickness of the wall, to the summit of the building. At different places, there are recesses, or galleries, leading off from the stair,

and the third represented the principle of Union (*Umfassung*). The last was his legal wife, but held the most subordinate place in his extraordinary household. Ere long, public feeling was excited against the M., who were said to be guilty, under forms of piety, of the most odious licentiousness in their meetings. The scandal became great in Königsberg, and a garden there acquired the name of the Seraphs' Grova. The subject was brought before the courts (1839—1842), and the result was that Ebel and Diestel were degraded from their offices, and the latter was further punished by imprisonment. It is alleged, however, by some who have examined the whole evidence produced, that the decisions did not proceed upon a calm judicial inquiry, but were dictated by strong prejudice against the accused, on account of their religious views and peculiar eccentricities; and, in particular, that the evidence gives no support whatever to the charge of licentiousness. Mr Hepworth Dixon has directed attention to the similarity of the Mucker movement with that of the Princeites (see AGAPEMONE) in England, and that of the Bible Communists or Perfectionists (q. v. in SUPP., Vol. X.) in America, all of which took place about the same time, and in connection with revival excitement, although it may almost be regarded as certain that the originators of these movements had not even heard of each other.

**MUD-FISH** (*Amia*), a very curious genus of fishes, forming the family *Amiida* of the order *Ganoidei* of Müller, although its position among the *Ganoidei* is determined only by anatomical characters, in which it agrees with sturgeons and the rest of that order, for the scales are not ganoid, and are not osseous plates, but are flexible and rounded, and destitute of enamel. Similar scales, however, are found in fossil genera regarded by Agassiz as ganoid. In habit, the M. resembles osseous fishes rather than ganoids. Except in the absence of teeth on the tongue, the mouth resembles that of a trout. The body is long and flexible, with a bony vertebral column; there are two nasal cirri; the head is flat, covered with a very thin mucous skin, immediately under which the bones appear as sculptured plates. More than ten species are known, natives of the fresh waters of America. The WESTERN M. (*A. calva*) is from a foot and a half to three feet long, bluish-black above, white below. It inhabits the great northern lakes of North America, and is found as far south as Carolina. It feeds chiefly on crawfish and other crustaceans. It is not esteemed as an article of food, although sometimes used by the Indians.

**MUHESUR**, a town of India, in the territory of Indore (q. v.), on the right bank of the Nerbudda, 280 miles north-east of Bombay. The fort contains many houses within its enclosure, but is in bad repair. There is a new palace, built of gray basalt, and overcharged with sculptures of human beings, and of elephants, tigers, and other animals. There are also numerous and costly Hindu temples, erected by Ahalya Bai, relict of Kunda Rao, son of Maharajah Mulhar Rao. The river, which is here about 2000 feet wide, has a rapid stream of blue water, rushing over a rocky bottom; the banks are 60 or 80 feet high in the dry season. Access to the water is gained by a ghât, or vast flight of stone stairs, which extends below the water at its lowest level. Pop. about 17,000.

**MÜLLER, JULIUS**, a German theologian, was born at Brieg, on April 10, 1801, and was a brother of Charles Otfried Müller (q. v.), the antiquary. He studied at Breslau and Göttingen, at first devoting himself to law, but afterwards to theology. After

much mental struggle, he adopted religious views opposed to those of the Rationalists. In 1825, he was appointed pastor at Schönbrenn and Rosen, near Strehlen, where he remained seven years. Having acquired a high reputation for theological learning, he was appointed in 1831 second university preacher in Göttingen, and there lectured on practical theology and pedagogics. The spirit in which he laboured there may be seen from his sermons, entitled *Das Christliche Leben, seine Kämpfe und seine Vollendung* (The Christian Life, its Struggles and its Perfection; Bresl. 1834; 3d ed. 1847). In 1834, he became Extraordinary Professor of Theology in Göttingen, and soon after Ordinary Professor in Marburg, from which he went in 1839 to occupy a similar chair in Halle. The work on which his reputation as a theologian chiefly rests is that on Sin, *Die Christliche Lehre von der Sünde* (Bresl. 1839; 3d ed., revised and enlarged, 2 vols., 1849), which has been translated into English (2 vols., Edin. 1852—1853). He afterwards published pamphlets on subjects of temporary interest, particularly in vindication of the cause of Evangelical union against the attacks of the rigid Lutherans; and in 1850, he began, in conjunction with Neander and Nitzsch, a periodical, entitled *Deutsche Zeitschrift für Christliche Wissenschaft und Christliches Leben*. He also contributed to the *Theol. Studien und Kritiken*. His work *Die Evangelische Union* appeared in 1854.

**MUNKA'OS**, a market-town of Hungary, situated on an affluent of the Theiss, 178 miles north-east of Pesth. The inhabitants are mostly artisans, and the chief production is hosiery. There are also alum manufactories, saltpetre-works, and in the vicinity, iron-works and mines of rock-crystal, called Hungarian diamonds. A short distance east from the town is the fortress (founded in 1359) of M., built upon an isolated height, which, although small and insignificant-looking, yet, from its strong walls and advantageous position, has, for the last few centuries, withstood many a siege. Since the beginning of the present century, it has been used as a state-prison. Pop. (1869) 8602.

**MURGAB**, a river of Central Asia, which rises on the northern border of Afghanistan, in the Hindu Kush, immediately to the north of the sources of the Heri (q. v. in SUPP., Vol. X.). The M. flows westward, then north-westward, and finally northward, passing from amongst the mountains in which it has its source into the desert plains of Turkestan, where the volume of its water gradually diminishes, until it finally loses itself in a swamp in the sandy plain of Merv, after a course of about 400 miles. In the upper part of its course it receives many tributaries, but none in the lower. The most noteworthy place on its banks is Merv, or Meru (anc. *Antiocheia Margiana*), a town of Independent Turkestan, about 300 miles south-east from Khiva. Merv was an important town in the days of the Seljuk dynasty, of which it was the capital, but is now very ruinous.

**MURO**, an episcopal town of South Italy, in the province of Potenza, 17 miles north-west of the town of Potenza. Its castle, built on a height overlooking the ravine, was the scene of the murder of Joanna I., queen of Naples. Pop. 8388.

**MUSCULAR FORCE, ORIGIN OF.** The recent and decisive investigations of Professor Fick and Wislicenus\* of Zürich, of Professor Frankland and of Professor Parkes, have completely

\* A translation of their Memoir may be found in the *Philosophical Magazine* for June 1866 (supplementary number).

overthrown the physiological views on this subject held previous to the year 1866. While the inference from previous experiments was, that the effect of exercise was to cause a very large increase in the elimination of carbon, and a much smaller, but very perceptible increase in the elimination of nitrogen, Fick and Wislicenus (from observations made on the excretion of nitrogen during the ascent of the Faulhorn) deny altogether the increase of the nitrogen, and come to the conclusion, that the force generated in the muscles is the result of the burning (oxidation) of non-nitrogenous substances (fats or carbo-hydrates), and not of the burning of the albuminous constituents of muscular tissue; and they conclude, that the nitrogenous constituents of muscles are rather to be regarded as forming the machine in which these fats or carbo-hydrates are burned, than as the subjects which are burned. Dr Frankland (*Philosophical Magazine*, September 1866) arrives at the conclusion that the non-nitrogenous constituents of the food, such as starch, fat, &c., are the chief sources of the actual energy which becomes partially transformed into muscular work. He does not, however, deny to the albuminous matters a co-operation in the production of muscular power, but he regards their chief use as being to renew the muscular tissue. The muscles are thus the source both of animal heat and of muscular force. One of the latest investigators of this important subject is Professor Parkes, who communicated the result of his inquiries to the Royal Society (see *Proceedings of the Royal Society*, Nos. 89 and 94, 1867). Two series of experiments were made on soldiers at Netley. Two men were kept on ordinary diet and on usual work for four days; were then kept in perfect rest for two days, on a diet free from nitrogen; then finally returned for four days more to their usual food and work. In the second series, the same course was adopted, except that throughout the whole period the men took a constant quantity (302 grains) of nitrogen daily.

The conclusions deduced by Dr Parkes from these experiments were, that Professors Fick and Wislicenus are quite correct in stating that there is no increase of nitrogen eliminated during the period of exercise. There is, on the contrary, a slight decrease. They are not correct in stating that there is no increase after exercise, for there is a perceptible, though not a very large increase. 'Without going into an analysis of the experiments, which would occupy too much space, I believe,' says Dr Parkes in his Sanitary Report, contained in the last volume of the *Army Statistical, Sanitary, and Medical Reports*, 1867, p. 346, 'my results indicate that our ideas of the origin of muscular force and of nutrition generally, must be modified; that during action, muscles appropriate nitrogen, and grow; and that they do not give it off and waste, as was formerly supposed, or undergo no change, as Fick and Wislicenus believe. In other words, formation of nitrogenous tissues goes on during action, and removal of nitrogen goes on during rest. The mechanical force manifested during muscular action is, however, probably derived from changes in the carbo-hydrates, especially the fats, which changes are connected with the appropriation of nitrogen by the muscles.'

The theory of muscular action which he proposes for consideration is this. During action, the muscles appropriate nitrogen; this act is accompanied by changes in the carbo-hydrates, which lead to the manifestation of mechanical force; these changes lead to effete products (lactic acid, &c.) in the muscles, which, as appears from Ranke's experiments, stop their contraction. Then ensues an action of oxygen upon the nitrogenous framework

of the muscle, and a removal of the effete products of the carbo-hydrates, so that the muscle becomes again capable of appropriating nitrogen, and of acting. The amount of truth in this theory must be decided by the investigations of others; it seems the only one which can explain the facts, if these have been correctly made out.

Although it is mainly to the above-named physiologists that we owe our recently acquired knowledge, it deserves mention that previous investigations undertaken on different but allied subjects by other physiological chemists, as, for example, Dr Edward Smith, Lawes and Gilbert, Playfair, and Haughton, are entirely in accordance with our new views.

**MUSIC RECORDER.** Many forms of apparatus have been invented for writing down music in a legible form by the very act of playing it on a keyed instrument, such as the pianoforte or organ. Beginning with 1747, various attempts had been made to effect this object, when, in 1863, Mr Fenby invented and patented his *Phonograph*, in which he brought in the aid of electro-magnetism. His chief aim, as an improvement on previous apparatus, was to devise a method of denoting the length of the notes, as well as their pitch and the interval between them. On pressing down any key of the instrument, a stud on the under side touches a spring; the spring acts in action a small electro-magnetic apparatus, which causes a tracer to pass against a strip of paper moving onward at a uniform rate by means of a cylinder and clockwork. The paper is chemically prepared, so as to receive a brown stain whenever the tracer passes along its surface. The length of each note is expressed by horizontal dashes of greater or less length, made by the tracer; and the arrangement is such as to denote the lines of the staff as well as the character of the note. By subsidiary adjustments, the apparatus is made to express accidental sharps and flats, changes of time, &c.

The Abbé Moigno's *Phonautograph*, introduced to the British Association in 1860, is a contrivance—not for noting down sounds in any kind of musical notation—but for causing a vibrating surface to tell its number and character of vibrations. A kind of spheroidal drum is covered at one end with a diaphragm or stretched membrane; a sheet of paper is carried along this drum-head by means of clockwork; and a system of small levers moves a pen. A tuning-fork, an organ-pipe, or the voice is sounded in proximity to the drum, the body of air within which acts as a reinforcement of the sound; the membrane vibrates in a manner which can be felt by the pen, although not seen by the eye; and the pen makes zigzag markings on the paper. When the sound is produced by a tuning-fork or an organ-pipe, the zigzag lines are so regular that they serve to count the number of vibrations belonging to each particular note. When the sound is that of a singing voice, the markings become very peculiar, especially in such words as contain the gutturals *r, g, &c.*

**MUTTRA**, or **MATHURÁ**, a town of British India, capital of a district in the N. W. Provinces, 97 miles S. S. E. of Delhi, is situated on the right bank of the Jumna. The fort was built by the celebrated astronomer, Jey Singh (who became Prince of Amber in 1693); and on the roof of one of the apartments is a ruinous observatory, containing a great number of astronomical instruments. Access is had to the river—which, along with the town, is considered sacred by the Hindus—by numerous gháts, ornamented with little temples; and its banks are, every morning and evening, crowded by devotees of all ages and both sexes, to perform their religious exercises. In Hindu Mythology, it is regarded

as the birthplace of the divinity Krishna. In honour of the monkey-god Hanuman, monkeys are here protected and fed, being allowed to swarm everywhere. There are also great numbers of parrots, peacocks, and sacred bulls at large, without owners. There is a very extensive military cantonment about a mile south of the town. M. appears at an early period to have been of much more importance than it is at present; and its enormous wealth and splendour made it an object of attack to the first Afghan invaders. Mahmud of Ghuznee, in 1017, gave it up to plunder, breaking down and burning all the idols, and amassing a vast quantity

of gold and silver, of which the idols were made. After this calamity, it sank into comparative obscurity. In Oct. 1803, it was, without resistance, occupied by the British troops. Pop. (1872) 59,281.

MYNPURI, or MAINPURI, a town of British India, capital of a district in the N.W. Provinces, is situated on the banks of a small affluent of the Ganges, 160 miles south-east of Delhi. It lies at an elevation of 620 feet above the sea, and is a favourite station for troops, as provisions and water are abundant and good. M. possesses a Jain temple. The rebels were driven from this place in 1857. Pop. (1871) 21,179.

N



**NAFITIA**, LAGO, a curious small lake in Sicily, about two miles from Mineo, in Catania. It is situated in a plain, amidst craggy hills, and is of a circular form, commonly sixty or seventy yards in diameter, and about fifteen feet deep, but in dry weather shrinking to a much smaller size, and being occasionally altogether dried up. In the midst of it are three small craters, two of which perpetually send up water in jets to the height of two or three feet; the third is more intermittent. The water is greenish, or turbid, and has an odour of bitumen. The whole lake resembles a boiling caldron, from the escape of carbonic acid gas, rushing upwards with great force. The atmosphere is consequently fatal to birds attempting to fly across the surface of the lake, and to small animals which approach it to satisfy their thirst; and an approach to it is attended with headache and other painful circumstances to man himself. The ancients regarded these phenomena with great dread. They supposed that Pluto, when carrying off Proserpine, drove his fiery steeds through this lake, ere his descent to the lower regions. A temple was erected here to the gods of the two craters, the *Dii Palici*, who were supposed to be twin sons of Jupiter by the nymph Thalia. Pilgrims flocked to this shrine; and it afforded an inviolable asylum to slaves who had fled from their masters. An oath by the *Dii Palici* was never broken by the master, who found himself compelled here to come to terms with his runaway slave. No remains of the temple of the *Dii Palici* are left, although it is described as having been magnificent.

**NAGY KAROLY** (i. e., Great Karoly), a town of Hungary, capital of the county Szathmar, 37 miles east-north-east from Debreczin, on a small feeder of the Theiss. It has several important annual fairs, and a trade in corn and cattle. Pop. (1869) 12,754.

**NAMAYCUSH** (*Salmo namaycush*), a fish nearly allied to the salmon and trout, a native of the great lakes and interior rivers of North America. It is often taken of a size varying from 20 to 40 lbs., and is said sometimes to reach 60 lbs. It is much esteemed for the table. It is caught at the same fisheries with the still more prized Whitefish (q. v.).

**NA'NAS**, a town of Hungary, in the midst of extensive morasses, about 110 miles east-north-east from Pesh. The population, partly Protestant and

partly Roman Catholic, is employed in cattle-husbandry and agricultural pursuits. Pop. 11,300.

**NANA SAHIB**, a Hindu, one of the leaders of the sepoy revolt of 1857. He was said to be the son of a Brahman from the Deccan, and his real name was Dhundu Punt. He was born about 1820, and was adopted as a son in 1827 by Bajee Rao, the childless ex-peishwa of Poona, thereby, according to Hindu law and custom, acquiring most of the rights of a legitimate son. He was educated as a Hindu nobleman—taught English, and brought much in contact with the European officers, in whose amusements he seemed fond of participating. A decision was, however, come to by the government of Calcutta, that they should not recognise rights to pensions or indemnities acquired by adoption; and in consequence, N. S. was refused the continuance of a pension of eight lacs of rupees, paid to his adopted father under a treaty made in 1818. This is believed to have rankled in his mind, along with slights he received from the supercilious English youth with whom he came in contact. He was allowed to retain some of the state of a native prince—a retinue of 200 soldiers, with 3 field-pieces, and a fortified residence at Bithoor, 10 miles west of Cawnpore. When the mutiny broke out in May 1857, he offered to assist the English, but instead, he treacherously placed himself at the head of the mutineers. The European troops were induced, on the 25th of June, to capitulate to N. S., who promised they should be sent down the Ganges in safety. They got on board boats provided for them, but had no sooner done so, than two guns were unmasked, and a murderous fire was opened upon them. The sepoys were ordered to shoot the men, but to spare the women and children, who, when their husbands and parents had been shot, were removed to a house in Cawnpore. On the 15th July, Sir H. Havelock, who had advanced to their assistance from Allahabad, defeated the sepoys in two engagements, one within 8 miles of Cawnpore; and N. S. next day directed that the women and children should be put to death, an order carried out with unparalleled atrocity. A long series of engagements against N. S. followed, in which he was always the loser, and he was ultimately driven beyond the English frontier into Nepal. In 1860, his death was announced, but two years later, new movements were discovered, which were attributed to him, and it is not certainly known whether he is dead or alive. Several persons have been arrested on suspicion of being N. S., but in all cases a mistake

has been made. A column has been erected at Cawnpore in memory of those who perished in the massacre.

**NAPOLEON-VENDÉE, BOURBON-VENDÉE, or LA ROCHE SUR YON**, a town of France, the capital of the dep. of Vendée, pleasantly situated on a hill on the right bank of the Yon, 37 miles south from Nantes. The town has no manufactures, and little trade, but derives its importance chiefly from its being the seat of departmental administration. The town contained only 800 inhabitants when Napoleon I. selected it for the capital of the department, granted great sums for its improvement, and called it *Napoleon-Vendée*, changed to *Bourbon-Vendée* at the restoration of the Bourbons, the former name coming again into use under Napoleon III. It is now known as *La Roche sur Yon*. Pop. (1872) 7110.

**NARDO** (anc. *Neretum*), a town of South Italy, in the province of Lecce, 8 miles north-north-east from Gallipoli. N. has manufactures of cotton goods and snuff, from cotton and tobacco grown in the neighbourhood. The surrounding country abounds in olive plantations. Pop. about 8500.

**NASSI'OK, or NASHIK**, a town of British India, in the district of the same name, in the presidency of Bombay, 95 miles north-east of Bombay, on the river Godavery, not far from its source. It is a town of great sacredness in the estimation of the Hindus—more revered than even Benares—is a great place of pilgrimage, the chief seat of Brahmanism in the Deccan, and the residence of many families of Brahmans, some of them living in great affluence. It contains many temples, which are built along both banks of the Godavery, and on rocks in the river. They are all of black basalt, and dedicated to Siva. Of far greater interest, however, are the Buddhist caves, about 5 miles from the town, which are situated in a conical hill, at a height of about 100 yards from its base. They are rudely executed. The figures which they contain are in a state of good preservation, and the leading figures are those of Buddha; but the whole character of the remains is thought to indicate Buddhism in a state of transition or compromise with Brahmanism. One cave is 45 feet square, and its flat roof is wholly unsupported. Notwithstanding the Buddhist origin and character of these caves, the Brahmans of N., for the sake of gain, encourage the popular reverence for them. N. contains a resident pop. of (1872) 22,436.

**NATIONAL EDUCATION, SYSTEMS OF**, the provision made by various states for the education of their citizens. In England, the term national education is commonly used as implying only a provision made for the instruction of children of the poorer classes. But it is capable of a much more extensive application, and in most of the countries in which the state provides for the education of the people, the state regulates, more or less, all instruction, from that of the primary school to that of the university. In England national education has no existence. The Parish Schools (q. v.) of Scotland at one time made a near approach to being national, but the altered religious circumstances of the country have made them cease to be so. The imperfect means adopted to supply the deficiency in both parts of the kingdom, are described under the head of **PRIVY COUNCIL, COMMITTEE OF, ON EDUCATION**. See also **SCHOOLS, PUBLIC AND GRAMMAR; INDUSTRIAL SCHOOLS; REFORMATORY SCHOOLS, &c.** In Ireland the foundation of a really national system was laid in 1833 in the 'National Schools' (supplemented since by the Queen's Colleges and University), the principle of which is briefly stated under **IRELAND**. These

schools have exhibited a steady and even surprising progress, when we consider the determined opposition they have met with from powerful ecclesiastical parties, both Catholic and Protestant. In several of the British colonies the local legislatures have boldly dealt with the question on the national principle, in opposition to the denominational. See **VICTORIA**. As this is likely to be one of the first important subjects to come before the reformed parliament, it may be opportune to give our readers a sketch of what some neighbouring nations have done in regard to it. Before entering upon the description which we propose to give of the principal systems of national education, it will be proper to give some account of the obstacles which have hitherto prevented the establishment of a national system among ourselves, and to indicate some of the matters as to which we have to look for instruction from foreign experience.

And, first, in Great Britain the establishment of a national system of education, and of all interference with education on the part of the state, has until lately been opposed upon principle by a numerous and respectable body of politicians. They for the most part consisted of Dissenters of the middle class, who, beginning with Voluntaryism in ecclesiastical matters, had passed on—at least the leaders had—to the doctrine of *laissez faire* in politics. The others were chiefly speculative persons, deeply imbued with the same doctrine, who, profoundly disbelieving in the wisdom of statesmen, and the capacity of officials, and apparently in the possibility of foresight in large affairs, held that the state should undertake as little as possible, and leave things to what they called their natural course. The arguments used by these two classes were not always alike. Individuals of the former class were apt to go back to the religious ground from which they started, maintaining that education ought to be religious, that the state ought not to teach religion, that therefore education was out of the province of the state. But what the spokesmen of both classes most insisted on was this, that education should be left to the law of supply and demand, or rather, to the voluntary action of individuals, single or combined. It was in that way, they declared, that the education of the people could be most beneficially carried on; for so carried on, it would always be, both in kind and in extent, what, on the whole, the circumstances of the people required. In the hands of government, they said, an educational system must be, more or less, an instrument of state. And at the best, the extent and the quality of the instruction provided must depend upon the will of persons who might be very ignorant of the wants of the people. They used declamation about the bad way in which governments did everything they attempted; about the danger of creating a host of new officials; and about the impropriety of interfering with natural laws, and of discouraging voluntary agency. Then they enlarged upon the great progress which education had made in England since the beginning of this century, independently, as they said, of the state—maintaining not only that it had been as great as the circumstances of the country permitted, but that it was almost as much as the state had accomplished in any country; and that it proved that in England, supply and demand, or the voluntary principle, would soon provide for the education of the whole people. The greater part of the increase in the supply of education, so far as it was not due to the action of the state, had come from the benevolent exertions of individuals. But their chief reliance was upon the agency of individuals or societies inspired by benevolence or

religious zeal. They held that the same objections did not apply to voluntary organisations which lay against the state; they declared that it was the great glory of England to accomplish by such means things which elsewhere were attempted only by the state. Combined voluntary action, they said, was consonant with the national habits and institutions; it was a part of the system which had made the English a free, self-reliant, and enterprising race; it should be fostered, not discouraged; and it was worth our while to pay a price if necessary, rather than let it be superseded by the action of the state.

It was answered, first, that the commercial principle of supply and demand, unless supplemented by the benevolence of individuals, could not be expected to educate the people except by very slow degrees; that education must create the demand for education; that children of the lower classes in large towns, unless assistance or stimulation came to them from without, had at present no more chance of receiving instruction than if they were living in Africa. And the nation would lose incalculably by delay in educating the masses; for nothing would so greatly increase its power and prosperity, so materially improve the condition of the humbler classes, as the education of the whole people. The importance of voluntary agencies was admitted; but why was the state to be precluded from at least co-operating with them? The state, it was said, had a greater interest in educating the people than any of her citizens could have; and, moreover—this was the real question—could undertake it more successfully. Voluntary agency, it was maintained, was too slow, too uncertain, too spasmodic in operation, to be permanently and solely relied upon in a matter of such great national concern. The friends of state action confidently appealed to the experience of foreign countries as shewing the superior efficiency of state education, and pointed to the effects which government stimulation, on a limited scale, had had at home. It is now several years since this controversy was at its height. The Voluntaries have since that been acquiescing in the interference of the state with education; and recently, several of their foremost men have frankly admitted that they had been mistaken, and that the state, by what it has done for education, has made good its claim to the regulation of it. The course of political events has recently added greatly to the importance of popular education; and at present it may be said that there is practically no opposition upon principle to the control of education by the state.

There have always, however, been obstacles to the establishment of a national system more formidable than the opposition of the Voluntaries, and these appear to remain unabated.

The most important of them are those which are concerned with the place, if any, to be assigned to religion in the school instruction. Upon this matter, there is a conflict of opinions which seems almost irreconcilable. A party, which is growing in numbers, and which is respectable from its activity and intelligence, holds that the state should give nothing but secular instruction; that religion is beyond its province, and should not be taught within its schools; that, indeed, with a population divided into numerous sects, a practicable scheme of state education embracing religion cannot be devised. To this party, a portion of the English Voluntaries now seems disposed to ally itself. There are others who believe it possible to teach an undenominational Christianity in schools; who desire that the state schoolmaster should confine himself to this; and that dogmatic teaching should be left to the religious bodies. A third party hold that dogmatic

teaching should be given in state schools; that religious teaching, to have any value, must be dogmatic; but that arrangements might be made for the religious instruction of children by persons of their own persuasions; and, at anyrate, that children should be exempted from the religious instruction given in a school, if their parents should so desire. The most numerous body of all are satisfied with the system of aiding denominational schools which now exists; because they approve of schools being, as for the most part they now are, under clerical supervision, and fear that by any change the influence of the clergy upon education would be weakened. Among the managers of Church of England schools, fault is scarcely found with more than one point in the present system; there is an incessant agitation against the 'Conscience Clause,' which the state has placed among the conditions of its aid, by which is stipulated that religious instruction shall not be given contrary to the wish of the parent. Between the Denominationalist and the Secularist there is a difference which scarcely admits of compromise; and until they agree, a national system is hardly possible. The former would most probably oppose any scheme for supplementing the Denominational system—for the purpose of educating the classes which this system does not educate—unless it were to include religious teaching.

The question of religious instruction has been found a troublesome one in nearly every country where the state regulates education, and there is nothing more instructive, in foreign experience, than the ways in which, in different systems, this difficulty has been disposed of. Next to this, the most important thing to be observed is, the parts which, in different systems, are assigned to the state and to the locality respectively; for it is unquestionable that there are some dangers attaching to state education, when the influence of the state is predominant, and that the function of the state in education must be carefully defined. By the mere selection of school-books, the state could powerfully influence the rising generation; and in Austria, and, it is said, in France also, the school has been made use of as an instrument of state policy. With a popular government, however, there is not much risk of it being used for sinister purposes; and in this country, we are in more danger of having recourse too little to the powers of the state than of trusting it too much. The possibility of making education compulsory, is another matter upon which foreign systems of education throw much light: we are perhaps more interested in noting how far indirect methods can be resorted to for compelling attendance at the schools. Upon the limits of the instruction which should be attempted in schools for the poorer classes—a subject which has been much discussed in connection with the Revised Code of 1861—and upon the results of government regulation of the middle and upper schools also, there is much to be learned from the foreign educational systems. We begin with

#### *State-education in Holland.*

There are several countries in which—if school statistics could be taken as a test—popular instruction is more widely diffused than it is in Holland; but in no European country is it so uncommon to meet a man who cannot easily read and write. The primary schools of Holland have a high reputation for the solidity of the instruction they impart, and have, by competent observers, been declared to be the best in Europe. A small and wealthy state—rich, too, in the public spirit of its citizens—with a population singularly docile and orderly, the task of educating the people has been



for Holland exceptionally free from difficulty. It had the start of most other European nations in the work of popular education. So far back as 1811, its primary schools had been celebrated in a Report by the famous Cuvier. It has had an education law since 1806; and of this law, though it underwent modification in 1857, it is necessary to give some account. Its author was M. Van Den Ende, who, from 1806 till 1833, had the superintendence of popular education in the country.

On the face of it, this law seemed far from making a complete provision for the education of the people; it left much—in any other country, it would have been a great deal too much—to the public spirit of local authorities. It did not make education compulsory; it did not even enforce the establishment of public schools; but it provided for two things being done thoroughly—the inspection of the schools and the examination of the teachers—and to this seems to have been chiefly due its eminent success. Each province of Holland was formed into a certain number of school-districts, and over each school-district was placed an inspector. The inspector was made supreme over primary instruction in his district. He was a member of every school-committee, and school-committees could be named only with his concurrence; no teacher, public or private, could exercise his calling without his permission; and he inspected every school in his district twice a year. The united inspectors of the province formed the provincial commission for primary education. This commission met three times a year, and received from each of its members a report upon his district; once a year, it sent a deputy to the Hague, to form, with the deputies from other provinces, a commission to discuss and regulate school-matters, under the direction of the Minister for the Home Department and his Inspector-general. The inspectors in the various provinces were appointed by the Home Office, on the presentation of the provincial commission. It has been said that in Holland public spirit is very strong. State-employments are thus deemed very honourable; and the inspectors gave their services gratuitously—receiving only an allowance for expenses. It was one of the duties of the provincial commission to examine teachers for certificates. First, the teacher had to get a *general admission*—a certificate of competency, admitting him into the teaching profession; he had to get a *special admission* also, before he could exercise his profession. There were four grades of certificates—the first or second grade had to be obtained by a school-master, public or private, in the towns; the third grade qualified for a village-school; the fourth grade was for under-masters and assistants. To the highest grade were admitted those candidates only who gave signs of a *distinguished culture*. For public masterships, when they fell vacant, a competitive examination was held; the successful candidate received his *special admission*—his appointment to exercise his profession in the school. For special admission as a private teacher, there was no second examination; it was in the power of the municipality, with the concurrence of the inspector, to grant it upon application. Although there were no obligatory provisions in the law, the provincial and communal administrations were charged by the government to provide the means of instruction in their localities, to insure a comfortable subsistence for teachers, and to obtain a regular attendance of the children in the schools; and they did all this to the best of their ability. Free schools for the poor were provided in the towns; in the villages, schools to which the poor were admitted gratuitously. Every effort was used, both by the lay

authorities and the clergy, to draw poor children into the schools; and the schoolmasters were provided with incomes much superior to what is usually paid to schoolmasters in any other European country. To this M. Cuvier attributed much of the success of the Dutch schools. Some of the best scholars were kept in the school to assist in the teaching; they became under-masters, and eventually masters; and thus, even before the institution of normal schools, an efficient body of teachers was provided. In the normal schools which were afterwards established, school-methods and the practice of teaching formed a more prominent part of the instruction than in those of other countries. It soon appeared, that the free schools for the poor in towns were giving better instruction than could be obtained by the lower middling classes; and intermediate schools had to be established in the towns (*tusschen-schoolen*), in which, for a small fee, an excellent education was provided. Above the intermediate school was the French school, in which, besides a sound commercial education, modern languages were taught; above that was the Latin school, giving a classical education, and preparing for the universities. The classical schools and the universities of Holland do not receive from foreign observers the commendation so freely bestowed upon the other parts of the educational system of the country.

Under this law, the public schools were non-denominational; no dogmatic instruction was to be given by the teacher or in the school; but the instruction was to be such as to 'train its recipients for the exercise of all social and Christian virtues.' The religious education of the children, however, was not overlooked. The government exhorted the clergy of the different communions to take upon them the religious instruction of children of their own persuasions; and this the clergy willingly did—giving up a portion of every Sunday to this duty. The schoolmaster instructed the children in the truths common to all religions, and on Saturdays, when the Jews were absent, in the New Testament and the Life of Christ. M. Cuvier, in 1811, stated that he found the education religious, though not dogmatic; and in 1836, high satisfaction with it was expressed by M. Cousin, an earnest advocate of religious education. It was thought that the Dutch schools had proved the possibility of teaching in schools an unsectarian Christianity. But it was chiefly upon this point that the controversy arose which led to the enactment of 1857; and as regards it, it cannot be said that the controversy is yet ended.

There were other matters which excited a demand for the alterations then made in the law. The constitution of 1848 had granted the liberty of instruction, and was therefore in conflict with the law of 1806. The school-attendance had been falling off. Some of the municipalities had been evading their duty to the schoolmasters and the schools. It was thought desirable that the duties of the commune in regard to education should be carefully defined by law. The changes made, however, were not of much practical importance.

The law of 1857 granted 'liberty of instruction;' still requiring from the private teacher the certificate of competency, it rid him of the veto of the municipality and the inspector. It expressly prescribes that primary schools, in each commune, shall be at the commune's charge; they are to be in sufficient number; and the states' deputies and the supreme government are to judge whether, in any commune, they are in sufficient number or not. If the charge of its schools is too heavy for a

commune, it receives a grant in aid, of which the state and the province each contributes half; but there is no fixed point at which the commune can demand this aid. The law fixes the minimum salary for a schoolmaster at 400 florins (about £34); for an under-master at 200 florins. (The schoolmaster's salary, however, is usually much higher; in towns, not unfrequently four times as much.) It provides that when the number of scholars exceeds 70, the master is to have the aid of a pupil-teacher; when it exceeds 100, of an under-master; when it exceeds 150, of an under-master and pupil-teacher; for every 50 scholars above this last number, he is allowed another pupil-teacher; for every 100 scholars, another under-master. School-fees are to be exacted only of those who can afford to pay them; and the municipalities are enjoined to 'provide as far as possible for the attendance at school of all children whose parents are in the receipt of public relief.' The law defines the subjects of primary instruction as follows: Reading, writing, arithmetic, the elements of geometry, of Dutch grammar, of geography, of history, of the natural sciences, and singing. There is still a competitive examination for the office of public schoolmaster; a list of those who have acquitted themselves best is made up by the inspector and a committee of the communal council, and from this list the selection is made by the whole body of the council. For the provincial commission, consisting of the inspectors of the province, there has been substituted a salaried provincial inspector; and the provincial inspectors are assembled once a year to deliberate upon the state of primary instruction. The Minister of the Home Department, assisted by a referendary, is the supreme authority in matters connected with education.

Upon the subject of religious instruction, the law was left unaltered. The enactment of 1857 provides as follows: 'Primary instruction, while it imparts the information necessary, is to tend to develop the reason of the young, and to train them to the exercise of all Christian and social virtues. The teacher shall abstain from teaching, doing, or permitting anything contrary to the respect due to the convictions of Dissenters. Religious instruction is left to the different religious communions. The schoolroom may be put at their disposal for that purpose, for the benefit of children attending school, out of school-hours.' This was the conclusion arrived at, after much excited discussion.

In 1848, all religions were, in Holland, placed by the law on a perfect equality; and immediately thereafter, an attack was begun by the Roman Catholics on the religious instruction of the schools. Professedly neutral, they maintained that it was really Protestant, and probably they were right. The schoolmasters, on the demand of the Roman Catholics, were enjoined to comply more strictly with the law; and thereupon there began among the orthodox Protestant bodies a violent agitation against the law—a movement for connecting every public school with some religious communion. The Roman Catholics, believing that in Holland neutral schools must be Protestant, desired that the instruction should be purely secular; and a considerable party among the Protestants contended for the same object. The only party in favour of the existing law were the Rationalist or New-school Protestants, who attach more importance to the moral and civilising side of Christianity than to its dogmatic aspects. Between the Denominationalists on one hand and the Secularists on the other, the victory fell to this last party. Of course, the decision was a compromise; and neither the High Protestant party nor the Roman Catholics regard it with

satisfaction. The consequence has been that, advantage being taken of the newly-conceded freedom of instruction, there has been a great increase in the number of private elementary schools conducted on the denominational basis. The non-denominational school in Holland cannot be considered entirely successful, since the opposition to it seems to be leading to primary education being to a considerable extent taken out of the control of the state.

*State-education in Switzerland.*

In no part of Europe has the education of the people been more successfully prosecuted than in Switzerland. In all the cantons, French and German, it has been carefully attended to by the governing bodies; and for small communities, provided the rulers have intelligence and public spirit, it is comparatively a simple and easy task. To those who are interested in school-methods and school-management, nothing can be more instructive than the education of the German cantons. Their primary schools are unsurpassed; those of the canton Aargau have the reputation of being the best in Europe. The experience of the French cantons throws light upon more than one of the questions which occur in the construction of a national system. It is with the latter class of questions that we are concerned; and to the French cantons—Geneva, Vaud, Freiburg, Neuchâtel, and the Valais—the following statement is confined.

In these five cantons, the school-system was, until recently, the same in its main outlines; it was a system designed to put public education in harmony with the democratic constitutions established after the war of the Sonderbund. In Vaud, it was founded in 1846; in Geneva and Freiburg, in 1848; in the Valais, in 1849; and in Neuchâtel, in 1850. In Freiburg, it underwent modification in 1856. Its main features were as follows: The communes were required to provide and maintain public schools, the state assisting them when the charge became too heavy. In general, every place with more than 20 children of school-age was required to have its school; every place with more than 50 or 60, a second school; and so on. Infant-schools were recommended and aided by the state, but their establishment was not made obligatory. The council of state—the supreme executive—of the canton appointed a Board of Public Instruction to exercise the government of education; but in important matters, an appeal lay from this body to the council; and by the council only could a master be dismissed. The municipality appointed a communal school-committee, which had the local superintendence of the schools. Ministers of religion were eligible for this body, but were not members of it by virtue of office. It was the duty of the school-committee to visit the schools of its commune not less than once a fortnight, besides holding a public general examination of them once a year. The teacher required to get a certificate of capacity; the examinations for the certificate being under the management of the Board of Public Instruction. In Vaud, however, five years' service in a public school exempted a teacher from the obligation of a certificate; and in other cantons, it does not seem to have been rigidly insisted on. For vacant masterships, there was a competitive examination, to which persons qualified by certificate or service only were properly admitted; in Vaud, however, failing qualified persons, other candidates might be admitted to examination, and provisionally appointed. In Geneva, Freiburg, and the Valais, there were school inspectors who periodically reported to the Board of Public Instruction;

Vaud and Neuchâtel had no inspectors; the duty of inspection in these cantons devolved upon the school-committee. The subjects taught were religion, reading, writing, grammar, arithmetic and book-keeping, geography, Swiss history, and singing. The instruction given had two or more degrees (in Geneva, six degrees), according as these subjects were taught with more or less extension; instruction in both degrees being usually given in the same school, and by the same master. Education was to be based upon the 'principles of Christianity and democracy.' Hours were to be set apart for religious instruction; from the ordinary school-lessons, dogma was to be strictly excluded; and it was regarded as the province of the minister of religion, not of the schoolmaster, to give religious instruction, though the latter was not prevented from giving it in the room of, and under the responsibility of a minister. In all the cantons, except Geneva, education was made compulsory; attendance at school was required from the seventh to the fifteenth, or from the eighth to the sixteenth year. If children were privately educated, the state must be satisfied that their education was sufficient; such children could be called up for examination with the scholars of the public schools, and if found inferior, might be transferred to a public school. A certificate of emancipation was granted when the obligatory course had been fulfilled. The law contemplated that the instruction should be gratuitous, and in Geneva and the Valais it was gratuitous.

In Freiburg, the school-system was framed in no small degree for the purpose of strengthening the democratic party against the clerical party. It provided that no religious society should be allowed to teach; that persons educated by the Jesuits should be incapable of holding any office in church or state; it imposed a political oath upon the schoolmaster; it prohibited children from being sent to a private school, except with the sanction of the inspector and the school-committee; and if sent, required that they should come up for examination every half-year. At the same time, it established an excellent programme of primary instruction. At the elections of 1856, the clerical party regained the ascendancy in Freiburg; and in January 1858, the council of state made a considerable alteration in the school-law. It reduced the programme of primary instruction; it made the clergyman a necessary member of the local school-committee, freed the teacher from the necessity of taking an oath, and relaxed the obligation of attendance at the public schools, giving parents liberty to educate their children at home or at private schools. In other respects, the system, as above described, has been maintained in Freiburg. There has been no change in the other cantons.

The law as regards religious instruction seems to work with tolerable smoothness. In Vaud, it appears that the laxity which prevails as to the requirement of a certificate sometimes leads to the admission of unqualified persons as teachers; and in Vaud and Neuchâtel, complaint is made of the incapacity of the school-committee to make up for the want of professional inspection.

In the four cantons in which education is by law compulsory, the school-attendance is found to be no better than in Geneva, where it is not compulsory. In these cantons, the law provides that parents not sending their children to school are to be warned; if the warning be neglected, that they are to be summoned before the tribunals, which can punish them by fine or imprisonment. But it appears that, in point of fact, the tribunals are never resorted to; and that the authorities are careful not to insist upon more than the people are easily able and willing

to comply with. In the Valais, the school-year need not last for more than five months. In Freiburg, the vacation may last for three months; and the inspector may exempt from attendance at school children who are sufficiently advanced, and children whose labour their parents cannot do without. In Vaud, the local school-committee may grant to children above twelve years of age, whose labour is necessary to their parents, dispensations which in a great measure exempt them from attendance at school; the master may grant the scholar leave of absence for two days in the week; the president of the school-committee may grant him leave for a week at a time; the school-committee itself for a month at a time. It appears that in Vaud, the attendance at the schools had been steadily falling off from 1846, the date of the law, up to 1858; and the attendance of the children whose names were on the books was then reported to be by no means regular. New branches of industry which gave employment to children had been introduced into the canton; and the Council of Public Instruction seems to have been compelled to sacrifice the law to the interests of families. The experiment of compulsory education cannot be said to have succeeded, because it has not really been made, in French Switzerland.

#### *State-education in France.*

At the head of the education of France is the Minister of Public Instruction; he is advised and assisted by the Imperial Council of Public Instruction, a body the members of which are appointed by the crown for the period of a year. The minister, if he thinks fit, brings before the council for discussion projected laws and decrees on public education; he is bound to consult it respecting the programmes of study, methods, and books to be adopted in all classes of public schools. The minister has succeeded to the functions in respect of education which, under the first Empire, were conferred upon the University of France; he is head of the university, the officials of which still perform a considerable part in the management of education, but do so under his control. As respects the higher and the professional education, the university is both a teaching and an examining body, granting degrees under conditions prescribed by the minister and council. The administration of the secondary instruction is committed to it, and it shares in the supervision of the primary instruction. It is composed of 18 *Academies*, each of which comprehends several departments. These academies are so many local centres of the Department of Public Instruction. At the head of each is a rector; the chief officials under him are called Academy inspectors. The Minister of Public Instruction is also rector of the Academy of Paris.

The Academy officials, under the control of the minister, have the superintendence of secondary instruction in the departments within the Academy's jurisdiction; there is an inspector for each department. The instruction is minutely regulated, as to the quantity to be provided, as to the subjects to be comprehended in it, and as to its cost; it is the chief duty of the Academy inspectors to see that the requirements with respect to it are complied with. The inspection is said to be highly efficient. The lyceum is the principal seminary of secondary instruction; in general, the chief town of every French department has its lyceum. There is, besides, the communal college. Every town of considerable population has its communal college. The lyceum is founded and maintained by the state, with aid from the department and the communes; the communal college is founded and

## NATIONAL EDUCATION.

maintained by the commune, with occasional aid from the state. The instruction given in the communal college and in the lyceum is substantially the same in character; in the lyceum it is the more extensive. To the lyceum there is usually attached a preparatory school for the younger boys. In both lycæums and communal colleges, there are boarders and day-scholars. French, Latin, Greek, and mathematics are the principal subjects of instruction; arithmetic, history, geography, modern languages, and the natural sciences are also taught. The course at the lyceum lasts for six years, and qualifies for the degree of Bachelor of Letters. Religious instruction is given—to the Roman Catholic boys, by chaplains attached to the school; to the Protestants, by a Protestant minister specially appointed to this duty; and the New Testament in Greek or Latin is read daily by every class. In the lycæums, the average charge for day-scholars is from 110 francs (£4, 7s. 4d.) to 180 francs (£7, 8s. 4d.) a year; the charge for boarders from 800 francs (£32) to 900 francs (£36), according to their age and advancement. In Paris, the charges are higher—from £38 to £60 a year for boarders, and from £6 to £12 a year for day-scholars; on the other hand, there are lycæums where the highest charge for boarders is £22 a year. There are public scholarships (*bourses*) founded by the state, to be obtained by competition, the holders of which are relieved from all cost. The education given is in no respect much inferior—and in some respects it is superior—to that which is to be had at an enormous cost at the best English public schools; it is far superior to that which, at a far higher cost, is ordinarily given to children of the middle classes in England. A private secondary school cannot be opened without notice to the public authorities: they must be satisfied that the premises are suitable; and the director must have a certificate of probation—showing that he has served five years in a secondary school—and a certificate of competency obtained at the public examination for secondary teachers. The Academy inspector inspects private secondary schools, but only to see that the pupils are properly lodged and fed, and that the teaching contains nothing contrary to morality and the laws. The minister may, however, dispense with the certificate of probation, and holy orders are accepted in lieu of the certificate of competency.

A law, dated the 21st June 1865, founded a new course of study in secondary schools—a special secondary instruction. The object of the special secondary instruction is declared to be 'found the sub-officers of industry; instruction in living languages is substituted for the classical instruction of the secondary schools; the elements of science and its applications receive great attention—particular regard being had to the teaching of agriculture and the sciences which bear upon it. The teaching, moreover, is intended to impart what may be called a sound French education. A normal school has been founded at Cluny for the preparation of masters for this special secondary instruction.

For primary instruction in France, an excellent basis was laid by M. Guizot's law of 1833, of which, indeed, the more important provisions have been retained. The body of legislation actually in force consists of the law of March 15, 1850, the organic decree of March 9, 1852, the law of June 14, 1854, and the law passed during the year 1867. The law requires that every commune shall maintain an elementary school, either by itself, or in combination with other communes; in founding and maintaining its schools, it is to be aided, if necessary, by the department and by the state. It must have taxed itself specially for the schools three centimes

per franc of rental before it can claim aid; the department must have taxed itself specially two centimes for the communal schools before the state is resorted to. Up to the present year, a certain number of poor children—the number determined for each school by the prefect of the department—were admitted to the school gratuitously; for others, a fee was charged, which was collected every month by the tax-gatherer. The state contributed whatever was necessary in addition to the communal and departmental taxation and the school-fees. The law of the present year, however, provides that all children are to be admitted gratuitously whose parents would have difficulty in paying the school-fee; and that a commune whose taxation amounts to four centimes additional may dispense with the school-fee altogether, the deficiency, if any, so arising being made up by the state. In the large towns, the schools have long been gratuitous—the communes often taxing themselves, for school-purposes, beyond the amount required by law. Up to the year 1867, the law did not oblige the communes to maintain separate schools for girls, though a large proportion of them contributed towards the maintenance of such schools. The law of 1867 provides for the establishment of girls' schools; the cost of them—the communal and departmental taxation being in most places previously exhausted—will fall in a great measure upon the state.

Religious instruction is given in every school. In France, the Roman Catholic, the Protestant, and the Jewish forms of worship are subsidised by the state; and it is provided that, in communes where more than one of these is publicly professed, each form is to have its separate school. The departmental council, however, has power to authorise the union, in a common school, of children belonging to different communions. For such cases, it is provided that ministers of each communion shall have free and equal access to the school, at separate times, to attend to the religious instruction of members of their own flock. To a school appropriated to one denomination, no child belonging to another is admitted, except at the express demand of his parent or guardian, signified in writing to the teacher. Denominational schools are now the rule, common schools the exception. Previously to 1850, under M. Guizot's law, common schools were the rule, but it was found that in them the religious instruction presented grave practical difficulties. All the religious bodies appear to be satisfied with the present system. The schools, though denominational, are communal schools; the denominations have not the management of them; and they are all subject to the same inspection.

The mayor and the minister of religion in each commune have the supervision and moral direction of the primary school; in practice, they are strictly confined to matters connected with its morality. Cantonal delegates are appointed by the departmental council (the canton is a division larger than the commune), who inspect the primary schools of their canton; but they have no real authority over the schools; they are only allowed to make representations as to the state of the schools to the departmental council, or to the inspector. The departmental council has the chief part in the regulation of the primary schools; moreover, no private primary school can be opened without its permission; and if it refuse permission, there is no appeal. It is the prefect, however, who has the power of nominating, suspending, and dismissing public primary teachers. His authority is usually exercised upon the report of the Academy inspector—the university official whose important functions, in respect of secondary instruction, have already

been described. The academies have the charge of the normal schools of primary instruction, and the supervision of the primary schools as regards the methods of teaching and course of study. Under them are the primary inspectors, who report to the Academy inspectors; above the latter, as regards primary instruction, there are four inspector-generals, attached to the office of education at Paris. It is the primary inspector who really superintends the instruction of the schools; his labours are unceasing, his inspection is a reality, for he is not required to give notice of his visits. The private primary schools are subject to his inspection, but only as regards the provision made for the bodily health and comfort of the pupils and the maintenance of morality.

The subjects which must be taught in every primary school, in addition to moral and religious teaching, are reading, writing, arithmetic, the elements of French grammar, and the French system of weights and measures; there are other subjects which are facultative—which, in whole or in part, may be taught, that is, if the council of the commune should so desire, and the departmental council give its consent. These facultative matters are the applications of arithmetic; the elements of history and of geography; the elements of physics and of natural history; elementary instruction in agriculture, the arts, and hygiene; surveying, levelling, drawing, singing, and gymnastics. For girls, there are superior primary schools which teach the facultative matters only; and in girls' schools, instruction is usually given in needle-work for about three hours a day.

For the preparation of male teachers, the law requires every department to maintain a normal school; in some cases, however, two departments are allowed to maintain one jointly: there are now 70 of these schools. There are separate normal schools for female teachers; of these, the number was recently 34; now that the law is about to add largely to the number of girls' schools, it will probably be increased. The members of the religious orders devoted to teaching, which perform a great part in primary education, are trained for their duties in the establishments of their respective orders. (Of these orders, the most important is that of the Brethren of the Christian Schools.) The instruction of the normal schools is meagre; it scarcely exceeds the subjects of primary instruction; a considerable proportion of the students, indeed, acquire only an imperfect knowledge of the facultative subjects. School-method is what, in the normal schools, it is deemed most important to teach. The examination for primary schoolmasters—which is conducted by a commission appointed by the departmental council—is limited to the subjects taught in the schools. There are two classes of certificates, according as the teacher passes in the obligatory subjects only, or in the whole or part of the facultative subjects also. Every male teacher, public or private, is required to have the certificate of capacity granted after an examination; also, excepting in the case of religious persons, a certificate of morality. The law recognises a certificate of stage, to be granted to assistants who have served as such for three years, as a substitute for the certificate of capacity; but this provision has been unpopular, and the qualification of stage is practically unknown. Female lay teachers require the certificate of capacity; female teachers of the religious orders are exempted from it. No person can be appointed a regular communal teacher unless he be twenty-four years old, and have served for three years since his twenty-first year as an assistant, or as a *supplying* teacher. The supplying teacher gets

a lower salary, and may be employed in the poorer communes. The salaries are low even in the towns: in many of the country communes, the legal minima are not exceeded: these are—for an ordinary communal teacher, £24 a year; for a female teacher, or a supplying teacher, £20 a year. The commune pays £8 a year, besides the school-fees; whatever is required to make up the legal minimum, the government supplies; and, since 1862, the government has, upon certain conditions, made slight allowances in addition to the minimum.

It is in secondary instruction that the education of France has a decided superiority over that of England. The primary instruction is scarcely equal to that given in English schools of the same grade. Mr Matthew Arnold has reported that, in 1839, he found in French primary schools the writing fair, but scarcely so good as in English schools; the reading better, the arithmetic much better, than in English schools. Of history and geography, the pupils were far more ignorant than English school-children of the same age. The ministry of M. Duruy, however, has been an era of improvement; much more attention is given to the facultative matters now; especial attention to agriculture and the subjects connected with the daily life of the peasant. Mr Arnold came to the conclusion, that even in the great towns there were no masses of children left altogether uneducated, that almost all passed at some time through the schools. Adult classes, taught in the evenings, have greatly increased in numbers of late years, and are now aided by the state.

In 1834—just after the passing of M. Guizot's law—the number of primary schools, public and private, was 10,316; in 1857, it was 65,100; in 1872, it was 70,180, of which 38,850 were boys' or mixed schools, 17,460 girls' schools, and 11,000 were free schools. In the primary schools alone there were, in 1872, 4,722,000 scholars—3,500,000 more than the number of scholars in 1829. In 1872, the year of the census, a careful inquiry was made into the condition of the French people with regard to primary education. Of the total population above the years of childhood, it was found that 30·77 per cent. could neither read nor write, 10·94 could only read, and but 58·29 could do both. There was a most extraordinary difference between one department and another in this respect, the percentages of utterly illiterate persons, ranging from 6·9 per cent. in Doubs to 61·8 in Haute-Vienne; the most favourable figures indicating universally the north-eastern departments. In 1872 the state and the communes expended 85,000,000 of francs on primary education alone. The item of public instruction stood at 49,211,000 in the budget of 1877. For the means of higher education in France, see *UNIVERSITY OF FRANCE*.

#### *State-education in Prussia.*

In all the Protestant states of Germany, the school-system in its main features is the same. The Prussian system—more celebrated, more extensive, more practical and thorough than the system of the minor states—always powerfully influencing these, and now likely to influence them more than ever, is that which must be selected for description. About this system, M. Cousin, by a strange confusion between it and a project of law—a mere scheme drawn up by the education minister, Von Altenstein, never even proposed for legislation—spread misconceptions throughout Europe, which have scarcely yet been dispelled. It has been greatly changed, greatly improved since Cousin wrote in 1831; but it does not yet in symmetry and completeness approach to what he described.

In Prussia, there is a Minister of Public Worship and Instruction; but the officials who under him carry on the government of education are the officials of the Department of the Interior. At the head of the government in each province is a president; over each of the departments into which the province is divided there is a prefect (*bezirk*); each of these officers is assisted by a council, of which one section, called *Schulcollegium*, forms a separate council for deliberating upon the local school-affairs. One member of the school-council, called provincial school-councillor, is associated with the president for administrative purposes: the prefect has attached to him two departmental school-councillors, one Protestant, one Catholic, to advise with him, and to administer the school-affairs of their respective communions. There is practically a division made of educational affairs between the officials of the province and those of the department. The provincial school-councillor takes the charge of secondary education within the province; the departmental school-councillors the charge of the primary schools of the department.

Over each of the circles into which the department is divided is an officer, termed a *Landrath*, who reports to the prefect of the department. With the *landrath*, in the management of primary schools, is associated the *superintendent*, the church dignitary of the circle. The *superintendent* is *ex-officio* inspector of the primary schools within the district. The parish clergyman is *ex-officio* local inspector of primary schools within his parish. There is also for the school or schools of each parish a board of managers, the composition of which varies in different provinces. The clergyman is always a member of it: he is usually chairman. In country places, the whole powers of the board are often left in his hands.

In the 'exterior' affairs of the school—passing school-accounts, visitation of school-premises, control of the school-estates, adjustment of the school-rate, &c.—the *landrath* is associated with the *superintendent*. Its 'interior' affairs, all that concerns its teaching and discipline, are, subject to the established regulations, under the *superintendent's* control; but, in practice, they are more under the influence of the departmental school-councillor. The *superintendent*, however, is required to visit the schools, and to watch over the conduct of the local inspector, and he reports annually to the government of the department. The local inspector's province is the interior affairs of the school. He is expected to visit the schools diligently, and to be active in the supervision of them. The religious teaching of the children is almost entirely done by him, it being his duty to prepare them for confirmation, which comes at the end of the school-period. To qualify them for the duty of school-inspection, the candidates of theology are required to attend for six weeks as auditors at a normal school, and to have attended a course of *Pädagogik* at the university. Nevertheless, it appears that many clergymen are very ill fitted for this work, and that their powers of interference are often exercised in ways annoying to the master, and detrimental to the school. The 'exterior' affairs of the schools of a parish belong to the board of managers.

This board is usually composed of representatives (1) of the patrons, if any, of the school; (2) of the parochial clergy; (3) of the municipal body; (4) of the householders. It has a stated meeting once a quarter; it meets whenever it is summoned by the chairman. It manages the revenue and expenditure of the school, in respect of which it is responsible to the *landrath*; it is the trustee of the school-

buildings and property. It is its duty to see that the regular school-hours are kept; that no unauthorised holidays are given; to its application must be made for dispensations for periods exceeding a week. Its members should be present at all examinations and other public solemnities of the school. In the large towns, there are school-delegacies appointed by the *Magistrat*, whose powers are more extensive, and are in practice the greater, because in the large towns the pastors pay little attention to the schools. The school-delegacies have control over the higher as well as the primary schools which their constituents maintain; two paid members—school-delegates—who must be members of the *Magistrat*, exercise the greater part of their authority. Under the delegacy, for every school there is a school-board, consisting of the clergyman and two lay members, whom the delegacy appoints. The delegacy itself is accountable to the *magistrat*, and both are subordinate to the provincial council.

Every commune is bound to find school-room and teachers for all the children of school-age belonging to it. The amount of the teacher's stipend is in every case fixed by the departmental government; there is no legal minimum; the salaries are usually very low. Some parishes possess endowments; but, in general, the cost of maintaining the schools is defrayed by means of (1) school-fees, (2) a local rate, (3) a grant from the national treasury. As children are only expected to pay what they can, and as the state grants aid only after the strictest proof of the incapacity of the commune, the weight of the burden falls upon the local rate. The maintenance of the schools ranks with the first charges upon the local purse. The teacher is appointed by the departmental councillor; in a few towns, however, a certain power of choice is allowed to the municipal authorities—they may select one from a number of candidates presented to them by the government.

School-attendance is by law compulsory for eight years; the school-age beginning at the completion of the fifth year. But in most parts of Prussia, children, though allowed, are not compelled to attend till the completion of their sixth year. The school-period closes with confirmation. A register of all children of school-age is made up—usually at the police-office; every child is registered for a particular school; there, whatever his rank, he must attend, unless a dispensation be got for him from the *landrath*. When a dispensation is applied for, the parents must state the motives of the application, and the provision to be made for the child's education. All persons officially connected with schools are expected to use their influence to secure regular attendance; but failing moral suasion, there are other means of enforcing it. The schoolmaster keeps a list of absences, excused and inexcused. When a child's attendance is irregular, the board of managers admonishes its parent. If admonition—which in general is repeatedly resorted to—has no effect, a statement is sent to the police-office; the parent is fined a small sum for each day of the child's absence since the last admonition; and the fine can be levied by execution, enforced by imprisonment, or taken out in parish labour. It seems that very few children escape registration; but the regularity of the attendance—in general it is very regular—varies considerably in different districts; the execution of the law being strict or otherwise according to the temper of the people, their circumstances, and the vigilance of the school-authorities. There are no statistics by which the success of the law can be exactly tested. In some of the larger towns, the demand for child-labour and the growth

of pauperism are adding to the difficulty of enforcing it. Prussia has a factory-law requiring that every child employed in a factory shall attend school for three hours a day, and this law is strictly enforced.

Teachers of every class, public and private, have to pass two examinations. Certificates are of three degrees of merit—they may be marked 'very well qualified,' 'well qualified,' or 'sufficiently qualified.' The heads of examination are 'religion, the German language, the art of school-keeping, geography of Prussia, arithmetic and geometry, knowledge of natural objects, writing, drawing, singing and the theory of music, organ.' After the first examination, the candidate is eligible as an assistant or provisional master; he must serve in this capacity for three years before taking the second; he must pass the second within five years. The second examination is in the same subjects; but now most weight is given to the art of school-keeping. Of the subjects taught in primary schools, the principal is religion; the others are reading, writing, arithmetic, singing, and the elements of drawing. Incidentally, the teacher may communicate information about natural phenomena; about geography, beginning with that of the locality and the history of Prussia. The teaching was much more ambitious before 1854; before 1864, also, the normal schools, now limited to a meagre programme, were universities on a small scale, aiming at the mental training of their students, rather than at fitting them to teach elementary schools. The change is often ascribed, both in Prussia and out of it, to political motives, having been made by a party unfriendly to popular education; but eminent educationists defend and approve it. The schools, they say, are now attempting as much as can be thoroughly done in the time allotted for primary education, and are doing it thoroughly; while the showy teaching of former times, with its endeavour to develop the faculties, and to communicate knowledge, neglected the indispensable elementary instruction, and, as regarded the greater number of the scholars, was in no respect successful. The normal school training, it is said, now fits the teacher for his duties and his position in life; formerly, it rather unfitted him for them, while fitting him perhaps for something better. It is, however, admittedly a defect in the Prussian system that it offers to the humbler classes no opportunity of carrying their education beyond the point at which the elementary schools leave it. In some of the towns, there are improvement institutes, where young persons are taught in the evenings or on Sundays; but they attempt little, are badly organised, and are neglected by the school administrations. It should be stated that the town schools often teach somewhat more than is taught in country places—more geography, history, and natural knowledge—but this, though permitted, is not encouraged by the authorities. Grammar is entirely excluded from primary instruction. The only part of the teaching which is less than excellent is the writing; it has been stated that upwards of 50 per cent. of the recruits are unable to write—the art, never perfectly mastered, being lost, it must be supposed, through want of practice.

As regards religious instruction, the rule is, that the primary school is denominational—public schools are set apart, that is, for children of each of the religious bodies; the clergyman who has the charge of the school is the clergyman of the body to which it is appropriated. Besides the 'Evangelical Establishment,' in which Lutherans and Calvinists are combined, there are the Roman Catholics and the Jews to be provided for; of other sectaries, there are not 10,000 in all Prussia. The Lutherans and Calvinists are combined in the school as in the

church. Dissenters are allowed to withdraw their children from the religious instruction, and have it given by their own pastor. Any commune may establish a mixed school, if it so desire, and if the authorities permit; but, in practice, mixed schools are only to be found where it would be very inconvenient to establish a school for each body. In mixed schools, the teachers are chosen proportionately from each of the two great religious bodies; if there be only one teacher, it is, in some districts at least, customary that he should be alternately a Protestant and a Catholic. The experiment of mixed schools had a long trial in Prussia, and was found to be unsatisfactory, leading to attempts, or suspected attempts, at proselytism, and to parish squabbling. It has been abandoned, not so much from the wish of the government, as in deference to the feelings of the people, and to the demands of the Roman Catholic hierarchy. But the denominational system is more in accord with the part which the state assigns to religion in the school. The school, it is said, should be the organ of the church for training children to church-membership; school and church are expected between them to form the child into a man contented with his position in life. Religious teaching must be given by the master for an hour every day. In the Protestant schools, the master teaches the Lutheran catechism to Lutheran children; the Heidelberg catechism to the Reformed children. Scripture history is also taught; and hymns, from a prescribed collection, have to be committed to memory. The master is not allowed to expound the catechism; his duty is to see that the children learn it, and understand the words in which it is expressed. It is the clergyman who explains its doctrines to the elder children in preparing them for confirmation.

Any one may open a private school of any class in Prussia who can obtain a licence for the purpose from the government; but in a city, it must be shewn that the district in which the school is to be placed is insufficiently supplied with schools; and every private teacher must have passed the two examinations. Private schools are subject at all times to the inspection of the school-councillor, and are bound strictly to follow the regulations established for private schools. The larger towns in Prussia are not yet adequately supplied with public primary schools; private primary schools are therefore common in such places: in Berlin, they educate nearly half the children who are in primary schools.

Of the secondary and higher education in Prussia, a brief and general notice must suffice. It has already been stated that the superintendence of the secondary schools is undertaken by the school-councillor of the province; it is independent of ecclesiastical control. The larger communes and the towns are required to maintain middle schools, giving instruction of a higher order than is given in the elementary schools, a sound German education, and preparing boys for the gymnasia. These must be provided to the satisfaction of the authorities, according to the wants of the population. They are maintained, like the primary schools, by school-fees, local taxation, and these failing, the state treasury. Some of the larger towns maintain also secondary schools of a higher class; these are of two kinds—the real-school, and the gymnasium or grammar-school. In such towns, as stated already, the local management rests with the school-delegacy. There is, besides, a considerable number of real-schools and gymnasia which are entirely in the hands of the government. None of the real-schools take boarders; very few of the gymnasia do so. The gymnasium is a classical school preparing for

the universities. In the real-school, mathematics, scientific studies, and modern languages are substituted for the classics, and the instruction is designed to prepare the pupils, as far as possible, for the pursuits of life. The real-schools grant certificates to their pupils. The royal real-schools and the gymnasia (other than those maintained by the large towns) are under the management of the provincial school-councillor. Some of the older of those gymnasia have endowments, but the money necessary for their support is contributed by the state. Appointments to the schools are made by the school-councillor; he appoints the teachers, or nominates the best out of which local authorities have to choose, in all the secondary schools. Teachers for all the schools have to pass two examinations. There are boards of examiners, appointed by the provincial government, which conduct the examinations; these boards also examine the students of the gymnasia, to test their fitness for the university. The university in Prussia is a teaching (or rather a lecturing), as well as an examining body, and grants degrees in four faculties—Theology, Jurisprudence, Medicine, and Philosophy. There are seven universities within the territory held by Prussia before the war of 1866; in two of these—Breslau and Bonn—there is a Roman Catholic as well as a Protestant institute of theology. The university affairs are administered by a commissioner appointed by the crown; all their regulations are prescribed, and all the appointments in them made by the state.

*State-education in the United States.*

In the United States, the education of the people is out of the sphere of the central government; it ranks among the domestic affairs of the several states, and it is chiefly in the Northern States—those from which, before the late war, slavery was excluded—that systematic attempts have been made to promote it. The central government has, however, in more than one instance endeavoured to assist education in the states, by providing for it endowments. In the states which contain waste lands, it puts aside, in every newly-surveyed township of six miles square, one square mile, for the support of schools within the township. The state becomes trustee of this land, or of the price obtained for it, which is usually called the Township Fund, and pays over the yearly income to the township when it has been settled. The central government, about 1836, had accumulated in its treasury a considerable balance, the surplus of its income over its expenditure during several years: this it apportioned *pro rata* among the states, reserving the right to reclaim it. This right has not been, and is not likely to be exercised; and in most of the Northern States, the income of the 'United States Deposit Fund' is applied to the support of education. Since 1864, by what is called the 'Agricultural College Act,' the central government has made a liberal offer of allotments of land to the states upon certain conditions, for the endowment of one or more institutions in every state, in which—whatever the other instruction may be—special attention shall be given to those branches of learning related to agriculture and the mechanic arts. Several states are preparing to avail themselves of this offer.

Every one of the Northern States has its common schools. Before the war, Kentucky, Missouri, and Louisiana had each some kind of school-system; at various points throughout the South, particular towns had established schools, always after the model set in the Northern States. The new state of Western Virginia has passed a

school-law since the conclusion of the war. In the Northern States, besides the endowments above described—both of which are possessed by most of the states—every state possesses a school-fund arising from various sources—sale of lands, taxation, penalties, and forfeitures—which is usually vested either in the state legislature or in a Board of Education. In one or two of the states, the income of this fund is considerable, but in general it is small. It is usually, but not in all the states, applied solely to the support of public schools, or of the normal schools which help to provide them with teachers. Apart from the influence exercised by means of this fund, the state usually promotes public instruction only by its legislation, by which it requires or enables local bodies to make certain provision for the education of children within their jurisdiction. Everywhere, the law leaves much, and usually the practice leaves everything, to the local bodies; and these come short of, or exceed the legal requirements according to the local interest in education and ability to pay for it. It is through the interest of the municipalities in education that very ample provision is made in the towns; it is through the force of example, and in deference to educational experience, that a certain uniformity of system prevails. There is a close approach to uniformity both in the law and in the practice of the several states; and a description of the system of one state will be approximately true of that of other states. The Massachusetts system is fittest to be selected for description, as being the oldest, the most celebrated, that which on our side of the Atlantic is most identified with the common schools, and perhaps on the whole the most successful. Some of the principal variations from it will be noted.

In 1642—twenty years after the landing of the *Mayflower*—the Massachusetts colonists passed a law requiring every citizen, under a penalty of 20s., to teach his children and apprentices, or have them taught, to read perfectly the English language. Five years later, they passed another law, requiring, under penalty, every township containing 50 householders to support a teacher to teach their children to read and write; requiring every township containing 100 householders to maintain a grammar-school capable of fitting youths for the university. The present law is different, if not less liberally conceived. The change was made by numerous steps, and was probably forced on by the circumstances of the community. The law, as it now stands in the revised statutes of the state, provides that in every township the inhabitants shall maintain for at least six months in the year a sufficient number of schools for all the children of the township. The teachers are to be of competent ability and of good morals, and they are to teach orthography, reading, writing, English grammar, geography, arithmetic, the history of the United States, and good behaviour. Other subjects—algebra, vocal music, drawing, physiology, and hygiene—are to be taught or not at the discretion of the local committee. Every township may, and every township containing 500 householders must, also maintain for ten months in the year a school which shall give instruction in general history, book-keeping, surveying, geometry, natural philosophy, chemistry, botany, the civil polity of Massachusetts and of the United States, and the Latin language. And in every township containing 4000 inhabitants, the teacher must be competent to instruct in the Greek and French languages, in astronomy, geology, rhetoric, logic, intellectual and moral sciences, and political economy. Moreover, any township may establish schools for children over 15 years of age, determining the instruction



to be given, and appropriate money for their support. The compulsory part of the law is supported by penalties, but it is said that there would be difficulty in enforcing them; at anyrate, they are not enforced. It is also provided that every child between 8 and 14 must be sent to school for at least 12 weeks in a year: the penalty for breach of this provision is 20 dollars, but the idea of enforcing it seems never to have been entertained; its existence even is not generally known. The law does not permit school-fees, or, as they are called in America, rate-bills. There seems to be no fund arising from waste lands in Massachusetts; and the township raises the necessary funds by a tax upon property—the personal property of the inhabitants and the capitalised value of their real property situated within the township. The amount of the rate is by the law left wholly undetermined: it is determined by the householders at their annual meeting. The state endeavours to influence the townships to make a liberal provision by means of the school-fund, a share of which is given to every township which has made its returns to the Board of Education, and has spent not less than at the rate of a dollar and a half per head for all the children of the township. The school-fund contribution is very small—less than a quarter-dollar for every child; but it is said to have an excellent influence upon the rural townships. No doubt, the publication of the returns made to the Board of Education tends to spur on the backward districts.

The management and control of all the public schools of a township are placed in the hands of a school-committee, consisting of any number divisible by three; the members of this committee hold office for three years, and one-third of them are elected annually at the annual meeting of the township. The committee have the supervision of the schools; and it is among their duties to see that no book calculated to favour the tenets of any particular sect of Christians shall be used in the schools, and to require the daily reading of some portion of the Bible in the common English version. Any township, by its public meeting, or a city, by its city-council, may require the committee to appoint a paid superintendent of schools: when this is not done, the members of the committee receive a small allowance for the time during which they are engaged upon the school-affairs. But, moreover, any township may, at a meeting called for the purpose, resolve to divide itself into districts for the support of its schools. If this be done, the township names for each district a 'prudential committee,' consisting either of one or of three persons, resident within the district, which is charged with providing and keeping in repair the school-house, at the expense of the district, and, if the township so determines, with the duty of selecting and contracting with the teachers. The district determines the amount to be raised by it for the building, or repair or furnishing of its school; this is collected by the township collector, and handed over to the district-committee. The school-committee retains its functions of management, except so far as they have been made over to the districts; and hence, there is a double management of the schools, which is found to be attended with inconveniences. The division into districts, too, is said to have led to an unnecessary multiplication of schools in country places: people scheme to have the township so divided that there may be a school in their neighbourhood—there are therefore more schools than are needed, and more than can be maintained in efficiency. The school-committee—in cities, the school-superintendent—examines the teacher before his appointment, and grants him a certificate, which

remains in force for a certain time. There are three classes of certificate—one valid for six months, another for twelve, a third for two years. The common schools of a township are open to all children resident therein between five and fifteen years of age: none are to be excluded on account of race, colour, or religious opinions; and it has been held that a child unlawfully excluded may recover damages therefor in an action of tort.

In New York, in Pennsylvania, and in most of the Western States, large municipal powers are possessed by the county, and the county shares with the township the management of school-affairs. New York has a state superintendent, whose power over the schools is considerable. In that state, it is the school-commissioner of the 'Assembly District' in which the township lies who divides the township into school-districts; and it is the district which determines the school-tax: the township is almost completely ignored. In New York, Ohio, and Illinois, it is by county officials that teachers are examined and certificated. In New York, Rhode Island, and Connecticut, 'rate-bills'—that is, school-fees—are allowed, and are usually levied. Several states besides Massachusetts make school-attendance compulsory: in most of the states, there appears to be some provision against 'truancy'; but it appears that attempts are not made to enforce the law except occasionally, in the case of homeless, wandering children, who are liable, in lieu of a fine, to be sent to reformatory schools. It has been calculated that in the city of New York (pop. 940,000) there are about 100,000 children who do not go to school—though in no city is there a better or ampler provision of common schools.

As might be expected, the school-law work badly in country districts. The householders are disposed to be satisfied with any kind of school, provided it be cheap, and within easy reach of them; and the multiplication of schools by the district-system, makes it almost unavoidable that an insufficient sum should be spent upon each school. The teachers—a vast majority of whom are women—being wretchedly paid, are badly qualified; they are constantly changing; scarcely any intend to make teaching their occupation for life. Few of them have been trained for their work—the normal schools which exist being utterly inadequate to supply the demand for teachers; and the examination by a rural school-committee affords but a slender guarantee of competency. The teacher is usually 'boarded round' among the farmers of the district, and is said to be treated by them with much observance; but his income—putting a money-value upon the board—has been estimated at an average of about 50s. a month, and that only during the time that the school is open. In 1864, in 84 townships of Massachusetts—more than a fourth of all the townships in the state—the schools were kept open for less than the statutory period of six months. The teaching is said to be wonderfully good, considering the scanty pay given; but where the vacations last for more than six months, and the teacher is changed almost every term, thorough and systematic instruction is scarcely possible. It is in the towns that the working of the school-law has been creditable and successful. Through the high public spirit of the municipal bodies, and the great importance attached to education, the support of the common schools is in general most liberally provided for.

In the towns, there is usually a superintendent of schools, by whom, under and in co-operation with the general and district school-committees, the schools are inspected, and the character of the instruction determined; by him the examination of

the teachers also is conducted. Of the schools, there are four classes—primary, intermediate, grammar, and high-schools or academies. Children usually enter the primary school about 5 or 6; the grammar-school between 8 and 9; the high-school between 12 and 13 years of age. They are not promoted from one class of school to another without undergoing an examination; the intermediate schools, where they exist, are intended for those who are too old to be at the primary school, and too backward to enter the grammar-school. To be admitted to a grammar-school, a child must be able to read at first sight easy prose, to spell common words of not more than three syllables, and to have acquired a slight knowledge of arithmetic. For admission to the high-school, the usual requirements are ability to read correctly and fluently, an acquaintance with the simple rules of arithmetic, and some knowledge of geography and grammar. From these tests may be inferred the average proficiency expected to be attained by children leaving the primary and the grammar school respectively. In the grammar-schools of Boston, the programme of studies consists of spelling, reading, writing, arithmetic with book-keeping, geography, English grammar, the history of the United States, natural philosophy, drawing, and vocal music: this is nearly the usual programme; but in New York and one or two other states a little more is attempted. Between the high-schools or academies in the various states, there are considerable differences. In the city of New York, for example, the Free Academy has pretensions to the rank of a university, and grants degrees in arts and science (Bachelor of Arts, Bachelor of Science, Master of Arts) to students who have completed with credit the curriculum of five years. But, in general, the high-schools are schools of secondary instruction, intended to prepare youths for the university—instruction being given in the classical languages, mathematics, the sciences, history, and the English language and English literature. The usual curriculum is one of four years; and the students are not required to study all the subjects taught in the school. At Boston, where boys are admissible to the Latin high-school at 10 years of age, the curriculum lasts for six years. There are high-schools for girls as well as for boys, the programme of instruction being the same in both. At Boston, the curriculum at the girls' high-school lasts for three years; and pupils at admission must be between 15 and 19 years of age. Boston possesses, besides its Latin high-school and its girls' high-school, an English high-school, said to be admirably planned and conducted. The instruction in it closely resembles that given in the real-schools of Germany, including French and German, and various sciences, with their application; being intended to enable boys to complete a sound English education, and to prepare themselves for commercial life. Great complaints are almost everywhere made—Boston seems to be exceptional in this respect—of the irregularity of the attendance at the primary schools. It is estimated that in most states not much more than half of the children pass from these to the grammar-schools; but a trifling proportion of the grammar-school pupils enter the high-schools, and of these, only a small fraction, persist to the end of the curriculum. All high-schools grant certificates of graduation to pupils who have creditably gone through the course of study. The study of the classics does not, even in the most pretentious institutions of this class, seem to be carried very far, much more attention being given to mathematics and natural science. In Boston—in many respects the most favourable example that could be taken—there were, in 1864,

32,814 children of school-age—between 5 and 15; of these, 26,960 were in school, the average attendance being 24,617. The number enrolled at the three high-schools was only 725, and the average attendance 691. The number of students who complete the five years' curriculum of the New York Free Academy seldom exceeds fifty. Among the wealthy, there is said to be a growing disinclination to make use of the common-schools: their children are usually sent to private academies. The only serious opposition to the non-religious character of the common-schools comes from the Roman Catholic clergy; but it is stated that there is a growing feeling upon this subject among some of the other religious bodies. In many of the New York schools; in which the majority of the children are Roman Catholic, clerical influence, insufficient to impress upon the education the religious character which it would approve, has obtained, with the tacit assent of the school-authorities, the disuse of the daily Bible reading which the law prescribes.

The primary and grammar schools are most frequently mixed schools—that is, they admit boys and girls; in the teaching, however, the sexes are kept apart. The teachers in primary and grammar schools, even in the towns, are usually women; but in Boston the principal of a grammar-school is always of the other sex. The schools are in towns always *graded*—divided, that is, into classes composed of those who are at the same stage; each grade forms a separate department of the school, and is taught by a separate master. The usual number of pupils allotted to a teacher is in the primary schools about 50; in the grammar-schools about 35. This system of grading is a cheap system, because it enables a teacher to take charge of a large number of pupils; but it is said to lead to a want of thoroughness in the instruction, the teaching being addressed to the class rather than to the individual members of it. Want of thoroughness seems, indeed, the besetting sin of American teaching, which aims too much at communicating knowledge, not sufficiently at developing capacities. In the primary and grammar schools, the education costs from 25s. to 30s. per head; in the high-schools, from £6 to £10 per head.

#### *Statistics of National Education.*

The proportion of children attending school—i. e., enrolled in school-registers—to the whole population of the countries under mentioned may be approximately stated as follows: England, 1 in 7.7; Scotland, 1 in 6.5; Prussia, 1 in 6.27; France 1 in 9; Holland, 1 in 8.11; Belgium, 1 in 11; Northern States of the American Union, 1 in 4.5; Switzerland, 1 in 7; the minor Protestant states of Germany, 1 in 6.7. These figures, however, must not be taken as indicating the comparative diffusion of education in the countries named: nor are they to be relied on as indicating, with anything like exactness, the comparative proportions of children actually attending school; for the proportion of the children enrolled which on the average is in actual attendance, varies in different countries. It should also be borne in mind that averages conceal the condition of the worst parts of a country: in Scotland, for instance, where the school attendance varies from 1 in 4 of the population in the best districts, to 1 in 15, 1 in 20, and even to 1 in 30 in the worst.

See the Reports of the assistant-commissioners appointed to inquire into the State of Popular Education in England, vol. iv., being vol. xxi. part iv. sess. 1861; the second Report of the Scottish Educational Commissioners, 1867; the Statistical Society's Quarterly Journal for March 1867; Horace Mann on Education in European Countries; Fraser's

Report on American (U. S. and Canada) Schools; Cousin on German and Dutch Education; M. Block's Abstract of Public Documents relating to Education in France; *L'Instruction du Peuple*, par Pierre Tempels (Bruxelles, 1865); *Statistische Nachrichten über das Elementar Schulwesen*, an official return, which gives a complete survey of elementary education in Prussia to the end of 1864; *Congrès International de Bienfaisance de Londres, Session de 1862*; and *Rapport et Discussion sur l'Instruction Obligatoire*.

[Since the preceding account was written, the claims of national education have been more fully recognised, and, with less opposition than might have been expected, a national system has been established in England and Scotland. The Elementary Education Act for England, 1870, enacts that every district in which the existing schools are found deficient shall have a popularly elected school-board, to manage its rate-supported schools, levy school-rates, appoint teachers, &c. Elementary schools are to be supported, and the expenses of school-boards paid, out of funds called school-funds. The local rate forms the nucleus of each school-fund; but every school under the act is likewise entitled to an annual grant from parliament not exceeding the income of the school from other sources, and varying in amount according to the number of pupils and their proficiency as tested by different standards of examination. Schools are to be open at all times to government inspection. Religious instruction, if given at all—and this is left to each board to decide—is to be given at fixed times other than the ordinary school-hours, when no child is compelled to attend. It is further left to the discretion of school-boards to make education compulsory.—The Scotch Education Act, 1872, differs materially from the English act on three points only: first, by providing that a school-board, under the Scotch Education Department, is to be elected in every parish and burgh; secondly, by making it illegal for parents to omit educating their children between 5 and 13 in reading, writing, and arithmetic; and thirdly, by comprehending higher-class schools. Otherwise, the acts are much alike. Every school is to be open to children of all denominations, and religious instruction is only to be given before or after ordinary school-hours. Provided they conform to the 'conscience clause,' school-boards may make any provision they please for religious instruction. School-boards are enjoined to relieve the teachers of higher-class schools, so far as may be, from elementary work.]

NAUTILUS PROPELLER was long the best known among many names given to a mode of propelling steam-vessels by means of a horizontal wheel within board, instead of a paddle or a screw on the outside. Hydraulic propeller has latterly come more into use. Engineers thought of this mode of propulsion generations ago, and patents have been taken out for inventions relating to it by Toogood, Hayes, Rumsey, Linaker, Hall, and others; but the most successful attempts to realise it have been those of Mr Ruthven. He constructed a small boat, 9 feet long, in 1839 (tried on the Union Canal), and a vessel, 40 feet long, in 1844 (tried on the Forth), to test the principle; each was worked by a small steam-engine, and provided with the hydraulic apparatus. In 1849, Mr Ruthven made improvements in the apparatus, and introduced them in a vessel, 30 feet long, tried upon the Thames. In 1851, he placed a boat in the Great Exhibition. In 1853, a vessel on this principle, called the *Albert*, was built in Prussia by M. Sydel, the machinery being supplied by Mr Ruthven. She plied on the Oder as a passenger-steamer for many

years, and illustrated favourably some of the characteristic features of the nautilus system. The term of Mr Ruthven's patent expired, however, before the invention had worked its way into use in England; and the Privy Council, in 1863, gave a further term of ten years. He afterwards began building a vessel to be called the *Nautilus*; while the Admiralty authorised the commencement of the gun-veel *Waterwitch*, both to be worked on the Ruthven principle.

The *Nautilus* was first tried on the Thames in April 1866. It is fitted with two steam-engines, of 10 (nominal) horse-power each, with cylinders of 17 inches diameter, and 2 feet stroke. Water is admitted through apertures in the bottom of the vessel into a water-tight iron case or compartment. In this case is placed a horizontal so-called turbine-wheel, 7 feet in diameter, acted on from a vertical shaft connected with the steam-cylinders. The wheel is divided into compartments by plates or radii of peculiar curvature, and is placed below the water-line of the vessel, so as to be always immersed. Two pipes extend from the wheel-case, one to either side of the vessel, where they emerge nearly at midship. Each pipe terminates with nozzles, 10 inches in diameter, placed outside the vessel at right angles to the pipes; inasmuch that each side of the vessel has a nozzle pointing ahead and another pointing astern. A valve is fitted to each pipe, at its junction with the nozzles, to open the passage to one nozzle and close it against the other; and the movement both of the starboard and the port valves can be governed from a raised deck built over the engine-house. The wheel-case is always full, or nearly full, of water, which enters through the apertures in the bottom of the vessel. When the wheel is made to rotate horizontally by the steam-engines, water is drawn in through the hollow axis, and expelled at the periphery by centrifugal force; it can only find an outlet through the two pipes, and then through the nozzles which terminate them. Supposing the nozzles pointing astern to be open, and those pointing ahead to be closed, the vessel is propelled forward by the resistance of the water of the river or sea to that rushing out of the nozzles; when the forward nozzles are open, and the hinder ones closed, the vessel is propelled backwards, or driven astern. The captain, standing on the raised deck, and commanding both valves, can close the fore-nozzles, and open the aft, which makes the vessel go ahead; he can open the fore and close the aft, which makes her go astern; he can open one fore-nozzle, and close the other, which makes her turn. The exit of the water from the nozzles is a little above sea-level, a plan found to be better than actually immersing them. In one of the trial-trips of the *Nautilus*, with strong wind and tide urging her on, and going at full speed, she was stopped dead in less than 10 seconds, and in about a quarter of her length, by simply reversing the valves.

The performance of the *Nautilus* was satisfactory enough to lead the Admiralty to expedite the finishing of the *Waterwitch*, an iron-clad gun-veel of 778 tons and 160 horse-power. The wheel is rotated by an engine having three separate cylinders, each 38½ inches diameter by 3 feet 6 inches stroke. The vessel was built at the Thames iron-works, and engined by Messrs J. and W. Dudgeon of Blackwall. Its turbine-wheel is 14 feet diameter; it rotates (at full engine-power) 39 times per minute. The brass discharge-nozzles, which measure 24 inches by 19½, are continued along the outside of the vessel 8 feet on each side of the centre; the lower lips of the discharge-nozzles are 8 inches below water-line, the remainder of the aperture being above water.

## NEMUCH—NERVOUS DISEASES OF AN OBSCURE NATURE.

The *Waterwitch* is flat-bottomed and double-ended, i. e., she has a rudder at each end, so that she can steer equally well when going ahead or astern. Her total cost was £80,000, of which no less than £13,600 was for the engines.

As regards her speed and the efficiency of her machinery, the *Waterwitch* did not do all that was expected of her; she was neither more nor less successful than her sister ships, the *Viper* and *Vixen*, and they all three belonged to the slowest class of gun-boats. As her machinery was much more expensive than that of the others, nothing has as yet been done in the way of adding to the number of hydraulic engines in the navy. They possess many advantages in regard to manœuvring the ship, but these are to a great extent also possessed by twin-screw engines, which can be made at a less cost; while some of the advantages originally claimed for them, such as freedom from alip, have not been realised in actual work. In such exceptional vessels as those of the *Viper* class, a fair comparison of the merits of the hydraulic propeller with those in common use cannot be made. The nett result of the experiments hitherto made is, that while the addition of one additional part to the machinery between the engines and the actual propellers (which in this case are the columns of water) is open to grave objections; still, with a 'turbine' less faulty in design, and under more favourable circumstances as regards the vessel in which it is placed, the hydraulic propeller may be found useful in men-of-war. The *Waterwitch* has chiefly been employed in harbour work as a tender to larger vessels.

**NEMUCH**, or **NIMACH**, a town of India, in the territory of Gwalior (q. v.), near the north-western border of Malwa, 320 miles south-west from Delhi, on a slightly elevated ridge rising from a well-cultivated plain. It is 1476 feet above the sea. The native population of the town is only about 4000; but N. has acquired importance on account of a British cantonment established here in 1817. Prior to the sepoy mutiny of 1857—1859, the officers' quarters comprised about 80 bungalows, beautifully situated among gardens; but all, except a single bungalow, were destroyed in 1857 by the mutineers, who massacred the Europeans, and kept possession of the fort for some time, till it was captured by Brigadier Stuart after a siege of fourteen days. The situation of N. is regarded as one of the most healthy in India; the climate is agreeable, the nights cool even in the hot season, the winter seldom so cold as to make fires requisite, and frost very rare.

**NEGAPATA'M**, a town of British India, in the presidency of Madras, and district of Tanjore, 124 miles south-south-west from Madras, on a small estuary of one of the many small southern mouths of the Cauvery. The manufacture of cotton and silk fabrics was, in former times, extensively carried on here, but has greatly declined in consequence of the cheapness of British goods. A chief branch of industry is the expression of oil from the cocoa-nut and from oil-seeds. There is a considerable trade with Ceylon. The harbour is suited only for small coasting-vessels; but measures are in progress for its improvement. N. is a terminus of the Great Southern Railway of India. It was the capital of the Dutch possessions in India, but was taken by the British in 1781. Pop. (1871) 48,525.

**NELLORE**, a town of British India, capital of a district of the same name, in the presidency of Madras, situated on an elevation on the right bank of the Northern Pennar, 20 miles from its mouth, and 95 miles north-north-west from Madras. It is

irregularly built, and the population in some places much crowded; but there are some good streets. The abundant supply of water contributes to the health of the town. N. was formerly an important fortress. It is a curious circumstance that, in the end of last century, a pot filled with Roman gold coins and medals—chiefly of Trajan, Adrian, and Faustina—was found under the ruins of a small Hindu temple at Nellore. Pop. 30,000.

**NELSON**, the capital of a province of the same name, in New Zealand, is situated at the north end of South Island, at the mouth of the Maitai, a small river, and at the head of a large bay called Blind Bay. The situation is very beautiful, on a flat, hemmed in by rugged hills and amidst almost tropical luxuriance. The harbour, however, only admits vessels of 500 tons at high water, and this circumstance has much retarded the progress both of the town and the settlement. The centre of the town is a hill rising 40 feet above the surrounding streets, and laid out as a square with an Episcopal church in its centre. N. is the seat of a bishop. The city was founded in 1841. The population in 1871 was 5534. Three newspapers are published here. The manufactures of the town comprise cloth and leather. Steamers sail to the neighbouring ports.

**NERIAD**, a town of British India, in the presidency of Bombay and district of Kaira, on the route from Baroda to Ahmedabad, 38 miles north-west from Baroda, on a feeder of the Sabarmati. It is the chief town of an extensive and well-cultivated tract, which produces much tobacco, and contains many prosperous towns and villages. Pop. (1871) 25,520.

**NERVOUS DISEASES OF AN OBSCURE NATURE AND NERVOUSNESS.** Although the most important affections of the nervous system, as chorea, convulsions, epilepsy, hydrophobia, hypochondriasis, hysteria, neuralgia, paralysis, spasms, and tetanus, have been considered in special articles, there is an infinite variety of (often evanescent) forms which the diseases of the nervous system assume, some of which we propose now to consider.

These nervous affections are almost solely confined to women, and most of them may be regarded as modified forms of hysteria. *Simulated Pregnancy*, or, as the French physicians term it, *Nervous Pregnancy*, is an affection of not very rare occurrence. The abdomen gradually enlarges, the catamenia are suppressed, and sickness, enlargement of the breasts, with the other symptoms of pregnancy, supervene (as far as they can be recognised by the non-professional observer), and it is only the non-appearance of the infant at the expected period that leads to a suspicion of the true nature of the case. The diagnosis of such a case is extremely difficult, and the most celebrated accoucheurs have been deceived. We commence with this extreme instance, as being singularly illustrative of the power which a perverted action of the nervous system may impress upon certain persons. The somewhat allied cases in which patients persist in fancying themselves pregnant in opposition to the opinion of their medical adviser (as the well-known case of Queen Mary, so admirably drawn by Froude), are far more numerous. The intestines are often implicated in cases of a deranged condition of the nervous system. The excretion of gas from the intestinal mucous membrane is often much increased in the class of patients commonly called nervous. The rattling sounds produced by the movement of the gas—scientifically known as *bomborygni*—are sometimes so loud as to prevent the patient from entering into society with comfort; and sometimes the mere fear of the occurrence of these sounds is

sufficient to induce them. A depraved appetite, scientifically known as *pica*, is a common symptom of deranged nervous system both in chlorotic young women, in whom the catamenial discharge is not well established, and in pregnant women. See **MORBID APPETITES**. The not very rare cases of fasting women and girls belong to the same category. All these cases, however, ultimately undergo detection.

Dr Parry and other physicians have described cases of morbid sensibility of the mucous membrane of the pharynx, in which the muscles of the larynx are called into violent action if the patient takes a sip of water or other fluid. Such cases so strongly simulate hydrophobia, that they are described as hysterical hydrophobia.

Passing on to the special modifications which an abnormal state of the nervous system impresses on the organs of circulation, we have nervous palpitation of the heart, which may readily be distinguished from palpitation dependent on change of structure by due attention to symptoms. There is a peculiar form of abdominal pulsation, due solely to nervous influence, which may not very frequently be felt on pressing the hand on the patient's abdomen. It has in many cases been mistaken for aneurism.

The nervous symptoms implicating the respiratory organs are not only the most common of any, but are alarming and urgent, and may be readily mistaken for indications of serious inflammatory or organic disease. Nervous asthma, which is supposed to depend upon a spasmodic constriction of the bronchial tubes, is too well known to require comment. Women suffering from a deranged condition of the nervous system sometimes present symptoms of what may be termed nervous catarrh—such as a copious flow of tears, free discharge from the nostrils, and constant sneezing. Such cases are often periodic. They may be treated with preparations of iron, and are sometimes at once checked by a pinch of snuff. There are various forms of cough due mainly to nervous irritation, the difference in the character of the cough probably depending on the spot which is the seat of irritation. Thus, we hear of *spasmodic* cough, which is often accompanied by much straining and convulsive agitation, and somewhat resembles hooping-cough; *ringing* cough, accompanied by dyspnoea and hoarseness, or loss of voice; *barking* cough, often arising from irritation of the ovaries, &c. Such coughs as these are aggravated by depleting measures, ordinary cough medicines, &c., and usually disappear under the use of tonics.

The nervous affections of the motor system are conveniently grouped by Dr Laycock under three heads—(1) the first including those cases in which there is paralysis or spasm without distortion; (2) those in which distortion follows cessation of muscular equilibrium, as in the various forms of club-foot; and (3) paroxysmal affections. The best example of the *first* class is hysterical paralysis of the lower extremities, of which Sir Benjamin Brodie long ago wrote as follows: 'I have known not a few, but very numerous instances of young ladies being condemned to the horizontal posture, and even to the torture of caustic issues and setons, for several successive years, in whom air, and exercise, and cheerful occupations would probably have procured a cure in the course of a few months.' A notice of such cases as these may be found in the article **HYSTERIA**. Paralysis of a lateral half of the body, or of one limb only, may also be merely a manifestation of hysteria. The *second* class is well illustrated by the following case, which is reported by Mr Shaw. A

young lady who had suffered from a train of symptoms indicative of a disturbed nervous system, had the ankle so turned round that she walked on one side of the foot. The knee was also bent outwards, and the spine was becoming distorted. Sir Charles Bell, who saw her in consultation, regarded the case as one of wilful deception, and in a year's time his diagnosis was completely established, scarcely any trace of lameness being apparent. Many of the joints—as the knee, hip, &c.—may be the seats of purely neuralgic symptoms, which so closely simulate organic disease of the cartilages, as to lead to the removal of the limb. Carmichael, Brodie, and others have recorded cases in which this terrible mistake has been made by experienced surgeons. Spinal irritation, or spinal tenderness, is a mysterious affection, whose diagnostic value is not very definite, as it may arise from a large number of distinct conditions, as, for example, disease of some part of the spinal cord, uterine disease, chronic disease of the intestinal viscera, &c.

One of the most anomalous affections of the nervous system ever recorded is described by Mr Holden in the *St Bartholomew's Hospital Reports*, 1867, vol. iii., pp. 299—305. The patient was a bright-looking boy about 12½, who, as he lay reading in bed, presented every appearance of perfect health: all that he complained of was what he called his 'bump,' which was about the size of a hen's egg, and lay on the right side of the neck, just above the shoulder. If the 'bump' were touched, even most gently, the boy instantly lost all consciousness, and became deaf, dumb, and blind, while his body became arched like a bow, and was supported only by the back of the head and the heels, while his arms were rigidly extended. He might be pinched or pricked, but shewed no sign of sensation. After remaining in this state for somewhat less than a minute, he drew a deep long breath, which was followed by a deep sigh. Instantly the spasm ceased, and the body fell, seemingly lifeless, on the bed. After two other similar sighs, which occurred in a few seconds, the boy awoke as if from profound sleep, and in a few minutes was none the worse for what he had gone through. Whenever the bump was touched—even when the boy was fast asleep—the same phenomena occurred. (It was found that, on touching the backbone in the dorsal region, the same series of events happened.) By continuous gentle manipulation of the bump, the boy was kept unconscious for twenty minutes. Another and even more remarkable phase of the boy's affection was his crouching and barking fit, which took place every day at the same time, almost to a minute. See the Reports above cited.

With this illustration, we close our remarks on what may be termed *Anomalous Nervous Affections*. With regard to *Nervousness*, which also stands at the head of this article, we may observe, that it is a word pertaining rather to the vocabulary of the patient (and pre-eminently of the female patient) than of the physician. It is usually understood to indicate a condition of which a restless mobility, with or without an undue excitability of the nerves of sensation, is the chief characteristic. For further information on this subject, the reader is referred to Dr Laycock's various works, and to Romberg's *Diseases of the Nervous System*, 2 vols., translated by Dr Sieveking.

**NEST-BUILDING APES.** Reference was made, but with some hesitation, in the article **GORILLA**, to certain new species of apes of the same genus with the chimpanzee and gorilla, said to have been discovered by M. du Chaillu in Western Africa. The complete vindication which has since taken place of that traveller's reputation as a truthful

and trustworthy observer, makes it necessary to give some further notice of these now unquestioned discoveries, exceedingly remarkable on account of the habits of some of the animals. To protect themselves from the rain, they construct nests, or rather umbrellas, among the branches of the trees, of long branches and leaves laid one over the other very carefully and thickly, so as to be 'capable of shedding water.' The branches are fastened to the tree in the middle of the structure by portions of the stems of twining shrubs, abundant in these forests. When the leaves dry, so that the structure no longer keeps out the rain, the owner builds another shelter; and Du Chaillu says this happens

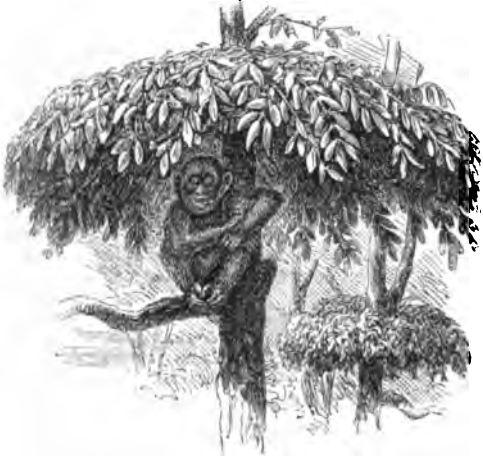

Nest-building Ape (*Troglodytes calvus*).

once in ten or fifteen days. The nest-building ape (*Troglodytes calvus*, called Nahiego Mbouve by the natives) is nearly four feet in length. Du Chaillu supposes this ape to rest all night on a projecting branch under its nest or umbrella, with an arm round the stem of the tree for security. The nests are generally constructed about 15 or 20 feet from the ground, and invariably on a tree which stands a little apart from others, and which has no limbs below the one in which the nest is placed, probably in order to safety from serpents and other animals. These apes inhabit the most lonely parts of the forests. The nests are never congregated together, so that this ape does not seem to be gregarious. It feeds on fruits.—Du Chaillu discovered a second species of nest-building ape, on his second visit to the Ogobai, very similar to the *Troglodytes calvus*, but which constructs its nest in a somewhat different fashion. It is called Nahiego Nkengo by the natives. It makes its nest or shelter at the height of about 20 or 30 feet from the ground, by bending over and intertwining a number of the weaker boughs, the foliage of which forms its protection from rain.

NEU-CHWANG, or YING-TSZE, a town of the Chinese Empire, in Manchuria. It stands on the left bank of the river Liaou, about 25 miles from its mouth, and in lat. 41° N., and long. 122° 30' E. The Liaou, which falls into the Gulf of Liaou-tong, at the head of the Yellow Sea, is navigable for sea-going vessels to N.; and N. is therefore regarded as a seaport, and is one of those opened to foreign trade by the treaty of Tientsin. A British consul resides here; but the trade is as yet inconsiderable, and only to Chinese ports.

NEUILLY (sometimes called NEUILLY-SUR-SEINE, to distinguish it from several much less

important places of the same name), a town of France, in the dep. of Seine, on the right bank of the river Seine, immediately to the north of the Bois de Boulogne. N. may now be regarded as a suburb of Paris, with which it is connected by several streets, or roads, lined with numerous villas. Here, near the Seine, and in a large and beautiful park, formerly stood the Château de Neuilly, built by Louis XV., and the favourite residence of Louis Philippe, which was burned at the revolution in 1848. The park was also then divided into lots for sale, the consequence being a rapid increase of the number of houses in Neuilly. N. has manufactures of porcelain and starch, chemical works and distilleries. Pop. (1872) 15,466. When Louis Philippe abdicated, and took refuge in England, he assumed the title of Count de Neuilly.

NEU'MÜNSTER, a prosperous manufacturing and market town of Holstein, on the Schwale, one of the head-waters of the Stoer, and on the railway between Altona and Kiel, 19 miles south-by-west from Kiel. There are large woollen and linen factories, tanneries, dye-works, and breweries. Pop. (1875) 10,124.

NEUSTETTIN, a town of Prussia, in the province of Pomerania, 92 miles south-west from Danzig, on the southern shore of the Vilm See. It is the capital of a circle, and a place of some importance. Pop. (1875) 6971.

NEUTRA, a town of Hungary, the capital of a county of the same name, on a river of the same name, 72 miles north-north-west from Pesth. N. is a very old town, having been the residence of a Moravian prince in the 9th c., before the Magyar invasion. Weaving is carried on to some extent, and N. being not far from the Moravian frontier, has a considerable transit-trade. Pop. (1869) 10,683.

NEVIA'NSK, a town of Russia, in the government of Perm, 50 miles north from Ekaterinburg. It is on the eastern or Siberian side of the Ural Mountains, and stands on the Neiva, the waters of which flow by the Tobol and the Irtysh to the Obi. The district around N. is famous for its mineral wealth, particularly for its productiveness of gold, copper, and platinum. N. has a mint, the tower of which is remarkable as leaning even more than the celebrated tower of Pisa. Pop. 18,000.

NEW'CHURCH, a very thriving town of Lancashire, England, 19 miles north from Manchester, in Rossendale, not far from the source of the Irwell. It has recently and rapidly risen to its present importance. There are numerous cotton and woollen manufactories, employing many operatives. Coal is also wrought in the neighbourhood, and there are numerous large quarries of excellent freestone. Pop. about 4000. The neighbourhood is very populous, abounding in manufactories and other public works.—Not much more than a mile to the west of N., is Rawtenstall, a large village, now almost a town, and rapidly increasing.

NGAN-KING, a large and wealthy city of China, the capital of the province of Ngan-whi. It stands on the left bank of the great river Yang-tze-Kiang, 190 miles south-west from Nankin. The surrounding country is highly cultivated, and very densely peopled. The mineral riches of the neighbourhood are also considerable. N. is a place of busy trade, great part of the goods intended for Nankin passing through the hands of its merchants. The trade is carried on by means of vessels on the river. Porcelain and cloth are among the principal articles of trade.

NIARE (*Bos brachicheros*), the wild ox or buffalo of tropical Western Africa, is in size and weight

about equal to the smaller breeds of British oxen, but of greater strength. The head is rather small, the muzzle black, the ears long and pointed, and fringed with beautiful silky hair, several inches long. The horns are 10 or 12 inches long, curved backwards, and sharply pointed. The animal is gracefully proportioned, having nothing of the clumsiness of the common buffalo. The body is covered with a coat of thin red hair. The tail is tufted at the extremity with black hair



Niare (*Bos brachicheros*).

several inches long. Herds of these oxen were seen by Du Chaillu in the open or prairie lands to the south of the mouth of the Ogobai. They are shy and fierce; if wounded, they turn upon the hunter with terrible fury. No attempt seems yet to have been made to domesticate this animal, which is probably very capable of it, and might be found more suitable than other oxen for warm climates.

NICARA'GUA, or RIVAS, a town of the republic of Nicaragua (q. v.), Central America, on the western shore of the Lake Nicaragua (q. v.), 35 miles south-south-east from Granada. It is not a place of much commerce, the commerce of the lake being chiefly carried on by Granada. Pop. 8500.

NICHOLSON, JOHN, British general, one of the most distinguished of the later school of Indian soldiers, was born in Dublin, 11th December 1821. His father, a physician of considerable reputation in that city, died when the boy had just completed his 8th year. By his mother, a woman of strong sense and much practical piety, he was carefully educated; and from her he seems to have inherited or imbibed a certain religious gravity and earnestness of character which was early noted in him, and continued to distinguish him through life. Through the influence of her brother, Sir James Weir Hogg, an Indian cadetship was obtained for him; at the age of 16, he arrived in Calcutta, and was soon after posted to the 21st Native Bengal Infantry, then stationed at Ferozepore. In 1840, his regiment was ordered to Ghizni in Afghanistan, where two years after, in the disastrous insurrection which avenged our occupation of the country, it was compelled to surrender to the enemy. After a time of miserable captivity, he regained his liberty, and joined the relieving army under General Pollock, to be saddened immediately after by the death, in action, of his brother Alexander. A period of inactivity ensued, during which he was stationed at Meerut, doing duty as adjutant of his regiment. On the breaking out of the Sikh war in 1845, he served in the campaign on the Sutlej, and was present at the battle of Ferozeshah, though, as attached to the commissariat department, without special opportunity of distinguishing himself. After the cessation of the war, through the recommendation of Colonel (afterwards Sir Henry) Lawrence, N., now a

lieutenant, was appointed assistant to the resident at the conquered capital, Lahore, and thus fairly transferred to the political branch of the service, in which most of his future time was passed. But shortly, with the outbreak of the Sikh rebellion in 1848, there came an interlude of military activity, in which he greatly distinguished himself. To N.'s daring and promptitude was due the preservation to us of the important fortress of Attock; and soon after, his success at the Margulla Pass, in intercepting and defeating a large body of the insurgents, brought his name prominently before the world. Throughout the struggle which followed, he rendered important service; and at the great battles of Chillianwalla and Gujerat successively, he earned the special approval of Lord Gough, to whom he was immediately attached.

The Punjab having finally become a British province, Captain N. was appointed a deputy-commissioner under the Lahore Board, of which Sir Henry Lawrence was president. He had now been nearly ten years in India; his strength was somewhat shaken by arduous service, and various illnesses which from time to time had assailed him; and above all, he was anxious to visit and console his widowed mother, then prostrated by the death in India, by an accident, of William, his younger brother. In 1850, accordingly, he took his furlough, and returned home, taking Constantinople *en route*, and visiting, with an eye to professional instruction, the capitals of all the great military powers of the continent. On his return to India, he was again appointed by Lawrence a deputy-commissioner in the Punjab, and for five years subsequently his work lay among the savage tribes of the frontier. His success in bringing them under thorough subjection to law and order, was something marvellous; and such were the impressions of fear and reverence wrought by the force and massive personality of the man, that he became among these rude populations, under the title of 'Nikkul Seyn,' the object of a curious kind of hero-worship. So far was this carried, that a sect actually arose, of Nikkul-Seynees, who consecrated him as their Gura (or spiritual guide), and persisted—despite of severe floggings regularly inflicted by the worthy men, indisposed to accept of divine honours—in falling at his feet, and making him an object of express adoration.

With the outbreak of the great mutiny in 1857 came N.'s supreme opportunity, and the brief career of glorious achievements in which he developed in the eye of the world the full power and splendour of his military genius. In the saving of the Punjab, virtually India was saved to us; and under Sir John Lawrence, who had succeeded his brother, Sir Henry, N.—though not without noble coadjutors to divide with him the honour—perhaps did more than any other single man to hold firm our grasp of the Punjab. He it was who suggested the formation of the famous movable column, by which mainly the work was done, and presided over its organisation. Shortly, he was appointed to command it; and in his dealings with the suspected regiments of sepoy, he exhibited a particular combination of boldness with subtlety, discretion, and astuteness, scarcely too much to be admired. At Trimmu Ghaut, on the 12th and 14th of July, he brought to bay, and nearly utterly annihilated, a large force of the declared rebels. Things thus made safe behind him, he marched to reinforce the army of General Wilson, engaged in the siege of Delhi, arriving in camp on August 7. His presence and counsels gave new impulse to the operations; and in every way he strove, with fiery and impatient energy, to expedite the delayed

assault. A strong body of the enemy having tried to make their way into the British rear, to N. was assigned the task of intercepting and bringing them to battle. This he achieved on August 24, near Nujffghur—under circumstances of extreme difficulty, in the most masterly manner surmounted—obtaining a most brilliant result in the complete ruin and dispersion of the mutineers. When the assault on the city was at last ordered, General N. (for to this rank he had now attained) was selected for the post of honour; and on the morning of September 14, he led the first column of attack. After the troops had forced their way into the city, an unforeseen check occurred, and N., ever in front, exposed himself in the most fearless manner to animate his men to advance. Conspicuous by his towering stature, he became the mark of the enemy's bullets, and fell, shot through the body. He lingered for some time in great suffering, and died on the morning of the 23d. Over the whole of India, the victory was saddened by his death; for it was felt that in John N., to use Lord Canning's expression, 'a tower of strength' had fallen. During the whole war of the mutiny, though it claimed many noble victims, there fell no man more regretted in his death than N., or in his death more worthy of regret. Throughout his career, he shone—as opportunity offered—a veritable 'king of men;' one of those born to command, who naturally and inevitably rise to it, and however great in achievement, seem to need only the hap of ampler opportunity in the future, to outdo their great achievements in the past. No one ever seems to have come fairly in contact with him without being strangely impressed with this sense of a magnificent reserve of power in him. It remains only to add, that his nature was on the one side as gentle, tender, and affectionate, as on the other it was strong and brave; and that, by all who had intimate relations with him, he was not less beloved for his mild virtues, than for his sterner gifts honoured and admired. To his memory all honour was paid. The Queen commanded it to be officially announced that, had he lived, he would have been created a Knight Commander of the Bath; and by the East India Company, a special grant of £500 a year was voted to the mother who survived to mourn for him.—For further details of the life of this man of right noble and heroic mould, the reader is referred to the account of him—from which this little sketch is redacted—given in Kaye's most interesting work entitled *Lives of Indian Officers* (2 vols., Lond., A. Strahan & Co., 1867).

NICOLAI, OTTO, a German musical composer of note, born at Königsberg in 1809. His early life was a struggle with poverty and difficulties. He studied for three years in Berlin under Klein; and in 1835 went to Rome, where he went through three more years of study under Baini. After travelling for ten or twelve years over Europe, he became, in 1847, Kapellmeister at Berlin, a post which he soon resigned. He appeared as a composer of dramatic music as early as 1831; but his first work of importance was *Il Templario*, founded on Scott's romance of *Ivanhoe*, which, produced at Turin in 1841, attained a high and permanent reputation. In 1848, he wrote at Berlin *Die Lustigen Weiber von Windsor*, on which his renown as a musician is founded, a work charming for its clear design and lively vigorous tone, whose overture is almost worthy of Weber. Two months after the production of this his *chef-d'œuvre*, its composer died at Berlin.

NICOSIA, a city of Sicily, in the province of Catania, 70 miles south-west from Messina. It is situated on the crest of a steep conical hill between

two head-branches of the Salso. It has scarcely any manufactures, but carries on some trade in corn, wine, oil, and cattle. Near it are beds of alum schist, a rich mine of rock-salt, and springs of petroleum. Pop. 14,250.

NIEUWER AMSTEL, a town of the Netherlands, in the province of North Holland, five miles south-by-west from Amsterdam. Pop. 8068. A few miles to the east of it is the village of Ouder Amstel, with about 3000 inhabitants, on the Amstel, one of the smaller mouths of the Rhine, which passes through the city of Amsterdam, and falls into the Zuider Zee.

NISCEMI, a town of Sicily, in the province of Caltanissetta, 10 miles north-east from Terranova, and on the right bank of the river Terranova. In 1790, this town was visited by an earthquake, and during seven shocks, the ground gradually sank, in one place to the depth of 30 feet. Fissures opened, which sent forth sulphur, petroleum, hot water, and mud. Pop. 10,750.

NISCH, or NISSA, a town of Roumelia, European Turkey, 122 miles south-east from Belgrade. It stands on the left bank of the river Nissawa, a branch of the Morawa. The town is ill built; but many new houses, and a well-supplied bazaar, attest its present prosperity. N. has long been noted as the point of meeting of many roads, both of military and commercial importance. It seems likely to acquire fresh importance by the construction of a railway from Belgrade to Constantinople and Thessalonica. In ancient times, N. bore the name of *Naisce*, and was a flourishing town of Upper Moesia. About a mile from it is a tower composed of human skulls, erected to commemorate a victory of the Turks over the Servians; and not far off is the hill of Woinik, or Kriegsberg, where, in 1689, the Markgraf Louis of Baden, with 17,000 men, destroyed a Turkish army of 40,000. Pop. 13,000.

NITI-GHAUT, a pass of the Himalaya, between the British district of Kumaon and Tibet. It takes its name from the village of Niti, in Kumaon, 12 miles south of the pass, in lat. 30° 47' N., and long. 79° 58' E. The pass is 16,814 feet above the level of the sea. This is regarded as the easiest pass between Kumaon and Tibet, and is consequently one of the principal channels of trade between Hindustan and Chinese Tartary. The Bhotias of Niti subsist chiefly by the carrying of goods in this trade. The articles of merchandise are conveyed on yaks, goats, and even sheep. Travellers often suffer much from difficulty of respiration on the pass of Niti-Ghaut, on account of the rarefaction of the air.

NITRO-BENZOL. This substance has recently taken a prominent place amongst the narcotic poisons. Under the name of *Essence of Mirbane*, it is largely employed, as a substitute, in perfumery and confectionery, for oil of bitter almonds, which it closely resembles in smell, and to confectionery it gives the smell, but not the agreeable taste of that oil. It is a pale, lemon-coloured liquid, with a pungent, disagreeable taste, and distinguishable by its odour from all other liquids, except oil of bitter almonds, from which it differs in the following reaction: Pour a few drops of each on a plate, and add a drop of strong sulphuric acid. The oil of almonds acquires a rich crimson colour with a yellow border, while the nitro-benzol produces no such colour. In 1859, Professor Casper of Berlin published an account of this liquid under the name of 'A New Poison,' and described its effects on dogs and rabbits. In 1862, and since that date, various cases of human poisoning have been published, both



in this country and abroad. We shall briefly notice three cases, in two of which the patient died, after swallowing a portion of the fluid; while in the other, the inhalation of the vapour proved fatal. A boy, aged 17, while drawing off some nitro-benzol by a siphon, swallowed a portion of the liquid. There were no immediate symptoms; but he soon felt sleepy, and when at dinner, ate but little, and said he felt as if he was drunk. This was between two and three hours after he had swallowed the liquid. He fell into a stupor, which became deeper and deeper, until death took place, without vomiting or convulsions, twelve hours after the ingestion of the poison. In the case of a man, aged 43, who spilled a quantity of nitro-benzol over his clothes, and went about for several hours breathing the vapour, the effects were nearly the same. The progress of each of these cases, both of which are described by Dr Letheby in the *Proceedings of the Royal Society* for 1863, was much the same as that of slow intoxication, excepting that the mind was perfectly clear until the coming on of the fatal stupor, which was sudden, as in a fit of apoplexy. From that moment, there was no return of consciousness or bodily power; the sufferer lay as in a deep sleep, and died without a struggle. The duration of each case was nearly the same, about four hours intervening between the swallowing or inhaling of the poison and the beginning of stupor or coma, which lasted five hours. Nitro-benzol, as well as aniline, into which it seems to have been partly converted in the body, was detected in the brain and stomach. It is unnecessary to describe the steps to be taken for the detection of the poison in all these cases: no one but a professed toxicologist should be intrusted with an investigation on the result of which the life and character of a human being may depend. It is satisfactory to read Dr Taylor's opinion, that 'there is no probability that this liquid will be successfully employed for the purposes of murder without the certainty of detection.'—*Principles and Practice of Medical Jurisprudence*, p. 311. It is worthy of notice that the vapour of this substance, as it is evolved from almond glycerine soap, has seriously affected females; and Dr Taylor mentions the case of a gentleman who, from using a cake of the soap in taking a warm bath, fainted from the effects of the vapour, and was ill for some months afterwards. The mode of treatment that should be adopted in poisoning by this substance, is essentially the same as that which should be adopted in poisoning by opium.

NITRO-GLYCERINE [C<sub>3</sub>H<sub>5</sub>N<sub>3</sub>O<sub>9</sub> or C<sub>3</sub>H<sub>5</sub>(NO<sub>2</sub>)<sub>3</sub>O<sub>4</sub>], known also as *Glonoïn* or *Glonoïn Oil*, is a compound which is produced by the action of a mixture of strong nitric and sulphuric acids on glycerine at low temperatures. Two methods of preparing it are given in *Watts's Dictionary of Chemistry*, vol. ii. pp. 890, 891, to which we must refer the reader who seeks for details on this subject. According to whatever method it is prepared, it is obtained as a light yellow oily liquid, of specific gravity varying from 1.525 to 1.6, inodorous, but having a sweet pungent aromatic taste; a single drop, however, if placed on the back of the tongue, produces headache and pain in the back, which last for many hours. It is only slightly soluble in water, but dissolves readily in ether, alcohol, and methylated spirits; according to Adriani (the *Chemical News* for January 3, 1863), it does not inflame or explode when touched by a light; but regarding its inflammability there seems a difference of opinion, for Richter of Freiberg, in a recent Memoir, entitled *Experiments with Nitro-glycerine*, observes that it does not take fire easily, and when

lighted, burns, but does not explode, and goes out as soon as the flame with which it has been brought in contact is taken away. On this very important point, further experiments are required. But although contact with flame does not cause it to explode, this result follows if it is exposed to a moderately strong blow or concussion, to the concussion due to the explosion of gunpowder, to contact with red-hot iron, and especially to the action of detonating mixtures and fulminates; it likewise explodes on exposure to a high temperature (see below); the explosion, however it is produced, being in all cases excessively rapid, and unaccompanied by smoke. It is this explosive power that renders this compound a useful agent in blasting. According to Dr Rudolf Wagner, the distinguished Bavarian technologist, it may be cooled down to 4° without becoming solid; but this statement probably refers to the chemically pure compound; for the nitro-glycerine of commerce, which has been patented by a German, under the name of *Nobel's Patent Blasting Oil*, becomes solid if exposed for a considerable time to a temperature of 46°, crystallising in long needles, which are most dangerous to handle, since they explode, even on being gently broken, with appalling violence. At 320°, nitro-glycerine begins (according to Dr Adriani) to decompose, giving off red vapours; and if the heat be suddenly applied, or slightly raised above this point, the substance explodes with great violence; while, according to other observers, it is liable to explode at 240°, or a little higher; and if exposed for a length of time to half that temperature, explosion may take place at 180° or less. It is obvious from the formula for nitro-glycerine that it may be assumed to consist of glycerine, C<sub>3</sub>H<sub>5</sub>O<sub>3</sub>, in which three atoms of hydrogen are replaced by three of peroxide of nitrogen, NO<sub>2</sub>. The products of the complete combustion of 100 parts of pure nitro-glycerine are—water, 20 parts; carbonic acid, 58; oxygen, 3.5; and nitrogen, 18.5; and hence, it has been calculated that one volume (say, a cubic inch) of this compound, at a specific gravity of 1.6, yields, on combustion or explosion:

Aqueous vapour,	. 554	volumes (say, cubic inches)
Carbonic acid,	. 469	" "
Oxygen,	. 39	" "
Nitrogen,	. 236	" "
	1798	" "

According to Nobel, these gases expand, on explosion, to 6 times their bulk; in which case, 1 cubic measure (say, 1 cubic inch) of nitro-glycerine will yield 10,384 cubic measures (say, cubic inches) of gases; while 1 cubic measure of gunpowder will only yield 800 cubic measures of gases. Hence, it follows that, for equal bulks, nitro-glycerine is 13 times as strong as gunpowder, while for equal weights it is 8 times as strong.

The danger of using this compound in mining, &c. is greatly increased by its instability. Even when pure, it is liable, at a heat of 70° or less, to undergo slow, spontaneous decomposition into glycerine, oxalic and hydrocyanic acids, ammonia, &c., with a continuous escape of gaseous products, which, exerting pressure on the liquid, renders it so prone to explosion that even a slight concussion is attended with danger; and the impure commercial compound decomposes far more rapidly than the pure nitro-glycerine: indeed, impure nitro-glycerine may, from this cause, be regarded as 'dangerously self-explosive even while standing quietly' (Adriani, *op. cit.*).

Many of our readers doubtless recollect the history of a terrific explosion that took place on board the ship *Europea*, when lying in harbour at Colon, Panama, on the 3d of April 1866. Amongst the cargo put on board at Liverpool were 70 cases of nitro-glycerine, and one case containing 70,000

## NITRO-GLYCERINE.

percussion-caps. At 7 A.M. on the 3d, a most tremendous explosion occurred in the after-part of the ship. It was described as most rapid, without smoke, but with a great flame, and the ship was immediately after seen to be on fire. The whole of the deck and cabin aft were carried away, and the side of the ship was also much damaged, the plates above the water-line being blown away, and the parts below it being much injured. For fear of further explosions, the ship was towed into the bay, where she shortly sunk. Nor was the injury confined to the *European*; the jetty was nearly blown away, and a vessel lying on the other side of it was much damaged. Houses in the town were also partially destroyed, the floors in many cases being torn up; and altogether about 50 lives were lost. When the bodies were recovered, they presented no sign of smoke nor any symptoms of scalding; and hence it was inferred that the explosion could not have been produced either by the percussion-caps or by steam. On these and other grounds, the conclusion was irresistible that the explosion was due to the nitro-glycerine. An action was (August 1867) brought at Liverpool by the owners of the *European* against the shippers of the nitro-glycerine, on the ground that no due notice of the dangerous properties of that compound had been given; and at this trial, several of the important points regarding the explosive properties of nitro-glycerine, which we have noticed, were elicited from Professor Abel, chemist to the laboratory at Woolwich; Colonel Boxer, superintendent of the Woolwich Laboratory; and Professor Roscoe, who appeared as scientific witnesses. To give some definite idea of the explosive force of this substance, Professor Roscoe stated that one case of it would have sufficed for the destruction of the *European*. It is used to a considerable extent in the slate-quarries in Wales, and in mining operations. A workman at one of those quarries described how he had been set to clean a wagon which had held some of it, which he did by scraping it with a piece of slate; and inadvertently throwing the piece of slate into the wagon when he had finished, the percussion exploded the remnants of the oil, and the wagon was blown to pieces. He states that it is regarded as ten times as powerful an explosive agent as gunpowder.

We learn from a number of the *Nevada Gazette* (quoted in the *Chemical News*, Aug. 16, 1867), that this substance has been advantageously employed in the blasting necessary for the construction of the summit tunnel on the Central Pacific Railway. The operation is said to have been carried on 25 per cent. faster than if powder had been used. The small holes required for the oil can probably be drilled in less than one-third the time required for the larger ones necessary in using powder. The oil does much more execution than powder, as it always breaks the rock from two to sixteen inches beyond the hole, and also throws out a much larger body. The oil was estimated as having, in hard rock, a strength five times greater than powder. It was made upon the spot, and was considered much stronger as well as safer than the imported compound. After having been used for several months, there had been no accident, nor had a single blast missed fire since the Chinamen commenced filling the cartridges. Colonel Schaffner of the U.S. army published an official Report on this compound, to which he gives the name of 'nitroleum,' which confirms the fact that its explosive properties are far greater than those of gunpowder. From a Report on the same subject by Captain Grant, R.N., it appears that it is exploded by percussion, and apparently, under ordinary circum-

stances, by nothing else—neither by friction nor fire. Generally, a trifling blow is sufficient to explode it. Its explosive force is about ten times that of gunpowder. It has all the appearance of common oil, and is usually carried in tin cases, each of which holds 25 lbs. Each can is packed in a wooden case for carriage. In a paper on this subject by M. Kopp, that chemist holds the view already noticed, that accidents are mainly due to the presence of impurities. He states that, by means of charges of 1500 or 2000 grammes of oil, from 40 to 80 cubic metres of a hard rock may be detached.

We have already noticed Richter's observations on the slight inflammability of this compound; and as the employment of this explosive agent seems to be increasing, we shall give his other chief results, so as to bring up our knowledge to the latest possible date. The shaft in which the experiments were made was being sunk 30 feet long by 8 feet wide, in hard gray gneiss with occasional joints, which facilitated the working. From these experiments, it appeared not only that its power was four or five times greater than that of the nitrate-of-soda gunpowder commonly used for mining purposes in Germany, but that other advantages accrued from its use, which may be summed up as follows: (1.) Fewer men are wanted for working out a certain-sized piece of ground, and fewer holes have to be bored than at present. (2.) Nitro-glycerine does not take fire easily (see above). (3.) The amount of smoke after a blast is small, as compared with that of powder; and workmen can return at once to the spot when the blast has taken place. (4.) Holes that have missed, or only partly torn, can be retamped and shot off, which, with the present arrangements, is impossible, or very dangerous. Against these advantages must be set off the following disadvantages: (1.) The gases formed during the explosion of nitro-glycerine have an injurious effect on the organs of sight and respiration. (2.) Nitro-glycerine explodes on being struck smartly, and easily freezes. (3.) The masses of rock which it removes are mostly very large, and considerable time has to be spent in breaking them up.

In another set of experiments, the relative cost of blasting by nitro-glycerine and gunpowder was compared, and it was found that a cubic fathom of ground could be removed by the former for £4, 0s. 4d.; the cost amounted to £5, 0s. 9½d. when the latter was used. In sinking a shaft in clay-slate by means of nitro-glycerine, the cost was under £3 per cubic fathom. For further details regarding these experiments, the reader is referred to the *Chemical News*, November 15, 1867, which contains a translation of Richter's valuable Memoir.

In the *Times* for December 10, 1867, there was a notice of a serious explosion from the employment of this agent within a few miles of the city of New York. The accident happened in the Berger quarries. Nine persons were blown to pieces, and ten or fifteen wounded, while the ground was shaken for fully a mile round, and several houses were destroyed.

A very serious accident took place on Tuesday, December 17, 1867, at Newcastle, and occasioned the loss of seven lives. The editor of the *Chemical News*, December 20, 1867, remarks, that 'unless means are taken by the manufacturers to prevent explosions causing such lamentable results as these, a valuable blasting agent will be lost to miners and quarrymen. If this be the case, however, the manufacturers of it will have themselves to blame, for explosions of nitro-glycerine during transport or storage ought to be unknown. It has recently been discovered that

nitro-glycerine dissolved in two or three times its bulk of methylated spirit is quite inexplosive, and that, when required for use, the addition of water will precipitate the oil, the layer of water and spirit merely requiring decanting off. The nitro-glycerine separated in this way possesses explosive properties quite as active as the original oil, which, indeed, is frequently rather improved than otherwise by the treatment. Shipping agents and railway companies should refuse to receive nitro-glycerine unless protected in the manner indicated.

It will be observed that all these terrible accidents are of recent date. Although nitro-glycerine was discovered about 20 years ago by Dr Sobrero (now professor at Turin), it remained simply an object of scientific interest, till glycerine was manufactured on a large scale—that is to say, till eight or ten years ago. We believe that it was at the close of 1864 that it first became an article of commerce.

[More recently, a compound of nitro-glycerine with gun-cotton, the constituents of gunpowder, infusorial earth, and one or two other substances, forming a paste, has been invented by Professor Engels of Cologne, and is coming into extensive use for mining and other purposes. It is known as *dynamite* or *litho-fracteur* (stone-breaker), and is described as possessing immense power. Its great recommendation, however, is its safety; it can be exploded only by a percussion-cap. It may be let fall, or exposed to the most violent concussion, without being affected; when ignited by ordinary fire, as a cigar-fuse, it merely burns away with a slight hissing noise.]

**NOCTULE** (*Vespertilio noctula*), the largest British species of Bat (q. v.), being nearly three inches long without the tail, which is fully an inch and a half. The ears are oval-triangular, shorter than the head; the muzzle is short and blunt. The N. is only seen on the wing during a short part of the year, retiring early in autumn to hollow trees, caves, or under the eaves of buildings, where many are sometimes found together.

**NOMBRE DE DIOS**, a town of Mexico, 35 miles south-east from Durango, in a mountainous district. Near it are rich silver mines. Pop. 7000.

**NORDEN**, a town of Prussia, in the province of Hanover, 72 miles north-west from Oldenburg, and a few miles from the North Sea, with which it is connected by a canal. Pop. (1871) 5952.

**NORTHERN LIGHT-HOUSES, COMMISSIONERS OF**, the body corporate which has under its management the whole of the light-houses of Scotland and Isle of Man. The body was first constituted by act of parliament 26 Geo. III., but has been frequently since the subject of legislation. The light-houses of the Isle of Man were assigned to it in 1815. By the Merchant Shipping Act, 1854, the Commissioners are so far limited in their powers, that any proposal for a new light-house must receive the approval of the Trinity House, London, and the outlay must be sanctioned by the Board of Trade; the cost, however, is borne by the imperial light-house fund. The Commissioners act wholly in virtue of office, and give their services gratuitously. The body consists of the Lord Advocate, Solicitor-general, Lord Provost and senior Bailie of Edinburgh; Lord Provost and senior Bailie of Glasgow; Lord Provost of Aberdeen; provosts of Inverness, Campbellton, Dundee, and Greenock; and the sheriffs of the following counties—Aberdeen, Argyll, Ayr, Berwick, Bute, Caithness and Sutherland, Edinburgh, Elgin, Fife, Forfar, Haddington, Inverness, Kincardine, Lanark, Orkney and Shetland, Renfrew, Ross, Wigton, and Kirkcubright. The

business of the Commissioners is conducted at an office in Edinburgh, with the assistance of a secretary and consulting engineers. In 1877, the number of light-houses under charge of the commission was 60, besides buoys and beacons. The Commissioners own a steam-vessel, the *Pharos*, for supplying stores to the several light-houses, and performing annual visits of inspection. The whole system of northern lights is remarkably well organised, the merit of which is in a great measure due to the late Robert Stevenson (q. v.). A Royal Commission appointed some years ago to inquire into the management of the English, Irish, and Scottish light-houses, has acknowledged that the 'Scotch light-houses are in the best state of general efficiency, the English next, and the Irish third.'

**NOSSI-BÉ, NOSSI-BARIN, VARIOU-BÉ, or HELLEVILLE**, an island on the north-west coast of Madagascar, at the mouth of the Bay of Pasoadava, and separated from the mainland by a narrow channel. It is about 74 sq. m. in extent; its coast-line is very much indented; and its surface much diversified. The highest hill is 1700 feet in height, and is clothed to the summit with magnificent trees; but much of the island has a bare aspect, the forests having been cut down in order to the cultivation of rice. The soil is very fertile, and rice, maize, manioc, bananas, &c., are produced far beyond the wants of the inhabitants. The soil is volcanic, and there are several old craters filled with water. Nossi-Bé has been in the hands of the French since 1840, and is regarded by them as an important possession, on account of an old claim which they suppose themselves to have to Madagascar. There is on this island a small town called Helleville, with a harbour well sheltered from the north and east winds. There is good anchorage also at several other parts of the coast. The pop. of the island is about 8000.

**NOSSI-IBRAHIM, or SAINTE MARIE**, an island on the east coast of Madagascar, and separated from it by a strait of about 5 miles in width. It is about 40 miles in length from north-north-east to south-south-west, but only a few miles in breadth. It is one of the much-prized possessions of the French on the coast of Madagascar, has been in their hands since 1750, and is their chief place of commerce on that coast. The soil is generally arid, and the climate moist and unhealthy. Rain is of extreme frequency. The pop. of the island is about 5000. It contains a small town called Saint Louis—a seaport, and fortified. All the French possessions on the coast of Madagascar were placed by an imperial decree of 1851 under one government, that of the Comoro Isles (q. v.).

**NOTORNIS**, a genus of birds of the family *Rallidae*, nearly allied to the coots, although in some of its characters it resembles the Ostrich family. One living species only is known, *N. Mantelli*, a native of New Zealand. It is particularly interesting, because the genus was originally established and the species characterized by Owen, from remains found along with those of *Dinornis* and other large birds of the Ostrich family, called Moas by the New Zealanders. The bird was, however, ascertained in 1850 still to exist. It inhabits some of the most unfrequented parts of the Middle Island. It is larger than the other coots, but small in comparison with the true moas. The flesh is said to be delicious. It seems to be a bird likely soon to become extinct unless preserved by human care, and of which the domestication would be easy and desirable.

**NOVELDA**, a town of Spain, in the province of Alicante, and 18 miles west from Alicante, on the railway between Madrid and Alicante. There are

corn and oil mills, brandy distilleries, and manufactures of lace. Pop. 8095.

**NOVELLO, OLARA**, a distinguished vocalist, daughter of the following, was born in 1818. Her talent shewed itself very early. At the age of ten, she became a pupil of the French Academy of Singing for Church-music, and studied in Paris for several years, following up her studies in after-years in Italy and Germany. Both in England and in Italy, she created quite a *furor* from the year 1840 to 1848: her singing has indeed hardly ever been equalled in equality, flexibility, and executive skill. In 1848, she married Count Gigliucci, and quitted the stage, returning to it, however, for a time from 1850 to 1860.

**NOVELLO, VINCENT**, an eminent musical performer and composer, was born in London, of an Italian father and English mother, in 1781. At the age of 16, he was organist in the chapel of the Portuguese embassy; and even then had attained a large measure of that proficiency on the organ for which he was celebrated in later life. He was one of the founders of the Philharmonic Society. His musical compositions, which are very numerous, and chiefly sacred, are considered to have contributed much to the improvement of cathedral music. As a painstaking editor of unpublished works of eminent musicians, he has also done great service to musical literature. He died at Nice in 1861.

**NOVGOROD-SSEJEWERSK**, or **NOVGOROD-SEVERSKOIE**, a town of Russia, in the province of Tchernigov, 89 miles north-east from Tchernigov, on the right bank of the Desna, a branch of the Dnieper. It is the capital of a district, and is a place of considerable trade and activity. Pop. (1867) 6301.

**NOVGRAD-VOLYNSKI**, a town of European Russia, in the government of Volhynia, 52 miles west-north-west from Jitomir. It is the capital of a circle, and is situated on the banks of the Slutch, a feeder of the Pripet, and so of the Dnieper. Pop. (1867) 8063.

**NOWANAGAR**, or **NOWANUGGUR**, a seaport of India, in the peninsula of Kattywar, Guzerat, at the mouth of the Nagna, a small river on the south shore of the Gulf of Cutch, 160 miles west-south-west from Ahmedabad, and in N. lat. 22° 28', E. long. 70° 11'. It is the principal place of the district of Hallar, the greater part of which is held as a *jaghire* by the chief of N., who bears the title of the Jam of Nowanagar. His territory comprises 540 villages, and a pop. of about 290,000. The town of N. is large and populous, nearly four miles in circuit. It is a place of very active trade, famous for the fine quality of the cloth which it

produces, and for the brilliant colours of which its fabrics are dyed. In the adjacent sea are beds of pearl-oysters. Copper ore has been discovered in a range of hills behind the town.

**NU'CHA**, or **NUKHA**, a town of Russia; after Tiflis and Shemacha, the most important town of Transcaucasia, and the only town of the former khanat of N. or Sheki, in the north-west of Shirwan. It is 120 m. E.S.E. from Tiflis, and stands at the southern base of Caucasus in the valley of the Kish-Tshai, an affluent of the Alasan, which itself is a branch of the Kur. Pop. (1867) 23,371. The town is surrounded by mulberry groves and fruit-gardens, extending to a distance of several miles. It has long been famous for the rearing of silk-worms, silk-spinning, and the manufacture of silken goods.

**NUGGINA**, a town of British India, in the district of Bijaur, division of Rohilcund, North-west Provinces. It is 48 miles north-north-west from Moradabad, on the route from Moradabad to Hurdwar. N. is the Birmingham of Upper India, and is famous in modern times for the manufacture not only of gun-barrels but of percussionLOCKS. Pop. (1872) 19,075.

**NULLIFICATION**, in American politics, the doctrine of the extreme states' rights party, of the right of a state to declare a law of Congress unconstitutional and void, and if the Federal government attempted to enforce it, to withdraw from the Union. In 1832, during the presidency of General Jackson (q. v.), the free trade and states' rights party in South Carolina (q. v.), under the leadership of John C. Calhoun (q. v.), her senator in Congress, asserted the doctrine of Nullification in a state convention which declared the tariff acts of that year unconstitutional, and therefore null and void; that the duties should not be paid; and that any attempt on the part of the general government to enforce their payment, would cause the withdrawal of South Carolina from the Union, and the establishment of an independent government. President Jackson met this declaration with a vigorous proclamation, in which he declared that the laws must be executed, and that 'the Union must and shall be preserved.' South Carolina, standing alone, receded from her position under protest, and a 'Compromise Bill,' introduced by Henry Clay (q. v.) in 1833, providing for a gradual reduction of duties, for the time settled the controversy.

**NYIREGYHAZA**, a town of Hungary, in the county of Szabolcs, on the railway between Debreczin and Tokay. The trade in agricultural produce is considerable. N. has salt, soda, and saltpetre works. There are mineral springs in the neighbourhood. Pop. (1869) 21,896.

## O



**OENKIRCHEN**, a town of Rhenish Prussia, 15 miles west-south-west from Düsseldorf, near the right bank of the Niers. It has manufactures of velvets, paper, leather, &c., and like many of the other manufacturing towns in the same district, has recently much increased in size and population. Pop. (1871) 7631.

**OEDENBURG** (Hung. *Sovrony*; anc. *Sempronium*), a town of Hungary, capital of a county of the same name, situated in an extensive

plain, about two miles west from the Neusiedler See, on the Ilkva, a branch of the Raab. It is connected by railway with Vienna. O. is one of the most beautiful towns in Hungary. It has manufactures of cotton and woollen goods, potash, nitre, tobacco, sugar, earthenware, glass, cutlery, &c.; and a considerable trade in wine, corn, tobacco, wax, honey, and cattle, the products of the neighbourhood, which is rich and well cultivated. The wine of Rust, a small town eight miles north of O., on hills sloping to the Neusiedler See, is one of the best wines of Hungary, and inferior only to

Tokay. The Roman station of *Sampronium* was one of considerable importance; and numerous Roman remains are found near Oedenburg. The inhabitants of O. are mostly of German race. Pop. (1869) 21,108.

OESEL, an island of Russia, in the Baltic, belonging to the government of Livonia, and lying across the mouth of the Gulf of Riga. It is about 80 miles in length from north-east to south-west, and about 40 miles in greatest breadth, but the south-western end consists of a comparatively narrow peninsula. A narrow strait separates the north-eastern end from the island of Dago. The surface is undulating, broken by low hills, marshy, watered by numerous small streams, and well wooded. The coast is generally formed by high cliffs. The climate is milder than that of the neighbouring continental districts. The rocks are generally calcareous, and the soil is in many places gravelly; the chief crops are wheat, oats, rye, barley, and peas. The rearing of cattle, horses, and sheep, and fishing, are, however, the principal occupations of the inhabitants. The seal-fisheries are of some importance. Pop. 46,000, mostly Lutheran. The only town is Arensburg, on the south-east coast, with a pop. (1867) of 3256. Many of the inhabitants of Arensburg are of German descent, as are the nobles and clergy of the island; but the peasantry are Esthonian. The islanders of O. were in early times noted as pirates. The Danish king Waldemar conquered the island in the beginning of the 13th century. Albert von Buxhövdén, Bishop of Leal in Livonia, obtained it from Denmark in 1227, in order that he might reduce its inhabitants to subjection, and convert them to Christianity. Being partly subdued by the Teutonic Knights, it remained for more than 300 years under its bishops, the seat of the bishopric being transferred to the island. The last bishop sold it to Denmark in 1559. It remained a Danish province till 1645, when it was given up to Sweden, and in 1721, fell into the hands of Russia.

OFFA'S DYKE, a remarkable relic of antiquity, an entrenchment extending along the whole border of England and Wales, from the north coast of Flintshire, on the estuary of the Dee, through the counties of Denbigh, Montgomery, Salop, Radnor, and Hereford, into Gloucestershire, where its southern termination is near the mouth of the Wye, in the grounds of Sedbury Park, which overlook the estuary of the Severn. In some places, it is nearly obliterated by cultivation; in others, it is of considerable height, although its appearance nowhere indicates that it can ever have been of much value as a rampart. It is therefore generally supposed to have been chiefly intended as a line of demarcation. Nearly parallel with it, but at a distance varying from a few hundred yards to three miles, on the eastern or English side of it, is *Watt's Dyke*, a similar relic of antiquity, which, however, seems never to have been so great a work, and is now in many places much obliterated. It has been conjectured that the space between them was neutral ground where the Anglo-Saxons and Welsh met for trading or other purposes. The principal dyke is ascribed by tradition to Offa, king of Mercia, who reigned in the 8th c.; but this is matter of tradition, and not of history.

OFFENBACH, JACQUES, a composer of dramatic music, who enjoys high popularity over the continent, of German birth, but a naturalised Frenchman. He was born in 1819, became *chef d'orchestre* in the Théâtre Français in Paris in 1847, and afterwards manager of the Théâtre des Bouffes-Parisiens. He has composed a vast number of light lively operettas, *Le Mariage aux Lanternes*, *La*

*Fille d'Elezondo*, &c., perfect as musical trifles; but the productions by which he is best known are a series of *bonjourneries musicales*, or burlesque operas, including *Orphée aux Enfers*, *La Belle Héloïse*, *La Barbe Bleue*, *La Grande Duchesse*, *Geneviève de Brabant*, and *Roi Carotte*, composed with the rather questionable aim of parodying music of a more serious description. The high public favour accorded to his works has of late years extended to England.

O'GOBAI, a large river of Western Africa, which falls into the sea by many mouths, between S. lat.  $0^{\circ} 40'$  and  $1^{\circ} 20'$ . Its delta is very large, and forms a most complicated network of rivers, flowing amidst a dense forest. The most northern mouth of the O. has long been known as the river Nazareth, and falls into a bay of the Atlantic, on the north of Cape Lopez. Another principal mouth, to the south of that far-projecting cape, is known as the Mexican; and the southernmost, which seems to be the largest of all, is the river Fernand Vas. These were regarded as distinct and large rivers, till the explorations of Du Chaillu revealed their relation to each other, and to the main river Ogbai. The extent of the basin of the O., its sources, and the length of its course, are yet unknown, but it may be deemed certain that it is by far the largest river of Western Africa between the Niger and the Congo. For almost all our knowledge of the O., and the country through which it flows, we are indebted to Du Chaillu, although, in the interval between his first and second visits, the lower part of its course was partially explored by two French expeditions. Not far from its mouth, the Fernand Vas is joined by the Rembo, also a large river, although much inferior in size to the O., which, after flowing in a south-westerly course from the interior, bends northward, and pursues a course nearly parallel to the coast for about fifty miles, the narrow peninsula between the river and the sea being a sandy and grassy prairie, with scattered groups of fine trees, frequented by herds of the Niare (q. v. in SUPP., Vol. X.) or wild ox of Western Africa, and of antelopes. The dense forests of the O. are the main haunts of the Gorilla (q. v.), and of several other anthropoid apes, discovered by Du Chaillu, among which are the Nest-building Apes (q. v. in SUPP., Vol. X.). Prodigious flocks of marabouts also come to lay their eggs on these prairies, and in the wet season, numerous pools are formed, which teem with fish. The forest-regions produce few of the mammalia, herbivorous and carnivorous, so abundant in other parts of Africa; and even birds are few. About 150 miles from the mouth of the O., the main stream is formed by the junction of two rivers, the Okanda and the Ngonyai—the former, which is said to be the larger of the two, coming from the north-east; the latter, which alone was explored by Du Chaillu, from the south-east. This river, after a long course through the table-lands of the interior, bursts through the mountain-range which separates them from the level country of the coast; the possibility of navigation being here cut off by a magnificent fall, and still more magnificent rapid, in which the river rushes down a steep declivity through a rocky chasm. Both above and below the fall, however, it is quite suitable for navigation by steamers; but a great impediment to commerce, when commerce shall spring up in that region, will be found in the difficult bar at the mouth of the Fernand Vas. The rainfall on the upper parts of the O. is supposed to be very great. The observations of Speke and Burton on the eastern side of tropical Africa, and of Du Chaillu on the western, concur in shewing that this must be the case. Raimy and dry seasons alternate on both coasts, but as the traveller proceeds inland, rain becomes more

frequent, falling almost every day, and it would seem at all seasons alike.

OHLAU, OLAU, or OLAWA, a town of Prussian Silesia, 17 miles south-east from Breslau, on the right bank of the Ohlau, a branch of the Oder. O. is a station on the railway which connects Breslau and the north with Vienna. It is an ancient town, with a royal palace and an old castle. At the present day, it is a place of considerable industrial activity. Being the capital of a circle, it has numerous district courts and offices. Pop. (1871) 7484.

OIDIUM, an important genus of minute fungi of the section *Hyphomycetes*, growing on diseased animal and vegetable substances. They consist of minute tubular threads, forming flocks, white in some species, brightly coloured in others, simple or irregularly branched, assuming in their upper part the form of strings of beads, which finally break up into elliptic spores. The species actually existing are probably much more numerous than those which have been fully ascertained. Among the most important of the vegetable parasites of man is *O. albicans*, which is found on the epithelium in the



Fig. 1.—Thrush Fungus (*Oidium albicans*): general view.

mouth and throat in the disease called *aphtha*, or thrush, and on that of the throat in diphtheria, also sometimes in the nostrils, stomach, and intestines,

on the nails, the nipples, and other places. It is more common in children and in aged persons, than in those who are in the prime of life. It occurs frequently in the last stages of many diseases, when the mucous membrane is covered with nitrogenous decomposable matter. Indeed, it would seem that whatever may be the case as to other vegetable parasites, no species of *O.* begins its attack upon a perfectly healthy surface, either animal or vegetable; a diseased state of the tissue being to these fungi a necessary condition of vegetation, 'just as the yeast-plant will not vegetate save in a fermentable fluid, that is, in a

solution which, in addition to sugar, contains some decomposable albuminous matter.' *O. albicans* appears to the naked eye as a white pasty

substance, slightly elevated above the mucous membrane to which it adheres; but under the microscope, its filamentous structure is easily perceived. Its seat is at first on the upper surface of the epithelial cells, but its filaments soon penetrate deeply between them, and the upper epithelial layers are soon worn out, and thrown off by the rapid growth from below.

However incapable the *O. albicans* may be of attacking a healthy surface, there can be no doubt that it greatly contributes to the extension of disease, and that it is very readily communicated from one patient to another when there is catarrh or other inflammatory affection of the mucous membrane.

Another species of *O.* which has attracted great attention is *O. Tuckeri*, regarded by many as producing the grape disease, which, several years ago, injured the vineyards of many parts of the world, but in accordance with the views already expressed, perhaps rather to be regarded as merely accompanying and extending the disease. It may probably be the case that over-cultivation of particular varieties of grape, and too long continued cultivation on the same ground, have so impaired the vigour and healthfulness of the plants, as to make them liable to the attacks of this parasite. *O. Tuckeri* makes its appearance at first in the form of a *mycelium* of webby, creeping, branching filaments (fig. 4, b), which send out upright or decumbent jointed stems (fig. 4, a). The bead-like joints of the stems become successively filled with spores, which are finally discharged in little clouds for the multiplication of the species. The grape disease was first observed in Kent, England, in the spring of 1845, on vines in the vinery of Mr Tucker. The ends of the young shoots assumed a crispy appearance, began to wither, and then dried up. The unripe grapes were next attacked, becoming covered with a grayish-white bloom, the skin of the grapes being destroyed, and they rotted and dried up. The disease rapidly spread over other English vineries;



Fig. 3.—Ends of perfectly developed thallus threads, more highly magnified (460 diameters).

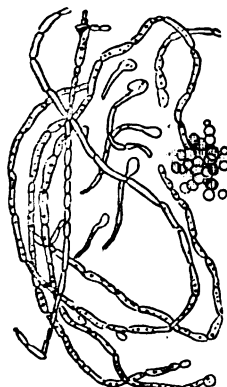

Fig. 2.—Perfectly developed thallus threads, shewing constrictions, partition-walls, and ramifications.

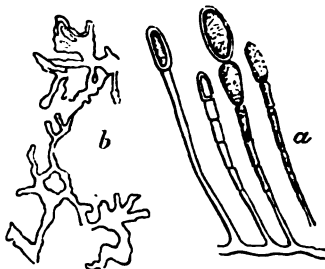

Fig. 4.—Grape Fungus (*Oidium Tuckeri*): early stage.

was observed about the same time in the vineries of Paris, and soon in the vineyards of almost all parts of France, Italy, Greece, Tyrol, and Hungary; finally, and in a slighter degree, affecting the vineyards of the Rhine. Its ravages extended to Algeria, Syria, Asia-Minor, and many other countries, among which is particularly to be noticed the island of Madeira, where it proved almost completely destructive to the grapes, and nearly put an end to the production of the celebrated Madeira wine. The importation of Madeira wine to Britain in 1831 amounted to 209,127 gallons; and in 1861, only to 28,749 gallons. It is probable that the complete

isolation of the Madeira vineyards made the progress of the disease more rapid, and its results more complete than elsewhere, by causing a prevalence of the conditions favourable for it. No kind of vine escaped. The grape disease is first perceived in the leaves, which become whitish, in consequence of a mycelium spreading over the upper surface of the leaf. The leaves sometimes curl up, or they become black at the centre, the blackness extending towards the circumference, and finally they drop off. The plant, through loss of its leaves, now becomes more unhealthy; the shoots are attacked by the disease, the stalks of the bunches of grapes, and the grapes themselves. The parasite penetrates into the young wood, the shoots are covered with spots and blotches of a reddish brown, or even black colour, and look as if a red-hot iron had been applied to them. Sometimes they secrete a clammy inodorous fluid all over their surface; and in many cases they wither from the top down half their length. The affected grapes very often first exhibit the disease in a single whitish spot on a single grape of a bunch, which enlarges by radiating irregularly. Fig. 5 represents a fragment of a grape with mycelium and erect fertile filaments. If in a bunch

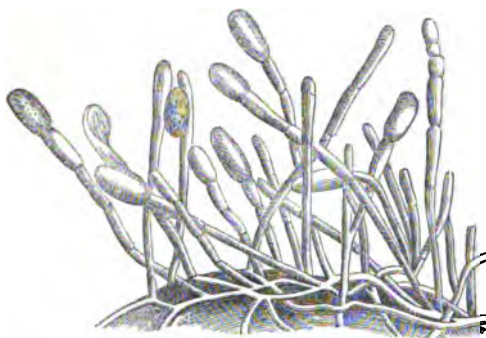

Fig. 5.—Fragment of surface of Grape, with oidium fully developed.

there is one abortive grape, it often shews signs of the disease, whilst the rest remain free. The creeping branches of the mycelium are fixed upon the skin of the grape by rootlets, which do not penetrate into the juicy pulp. The mycelium sends up vertical fertile branches of nearly equal height, densely aggregated, and forming a velvet-like mass. The extremities of these become beaded; and at last the uppermost cell or bead increases in volume, becomes detached, and is carried off by some slight breath of air, to multiply the species by the dispersion of its spores. The other bead-like cells follow in succession.

Various means were resorted to for the prevention and cure of the grape disease. The application of pulverised sulphur was found useful, the fungus withering and drying up when brought into contact with a minute particle of sulphur. The application of sulphur must be frequent, as portions of the mycelium and some of the spores always escape. The use of sulphur was the chief means of checking the spread of *O.* in French and other European vineyards; it became general in the south of France and in Italy; and in consequence of its national importance, the duty on sulphur was reduced by the French government. Hydrosulphide of lime was also applied to vines with very beneficial effect. It is prepared by thoroughly mixing 68 ounces of flowers of sulphur with the same quantity of slaked lime, adding

three or four quarts of water, boiling for about ten minutes, allowing it to settle, and decanting the clear liquor. When it is to be used, one quart is mixed with 100 quarts of water, and it is poured over the vines.

**OIL-FUEL.** A great incentive has been given by the discovery of copious wells of petroleum (see OIL-WELLS AND OIL-TRADE) to the invention of some mode of using oil as a fuel for furnaces and stoves. Such attempts had often been made before; but they assume a new aspect now that oil has become so much cheapened. Nearly half the carrying capacity of European steam-ships, and more than half in those which make long voyages, is taken up with the stowage of coal. Petroleum (*q. v.*), if wholly burned, and all the heat utilised, gives out much more heat than an equal weight of anthracite or steam coal.

Mr Richardson made some experiments for the government at Woolwich in 1866. His grate consisted of two iron boxes, one within the other; the inner contained oil, and the space between the two boxes contained water. When the water boiled by the application of heat, and the oil began to arise in vapour, a jet of steam was admitted to mix with the vapour. The steam was found to assist the perfect combustion, so as to avoid the production of smoke. One object was, to ascertain whether the refuse of the stills, resulting from the distillation of shale oil, could be made available as furnace-fuel. The government published a Report of the Experiments, with diagrams, in 1866. It was considered that petroleum, used instead of coal as fuel, (1) raises steam more rapidly; (2) requires a smaller furnace and boiler; (3) maintains a more continuous fire and heat; (4) affords means of varying the intensity of the fire more quickly; (5) is extinguished instantly by turning off the oil and keeping on the steam; (6) produces no smoke, ash, or dust; (7) dispenses with some of the staff of coalers and stokers; (8) economises space for coal-bunkers; (9) reduces the dead-weight carried by the ship; (10) occasions no loss of heat by opening furnace-doors; (11) keeps the engine-room clean and comparatively cool; and (12) admits of the furnace-fires being lighted much more quickly. A modified form of oil-furnace was tried at Woolwich by Mr Richardson in 1867, not only with refined petroleum, but with the same oil in its crude form, shale-oil, naphthaline, creosote, grease, and residuum tar.

Experiments have been conducted with the same object in America. Mr Isherwood, chief of the bureau of steam-engineering in the United States navy, conducted a series of experiments, in 1867, on Colonel Foote's furnace for burning petroleum, and fitted up the iron gunboat *Palos* for this purpose, under the direction of a board of engineering officers. Most of the advantages claimed for Richardson's apparatus seem to be equally applicable to this of Foote.

There is a petroleum furnace by Messrs Wise and Field, patented in 1867, in which the oil is injected into the furnace by the pressure of superheated steam. There are many other forms of oil-furnace by Hill, Stevens, Sim, Barff, the American Petroleum Light Company, &c.

Many of the advantages of oil-fuel already mentioned are pretty generally conceded; but the questions of *safety* and *cheapness* are not yet settled.

**OIL-WELLS AND OIL-TRADE.** One of the most remarkable trades, suddenly sprung up into importance in modern times, is that in oil obtained from subterranean sources. See NAPHTHA.

It is now known that oil-bearing mineral beds exist in various parts of America, as well as in the

older continent; but the richest deposit hitherto discovered is in the United States, in Venango county, at a spot in Pennsylvania not far from the point of junction of that state and New York state with Lake Erie. Oil had for many years been seen floating on the surface of the water of a well near Titusville; it was taken up by absorption by means of flannel, and applied to medicinal purposes. Dr Brewer, in 1853, suggested that it might possibly be used for lubricating and for illumination; and in the following year was formed the Pennsylvania Rock-oil Company. This Company languished until 1858, when Colonel Drake, manager of the Company, and Mr Bowditch, resolved to sink a well purposely for oil. They were amply rewarded, for oil was pumped up at a rate varying from 400 to 1000 gallons daily. The news being spread abroad, adventurers quickly came to the district, which obtained the names of Oil Creek and Petrolia; and they experienced every degree of fortune from utter failure to splendid success, according to the spot at which they happened to sink their wells. So rapidly did the works proceed, that by 1860, it was known that oil existed beneath 100 square miles of country, at a depth varying from 70 to 500 feet. In 1861, the first large *flowing* well was struck—that is, a well up which the oil rose so profusely as to flow over the surface, yielding 1000 barrels (of 40 gallons each) per day; and another that yielded 2500 barrels. This new good fortune increased the excitement and the well-digging.

The uncertainty in this trade is something extraordinary. On one occasion, a well was bored with the usual centrebit to a considerable depth without any oil being found. On withdrawing the bit, and putting in the rimer or rimmer to widen the hole, a vein was struck at the side. The bit had just missed the vein, and the well would have been a failure had not the orifice been enlarged. This incident gives meaning to a phrase much used in America—that of 'striking oil.' On another occasion, a well was bored which promised to be very productive, a large amount of oil flowing; the owner of the well not being ready to collect it, a plug was driven into the pipe; but upon the removal of this plug, when tanks had been built, the oil had altogether disappeared. The deepest well sunk in the district, more than 1000 feet, yielded no oil whatever; and altogether only 15 per cent. of the borings were successful. Very often, there was twice as much water as oil in the liquid pumped up; and in some instances, the mixed oil and water was suddenly succeeded by water alone, thereby putting a stop to any further profitable operations.

When the oil began to be sent in large quantity to New York and other towns, the cheapness of price led to its application as lamp-oil, as fuel to be converted into gas, and in many other ways: this led to a constantly increasing demand; the demand brought the price up again to a reasonable figure at Petrolia; and the price induced the sinking of new wells. Considering that the produce of the district reached 20,000,000 gallons in 1861, it can be easily understood that commercial arrangements multiplied rapidly. Small villages rose into large towns, with banks, hotels, and wealthy people, all, however, begrimed with oil. Titusville, which had 243 inhabitants in 1855, rose to nearly 10,000 in 1866. Another place, called Oil City, had its two newspapers devoted mainly to oil-news, and transacted business to the amount of £3,000,000 per annum. By the end of 1866, it was estimated that there had been 90,000,000 dollars invested altogether in this and other parts of the United States; and that the average price at the well's mouth had

settled down at about 10 dollars per barrel, or a shilling a gallon.

In July 1860, oil was discovered in the state of Ohio, and within six months, 50 wells were sunk there. At Sandy Valley in Kentucky, Perry County in Indiana, Gardiner in Illinois, Yates County in New York, and Chattanooga in Tennessee, the oil-wells have attracted some attention. The Canadian deposit is a remarkable one. Near a village, now a large town, called Oil Springs, in Inniskillen County, at the southern end of Lake Huron, a busy community has sprung up. In 1857, while sinking a well at this spot, in a forest where much semi-solid tar-like matter had often been found, the men were surprised by a sudden upburst of oil. This discovery set enterprising adventurers to work; and by the year 1863 there had been more than 200 wells sunk, within an area of only two miles by one. At first, the oil flowed from most of these wells; but the level gradually sank, and the oil could only be obtained by pumping. At the end of the six years, one half of the wells had ceased altogether to flow; and the wells since dug have been still more uncertain in their yield. The oil appears to lie in fissures in the limestone; but the well-borers have not yet succeeded in finding symptoms whether a particular spot will yield profitably or not at all. One particular well gave 35,000 barrels in ten months, and by that time had exhausted itself. The recognised rental became, 700 dollars down per acre, and one-third of the oil. The oil requires refining, to remove the tar, the volatile constituents, and the offensive odour. The Canada oil appears to be more disagreeable than that of the United States, and to be less in favour in consequence. The average produce per well in Pennsylvania and Canada cannot be stated, on account of the extreme fluctuations. In 1861, there was an estimate that 100 wells in Petrolia yielded 15 barrels per day each. The total American—that is, Canada and the U. States—product in 1868 was 3,695,000; in 1869, 4,717,000; and in 1870, 5,535,000 bbls.; and in 12 years, from 1869 to 1870, 34,388,100 bbls. of crude petroleum. The price at New York has ranged between the very wide limits of 9 to 56 cents per gallon for crude oil, and 19 to 120 cents for refined. The oil was first imported into Great Britain in 1861, since which year the import has steadily and greatly increased, amounting in 1875 to 77,661 tons, value £781,232.

In 1865, a shale was discovered in New South Wales, similar to the Boghead coal or Torbanehill mineral of Scotland, but richer in oil, and more free from sulphur. When distilled at Sydney, from 100 to 160 gallons of oil were obtained from one ton of shale. The seam in Hartley district is 54 feet thick. Efficient distilling apparatus has been sent out from England; and the shale is either distilled for oil or for gas, according to circumstances. See NAPHTHA and SHALE.

**OLHAO**, a town of Portugal, on the sea-coast, near Cape de St Maria, and five miles east from Faro. Pop. 7025.

**OLINDA**, a city of Brazil, in the province of Pernambuco, and four miles north-east from Pernambuco. It was formerly the capital of the province, and there were bloody contests between Spain and Holland for the possession of it. It is still a bishop's seat, Pernambuco being included in the diocese. The whole aspect of the town is that of a place half deserted. Pop. 8000.

**OLIVENZA**, a town of Spain, near the Portuguese frontier, 19 miles south-west from Badajoz, on a small river which flows into the Guadiana. The chief branches of industry are the expressing



of oil, weaving, and the making of earthenware. From the treaty for the cession of O. by Portugal to Spain in 1801, Godoy acquired his title of Prince of the Peace. Pop. 10,000.

**O'LOT**, a town of Spain, in the province of Gerona, and 22 miles north-west from Gerona, near the base of the Pyrenees, on the Fluvia. There are 14 volcanic cones close to the town; the crater of the largest is a mile in circumference and 445 feet in depth. The whole district is volcanic. In many places, and even in the town itself, currents of air blow continually from the porous lava. These are called *Bufadores* and *Sopladores*, and some of them are conducted beneath houses, and used as refrigeratories in hot weather. They maintain the temperature of about 53° F. both in hot and cold weather, but the gust of air is strongest in hot weather. O. was almost destroyed by an earthquake in 1421, but was soon rebuilt. Pop. 12,070.

**ONE'GLIA**, a town of North Italy, in the province of Porto Maurizio, on the Gulf of Genoa, 40 miles east-north-east from Nice, at the mouth of the Impero, a small river which rushes down from the Apennines. The harbour is not good. The principal article of export is oil. Andrea Doria, the great Genoese admiral, was born here. Pop. about 8000.

**ONTENIENTÉ**, a town of Spain, in the province of Valencia, 45 miles south-by-west from Valencia, on the right bank of the Clariano, and near the railway which connects Valencia with Madrid. Linen and woollen fabrics are manufactured here; there are also numerous oil-mills. Pop. 9508.

**OOMRAWUTTI**, or **AMRAWATI**, an important commercial town of British India, in the province of Berar, 86 miles west-by-south from Nagpore, on one of the head-waters of the Purna, a branch of the Tapti. The district which contains it was ceded by the Nizam to the British government; and transit-duties, which formerly much interfered with the commerce of the town, have been abolished. Several considerable business firms are established here; and the chief merchants of Upper India and of Bombay have agents, who often make advances to the cotton cultivators of the surrounding country, on security of their crop. There are large cotton warehouses at Oomrawutti. Pop. 23,410.

**OOTRUM**, an Indian fibre, derived from the stem of *Dœmia extensa*, a plant of the natural order *Acepiadiaceæ*, abundant in many parts of Hindustan. The fibre is soft, white, silky, and strong, and is regarded as a promising substitute for flax.

**O'PENHEIM**, a town of the grand duchy of Hesse-Darmstadt, in the province of Rhenish Hesse, on the left bank of the Rhine, 10 miles south-by-east from Mayence, and on the railway between Mayence and Spire. It stands on the steep slope of a hill abounding in vineyards, and carries on a pretty active trade in wine. O. occupies the site of the Roman castle of *Bauconia*, and was made a royal palatinate under the Carolingians. It afterwards became one of the most important free towns of the empire. It was taken in 1218 by Archbishop Adalbert of Mayence, in 1620 by the Spaniards, in 1631 by the Swedes under Gustavus Adolphus, and in 1634 by the imperialists, suffering much upon all these occasions. In 1689, the French under Melac almost entirely destroyed it. The church of St Catharine, a fine specimen of the German architecture of 1262—1317, a kind of mixture of the Cologne cathedral, lies yet in a ruinous condition, except the eastern part, which was restored in 1838—1843. Pop. (1871) 3085.

**ORE'NSE** (anc. *Aqua calida Ciliensium*, or *Aqua Originis*), a city of Spain, the capital of the province of Orense, in Galicia, near the frontier of Portugal, on the left bank of the Minho. O. contains a number of interesting ecclesiastical edifices. It is highly reputed for its hot sulphurous springs, called *Las Burgos*, which issue—three in number—almost boiling from a granite rock in the western part of the town. The baths of O. were known to the Romans, and were in much repute among the Goths. O. carries on manufactures of linen, leather, and chocolate. It has a large trade in hams, which are in great repute throughout Spain. Pop. 10,775.

**OROSZÁZA** (pronounced *Oroszáca*), a thriving town of Hungary, in the county of Békés Csanad, 31 miles north-east from Szegedin. Pop. (1869) 14,554.

**ORU'RO**, or, in the complete form of the name, *San Felipe de Asturia de Oruro*, a town of Bolivia, the capital of the dep. of Oruro. It is situated about nine miles east from Desaguadero, and 32 miles north from the northern extremity of the salt lake of Desaguadero, on an affluent of the river of the same name which falls into that lake. It is 12,015 feet above the level of the sea, at the base of a very high mountain; but on the other side of the town is a large plain, often covered with saline efflorescences. The soil of the whole department is saline, and far from being fertile, but its mineral wealth is great. Gold, silver, copper, tin, iron, lead, and antimony are among its products. O. was founded in 1590, in consequence of the discovery of silver mines, which proved more productive than any in Bolivia, except those of Potosi. It soon became a wealthy and flourishing city with 70,000 inhabitants; but in consequence of the diminished productiveness of its mines, and of the anarchy prevailing in the country after the Revolution, its population declined, and is now only 7960. It has recently been made the seat of the Bolivian government, and the place of meeting of congress.

**O'SCHERSLEBEN**, or **GROSS-OSCHERSLEBEN**, a town of Prussian Saxony, on the left bank of the Bode, a branch of the Saale, 22 miles west-south-west from Magdeburg. Pop. (1871) 8023.

**OSTRICH-FARMING**. Attempts are being made to increase the supply of ostrich feathers, or to facilitate the procuring of them, by establishing farms—enclosures where the birds can grow and breed in tameness. In 1859, the Bulletin of the Société d'Acclimatation contained a note from Dr Vavasour, discussing the question whether the ostrich of South America, the *Nandu* (q. v.) or *Rhea*, can be acclimatised in France. When caught, they are easily tamed; and this is the circumstance which has suggested the idea of naturalisation. They must not be placed in cages, but must have free range to walk about, secured simply by a leg-guard. Dr Vavasour expressed an opinion 'that the South American ostrich could live without difficulty in the north of France; that there is no difficulty in domesticating it; and that it will feed on almost anything that is given to it, however coarse.

At a meeting of the Cape Agricultural Society of Cape Town, in 1864, Mr L. von Maltitz gave an account of his experience in ostrich-farming at Colesberg. Towards the end of 1863, he purchased seventeen young ostriches of three or four months old, and placed them in an enclosure of 300 acres, over which they had free run. They subsisted wholly on the herbage of the enclosure, save a little grain given to them now and then. The

opinion he formed from many months' observation was, that 35 ostriches might find sufficient sustenance upon 300 acres of good grazing-ground. In April 1864, he had the wings of the birds cut at the point where the well-known ostrich feathers grow; and they were fit again to cut six months later. The birds were so tame that they allowed themselves to be handled, and their plumage minutely examined. Having caused the birds and the feathers to be examined by experienced dealers, he found that the largest feathers, of which there are twenty-four on the wing of each male bird, were worth £25 per lb.; and that one plucking of his seventeen birds would yield £10 each on an average. The birds cost him about £5 each. Since this experiment of Mr Von Maltitz, O.-F. has become a recognised form of industry at the Cape. The price of a healthy bird a week old is £10; at six months, £30. The feathers may be plucked when the bird is a year old, and each crop is worth about £7 a bird. The price of the feathers ranges, according to quality, from a few shillings per lb. to £40 or £50. In 1875 there were 32,247 domesticated ostriches in Cape Colony. It is found that 600 acres of grass are required to feed 80 birds; and when the grass is poor, the ostriches are fed on supplies of shrubs and occasionally on Indian corn. The adult birds require to be kept in separate paddocks, which are generally surrounded by wire-fencing. The egg of the ostrich, though coarse, is reasonably good food; but the naturalisation of the bird derives most of its prospective importance from the feathers, for which there is at all times a large demand in the chief European countries.

OSTUNI, a city of South Italy, in the province of Lecce, 22 miles west-north-west from Brindisi, on the railway between Ancona and Brindisi. It stands on a steep hill. A considerable trade is carried on, chiefly in the produce of the neighbourhood, and the city is a flourishing one. Pop. (1871) 14,422.

OTO'LITHUS, a genus of fishes of the family *Sciænidæ* (q. v.), having a perch-like form, a convex head, with cellular bones, feeble anal spines, no barbels, long curved teeth or *canines* among the other teeth. A valuable species of this genus is the WEAK-FISH, or SQUETRAQUE (*O. regalis*), which is common on the eastern coasts of North America, from the Gulf of Mexico to the Gulf of St Lawrence, and attains a length of two feet. It appears on the coasts only in the warmer part of the year. It swims in shoals near the surface, takes bait greedily, and may be readily taken by any soft bait. It enters the mouths of rivers where the water is brackish. The flesh is pleasant, but soon gets soft. Excellent isinglass is made of the air-bladder.—A number of species of *O.* are found in the East Indian seas, some of which are valuable for the isinglass which is made from their air-bladder, and some are much used as food, both fresh and dried.

OTTO (or ATTAR) OF ROSES is the volatile oil or otto (see PERFUMERY) of the petals of some species of rose, obtained by distillation, and highly prized as a perfume. It is a nearly colourless or light yellow crystalline solid, at temperatures below 80° F., liquefying a little above that temperature. It is imported from the East, where in Syria, Persia, India, and Turkey, roses are cultivated to a considerable extent for its sake. It is probable that the oriental otto is the produce of more than one species of rose; and it is uncertain what species is cultivated in some of the localities most celebrated for it; but *Rosa Damascena* is known to be so employed in the north of India, and a kind of otto is sometimes obtained by the makers of rose-water

from *Rosa centifolia* in England. See ROSE. Ghazipore, near Benares, is celebrated for its rose-gardens, which surround the town, and are in reality fields occupied by rows of low rose-bushes, which in the flowering season are red with blossoms in the morning, but the blossoms are all gathered before midday. Cashmere is noted for its extensive manufacture of otto, as are also the neighbourhoods of Shiraz and Damascus. To procure the otto, the rose-petals are usually distilled with about twice their weight of water, and the produce exposed to the cool night-air in open vessels, from which the thin film of otto is skimmed with a feather in the morning. Twenty thousand flowers are required to yield otto equal to the weight of one rupee, which even in India is worth about 100 rupees, or £10 sterling. Otto is said to have been first procured by what may be called an accidental distillation of rose-petals exposed with water to the heat of the sun, and to have been found floating on the surface of the water; and it is still sometimes obtained in India by such a process. It is said to be also obtained by dry distillation of rose-petals at a low temperature. During the distillation of rose-petals, a small quantity of a solid volatile oil comes over (Solid Oil of Roses, see below), which crystallises and floats on the water in the receiver, and which is sometimes called *English Oil of Roses*. Otto of roses is not unfrequently adulterated with sandalwood oil, oil of rhodium, &c. It is much used for making hair-oil, a drop of it being enough to impart a pleasant odour to a considerable quantity. It is also used in making lavender-water and other perfumes. The odour of otto itself is too powerful to be altogether pleasant. Another method of obtaining the *scent* of roses is described in the article PERFUMERY. Otto of roses is a mixture of two volatile or essential oils; the one solid at ordinary temperatures, and the other liquid. The solid oil of roses (rose camphor, stéaroptène of oil of roses) exists separately in crystalline plates, melts or fuses at 203° F., and boils at about 592°. It possesses of itself very little odour, is insoluble in alcohol, but soluble in ether. It is composed of carbon and hydrogen. The liquid oil of roses (éléoptène of oil of roses) is a very fragrant liquid, to which the otto of roses is indebted for its delicious perfume, and appears to consist of carbon, hydrogen, and oxygen; though its composition and properties have not been attentively studied. The otto of roses may be regarded as a solution of one part of the solid oil in two parts of the liquid. To separate these oils, the otto is frozen at a temperature below 80° F., and the congealed mass pressed between folds of blotting-paper, which absorbs the liquid oil of roses, and leaves the solid. Another process which may be resorted to is to treat the frozen otto with alcohol, which dissolves the liquid oil, and leaves behind the solid. The otto of roses has a specific gravity of 832, water being 1000; it is combustible; and when its vapour is diffused through oxygen, and set fire to, a violent explosion takes place: 1000 parts of alcohol dissolve 7 parts of the otto in the cold, and 33 parts when slightly heated. The principal use to which otto of roses is put is as a perfume. Milk of roses and lavender-water owe their fragrance to the presence of the otto. A good receipt for oil for the hair is olive oil, coloured by alkanet, and scented by a few drops of otto, and this is very generally sold under the name of otto of roses. Medicines are occasionally perfumed by otto of roses, and it is sometimes added to unguents and spirit-washes.

OUGRÉE, a town of Belgium, in the province of Liège, three miles south-south-west from Liège, on the right bank of the Meuse. It has iron-works,

a cannon-foundry, and oil and flour mills. The neighbourhood produces coal. Pop. (1870) 6200.

**OVAR**, a town of Portugal, in the province of Beira, 17 miles north from Aveiro, at the mouth of the small river Ovar, and at the head of one of the branches of the curious lagoon or bay called Ria d'Aveiro. See **AVEIRO**. It is a prosperous and rapidly increasing town, and carries on an extensive fishery and a considerable trade. Pop. (1864) 10,374.

**OVEN-BIRD** (*Furnarius*), a genus of birds of the family *Certhiadae* (q. v.), natives of the southern parts of South America, interesting on account of the remarkable nests which they construct. They are small birds, with short wings and feeble power of flight. One species, *F. albogularis*, or *F. rufus*, is found near Buenos Ayres; another, *F. fuliginosus*, inhabits the Malouine Islands. It is a fearless little bird, regarding the presence of man so little that it may be easily struck down with a switch. Both sexes take part in the construction of the nest, which is generally in an exposed situation, remarkably large, and of the shape of a dome, with a small entrance on one side, so as to have much resemblance to a rude oven. It is made of clay, grass, &c., well plastered together, and becomes quite firm as the clay dries in the sun. Internally, it is divided into two chambers by a partition

reaching nearly to the roof, the eggs being placed in the inner chamber on a bed of soft grass and



Oven-bird (*Furnarius fuliginosus*).

feathers. The outer chamber seems to be intended for the male.

**OZIERI**, a town of the island of Sardinia, in the province of Sassari, 26 miles east-south-east from Sassari, amongst the mountains which occupy the centre of the island. It stands in a deep valley, open only to the north, and is therefore peculiarly exposed to cold winds. Pop. (1871) 7965.

P



**PADRON**, a very ancient town of Spain, in the province of Coruña, 15 miles south-west of Santiago, on the Sar, a few miles from the coast. P. being the place at which the body of Santiago is said to have landed itself, was formerly an important place of pilgrimage. Pop. 6090.

**PADULA**, a town of South Italy, in the province of Salerno, 52 miles south-east of the town of Salerno, in a mountainous district. Below P. are the ruins of the once famous and magnificent monastery, *La Certosa di S. Lorenzo*, despoiled by the French during their occupation of Calabria. Pop. (1871) 8556.

**PAGA'NI**, an uninteresting town of South Italy, province of Salerno. In the church of St Michele is the tomb of Alfonso de' Liguori, founder of the order of the Redemptionists, who died here, 1787. The body is preserved in a glass case. Pop. about 12,000.

**PAKS**, a market-town of Hungary, in the county of Tolna, 60 miles south-south-east of Pesth, on the Danube. The river is here very winding, and the eastern bank a desert and useless morass. The town is frequently subject to inundations. Pop. (1869) 9434.

**PALAY** (*Cryptostegia grandiflora*), a climbing plant of the natural order *Aeclepiadaceae* (q. v.), common in many parts of India, particularly on the eastern coast of Hindustan. It yields a very fine strong white fibre, resembling flax, and which can be spun into the finest yarn. The fibre is obtained

from the stalk; the milky juice contains caoutchouc. P. is one of the most interesting plants which have recently been recommended to notice in India.

**PALAZZOLO ACREI'DE**, a town of Sicily, in the province of Syracuse, 29 miles south-south-west of Catania, is situated on the brow of a hill, just where it overhangs a deep valley. Near P. are the remains of the ancient *Acra*, founded by a colony from Syracuse, on the site of a Phœnician settlement, 664 B.C. The most curious remains are to be found in some low cliffs beneath the town to the south, where is a series of arched niches, containing figures carved in high relief in the rock. The style of art appears to be archaic Greek, with somewhat of an Egyptian character. Pop. 9954.

**PALMA**, or **PALMA DI MONTECHIARO**, a town of Sicily, in the province of Girgenti, 14 miles south-east of the town of Girgenti, near the south-west coast. It is entirely a modern town, its foundation dating only from 1637. There is a trade in almost-dried fruits, soda, wine, and sulphur. Pop. (1871) 13,458.

**PALMÉ**, or **PALMI**, a royal city of South Italy, in the province of Reggio-Calabria, 20 miles north-east of Reggio, on the coast of the Bay of Gioja. The town, by means of its port, carries on an active trade. Pop. 9140.

**PARASITA**, or **ANOPLURA**, an order of insects, to all of which the name Louse is popularly given. All live as parasites on quadrupeds and birds. The characters of the order are noticed in the article **LOUSE**. It remains, however, to be added that the order is divided into two sections; in the

first of which, *Pediculidea*, the mouth is small and quite suctorial; whilst in the second, *Nirmidea*, it is furnished with mandibles and hooked maxilla. The species of the first section are found only on man and mammals; those of the second section, almost exclusively on birds, although one infests the dog. The *Nirmidea* shew much greater activity than the *Pediculidea*. When a bird dies, the bird-lice congregate near the beak, and seem disquieted, apparently anxious to change their abode.

PARATY', a seaport town of Brazil, in the province of Rio de Janeiro, on the west coast of the Bay of Angra, 90 miles south-west of Rio de Janeiro city. It has extensive commerce, and numerous distilleries. Pop. said to be 10,000.

PARKESINE, the name given to a substance introduced for manufacturing purposes by Mr Parkes of Birmingham. It is a combination of various vegetable ingredients, the number and proportions of which differ according to the qualities required to be given to the substance. Parkesine was first shewn in quantity at the International Exhibition of 1862. The basis is almost any vegetable fibre—such as cotton or flax waste, old rags, &c. The inflammable nature of these fibres is subdued by the addition of certain mineral neutral salts—sulphates, tungstates, &c. Naphtha is used as a solvent. Another component is oil, animal or vegetable, which may or may not be hardened by chloride of sulphur. The inventor has not made public the exact mode in which the various ingredients are combined; but it appears that the elasticity mainly depends on the oil, and the non-inflammability on the kind of neutral salt employed.

In a paper read before the Society of Arts on the subject of Parkesine, and in a discussion which followed the reading, it was stated that this substance is not affected by sea-water; it does not soften, like gutta-percha, by heat; it is a good insulator of electricity, even at a temperature of 212° F.; it may be made either opaque or transparent, plain or coloured; it will make a very strong joint after fracture; it will resist most of the common acids; its tensile strength is greater than that of india-rubber or gutta-percha. In its hard form, the surface can be so treated as to imitate marble, tortoiseshell, amber, or malachite. It may be moulded, pressed, turned, sawn, planed, carved, rolled, engraved, inlaid, or polished, according to the consistency given to it in the course of manufacture; or it may be made thin enough to use, when melted, as a varnish or protective coating or waterproofing. Among the many articles into which it may be fashioned, are included spinners' rolls and bosses, knife-handles, combs, brush-backs, shoe-soles, umbrellas and parasol handles, buttons, bookbinding, tubes, galvanic-battery cells, waterproof fabrics, surgical implements, and telegraphic insulators.—It is probable that the eventual success of compositions such as this will mainly depend on the price at which the material can be supplied per pound, compared with the prices of gutta-percha and india-rubber, the two substances which it is mainly intended to imitate or supersede. The supply of these two is wholly dependent on the sap of certain forest-trees in torrid climates; the mode of obtaining the sap is recklessly wasteful; and it is not yet known how far a continuance of the supply can be relied on.

PARRAS, a well-built town of Mexico, in the state of Coahuila, 470 miles north-west of Mexico, near the east shore of Lake Parras. It derives its name from a species of indigenous vine much cultivated, and has always been celebrated for its wines

and brandies. There are many old Spanish families here. Pop. 8000.

PARRISH'S CHEMICAL FOOD is the popular name for a non-official preparation medicinally known as *Compound Syrup of Phosphate of Iron*, every drachm of which contains 1 grain of phosphate of iron, 2½ of phosphate of lime, besides soda and potash. Mr Parrish of Philadelphia was the first to publish a formula for this very useful compound.

PARTA'NNA, a market-town of the island of Sicily, in the province of Trapani, 36 miles south-west of Palermo, on a slope. Pop. 12,467.

PASMA is the name given to a non-official healing-powder, which is regarded as very serviceable in burns, ulcers, excoriations, &c. It is composed of 30 parts of silica, 12 of magnesia, 6 of alumina, 2 of protoxide of iron, and 50 of starch from the olgrra root.

PATENT LAWS. Since the introduction of the amended Patent Law in 1852 (see PATENTS), many manufacturers have boldly advocated the abolition of the patent system altogether; on the plea, that the good results, whatever they may be, are over-balanced by the bad. The great majority of advisers, however, call for further reform, not abolition. The Economic Section of the British Association has discussed this matter during a long series of years. The Society of Arts, also, have had many discussions on the subject; and the arguments *pro* and *con*. will be found at length in the *Transactions* of these bodies. The various Chambers of Commerce throughout the kingdom have likewise debated the subject at length. The actual operation of the system may be briefly illustrated. Mr Bennett Woodcroft, in 1864, examined 100 patents out of those which had been applied for in 1855. Of the 100, he found 96 frivolous in character, of little or no value as to the merit of the inventions; 4 of moderate value; and not one of striking promise. Out of the 100 applications, 70 patents were granted, of which 1 became void at the end of six months, 51 more at the end of three years, and 15 more at the end of seven years—because the patentees declined to pay the successive instalments of fees. There were therefore, in 1863, only 3 patents left out of the 100 which had been applied for in 1855. Mr Woodcroft finds that about the same ratio is exhibited in the whole of the 3000 or so applied for every year. In 100 of the average applications in 1858, he pronounced that there was not one invention of much value, 3 of some, and 97 of little or no value. In 1862, he found 1 of much, 1 of some, and 98 of little or no value. As to statistics of actual numbers, see PATENT OFFICE, LIBRARY, AND MUSEUM.

In 1862, a royal commission was appointed to consider the whole subject of the patent laws, and to suggest alterations which might be useful. The commission collected evidence in that and the two following years, and made its Report in 1864. Other commissions and committees have made later inquiries, and offered suggestions founded on the evidence collected; but the opinions expressed, on almost every point, are most conflicting. The divided opinion of practical men has hitherto discouraged any attempt to legislate on their recommendations; and the act of 1852 remains still in force.

PATENT OFFICE, LIBRARY, AND MUSEUM. The present organisation of these establishments arose mainly out of the act relating to *Patents* (q. v.) passed in 1852. Rooms were rented in Southampton Buildings, London, for the office as reorganised; a superintendent of specifications was appointed; and a plan was adopted for

making the system as useful to the public as possible.

*The Office.*—All the specifications of patents from the earliest date were examined, and minutely classified according to their contents. The patents from 1711 to 1852 were found to amount to the large number of 12,977; and the specifications of the whole of these were printed between 1853 and 1858. There were a few of earlier date, between 1617 and 1711, but none in so complete a form as to render them worth printing. The whole fill many hundred quarto volumes, with the lithographed illustrations bound in separate folio volumes. The expense of the whole undertaking—for paper, printing, and lithographing—was £92,000; the number of copies printed was small; but any single specification can be reprinted if a demand for it should arise. The next work was to utilise this immense collection by a thorough system of indexing. Three indexes were prepared—*Chronological*, *Alphabetical* (according to the names of the inventors), and *Subject-matter*. Arrangements were at the same time made for printing and indexing the specifications of all patents obtained under the new law (1852); and this has been done year by year. (The total number of patents, from 1617 to 1871, exceeded 70,000.) These specifications are sold to the public at the price of paper and print, varying from 1½d. to about 4s., averaging about 8d. each. The printing and publishing are completed within three weeks of the time when each final specification reaches the hands of the superintendent. Any copy of any of these, if stamped and certified, is received in any court of law or equity in the kingdom, in evidence of the patent to which it relates, without the necessity of producing the original document itself. There are generally over 3000 petitions for new patents every year; about 800 of the petitioners usually fail to give notice of their intention to proceed, and 200 more fall away before the actual sealing of the patent; so that, roughly speaking, about 2000 specifications of patents are added to the list every year. Of this number, not more than 500 to 600 over-live three years, the patentees being unwilling to pay the second instalment of duty which becomes payable at the end of the third year; and very little more than 100 are willing to pay the third instalment, due at the end of the seventh year. (In 1871, the new patents applied for were 3529; the number fell to 2338 by the time of filing the specifications.) To render the new specifications equally available with those of older date, three indexes are prepared for each year's collection, of the kinds already described. There has also been prepared a *reference index* to the whole series. In 1871, a new plan was adopted, of publishing weekly abridgments of the specifications of new patents: dispensing with any further alphabetical and subject-matter indexes. Besides this, abridgments have been drawn up of most of the specifications, and will be eventually of all: setting forth, in a few words, the general nature of the invention. These abridgments are collected into 12mo volumes, one or more to each class of subjects; and the volumes are sold at 6d. to 10s. each, according to their bulk. At the end of 1871, there were 77 such volumes, relating to 56 groups or classes of subjects. By reference to one of these handy volumes, or to the *Subject-matter index*, an inventor can see whether any person has preceded him in the particular subject for which he desires a patent.

*The Library and Reading-room.*—Special arrangements are made to render the specifications, and all that relates to them, as available as possible to the public. Complete sets of the printed specifications,

indexes, &c., have been presented to universities, government offices, provincial towns, colonies, and foreign governments; and partial sets to 300 mechanics' institutes and scientific and literary societies. A complete set comprises 2380 volumes, from folio to 12mo, and costs no less than £2700 for paper, printing, and lithographing; about 160 of these complete sets have been presented. At the head office in Southampton Buildings, a Reading-room has been provided, open to each of the public as may wish to consult the specifications at their leisure. But besides this, the commissioners have gradually become possessed of a large and valuable collection of scientific and technical books and periodicals, to which additions are every year made by purchase. A new Library and Reading-room, occupying the upper part of the old building, has been constructed at a cost of £15,000, and was finished and opened in 1867. All the scientific and technical works of the Library, as well as the specifications of the patents, may here be consulted under due regulations.

*The Museum.*—The commissioners having come into possession, by gift and otherwise, of several models illustrating patented inventions, had no place of their own to deposit them for preservation and exhibition. But an arrangement was made with the authorities at South Kensington for the reception of these models; and, greatly augmented by specimens, drawings, diagrams, and portraits, the Patent Museum now occupies a site adjacent to the South Kensington Museum.

The commissioners have for many years sought permission to erect a large and handsome building to accommodate the whole of their departments—offices, Library, Reading-room, and Museum. They possess the pecuniary means, but lack the authority. Their receipts exceed £100,000 a year, in the form of fees from patentees; and after a very liberal expenditure for salaries, superannuation allowances, editing, compiling, printing, purchase of books and periodicals, &c., there is a considerable surplus. A clause in the act of 1852 prevents them from buying land and erecting buildings without the consent of the Treasury. The latest suggestion made by the commissioners is for permission to build in a new street to be formed from the Horse Guards to the Thames Embankment; but this new street, involving the demolition of Fife House, has not yet received legislative sanction.

PATERNO (anc. *Hybla Major*), a town of Catania, Sicily, 11 m. N.W. by W. from Catania, at the southern base of Mount Etna. Near P. are salt-springs and a salt-mine. Pop. (1871) 14,730.

PATTI, ADELINA MARIA CLORINDA, a popular operatic singer of Italian extraction, born at Madrid April 9, 1843. After a course of professional study, she sang at an early age in New York. Her debut in London took place in 1861 as Amina in *La Sonnambula*; and she has ever since been looked upon as one of the first singers of the day. Her voice is an unusually high soprano, of rich bell-like quality, and remarkable evenness of tone; to these qualities she adds purity of style and high artistic finish. Equally at home in the tenderness of deep passion and the sprightly vivacity of light comedy, she has also sung with success in oratorio. She has also won golden opinions on the continent wherever she has appeared, receiving, in 1870, the Order of Merit from the Emperor of Russia. Her greatest success is generally considered to be in the part of Marguerite in Gounod's *Faust*. In May 1863, she married the Marquis de Caux, from whom she was divorced in 1876. She had never retired from the stage.

**PATTI, CARLOTTA**, sister of the above, is also one of the leading singers of the day, though a slight degree of lameness has prevented her from appearing much in opera. Her voice is a soprano of unusual compass, and of a clear silvery quality, and much power in the upper register. Her peculiarly high notes, and a graceful *abandon* of manner, have brought her into favour with the public, though, in quality of tone, she does not come up to her sister. She made her *début* in London in 1862, but had for some time before been in the enjoyment of a high reputation in the United States.

**PAUCHONTI TREE** (*Isonandra polyandra*), a large forest-tree, of the same genus with the gutta-percha tree, and producing a substance similar to gutta-percha, abundant in some of the forests at the base of the Western Ghats in India. It is now supposed that there are several species of *Isonandra* in Western India, the produce of all which has begun to be sent to the market as gutta-percha, although it is said that none of the kinds is equal in quality to the true gutta-percha, obtained from *Isonandra gutta*. The wood of the P. tree is very heavy, and its tenacity is equal to that of teak. A P. tree having been tapped in 40 places, from the base to 60 feet high, has yielded in twelve hours about eight pints of sap, each pint being equal to about a pound of gutta-percha.

**PAZ (LA) DE AYACU'CHO**, a town of Bolivia, South America, capital of a dep. of the same name, about 20 miles from the south shore of Lake Titicaca, is situated on the east declivity of the Andes, at an elevation of 12,000 feet above the sea, on both sides of a deep ravine, here crossed by nine bridges. The whole city is subdivided into sections by numerous ravines. The streets are generally irregular and steep; there are some good public buildings, several educational institutions, a noble cathedral, and many other churches. It is the seat of a bishop and a university. La P. is the largest city, and the principal commercial emporium of Bolivia—the exports consisting of gold, bark, and other products of the country; and the imports of manufactured goods, the bulk of which comes through Peru. This city, whose original name was Nuestra Señora de la Paz, was founded in 1648. The name was changed in 1825 to its present form, in honour of the national victory of Ayacucho (q. v.). Pop. at latest published census, 76,372, the greater part of which is Indian. Pop. of dep., 475,322.

**PEGANUM**, a genus of plants of the natural order *Zygophyllaceae*, of which the only known species, *P. harmala*, a half-shrubby plant with linear, smooth, almost bipinnatifid leaves, and solitary, white, axillary flowers, a native of the Levant and the north of India, is sometimes cultivated in gardens under the name of SYRIAN RUE. The seeds are narcotic, and the Emperor Solymán is said to have kept himself intoxicated by eating them. They were formerly used in medicine in Europe, and still are in the East. The Turks use them as a spice, and also for dyeing red. The plant is believed to be the *Harmala* of the Greeks, mentioned by Dioscorides as one of the kinds of *Peganon*.

**PEI'SHWA** (Minister) was the title of the personage third in rank and authority at the court of the Mahratta Maharajahs of Satara, there being only the *Priti-nidhi* (Delegate of the Rajah) between him and his sovereign. However, during the weak reigns of Sevajee's descendants, the minister increased in importance, till, at the commencement of the 18th c., BALAJEE BISWANATH, the then Peishwa, and a man of distinguished administrative ability and diplomatic talents, made himself virtually the ruler of the Mahrattas (q. v.).

**PELESTRINA**, a town of N. Italy, in Venetia, near the centre of an island of the same name, 12 miles S. of Venice. The island is about 7½ miles in length, and one mile in breadth. It is one of the low narrow islands which separate the Lagoon of Venice from the Adriatic. The island is in great part occupied by a row of small towns, of which P. is the largest. Pop. 7195.

**PE'MBA**, called the Green Isle by the Arabs, an island off the east coast of Africa, in the dominions of the Sultan of Zanzibar, the nearest point being about 20 miles from the coast, and the southmost point 40 miles north of the island of Zanzibar. It lies across the 5th degree of S. lat., and in long. 39° 53' E. Length about 38 miles from north to south. Next to Zanzibar, P. is the most remarkable island in the dominions of the sultan. It is an irregular coralline island, cut up in every direction by creeks, which are much frequented by country craft engaged in the slave-trade; while, owing to the numerous reefs and shoals, and to the imperfect survey of the island, they are quite impracticable for vessels of war. The vegetation is most luxuriant. Although the main island is less cultivated than Zanzibar, it appears, if possible, more productive, and its fruits, especially the mango, are more highly esteemed. P. is more unhealthy than Zanzibar, and the mortality from fever is so great, that it is a question whether it could be kept under cultivation were the supply of slave-labour cut off. Chak-Chak, the chief fort, port, and town, is situated in a deep inlet on the western side, and the narrowest part of the island. Its approach is winding and difficult. The Portuguese long made P. one of their principal slave dépôts. A few merchants reside on the island.

**PENEDO**, a flourishing town of Brazil, in the province of Alagoas, 50 miles south-west of Macayo, on the San Francisco, near its mouth. In the district, cotton, rice, and other crops are grown. Pop. of town 9000, of district, 17,574, mostly Indians.

**PEREJASSLA'VI**, an ancient town of Russia, in the gov. of Poltava, 100 miles south of Tchernigov, at the confluence of the Trubesh and Alta, near the Dnieper. A battle was fought here in 1149. Pop. (1867) 10,047.

**PERFECTIONISTS, or BIBLE COMMUNISTS**, popularly known as **FREE-LOVERS**, or preachers of Free Love, a small American sect who are equally remarkable for the doctrines which they hold, and for the unflinching way in which they carry them out in practice. The founder of the sect, John Humphrey Noyes, is still alive, and is described by William Hepworth Dixon, in his work on *New America*, as 'a tall, pale man, with sandy hair and beard, gray dreamy eyes, good mouth, white temples, and a noble forehead.' In appearance, he is a little like Mr Carlyle, and he is said to be not a little proud of the resemblance. Noyes was born at the town of Brattleborough in Vermont; he studied at Dartmouth College, New Hampshire, where he took a degree; and he afterwards became a clerk in a lawyer's office, at Chesterfield. In 1831, a revival of religion broke out at Putney, and Noyes was one of those who were aroused to a consciousness of sin and anxiety about the way of salvation. He began to puzzle over theological questions; and he gave up the law to study theology at Andover, in Massachusetts. There he spent a year in unremitting study of the Bible; but was exposed to many temptations, owing to the habits prevailing among his fellow-students. From Andover he passed to Yale College, New

Haven, where he was first a student, afterwards a preacher in connection with the Congregational body, and where he became a great seeker after truth—not as it stands between God and man only, but as between man and man. Here it was that he arrived at the principal of the ideas which constitute his social and religious system—deriving them, after much study and speculation, from the writings of St Paul. He came to the conclusion that the opinions of St Paul had been completely misconceived by all the Christian churches; that all our ecclesiastical organisations have consequently been blunders; and that from the apostolic age to his own there had been no visible church of Christ upon earth. He conceived that in the age of Paul and Peter there had been a true Christian church—a communion of saints, in which all were brethren, and all equals; but that it passed away at an early date, on our Lord having returned in the Spirit, as he had promised, to dwell among his people for ever. This second advent of Christ he placed in the year 70; and he came to the conclusion, that since then the true church has consisted, not of any of the religious organisations which have successively sprung up, but of saintly persons scattered here and there, sinless in body and soul, confessing Christ as their Lord, professing holiness, rejecting law and usage, and submitting their passions to the Divine will. He believed that Christ, on his second advent, abolished the old Law, and closed the reign of sin which began with Adam; and that he has thenceforth set up His kingdom in the hearts of all willing to accept His reign. For such persons, there was no longer any law or rule of duty; neither the Mosaic code, nor the Sermon on the Mount, nor the ordinances or institutions of civil society, were binding upon them; they were a law unto themselves; they were free to do as they pleased, but—with exceptions which, however, could not invalidate an eternal truth—under the influence of the Divine Spirit which dwelt in them, they could only do that which was right. It was owing to the power of the devil that the churches had gone so far astray; but he conceived that the time had come when, among the new communities of America, there should be set up a perfect model of a Christian church—in which all should be brethren; in which men and women should be equals; in which individuals should be untrammelled by any restraints save those imposed by the Divine Spirit working within themselves. Noyes took upon himself the task of laying the foundations of the true Christian church; but before setting to the work, he is accused of having furnished at once evidence of his belief in his theory, and an illustration of the dangers attending it in practice. His mind once satisfied that there was no law for him, he gave the rein, it is said, to dissipation, and for some time abandoned himself to licentiousness. This, however, is denied as a malicious calumny.

His early efforts at establishing a church, made at New Haven, were very discouraging; he made converts to his views, and they became only too deeply imbued with his theory. Each being a law unto himself, they had conflicting desires, and this led to quarrelling, and eventually to schism. Among the men, there were some who contested with Noyes the leadership of the fraternity; and among the women, one or two who, in spite of his theory, expected him to marry them. At the end of four years, he found, that though he had co-believers, he had no followers; and he retired to Putney, disappointed, but resolved to make a new experiment. He determined to make trial of the principle of association—of association under conditions which he deduced from the

New Testament; to establish a 'Bible Family'—a society disavowing all law and all connection with the world, in which all should be brethren, perfectly equal; in which, therefore, worldly goods should be held in common; in which there should be no appropriation of men and women to one another. The connection of the sexes was, upon his view, as free from law, as completely subject to the desires of individuals, as every other human relation; and besides, he seems to have thought a community of women a logical sequence from a community of goods. He saw that the members of such a society must be selected and educated for it; and he set up a Bible class, by means of which he gained a sufficient number of proselytes, and educated them for Bible association. Before long, there was nothing wanting for a trial of his scheme but money to buy a house and a piece of land; and this he got by marrying one of his converts, a young lady named Harriet Holton, to whom it is but fair to say, he candidly explained that with his principles marriage could be nothing but a form. Then he and his associates formally renounced their allegiance to the United States, and set up house in 'celestial order' at Putney. His wife, mother, sister, and brother were among the members of the new society; the others were all persons of some means and position—preachers, farmers, doctors, with their wives and children. Their property was thrown into a common stock; they gave up the use of prayer, all religious service, and the observance of the Sabbath; those who were married renounced their marriage ties, and a 'complex marriage' was established between all the males and all the females of the 'Family.' To get rid of the inconveniences which had been found attendant upon the exercise of Christian liberty, Noyes had set up a new principle, viz., sympathy, by which the individual will was to be corrected, which practically imposed upon individuals the duty of deferring to the feelings and opinions of the brethren. He now taught that the Family was wiser than the individual, who might stray from the path of grace; that the individual was erring when he differed from the Family; and that the inclinations of individuals must be submitted to the opinion of the Family. Having dispensed with law, he set up public opinion as a controlling power in its stead; and free criticism of one another by the members of the society became an important feature of his system. Quarrelling, however, broke out among the members; their differences were brought before the law-courts; and when the details of the Family system became known, the people of Putney made the place too hot for the Perfectionists. Their establishment was broken up; but a portion of the Putney Family—about fifty men, as many women, and about the same number of children—soon established themselves in a new home, in the sequestered district of Oneida, in the state of New York. Among the things which first drew attention to the Putney Family was a controversy which Noyes maintained with the leaders of another society of P. established at Oberlin. The P. were divided upon the question, whether of the two leading features of their system, the profession of holiness and the right of Christian liberty, the one or the other was the more important—some were 'Liberty-men,' others 'Holiness-men.' Noyes took up the controversy on behalf of the latter.

At Oneida Creek, the new 'Family' purchased about 600 acres of forest-land, and proceeded to bring it under cultivation. They have made it one of the most productive estates in the Union; they have also established manufactures of various kinds; and in the course of 30 years, they have become a

prosperous, and even a wealthy community. Their wealth they owe in a great measure to the inventive talent of one of the 'Family,' an old Canadian trapper, named Sewell Newhouse, who invented an improved form of trap—the 'Oneida Trap'—which is now almost universally used by trappers throughout America. In other respects, the 'Family' has been very prosperous: it consisted in the year 1874 of in all 238 persons, who live together in a state of great harmony and contentedness; and being already sufficiently numerous, it has to reject frequent applications which are made for admission to membership. A similar society has been established at Wallingford, which numbered, in 1874, 45 members. Their neighbours have become accustomed to the P. and their ways, and let them live in peace; Noyes is even become popular. On settling at Oneida, guided by his experience, he modified many of the details of his arrangements. Between study and labour, the life of the 'Family' at Putney had been rather a hard one—he told his followers that in future they should enjoy life, as became men to whom all things were pure and permitted. The society chose no chiefs, believing that, without chiefship, the management of their affairs must fall to the fittest persons; and their affairs have been ably managed. The controlling function of criticism was strengthened by being made more systematic; and a regard for the common good, grown strong through habit, has made persons who disavow all laws perfectly submissive to the unwritten laws of public opinion. In the smallest, as well as in important affairs, the Perfectionist practises submission to the opinion of his brethren: in small matters, he usually gathers it by consultation with some of the older members of the body; important ones are submitted to the 'Family' at their evening meetings. All are busy; and they work as hard for the general interest as men do in the hope of enriching themselves. The men wear no particular garb, but usually dress like the country-people around them; the women have their hair cut short, and parted down the centre; abjure stays and crinoline; wear a tunic, falling to the knee, and trousers of the same material; a vest, buttoning high towards the throat; and a straw hat. In this costume, according to Mr Hepworth Dixon, plain women escape notice, and pretty girls look winsome; but, as may be inferred from the treatment of their hair, it has been no part of the Perfectionist system to make the women look bewitching. The 'Family' has breakfast at six o'clock, dinner at twelve, and the evening-meal at six in the afternoon; the more advanced of its members abstain from animal food; they drink no beer, and only a weak home-made wine; and like most of the new American sects, they will have nothing to do with doctors. The women are allowed a good deal of influence.

While all the males and females of the 'Family' are united by a 'complex marriage,' their intercourse—which, in theory, is unfettered by any law—is, in practice, subject to a good deal of regulation. Like everything else, it is subject to the opinion of the society, and certain principles have been so steadily applied to it, that they have gained the force of laws. First, there is the principle of the ascending fellowship. There should be contrast, the P. say, between those who become united in love. That there should be difference of temperament and of complexion has, they say, been well ascertained by physiologists. They hold that there should be a difference in age also, so that the young and passionate may be united to those who have, by experience, gained self-control. In virtue of this principle, the younger women fall to the older men, and the younger men to the older women. A second

principle is, that there should be no exclusive attachment between individuals; a third, that persons should not be obliged to receive the attentions of those whom they do not like; and lastly, it is held indispensable that connections should be formed through the agency of a third party—because, without this, the question of their propriety might be withdrawn from criticism, and also, because this affords a lady an easy opportunity of declining. The human heart, the P. say, is capable of loving any number of times, and any number of persons at the same time, and the more it loves the more it can love. The system of the 'complex marriage' is therefore suitable to, while monogamy imposes a restriction upon, human nature; and they believe that marriage will be spurned by the churches as soon as they get rid of the false notion of the essential sinfulness of love. They are confident that, when they have worked out a few details, still incomplete, their system will be perfect, and that it will, before long, be imitated throughout the length and breadth of America. There are four things, according to Noyes, necessary to the organisation of a true family: (1) the reconciliation of its members with God; (2) their salvation from sin; (3) recognition of the brotherhood and equality of man and woman; (4) community of labour and its fruits; and communism can only prosper when the previous conditions exist. The P. hold that for reconciliation to God and salvation from sin nothing is necessary but faith; let a man believe that he is reconciled to God, and his sins are immediately washed away.

**PERINEUM.** The part of the human body which forms the floor of the true pelvis is by anatomists divided into two portions. Of these, the anterior one, situated in front of the anus, is called the *true perineum*, or urethral portion of the perineum; the posterior portion, which contains the anus or termination of the rectum, is called the ischio-rectal region, or anal portion of the perineum. The anterior portion, or true perineum, is triangular in form, the apex being in front; the sides, about three inches in length, are formed by the rami of the pubes and ischium; and the base by an imaginary line joining the tuberosities of the ischium, and passing about half an inch in front of the anus. Through this space the urethra passes through a layer of strong fascia—the deep perineal fascia—to communicate with the bladder, and in this space the opening is made in the operation of lithotomy.

**PERLEBERG**, a town of Prussia, province of Brandenburg, on the Stepnitz, with woollen and machine manufactures, tanneries, &c. Pop. (1871) 7390.

**PERUWELS**, a town of Belgium, in the province of Hainaut, with breweries, limekilns, and some linen manufactures. Pop. (1870) about 8000.

**PETERHOF**, a palace of the emperor of Russia, on the southern shore of the Gulf of Finland, 15 miles west of St Petersburg. The palace was built by Peter the Great in 1711, contains a fine collection of paintings, and is surrounded by a beautiful park. The town of P. has (1867) 7745 inhabitants.

**PETÖFL, SANDOR (ALEXANDER)**, who may fairly be described as the national poet of Hungary, was born at Little Kürös, in the county of Pesth, in 1822. His father was a butcher, and a small landowner in Little Kumania, and bore the name of Petrovich (son of Peter)—a name indicating a Slavonic origin, which the poet, when he came to manhood, exchanged for the Magyar equivalent, Petöfi. In 1838, his father was reduced to poverty by an overflowing of the Danube, which destroyed his little estate; and it was by the help of relatives that he was able to carry out his design of educating his son for a



profession. P. was sent to the lyceum of the town of Schemnitz. It was while there that he began to write verses, and first displayed the extravagant fondness for theatricals which characterised him throughout life. From the first, he neglected his studies; ultimately, he ran away with a band of German strollers. His father after some time found him out, and brought him home, and he remained for a period in quasi-custody among his relatives. When at length he was again sent to school at Oedenburg, he almost immediately ran away, and enlisted as a common soldier. After he had been about two years in the army, a physician, who had taken pity upon him, procured his discharge, and he went back to his relations. He afterwards went to Pápa, to complete his education. His passion for the stage, however, drew him away from Pápa, as it had formerly done from Schemnitz; in 1842, he left it to join a troop of comedians. His stage-attempts were utter failures, and he soon parted from the comedians, if, indeed, he was not dismissed by them. He made his way to Presburg, and afterwards to Pesth, where he got some employment as a translator from the English and the French. Among other works, he translated a novel by Mr G. P. R. James. As soon as his literary labour supplied him with the means of travelling, his passion for the stage returned upon him; he went to Debreczin, and made another venture as an actor—playing the part of Othello—but failed even more completely than before. At last he had the good fortune to be invited to contribute to a newspaper at Pesth—the *Devallap*—and he immediately closed with the proposal. He made his way on foot from Debreczin to Pesth—a distance of nearly 200 miles—wearing shoes padded with straw, and carrying in his bosom a MS. volume of verses, his whole provision for the journey consisting of two florins, which he got from an old school-fellow. It was on his arrival at Pesth that he exchanged the name of Petrovich for Petöfi. Within a few weeks of his arrival, he had troops of friends and a reputation.

He introduced himself to Vörösmarty, then the most popular poet of Hungary, who received the shabbily-dressed stranger coldly, and did not readily consent to listen to his verses. But when he had listened, he expressed his admiration warmly. 'Hungary,' he exclaimed, 'never had such lyrics: you must be cared for.' And from that time, he treated P. as a son, and never rested until his merits were fully acknowledged by his countrymen. P. was almost at once received into the Literary National Circle, at the expense of which was published his *Versék*, which appeared in 1844. This was soon followed by other volumes, which succeeded each other with amazing rapidity; all of them, though regarded as vulgar by some of the critics, obtaining an unbounded popularity; so that it was said of P. that 'he never went to bed at night, he never arose in the morning, without hearing his songs from the multitudinous passengers in the public streets.' He sprang almost at a bound into a position in Hungary similar to that which Burns holds in Scotland—that at once of the greatest poet and the representative man of his country. In 1848, when the revolutionary movement, which spread over Europe, began to affect the Hungarians, his energies and enthusiasm found a more useful direction; he became, by speech and pen, the advocate of the independence of Hungary. He was for some time a member of the Diet, but in October 1848, he became a captain in the Hungarian army; and in the beginning of 1849, he was appointed adjutant and secretary to General Bem. He was present at the

battle of Segesvár, fought on July 31, 1849, in which Bem's army was defeated with great slaughter; and he was never heard of after that battle. It is believed that he was trampled to death in the fight, and that his body, so defenceless as to escape recognition, was buried with the multitude of Magyar dead left upon the field. His countrymen long believed that he was not dead, but a prisoner in an Austrian dungeon; and it is said that among the peasantry this belief is cherished still. Several false Petöfis have made their appearance since his death, and much spurious poetry has been published under his name. Lately, however, his countrymen have subscribed for the erection of a monument to his memory, and have purchased, with a view to its preservation, the house in which he was born at Little Kőcs. He left a widow—who married again—and one son. His brother, STEPHEN, has gained some reputation as a poet.

His poems, 1775 in number, were published in ten volumes. Most of them are lyrics, of which he published several collections, under the titles, *Cypress Leaves on Etelka's Grave*; *Pearls of Love*; *Starless Nights*; *Clouds*. The most celebrated of his narrative poems—also the longest—are, *János, the Hero*; and *Istok, the Fool*. His earliest work was *The Village Hammer*, published in 1843; his latest, *The Assessor of the Judgment-seat*, which appeared in 1849. A volume, containing a poem entitled *The Apostle*, was suppressed by the Austrian government after the pacification of Hungary. P. published a novel, *The Hangman's Rope*, which was by no means successful, and several volumes of tales, criticisms, and sketches of travel; and he translated largely from English and French into the Magyar.

A selection from his earlier pieces, translated into German, was published in 1845; and several volumes of translations from his writings have since appeared in Germany. They have also been translated into French, Flemish, Polish, Danish, and Italian; and lately, an English version, comprising his finest poems, has been published by Sir John Bowring. The quality of his poetry has been as fully recognised among foreigners as among his countrymen: thus, Grimm declared that 'Petöfi will rank among the very greatest poets of all times and tongues;' Henry Heine spoke rapturously of his 'rustic song, sweeter than that of the night-gale;' and Uhland avowed that only old age could prevent his learning Magyar, that he might enjoy P. in his native dress.

PETROVSK, a town of Russia, in the province of Saratov, 55 miles north-west of Saratov, situated on the Medveditz, a tributary of the Don. Pop. (1867) 12,749.

PEUTINGERIAN TABLE, the name given to a most interesting ancient document, which exhibits the military roads of the Roman Empire, and indeed of the world known to the Romans. It is not, properly speaking, a map; no regard being paid to geographic position, or the extent of countries. The great lines of road are laid down in a narrow strip, as if nearly parallel, all proceeding from Rome as a centre; and as to rivers, it only appears whether they cross the road from left to right or from right to left of the traveller proceeding from Rome. The Mediterranean and other seas are represented by mere narrow channels. A small house is the mark for a town; important towns and military stations are distinguished by walls and towers. Rome, Constantinople, and Antioch are each represented by a circle, within which is a human figure seated; in the case of

Rome, the figure is crowned. Until very recently, a portion of the only copy of this valuable relic of antiquity known to exist was evidently wanting, as it terminated abruptly on the west at the confines of Spain, and included only the eastern parts of Britain. In the east, it traces roads through India to a number of places of trade as far as the mouths of the Ganges. It is on parchment, and as described in all the publications devoted to it, twenty-one feet in length, and about one foot wide. It was found in the library of the Benedictine monastery at Tegernsee, in Upper Bavaria, in the 15th c., by Conrad Ceites, who bequeathed it to Conrad Peutinger of Augsburg, a zealous antiquary, and one of the earliest authors on the Roman and other antiquities of Germany. Peutinger began to prepare a copy of it for publication, but died before he could accomplish his purpose, which, however, was partially executed by Mark Welsler, in his *Fragmenta Tabule Antiquæ ex Peutingerorium Bibliotheca* (Venice, 1591). The ancient document itself remained in the hands of the Peutinger family, and attracted no further notice, till it was offered for sale in 1714, and purchased by Prince Eugene, who presented it to the Imperial Library of Vienna, in which it still remains. An exact copy of it was published at Vienna in 1753, with an introduction and index by F. C. von Scheyb. It was again published as an appendix to *Katancsich's Orbis Antiquus* (Ofen. 1825); and at the request of the Academy of Munich, a revised edition, with an introduction, was published by Conrad Mannert (Leip. 1824). Since that time, a leaf detached from the rest has been found in the Imperial Library at Vienna, but we are not aware that any particular account of it or its contents has yet been given to the public.

The Peutingerian Table does not always agree with the Antonine Itinerary (see *ITINERARY*); some stations and towns being marked in the one which are not in the other, the distances marked being also sometimes different. But the two together throw great light on ancient geography. It appears almost certain from internal evidence that the Peutingerian Table belongs to the third century of the Christian era, or the beginning of the fourth, although the existing copy seems to belong to a later date. The general character of the work seems to shew that its authorship is to be referred to times of prevalent paganism; whilst a few things appear, probably alterations or insertions of a copyist, which refer to Christianity.

**PHARMACOPŒIA** (supplement to the article). The *British Pharmacopœia*, published in 1864, had the merit of amalgamating the London, Edinburgh, and Dublin Pharmacopœias; but it unfortunately contained so many defects, that, in accordance with the universal wishes both of the medical profession and of the chemists, the Medical Council ordered a new edition to be as speedily as possible prepared. This new edition has met with general favour from the profession; and it is to be hoped that as we have now succeeded in incorporating three distinct works into one, we may, in the course of a few years, hope to have a universal Pharmacopœia, or, at all events, one of so general a nature that the most important medicines of the American, British, and chief continental Pharmacopœias\* shall all be of the same strength. The most important additions to the new edition are benzoated lard (used for making suppositories and ointments), bromide of

ammonium (useful for sleeplessness, and in hysteria and epilepsy), carbonate of bismuth and solution of citrate of bismuth and ammonia (useful in the same cases as white bismuth), iodide of cadmium (which may be used in the form of ointment when the yellow colour of the skin that follows the application of iodide of lead ointment is objected to), oxalate of cerium (which, in doses of one or two grains three times daily, acts as a sedative and tonic, and is of great value in chronic intestinal irritation, dyspepsia, pyrosis, in chronic vomiting, and especially in the vomiting during pregnancy), flexile collodion (consisting of a mixture of 48 parts of collodion, 2 of Canada balsam, and 1 of castor-oil, and useful as a protecting coating for burns, ulcers, and in erysipelas); glycerines of borax, carbolic acid, gallic acid, tannic acid, and starch (which are used as local applications); various mercurial preparations, as compound ointment of mercury (which is an imitation of Scott's celebrated ointment for diseased joints), mercury suppositories (for thread-worms in the rectum), and the black and yellow washes which are now for the first time made official, lozenges of chlorate of potash, tincture of pellitory or pyrethrum (used locally for relieving toothache), quinine pills and wine, tincture of sumbul (valuable in 20 minim doses as a nervous stimulant in typhoid fever, delirium tremens, &c.), and tincture of green hellebore, or *Veratrum viride* (which, in doses of from 5 to 20 minims, is useful in gout, rheumatism, and neuralgic affections).

**PHILIPPO'POLIS**, capital of a sanjak in the eyalet of Adrianople, European Turkey, 91 miles west-north-west from Adrianople. It stands on a small island formed by the Maritza, which here becomes navigable. This island rises as a hill in the midst of a vast plain, which extends beyond Adrianople on the east, and from the base of the Rhodope Mountains on the south, to the Balkan chain on the north. The plain is extremely fertile, and is celebrated for the excellence of the rice which it produces. P. carries on a very extensive commerce both with Austria and with the East. P. is an ancient town, and in the time of the Romans bore the name of *Trimontium*. Three-fifths of the inhabitants are Christians, one-fifth Jews and gipsies, the remainder Mohammedans. P. is the seat of a Greek archbishop. The North American Board of Missions has a station at Philippopolis. Pop. about 60,000.

**PHILIPPSBURG**, a town of the grand duchy of Baden, 16 miles north from Karlsruhe, on the right bank of the Rhine, at the mouth of the Salz-bach. In former times, it was one of the most important fortresses on the Rhine, and belonged to the Bishop of Spira. During the Thirty Years' War, P. fell successively into the hands of the Swedes, the French, the Imperialists, and again of the French, who were confirmed in possession of it by the Peace of Westphalia. In the war between Louis XIV. and Germany, it was taken by the Germans under Duke Charles of Lorraine, and assigned to Germany by the peace of Nimeguen in 1679; but was again taken in 1688 by the French under Vauban, and once more restored to Germany by the peace of Ryswick in 1697. The French captured it again in 1734, and this time with little difficulty, the strength of the fortress being now much diminished, although the capture cost the life of the Duke of Berwick, their commander; and they again relinquished it in 1735. During the wars of the French Revolution, P. was bombarded in 1799, taken, and its fortifications completely destroyed in 1800. Pop. 2317.

**PHULOWDI**, a town of India, in the Rajpoot state of Jodhpoor, in lat. 27° 8' N., and long. 72° 28' E.

\* The chief continental Pharmacopœias are the French, which is also used in Switzerland; the Prussian, which is mostly used in Germany and Russia; and that of Orosi, which is used in Italy.

It is built on a rising ground, near the bank of a stream, which, after a course of no great length, loses itself amidst the sands of the desert. Pop. about 15,000.

**PIANA DE' GRECI**, a town of Sicily, in the province of Palermo, 10 miles south-west from Palermo, on one of the head-waters of the Belici. It was the chief colony of the Albanians who settled in Sicily in the 15th c., taking refuge from Turkish tyranny. Twenty-three such colonies were established in Calabria, but only four in Sicily, where King John II. granted them land, and guaranteed to them the free exercise of their religion. The colony at P. was founded in 1488. The descendants of the colonists still follow the Greek ritual, and adhere to all the customs of the Eastern Church, although acknowledging the supremacy of the pope. The Albanian dress is partially retained among the poorer classes, and particularly among the women. The inhabitants of P. are mostly husbandmen and shepherds. The houses are generally mean buildings of a single story. Pop. 7270.

**PIATRA**, a town of Moldavia, 62 miles west-south-west from Jassy, on the left bank of the Bistritza, a branch of the Sereth. The church of P. is one of the oldest in Moldavia. The only paper-mills in the province are here. Much wood is floated down the Bistritza and the Sereth to the Danube, to be exported from Galatz. Pop. about 11,900.

**PIA'ZZA**, or, more fully, **PIAZZA ARMERINA**, a town of Sicily, in the province of Caltanissetta, 17 miles east-south-east from Caltanissetta. It stands on the crests and slopes of an isolated hill on the left bank of the Terranova. It is the residence of many nobles and landowners. The chief trade is in corn, oil, fruits, and other agricultural produce. Pop. (1871) 15,923.

**PICTURES, RESTORATION OF.** Some important observations on the action of light on oil-paintings have led to a series of experiments by Dr David Price of the Crystal Palace, and he has succeeded in demonstrating that the discoloration of pictures in galleries and dwelling-houses arises in a great measure from the presence of sulphide of hydrogen gas, which reduces the metal in the white lead, and thereby gives the dark dingy appearance which so frequently defaces even modern pictures in some places where the pictures are hung on walls not exposed to the direct light of the sun. Dr Price shews that pictures which have been thus injured can be completely restored by being fully exposed to light in a pure atmosphere, the light exerting a rapid and powerful influence over the lead compounds, even though well protected with varnish. The same holds good even in a stronger degree in water-colour paintings in which lead-whites have been used.

**PIEDIMONTE D'ALIFE**, a town of South Italy, in the province of Caserta, and 20 miles north-by-east from Caserta, at the base of the Apennines, on a branch of the Volturno. It is about 3 miles north-east from Alife, the ancient *Alifia*, a city of the Samnites, now a small town of only 2689 inhabitants. In a grand and gloomy ravine, called the Val d'Inferno, near P., a torrent issues from a cavern, which is supposed to derive its waters through subterranean channels from a lake, about five miles distant, amongst the mountains. This and other mountain torrents afford water-power for a number of cotton, paper, flour, fulling, and copper mills in and around the town. P. is one of the most active manufacturing towns in Italy. The extensive cotton-mills established by Mr Egg give employment to about 1500 hands. There are copper-mines

in the vicinity. Pop. about 6000. Piedimonte is the name of several smaller towns and villages in Italy and Sicily.

**PIE'DRA BLANCA**, a town of the Argentine Republic, South America, in the province of Catamarca, and 20 miles south-west from Catamarca. Pop. 10,000.

**PIETRAPERZIA**, a town of Sicily, in the province of Caltanissetta, and six miles south-east from Caltanissetta, on a lofty height rising from the left bank of the Salso. There are sulphur-mines in the vicinity. Pop. 9909.

**PILLIBIT**, or **PHILLIBIT**, a town of India, in the British district of Bareilly, North-west Provinces, 28 miles N.E.-by-E. from Bareilly, on the left bank of the Gurráh, and on the road from Bareilly to Fetagorah. P. is a place of considerable trade. The P. rice, celebrated throughout India for its excellence, is the produce of the south of Kumaon, brought to P. to market. Pop. (1871) 29,840.

**PIP, CHIP, or ROUP**, a disease of poultry, often very fatal, particularly to chickens and turkey poults. It is very frequent also in young pheasants. Adult birds are, however, liable to it; and when it appears in a poultry-yard, it often attacks many in rapid succession, so that it is regarded as highly contagious. It most frequently occurs in wet or very cold weather, and is generally described as a kind of catarrh, although perhaps it might more accurately be called a kind of influenza. It begins with a slight hoarseness and catching in the breath, which is followed by an offensive discharge from the nostrils and eyes, rattling in the throat, and an accumulation of mucus in the mouth, forming a 'scale' on the tongue. The communication of the disease from one bird to another is supposed to take place through the contamination of the water in their common drinking-vessel; and therefore a bird affected with it should at once be removed from the rest. Castor-oil is freely administered by some poultry-keepers. Mrs Blair, in *The Henwife*, recommends a table-spoonful, but without saying whether this dose is for a full-grown fowl or a young chicken. She recommends also a medicine composed of half a drachm of dried sulphate of iron, and one drachm of capsicum, made into 30 pills with extract of liquorice, one pill to be given three times a day. This after a certain time is to be followed by another compound of sulphate of iron, cayenne pepper, and butter. The eyes, nostrils, and mouth are to be washed with vinegar. In a work on poultry published in 1867 (*The Practical Poultry-keeper*, by L. Wright, London), it is specially recommended that the diseased birds should be kept warm; they are to be fed on oatmeal mixed with ale, and to get plenty of green food. In other respects, except as to the castor-oil, the treatment recommended nearly agrees with Mrs Blair's; but the removal of the 'scale' from the tongue is not regarded as necessary, because it will disappear of itself on the cure of the disease.—It is proper to mention that there is considerable confusion of nomenclature as to the diseases of fowls, and that, by some writers, the mere symptomatic affection of the tongue is called *Pip*, and the disease itself *Roup*. The terms, however, are generally used in the same sense.

**PI'ZZO**, a seaport of South Italy, in the province of Catanzaro, 24 miles west-south-west from Catanzaro, on the Gulf of Santa Eufemia. It was at P. that Murat (q. v.), the ex-king of Naples, was taken, tried, and shot. He was buried in one of the common vaults of a church to the erection of which he had largely contributed. Pop. 6402.

**PLA'SSEY**, a small town of British India, in the

presidency and province of Bengal, and in the district of Nuddea, 84 miles north from Calcutta, on the left bank of the Bhaghrutti, a river which derives its waters from the Ganges, and pours them into the Hooghly, or rather may be said to become the Hooghly. P. is celebrated in the history of India for the great victory gained by Clive (q. v.) over Suraja Dowlah, subahdar of Bengal, 23d June 1757, a victory, the immediate effect of which was to transfer the subahdarship to Meer Jaffier, but which really laid the foundation of British supremacy in India. The British force at the battle of P. consisted of not much more than 3000 men; and the only British troops were about 650 foot and 150 artillerymen, the remainder being sepoys. The subahdar's force consisted of 18,000 cavalry and 50,000 infantry, with 40 or 50 French artillerymen, 50 large cannon, and 4 pieces of light artillery. On the evening before the battle, Clive held a council of war, at which it was resolved to decline battle, on account of inferiority of force; but Clive himself afterwards adopting a different resolution, crossed the river, and won a most brilliant victory.

PLINLI'MMON, or PLYNLIMMON, a mountain of Wales, on the boundary between the counties of Montgomery and Cardigan, 11 miles north-west from Llanidloes. It is 2481 feet in height. The name P. is said to be a corruption of the Celtic *Pumlumon*, signifying Five Rivers, and to be due to the fact, that five rivers have their source in this mountain: one of them is the Severn, and another the Wye. P. is a huge mountain mass, with three chief summits. Although not above 12 miles from the coast, it is in the midst of a wide waste of muir and bog. Spurs, or subordinate mountain-ranges, spread out from it in all directions. The view from the summit is very extensive. It was in the fastnesses of P. that Owen Glendower took his stand, in 1401, at the outset of his career, issuing thence with a few determined followers to make inroads on the English borders.

PLOJESHITI, or PLOYESTI, a town of Walachia, 35 miles north-by-east from Bucharest, on the Dimbow, a feeder of the Jalomniza. It is a place of considerable trade, and has a great annual wool-fair. Pop. (1870) 26,468.

PLUME-BIRD (*Epimachus*), a genus of birds of the family *Upupidae* (see HOOPOE), but exhibiting



Plume-bird (*Epimachus albus*).

points of resemblance both to honey-suckers and to birds of paradise. The bill is slender and arched. The plumage is magnificent and gorgeous, scarcely excelled even by that of birds of paradise. The plume-birds are natives of New Guinea and New

Holland. They are variously adorned with enormously long tail-feathers, great shoulder-tufts of broad feathers, loose downy plumes, &c. One species, *E. albus*, has remarkable thread-like prolongations of the shaft of some of its plumes.

POINT-A-PITRE, a town of the French West India island Guadeloupe, capital of the division of Grande-Terre, on the Little Cul-de-Sac, 20 miles north-east of Basse-Terre. The town is well built, and has a safe and spacious harbour. It is the centre of the commerce of the colony. Pop. 14,000.

POISSON, SIMÉON-DENIS, a celebrated French geometer, was born at Pithiviers, in the dep. of Loiret, 21st June 1781; and displaying an aptitude for mathematics, he was received into the Ecole Polytechnique in 1798. The striking talent he thus early exhibited attracted the notice of Lagrange and Laplace, both of whom anticipated for him a brilliant future. In 1802, he became a professor in the Polytechnique; in 1808, a member of the Bureau des Longitudes; in 1809, Professor of Mechanics to the Faculty of Sciences; member of the Institute in 1812, &c.; and this list of distinctions was crowned in 1837 by his elevation to the dignity of a peer of France. He died in 1840. P.'s whole life was devoted to the prosecution of scientific research, and the fruits of his pen number about 300 Memoirs, inserted in the publications of the Ecole Polytechnique, of the Academy of Sciences, and other scientific journals. A complete summary of these labours by P. himself is published by Arago (*Notices Biographiques*, vol. ii.). Of the separate treatises published by P., the following are the chief: *Traité de Mécanique* (2 vols. 1833); *Nouvelle Théorie de l'Action Capillaire*; *Théorie Mathématique de la Chaleur* (1835); *Mémoire sur le Mouvement des Projectiles dans l'Air, en ayant égard à la Rotation de la Terre* (1839); and lastly, the celebrated work, *Sur l'Invariabilité des Moyens Mouvements des grands Axes Planétaires*. P. is fairly considered one of the chief founders of the science of mathematical physics, which was brought by him to great perfection, especially in what concerns statical electricity and magnetism. Many other ingenious discoveries and speculations are dispersed throughout his writings.

POKHURN, a town of India, in the Rajpoot state of Jodhpoor, 340 miles south-west of Delhi. It is situated close to a deserted town of the same name, the site of which is marked by a very conspicuous temple in an elevated situation. P. has a considerable trade and a pop. of about 15,000.

POLO, an equestrian game recently introduced from India into England, where not a few P. clubs have been founded. The game was first taken up by British cavalry officers when stationed at Lahore in the Punjab; and in England it is still practised chiefly by officers. P. may be familiarly described as hockey on horseback. The ground is three or four hundred yards long, and nearly as wide; the goals are each marked by two posts eight feet apart. Each player, mounted on his pony—for in England ponies are usually employed—holds in his hand a stout stick, having a curved hook at the lower end. The stick is not long enough to touch a ball on the ground without the rider's stooping somewhat; and he must be prepared to stoop to right or left with equal readiness, and to drive the ball backward, forward, or sidewise. The ball is dropped on the ground midway between the goals; then two sets of riders (generally about five on each side) gallop forward, each endeavouring, by means of repeated strokes, to drive the ball through the enemy's goal. As a safeguard against kicks during the scrimmage, the legs of the ponies are thickly bandaged. P.

is admittedly an exciting amusement, and is also splendid training for a horseman.

**POLYTRICHUM** (Gr. many-haired), a genus of mosses, having the capsule supported on a stalk (*seta*) which is terminal, and thus appears as an elongation of the stem; the peristome single, of 32 or 64 short equidistant teeth, which are curved inwards, and their summits united by a horizontal membrane closing the mouth of the capsule. A number of species are found in Britain, of which the most abundant is *P. commune*, sometimes called *Hair-moss*, *Golden Maidenhair*, and provincially *Goldilocks*; growing in heaths and woods, particularly where the soil is sandy; the stems not at all branched, or only at the base, several inches long; the narrow slender leaves sometimes nearly half an inch long. This beautiful moss is very common in the most northern parts of Europe and Asia.

**PONA'NI**, or **PANIANI**, a seaport town of British India, in the district of Malabar, on the south side of an estuary of a river of the same name, about 600 miles south-east from Bombay. The river is navigable only for canoes to the distance of 63 miles from the sea. The population is employed in fishing and in trade, having numerous patamars, or sea-going boats. P. was formerly a much more considerable place, until nearly ruined by the oppression of Tipoo Sultan. Under the system of railways by which the Madras territories are traversed, the eastern and western coasts of this part of the peninsula have been united by a line from P. to Madras. Pop. (1872) 11,472.

**POPERINGHE**, an old commercial town of Belgium, in the province of West Flanders, four miles from the French frontier. The town is walled, and has manufactures of lace, linens, and woollen cloths. Hops are grown in the surrounding district. Pop. (1870) about 11,000.

**PORDENO'NE**, a town of Venetia, Italy, in the province of Udine, 40 miles north-north-east of Venice, on the Noncello, a branch of the Livenza. The town is situated in a pleasant plain, near the base of the Alps. It is a station on the railway between Venice and Trieste. The site is supposed to be that of the *Portus Naonis* of the Romans. There are several large paper-mills, also cotton and linen manufactures, oil-mills, manufactures of copper goods, and glass-works. Pop. (1871) 4591.

**PORTER, DAVID D.**, Admiral of the American navy, son of Commodore David Porter, who commanded the *Essex* frigate in the war of 1812, was born in Philadelphia about 1805, entered the navy as midshipman in 1829, serving under Commodores Biddle and Pattison, passed his examination in 1835, was employed from 1836 to 1841 in the survey of the coast of the United States; in 1841, appointed as lieutenant to the frigate *Congress*, and employed four years on the Mediterranean and Brazil stations; in 1845, transferred to the National Observatory at Washington, and during the Mexican war, to the naval rendezvous at New Orleans; again to the coast-survey, and from 1849 to 1853, engaged in command of the California mail-steamers. At the commencement of the war of 1861, he was appointed, with the rank of commander, to the steam sloop-of-war *Powhatan*, and ordered to Pensacola; distinguished himself in the capture of New Orleans, and commanded the gun-boat and mortar flotilla which co-operated with the squadron of Admiral Farragut in the first attack upon Vicksburg. In 1863, he aided in the second and successful bombardment, and subsequently commanded the naval forces in James's River, and in the attacks upon Fort Fisher, captured at the second attack.

At the termination of the war, he was appointed superintendent and president *ex officio* of the U. S. Naval Academy, Annapolis. He was made vice-admiral in 1866, and in 1870 he became admiral, a rank which carries with it the command of the whole U. S. navy, subject only to the president.

**PORTO-MAURIZIO**, a seaport town of North Italy, capital of a new province of the same name, on the Gulf of Genoa, 58 miles directly south-west of Genoa city. Area of province, 467 sq. miles. Pop. (1871) 126,953. The town stands on a high promontory, projecting boldly into the sea, and has a lofty church, painted in brilliant colours. The harbour, defended by a mole, is generally crowded with the picturesque coasting-vessels of the Mediterranean. There is an extensive trade in olive-oil and agricultural produce. Pop. 6256.

**POST-OFFICE INSURANCE** is a valuable addition to the many useful services which our postal establishment has been enabled to render within the last few years. Book-post, sample-post, money-orders, and postal savings-banks, all additions to the original letter-post and newspaper-post, have been found to work so satisfactorily, that the legislature has been encouraged to intrust to the same organisation a new system of insuring lives and granting annuities—specially intended to foster provident habits among persons whose savings can be but small.

In 1853, an act of parliament made an improvement in the then existing state of insurance law, by facilitating the purchase of government annuities through the medium of the savings-banks; and in 1864, another statute gave a great extension to those portions of the system which had been found to work well, effecting at the same time alterations in those which had exhibited certain defects during eleven years' working. Great facilities are introduced by this act for securing annuities by small payments. Not only may the National Debt Commissioners employ the trustees of savings-banks to receive and pay the moneys, at a certain rate of remuneration; but the Postmaster-general joins in the arrangement, acting as a medium between the public on the one hand and the Commissioners on the other. Ample tables and regulations have been printed, for the guidance of the Commissioners, the Postmaster-general, and the local postmasters throughout the kingdom. On the completion of these tables and regulations in 1865, the practical working of the system began. The tables of the premiums to be charged for life-insurances, for immediate annuities, for deferred annuities, and for deferred monthly allowances, are sold by Messrs Eyre and Spottiswoode, the government printers, for 5s. (the cost of the paper and printing); but similar tables are kept for inspection at the local post-offices without charge.

In regard to insurance, distinct from annuities, persons of either sex may insure through the medium of the post-office. The limited ages are from 16 to 60, and the limited sums from £20 to £100. In order to afford every possible facility in the payment of the premium, minute calculations have been made of the exact sum to be paid at each instalment, by yearly, quarterly, monthly, or fortnightly payments, and terminable or not at a particular age. In order that there may be some limit to the labour thus placed on the postal authorities, no periodical instalment is made smaller than two shillings. No one life can be insured for less than £20 in the whole; but when a life has been insured for £20, further insurances may be effected on the same life from time to time, until the whole sum for which it is insured amounts to £100. The

POT-WALLERS—PRESERVES.

following is a tabulated example of nine different modes of paying the premium on one particular insurance, to suit the convenience of the insurer. A man in his 30th year may insure £100 to his survivors at his death :

	£	s.	d.
1. By a single payment of . . . . .	43	3	7
2. By an annual payment for life of . . . . .	2	6	7
3. By a quarterly " " " " . . . . .	0	13	0
4. By a monthly " " " " . . . . .	0	4	4
5. By a fortnightly " " " " . . . . .	0	2	2
6. By an annual payment, until the insurer reaches 60 years, of . . . . .	2	13	10
7. By a quarterly payment, until the insurer reaches 60 years, of . . . . .	0	15	0
8. By a monthly payment, until the insurer reaches 60 years, of . . . . .	0	5	0
9. By a fortnightly payment, until the insurer reaches 60 years, of . . . . .	0	2	6

If an insurer who has duly paid all instalments for five years, should desire, or be compelled by circumstances to withdraw from the engagement, a portion of the past premiums will be repaid to him—never less than one-third of the total amount.

In regard to immediate annuities, persons of either sex may purchase annuities of not more than £50, and for lives from 10 years old and upwards. The premiums necessarily vary with sex, age, and amount. Thus, a man aged 65 can purchase an immediate annuity of £10, paid half-yearly, for £88, 18s. 4d.; whereas, a woman of the same age would have to pay £103, 16s. 8d. Two or more small annuities may be purchased for the same life, provided the total amount does not exceed £50. Any two persons may purchase an annuity on their joint lives, with or without continuance of the annuity to the survivor.

Deferred annuities form another element in the scheme. These annuities are very varied in kind, and the amount of premium depends on a great number of conditions—amount of annuity; age and sex of the person; length of term for which the annuity is deferred (that is, the number of years which are to pass before the commencement of the annuity); mode in which the premium is to be paid; and the condition whether or not there is to be any return of purchase-money under certain contingencies. As examples, take the following: A man aged 30 may purchase a deferred annuity of £10, to commence on his reaching the age of 60, and due half-yearly, for one immediate payment of £21, 3s. 4d., or an annual payment of £1, 8s. 4d.; in the case of a woman, the immediate or total payment would be £32, 8s. 4d., and the annual payment £1, 17s. 6d. If the person on whose life the annuity is to depend should die before the annuity itself commences, all the premiums paid up to that date may be returned to his or her representatives, provided a contract to this effect is made in the first instance. The premiums are necessarily higher for such a contract. The four sums just mentioned, where past premiums are not returnable, would be raised respectively to £40, 9s. 2d., £2, 0s. 10d., £47, 0s. 10d., and £2, 7s. 6d., with the returnable clause included.

Many persons in humble life would prefer that the annuities due to them should come more frequently than half-yearly. To suit this class, a system of deferred monthly allowances is established. A man aged 30 may purchase a deferred allowance of £2, 7s. 3d. per month, to commence when he reaches the age of 60, by a payment of 8s. per month, until he reaches that age; the same monthly payment by a woman would realise a monthly allowance of £1, 16s. 7d. If the returnable clause (above noticed) is included in the contract, the man's monthly allowance would be £1, 14s. 2d., and the woman's £1, 9s. 4d., for the like

payment of 8s. per month. In regard to married couples, a husband and wife may each be insured to the full amount of £100, and may each purchase an annuity of £50, or a monthly allowance of £4, 3s. 4d.

Persons whose lives are insured, or to whom annuities are granted, through the post-office, have direct government security for the payment of the money at the proper time; and this is one of the many valuable features of the system. It is not necessary here to describe the exact routine of proceedings for making an insurance or purchasing an annuity; the postmasters whose post-offices have been raised to the rank of insurance offices, are fully instructed in the matter, and will give all requisite information to applicants. We may add, that the *British Postal Guide*, an authorised publication, issued quarterly at 6d., gives a considerable list of tables of premiums payable at various ages for various kinds of insurance and annuity.

**POT-WALLERS**, or **POT-WALLOPERS** (from *pot*, and Old English *wall*, to boil or bubble), the popular designation of a class of electors forming the constituency of various English boroughs—as Ilchester, Honiton, Tregoney, Old Sarum—before the Reform Act of 1832, whose qualification as housekeepers was considered to be established by their boiling a pot within the limits of the borough over a fireplace erected in the open air. The doing so was regarded as evidence that the elector was in circumstances to provide for his own subsistence, and not necessitated to apply for parochial relief.

**PRAIRIE-DU-CHIEN**, a town of the state of Wisconsin, U.S., on the right bank of the Mississippi, three miles above the mouth of the Wisconsin, and 165 miles west from Milwaukee. It is a prosperous and rapidly increasing town, and in its neighbourhood are rich copper-mines. Pop. (1870) 2700.

**PRA'TO**—often, for distinction, called **PRA'TO IN TOSCANA**—a town of Italy, in the province of Florence (*Firenze*), 10 miles north-west of Florence, in a fertile plain, on the right bank of the Bisenzio, a feeder of the Arno, and on the railway between Florence and Pistoja. There are manufactures of straw-plait, woollen cloth, cotton goods, silk thread, &c.; also soap-works, tanneries, and copper-works. Copper-mines of considerable productiveness exist in the neighbourhood. Pop. (1871) 12,900.

**PRESERVES, PRESERVED PROVISIONS**, &c. In addition to the methods already described under this head, we have to notice here some recent efforts to preserve animal food. As yet the most successful method is by placing it when boiled in tins of convenient size for household consumption, hermetically sealed from the air. The waste of animal food in Australia and South America had long been a source of deep regret, and the plan of sending it to Europe in the dried state had only partially come into use, when the attempt to preserve it in a boiled condition was first tried, on any scale, in 1866 or 1867. Since then, the quantity of Australian mutton and beef consumed in Great Britain has increased very rapidly. In 1872, the total value of the imports of unsalted meat was not far short of a million sterling, nearly the whole of which came from Australia. Tinned meat is not much inferior to newly cooked beef or mutton in flavour, and is more economical; its chief defect to most tastes is that it has the effect of being overdone.

The eminent chemist Liebig suggested the manufacture of a concentrated extract of meat; and this is now carried on very extensively both at home and abroad. It is chiefly used by invalids, and for quickly making soups. Only the lean or muscular

PREVEZA—PROVISIONAL ORDER.

part is used, and this is boiled until all but the fibrin is dissolved out; the liquid is then concentrated until it is brought to the state of a thick paste, in which state it is easily preserved. Much controversy has of late taken place concerning the nourishing properties, not only of Liebig's, but of all meat extracts. Still those physiologists who have least to say in their favour, do not deny that they have some useful properties as food, and their use is decidedly on the increase. The Liebig Extract of Meat Company is said to have slaughtered, in the year 1872, 150,000 head of cattle.

A few years ago, Professor Redwood patented a method of preserving fresh meat by a coating of paraffin; but this substance, from its brittleness, is apt to crack, and we are not aware that it is now in use. Quite recently, Signor Mariotti has patented a rather peculiar plan, which is more likely to succeed. It consists in carbonising the whole surface of the meat by taking advantage of the high temperature of boiling fat into which it is dipped. No way of preserving fresh animal food, however, can possibly excel the simple one of storing it in chambers or cabins at a temperature as little as possible above the freezing-point. This method has been practically applied in conveying large supplies of fresh meat to this country from the United States and Canada in steamers fitted up for that purpose.

Two large companies, an English and a Swiss, have been lately formed for the supply of condensed milk, and also coffee and cocoa mixed with it and sugar, in such a way as to be ready for use with the addition of boiling water. Coffee so prepared is at present very much in demand.

**PREVEZA**, or **PREVISA**, a town of European Turkey, in Albania, 20 miles south-west from Arta, and on the north shore of the strait which forms the mouth of the Gulf of Arta. Pop. about 8000.

**PRIEGO**, a town of Andalusia, Spain, in the province of Cordova, 45 miles south-east from the city of Cordova. The inhabitants of P. are chiefly occupied in husbandry. There are oil-mills, flour-mills, tanneries, and potteries. There were formerly very important silk manufactures, but these have become inconsiderable. Pop. over 13,000.

**PRILUKI**, a town of European Russia, in the government of Poltava, 138 miles north-west from Poltava. It has a considerable trade in corn, cattle, brandy, and saltpetre. Pop. (1867) 10,870.

**PRINTING.** In Printing, a remarkable American invention was brought into use in 1867. It is called the Matrix Compositor, and is only adapted for stereotyping, by making impressions on thick, soft paper of the letters in the order required, and then taking casts of the same in metal as usual. The peculiarity of this machine is, that it brings up any letter the compositor wishes to its right place in the line by simply touching the key which answers to that letter, in an arrangement like the front of a piano, each key being marked with its corresponding letter. At the moment the letter is brought to its place, it is made to press into the paper; and in this way the composition proceeds with only one alphabet of fixed types, which are made of steel to bear the pressure. With practice, a good compositor will work this machine, and thus form the matrix for the stereotype plates, as fast as he could set up the ordinary movable types. The saving in time and the wear of type is therefore very considerable.

**PRIZZI**, a town of Sicily, in the province of Palermo, and 30 miles south-by-east from Palermo. It is of considerable commercial importance. Pop. (1871) 8835.

**PROVISIONAL ORDER** is an order granted under the powers conferred by an act of parliament by a department of the government, by the Secretary of State, or by some other authority, whereby certain things are authorised to be done, which could be accomplished otherwise only by an act of parliament. The order does not receive effect, however, until it has been confirmed by the legislature. Till that time, it is purely provisional; and even after it has been so confirmed, and is in reality an independent act, it retains the title of a provisional order.

Provisional orders have been in operation in England for many years, and have been found most useful in facilitating the modification or extension of the provisions of general acts, so as to adapt them to the special necessities of particular districts. A general statute, dealing with an extensive subject like police or sanitary improvement, could only embrace provisions suited to the requirements of the country generally, and could not be so framed as to meet exceptional circumstances. When these had to be provided for, private legislation was necessary; but the cost and delay attendant upon the promotion of local acts in the usual way were so great as in many cases to be practically prohibitory. What was needed, therefore, was a ready and inexpensive mode of obtaining local legislation, and the system of provisional orders was devised to meet that want. The general act embodied legislation generally applicable, and gave power to some board or officer to issue provisional orders, whereby the general act might be better applied to special districts or under peculiar circumstances. Such powers were by the Public Health Act, 1848 (11 and 12 Vict. c. 63), conferred on the General Board of Health thereby constituted, but were by the Local Government Act, 1858 (21 and 22 Vict. c. 96), transferred to the Secretary of State. The Tunnage and Duties Act, 1861 (14 and 15 Vict. c. 38), empowered the same functionary to grant orders in reference to the objects of that act; while the Piers and Harbours Act, 1861 (24 and 25 Vict. c. 45), authorised the Board of Trade, with the sanction, in certain cases, of the Admiralty and Commissioners of Woods and Forests, to issue provisional orders dealing with a variety of important matters connected with the construction of piers and harbours, and the levying of dues and rates. The Lands Drainage Act, 1861 (24 and 25 Vict. c. 133), gave power to the Enclosure Commissioners to issue orders for the purposes specified in that act; and the Merchant Shipping Amendment Act, 1862, gave, relatively to its objects, corresponding powers to the Board of Trade.

All these acts were in full and beneficial operation in England when the General Police and Improvement (Scotland) Act, 1862 (25 and 26 Vict. c. 101), was passed, and it conferred extensive powers on the Secretary of State in relation to the granting of provisional orders for police and sanitary purposes. Subsequently, the Irish Drainage and Improvement of Lands Acts of 1863 and 1864 (26 and 27 Vict. c. 88, and 27 and 28 Vict. c. 72) enabled the Commissioners of Public Works, and the Oyster and Mussel Fisheries Act, 1866 (29 and 30 Vict. c. 86), enabled the Board of Trade, to issue orders in relation to the subjects of these acts respectively.

Nothing can be more diversified than the objects to be attained by provisional orders under the several acts above alluded to, and yet the course of procedure in relation to them all is substantially the same. A petition to the proper authority, specifying what is wanted, and supported by such evidence as can accompany the application, is made

the subject of inquiry by a qualified person commissioned for the purpose. After due inquiry has been made, and the result has been reported to the authority to which the application is addressed, the petition is disposed of, either by giving or refusing what is asked, or by giving it in a modified form. When a provisional order is granted, steps are taken on behalf of the government to have it confirmed by parliament. In the case of orders issued under the General Police and Improvement (Scotland) Act, for example, the requisite Confirmation Bill is framed, under instructions from the Secretary of State, by the Lord Advocate, who takes charge of the measure through its various stages. When unopposed in parliament, ten days or a fortnight usually suffice for the passing of the requisite Confirmatory Act, which has all the facilities of a government measure. Of course, the whole expense connected with the preparation and passing of the order, and the relative Confirmation Act, is defrayed by the applicants; but the advantages of provisional orders, compared with ordinary private bills, are nevertheless considerable. A provisional order may be got with greater expedition and at much less cost than a private bill. It is exempted from the tedious and costly formalities of complying with standing orders and making deposits, with all the formidable fees of the House, and other incidental charges. When opposition is offered, the opponents are fully heard by the commissioner appointed to make the requisite inquiries; and the grounds of opposition are deliberately weighed, first by him, and afterwards by the superior authority to whom he makes his report. The opponents have thus the satisfaction of knowing that their case has been considered, with probably the same result as if it had been submitted at much cost to a parliamentary committee. There is, therefore, little inducement in ordinary circumstances to appeal directly to the legislature; and, as a consequence probably, an opposition to a provisional order in parliament is exceedingly rare. No doubt, if an opposition on feasible grounds were offered to a provisional order in parliament, the whole subject would be referred to a select committee, who would probably proceed as in the case of an opposed private bill; but that, as has been observed, is of so rare occurrence, that it does not detract from what has been said in regard to the advantages of the system as a rule.

**PRZEMYSŁ**, a town of the Austrian Empire, in the province of Easter Galicia, on the right bank of the San, an affluent of the Vistula, 53 miles west from Lemberg. It is connected by railway with Cracow, and so with the west and north of Germany on the one hand, and with Lemberg on the other. P. is a flourishing town, carries on a considerable trade, and has manufactures of linens and leather. Pop. (1869) 15,400.

**PRZIBRAM**, a town of the Austrian Empire, in Bohemia, 33 miles south-south-west from Prague, on the Litawka, a feeder of the Moldau. It derives its importance chiefly from extensive lead and silver mines in the neighbourhood, and is the seat of a superior court of mines. Pop. (1869) 9299.

**PSEUDOSCOPE** (*pseudos*, false, and *skopein*, to see), an optical instrument invented by Professor Wheatstone, and so called from the fact of its exhibiting objects, viewed through it, under aspects the exact converse of their natural appearance. Its construction is shown by the annexed figure: *abc*, two rectangular prisms of flint-glass, the hypotenuses of which measure  $1\frac{1}{2}$  inch in length, and  $1\frac{1}{4}$  inch in depth. The prisms are hinged at *c*, so that they may be inclined towards each other in any desired degree, and are fixed each in a wooden

framework, fastened together by the hinge or pivot *d*. By means of the pivot *d*, the distance between *c* and *c* may be made to accommodate itself to the different interval between the eyes in various observers. In using the instrument, the eyes are placed at *E* and *E* respectively. The thumb-pieces attached to the prisms at *a* and *a*, are used in adjusting the instrument for distinct vision of any

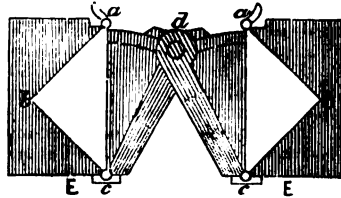

particular object. The optical effect of each prism is twofold: it displaces the object, and it procures the lateral inversion of the image. From the latter circumstance, it follows that the right-hand side of a cube, for example, is seen on the left, and *vice versa*; this inversion being occasioned by the reflection of the rays upon the side of the hypotenuse within each prism. By the two refractions undergone by the rays as they enter and leave the prisms, the axis of the emergent pencil is no longer directed towards the real place of the object, but is diverted in such sort that the convergence of the optic axes *diminishes* as the distance of the object *diminishes*; and *increases* as its distance *increases*—a complete reversal of the ordinary conditions of sight, and one which, in conjunction with the lateral inversion before mentioned, gives rise to very curious visual phenomena. See VISION. It is essential to the efficient use of this instrument that the object be seen by both eyes; and therefore the observer, having placed the object at the usual distance for distinct vision, should, by closing the eyes alternately, ascertain that it is within the field of each prism. He should then adjust the prisms until the two images coincide in point of space, when they will coalesce, and, at first, the object will probably retain its natural aspect; but on a sudden, it undergoes a change, and the converse appearance stands out to view with the utmost distinctness and reality. A hat will appear to be turned completely inside out; the interior of a basin will appear convex and protruding; and 'a bust regarded in front becomes a deep hollow mask.' To facilitate the illusion, the object should be equally illuminated on either side, so as to prevent shadows.—For a full account, see the original paper by Wheatstone, *Phil. Trans.*, 1852, p. 11, *et seq.*

**PUCCINIA**, a genus of fungi, of the division *Oomycetes*, all very small and parasitic on the leaves or stems of plants, within the tissue of which the mycelium creeps. One of the most common species, and the most important, is the CORN MILDEW (*P. graminis*), which is almost always present in corn-fields, and in some years is very injurious to wheat and other cereal crops. It is pitchy brown or black, and grows in irregular lines, somewhat following the venation of the leaf, the lines sometimes confluent. The spores are supposed to find their way from the root upwards, with the juices of the plant on which they vegetate, but this has not yet been proved by observation.

**PUERTO-CABELLO**, or PORTO-CABELLO, a town of Venezuela, in the province of Caracas, 78 miles west from Caracas. It stands on an island in the Golfo Triste, separated from the mainland by a channel so narrow as to be crossed



by a bridge. The situation is very unhealthy, but the harbour is safe and commodious; its imports in 1874 amounted to £667,382; exports, £869,544. P. is the port of Valencia, which is about 20 miles inland. Pop. about 8000.

**PULICAT, PALIKAT, or PALVELAKA'TU**, a town of British India, in the presidency of Madras, and district of Chingleput, 20 miles north from Madras. It stands on an island in a large inlet of the sea or salt-water lake called the Lake of Pulicat. This lake is about 37 miles in length from north to south, and 11 miles in breadth at the widest. It contains a number of islands. The communication between the lake and the sea is by very narrow openings. The lake is much used as affording facilities of traffic by boats between Madras and more northern places. P. was occupied by the Dutch in 1609, and became afterwards the capital of their settlements on the Coromandel coast, but fell into the hands of the British in 1795.

**PULWUL**, a town of British India, in the district of Gurgaon, in the Punjab, 36 miles south-by-east from Delhi, on the route to Muttra. Pop. (1868) 12,629.

**PUNDERPUR, or PANDHARPUR**, a town of British India, in the district of Sholapur, and presidency of Bombay, 90 miles east from Satara, on the right bank of the Bima, a large branch of the Kistna. It is highly revered by the Hindus, on account of a celebrated temple dedicated to an incarnation of Vishnu. Pop. (1872) 16,275.

**PUTEAUX**, a town of France, in the dep. of Seine, at a distance of about two miles from the western boundary of Paris. It is situated on the left bank of the Seine, opposite to the Bois de Boulogne. The situation of P. is a very pleasant one, and many Parisians have fine villas here. The population and industrial activity of the place have of late greatly increased. Pop. (1872) 9491.

**PUTTUN, PATTAN, or ANHULWAR PAT-TAN**, a town of India, in the territory of the Guicowar, Guzerat, 64 miles north-west from Allahabad. It stands on the Saraswati, a small river, which is

a tributary of the Banas; and is a town of considerable importance, having manufactures of swords, spears, pottery of a light fine kind, and silk and cotton goods. P. occupies part of the site of the ancient city of Anhulwara, the traces of the walls of which may still be seen, extending to about five miles in circuit. Pop. estimated at 30,000.

**PYGMIES OF WESTERN AFRICA.** The existence of pygmy races of human beings in Africa has been often asserted, and many circumstances less easily credible than their diminutive size have been reported. See **PYGMIES.** Du Chaillu some time ago discovered the actual existence of a pygmy race, but of whom the diminutive size is the only remarkable characteristic. He found them in the mountainous country on the east of the southern great branch of the Ogobai. They are called Obongos, are about 4½ feet in height, and live in the midst of negro tribes of ordinary stature. They subsist chiefly on animal food, but partly also on the roots, berries, and nuts which they find in the forests. Schweinfurth, in his travels in the heart of Africa, 1868-1871, also came into contact with a nation of pygmies.

**PYNE, LOUISA**, a popular English singer, daughter of a well-known singer, Mr G. Pyne, was born in 1824, received instruction from Sir George Smart, and first appeared in public in London in 1842. She appeared in Paris in 1847, made her *début* in opera in 1849, and has since visited America. She is chiefly known from her being chief soprano of an English opera company, in which she was associated with Mr Harrison at the Lyceum, Drury Lane, and Covent Garden.

**PYRITZ**, a very ancient town of Prussian Pomerania, in the government of Stettin, 25 miles south-east of the town of Stettin. There are standing five high towers on the town-walls, built by the Wends, under whom it was a place of great strength. There is a seminary named after Otto, Bishop of Bamberg, near the spring where it is said he, in 1124, baptised the first Pomeranian converts. P. has manufactures of woollen cloth and leather. Pop. (1871) 7065.

## Q

**QUANG-NAM, KUANG-NAM, or TURON**, a town of Anam, about 75 miles south-east-by-east from Hué (q. v.), or Phu-thuan-thien, the capital of Anam. It is situated near the head of a beautiful gulf, and is a place of considerable trade.

**QUE'DAH, KEDAH, KEDDAH, KEEDAH, or KIDAH**, a half-independent state, on the west coast of the Malay Peninsula, on the Strait of Malacca. It extends from about latitude 5° north, to latitude 7° north, and its average breadth is about 50 miles. The British province Wellesley, which lies between it and the sea-coast opposite to Penang, was separated from it and ceded to the British in 1800, by a treaty in which the British agreed to pay the rajah 10,000 dollars a year. Q. nominally owes a kind of feudal subjection to Siam, but is in reality much more subject to the sway of Britain.—The capital, from which the state takes its name, stands at the mouth

of a river also of the same name, in lat. 6° 6' N., and long. 100° 20' E. Its pop. is estimated at about 21,000.

**QUEENS' COLLEGE, CAMBRIDGE**, was founded in 1446 by Margaret of Anjou, consort of Henry VI., and refounded in 1465 by Elizabeth Woodville, consort of Edward IV. The college consists of a President and 14 foundation Fellows; the fellowships being tenable for ten years from M.A. without being subject to any restriction whatsoever; while any Fellow who takes holy orders, and has not a benefice of the net annual value of £300, may hold his fellowship for life. The new statutes provide that there shall be at least 14 scholarships, tenable till B.A., ranging between £30 and £50; the number and value of the scholarships to be augmented at the discretion of the President and Fellows. Besides these, there are 5 exhibitions, ranging from £12 to £20; and there are funds to the amount of £130 per annum at the disposal of the President, for the behoof of deserving

College holds the patronage of ten benefices in the counties of Bucks, Cambridge, Essex, Leicester, Norfolk, Notts, and Wilts.

**QUEEN'S TOBACCO-PIPE**, the facetious designation of a peculiarly shaped kiln, which is situated in the north-east corner of the Tobacco Warehouses belonging to the London Docks. These warehouses are rented by government at £14,000 annually. The kiln consists of a circular brick stalk, bulging out at the bottom to a width of five feet inside. A side-door of massive iron, lettered 'V. R., the Kiln,' gives access to the interior, in which are piled up damaged tobacco and cigars, and contraband goods, such as tobacco, cigars, tea, &c., which have been smuggled, books which are attempted evasions of the Copyright Act, &c., till a sufficient quantity has accumulated, when the whole is set fire to and consumed. The total value of the goods thus destroyed is enormous; and though this wanton destruction has often been censured, government still persists in the practice of periodically filling and lighting 'the Queen's Pipe.'

**QUESALTEÑA'NGO**, a town of Guatemala, Central America, the capital of a dep. of the same name. It is 66 miles west-by-north from Guatemala,

and carries on a considerable trade. Pop. estimated at from 25,000 to 36,000, largely Indians.

**QUILLO'TA**, a town of Chili, in the province of Valparaiso, and 22 miles north-east from Valparaiso, on the Aconcagua, about 20 miles from its mouth. Q. is a station on the railway from Valparaiso to Santiago, and is a place of some importance and considerable trade, the richest copper-mines of Chili being in its vicinity. To almost every house is attached a vineyard, but no wine is made. Pop. estimated at 10,000.

**QUILO'N** (*Kayan Kulan*), a town of India, in the state Travancore, 35 miles north-west from Trivanderam. It is situated on the sea-coast, in a bight where ships may anchor and have shelter. Q. has a barrack for European troops, a hospital, a jail, &c. There is a considerable export trade in timber, cocoa-nuts, ginger, pepper, &c. The communication with Trivanderam is almost entirely by canals, connecting the lagoons of the *back-water*. There is similar water-communication with towns further northward on the coast. Pop. estimated about 20,000.

## R



**RACALMU'TO**, or **RAGALMUTO**, a town of Sicily, in the province of Girgenti, in an inland situation, on the crest of a hill 12 miles north-east from Girgenti. It is said to be of Saracenic origin. It has a castle, built by Frederick Chiaramonte in the 14th century. Pop. (1871) 11,012.

**RACE**, a term employed in some cases, particularly in the English Channel, to designate the powerful current formed by a rushing tide. Thus, between the island of Alderney and Cape La Hogue, on the coast of France, is the *Race of Alderney*; and off the Isle of Portland, on the coast of Dorsetshire, England, is the *Race of Portland*.

**RAG TRADE**. This trade, even within the limits of a generation, has undergone extraordinary changes. Woollen rags, which some thirty years ago were all allowed to rot on the dunghill, save the very small quantity required for flock papers and stuffing saddlery, are now consumed, under the name of 'shoddy,' to a vast extent in the manufacture of the cheaper woollen cloths, more than 30,000 tons having been imported in 1872; and in the same year, probably a like quantity was obtained in Great Britain itself.

Linen and cotton rags are, as is well known, nearly all consumed in the manufacture of paper; but of late years the demand for paper has increased at so great a rate, especially for the American and colonial markets, that rags can no longer be looked upon as the principal raw material from which it is made. It was stated by Mr Routledge, to whom the country is mainly indebted for the successful introduction of esparto fibre, at a meeting of the London Society of Arts, in December 1871, that rags were now used alone

only for the paper of bank-notes, ledgers, and such-like special purposes, esparto fibre being even preferred as a material for printing-paper. Wood pulp is also largely used on the continent, as well as in America, to mix with rags for all kinds of papers, often forming as much as 70 per cent. of their weight. For some time past, the amount of cotton and linen rags annually imported into Great Britain has been below 20,000 tons; while the imports of esparto and other vegetable fibre reached, in 1876, the amount of 130,911 tons. Moreover, no less a quantity than 22,925 tons of rags and other paper material, but chiefly rags, were exported from British ports, nearly the whole of which went to the United States.

Unfortunately, there seems but too much reason to fear that the regular supply of esparto, as the staple material for paper, cannot be depended upon; and even though it could, rags will always be of great value for the better kinds. According to an estimate published about ten years ago, and which seems to have been accepted as tolerably accurate, 'the continent consumes only 4 lbs. of paper per head of its population, requiring 6 lbs. of paper material for its production; England consumes 8 lbs. of paper per head, requiring 12 lbs. of paper material; and America consumes 10 lbs. of paper per head, requiring 15 lbs. of paper material for its production. At that time, then, the continent had more rags than it required; while both England and America had to import rags to keep their mills going. The state of matters is still the same as regards the continent; but, in the meantime, the increased use of esparto appears to admit of England sending away as many rags as she imports. Most of the imported linen rags come from Germany and France. Cotton, flax, and jute waste from spinning-mills are all used for paper-making.

It is believed that the home supply of linen and cotton rags might be largely increased by greater care in housekeeping economy. Mr Herring, partner in a firm of paper-merchants, and author of several articles on this branch of industry, published, in 1860, a 'Letter,' addressed to clergymen and others, suggesting an organised plan for the attainment of this object. 'There are,' he remarks, 'more rags wasted, burned, or left to rot, than would make our paper-manufacturers independent of all assistance from abroad.' Whatever may have been the case in 1860, it is plain that, however carefully collected, all the rags produced in Great Britain would now be far short of meeting the demands of our paper-mills if no other material were used.

The managers of ragged schools in London organised a *Rag-collecting Brigade* in 1862, which still exists, though diminished of late years.

**RAMNAD**, a town of British India, in the district of Madura, presidency of Madras, 125 miles north-east from Cape Comorin, and about five or six miles from the shore of Palk's Bay. In the centre of the fort is the palace or residence of the semindar, one of the greatest of his class in the south of India, his extensive possessions containing more than 2000 villages, and nearly 300,000 inhabitants. Pop. about 13,000, of whom 6000 dwell within the fort.

**RANDA'ZZO**, a town of Sicily, in the province of Catania, at the base of Mount Etna, and eight miles north-by-west from its summit, on the Cantara. It crowns the summit of a low cliff of lava, and ascends the slope above, with brown battlemented walls and Norman towers, so medieval in its whole appearance, that it has been likened to 'a town of the middle ages preserved as a curiosity.' R. is believed to have been founded by the Lombard adventurers who assisted Count Roger in his conquest of Sicily. Pop. (1871) 7945.

**RANELAGH**, a village forming part of the suburb of Dublin, is situated two miles south from the centre of the city. It consists of one principal street with a square, but is surrounded by villas. The pop. in 1871 was 3209.

**RAVENSBURG**, a town in Württemberg, and capital of a bailiwick of the same name, in the Circle of the Danube, is pleasantly situated in a fertile and romantic valley, the Schussenthal, at the foot of a hill planted with vines. The principal industries are spinning wool and flax, weaving woollen fabrics, linen, and stockings, bleaching, making paper, playing-cards, furniture, wood-work, sawing wood, &c. Pop. (1875) 10,034.

**RECANATI**, a town of Central Italy, in the province of Macerata, on the Musone, 14 miles south from Ancona. It is a station on the railway between Ancona and Rome. R. was a powerful military position in the 11th century: great privileges were bestowed on it by the Emperor Frederick II. in 1229, when the whole line of coast from the Potenza to the Musone was granted to it for the erection of a port. Pop. above 6000.

**REEVES**, SMs, an eminent tenor singer, born at Woolwich in 1821. Before attaining his fourteenth year, he was a clever performer on various instruments, and tolerably well versed in composition; and at that early age he was appointed organist and director of the choir in the church of North Cray in Kent. His musical education was conducted under J. B. Cramer, T. Cooke, and other artists of note. He first appeared in public as a baritone at Newcastle in 1839. His *début* was a complete success; and he acquired fresh fame in Scotland and Ireland. In order to perfect his voice and style, he went to Paris, and after studying there for some time, appeared at Milan in the tenor part

of Edgardo in *Lucia di Lammermoor*, when his singing electrified the audience. He returned to England in 1847, and coming out at Drury Lane as Edgardo, was immediately recognised as the first living English tenor, and was engaged in 1848 at Her Majesty's Theatre. In 1851, he was equally successful as first tenor at the Italian Opera in Paris. One of his best original parts was in Macfarren's opera of *Robin Hood*, produced in 1860.

**REFORM**. The article **REFORM** in the *Encyclopædia*, closes with the withdrawal of Lord John Russell's bill in 1860. No one, remembering amidst what apathy that took place, would have expected, within so few years, to see the subject revive, and assume such large dimensions. Mr Gladstone's speech of 1864 first gave new life, and his declaration, that it lay with those who refused the elective franchise to justify the refusal, sounded the commencement of the new agitation. At the general election of 1865, reform was necessarily much discussed. The death of Lord Palmerston gave the country a ministry in which Lord Russell led the House of Lords, and Mr Gladstone led the House of Commons. This ministry was not long in attacking the subject, and the reform discussions of 1866, so valuable as preparing for the final settlement of the question, commenced. The ministry adopted a suggestion which Mr Bright had made, and tabled first a bill dealing with the franchise alone. Its proposals were of a moderate enough description, its leading provisions being to give the franchise to occupiers of premises of the annual value of £7 in boroughs, and of £14 in counties. At the desire of the opposition, led by Mr Disraeli and Lord Stanley, government introduced its Redistribution of Seats Bill, and the two bills were combined and sent to committee together. In committee, parliament proved unmanageable. Several clauses were carried by the narrowest majorities, till at length, on the comparatively small question, whether 'clear' or 'rateable' annual value should be taken as the basis of the franchise, government was left in a minority of seven. The leaders, true to the traditions of party, resigned, and left the question of reform to the Conservatives.

The resignation was beneficial to progress. In the autumn following it, numerous mass meetings, conducted in general with perfect order, were held; and some unlucky speeches of the opponents of any reduction of the franchise were employed more or less unfairly in order to get a starting-point for the kind of eloquence that such meetings require. It now became plain that the main drawback to reform, the alleged indifference of the working classes, had ceased to exist. Reform therefore became inevitable; and it was equally clear that if reform was to be carried by the Conservatives, the country would not accept from them a measure of the moderate character which it would have gladly taken from the Liberals shortly before.

The meeting of parliament in 1867, it is said, found the ministry of Lord Derby and Mr Disraeli still undecided. But it was necessary to do something. The Queen's Speech accordingly broached the matter; and in the beginning of the session, Mr Disraeli proposed to deal with the subject by way of resolution. His resolutions, however, were vague, and had to be withdrawn. Mr Disraeli then (25th February 1867) made a speech, in which he proposed to bring in a bill, with a £5 rating franchise in boroughs, a £20 rating in counties, and with some of what were called 'fancy' franchises. With the redistribution question, he proposed to deal much as his actual bill afterwards dealt. This proposed bill was understood to be a compromise with a section of the cabinet not

favourably disposed to reform. However, as it did not succeed in making matters smooth, the leaders of the government are said to have reverted to what was their original policy. The dissentients, Lord Carnarvon, Lord Cranborne, and General Peel, then resigned, and (on 18th March) the Reform Bill of 1867 was introduced.

The bill surprised the country. Mr Disraeli has since said that, so far back as 1859, he and Lord Derby came to the conclusion, that if the £10 line, at which the Reform Act of 1832 had fixed the borough franchise, were disturbed, there was no other fixed line tenable; and he has made the further revelation, that he spent the interval between 1859 and 1867 in educating his party to the belief, that if the borough franchise was to be dealt with at all, it must be dealt with in the boldest manner. His bill, therefore, carrying out this policy, proposed that all householders within boroughs who were rated for the payment of poor-rates, should be entitled to vote. There were certain 'securities' attached to this proposal. The householder must have resided two years in the borough, and must have personally paid his rates. Further, the 'fancy franchisees,' which again made their appearance, had coupled with them what was called the 'dual vote,' the object of which was to give to every householder who possessed one of them a second vote in addition to the first, which his house would give him. In counties, the bill proposed a £15 rating franchise, and all existing franchises were permitted to remain. In redistribution of seats, the bill proposed to take the second member from each borough of less than 7000 inhabitants, and to divide these seats, together with the seats taken from the corrupt boroughs, in nearly equal proportions between the larger counties and boroughs, giving one also to London University.

The bill was not permitted to pass without many alterations. Government, either influenced by a sincere desire for reform, or convinced that, as reform was at anyrate unavoidable, it was better that it should pass under their management than under the management of their opponents, were quite resolved that a bill should pass. They yielded to the House whenever they well could, and when they could not, the threat of dissolution at once brought the House to reason. The result of the labours of the session admits of being shortly stated.

The borough franchise remained substantially as at first proposed. Much of the session was lost in devising clauses by which the rating principle could be applied to those tenants whose landlords compounded for their rates. The principle was, however, maintained; and an amendment introduced by Mr Gladstone, with a view of fixing the hard and fast line of £5, was rejected. But by a new clause, the system of compounding was put an end to, so that the franchise was really given to all householders except those excused from rating on the score of poverty. The period of residence, on the motion of Mr Ayrton, was reduced from two years to one. On the motion of Mr McCullagh Torrens, an important addition was made in the shape of the lodger franchise. Mr Disraeli's bill of 1859 had contained a provision of the kind, and something like it was again added. It gives votes to all lodgers who have occupied for a year lodgings which would let unfurnished for £10, and who apply to be put on the roll.

The county franchise was reduced from £15 to £12 rating; and there was added (on Mr Colville's motion) a reduction of the copyhold and leasehold franchise, giving votes to all owners or liferenters of the free annual value of £5 in property other than freehold, which continues to yield a 40s. franchise.

The dual vote was early abandoned, and its abandonment involved that of the 'fancy' franchises. These have now only interest as matters of history; but as the name appears often in the discussions, it should be mentioned that, in their last form, they proposed to give votes to all who paid £1 annually in direct taxes (not including licenses), who belonged to certain of the better educated professions, or who had £50 in a savings-bank or in the funds. Mr Mill's proposal to extend the franchise to women found 73 supporters. The vote by ballot was rejected, equally with the government proposal to take the vote by means of voting-papers.

The comparatively restricted proposals of the government with regard to redistribution of seats were considerably extended. On Mr Laing's amendment, the limit at which boroughs then returning two members should hereafter return only one, was raised from 7000 inhabitants to 10,000. This gave 38 seats to be distributed,\* making, with the 7 seats forfeited for bribery by the boroughs of Lancaster, Yarmouth, Reigate, and Totness, 45 in all. Of these, 25 were given to the larger counties, which were severally divided into two or more districts for the purpose.† To boroughs, 19 new members were given—8 by way of additional members to boroughs already possessing members, and 11 to new boroughs.‡ To the University of London, one member was given. Mr Laing's proposal to make the scheme of redistribution still more extensive, by applying to all boroughs having fewer than 5000 inhabitants the system of grouping which prevails in Wales and Scotland, was rejected.

The only amendment of importance which the House of Lords succeeded in making, was the addition of the system of representation of minorities. By this system, persons voting in London, where four members are returned, cannot vote for more than three; and in the counties and boroughs which return three members, cannot vote for more than two. The object is to prevent a majority which may possibly exceed the minority by only one man, from monopolising the whole representation. The plan appeared first in Lord John Russell's bill of 1854, and having then been unpopular with both sides, does not appear to have been proposed since. Mr Disraeli took occasion, in introducing his bill, to declare himself against it. Mr Lowe proposed to

\* The boroughs from which one member each was taken were Andover, Bodmin, Bridgenorth, Bridport, Buckingham, Chichester, Chippenham, Chipping-Wycombe, Cirencester, Cockermouth, Devizes, Dorchester, Evesham, Great Marlow, Guildford, Harwich, Hartford, Honiton, Huntingdon, Knaresborough, Leominster, Lewes, Lichfield, Ludlow, Lynton, Maldon, Marlborough, New Malton, Newport (Isle of Wight), Poole, Richmond, Ripon, Stamford, Tavistock, Tewkesbury, Thetford, Wells, and Windsor.

† West Kent, North Lancashire, East Surrey (already having two members each), and South Lancashire (already with three members), were subdivided, and two members given to each division, which absorbed 7 seats; and the counties of Chester, Derby, Devon, Essex, Lincoln, Norfolk, Somerset, and Stafford, together with the West Riding (all already in two divisions, with two members each), were divided into three parts, each represented by two members, which absorbed the other 18 seats.

‡ Birmingham, Leeds, Liverpool, Manchester, Merthyr-Tydvil, and Salford got each an additional member. The Tower Hamlets were subdivided, and got two additional members. Chelsea was made a borough, returning two members; and the following boroughs were appointed to return one each: Burnley, Darlington, Dewsbury, Gravesend, the Hartlepoons, Middlesborough, Staleybridge, Stockton, and Wednesbury.

Conservatives, and Mr Mill and Mr Fawcett among the Liberals. Mr Bright joined the government in opposing it, and it was lost by a majority of 141. In the House of Lords, its insertion was again proposed by Lord Cairns, and carried by a very large majority, most of the Conservatives voting for it, against the government. When the Lords' Amendments were considered in the Commons, it was the only one of them which was agreed to. It is hardly necessary to say that a scheme such as that of Mr Hare, for carrying out the principle in a rigorous and complete manner, was found to be far in advance of the day.

The opportunity of passing the Reform Bill was taken to provide for some minor improvements. The inconvenience of having parliament dissolved by the demise of the crown was obviated, and it was provided that ministers of the crown and their subordinates changing from one office to another should not have to submit to re-election. A boundary commission was appointed to re-adjust the boundaries of the boroughs and counties. Mr Fawcett's proposal to throw the necessary expenses of elections, such as the expenses of polling-places, sheriffs, &c., on the borough or county rates, was, however, rejected.

Such is the Reform Act (for England) of 1867. Its passing, in some shape or other, from the temper of the government and its power of controlling the House, was at no time in serious risk. The most critical period was when Mr Coleridge's amendment was brought forward, with the view of making way for Mr Gladstone's amendment of the £5 rating limit; and here the government were served by the defection from the Liberals of 'the tea-room' party—a large number of 'extreme' and 'independent' Liberals, some of whom really preferred the *quasi* household suffrage scheme of the government, and others of whom were only resolved that a bill of some kind should pass. Mr Gladstone's amendment was thus defeated.

Acts similar to the English one were passed for Scotland and Ireland in the session of 1868. The borough franchise for Scotland is substantially the same as for England, being conferred on every man who has for twelve months occupied, as owner or tenant, any dwelling within the borough, except he has been exempted from poor-rates on the ground of inability to pay, or has failed to pay. Scotland has also the £10 lodger franchise. In Scottish counties, proprietorship to the extent of £5 of clear yearly value confers a vote; the limit of the tenant franchise is £14. The Scottish act disfranchised seven English boroughs, and gave seven additional representatives to Scotland—two of these being assigned to the universities, and the rest to the larger towns and counties. The universities of Edinburgh and of St Andrews return one member jointly; as do those of Glasgow and Aberdeen. The Irish act made no alteration in the county franchise, but reduced that of boroughs to a £4 rating occupation.

As thus chosen, the House of Commons was composed, in 1869, of the following representatives:

	Of Counties.	Cities and Boroughs.	Universities.	Total.
England and Wales,	137	297	5	439
Scotland,	32	26	2	60
Ireland,	64	37	2	103
United Kingdom,	233	360	9	602

**REFRIGERATING MACHINES.** Under the head ICE, some notice is given of machines by which it can be prepared artificially; but as the practical importance of refrigerating apparatus is daily increasing, we propose to give here a fuller

simplest and best of those which produce cold by the evaporation of some volatile liquid, we shall describe it first. It is shewn in figures 1 and 2, and consists of two strong cast-iron cylinders A and B, connected together by a metal tube T, all perfectly gas-tight. The whole apparatus is made strong enough to stand seven or eight atmospheres of internal pressure.

The cylinder A is charged with a concentrated aqueous solution of ammoniacal gas. Ammonia is a powerful absorber of heat, and is, moreover, so extremely soluble in water that the latter takes up nearly 700 times its volume of the gas. Air is completely expelled from the apparatus by opening a screw valve and heating the cylinder. It is then ready for use. On applying heat to the cylinder A (fig. 1), which fits into a small stove for the purpose,

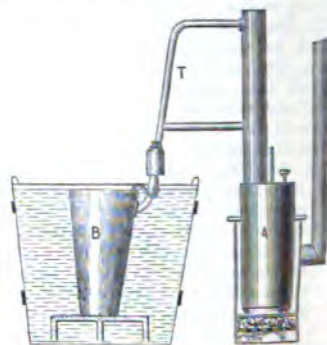

Fig. 1.

the solution of ammonia is volatilised, and carried over and condensed in the cylinder B, which is placed in a vessel containing cold water. The heat reaches to about 220° F., and while it is being applied, the volatilised ammonia condenses into a liquid under very high pressure, produced by its own atmosphere, in the cold cylinder B. When the heating has gone on long enough—about half-an-hour for a small machine—the hot cylinder A, is removed from the fire, and placed in a vessel of cold water, as shewn in fig. 2. The cooling of this

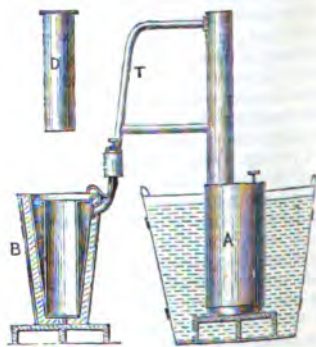

Fig. 2.

cylinder immediately causes the reabsorption, by the removal of the pressure, of the condensed ammonia from the other cylinder B; and as it

intense cold is produced (see HEAT), and, in consequence, heat abstracted from everything in contact with this portion of the apparatus.

The cold cylinder B is shewn in section in fig. 2. It is so constructed that the ammonia is contained in an outer jacket, leaving a hollow space in the centre. When ice is to be made, the latter is filled with salt water or other liquid which does not freeze at 32° F., and into this is placed a loosely fitting metal cylinder D, containing the water to be frozen. In this way, with a small machine for domestic purposes, a few pounds of ice can be made in an hour or two; but large machines, on the same principle, are made which produce 440 lbs. of ice per hour.

An Italian, named Toselli, has recently brought out a modification of Carré's machine, in which the ammonia is volatilised by hot water instead of by a stove. This is considered to be a practically safer and more convenient plan.

There is another excellent refrigerating machine constructed by Mr D. Siebe of London, where ether is used as the volatile fluid instead of ammonia. It operates on essentially the same principle; but a powerful pump, worked by a steam-engine, is used to facilitate the evaporation of the ether. Some machines are also in use which produce

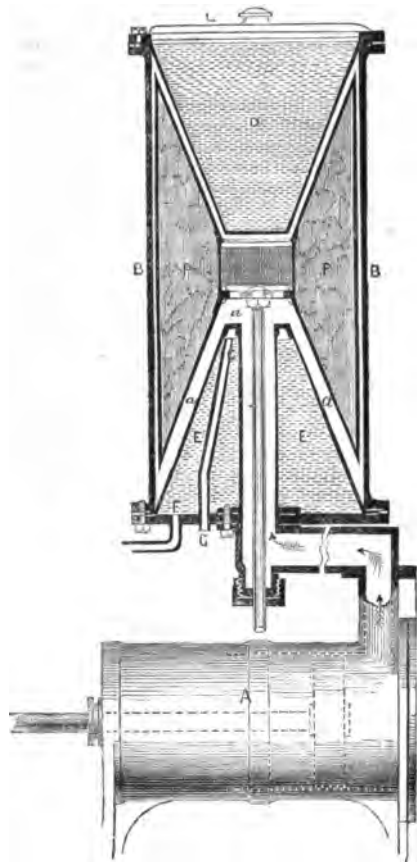

Fig. 3.

ice by means of freezing mixtures; but they are of minor importance.

Mr A. C. Kirk, late of the Bathgate Chemical

experiments with a view to the construction of such an apparatus which would produce cold by the simple expansion and compression of air. He ultimately succeeded in producing a most efficient machine, which he patented on the 25th April 1862, the number of the specification being 1218.

Although it is not strictly true that the mere rarefaction of air produces cold, yet it will simplify the explanation of this machine to assume in the meantime that it does so. Its simplest form is shewn in fig. 3, and consists of a cylinder with a piston to compress air, communicating with another cylinder containing a kind of piston or plunger where the compressed air is cooled and expanded. The machine is driven by a steam-engine, and it may be as well to remark, that the actual relative position of the cylinders is different from that shewn in the diagram, which is given rather to shew the principle of the apparatus than as an accurate representation of it.

The compressed air is forced by the compressing cylinder A, into the refrigerating cylinder BB, just at the moment when the position of the plunger, PP, is close upon the upper cone D. This air, which fills the space *aa*, between the plunger, PP, and the lower cone E, is of course heated by the compression; and in order to cool it again, cold water is made to circulate in the cone E, by an entrance-pipe F, and an exit-pipe at G. The next movement of the machine draws the piston in the cylinder A to the opposite end, and consequently allows the compressed air to expand again; but at the same moment the plunger, PP, descends close upon the cone E, thus allowing the space between the plunger and the upper cone D, to be at its fullest when the expansion of the enclosed air is at its greatest.

By this arrangement, the patentee secures that the air while being compressed will always be at the lower, or what he calls the hot end, of the refrigerating cylinder B; and while being expanded, it will always be at the upper or cold end. There is a regenerator constructed as in the Caloric Engine (q. v.) of wire-gauze, placed in the middle of the plunger at C. This, while it allows the air to move freely through it, prevents the conveyance of heat or cold from one end of the cylinder to the other. The plunger, PP, is filled internally with sawdust or some non-conducting material.

We may now explain that the low temperature of the air which surrounds the cone D during expansion, is not produced by simple rarefaction. That alone would not produce cold. It is necessary as well to abstract heat from the air by giving it some work to do, and here it unavoidably does work, in assisting to force back the piston of the compressing cylinder, while in the act of expanding. The air loses an equivalent of heat exactly in proportion to the amount of force which it expends in moving, or in assisting to move, the piston. See FORCE.

Before air is admitted into the cylinders, it is necessary to dry it thoroughly, by first passing it through a box containing chloride of calcium, because, if any moisture were present, it would freeze in the regenerator, and stop the action of the machine. In the particular form of the apparatus shewn in the figure, the substance to be cooled is placed inside the cone D, which is furnished with a lid L. Here not only water, but even mercury, can be frozen with facility.

Most of the machines of this kind which have as yet been made were required for working on a more extensive scale than the one shewn in fig. 3 could easily do. In the larger-sized machines, accordingly, instead of one hollow cone like D

cylinder, as shown in fig. 4. These form annular passages, through which a continuous current of

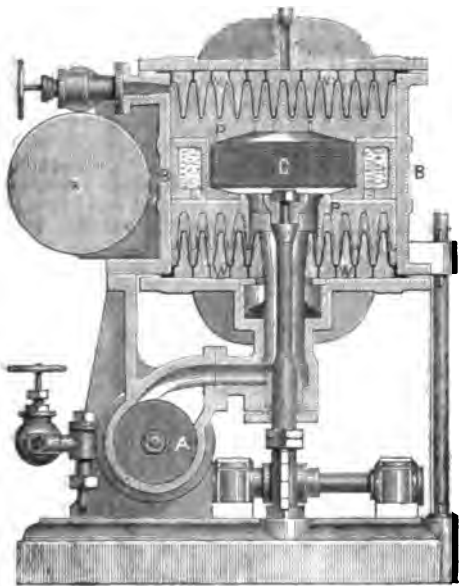

Fig. 4.

some fluid not easily frozen, such as brine, flows. This is of course cooled by the expanded air (in the manner already explained), at the cold end of the cylinder, and can be conveyed away in pipes to cool any substance at a greater or less distance from the machine.

The first machine which Mr Kirk made was designed for the purpose of freezing out the solid paraffin from paraffin oil, and the work actually done by it was found to be equivalent to the production of two tons of ice in 24 hours, one indicated horse-power being consumed for every 212 lbs. of ice made. It was not, however, constructed to work at a greater maximum pressure than 70 lbs. per square inch. One made to work with double this pressure would produce four tons of ice per day, while the cost of it would not be materially increased.

It is only within the last few years that much attention has been given to the construction of machines for the production of artificial cold on the large scale, but there can be little doubt that they will now receive many important applications. There is no difficulty in working with one on Kirk's principle anywhere, because it can be so constructed that even a pair of bellows will compress the air enough. In this country, besides being available for the production of ice; the extraction of certain salts from mixed solutions, such as sulphate of soda from common salt—the former separating at a temperature above that which keeps the latter in solution; the separation of paraffin from mineral oils; and in other chemical operations, as well as for cooling worts in breweries and distilleries, they can also be turned to good account in the salting and preservation of meat. In warmer countries, they will be still more useful, and perhaps most of all in cooling large hospitals and public buildings, by sending a current of some cold liquid through pipes, just as we in Great Britain heat

RE'NI, a town of Moldavia, at the confluence of the Pruth and the Danube, on the left bank of both rivers. It carries on a considerable trade, exporting large quantities of grain. Pop. about 8000.

RETI'MO, a seaport town of the island of Crete, on its north coast, 35 miles west from Candia. The neighbourhood is productive both of oil and wine. Pop. about 6000, of whom two-thirds are Turks, and the rest Greeks.

**REVIVAL'S OF RELIGION.** The term *Revival of Religion*, or, more briefly, *Revival*, is employed to denote an increase of faith and piety in individual Christians, particularly after a period of religious declension, and also an increase of religion in a community or neighbourhood, both through the revival of those who are already religious, and through the conversions of the previously irreligious. In these applications, its use is countenanced by several passages of Scripture; the idea which it is intended to convey is, however, far more frequently suggested by passages in which the term does not occur. The idea of revival is more particularly connected with the system of 'evangelical' doctrine, and particularly with that part of it which relates to the work of the Holy Spirit in the conversion of sinners.

What are commonly called revivals of religion may be described as religious movements or excitements extending, more or less generally, over a neighbourhood, or sometimes over a country. By those who regard them as genuine, it is urged in their favour, that they are in accordance with what the Scriptures teach us to expect, and that we have instances of a similar kind recorded in the Scriptures themselves—both in the history of the Jews, and in the early history of the Christian Church, particularly in the effusion of the Holy Spirit on the day of Pentecost, and afterwards in connection with the ministry of the apostles, when many were converted through a single discourse, or, in other cases, evidently within a short time. It is further urged that the promise of the effusion of the Spirit in 'the latter days' was not completely fulfilled on the day of Pentecost, but relates to the whole period of the Christian dispensation, and that, according to many prophecies, we have reason to expect even more of it in future times than there has ever hitherto been, so that 'a nation shall be born in a day, and the kingdoms shall be the Lord's.' The Reformation of the 16th c. and the more partial movements of the same kind which preceded it, are also regarded as essentially revivals of religion—the Reformation itself the greatest which has taken place since the apostolic age. The great development of religious fervour in England in the 17th c., is, according to this view, to be considered as a revival, and the extravagances which attended it as mere excrescences, like those of the Anabaptists in the time of the Reformation. The next great movement of the same kind was that in the first half of the 18th c., from which the Methodist churches originated (see *METHODISM*). It was accompanied with many circumstances similar to those which have attended later revivals of religion. The term revival did not begin to be commonly employed till after this period; and the revival which took place in New England and other parts of North America about the same time, was then and still is generally designated the *Great Awakening*. The beginning of this revival seems to have had no connection with the Methodist movement in England, although subsequently

visits to North America. The revival in New England, which began about 1734, under the ministry of the celebrated Jonathan Edwards at Northampton, and rapidly extended over great part of New England and New York, was speedily followed by similar religious movements in Scotland, not altogether independent of it. Such religious movements had not, however, been unknown in Scotland before, although very much confined to particular times and localities. In 1625 and some following years, there was a revival at Irvine, under the ministry of Mr David Dickson—a minister of more than ordinary abilities and attainments, some of whose works have recently been republished—so considerable as to be noticed in many histories of the church of Scotland, and which, because it extended very much to the neighbouring parish of Stewarton, and along the banks of the Stewarton Water—the people of that district frequenting Irvine on market-days, and hearing Mr Dickson's lectures—was contemptuously styled by its adversaries the *Stewarton sickness*. In 1630, several hundreds are said to have been converted at once, through a sermon preached at Kirk-of-Shotts by Mr John Livingstone, then a young preacher, but afterwards an eminent minister of the church of Scotland, and a sufferer for the cause of Presbyterianism. About the same time (1623—1641), similar movements took place in Ireland under the ministry of Scottish Presbyterian ministers settled in Ulster, and to which the origin of the Irish Presbyterian Church must in great part be ascribed. The Presbyterians of Scotland were thus in some measure prepared to acknowledge the revivals of the earlier part of the 18th c. as genuine, which began at Cambuslang—Mr M'Culloch being minister of that parish—in 1742, and speedily extended to Kilsyth and other parishes in the neighbourhood, as well as to Dundee and other places more remote. No similar movement, however, took place over the country generally; nor was there anything of the same kind again till the very end of the century, when a revival took place (1798—1800) at Moulin in Perthshire, of which Mr Alexander Stewart was then minister. This was followed in a few years by a revival in Arran (1804—1813), under the ministry of Mr M'Bride. Other similar local revivals followed, not unfrequently, and in parts of Scotland widely remote from each other, both in the Highlands and Lowlands; and also in other parts of Britain, particularly a very extensive one in Wales, resulting in the formation of the Welsh Calvinistic Methodist Church, but not confined in its effects to those who became connected with that church. Local revivals also in some instances attended the ministry of evangelical ministers of the Church of England.

In 1839, the attention of all Scotland was drawn to a religious movement at Kilsyth, which was followed by similar occurrences in a number of other places, more or less evidently connected with it. The first appearance of an unusual degree of religious feeling at Kilsyth was in the parish church, during a sermon by Mr William C. Burns, a son of the minister of the parish, and afterwards a missionary in China. The emotion of many of the congregation broke out in sobs and cries, so that for a time the preacher's voice could scarcely be heard. For months, religion was the almost exclusive subject of interest to a great part of the inhabitants of the parish, and many meetings for public worship were held besides the ordinary Sabbath services, at which great emotion was often displayed. Among the other places to which this movement notably extended was Dundee, where Mr W. C. Burns was then stately employed in the ministry of the

to time in various places in Scotland; but none of great extent or interest there or elsewhere in the British Islands for nearly twenty years. There had, meanwhile, been many revivals in America, generally, indeed, confined to particular congregations, seminaries, or localities, but sometimes extending over considerable districts; and throughout at least the northern and middle parts of the United States, the idea had become familiar to the popular mind, that revivals of religion ought to be expected from time to time; from which naturally followed the belief that means ought to be employed to produce them. From this resulted, in some cases, increased earnestness in preaching and prayer, with greater assiduity in the use of all the ordinary means for the promotion of religion; in other cases, direct endeavours to produce excitement, as by *camp-meetings*—assemblies of great numbers of people held in the open air, at which exciting addresses were delivered by preacher after preacher, to work upon the nervous sensibilities of the audience.

Nothing of this kind, however, attended the commencement of the great religious movement which took place in 1837 and in the two following years. Its origin is ascribed in part to the thoughts and feelings awakened during a period of great commercial distress. It began in New England, particularly in Connecticut and Massachusetts, and rapidly extended to New York and over the middle and western states. It was not generally attended with scenes of great excitement. Strong, but calm religious feeling was its general characteristic. In the city of New York, almost every congregation received a great accession of members, and prayer-meetings were held for about an hour in the middle of the day, which were attended by great numbers of persons actively engaged in business. More than 2000 places in the state of New York were reported as partaking of this revival. Not long after it began in America, a similar movement took place in the north of Ireland, not apparently connected in its origin with that in America, although certainly connected with it soon afterwards, and promoted by the news brought across the Atlantic. It rapidly extended over the whole north of Ireland, and subsequently to many parts of Scotland, Wales, and some parts of England. As a rule, it was free from excitement, and characterised by little else than the intensity of religious feeling displayed. Another remarkable revival, which extended over the greater part of Great Britain in 1874—1875, originated in the efforts of two American evangelists, Messrs Moody and Sankey, and was characterised by the almost entire absence of sensationalism.

Revivals of religion have occurred also in other parts of the world. About fifty years ago, a widespread movement of this kind took place in Switzerland, although not affecting more than a small part of the population anywhere. Under the ministry of Felix Neff, it subsequently extended to the Protestant districts of Dauphiné, and to the neighbouring Valdois or Waldenses, on the Italian side of the Alps. Similar religious movements have occurred in many parts of Sweden.

Revivals have been accounted for in very different ways; but in general, too evidently in mere accordance with the different religious views of those by whom the theories have been proposed. Some have attempted to explain the phenomena of religious excitement extending over wide districts, and rapidly spreading from one place to another, by the supposition of a kind of epidemic disease affecting the mind. Another opinion very prevalently entertained by those who do not see in revivals anything really good, is, that they are



the result of endeavours to work upon the feelings. It is replied, that although this theory might be plausibly enough advanced, if only such things were considered as the camp-meetings of the American Methodists, it is far from being in accordance with the best ascertained facts as to many of the revivals which have taken place both in America and in other countries. It is certain that many of these have taken place without any apparent attempt to work upon the feelings, more than is ordinary and proper in the preaching of the gospel, and that the greatest display of emotion has often been connected with preaching of the most simple and sober kind.—By those who believe in the reality of revivals, as productive of a true increase of religion, they are generally ascribed to the operation of the Holy Spirit, to which, according to the 'evangelical' scheme, the 'conversion' of every individual soul is ascribed, and also all increase of faith and piety in the converted. Revivals have, however, often been regarded with doubt by many who believe in the whole doctrine of the work of the Spirit as generally held in the Protestant churches, but who look upon the excitement frequently attending them as inconsistent with the proper sobriety and solemnity of religion, and think the progress of religion ought rather to be expected to be gradual, and without very much to call particular attention to it at one time more than another. It is replied, that whilst a blessing on the regular use of ordinances may confidently be expected, if duly sought by prayer, there is yet much in Scripture to favour the notion that particular seasons may be unusually marked by the evidence of it; and further, that revivals, when they take place, generally shew the usefulness of the ordinary means employed for the promotion of religion, as they seldom occur among persons very ignorant of religion, but rather among those who have previously enjoyed the benefit of the most faithful ministrations. With regard to the excitement attending many revivals, it is argued that this excitement is not wonderful, if persons are suddenly impressed with a deep sense of their sins, of the danger of divine wrath, and of the importance of religion; and that it is in some measure also to be expected in those who are brought by a quick transition from deep distress to a full sense of forgiveness and the favour of God. Are we to be surprised, it is asked, if persons in such circumstances, after much effort of self-restraint, cry aloud in the congregation, or fall down, overpowered by their emotions? It is sometimes alleged by the opponents of revivals, as an objection to them, that much of the excitement manifested in them is merely hysterical; and some of their advocates have rashly denied that this is the case; others, admitting it, deny that it affords any just cause of objection, and maintain that hysterical excitement is natural and unavoidable in such circumstances, and however undesirable in itself, is a manifestation of the reality and strength of the feelings awakened. They acknowledge, however, also, that like similar excitement produced by causes which have nothing to do with religion, it may extend from one to another, even where the cause in which it originated does not operate; and they therefore refuse to see in it, considered by itself, any evidence of the religious or spiritual condition of the persons affected by it.

That much folly and extravagance have often been exhibited in connection with revivals of religion, is freely admitted by many who are fully convinced of their reality; but this, they say, is also only what might be expected, as the occasion always seems a favourable and inviting one to persons whose zeal exceeds their discretion, and too often affords

opportunity for ignorant and self-conceited persons to thrust themselves forward as teachers and conductors of religious exercises.

It may be proper to advert to some of the practices which sometimes take place on occasions of revival, but which are disapproved by all except those who are filled with the desire of seeing excitement produced and increased. Among these is the bringing forward of persons in the character of new converts, to conduct prayer in public, and to address meetings, which they are often among the least capable of doing well. Another practice liable to much objection is the permitting of mere youths, under profession of Christian zeal, to converse in private with persons in distress of mind, especially when these are young persons of the other sex. A third objectionable practice is the calling upon those who are anxious about their salvation to come forward and occupy a place by themselves—or what are called in America *anxious seats*—that they may be individually conversed with, and that special prayer may be made for them, they being thus brought into a publicity which is undesirable. It is hardly necessary to refer to the absurdity of demanding—as has sometimes been done—a show of hands from those who are now resolved to give themselves to the Lord! With such uncommendable practices may be classed that of encouraging persons who have been of very profligate life to recount their own history, which has sometimes been carried so far, that they have seemed even to glory in the enormity of their past wickedness.

Certain peculiar modes of expression, which might not unaptly be designated a kind of slang, have often come into use in connection with revivals of religion, with the unhappy effect of exciting disgust in many minds, and particularly among the most educated classes of society. Thus, in the revival of last century in New England, the objects of the revival—in a certain state of their experience—were spoken of as being *filled*. In the recent revival in Ireland, it was common to speak of those who fell down suddenly in congregations or in their own houses as *stricken*, and as the *stricken ones*. It was very common during the same revival to speak of individuals as having *found peace*; and this finding of peace was by some regarded as proof of conversion, or even as indicating the moment of conversion—all which was considered by many who fully believed in the reality of the revival, as unscriptural and delusive.

Among the evils acknowledged to attend revivals by those who believe them to be real, but who also believe that there is often much connected with them which is not the work of God, is the disposition to judge of the spiritual state of individuals, as converted or unconverted. *New converts*, especially when brought into undue prominence, are apt to become elated and self-satisfied, and even to regard themselves as the only true Christians, or as superior to those whose piety is of much longer standing than their own. This, however, is not always the case, and much depends on the judicious or injudicious conduct of the ministers chiefly concerned when a revival takes place.

We have endeavoured to present this subject fairly to our readers; but it is evident that as to the opinion to be formed by any one, much must depend upon the general religious views which he entertains. As to mere religious excitement, however, and bodily affections resulting from it, many facts may be adduced to shew, what might be supposed beforehand, that these may be connected with religious views extremely at variance. Excitement may be produced by religious views that are utterly false, as well as by those which are true. Heathenism

of Rome as well as in the Protestant churches. It is not necessary to do more than allude to the extravagances of the Flagellants, and to the strange scenes of the Dancing Mania. Some of the small sects, also, which evangelical Protestants regard as most heterodox, seem to maintain their existence by a systematic working up of excitement.

The subject of this article has been treated in a multitude of publications, almost every revival which takes place calling forth new pamphlets, narrative and controversial. The works of Jonathan Edwards deserve the first attention of those who wish to study the subject; and much information as to the history of revivals will be found in Gillies's *Historical Collections relating to Remarkable Periods of the Success of the Gospel*. Reference may also be made to Mrs Lundie's work on *Revivals in the British Isles*; and for the revivals in Scotland in the middle of the 18th c., to Robe's *Narrative of the Revival of Religion at Kilsyth, Cambuslang, and other Places in 1742* (new ed., Glasgow, 1840). Edwards maintains the genuineness of revivals with perhaps more force of argument than any writer has since done; and most of those extravagances which have sometimes attended revivals down to the present time, might have been avoided if those whose religious views accord with his had more carefully studied his discriminating remarks and sober counsels. No work has yet been produced such as Edwards in one of his letters expresses a strong desire to see—a history of true, vital, and experimental religion, and enthusiasm, bringing down the history from age to age, judiciously and clearly making the distinction between the one and the other.

RE'WAH, a state of India, called also BAGHEL-CUND, lying between the North-western and the Central Provinces, subsidiary to the government of the latter, and having for its capital a town of the same name, which is 70 miles south-west from Allahabad, and stands on the right bank of the Tons. The town has a pop. of about 7000. It exhibits remains of former magnificence, but even the walls and the rajah's palace are much decayed. The state has an area of about 13,000 sq. m., and great part of it is well cultivated. The pop. is about 2,035,000.

RHEYDT, a town of Rhenish Prussia, on the left bank of the Niers, and on the railway between Düsseldorf and Aix-la-Chapelle, 14 miles west-by-south from Düsseldorf. It has manufactures of silks and velvets, soap, glue, vinegar, and leather; it has also dyeworks, and some trade in linen. Pop. (1875) 15,857.

RICORD, PHILIP, a distinguished French physician, was the son of a wealthy ship-owner, and was born on the 10th of December 1800, at Baltimore, whither his father had gone in 1790, to repair his fortunes, which he had lost under the India Company. He came in 1820 to Paris, where he was attached in succession to the Hôtel-Dieu under Dupuytren, and to the Pitié under Lisfranc. He graduated as Doctor in Medicine in 1826; but was unable, from the scantiness of his private means, to begin practice in Paris. His professional career, therefore, commenced at Olivet, near Orleans, and was thence transferred to Croty-sur-Ouroq, where he rapidly rose to distinction as a practitioner. In 1823, he returned to Paris, where he delivered two annual courses of lectures at the Pitié on surgical operations; and was appointed surgeon-in-chief to the hospital for venereal diseases. This post he held with brilliant success till his retirement in October 1860. It was here that he won his world-wide

accurate physiological and pathological knowledge, with great manual dexterity as a surgeon, and felicitous inventiveness and resource as a physician. He did much to improve the classification of enthetic diseases; and, at the Venereal Hospital delivered annually, from 1834, a course of lectures on Syphilology, for which a special amphitheatre was granted to him. For his suggestions on the cure of varicocele and on the operation of urethroplasty, he received in 1842 one of the Montyon prizes. M. R.'s practice is the most extensive and the most lucrative in Paris, insomuch that while an inmate of the debtors' prison at Clichy, he was literally besieged by crowds of patients. He has been since 1850 Member of the Academy of Medicine (section of Surgical Pathology); Member of the Surgical Society; and consulting-surgeon to the Dispensary of Public Health. In 1862, he was appointed Physician in Ordinary to Prince Napoleon; and in 1869, consulting surgeon to the late emperor; having already on the 12th of August 1860 been raised to the distinction of Commander of the Legion of Honour. His works are numerous, the more important of them being these: *On the Employment of the Speculum Biviale* (1833), invented by himself; *On the Bleorrhagia of the Female* (1834); *On the Employment of Mercurial Ointment in the Treatment of Erysipelas* (1836); *Treatise on Venereal Maladies* (1838); *On Bleorrhagic Ophthalmia* (1842); *Iconographical Clinic of the Venereal Hospital* (1842—1851); and *On Syphilisation and the Contagion from Secondary Accidents* (1853). He has also contributed to the medical journals a multitude of Memoirs, Observations, Researches, and Communications on his speciality. His latest work is that entitled *Letters on Syphilis* (3d ed. 1857), which, from their fluency and grace of style, have earned for him the name of the Marivaux of medicine.

RIE'SI, a town of Sicily, in the province of Caltanissetta, and 13 miles south from Caltanissetta. It is situated at the base of a mountain of the same name, not far from the left bank of the Salso. There are sulphur-mines in the mountain. Pop. (1871) 11,548.

RIOBAMBA, a town of Ecuador, 100 miles south from Quito, situated among the Andes, on an affluent of the Pastasa, a large branch of the Amazon. It is sometimes called New R., having been built instead of a former town of the same name, which was destroyed by an earthquake in 1797, and the ruins of which are 9 miles distant, at the foot of Chimborazo. Pop. about 16,000, in great part consisting of Indians.

RISTORI, ADELAIDE, a celebrated Italian tragic actress, was born in 1821 at Cividale in Frioul. Her parents were strolling players, and she almost began life in the theatre. At the age of 14, she played in *Francesca da Rimini*, and in a few years became the leading Italian actress. Her talents, her beauty, and her grace made her a universal favourite. In 1847, her marriage with the Marquis Capranica del Grillo (who died in 1861) temporarily interrupted her dramatic career; but after two years, she returned to the stage, and appeared at Rome in 1849 in Alfieri's tragedy of *Myrrha*. But the French attack on the city caused her to desert the theatre for the hospital, where she employed herself assiduously in nursing the wounded. After having acted in 1850 and succeeding years at Rome

French audience in 1855, when Rachel was in the height of her fame, a proceeding considered in the light of a challenge by the first Italian actress to the first French actress. Even at Paris she obtained a triumph, her genius creating an enthusiasm which could not be repressed. Without all the sympathetic sensibility of Madame Rachel, she surpassed her in vivacity and expansion. She has since appeared with success in England, the United States, &c.

**RITUALISM**, the name popularly but inaccurately given to the remarkable increase of ceremonial in the Church of England since the year 1863. It may be considered as a development of Tractarianism, though it is one not contemplated by the authors of that movement, whose aim was rather to disseminate doctrines than to introduce ritual changes. Its collateral causes may be said to be: (1) The great advance of æsthetic taste, and the increased cultivation of the fine arts in the service of religion. (2) The extended study by the clergy of ancient liturgies, and the connection discovered to exist between them and the offices of the English Church. With the spread of High Church principles, certain changes in the mode of conducting divine service had been introduced by the clergy, which, though unpopular at first, were widely adopted, and up to a certain point, had received the sanction of the law. But the restored church with low and open benches—the separated chancel—the altar-table with coverings of different colour according to the ecclesiastical seasons, and candlesticks, and a cross upon or over it—choral services, and weekly celebration of the communion, were all that had hitherto been attempted. To these comparatively small alterations, important additions have recently been made—viz. (1) Special vestments at the celebration of the holy communion, and at certain other times, viz. for the celebrant, an alb and stoles, of different colour, and chasuble; for the assisting ministers, albs with tunicles, according to the seasons. At other times, a cope is worn instead of a chasuble. (2) Lighted candles on the altar at holy communion. (3) Incense burned either in a 'thurible' or in a standing vessel. (4) The mixing of water with wine for the communion. (5) The use of wafer-bread. (6) Elevation of the elements either during or after consecration. (7) The attendance of non-communicants at the holy communion. (8) Processions with crosses, banners, and vested attendants.

These innovations are defended by their promoters on the following grounds of (a) Law, (b) Doctrine, and (c) Expediency.

(a) The rubric at the end of the calendar in the Book of Common Prayer enacts 'that such ornaments of the church and of the ministers thereof at all times of their ministration shall be retained and be in use as were in this Church of England by the authority of parliament in the second year of the reign of King Edward VI.' The Judicial Committee of the Privy Council in the case of *Westerton v. Liddell* (1857), ruled that 'ornaments' here means, 'all articles used in divine service'; that the words 'by authority of parliament,' &c., refer to the first Prayer-book put forth in that reign (1549); and that 'the meaning of the rubric, as of the previous statute of Elizabeth, the language of which it adopts, is, that the same dresses, utensils, and articles which were used under the first Prayer-book of Edward VI. may still be used.' Now, the first Prayer-book of Edward VI. prescribes that at the time of the communion 'the priest that shall execute the holy ministry shall put on him a white alb plain with a

ministry, that is to say, albs with tunicles.' It is therefore inferred that the above are the only legal vestments in which the holy communion should be celebrated. To this it is objected (1) That the word 'retained' can only refer to such vestures as were in use up to the time of the last publication of the rubric—viz. the surplice in parish churches, and copes in cathedrals. (2) That the rubric, when first inserted under Elizabeth, was limited by the Injunctions and Advertisements of that reign, which aimed only at the restoration of the surplice. (3) That whatever be the intention of the rubric, it has been so long obsolete that it is absurd to revive it. It is answered (1) That the word 'retained' must have the same meaning that it had in the rubric of Elizabeth, in which it first occurs. (2) That the Injunctions and Advertisements were not of supreme authority, and were only intended to help towards restoring a decent uniformity in divine worship. (3) That the fact that a law has become obsolete does not invalidate its force. The same reference of the ornaments rubric to the second year of Edward VI. is held to authorise other accessories known to have been in use at that time, though not specified in the first Prayer-book—such as lighted candles, incense, &c. And on the principle, that the Reformed Church was legally identical with that before the Reformation—which the 30th canon of 1603 is cited as maintaining—it is further contended that all ancient laws and usages are still in force, except where directly or implicitly abrogated by subsequent enactment. And as the chief ritual authority before the Reformation was the liturgy of Sarum (the Sarum 'use' referred to in the preface to the present Prayer-book), it is to that standard, as far as possible, that the more advanced Ritualists desire to conform.

(b) The doctrinal grounds of defence are expressed in the following statements: (1) The Eucharist (as the Lord's Supper was anciently called) is the special institution of Christ, the single rite of continual observance which He enjoined on His disciples, and the chief act of Christian worship. It is therefore right to exalt and dignify it above all other services, and mark it as standing on different and higher ground than any other institution. (2) The Eucharist, according to the universal belief of the ancient church, is to be regarded as a sacrifice, commemorative, as the Jewish sacrifices were anticipatory, of the death of Christ—not as iterating or repeating it (which idea alone the 31st article is held to condemn), but as a solemn pleading and offering of it before God, as Christ himself offers it in heaven. Hence the position of the celebrant in front of the altar, and the use of a sacrificial vestment, as the chasuble is held to be. (3) In the Eucharist, there is a real presence of Christ, which, though spiritual, is objective, i. e., not dependent on the receiver, but as a result of consecration, and to a certain extent local. (The growth of this belief is marked by the change made in a recent edition of Keble's *Christian Year* of the words, 'not in the hands,' in a poem on the Eucharist, to, 'as in the hands.') Hence distinct acts of adoration, addressed, not, as is explained, to the elements, but to the Divine Presence, of which they are the vehicles and signs.

(c) On the ground of expediency also, it is contended: (1) That experience proves that the only way of attracting and gaining a hold on the vast undedicated masses of our towns and cities is by a worship addressed not merely to the ear, but to the eye. 'Ritualism,' says one of its defenders, 'is the object-lesson of religion.' Services conducted in grand and

and every outward token of reverence and solemnity, will impress the young and the poor as nothing else can do. Those churches in London where advanced ritual prevails are said to be thronged with worshippers—mainly of the lower classes, and in great proportion of men—when others are almost empty. (2) A further argument, under this head, is connected with the desire, which has grown up of late years among the High Church party, for the restoration of the visible unity of Christendom, and specially the renewal of communion between the Church of England and both the Eastern and the rest of the Western Church; and with this view, it has become an avowed object to assimilate the Anglican service as much as possible to that of other Catholic churches.

It remains to notice briefly the effect of these innovations. It is a remarkable index of the change of popular feeling within the last ten years, that such bold and startling changes, altering the whole character of the Anglican service, should, by a large number of people be not only tolerated, but approved. In 1859, the attempt of the rector of St George's-in-the-East to introduce Eucharistic vestments, led to riots which convulsed the whole of East London. In the year 1867, in about twelve churches of the metropolis—and in several country towns and villages—a far more advanced ritual, with vestments, altar-lights, and other ceremonies, appears to attract an eager throng, not of spectators only, but of worshippers. And the spread of the movement may be judged by the statement, which appears authorised by facts, that since the publication of the first Report of the Royal Commissioners on Ritual, the vestments have been introduced in more than thirty churches. On the other hand, among the 'Protestant' members of the church, and those of other denominations, the movement has provoked the loudest opposition. Most of the bishops have, directly or indirectly, expressed their disapprobation; the press, except two or three journals, which are its strenuous advocates, is almost unanimous in denouncing it; the more moderate members of the High Church party discourage it; and active efforts have been made to arrest it by legislative interference. In the Lower House of Convocation, on the motion of the Dean of Ely, a committee was appointed to consider the subject, which, after careful examination, reported, in June 1866, that vestments and altar-lights, whether legal or not, should not be introduced without sanction of the bishop; that the censuring of persons and things, elevation after consecration, wafer-bread, and presence of non-communicants (except in special cases), were to be discouraged. In deference to this opinion, the censuring of persons and things has been in some churches given up. Suits were instituted against several individuals—the Rev. A. H. Mackonochie, incumbent of St Albans, London; the Rev. T. B. Simpson, in the diocese of Essex, and others. The points complained of in these are chiefly elevation and the mixed chalice. In the beginning of the year 1866, an opinion was obtained, at the instance of some of the bishops, from five eminent counsel, among whom were Sir R. Palmer and Sir Hugh (now Lord) Cairns, against the legality of all ritualistic innovations (the main grounds of which opinion are given in the *objections* above stated). In reply to this, another opinion was obtained, by the Council of the English Church Union, from nine leading counsel—some of whom have since been raised to the bench—all of whom advise in favour of the legality of vestments, all but two

equally divided.

In the session of 1867, the Earl of Shaftesbury introduced a bill—founded on the 56th canon of 1603—to limit ecclesiastical vestments to the ordinary surplice and hood, in favour of which more than 600 petitions were presented; while one against it, presented by Lord Redesdale, was signed by more than 9000 clergy and lay communicants. (An earlier memorial, to the Archbishop of Canterbury, against any change in the existing law, was signed by more than 40,000 communicant members of the church.) This bill was withdrawn on the appointment by the government of a Commission 'to inquire into the Rubrics, Orders, and Directions for regulating the course and conduct of Public Worship, &c., according to the use of the United Church of England and Ireland.' The commissioners included the Archbishops of Canterbury and Armagh, and the Bishops of London, St Davids, Oxford, and Gloucester. They published a report to the effect that 'it is expedient to restrain, in the public services of the church, all variations in respect of vesture from that which has long been the established usage of the said church; and that this may be best secured by providing aggrieved parishioners with an easy and effectual process for complaint and redress.' The evidence appended to the report supplies much information as to the various practices prevailing, and the widely different views entertained. The general conclusions appear to be that vestments, and probably altar-lights and the mixed chalice, are legal; that an ornate ritual is useful among some classes, and might, with certain safeguards, be allowed; that absolute uniformity is impossible, but that the law might be obeyed a good deal more generally than it is; that the maintenance of the present law, with a wide and liberal interpretation, but limited as a maximum to the ritual of the 2d year of Edward VI., with some recognised ecclesiastical authority to restrain unauthorised variations, would be most for the welfare of the church. The report produced no restraint on the progress of Ritualism, and in May 1873, 60,000 persons of standing and influence presented an address to the two archbishops requesting them to adopt means for checking the growth of ritualistic practices. In April 1874, a bill for this purpose was introduced in the House of Lords by the Archbishop of Canterbury, entitled The Public Worship Regulation Act. It was adopted by the government, but was opposed in the House of Commons by Mr Gladstone in a series of six resolutions, and notwithstanding a considerable amount of ecclesiastical agitation, it became law in August. Its main provision is the appointment of a judge for the trial of ritualistic cases. A complaint against the use of vestments, ornaments, and rites and ceremonies, or the omission of such as are ordained in the Book of Common Prayer, in the churches or burial-grounds of the Church of England, may be presented to the bishop of the diocese by an archdeacon or churchwarden, or by three parishioners, members of the church, of full age, and a year's residence in the parish. In the event of the parties not submitting to the directions of the bishop, he shall forward the case for trial by the judge, from whose decision an appeal lies to the Privy Council.

RI'ZAH, a town of Asiatic Turkey, in the pashalic of Trebizond, on the coast of the Black Sea, 40 m. E. from Trebizond, with considerable trade, and manufactures of fine hempen fabrics. Pop. 30,000.

ROBERTS, DAVID, R.A., a painter of great

eminence, was born at Edinburgh on 24th October 1796, and began life there as apprentice to a house-painter. His talent for art becoming obvious, he was set to study at the Trustees' Academy; and in 1822 he went to London, where he found employment as a scene-painter at Drury Lane Theatre. Clarkson Stanfield, since famous as a marine-painter, was then also working at Drury Lane, and between him and R. an affectionate intimacy ensued, which ceased only with life. In 1826, a picture of 'Ronen Cathedral,' exhibited by R. at the Royal Academy, drew attention by its marked ability. The year after, appeared his painting of 'St Germain's at Amiens.' Shortly after, he left England, and for seven years was engaged in sketching in Spain, Africa, and the East. As the result of his labours, there was given to the world in 1839 the splendid work, in 4 vols., entitled *Sketches in the Holy Land, Syria, Idumæa, Arabia, Egypt, and Nubia*. The book contains 246 subjects, lithographed by Louis Hague, and illustrated by a historical commentary furnished by Dr Croly. It is the finest and most elaborate thing of the kind perhaps ever produced, and of itself it would have sufficed for a great reputation to the artist. Pending its appearance, he had resumed his contributions to the Academy, of which in 1839 he was elected an Associate; the full dignity of Academician being conferred on him two years after. From this time forward, he grew steadily in fame, and in 1854 he was selected by the Queen to paint for her the 'Inauguration of the Great Exhibition in 1851;' a task which he achieved with admirable success. In his chosen field of architecture, during all his later life, he was admittedly without a rival. In addition to his unremitting work for the Academy, he illustrated many books, and issued the admirable series of lithographs, 'Spanish Sketches,' which attained a great popularity. He died November 25, 1864.

ROBERTSON, JOSEPH, the most accomplished Scottish antiquary of the present century, was born at Aberdeen on the 17th day of May 1810. He was educated at Udny, in his native county, at the grammar-school of Aberdeen, and afterwards at the Marischal College there. The law was chosen for him as his profession, but his heart was not in the task, and from an early age he devoted himself to literature. His chief attention then, as in his after life, was directed to researches connected with the history and antiquities of Scotland; and in 1833 he went to Edinburgh, the place of all others best adapted for the cultivation of his favourite studies. While there, he wrote, for Oliver and Boyd's Cabinet Cyclopædia, a volume on the *Circumnavigation of the Globe*, which was published in 1836. The work by which he became first generally known, *The Book of Bon-accord, or a Guide to the City of Aberdeen*, was published in 1839. It is justly styled by Mr Charles Knight, in his *Life of Shakspeare*, 'a most lively, instructive, and learned volume—a model of guide-books.' A continuation of this work was promised, but was never completed. In the following year, his *Delicia Litterariae, a new volume of Table-talk*, was published. In 1839, he returned to the north to undertake the editorship of the *Aberdeen Constitutional* newspaper; and in the end of that year, in conjunction with Mr John Stuart, he founded the Spalding Club, a society instituted for printing the historical, ecclesiastical, genealogical, topographical, and literary remains of the north-eastern counties of Scotland. This society, formed on the model of the Bannatyne and Maitland Clubs, has printed many valuable works on Scottish archæology, which otherwise would have been all but inaccessible. Its earliest publication was a *History of Scots Affairs from 1637 to 1841*,

written by James Gordon, parson of Rothiemay, which was issued in three vols. in 1841, under the joint editorship of Mr R. and Mr Grub. R. edited for the same Club a volume of *Collections for a History of the Shires of Aberdeen and Banff* (1843); three vols. of *Illustrations of the Topography and Antiquities of the Shires of Aberdeen and Banff* (1847, 1857, and 1862); and *Passages from the Diary of General Patrick Gordon of Auchleuchries* (1859). He also contributed to the fifth volume of the Miscellany of the Club, in 1852, a learned paper *On Scholastic Offices in the Scottish Church in the 12th and 13th Centuries*. In 1843, R. went to Glasgow to become editor of the *Glasgow Constitutional* newspaper. While in that city, he edited for the Maitland Club, in 1846, a volume containing the *Book of the Collegiate Church of St Mary and St Anne, Glasgow*, and the *Chartulary of the Black Friars of Glasgow*; and in 1847, the fourth volume of the Miscellany of the Club. In June 1849, he contributed to the *Quarterly Review* an article on Scottish Abbeys and Cathedrals, which has become a text-book for all who write on that subject. In the same year he once more took up his residence in the Scottish metropolis, on being appointed editor of the *Edinburgh Evening Courant*. He discharged his editorial duties at Aberdeen, Glasgow, and Edinburgh with faithfulness and ability; but he found a more congenial occupation, when, in 1853, he was appointed, through the Earl of Aberdeen, who knew and appreciated his merits, to the office which is now known as that of Curator of the Historical Department of the Register-house at Edinburgh. In 1863, he edited for the Bannatyne Club the *Catalogues of the Jewels, Dresses, Furniture, Books, and Paintings of Mary Queen of Scots*. This volume contains a Preface which forms a most valuable contribution to the history of Mary's reign, and supplies information on almost all the controversies connected with her life. With the sanction and zealous encouragement of Sir William Gibson-Craig, Lord Clerk-register of Scotland, he projected the publication of a series of works connected with the history of Scotland, similar to those which have appeared in England under the direction of the Master of the Rolls. The first volume of the series, the *Chronicles of the Picts and Scots*, has been edited by Mr Skene, and several others have since been published. R. assisted in other literary undertakings, and was a valuable contributor to this *Encyclopedia*. His articles are generally connected with his favourite studies; among them are those on ARCHÆOLOGY, BURGH, ST COLUMBA, CRANNOGES, the CULDEES, DAVID I, the FAMILY OF DOUGLAS, IONA, MARY STEWART, and OSSIAN. The last and most important of R.'s works was his *Concilia Scotiæ*, printed in two vols., in 1866, for the Bannatyne Club. This work has done for the Scottish Church that which Archdeacon Wilkins did for the Church of England in his *Concilia Magnæ Britannia et Hiberniæ*. It contains the statutes of all the Scottish councils, whether provincial or diocesan, from the earliest period to the Reformation, printed carefully from the best authorities; and the Preface, which occupies the greater part of the first volume, is a learned and authentic history of the councils, and of everything bearing on the subject of them. The authorities are quoted with an accuracy and copiousness for which R. was remarkable, and which contrasts strongly with the carelessness in that respect which marks some popular historians of the present day. In April 1864, R. received the degree of LL.D. from the University of Edinburgh. He died on December 13, 1866, almost immediately after the publication of his *Concilia Scotiæ*. R.'s labours are

merit published during the last twenty years of his life, in connection with Scottish history and antiquities, to which he did not in some way or other give his assistance; and his assistance was given with a thorough heartiness which only those who have benefited by it can appreciate. No literary man of his time was more beloved by his friends and intimate associates. In the relations of private life, he was most exemplary.

RO'BIN, besides being a familiar name of the Redbreast (q. v.) in Britain, and frequently given to the Bluebird (q. v.) in America, is also in America the usual name of a species of Thrush (q. v.) widely distributed from Mexico to lat. 60° N. It is nearly twice the size of the redbreast, olive gray, the top and sides of the head black, the chin and throat white with black streaks, the under parts chestnut brown. It remains during winter in sheltered places, even as far north as New England, but is generally a bird of passage. Many arrive in New England before the snow has disappeared. Large flocks are to be seen in the Southern States in winter, where great numbers are killed for the table, the markets being often glutted with them. In Massachusetts, the law forbids the killing of this bird at any season of the year. Its nest is often built near houses. Two broods are produced in the year. The robin is a lively bird, and a general favourite in the northern parts of the United States. It is often kept as a cage-bird, is very gentle and easily tamed, and has a pleasing song.

ROHTU'K, a town of British India, the capital of the district of the same name, in the division of Hissar, Punjab, 42 miles north-west from Delhi. A canal or water-course, 45 miles long, constructed by order of the British government in 1825, supplies R. and the neighbouring country with water from the great Feroze-shah Canal. Pop. (1868) 14,153.

RONDELET, WILLIAM, a French naturalist, born at Montpellier in 1507; died 1566. He became a medical practitioner in Montpellier, and professor in the medical school there. He was a zealous student of natural history, and particularly distinguished himself in ichthyology. His *Histoire entière des Poissons* (Lyon, 1558) was one of the first works which contributed much to the progress of that branch of science.

ROSARIO, a town of the Argentine Republic, on the right bank of the Parana, 170 miles north-west from Buenos Ayres, 210 miles by river. It is the most important town on the Parana, and is rapidly increasing in population and commerce. The customs duties amount to considerably over £140,000 a year. In 1874 the value of merchandise imported direct was \$7,046,400; of the exports, \$2,101,100, of which \$1,073,540 consisted of wool, hides, &c., sent to the United States. Pop. above 40,000.

ROSSIENY, a town of European Russia, in the government of Kovno, 66 miles north-west from Kovno, on the Dubitzka, a branch of the Niemen. Under the Polish government, it was the capital of Samogitia. Pop. (1867) 10,732.

ROTA, a town of Spain, in the province of Cadiz, and six miles north-north-west from Cadiz, on the opposite side of the entrance of Cadiz Bay. Rota wine has acquired some celebrity, and is brought to the British market. Pop. 8000.

ROTATION OF CROPS. The plants like the animals of the farm differ much in their habits, and

whilst the narrower-leaved grains and grasses, especially if their seeds are ripened, partake more largely of mineral food withdrawn from the soil. The cereals require for their healthy nutrition large supplies of phosphoric acid and silica; leguminous plants devour a large share of lime; turnips, carrots, and clover take up a great amount of potash. Corn-crops, occupying the ground during the greater part of the year, favour the growth of weeds; well-tended root-crops, on the other hand, afford better opportunity for deep culture, for the extirpation of weeds, for the convenient application of manures; whilst, being in great part consumed on the land, they raise its fertility. Mainly from such considerations, the farmer of arable land is led to grow a succession of dissimilar plants, or, in other words, to adopt a rotation of crops. The cereals exhausting the farm, on account of their ripened seeds being sold off, are generally alternated with fallow, root, or cleansing crops, or with beans and peas, which occupy a kind of intermediate position between the cereals and the roots; whilst clovers or grasses are taken at intervals of six or eight years. The rotation most suitable for a particular farm is, however, greatly modified by various circumstances, and especially by the nature of the soil, climate, markets, available supplies of extra manures, amount of live-stock kept, &c. That course of cropping is evidently the most desirable which will economically secure, with thorough cleanness of the soil, a high and increasing state of fertility.

Many rotations are based upon the Norfolk or four-course system, which consists of (1) Clover or mixed grass seeds; (2) Wheat, or in many parts of Scotland, oats; (3) Turnips, Swedes, mangold, potatoes, or bare fallow; (4) Barley. The details of this system are generally as follows. The clovers or grasses are mown or grazed; when cut, they are either used green or are dried for hay; the second crop is carted home for the cattle or horses; near towns, it is sold off; or it is consumed on the ground in racks by sheep, which on most highly cultivated farms receive besides a daily allowance of cake or corn. In districts where town-manure can be obtained, a top dressing is applied as soon as the first crop of grass is cut. On the poor and worse cultivated soils, the grass-crop occasionally remains down for two, or even three years, thus extending a four into a five or six years' rotation. The clovers or mixed seeds are ploughed up in autumn, and followed generally in England by wheat, and in Scotland by oats. These crops are now usually drilled, to admit of horse and hand hoeing. After harvest, the stubble is, if possible, cleaned by the scarifier, grubber, or plough and harrows; or, where the management for several years has been good, any patches of couch-grass or other weeds are best forked out by hand. The land, especially if heavy, or intended for mangold drilled on the flat, as practised in the drier parts of England, may then be manured and deeply ploughed: the grubber and harrows, in April or May, suffice to prepare for the drilling of mangold or Swedes. Heavy land, intended either for roots or barley, should, in spring, be ploughed or disturbed as little as possible. In Scotland, and the cooler moist climates of the north and west of England, turnips and potatoes are grown on raised drills or balks, in which the manure lies immediately underneath the plant. Frequent horse and hand hoeings should insure the thorough cleaning of the crop. Unless in the neighbourhood of towns, where it is greatly more

cattle, but the largest portion is consumed by sheep in the field. After the fallow or cleaning crop, another cereal crop is grown: under the Norfolk system, this is generally barley, with which the clovers or seeds are sown out. Where sewage or tank water is available, Italian rye-grass is often used, and on land in high condition, early large and repeated cuttings are obtained; but rye-grass has the disadvantage of being a worse preparation than clover for the wheat-crop which usually follows. The chief failing of the four-course system consists in the frequent recurrence of clover, which cannot be successfully grown oftener than once in six or eight years. To obviate this difficulty, one-half of the clover quarter is now often put under beans, peas, or vetches, thus keeping the grass or clover seeds eight years apart.

The Norfolk four-course system is unsuitable for heavy land, where a large breadth of roots cannot be profitably grown, and where their place, as a cleaning crop, is taken by bare fallow, vetches, or pulse. Bare fallows are, however, less frequent than formerly, being now confined to the most refractory of clays, or to subjects that are so hopelessly full of weeds as to require for their extirpation several weeks of summer weather, and the repeated use of the steam or horse ploughs, the scarifier, grubber, and harrows. In such circumstances, winter vetches are often put in during September or October, are eaten off by sheep and horses in June or July, and the land afterwards cleaned: this practice is extensively pursued on the heavier lands in the midland and southern counties of England. In such localities, the following system is approved—(1) The clover leas are seeded with (2) wheat; then come (3) beans, pulse, or vetches, manured, horse or hand hood; (4) On good land, wheat succeeds; (5) Oats or barley often follow, but, to prevent undue exhaustion of plant-food, this system requires considerable outlay in artificial manures, cake, and corn; (6) A fallow, or fallow crop, deeply and thoroughly cultivated, and well manured, comes to restore cleanness and fertility; (7) Barley or wheat is drilled, and amongst this, the clover-seeds are sown. On the heavier carse-lands in Scotland, the following plan of cropping is generally practised—(1) Clover; (2) Oats; (3) Beans; (4) Wheat; (5) Bare fallow or fallow crop, usually including a considerable breadth of potatoes; (6) Wheat; (7) Barley, with which the clovers or mixed grasses are sown. Under this system, it is difficult, with so few cleaning crops, to keep the land clean; roots, besides, are not produced in quantities sufficient properly to supply either cattle or sheep during the winter. To remedy these defects, roots may be introduced after the oats, and would be followed either by wheat or barley. This extends the rotation from seven to nine years.

In all well-cultivated districts, whether of heavy or light land, stock-farming is extending, and a more vigorous effort is being made to raise the fertility of the land. Root-crops are accordingly more largely grown; indeed, it is sometimes found profitable to grow two root-crops consecutively; thus, after turnips, Swedes, cabbage, or mangold, well manured from the town or farmyard, and eaten off by sheep, potatoes of superior quality are produced with one ploughing, and a dose of portable manure. Specialities of management occur in almost every locality. In Essex, winter-beans follow wheat, are got off in August, and are succeeded by common turnips. Near London, and in other southern districts, early potatoes or peas are grown for market, and are immediately followed by turnips. In many parts of England, where the soil and

then put in.

Good rotations do not necessarily insure good farming; they are merely means to an end. By carefully removing weeds, by deeply stirring the soil, and by applying appropriate manures, wheat may be grown on the same soil for an indefinite number of years. At Lois-Weedon, in Northamptonshire, the Rev. S. Smith has for twenty years cultivated alternate three-foot strips of wheat and well-forked bare fallow; the land that is wheat this year being fallowed next. Although no manure whatever is applied, and only one-half of the experimental plot is each year under crop, the yield continues to stand at four quarters per acre, which is about four bushels per acre in excess of the average acreable produce of Great Britain. The Lois-Weedon system, owing to the outlay which it entails for manual labour, probably could not be carried out with profit on a large scale. It demonstrates, however, the inherent resources lying dormant, especially in clay-soils, and indicates how they may be rendered available by thorough cultivation. It is mainly by such cultivation that steam-power proves so serviceable in our fields. The soil is turned up deeply to the disintegrating solvent influences of wind and weather; the necessary operations are rapidly overtaken in good season; much work is accomplished in autumn; treading and poaching of the surface is avoided; whilst a larger breadth of roots is attainable for the healthy and economical support of the sheep and cattle stock, which not only directly enhance the returns of the farm, but also raise rapidly its manurial condition.

As agricultural education and enterprise extend, fixed rotations will be less regarded. The market-gardener, who extracts a great deal more from his land than the farmer has hitherto been able to do, does not adhere to any definite system of cropping. If the farm is kept clean and in improving condition, there can be no harm in growing whatever crops it is adapted to produce. Cropping classes are only requisite during the three or four last years of a tenancy. The restrictions found in some agreements, preventing the growth of clover for seed, flax, and even potatoes, are inadmissible. Equally objectionable are clauses against the sale of particular sorts of produce, such as hay or roots. The farmer, if he is fit to be intrusted with the use of the land, ought to be permitted to grow or sell off any crop he pleases, provided an equivalent in manure be brought back. On well-cultivated land, in good condition, it is now the practice of the best farmers to take oats or barley after wheat; indeed, some of the best malting barley in Essex, on the Scottish carse-lands, and elsewhere, is now grown after wheat. The frequent growth of cereals, and the heaviest of hay and root crops, even when removed from the farm, may be fairly compensated for by large doses of town-dung or of sewage. The plant-food disposed of in the more ordinary sales of the farm is economically restored by the use of bones or superphosphate, guano or nitrate of soda, or by keeping plenty of sheep, penning them over the land, and supplying them liberally with cake and corn.

**ROTTLERA**, a genus of trees of the natural order *Euphorbiaceae*, with a 3-5 parted calyx, no corolla, 30-40 stamens springing from the convex receptacle, and a 2-4 coccous capsule, each portion having one seed. The species are rather small trees, found in India and other tropical parts of Asia. *R. tetraococa* grows in Sylhet, and yields a hard and valuable timber. *R. tinctoria* is a native of India,

which, when rubbed on, have the appearance of a fine red powder, are used in India for dyeing silks scarlet and orange, and form an article of commerce in that country. Professor Anderson of Glasgow has examined this dye-stuff, and in the *Edinburgh Philosophical Journal* for April 1855, has stated his opinion that it merits the attention of silk-dyers. The colour which it yields is of great beauty and great stability.

**ROUHER, Eugène**, a very eminent French statesman, was born at Riom, on November 30, 1814. He first distinguished himself as an advocate at the bar of his native town, at which he practised up to 1848. The attention of the country was first drawn to him by the ability he shewed in a press prosecution, in which he was engaged for the defence. In 1848, he was returned by the department of Puy-de-Dôme to the Constituent Assembly, which was summoned after the revolution of that year, and in the following year he was returned to the Corps Législatif by the same department. On the break-up of Odillon Barrot's cabinet, the first ministry of Louis Napoleon, towards the end of 1849, R. was appointed Minister of Justice; and with slight interruptions, he has been since then a member of the French government. In the Corps Législatif, he shewed himself a moderate politician; and he never affected to consider the Republic an improvement on the constitutional system which had preceded it. In 1852, he was appointed Vice-president of the Council of State, with the oversight of the departments of Legislation, Justice, and Foreign Affairs. In 1855, he was appointed Minister of Agriculture, Commerce, and Public Works, and in this office he found extraordinary opportunities for the exercise of his administrative ability. In the negotiation of the Treaty of Commerce with England, which—much derided both in France and in England at first—is now admitted to have conferred immense advantages upon both countries, the negotiations were conducted by M. R. and M. Baroche on the part of France, by Lord Cowley and Mr Cobden on the part of England; the treaty was signed on January 22, 1860. The arrangements consequent upon the treaty involved immense labour and manipulation of details, and the chief part in adjusting them devolved upon M. R. and Mr Cobden. In 1863, he negotiated a Treaty of Commerce between France and Italy, receiving from the king of Italy, in acknowledgment of his merits, the Orders of St Maurice and St Lazaire. He has thus been the chief instrument in the introduction, or in preparing the way for the introduction, of free trade as the commercial policy of France and the neighbouring continental countries.

In June 1863, M. R. retired from the ministry of Agriculture and Commerce, and was appointed President of the Council of State in succession to M. Baroche. Soon after, he took the office of Minister of the Interior; and in October 1863, on the death of M. Billault, he was appointed Minister of State. In this office, he had to represent the government as 'talking-minister' in the Corps Législatif; and it is admitted that he had no superior as a debater among the great orators trained under the constitutional system, and these were able rivals. His reputation as a debater stands as high as his reputation as an administrator; and it may safely be said that he has no superior, if any equal, for ability among the French politicians of the time. In January 1867, when the late emperor, by a decree, introduced certain modifications of the privileges of the Corps Législatif, and of the relations between that body and the ministers, M. R.,

was appointed a member of the French Senate on the 18th of June 1856. He became Grand Officer of the Legion of Honour in 1856, and gained the Grand Cross in January 1860. He was returned to the National Assembly for Corsica in 1872.

**ROUND-FISH** (*Coregonus quadrilateralis*; see **COREGONUS**), a fish found in the western parts of North America, from Vancouver's Island northwards, in the rivers on the western side of the Rocky Mountains, and in the Mackenzie and Coppermine rivers. It ascends the rivers in summer to spawn, spending part of its life, like the salmon, in the sea. It is a beautiful fish; seldom more than two pounds in weight, of a yellowish-brown colour, paler on the sides and belly than on the back, with bright and glittering scales, each of which is edged with a narrow band of dark gray; the mouth very small, no teeth perceptible. Before spawning, it is loaded with fat, which, on the shoulders, almost amounts to a hump; but after spawning, it becomes thin, and its flesh watery and insipid. In a good state, it is a very delicious fish, rivalling in excellence its congener, the Whitefish (q. v.). This fish is an important article of food to the Indians of North-western America, and vast numbers are caught in the rivers as they ascend from the sea. They ascend in such numbers that no ordinary contrivances of fishing are necessary, but the fish are baled out by baskets, little nets, wooden bowls, or even by the hand. They are cured by splitting and drying, like salmon. The R. readily takes a rough gandy fly.

**ROVU'MA**, a river of South-east Africa, which enters the Indian Ocean by a spacious bay north of Cape Delgado. Only a small portion near its mouth was known to Europeans till 1861, when Drs Livingstone and Kirk attempted its ascent in the small steamer *Pioneer*, drawing five feet water. The river was then in flood, and had a strong current. After an ascent of 30 miles, the difficulties of the passage induced the explorers to return. Another ascent was made by the same party during the dry season of 1862. With two ships' boats, they reached the rapids which limit the navigation, above 100 miles from the coast, and half-way to the Nyassa Lake.

Passing through gloomy, unhealthy forests of mangroves, they entered a healthy plain, covered with heavy timber and brilliantly flaming tropical plants; but the country was infested by the 'tsetse fly,' a serious obstacle to its development. The river abounded with hippopotami. The travellers came within two days of the town of N'gomano, where all the caravans cross the R., but could not leave the boats in order to reach it. Here the R. is joined by the Niende, a large affluent from the hills on the south-west; while the main stream comes from the west and north-west. As the R. is navigable for only a few months of the year, it offers little advantage for commerce; but it affords an excellent entrance by which to explore the regions between the Nyassa and Tanganyika lakes. During his last African journey, Dr Livingstone and his party left Zanzibar in March 1866. Owing to the swampy state of the country, the party landed 25 miles north of the R., and striking south-south-west across the country to that river, followed it to the point where it is joined by the Leonde from the mountains on the south-west, near the eastern shore of Lake Nyassa. On their arrival at N'gomano, the travellers found the country destitute of provisions, a tribe of Mazitè having swept away all the food found above ground. Dr Livingstone



Nyassa; and the last authentic news of him received for a long time was from a letter dated thence on the 18th May 1866. See LIVINGSTONE, for the proceedings of that great traveller from the time he was at N'gomano till his death in 1873.

ROYER-COLLARD, PIERRE-PAUL, a French statesman, born 21st June 1763, at Sompuis (Marne). The childhood of R. was spent at his father's house, under the severe surveillance of his mother, who belonged to a family ardently devoted to Jansenism. He was sent to college at Chaumont, and afterwards at Saint-Omer, which was superintended by one of his uncles, the Abbé Collard. Having passed as advocate at an early age, he pleaded several times before the old parliament; but from the first days of the Revolution he was involved in the events of that time, having been elected one of the representatives of the commune of Paris. From 1790 to 1792, he acted as joint-secretary of the municipality. It was then that he was connected with Pétion and Danton. The events of the 31st May obliged him to remove from Paris. He then returned to Sompuis, and lived in obscurity during the whole time of the Reign of Terror, studying and following the plough himself, to evade the suspicions of the Jacobins. Three years afterwards, in 1797, the electors of this department chose him to represent them in the Council of the Five Hundred. R. took an active part in the work of that assembly. He was one of those honest men who, preferring monarchy, but fearing a violent counter-revolution, consented to try the republic with a moderate government, cherishing the hope, in the meantime, of an ultimate restoration. The 18th Fructidor completely opened his eyes and dispelled his illusions. It was then that he turned his thoughts to what he believed to be the only hope of France, and that he began a correspondence with Louis XVIII., which, however, ceased towards the epoch of the establishment of the Empire. For some years afterwards, he ceased to have anything to do with politics, and entered on another career. He was offered the chair of Philosophy (1809) by Napoleon, in the recently created University of France, which he accepted after great hesitation. Applying himself vigorously to study for it, he was soon highly qualified to fulfil his duties. In the few years he occupied this chair, he exercised an immense influence on the philosophy of France. Rejecting the purely sensuous system of Condillac, he proceeded eclectically, giving special prominence to the principles of the Scottish school of Reid and Stewart. He originated the 'Doctrinaire' school, of which Jouffroy and Cousin were the chief representatives.

The Restoration deprived the cause of education of the services of Royer-Collard. The Bourbons did not overlook the man who had not ceased, since 1798, to maintain their cause; but R., who had all along dreamed of the union of hereditary monarchy with an enlightened liberty, was ill fitted to act with the royalist fanatics now dominant in France.

R. was appointed President of the Commission of Public Instruction (15th August 1815), which office he held, with the title of Councillor of State, till July 1820. He gave in his resignation at that time, not wishing to associate himself with the politics of the ministry. In 1815, the electors of Marne chose him to represent them in the famous 'Chambre Introuvable' (q. v. in SUPPLEMENT). He took part in all the business of the Chamber, remaining steadfastly attached to the king, but energetically opposing the *ultra* party. In the next parliament, he rejected, with great energy, the idea of confiding public instruction to the clergy. 'The university,

and the army that of the public force.' At the end of the session 1817, R., for the first time, withdrew from the government, at least from the course pursued by the ministry. He once more supported it in a new discussion against the predominance of the Catholic Church; but dating from 1819, the rupture was complete. He presented then the singular spectacle of a devoted royalist seconding the efforts of the Liberals. The French Academy opened its doors to him in 1827; and in 1828, he was named President of the Chamber of Representatives. As President, R. had to present the famous address of the 221 deputies (March 1830), refusing their support to the government, which the king refused to hear read. Next day, the Chamber was prorogued. R. departed for Châteaueux, his country-seat, where he went to conceal fears and regrets which the revolution of July was to justify. He was re-elected in June 1830, and he accepted this mandate. In 1842, he withdrew from parliamentary life, and after that lived in great retirement.

Although R. had a considerable fortune, he never departed from the greatest simplicity, excepting for three things—the purchase of books, charity, and the receptions which his official position imposed on him. He received with politeness, but with a certain coldness which he could never lay aside. His salon was very much frequented by the political world. Every Sunday, the principal leaders of the moderate opposition assembled there: it was a large room, serving as a study, the walls of which were hidden from top to bottom by shelves loaded with books; not a single ornament—no fine furniture—what was strictly necessary, and no more. There assembled Cousin, the most eminent of his pupils; Guizot, the Duke de Broglie, Casimir Prier, De Barante, Villemain, Ampère, Andral, De Rémusat, De Barthélemy, Gabriel, and many others. There was little conversation, properly so called; the slow and sonorous voice of R. was dominant in the room. The subjects were almost always the political events and the debates in parliament; the acts of the government were not spared. This salon was the echo of the Liberal world.

From 1842, R. had completely withdrawn from public life, his health, in fact, not allowing him to occupy himself with public matters. He spent only the winter in Paris, returning in summer to his estate of Châteaueux, where he died, 4th September 1845.

R. is undoubtedly one of the most noted men of the 19th century. He exercised on his contemporaries a powerful influence, owing more, perhaps, to the uprightness, firmness, and extreme earnestness of his character, than to intellectual power or genius. Excepting his political speeches, published in the *Moniteur*, R. left few published works. A lecture on External Perception appeared in 1813; and his smaller contributions to philosophy are to be found in Jouffroy's translation of Reid's works (Par. 1836).

RSHEW, or RJEV, a town of European Russia, in the government of Tver, and 80 miles south-west from Tver, on the Volga, which passes through it. It is a place of much commerce, has salt and corn magazines, and two great annual fairs. Pop. (1867) 17,528.

RUE'LLIA, a genus of plants of the natural order *Acanthaceae*, natives of tropical and subtropical parts of Asia and Australia. Some of them are very beautiful, and are common ornaments of our hothouses. In some parts of China, especially in the province of Che-kiang, and on the mountains

*indigofera*, is much cultivated for the excellent indigo which it yields. It is also a native of Assam, and is cultivated there.—See *Fortune's Residence among the Chinese*.

**RUMA'NIA** (often written **ROUMANIA**). See the article **MOLDAVIA AND WALACHIA**, to which this short notice serves as a continuation and conclusion. A military revolt took place in February 1866, which resulted in the deposition of Prince Couza—Alexander John I. The Count of Flanders, younger brother of Leopold II. of Belgium, was unanimously chosen Hospodar; but he at once declined the perilous honour. Upon this, the choice of the Rumanians fell upon Prince Charles of Hohenzollern-Sigmaringen, who was proclaimed Prince of R. on April 20, 1866. The existing constitution was then adopted. When war broke out between Russia and Turkey in April 1877, R. signed a convention with Russia, guaranteeing the Russian troops a free passage through Rumanian territory; and on May 21 the Chamber of Deputies at Bucharest decreed the independence of R. War was declared with Turkey; and the Rumanian army bore a creditable part in several battles, especially before Plevna. The treaty concluded in March 1878, between Russia and Turkey, stipulated for recognition of the independence of R., and for certain changes of the Rumanian frontier towards Russia and Turkey.

**RU'SSIAS**, ALL THE, the official designation of the Russian empire in Europe, was assumed in 1654, when the Czar Alexei Mikailowitch styled himself for the first time 'Tzar of All the Russias,' after his conquest of Little Russia and acquisition of Smolensk from Poland. This phrase at first included only Great Russia, White Russia, and Little Russia. *Great Russia*, formerly called Muscovy, which is by far the largest of these three divisions, includes the territory now comprehended in the 19 governments of Archangel, Olonez, Vologda, Novgorod, Tver, Jaroslav, Kostroma, Pskov, Smo-

Kalouga, Toula, Riazan, Tambov, Orel, Kourak, and Voronetz.—*White Russia* included the provinces of Vitebsk, Mohilev, and the rest of Smolensk, and though long held by the Poles, was re-united to Russia at the first and second partitions of Poland (1772 and 1793). In 1793, it also received the accession of the Polish provinces which now form the governments of Vilna, Minsk, Kovno, Volhynia, Podolek; and White Russia with these accessions was then denominated *West Russia*.—*Little Russia* contains the ancient Russian possessions in the south-west, which, in the middle ages, became independent under the Cossacks of the Ukraine, and were finally reunited to Russia in 1654; and is divided into the four provinces of Kiev, Tchernigov, Poltava, and Kharkov. During the 18th c., the countries wrested from the Turks, lying between Great Russia and the Black Sea, were formed into a fourth great division, under the name of *Southern Russia*. This last includes the districts occupied by the Don Cossacks, sometimes called *New Russia*.—*Red Russia* was a portion of the Russian principality of Galich (Galicia), and with the rest of it, was subdued by Casimir III. of Poland; it included what is now the province of Lublin, in the kingdom of Poland, and the eastern portion of Austrian Galicia, between Lublin and the Carpathian Mountains, and is inhabited by Poles, and another and antagonistic people, who are called indifferently Red Russians, Russniaks, and *Ruthenes*.

**RU'TÉ**, a town of Spain, in the province of Cordova, and 43 miles south-east from Cordova, on an affluent of the Jenil. Pop. 8000.

**RUVIGADO**, a town of the United States of Colombia, South America, in the department of Cundinamarca, in a mountainous district, on one of the head-waters of the Magdalena, in N. lat. 6° 10', and W. long. 75° 42'. It is 8901 feet above the sea. The chief importance of the town is as a centre of trade for a large neighbourhood. Pop. 10,000.

## S

**S**AARLOU'IS, a town of Rhenish Prussia, 31 miles south-south-east from Treves, and between four and five miles from the frontier of France. It stands on the left bank of the Saar, a branch of the Moselle, and is a place of some strength, being walled, and containing several forts. It is of considerable importance as a border fortress. There are manufactures of firearms in the town, and lead and iron mines in the neighbourhood. There are also wire-works. S. was long in the possession of France, and was fortified by Vauban in the reign of Louis XIV. The Congress of Vienna gave it to Prussia in 1815. Pop. (1871) 7080.

**SA'GUA-LA-GRANDE**, a town of Cuba, on the river Sagua, about 12 miles from its mouth, which is on the north coast of the island. It is a town of considerable importance, and is connected by railway with Villa Clara and other places. Pop. about 10,000.

**SAGUENAY**, a large river of Canada, falling into the estuary of the St Lawrence, on the north side, about 115 miles below Quebec. It drains the Lake of St John, which is nearly circular, and almost 30 miles in diameter. Its course from that lake to the Gulf of St Lawrence is about 100 miles, and is almost a straight line. It flows between precipitous cliffs, has numerous cataracts in its upper part, and is in many places two or three miles broad. In the lower part of its course, it is less wide, but very deep, and large ships ascend it more than 60 miles to load with timber from the settlements on its banks. The name S. is sometimes also given to the principal river which falls into Lake St John, and which is known to the Indians as the Chomouchouan and as the Assouapmoussin. It rises about 200 miles to the west of Lake St John. The average depth in mid-channel is 145 fathoms.

**SAHARANPUR**, or **SUHURUNPUR**, a town of British India, North-west Provinces, the chief place of a district of the same name. It is situated

large fort, a military cantonment, and a government dépôt. S. is about 1000 feet above the sea, and the climate is temperate during great part of the year. S. was therefore chosen as a suitable situation for a botanic garden, for plants requiring a milder climate than that of Calcutta, and one was formed in 1817. S. is described as one of the most handsome British stations in India. Pop. (1871) 44,119.

ST ALBAN HALL, OXFORD, takes its name from Robert de St Alban, a citizen of Oxford, who conveyed the building to the nuns of Littlemore, near Oxford, in 1230. On the dissolution of the nunnery, it was given by King Henry VIII to his physician, George Owen, D.M., who conveyed it to Lord Williams of Thame, and Sir John Gresham. By their assignees, it was finally transferred to the Warden and Fellows of Merton College, and was some time after established as an academical Hall. The principal of this, as well as of the other four halls, is assisted in his duties by a vice-principal and other officers appointed by himself.

SAINTE-BEUVE, CHARLES-AUGUSTIN, a French poet and critic of great eminence, was born at Boulogne-sur-Mer, on 23d December 1804. His father, who died two months before his birth, was *principal des droits réunis* at that port. His mother, a woman of superior character and intelligence, was by family originally English, and through her the boy early acquired a familiarity with the English language and literature. He was educated at an institution of his native place, and afterwards at the Collège Charlemagne in Paris. On leaving college, though his bent towards literature was already pronounced, he was shy of committing himself to it as a profession, and betook himself to the study of medicine and anatomy. Shortly, he obtained a situation at the Hospital St Louis. Here for some time he worked steadily; but his spare time was occupied with literature; and his articles contributed to the *Globe* on topics of history, philosophy, and criticism, attracted attention, and in particular procured him the acquaintance of the celebrated M. Jouffroy. While he was thus wavering between literature and the claims of a profession distasteful to him, Victor Hugo's *Odes et Ballades* were published, and the impression made upon him by this work, of which he wrote an enthusiastic *critique*, seems to have determined him finally to a life exclusively literary. He gave up his situation at the hospital, and attached himself to *Le Cénacle*, along with Alfred de Musset, the two Deschamps, and others of the so-called Romantic School. Shortly, he gave to the world his *Tableau Historique et Critique de la Poésie Française, au XVI.° Siècle* (1828—afterwards enlarged in ed. 1843), which at once established his reputation as one of the first critics of the time. His next work, *Les Poésies de Joseph Delorme*, though somewhat coolly received by the public, brought him what perhaps pleased him better than any applause of the multitude, the emphatic approval of Béranger and others of the literary guild. *Les Consolations*, published in 1830, was considerably more successful in hitting the taste of the public. On the cessation of *Le Cénacle*, after the revolution of 1830, S. attached himself to the *Globe*; and subsequently, he wrote much in the *Revue des Deux Mondes*, the *National*, and the *Constitutionnel*. In 1834, appeared his *Volupté*, a work curious as a study of moral pathology, but more curious than pleasing; and in 1840, he published the first volume of his *Histoire de Port Royal*, a work which, in 1860, he completed in

fall to a Frenchman of letters, by his election to be a member of the Academy. In 1850, he began to issue, in the pages of the *Constitutionnel*, the famous series entitled *Causeries de Lundi*, the most delightful of all his works, and that by which he is most widely known. After the *coup d'état* of 2d December 1851, he became connected with the *Moniteur*, and was appointed Professor of Latin Poetry at the Collège de France. Of this appointment some fruits are before the world in his *L'Etude sur Virgile*, published in 1857. In 1865, he was called to be a member of the Senate. He died November 1869.

As a poet, S., despite the fine talent he displayed, never succeeded in becoming popular, nor can very high rank be accorded him. But as critic, he was 'himself alone,' and his place is by common consent in the very fore-front of French literature. His sympathies were wide and catholic; in delicacy of perception, and subtlety of refined analysis, he was almost without a rival; his style is piquant, lively, fascinating, instinct with individual expressiveness; and nothing can exceed the felicity with which the interest of criticism proper is combined in his sketches with that of anecdotic biography.

Of his works not already glanced at, the following only need be mentioned: *Poésies Complètes* (1840); *Critiques et Portraits Littéraires* (1852—1839); *Portraits Littéraires* (1844); *Portraits Contemporains*; *Causeries de Lundi* (1851—1857); *Nouveaux Lundis* (1863); *Souvenirs et Indescriptions. Le Dîner du Vendredi-Saint* (1872). A selection from the *Causeries de Lundi* has been translated into English, with an introduction, under the title *English Portraits* (1875).—See C. A. Sainte-Beuve, *sa Vie et ses Œuvres*, by D'Haussonville (1875); and an article in No. 281 of the *Quart. Rev.*

SAINTE-CLAIRE DEVILLE, HENRI ETIENNE, French chemist, was born in March 1818, at St Thomas, West Indies, and was educated in France. On quitting college, he constructed at his own cost a chemical laboratory, and for nine years, without master and without pupils, devoted himself to patient studies and skilful researches. In 1844, he was commissioned to organise the Faculty of Sciences of Besançon, of which, in the following year, he was appointed Dean and Professor. In 1851, he succeeded M. Balard in the chair of Chemistry in the École Normale. Since 1853, he has supplied the place of M. Dumas in the Faculty of Sciences of Paris. In 1861, he was chosen a member of the Academy of Sciences of the Institute, in place of M. Berthier in the section of Mineralogy.

S. D.'s earliest investigations relate to different essences and resins, and the most important are in the department of mineral chemistry. In 1849, he made known the mode of preparation and the properties of anhydrous nitric acid, a compound whose existence had been up to that date ignored. In 1852, he published an important paper on Metallic Carbonates and their Combinations; and in the following year, a new method of mineral analysis, known as the middle way, in which he proposes the exclusive employment of gases and volatile re-agents, against the errors arising from the use of the filter.

About the same time, he began his researches into aluminium, a metal discovered in 1827 by Wöhler of Göttingen, but still very imperfectly known, and set forth its special properties. Being commissioned by Louis Napoleon to seek the best method of obtaining aluminium at a low price, he made numerous experiments, jointly with M. Debray, in the factory at Javel; and after some

1855. These experiments, and the properties of aluminium, have been described by S. D. in scientific periodicals; and among his later papers are—on the Three Molecular States of Silicium; on the Metallurgy of Platina; on the Density of Vapours at very High Temperatures; on the Measurement of High Temperatures; on the Permeability of Iron to Gases at a High Temperature; on the Phenomena of Dissociation in Homogeneous Flames; and on the Industrial Preparation of Aluminium and its Compounds. These papers are published in the *Mémoires* and *Comptes Rendus* of the Académie des Sciences de l'Institut, and in the *Annales de Chimie et de Physique*.

**SAINTE MARIE-AUX-MINES** (Ger. *Marzkirch*), a town of Germany, in Alsace, on the Liepvetzte, 12 miles north-west of Colmar, at the foot of the Vosges Mountains. It formerly owed its prosperity to its silver mines, but these are no longer worked. Its chief manufactures are cotton fabrics of various kinds, paper, and cherry-brandy. Pop. (1871) 12,319.

**SAINT LOUIS**, the capital of the French possessions in Senegambia, is situated on a small low island of the same name, at the mouth of the Senegal river. The town covers almost the whole island. With its fortifications, it presents an imposing appearance from the sea, but the interior is mean and dirty. The harbour is good. The principal building is the government house. There are 600 stores for goods. Saint L. possesses a botanic garden, founded in 1822. Pop. about 18,000.

**SAINT PIERRE**, a town of the island of Bourbon (q. v.), or Réunion, on the south-west coast, 34 miles south-west from Saint Denis. Pop. 14,135.

**SAINT-PIERRE-LÈS-CALAIS**, a town of France, in the dep. of Pas-de-Calais. It may almost be regarded as a south-eastern suburb of Calais, to which it nearly adjoins, but has grown to a size exceeding that of Calais itself. It is famous for its manufactures of Tulle (q. v.). Other branches of industry are also actively prosecuted, as the manufactures of leather and beetroot sugar. Pop. (1872) 18,092.

**SALEMI**, a town of Sicily, in the province of Trapani, 39 miles south-west from Palermo. Pop. about 12,000.

**SALINS** (anc. *Salinae*), a town of the dep. of Jura, France, 52 miles north-by-west from Geneva, on the Furiense, a feeder of the Doubs. It is situated in a narrow rocky gorge between two lofty hills, looking upon a fertile and beautiful valley. It derives its importance from its salt-works, from which also it has its name. The salt is obtained from brine-springs, and the evaporation of the brine is mostly carried on in a great building, in the valley below the town, which has long borne the name of the *Salines Royales*; but that of the weaker springs is conveyed in pipes to the forest of Chaux, 15 miles off, where it is first slowly evaporated in *maisons de graduation*, and afterwards by boiling. There are iron-works, soda-factories, tanneries, and quarries of gypsum in S. and its immediate neighbourhood. Pop. (1872) 5193.

**SALLEE**, or **SLA**, a seaport town of Morocco, in the territory and former kingdom of Fez, 106 miles west from Fez. It stands on a low sandy point of the shore of the Atlantic, at the mouth of the Bu-Regreb, on the northern side of the river, whilst opposite to it, on the southern side, is the town of Rabat. Both S. and Rabat were bombarded and

*Sallee Rover* was the dread of peaceful mariners in the Atlantic and Mediterranean. It is particularly noted for the carpets which it produces, of fine texture and bright colours. They are mostly used in Morocco itself. The chief export from S. is wool. Pop. estimated at about 12,000, of whom 3000 are Jews.

**SALMON OF NORTH-WESTERN AMERICA**. The rivers of North-western America abound in salmon and trout to a degree not exceeded, and perhaps not equalled, in any other part of the world. Since the article SALMON was written, a very interesting account of the most important species has been given by Mr J. K. Lord, in his work entitled *The Naturalist in Vancouver Island and British Columbia* (2 vols., Lond. 1866), to which we are indebted also for accounts of the Candle-fish, Vancouver Island Herring, and Viviparous Fish, noticed in this Supplement. The first place must be given to *Salmo Quinnet*, of which Quinnet is one of the Indian names, a fish similar in quality to our European salmon, and sometimes 70 lbs. in weight. It is very thick in proportion to its length, the dorsal outline slightly arched, almost forming a notch with the tail. The back is light steel blue, shading to a lighter tint on the sides, and imperceptibly changing to gray or silvery white, blushed over with pink, on the belly. The upper parts, and often also the lower, are thickly spotted with black stars. Salmon of this species ascend the Columbia, the Fraser, and other rivers in prodigious numbers, at the spawning season, and proceed hundreds of miles, and even in the Columbia 1000 miles, from the sea into every rivulet, 'filling even pools left on the prairies and flats by the receding floods.' In what multitudes they crowd up the rivers will be even better understood from the following statements of Mr Lord, relating to a tributary of the Fraser. 'About a mile from my camp was a large patch of pebbly ground, through which a shallow stream found its way into the larger river. Though barely of sufficient depth to cover an ordinary-sized salmon, yet I have seen that stream so filled, that fish pushed one another out of the water high and dry upon the pebbles. . . . With one's hands only, or, more easily, by employing a gaff or crook-stick, tons of salmon could have been procured by the simple process of hooking them out.' Mr Lord goes on to express his opinion that thousands of the salmon ascending the small mountain-streams never can spawn from sheer want of room. He describes them as dying by scores at the base of a waterfall which they could not leap, where, however, they persisted in remaining till they died from inanition, fresh fish coming up as the dead ones floated down. A prodigious stench arises from the multitudes of dead salmon floated down the rivers. The Indians say that all the salmon of this species that come up to spawn die in the rivers; and Mr Lord believes that few, if any, ever reach the sea again. They seem not to eat when in the fresh water, and cannot be tempted either by fly or bait, nor is any food to be found in their stomachs, although, in the stomachs of those taken in the tideway or salt water, the remains of small fish and marine animals are to be found. This kind of salmon ascends the rivers in June and July, for, unlike the salmon of Britain, it spawns in summer.—At the same time with *Salmo Quinnet*, a smaller species, called by the Indians, at the Kettle Falls, the Cha-la-lool (*Salmo Gairdneri*), ascends the rivers. Its average weight is only from eight to eleven pounds, but when it first arrives in the fresh water, its flesh is fat, pink, firm, and most

delicious.—A little later in the season, comes the **WEAK-TOOTHED SALMON** (*Salmo paucidens*).—The autumn, also, has its supply of salmon, quite equal to that of spring in point of numbers, but inferior in quality. They ascend the rivers in September and October. The autumnal salmon (*Salmo lyaodon* of Pallas), a species known also in Northern Asia, is a dingy hook-nosed fish, called *Hooked Snout* by the fur-traders. The hooked snout, however, is peculiar to the males. Salmon of this species are to be found 'in every stream and rill where they can by any possibility work a passage,' and they often remain in fresh water, far from the sea, for four or six months, all of them becoming emaciated, and many of them dying, whilst the snout of the male becomes prodigiously elongated, and the teeth also increase into tusks. As to the multitudes of the full-grown fish of this species to be found at the proper season in the rivers of North-western America, the following extract from Mr Lord's book is conclusive. 'At Fort Hope, on the Fraser River, in the month of September, I was going trout-fishing in a beautiful stream, the Quaque-alla, that comes thundering and dancing down the Cascade Mountains, cold and clear as crystal; these salmon were then toiling up in thousands, and were so thick in the ford that I had great trouble to ride my horse through: the salmon were in such numbers about his legs as to impede his progress, and frightened him so that he plunged viciously, and very nearly had me off.'—The **RED-SPOTTED SALMON TROUT** (*Salmo spectabilis*) is another valuable fish of the same regions. It seldom exceeds three pounds in weight. It ascends the rivers in October, when a great Indian fish-harvest takes place. This fish is readily taken by hooks baited with dried salmon-roe, or by a small shining strip from the belly of a trout.—The **OREGON BROOK TROUT** (*Salmo* or *Fario stellatus*) abounds in the rivers and streams of North-western America, even to a height of 7000 feet in the Rocky Mountains. It attains a weight of three pounds, and is a delicious fish. This trout is readily taken with fly or bait.

The Indians of these regions take the salmon, as they ascend the rivers, by various contrivances. They construct weirs reaching from one side of a stream to the other, with openings, through which the fish pass into large lateral prisons of closely woven wicker. They use nets in the bays and harbours, when the salmon, pursuing anchovies and herrings, run into the net, and are caught, and thus immense numbers are taken. They construct rude scaffolds or stages of wood among the boulders on the sides of large rivers, on each of which many Indian fishers await the salmon, with small nets fastened to handles, forty or fifty feet in length. Thirty salmon an hour is not an unusual take for two Indians to land on a stage. Another and more curious method, practised at falls, is by means of great wicker hampers, about 30 feet in circumference, and 12 feet in depth. To make these available, huge trees are cut down, lopped clear of their branches, and brought to the edge of the river, where they are fastened so that the smaller ends overhang the foaming water. To these the wicker baskets are suspended, where the salmon generally leap in their attempt to clear the falls; and in each basket two naked Indians are stationed all day, frequent relays being necessary, as they are under a heavy fall of water. As the salmon fall into the basket, the Indians catch them under the gills, kill them with a club, and fling them on the rocks. Mr Lord says: 'I have known 300 salmon landed from one basket between sunrise and sunset, varying in weight from 20 to 75 lbs.' The salmon and trout of these regions have already been made

in some small measure available for the markets of the more densely peopled parts of the world.

**SAMBOR**, New, a town of the Austrian empire, in the province of East Galicia. It is a thriving and well-built town, with manufactures of linens and extensive salt-works. Pop. (1869) 11,749.

**SANDHURST**, a town of Victoria, 82 miles north-north-west from Melbourne, on the railway between Melbourne and Ebuca. It is the centre of an important mining district of the Bendigo gold-fields. Pop. (1871), along with its suburbs, 27,642. In the district of S. there are many Chinese.

**SAN FELÉ**, a town of South Italy, in the province of Potenza, 17 m. N. W. of Potenza. Pop. 900.

**SAN FRATELLO**, a town of Sicily, in the province of Messina, 53 miles west-south-west from Messina. At the base of the hill on which the town stands is a remarkable cave, discovered in 1859, and containing prodigious quantities of bones of mammals, with which flint implements are mixed. Pop. 7200.

**SANITARY SCIENCE**, known also under the names of **PREVENTIVE MEDICINE**, **STATE MEDICINE**, **HYGIENE**, and **PUBLIC HEALTH**, has been variously defined by different writers.\* Dr Mapother's is perhaps as good a definition as any. In the first of his *Lectures on Public Health*, he describes this science as 'an application of the laws of physiology and general pathology to the maintenance of the health and life of communities, by means of those agencies which are in common and constant use.' This department of science received so strong an impulse, about a quarter of a century ago, from the labours of Southwood Smith, Edwin Chadwick, Lyon Playfair, and others, that many persons regard it as of modern origin; and doubtless to a great extent they are right; but on turning back to the records of early history, we almost invariably find evidence that the health of the general population was a subject of legislation. The Mosaic code of laws—the most ancient on record—contains minute directions for the cleanliness of the person, the purification of the dwelling and the camp, the selection of healthy and the avoidance of unwholesome food (pork, for example, which in hot countries is more commonly found to harbour parasites than in temperate climates, and blood, which is the most putrescible part of the animal), the seclusion of persons with contagious disorders, the regulation of sexual intercourse at certain periods, and various other points bearing on the physical well-being of the Jewish nation. The Greeks and Romans, although not, like the Jews, making hygiene a part of their religious duties, were far from neglecting it. 'The Laws of Lycurgus,' says Dr Gairdner, 'are not wanting in very pointed enactments on sanitary matters; and the importance attached by all the Greek republics, and in the Platonic ideal polity, to physical culture, is too well known to require remark. The Roman people, poor and apparently rude as it was in its origin, yet found time, amidst its military occupations, to construct the *Cloaca Maxima*, as an indestructible and stupendous memorial of its attention to the drainage and sewerage of the city at a very early period of its history. At a later period, aqueducts were made to cover miles upon miles of the surrounding plain; and their splendid ruins, still partly used for their original purpose, attest the munificence and the abundance with which the first of sanitary requisites was supplied

\* As the state of Sanitary Science, both in principles and practice, is substantially what it was when this exhaustive account of the subject was written by the late Dr Day, the article has been allowed to stand without alteration.

enough of the construction of the private houses and public buildings of the Romans to see that they recognised the necessity for free ventilation and good drainage. When the *Archiatri populares*, or state-physicians, were first appointed in the Roman Empire, is not certainly known. Their mode of election is described in the Theodosian and Justinian codes. There were ten of them in the largest towns; one to each district or subdivision; seven in towns of the second order; and five in the smaller ones. They collectively formed a college, whose duty it was to attend to the public health; and they may be regarded as the earliest type of our 'General Medical Council.' Gradually, however, as Christianity spread, an utter misconception of doctrine led to the neglect of all care of the human body. While the monks and friars devoted themselves to good works, feeding the hungry, clothing the naked, and instituting hospitals, they entertained no idea of the possible prevention of disease. They never attempted to impress upon their followers the importance of drainage, ventilation, pure and abundant water, &c.; but when an epidemic arose, it was supposed to be a manifestation of God's special anger; and it would have been impossible to make them understand that it was the natural result of a prolonged disregard of the laws of nature. Those who have read Dean Stanley's graphic *Memorials of Thomas A'Becket* will be inclined to wonder whether those who adopted such penances as his could ever be free from cutaneous disorders. The state of the towns in England in the 13th c. is so clearly described by Mr Brewer in his Introduction to the *Monumenta Francicana*, that we should have been glad to have extracted it, if our space had permitted. Those who have not access to the valuable series in which Mr Brewer's work is included, will find a sufficient quotation from it in Dr Gairdner's interesting volume on *Air and Water*, pp. 44—47. In another work in the same series—the *Liber Albus*, edited by Mr Riley—much important information regarding the general sanitary state of London in the mediæval times may also be found. In addition to the causes of disease indicated by these writers, such as the absence of drainage, the accumulation of filth, bad ventilation, insufficient and often unwholesome water, inattention to personal cleanliness, &c., must also be noticed the ordinary food in those times. The common vegetables of our own day, excepting the cabbage, were only slowly introduced from the time of Henry VIII. As turnips were not then used as a winter-food for oxen and sheep, these animals were with difficulty kept alive during the season when grass was scanty, and were therefore killed and salted in the beginning of the cold weather; and during several months, game and river-fish were the only kinds of fresh animal food. Macaulay, in his celebrated third chapter on 'The State of England in 1685,' observes that, at that time, meat, although cheaper than in former times, was still so dear that hundreds of thousands of families scarcely knew the taste of it; that bread such as is now given to the inmates of work-houses was then seldom seen even on the trencher of a yeoman or of a shopkeeper; and that the great majority of the natives lived almost entirely on rye, barley, and oats. Many important facts of a similar nature are also recorded in Froude's *History of England*.

During the 18th c., many important steps were taken for the improvement of the public health. Under a proper system of drainage, ague became eradicated from extensive fenny districts; and with a knowledge of the therapeutic properties of

blotted out of the list of diseases that proved most fatal to our sailors; and vaccination, incomparably the greatest discovery yet made in this department of science, was the crowning achievement of the century.† The first outbreak of cholera in this country in 1832, lamentable as it was in itself, was productive of much benefit in directing the public mind to the all-important subject of the prevention or repression of disease. It was impossible to ignore the fact that, while the poor, dwelling in unventilated and undrained hovels, fell victims to this new and ill-understood disease in thousands, the middle and higher classes were comparatively safe. All investigations into the dwellings and domestic habits of the lowest class of the population revealed a condition of things of which the general public had no conception. A new poor-law was consequently passed in 1834, and a commission was appointed to investigate and report upon its working. The *Report on the Sanitary Condition of the Labouring Population of Great Britain*, published in 1842, and mainly treating of the sanitary state of the poor and of the character of their dwellings, may be regarded, as Professor Gairdner‡ well observes, as 'the true starting-point of modern sanitary legislation.' A 'Health of Towns' Commission, which was soon after appointed, gave in two valuable Reports in 1844 and 1845; and subsequently, a Metropolitan Sanitary Commission published Reports in the years 1847 and 1848. These Reports will form a lasting memorial of the labours of Mr Chadwick and his able co-operators. Nor, in this rapid glance at the history of sanitary science, can the name of Dr William Farr be omitted, who—again to quote Dr Gairdner's words—'found the facts of this science in a state of almost hopeless and aimless confusion, and has not only added immensely to their number and value, but has brought into them light, harmony, order, and, for the first time in the history of the science, a determinate method, and an approach to scientific exactness.' By his system of calculating death-rates, he has placed an easy and useful method at the service of his professional brethren, while, by the formation of life-tables, he has greatly facilitated the operations of life-assurance.

We now pass on to the consideration of the most important sanitary agents, beginning with AIR. Under this head, we have to consider (1) the amount of air necessary for the full performance of the respiratory process; (2) the means of ascertaining when air is impure, or, if impure, what substances are mixed with it; (3) the means of purifying contaminated air; and (4) the diseases due to deficiency in the quantity, and alterations in the quality of the air.

(1) The first question can be answered both by calculation and experiment. By calculation, Dr Parkes finds that 2082 cubic feet of air must be supplied per head per hour, so to dilute the products

\* We regret to state that during the last few years scurvy is again becoming prevalent in the mercantile service, and occasionally amongst navvies engaged at places where good food was not easily attainable. In both cases, it may always be traced to neglect of due dietetic precautions.

† And yet, in consequence of vaccination being either neglected or imperfectly performed, no less than 51,034 persons died in Great Britain from small-pox in the ten years, 1856—1865. In the year 1864 alone, the deaths were 9425. On this subject, see Sir James Y. Simpson's 'Proposal to stamp out Small-pox, &c.,' in the *Medical Times and Gazette* for January 4, 1868.

‡ *Public Health in Relation to Air and Water*, p. 17.

of respiration and transpiration from the sound body, as to keep the air always pure and fresh (see his *Manual of Practical Hygiene*, 1864, p. 65). From numerous experiments in which the outflow of air was measured, and the carbonic acid simultaneously determined, he found that at least 2000 cubic feet per hour must be given to keep the carbonic acid at its normal level of '5 or '6 in 1000 volumes, and to remove the *odor humanus* or fetid smell of animal matter. General Morin, in his *Rapport de la Commission sur le Chauffage et la Ventilation des Bâtimens du Palais de Justice*, 1860, gives results in close accordance with those of Parkes, assigning the following as the relative hourly amounts of fresh air (expressed in cubic feet) per head in temperate climates: in barracks, at 1059 by day, and 2118 by night; in workshops, prisons, and theatres, 2118; in schools, 1059; and in hospitals, 2825, increased to 4236 during the hours of dressing the surgical cases, and 5650 during epidemics.\* In mines, if it is wished to keep up the greatest energies of the men, 6000 feet of air per hour must be allowed. It may be incidentally mentioned that a horse requires 2460 feet per hour at the least. It is difficult to lay down any rules regarding the amount of fresh air required in sickness. The vitiation of the air by the products of combustion of gas, candles, lamps, &c., must not be overlooked. For every cubic foot of gas that is burned, 1800 cubic feet of air are required to keep the air pure, unless the gaseous products are carried off in a special channel, such as is now frequently attached to gas-fittings. A pound of oil burned in a lamp may be regarded as equivalent to 10 cubic feet of gas, so far as the deterioration of the air is concerned. (For these facts, we are indebted to Dr Parkes.)

(2) The composition of pure air is sufficiently described in ATMOSPHERE. The impurities in air may be divided into: (a) suspended matters, (b) gaseous substances, and (c) special impurities. Amongst *suspended matters* are, according to Pasteur and others, numerous and universal germs of organic beings, both animal and vegetable, as of vibriones, bacteria, and monads; pollen, spores of fungi, mycodermis, mucedones, &c. Minute particles of finely comminuted inorganic matter are also often taken up by currents of air, and remain in suspension. These are probably altogether harmless. The works of man more seriously affect the air in a hygienic point of view. Particles of coal and of half-burned carbon (smuts), starch-cells (from bakeries and bread), and, when certain trades are carried on, cotton fibres, hairy particles of wool, of stone, of iron, &c., may, when constantly inhaled, give rise to the production of special diseases of the lungs and stomach. In the air of badly-kept hospital wards, pus-cells and epithelial cells are often to be detected. Most physicians now believe that the specific poisons of small-pox, scarlet fever, and measles, which are derived from the skin and mucous membrane, consist of molecular organic matter which, although as yet undetected, must pass into the air; and the same remark applies to the so-called germs of typhoid fever (see the article on TYPHUS AND TYPHOID FEVERS) and cholera which are thrown off by the intestinal mucous membrane, and subsequently become dried and capable of aerial suspension. Amongst *gaseous matters*, which merely pass into the atmosphere either from natural causes or manufactories, various compounds of carbon, sulphur, chlor

\* The older observers fixed the necessary quantity of fresh air far too low: Pelet thought 212 feet sufficient; Arago, 368 feet; and Dr Reid, 600 feet per hour.

magnesia. Amongst the *liquida*\* (consisting of an alkaline permanganate, which at once decomposes ammoniacal compounds, and destroys organic matter rapidly) and carbolic acid: whilst amongst the *gases* or *vapours*—which are the most powerful means of purifying the atmosphere, next to ventilation—may be especially mentioned chlorine, nitrous acid, and sulphurous acid; of these, says Dr Parke, the nitrous acid is probably the most powerful, but it is useful to employ all three alternately, or even together. It must be recollected that all these agents are mere auxiliaries to ventilation, the primary importance of which must never be forgotten.

(4) Abundant experience confirms the view which might have been *a priori* inferred from the study of the physiology of Respiration (q. v.), that the breathing of impure air must be incompatible with perfect health. The special impurities which are worthy of notice as being causes of disease, or of an impaired state of health, are arranged by Dr Parke as follows: (a) Suspended matters; (b) Gaseous matters; (c) Impurities from several substances always co-existing.

(a) *The suspended matters* which are known to occasion disease in various trades, are very numerous. Thackeray, in his well-known work on *The Effects of Arts, Trades, and Professions on Health*, published in 1832, gives the following list of workmen who were injuriously affected by the dust of their trades: Corn-millers, maltsters, tea-men, coffee-roasters, snuff-makers, paper-makers, flock-dressers, feather-dressers, shoddy-grinders, weavers of coverlets, weavers of harding, dressers of hair, hatters employed in the bowing department, dressers of coloured leather, workers in flax, dressers of hemp, some workers in wood, ware-grinders, masons, colliers, iron-miners, lead-miners, grinders of metals, file-cutters, machine-makers, makers of firearms, and button-makers. To this list must be added colliers, who suffer from lung-disease in ill-ventilated mines; potters, especially the class called *flat-pressers*, in whom *emphysema* is so common that it is known as 'the potters' asthma'; the china-sourcers, who all, sooner or later, become asthmatical from inhaling the light flint-dust in suspension; pearl button-makers and pin-pointers, who suffer from bronchitis and hæmoptysis; the makers of grinding-stones; the makers of Portland cement, &c. In some trades, irritant vapours are more or less associated with suspended particles in causing disease. Brass-founders suffer not only bronchitis and asthma from the inhaled dust, but also a special disease, described by Dr Greenhow (in the *Proceedings of the Medico-Chirurg. Soc.* vol. 4) as Brassfounders' Ague, which is apparently produced by the inhalation of the fumes of oxide of zinc; the symptoms being oppression of the chest, with indefinite nervous sensations, followed by shivering, a hot stage, and profuse sweating. Copper-smiths and tin-plate workers are liable to somewhat similar attacks. Plumbers, house-painters, manufacturers of white-lead, &c., are, as is well known, liable to lead-poisoning. The peculiar affection to which workers in mercury and its amalgams, as silverers and water-gilders, are exposed, is described in the article PARALYSIS, under the name of *Mercurial*

\* It may interest some of our readers to know that by washing the cavity of the mouth with a very weak solution of Condy's Fluid, the odour of tobacco is instantly removed.

making artificial pigments, &c., the well-known symptoms of chronic arsenical poisoning are likely to ensue. On the subject, Dr Guy has, at the request of government, drawn up an elaborate Report.

Passing from inorganic or unorganised matter to organic substances floating in the atmosphere, and giving rise to a large class of important diseases, we may remark, that it still remains to be decided in what exact condition this organic matter exists—whether it is in the form of impalpable particles, or moist or dry epithelial or pus cells; and whether it is always contained in the substances discharged or thrown off from the body (as is certainly the case in small-pox), or is produced by putrefactive changes in these discharges, as is supposed to be the case in cholera and dysentery, is also a matter of doubt. But, from the way in which, in many cases, the organic substance is absorbed by hygroscopic substances, it appears that it is often combined, or at anyrate condensed, with the water of the atmosphere.—Parke, *op. cit.*, p. 86. This much is known with certainty regarding the specific poisons—viz, that they differ extremely in the readiness with which they are oxidised and rendered harmless. While typhus and oriental plague throw off a poison, which, if there is due ventilation, is readily destroyed, the poisons of small-pox and scarlatina spread in defiance of free ventilation, and retain their virulence for weeks or months.

(b) The most important *gaseous matters* in the air likely to produce disease are *carbonic acid* and *carbonic oxide*. The normal quantity of carbonic acid in the air being regarded as '5 in 1000 volumes,' it produces fatal results when the amount reaches 50 per 1000 volumes; and at an amount much below this, 15 or 20 per 1000, it produces in some persons, at anyrate, severe headache.' Dr de Chaumont, assistant Professor of Hygiene at Netley, has published a valuable paper in the *Lancet* for September 1866, in which he shews how the amount of air necessary to reduce the carbonic acid of respiration to a given standard could be calculated; and in the *Edinburgh Medical Journal* for May 1867, he has given extended formulae for calculating most of the problems connected with ventilation. Amongst the most important of his conclusions are the following: (1) We cannot safely accept a lower standard of purity than '06 per cent. of carbonic acid. (2) Uniform diffusion being supposed, we cannot preserve this standard with a less delivery of fresh air than 3000 cubic feet per head per hour. (3) We must provide an air space which will admit of the delivery of 3000 cubic feet per head, and at the same time preclude the necessity of changing the whole air so often as six times per hour, for which condition a minimum of 1000 cubic feet is absolutely necessary.\* *Carbonic Oxide* (q. v.), which is often developed in association with carbonic acid, is far more actively poisonous than carbonic acid. An atmosphere containing  $\frac{1}{4}$  per cent. killed small birds in three minutes; and when 1 per cent was present, they died in half this time (Letheby). For the effect of other gaseous matters, as sulphuretted hydrogen, carburetted hydrogen, sulphurous acid gas, hydrochloric acid

\* A committee, of which Sir T. Watson was president, recently appointed by the Poor-law Board to consider the question of the amount of cubic space necessary for the sick in workhouse infirmaries, report that for ordinary patients 800, for offensive cases 1200, and for fever patients 2000 cubic feet should be allowed. Although these spaces are greater than we find in most workhouses, it is obvious from the statements in the text that they are not sufficient.



works on this subject.

(c) *The impurities from several co-existing agents* next claim attention. In point of fact, these are the impurities with which we have practically almost always to deal, and it is very probable that a knowledge of the actions of two or more isolated noxious agents might lead us to very incorrect conclusions regarding the composite effect that is actually produced. When air is vitiated by respiration, it is popularly believed that the carbonic acid gas is the chief poisonous agent; and that the fatality in such well-known cases as the Black Hole (q. v.) of Calcutta, the prison in which the Austrians were placed after the battle of Austerlitz, the steamer *Londonderry*, &c., is simply due to the action of this gas. The true poisonous agencies in these instances are the organic matter, which is always found in air rendered fetid by the prolonged respiration and cutaneous exhalation of a crowd of human beings, and the deficiency of the oxidation, and the consequent increase of putrescent matter in the body (see Carpenter's *Human Physiology*, 1864, p. 304). Putting aside these extreme cases, which are of rare occurrence, we have abundant evidence in the Reports of the Health of Towns Commission, and elsewhere, that the continuous inhalation of an atmosphere moderately vitiated from respiration has an injurious effect on the health. The aëration of the blood is imperfectly effected, and the nutrition generally is more or less interfered with. Although impure air has long been vaguely regarded as a cause of phthisis, it is only during the present century that the fact has been placed on unquestionable authority. It may now be regarded as established, that not only phthisis but other lung-diseases may have their origin in breathing an atmosphere contaminated by respiration. The subject is one of such vital importance that we shall adduce the very strong evidence of Dr Parkes, who most distinctly proves that the prevalence of phthisis amongst our troops is in a direct ratio to the impurity of the air in the barracks. 'A great amount of phthisis used to prevail,' he observes, 'in the most varied stations of the army, and in the most beautiful climates: in Gibraltar, Malta, Ionia, Jamaica, Trinidad, Bermuda, &c., in all which places the only common condition was the vitiated atmosphere which our barrack-system everywhere produced. And, as if to clench the argument, there has been of late years a most decided decline in phthisical cases in these stations, while the only circumstance which has notably changed in the time has been the condition of the air. So also the extraordinary amount of consumption which prevails in the men of the royal and merchant navies, and which, in some men-of-war, has amounted to a veritable epidemic, is in all probability attributable to the faulty ventilation.'—*Op. cit.*, pp. 91, 92. A considerable amount of evidence in support of this view is afforded by comparative pathology. The extraordinary mortality of phthisis amongst the inhabitants of the old monkey-house in the Zoological Gardens, was found to be due to overcrowding and bad ventilation; and now, in their present airy residence, the inhabitants are no longer prematurely cut off. The overcrowding to which cows in large towns are subjected leads to the great amount of pulmonary disease amongst these animals; while horses, which in the worst stables have more free air than cows, rarely suffer. Not only are pulmonary affections induced by the prolonged respiration of air partially vitiated by organic exhalations, but such an atmosphere seems to favour the spread of several well-known specific diseases, as typhus, plague, small-pox, scarlatina, and measles.

breathing an atmosphere vitiated by the exhalations given off by persons in ordinary health; if we now pass to the consideration of the air of a crowded hospital-ward, we shall find the organic matter not only more abundant, but at the same time far more noxious. The convalescence of patients is much retarded by their being kept in such an atmosphere (see CONVALESCENT HOSPITALS). When the air has absorbed a certain amount of organic impurity, its respiration is very liable to give rise to erysipelas and hospital gangrene. *Sewers* and old *cesspools*, when opened, give off *sewage-gas* containing carbonic acid, sulphuretted hydrogen, sulphide of ammonium, and putrid organic vapour. A case is given in the first volume of the *Health of Towns Report*, which forcibly illustrates this fact. When a privy connected with a school at Clapham was cleaned out, 23 of the children were seized with violent vomiting and purging, headache, great prostration, and convulsive muscular twitchings; and 2 of them died within 24 hours. Sewer-men are more liable to typhoid and typhus fever than other persons; but night-men and scavengers do not seem liable to any special disease. The effect of diluted sewer-gas, from bad drainage, on the health of the population at large, is a distinct question, into which we have not space to enter, further than to remark that typhoid and diarrhoea are commonly induced by the escape of this gas through our drains and water-closets into our houses. The effects of the impurities arising from manufactories of various kinds, are of course extremely varied; and the subject is so extensive a one that it must be touched upon very briefly. Sulphurous and sulphuric acid are given off from vitriol and copper-smelting works; hydrochloric acid from alkali-works; arsenical fumes and sulphurous acid from copper and lead smelting furnaces; carbonic acid and carbonic oxide from cement-works, &c. Soap and candle manufactories, if not well superintended, yield various gases of a rancid smell, and even that powerful irritant, acrolein. Gas-works in which the wet-lime process of purification is adopted, often evolve sulphuretted hydrogen to such a degree as to become a nuisance injurious to health. Manure-works usually evolve more or less disgusting smells according to the basis operated on, and the mode of preparation. No bad effect on the health has, so far as we know, been observed in this country, from the gases given off by such works, and the exhalations from the manufactories of *poudrette*, which is dry fecal matter, are positively declared, by several of the highest French authorities, to exercise no injurious action either on man or vegetation; but the eminent French hygienist, Parent Duchâtelet, relates two cases in which *poudrette* underwent fermentation on board ship; and in one of these cases, the vessel lost half her crew (number not stated); while in the other, all on board (five) suffered from intense headache, pain in the limbs, vomiting, prostration, and (in two cases) diarrhoea. The *air of old graveyards*, when they are disturbed, often gives rise to epidemics of fever; but the effect of the effluvia of comparatively recent putrefying human bodies is much more decided. Numerous cases are recorded of asphyxia and various forms of fever arising from the exhumation and disturbance of bodies. How far the effluvia arising from *slaughter-houses* and *backeries* are injurious to health, is an open question. There is very strong general evidence that the men employed at Montfaucon (where, however, the ventilation is excellent, and no putrid matters are allowed to remain) enjoy good health; and Turpin, from a late re-examination of the point, confirms the old conclusion, except so far as glanders and

Malaria seems not only to occasion intermittent and remittent fevers, but diarrhoea and pure dysentery. Organic matter to the amount of eight grains has been obtained from 1000 cubic feet of air collected over marshes; and it is worthy of notice that it has just the same chemical characters as the organic matter exhaled from the lungs, turning red with nitrate of silver, yielding ammonia when treated with lime, and blackening sulphuric acid when drawn through it. See Mapother, *op. cit.*, p. 87.

The next point to be considered is the means to be adopted for continually changing the air, so as to keep it in its natural purity. We have already shown that this change must amount to at least 2000 cubic feet per head per hour for persons in health; and sometimes double that amount, or more, for sick persons. The general principles of ventilation having been treated in the article on WARMING AND VENTILATION, we shall confine ourselves here to a few supplementary observations. In whatever way the fresh air is supplied, there are several essential conditions to be observed, of which the following, as stated by Dr Parke, deserve special notice: (1) 'The entering air must itself be pure. It must be warmed if too cold, and cooled if too warm. (2) Its movement should be imperceptible, otherwise it will cause the sensation of draught, and will chill. The rate at which the movement becomes imperceptible is  $1\frac{1}{4}$  feet per second, or 1.36 miles per hour; 2 and  $2\frac{1}{4}$  feet per second, or 1.4 and 1.7 miles per hour, are imperceptible to some persons; 3 feet per second, or 2 miles per hour, is perceptible to most;  $3\frac{1}{4}$  feet is perceived by all persons. Any greater speed than this will give the sensation of draught, especially if the entering air be of a different temperature, or moist. (3) It must be well diffused all through the room, so that in every part a movement shall be going on—in other words, the distribution must be perfect. (4) The outgoing air must be removed so immediately that there shall be no risk of a person breathing again either his own expired air or that of any other person.'—*Op. cit.* p. 103. The action of the wind is a powerful ventilating agent. If it can pass freely through a room with open doors and windows, it changes the air to an extent that can be effected in no other way. The most serious objection to winds as ventilating agents by perfilation is the uncertainty of their movement, and the difficulty of its regulation. When the velocity reaches 4 miles, it is found unpleasant by most people, and is therefore either excluded, or only admitted through small openings, when it fails to become properly distributed. For the various ways in which the perflative power of the wind has been employed in systems of ventilation, we must refer to Ritchie's *Treatise on Ventilation*, 1862; Tomlinson's *Treatise on Warming and Ventilation*; and to the chapter on that subject by Dr Parke, who gives a diagram illustrating the mode in which Dr Arnott has most successfully ventilated the Field Lane Ragged Schools. In the ventilation of ships, the wind is always used, the air being directed between decks and into the hold by means of wind-sails or tubes with cowls turning towards the wind. A description of Dr Edmond's plan of ventilation, which is now commonly used in emigrant-ships, and is being adopted in the royal navy, is given in a recent article in *The Lancet*, on 'The Medical Aspects of the Abyssinian Expedition.' 'In all cases,' says Dr Parke, 'in which the air of a room—as in a basement story or in the hold of a ship, perhaps—is likely to be colder than the external air, and where artificial means of

ventilation by a fan or screw, it is a question which of the two methods should be employed—the method of extraction, in which the air is drawn out of a building or room; or the method of propulsion, in which air is driven in, so as to force out the air already in the room. Both plans have advocates of authority. The advantages of the method of propulsion are its certainty and the ease with which the amount may be altered. The stream of air can be taken from any direction, and can be washed, cooled, or warmed at pleasure. The fan or wheel commonly used in propulsion is essentially that proposed by Desaguliers in 1734; it is figured in article BLOWING-MACHINES (figs. 7, 8) in SUPPLEMENT. The following is the way in which it is applied to one of the largest rooms in this country—St George's Hall, at Liverpool. The air is taken from the basement; is washed, by being drawn through a thin film of water, thrown up by a fountain; is passed (in cold weather) into vessels for the purpose of warming it, in which it can be moistened by a steam-jet, if the difference of the dry and wet bulb be more than five degrees, and is then propelled along the channels which distribute it to the hall. In summer, it is cooled in the conduits by the evaporation of water. This system is employed with success in various hospitals, asylums, &c. in France and America; and during the Crimean war, Mr Brunel introduced into the hospital of Renkioi a wheel of Desaguliers' at the entrance of each ward of 50 beds, which was worked by hand, and could throw 1000 cubic feet of air into the ward every minute.

For information regarding the best means of keeping the air of rooms at the most fitting temperature, we must refer to the article WARMING. The degree of artificial warmth that should be given to the air varies according to circumstances. Healthy adults, who are well fed and clothed, usually find any temperature from 50° to 60° comfortable; while children and aged persons require a temperature of 65° to 70°. In hospitals, the proper temperature is usually supposed to be about 60°; but in those diseases in which there is preternatural heat, except possibly in scarlatina, a lower temperature—as from 50° to 45°, or even 40°—is more expedient. In most febrile cases, in the acute stage, cold air moving over the body is very efficacious as a cooling agent.

The next sanitary element to be considered is WATER. The daily quantity of water for healthy and sick persons is the first point for consideration. Water is required by healthy persons (1) *For drinking*. A man weighing 10 stone will take on an average from 70 to 90 ounces of water in 24 hours, of which 30 or 40 ounces are taken imperceptibly in the solid food, while the remaining 50 or 60 ounces are taken in a liquid form. But the amount varies extremely. The usual allowance on board ship for both drinking and cooking is 8 pints per adult daily. (2) *For cleansing the person, clothes, and habitations*. Dr Parke estimates 4 gallons per head daily as the smallest amount; and if perfect cleanliness is to be secured, and baths\* are taken, at least 16 gallons per head are required. (3) *For sewage*, an additional 9 gallons must be added. The amount for a water-closet varies with its construction. At Netley Hospital, to which Dr Parke is physician, Jennings's closets are used, which require 10 gallons per head daily.

It may be of importance to many of our readers

\* A general bath requires about 50 gallons; a shower-bath at least 6 gallons; and a hip-bath from 12 to 18 gallons.

purposes; a cow or small ox drinks from 6 to 8 gallons; and a sheep or pig, from 2 quarts to 1 gallon.

The different sources of water—rain-water, rivers, and springs; the chief impurities in these waters; the methods of detecting them; and the modes of purifying bad water, are so fully described in the article WATER-SUPPLY, that we have scarcely anything to add on these points. The organic matters in different waters used for drinking purposes require, however, a few additional remarks, on account of their extreme importance in a hygienic point of view. To the remarks on this subject in pp. 100—101 of vol. ix., we may add that their amount varies from 0·3 per gallon to as much as 12 or even 30 grains per gallon, the purest waters in this respect being those from granitic, or clay-slate, or chalk districts. The most common organic matter is derived from the vegetable kingdom, and consists of humin and ulmin, and of acids derived from humus; all which substances are non-nitrogenous, although the acids combine readily with ammonia. This form of organic matter is far less dangerous than that which has an animal origin, and contains nitrogen. This organic matter is usually derived from the contents of cesspools or sewers percolating into springs. Its exact composition is not known. Fæcal and biliary matters doubtless contribute to the composition of this matter; and in addition, decomposed flesh, as the refuse of butchers' shops and slaughter-houses—substances from tripe-manufactories and gut-spinners, from size, horn, and isinglass manufactories, &c., often contribute to the organic matter of well and spring water. See Parkes, *op. cit.*, p. 12. Most of these substances, in decomposing, produce both nitrous and nitric acid and ammonia; and the nitrites and nitrates thus formed unfortunately not only do not communicate any bad taste or smell to the water, but actually tend in many cases to render it especially palatable. The use of water of this kind is liable to produce diarrhoea and choleraic symptoms.

The characters of good drinking-water—as laid down after much discussion by various sanitary congresses—are summed up by Dr Parkes as follows: 'It must be transparent, colourless, without odour, and tasteless; it should be well aerated (as it then appears to be more easily absorbed), cool, and pleasant to drink; it must have no deposit; vegetables should be readily cooked in it; the total dissolved constituents must be within a certain amount, which, with some limitation, may be represented by the following numbers: organic matter should not exceed 1·5 grains per gallon; carbonate of lime, 16 grains; sulphate of lime, 3 grains; carbonate and sulphate of magnesia, 3 grains; chloride of sodium, 10 grains; carbonate of soda, 20 grains; sulphate of soda, 6 grains; and iron, 0·5 of a grain.'

For details regarding the mode of examining water with the view of ascertaining its value for drinking purposes, we must refer to any of the leading works on Practical and Analytical Chemistry, and an especial reference may be made to Professor Miller's recent Memoir on Potable Water, and to Dr Parkes's section on the examination of water. To the substances named in the article on WATER-SUPPLY, as purifying water from organic matter, we may add the following: (1) *Permanganate of potash*, commonly known as Condyl's Fluid, which decomposes organic matter and ammoniacal compounds by rapid oxidation. A physician who has had long experience on board Australian emigrant-ships informs us that he has often <sup>22</sup> a small quantity to the water which, when <sup>23</sup> from the casks,

Condyl's Air and Water, their Impurities and Purification, may be read with advantage.) (2) *Styracis potatorum*, which is used in India to purify water; the nut being rubbed on the inside of the cask. (3) Certain vegetables containing tannin, as tea,\* kino, the Laurier rose (in Barbary), and bitter almonds (in Egypt).

The consequences of an insufficient and impure supply of water are deserving of the most serious consideration. The Reports of the Health of Towns Commission (1844 and 1845) contain much information on the first of the subjects; while the Reports of the Medical Officer of the Privy Council abound in facts relating to the second subject. We find that an insufficient supply leads to the persons and clothes not being washed at all, or being repeatedly washed in the same water; to water for cooking being repeatedly used; to imperfect cleansing of houses and streets; to the sewers becoming clogged, and the air thus rendered impure. The natural result is—as in the case of a deficiency of pure air—a depressed condition of the general health, with a tendency to skin-diseases, ophthalmia, &c.; while the imperfect cleansing of the sewers favours the spread of typhoid fever and of choleraic diarrhoea. We are indebted more perhaps to Mr Simon's valuable Reports than to any other source for the knowledge that a continually increasing class of cases is found to be connected with the use of impure water, the principal noxious ingredients being animal organic matter, especially when of fæcal origin; vegetable organic matter, when derived from marshes; and some salts, except when in very small quantities, as sulphates of lime and magnesia, chlorides of calcium and magnesium, nitrates and nitrites of ammonia, &c. The *disenteric mucous membrane* is especially liable, he supposes, to be affected by impure water. Thus, dyspepsia, with such symptoms as partial loss of appetite, uneasiness or pain in the pit of the stomach, nausea and constipation, with occasional diarrhoea, may be caused by water containing certain quantities (probably about eight grains each per gallon) of sulphate of lime, chloride of calcium, and the magnesian salt. *Diarrhoea* may be caused by the use of many of the great North American rivers, the Ganges, &c., where much clay is held in suspension. Water contaminated with sewage, and containing suspended animal and especially fæcal matter, is a common cause of an outbreak of this affection, and even of choleraic symptoms. Dissolved animal organic matters doubtless have a similar effect, but it is difficult to distinguish between the actions of these and of suspended organic matters. Amongst other impurities known to occasion diarrhoea are fetid gases (sulphuretted hydrogen), an excess of dissolved mineral matters and nitrate of lime; and on most persons, brackish water acts similarly. The effects which the selenitic well-waters of Paris exert on strangers are well known. There is abundant evidence to shew that impure water is one of the principal causes of *Dysentery*. The records of our army surgeons abound in illustrative cases. The detestable effect of the impure water of Calcutta in inducing dysentery has been forcibly pointed out by Dr Chevers in the *Indian Annals* for 1844.

\* The water of the Peiho and other rivers in the north of China is so impure, and has so offensive a smell during winter, that the Chinese never drink it except as tea, when it seems to lose all its bad effects. It is only by using their 'brick-tea' to purify the water of the steppes, that the Tartars render the water drinkable.

are certain *specific diseases* which result from the use of impure water, as *Malarious Fevers* of various forms, from the use of the water of marahas; *Typhoid Fever*, from water contaminated with sewage matters, or the special typhoid poison; *Cholera*, from water into which cholera-evacuations have made their way; and possibly *Yellow Fever*. (The relation of impure water to typhoid fever and cholera will be more fully noticed in a later part of this article.) To the use of water unfit for drinking purposes are also ascribed epidemic boils from the presence of sulphuretted hydrogen; disease of the bones, as exostosis, from an excess of carbonate and sulphate of lime; calculi (on, we think, insufficient evidence); goitre, from water derived from limestone and magnesian rocks; and entozoa of various kinds. Dr Parkes sums up the department of his *Manual* which treats of water in a hygienic point of view with the following practical conclusions: '(1) An endemic of diarrhoea in a community is almost always owing either to impure air, impure water, or bad food. If it affects a number of persons suddenly, it is probably owing to one of the two last causes; and if it extends over many families, almost certainly to water. (2) Diarrhoea or dysentery constantly affecting a community, or returning periodically at certain times of the year, is far more likely to be produced by bad water than by any other cause. (3) A very sudden and localised outbreak of either typhoid fever or cholera is almost certainly owing to the introduction of the poison by water; and the same fact holds good in cases of malarious fever. (4) The presence of lumbrici, guinea-worm, or *Bothriocephalus latus*, should always excite suspicion of the drinking and bathing water.'—*Op. cit.*, p. 63.

After the two most important factors in relation to health, viz, air and water, SOIL and CLIMATE occupy a secondary, although by no means unimportant place. As their practical bearing is less direct and universal, we will dismiss them briefly. SOIL may affect health (1) by its conformation and elevation. Thus, amongst hills, the unhealthy spots are enclosed valleys, where the air must stagnate, and ravines. On plains, the most dangerous spots are at the foot of hills which store up water, unless a ravine cuts off the drainage. (2) Vegetation exerts an important influence. If we regard vegetation as divisible into herbage, brushwood, and trees, it may be laid down as a general rule, that herbage is always healthy, and in the tropics, is of great importance in cooling the ground, both by obstructing the sun's rays and by aiding evaporation; that brushwood is almost always bad, but that its removal may cause a temporary increase of malarious disease, on account of the disturbance of the soil; and that trees should seldom be removed, unless they decidedly interfere with the movement of the air, for in cold countries they shelter from cold winds—in hot, they cool the ground—and in both they may afford protection from malarious currents. The present condition of St Thomas in the West Indies, which is now one of the most pestilent sites we are acquainted with, is mainly due to the insane destruction of its trees. The island of Mauritius, which has lately been visited by one of the most universal and destructive forms of fever ever recorded, has similarly suffered from the same cause. (3) The mechanical structure of the soil is of hygienic importance in various points of view. Thus, heat is very differently absorbed by different soils under the same conditions of exposure. Assuming that sand with a little lime has the maximum power of retaining

of humus as low as 49. Hence, we see the comparative coldness of the latter soils as compared with sand. The capacities of these soils for absorbing and retaining moisture are in the reverse order.

As a general rule, there seems to be the following connection between the geological characters of a site and its probable healthiness. *Granitic, Metamorphic, and Trap Rocks* are usually healthy: there is generally a slope, so that water runs off readily, the air is dry, vegetation moderate, and drinking-water generally good. They are, however, supposed to be unhealthy when they have become disintegrated, as at Hong-kong, into a dark-coloured soil. *Clay-slate Rocks* are regarded as healthy, for very similar reasons; water, however, is often scarce. Of the varieties of *Limestone Rocks*, the hard oolite is the best, and the magnesian (which, if possible, should always be rejected as a site) the worst. *Chalk*, when unmixed with clay, forms a very healthy soil; but if it be mixed with clay, it loses its permeability, and is often damp and cold. The air is pure, and the water, though hard, is clear, sparkling, and pleasant. The *Sandstones*, if permeable, are healthy; but if, from an admixture or underlying of clay, they lose this property, they are often damp. The water must be carefully examined. The hard millstone grits are very healthy. *Gravels* of any depth are healthy, except water rises through them. Dr Parkes considers gravel-hillocks as the healthiest of all sites, and the water as being very pure. *Clay, Dense Marls, and Alluvial Soils* must be regarded with suspicion. Such soils, and especially the deltas of rivers, should, if possible, be avoided as sites, and if they must be chosen, thorough sub-soil draining, careful purification of the water, and elevation of the houses far above the soil, are the measures to be adopted. According to Dr Forbes Watson, nearly one-third of the whole surface of India is covered by alluvial soil.

CLIMATE.—The most important climatic conditions connected with the air are *temperature, humidity, and movement, weight, and composition of the air*. Under the head of temperature we might enter into the general subject of acclimation; we must, however, confine ourselves to the remark, that Europeans from temperate climates seem to flourish in countries not much hotter than their own, as in some parts of Australia and New Zealand, although it is yet too soon to decide whether the general vigour of the race will improve or diminish. In countries with a yearly mean of 20° F. higher than their home climate, as in many parts of India, the race seems to dwindle, and gives indications of dying out. The endemic diseases of Europeans in the tropics are liver-disease and dysentery, but it is uncertain how far other influences may be at work besides heat in the production of these diseases. Rapid changes of temperature are always dangerous. The sudden check to the free action of the skin caused by a cold wind, is sure to give rise to catarrh, inflammations, and neuralgia. The Registrar-general's returns shew that when the temperature in London falls from 45° to 27°, the weekly mortality is increased by 400, bronchitis being the disease which mainly causes this increase—an affection which usually does not prove fatal in more than about 40 cases weekly. The fatal influence of extreme cold in depressing the nervous system, and giving rise to a sleep from which there is no awakening, is noticed in the article COLD. According to their humidity, climates are also divided into *moist* and *dry*. The most agreeable

amount of moisture to most persons is when the relative humidity\* is between 70 and 80 per cent. In chronic lung-diseases, a still moister air is most pleasant, and serves to allay cough. The morbid effects of undue moisture are always associated with rise of temperature. As a general rule, warmth and great humidity are less oppressive than cold and great humidity. There seems to be close relation between the spreading and the checking of certain epidemic diseases and the relative moisture of the atmosphere. The malarious diseases are most intense when the moisture is excessive; while plague and small-pox are checked by a very dry atmosphere. Yellow fever seems unaffected by this atmospheric condition. That the humidity of a climate, irrespective of other climatic relations, is not injurious to life, may be inferred from a comparison between the climates of England and Ireland. The number of persons over 100 years of age is, in proportion to the population, five times as great in Ireland as in England, and the greatest longevity has been observed in Connaught, the wettest of the provinces.† See Mapother, *op. cit.*, p. 134.

diseas  
from  
emph  
bron  
F  
side  
Th  
wh  
as  
ki  
a  
c

The *movement of the air* is another climatic condition of importance, but it must be considered in connection with heat and moisture. A cold wind abstracts the bodily heat in proportion to its velocity; while a hot wind, if dry, increases evaporation, and may thus partly neutralise its own heat. Variations in atmospheric pressure are of great importance in relation to health. 'In ascending mountains,' says Dr Parke, 'there is a reduction, i. e., lessened pressure of air, lowered temperature, and lessened moisture above 4000 feet; greater movement of the air; increased sunlight; greater sun-radiation, if clouds are absent, and the air is freer from germs of infection.' Owing to the rarefaction of the air and the escape of vapour, there is greater diathermancy of the air; the soil is rapidly heated, but radiates its heat fast, hence very great coolness of the ground and of the air close to it at night.' p. 418. The physiological effects of lessened pressure begin to be perceptible at somewhat above 3000 feet, at which altitude the mercurial barometer stands at 30 inches. The pulse is quickened by 15 beats per minute, and the breathing by 10 or 15 inspirations per minute; there is increased evaporation from the skin and lungs, while the urinary secretion is notably diminished. At an elevation of 4000 feet, as in the Swiss Alps, the mountain air shews itself in a marked manner in its effects on digestion, sanguification, and muscular vigour. At great heights, there is a constriction of the superficial vessels, and occasionally a congestion of the nose and lungs; and a sensation of numbness is felt in the limbs from the lessened circulation. A residence for some time in the high mountains is of great value in all anæmic affections, whatever cause they may arise. Scrophulous affections and rheumatism are all benefited by high positions (see Weber *On the Climate of the Alps*, 1864); and scrofula and consumption are absent in the true alpine regions. Persons affected with these diseases, in a high mountain climate, rapidly improve. On typhoid fever, pneumonia, pleurisy, and acute bronchitis, common in high regions the

\* By *relative humidity* we mean the amount of moisture, complete saturation. It is determined by dividing the amount of moisture actually existing in the air (or the weight of vapour which it contains) by the weight of vapour which the air had been saturated with.

† The average annual rainfall in England is 38, but on many days it is

hospitals, fixed scales must, as a matter of convenience, be adopted; but almost every special case requires a modification. For further information on special diets, the reader is referred to Moleschott's *Physiologie der Nahrungsmittel* (1860); to Dr Dobell's useful *Manual of Diet and Regimen*; and to Dr Smith's *Practical Dietary for Families, Schools, and the Labouring Classes*.

The diseases connected with food are so various that we can only notice the most important. Passing over those which arise from excess of food generally, or of one of its classes, with the remark, that a prolonged excess of albuminates gives rise to congestion and enlargement of the liver, and a general state of plethora, while excess of starchy matters may possibly affect the muscular fibres of the heart and voluntary muscles, and certainly often renders the urine saccharine, we proceed to notice the diseases produced by the deficiency of food. The history of epidemic fevers in all ages and countries shews the close relation between famine and fever. The *Irish famine* of 1847—1849 is now a matter of history. In those three years, no less than 579,721 cases were treated in the hospitals alone. Fleeing in despair, emigrants carried the germs of disease with them; and the so-called *ship-fever* which followed destroyed its thousands. Its malignity was most appalling. In one vessel, 329 out of 349 passengers caught the fever, and 117 died; and the mortality in Liverpool, induced by the contagion of the fever-stricken Irish who landed there, suddenly became the highest ever recorded in any modern town—the death-rate being raised to 70 per 1000. During the last three years, 1865—1867, the death-rate of this town was 36, 42, and 30. Dr Mapother is of opinion that the introduction of the potato as an almost sole article of diet has been productive of much harm, in consequence of the deficiency of that root in nitrogenous matters and in salts of lime and magnesia.\*

To this source he traces indigestion, consumption, scrofula, rickets, ophthalmia, and chronic rheumatism. The deprivation of starchy food, on the other hand, can be borne for a long time if fat be given; but the simultaneous deprivation of fat and starch soon induces illness, though albuminates be supplied.

With regard to salt meat, it must be recollected that the brine, if it has been used several times, occasionally becomes poisonous. The evidence as to the power of diseased meat when eaten to excite disease, is—if we except the cases in which entozoa are present—very unsatisfactory. We have the evidence of Sir Samuel Baker and others that certain African tribes eat without injury meat swarming with maggots. In this country, the flesh of healthy animals, when decomposing, is sometimes eaten with impunity, and sometimes occasions severe gastric

\* Potatoes contain 74 per cent. of water, 1.5 of albuminates, 0.1 of fat, 23.4 of starch, cellulose, &c. (the carbo-hydrates), and 1 of salts. The chief ingredients of the salts are potash, about 50 per cent.; and phosphoric acid, about 13 per cent. The juice of the potato abounds in salts of organic acids (citric, tartaric, &c.), which on incineration are converted into carbonates—the carbonic acid thus formed amounting to 13.3 per cent. The relative proportion of fat to albuminates in the food which is most easily digested, and at the same time produces the greatest mechanical force, is as 1 to 2; in the potato, it is as 0.1 to 1.5, or as 1 to 15. Again, the starchy matters should be to the nitrogenous as 3 to 1 in the best diet: in the potato, they are as 23.4 to 1.5, or as 14 to 1 nearly. On this subject see the article **MUSCULAR FORCE, ORIGIN OF**, in *SUPP.*, Vol. X.

river fish be washed in a very dilute solution of Condyl's fluid, previous to being cooked, all danger is removed. The occasional occurrence of a poison in sausages and even in pork pies is well known, although its nature is not clearly understood. The fresh flesh of diseased animals assuredly causes injurious effects in many cases, but not in all. In the early stage of acute inflammatory disease, the meat is not altered, and may be eaten with impunity. Whether the epidemic pleuropneumonia of cattle renders their flesh unfit for use, is an open question. (See Mapother, *op. cit.*, pp. 217—224, who decidedly condemns its use, and Parkes, *op. cit.*, pp. 161—166, who quotes conflicting evidence.) The discrepancy of evidence is equally great regarding anthrax and malignant pustule. The death of sheep from splenic apoplexy or braxy, and from small-pox, renders their flesh unfit for food; while the flesh of cattle destroyed by foot-and-mouth disease and by typhoid fever has been largely used in France without injury. The detection of the adulterations of the ordinary articles of food is a very important duty in relation to hygiene; on this subject, we must refer to Hassall's great work, and to our article **FOOD**.

The object of **CLOTHING** is to preserve the proper heat of the body by protecting it both from cold and heat, and thus to prevent the injurious action of sudden changes of temperature upon the skin. The most important materials of clothing are cotton, linen, wool, silk, leather, and india-rubber. *Cotton*, as a material of dress, wears well, does not readily absorb water, and conducts heat much less rapidly than linen, but much more rapidly than wool. From the hardness of its fibres, its surface is slightly rough, and occasionally irritates a very delicate skin. Its main advantages are cheapness and durability. In merino it is mixed with wool in various proportions, and this admixture is far preferable to unmixed cotton. *Linen* is finer in its fibres than cotton, and hence is smoother. It possesses high conducting and bad radiating powers, so that it feels cold to the skin; moreover, it attracts moisture much more than cotton. For these reasons, cottons and thin woollens are much preferred to linen garments in warm climates. *Silk* forms an excellent underclothing, but from its expense, it can never come into general use. *Wool* is superior both to cotton and linen in being a bad conductor of heat, and a great absorber of water, which penetrates into the fibres and distends them (hygroscopic water), and also lies between them (water of interposition). 'This property of hygroscopically absorbing water is,' as Dr Parkes observes, 'a most important one. During perspiration, the evaporation from the surface of the body is necessary to reduce the heat which is generated by exercise. When the exercise is finished, the evaporation still goes on, and to such an extent as to chill the frame. When dry woollen clothing is put on after exertion, the vapour from the surface of the body is condensed on the wool, and gives out again the large amount of heat which had become latent when the water was vaporised. Therefore, a woollen covering, from this cause alone, at once feels warm when used during sweating. In the case of cotton and linen, the perspiration passes through them, and evaporates from the external surface without condensation; the loss of heat then continues. These facts make it plain why dry woollen clothes are so useful after exertion. In addition to this, the texture of wool is warmer, from its bad conducting power, and it is less easily penetrated by cold winds.'—*Op. cit.*, p. 353. **Leather**

is used not only for shoes, boots, and leggings, but, in cold windy countries, for coats. Leather and sheep-skin coats are in common use in Turkey, Tartary, Persia, the Danubian Provinces, and in Canada, where buffalo-skins are often used. For persons specially susceptible to cold, and of delicate organisation, a chamois leather jacket worn over a flannel waistcoat may be recommended with advantage during the winter months. *India-rubber* clothing must be used with extreme caution. From its being impenetrable to wind, and from its condensing and retaining the perspiration, it is decidedly objectionable; while, on the other hand, its protection against rain is a very valuable property. The Council of Health of the French army have refused to admit waterproof garments amongst their soldiers; and in this country it has been prohibited amongst the London postmen.

In relation to protection against heat, we have to consider the colour and not the texture of clothing. White is the best colour, then gray, yellow, pink, blue, and black. Hence, in hot countries, white or light gray clothing should be preferred.

The shape and weight of all articles of clothing should be such as to allow of the freest action of the limbs, and in no way to interfere by pressure with the processes of respiration, circulation, or digestion. In a complete treatise on hygiene, a discussion on the relative advantages and disadvantages of the various articles of clothing used by both sexes would find a proper place, but our limited space totally precludes us from entering into this subject.

Attention to the STATE OF THE SKIN is of great importance in a hygienic point of view. The perspiration and sebaceous matters which are naturally poured out upon the surface of the body, with an intermingling of particles of detached epidermis, fragments of fibres from the dress, dirt, &c., if not removed, gradually form a crust which soon materially interferes with the due excreting action of the skin. There is little doubt that the daily use of the matutinal *tub*, which less than half a century ago was unheard of, and is now a matter of necessity with most healthy persons who have the means of using it, has contributed materially to harden the system against attacks of colds, rheumatism, &c. When a tub and sponge happen to be unattainable, a wet towel rubbed over the body, followed of course by a dry one, is a good substitute.

EXERCISE is the subject that next claims our consideration, and we shall briefly notice its effects on the different systems of organs. (1) The most important effect of muscular exercise is produced on the *lungs*, the quantities of inspired air and of exhaled carbonic acid being very much increased. Taking the air inspired in a given time in the horizontal position as unity, a man walking 3 miles per hour inspires 3.22; and if carrying 34 lbs., 3.5; a man walking 4 miles per hour inspires 5; and when walking 6 miles per hour, no less than 7. Almost twice as much carbonic acid is exhaled during exercise as during rest. Hence, muscular exercise is necessary for the due removal of the carbon; and it is obvious that in a state of prolonged rest, the carbonaceous food must be diminished, or the carbon will be liable to accumulate in the system; and further, it is clear that, for strong exercise, carbonaceous food should be freely given. (2) The action of the *heart* rapidly increases in force and frequency during exercise. The increase in the number of beats may range from 20 to 30, and is sometimes much more. After exercise, the heart's action is diminished. Excessive exertion

may do harm by inducing pulmonary congestion, and even hæmoptysis, palpitation, hypertrophy, valvular disease, and occasionally rupture; while deficient exercise probably tends to induce tuberculous disease of the lung, weakness of the heart's action, and probably dilatation and fatty degeneration. From these facts we learn, that when a person commences any new form of exercise or gymnastics, the heart's action should be watched, and if the pulse rise to 120 or more, the exercise should for the time cease. (3) The *skin* becomes red from increase of blood in the capillaries, and the perspiration is increased, being at least doubled. The bodily heat is kept down by cutaneous evaporation, which reduces the temperature. During exertion, there is very little danger of chill, but the danger becomes great when the exertion is over, because there is then a rapid fall in the heat of the body, while the evaporation of the skin continues. Hence, while the skin may be freely exposed during exercise, it must be covered immediately afterwards, in order to prevent any feeling of coolness on the surface. (4) The *muscles* grow to a certain limit, but over-exercise of any special group may produce wasting. Care must be taken that the exercise is of such a nature that all the muscles, and not single groups, should be brought into play; and that in early training, long intervals of rest should intervene between the periods of exercise. (5) The effect of exercise on the *mind* is not clearly determined; great bodily activity is often observed in association with full mental activity; but there is a fear that, in our great public schools and universities, boating and cricket are supplanting more useful subjects, and leaving too little time for the due performance of intellectual work. (6) *Digestion* is improved by exercise. The appetite increases, and nitrogenous substances, fats, and salts, especially phosphates and chlorides, are required in greater quantity than in a state of rest. (7) The *change of tissues* is increased by exercise, or, in other words, the excretions give off increased quantities of carbon, nitrogen, water, and salts. The muscles require much rest for their reparation after exercise, and they then absorb and retain water, which seems to enter into their composition. So completely is the water retained in the muscles, that the urine is not increased for some hours. Hence, observes Dr Parkes, there is an absolute necessity of water for the acting muscles, and the old rule, held by trainers, of only allowing the smallest possible quantity of fluid, must be wrong.

The amount of exercise which should be taken by an adult healthy man is a subject of great importance. Professor Haughton, in his *New Theory of Muscular Action*, calculates that a labouring man daily exerts a muscular force to a degree which may be expressed by saying, that he would raise to the height of 1 foot from 250 to 350 tons. For persons not obliged to labour, the force expended, including that required for the ordinary avocations of life, should average 150 tons, which is equivalent to walking about 9 miles daily. It is unfortunately impossible to arrange scales of exercise for invalids, women, and children. Professor Haughton has shewn that walking on a level surface is equivalent to raising the  $\frac{1}{10}$ th part of the weight of the body through the distance walked. When ascending a height, a man of course raises his whole weight through the height ascended. Using his formula,  $W + W'D$  (where W is the weight of the person,  $20 \times 2240$  W' the weight carried, D the distance walked, 20 the coefficient of traction (see FRICTION), and 2240 the number of pounds in a ton), we obtain as a

result the number of tons raised 1 100t; and on applying it, we get the following table :

Kind of Exercise.	Weight done in Tons About one foot.
Walking 1 mile, . . . . .	17.67
" 20 miles, . . . . .	353.4
" 1 mile, and carrying 60 lbs., . . . . .	34.75
" 20 miles, " " " " . . . . .	495

Thus, a march of 10 miles, with a weight of 60 lbs. (which is about the weight a soldier carries when in marching-order, but without blankets and rations), is a moderate day's work. A 20 miles' march with this weight is a very hard day's work. As a continuous effort, Professor Haughton believes that walking 20 miles a day without a load (Sundays excepted) is good work.—For a discussion on the various forms of exercise, as horse-exercise, boating, dancing, and gymnastics, we may refer the reader to Mapother, *op. cit.*, pp. 263—268. In connection with the subject of exercise, the reader is referred to the article **MUSCULAR FORCE, ORIGIN OF**, in **SUPP.**, Vol. X.

The **CONSTRUCTION OF HOUSES**, especially of dwelling-places for the poor, and public lodging-houses, next claims our notice. There can be no doubt that the frequency and fatality of the epidemics of the middle ages were in a great measure due to unhealthy habitations. The houses were usually closely packed in crowded streets, and were often built for the purpose of defence, at a sacrifice of ventilation, lighting, draining, &c. At the present day, with all our boasted civilisation, the dwellings of the poor, both in our large towns and in our country villages, are too often a disgrace to humanity. Any one may readily satisfy himself on this point by reading the various government Reports referred to in an early part of this article, the Annual Reports of the Medical Officer of the Privy Council, and the Reports which are annually published by many of our Officers of Health.

An article on the Sanitary State of Manchester, which appeared in the *Quarterly Journal of Science* for April 1867, reveals a condition of the dwellings of the poor which seems almost incredible to those who have not previously studied this important but uninviting subject. In many parts of Ireland, as we learn from Dr Mapother, the dwelling-places of even the small farmers are hardly fit for a healthy existence. Dr Tucker of Sligo draws the following picture of 'the homely hovel of a small farmer, which may be taken as the prototype of many. It was about 12 feet wide and 24 feet long. The domestic circle that dwelt therein consisted of a sick man, his wife, four daughters, one son, three cows, one horse, two calves, two pigs, and poultry—all in one common undivided house, without a partition. Generally, the pigs dwelt beneath the beds, the people in them, and the poultry overhead.' On the evils, physical and moral, arising out of such a system it is unnecessary to dwell.

Much has of late years been done in London (by the benevolence of Baroness Coutts, Mr Peabody, Alderman Waterlow, and others) and in many other large towns to improve the dwellings of the poor, and to give them, on moderate terms, a far more healthy and commodious house-accommodation than they could otherwise obtain. Many of these improved dwellings seem fever-proof, and the death-rate has been found much lower than in adjacent places. Even without the aid of private benevolence, the erection of blocks of improved dwellings for the working-classes has proved remunerative. Five conditions are requisite in order to insure healthy habitations, on whatever scale they

may be constructed: (1) A site dry and not malodorous, and an aspect which gives light and cheerfulness; (2) a ventilation sufficient to carry off all respiratory contaminations of the air; (3) a system of immediate and perfect sewage removal; (4) a due supply and proper removal of water; and (5) a construction of the house such that perfect dryness of its foundation, walls, and roof is insured. For further information on this important topic, the reader is referred, *inter alia*, to the various works of Mr Godwin, especially his *Another Blow for Life*; to Mr Hole's interesting book entitled *The Homes of the Working-classes*; and to Dr Mapother's *Lectures on Public Health* (2d ed. pp. 297—326).

SEWAGE is sufficiently considered in the special article devoted to that subject (see also **SEWAGE EARTH-CLOSET** in **SUPP.**, Vol. X.); and we pass on to another subject closely connected with hygiene—viz., the **DISPOSAL OF THE DEAD**. To see the importance of this subject, the reader must know something of the changes which the body undergoes after death. A body that has been buried gradually breaks up into a large number of comparatively simple compounds, such as carbonic acid, ammonia, sulphuretted and carburetted hydrogen, nitrous and nitric acid, and certain more complicated gaseous matters with a very fetid odour, which finally undergo oxidation; while the non-volatile substances usually enter into the soil, and either pass into plants, or are carried away by the water percolating the soil. These changes are accelerated by the worms and other low forms of life that usually swarm in decomposing bodies; and the character of the soil materially influences the degree of rapidity of destruction. The bones remain almost unchanged for ages. If a body is burned, decomposition is incomparably more rapid, and different volatile combinations may arise; the mineral salts and a little carbon alone remaining. The question for our consideration is, What is the best method of disposing of our dead, so that the living may suffer the least? Putting aside the visionary schemes for turning the dead to commercial account, there are three methods for consideration—viz., burial in land or in water, or incineration. At present, as Dr Parkes observes, the question is not an urgent one; but it may become so in a century or two, if the population goes on increasing at the present rate. Even in our own time, a great change has taken place, and the objectionable habit of interments in and round churches in towns has been given up, cemeteries in the country being now commonly employed, except in the case of country villages. The air over cemeteries is, however, always contaminated, and water percolating through them is unfit for drinking purposes; and there is a general and very decided opinion that the vicinity of graveyards is unhealthy. The evils are lessened by making the grave as deep as possible, and by placing not more than one body in one grave. Plants should be freely introduced into every cemetery, for the absorption of organic matters and of carbonic acid; and the most rapidly-growing trees and shrubs should be selected, in preference to the slowly-growing cypress and yew. We may add that the superficial space which should be allotted to each grave varies in different countries from 30 to 90 feet, and that the depth should be at least 6 feet. It is required by law that the grave spaces for persons above 12 years of age shall be at least 9 feet by 4, and those for children under 12 years, 6 feet by 3. It is likewise required that not less than 4 feet of earth should be placed over the coffin of an adult, and 3 feet above that of a child. The time which should elapse before a grave is disturbed



for a new tenant varies with the soil and the distance of the body from the surface. Under favourable circumstances, a coffin containing an adult will disappear with its contents in about 10 years; while in a clayey or peaty soil, it will remain a century. It is generally assumed that a period of 14 years is sufficient for the decay of an adult, but long before this time, all will have disappeared but the skeleton. If the question should in course of time arise between burying in the sea and burning, it will be decided, Dr Parkes believes, in favour of the former, on the following grounds: 'It is true that the impurities in burning can be well diffused into the atmosphere at large, and would not add to it any perceptible impurity. But if the burning is not complete, fetid organic matters are given off, which hang cloud-like in the air, and may be perceptible and even hurtful. As a matter of expense, too, the system of incineration would be greater than the burial at sea. In the burial at sea, the body would go at once to support other forms of life more rapidly than in the case of land-burial, and without the danger of evolution of hurtful products.' On this subject, the reader may further consult the Report drawn up by Mr Chadwick on the State of Cemeteries; the Report of the General Board of Health, 1858 (of which Mr Chadwick and Dr Southwood Smith were members), on the same subject; Dr Mapother's 14th Lecture 'On the Burial of the Dead;' and a work published by M. Favrot, entitled *Histoire des Inhumations*, 1867.

The Reports to which we have just referred contain abundant evidence of the necessity for the universal establishment of mortuaries, or houses for the reception of the dead until the period of the burial. In some parts of Germany, the deposit of the dead in such houses is compulsory; and in many parts of the continent, there are laws rigidly enforcing the burial within a certain number of hours after death.

Before proceeding to consider how far our sanitary regulations have effected a saving of human life, it is expedient to give a brief notice of the chief acts of parliament which have passed, and government Reports that have been officially published, bearing on important sanitary subjects. Beginning with 1833, in which the Factory Children's Act was passed; in 1834, the practice of employing climbing boys for sweeping chimneys was abolished; in 1840 and 1841, the Act to Extend the Practice of Vaccination was passed; and in 1841 the employment of women and children in min and collieries was abolished. Then appeared the General Local Reports on the Sanitary Condition of the Labouring Classes, 1842, which constitute as Dr A. P. Stewart well observes, a 'remarkable series of volumes, for which we were indebted chiefly to Mr Chadwick, and which, revealing they did an almost incredible state of matters, our crowded centres of population, were read multitudes with a strange and eager interest.'—*Medical and Legal Aspects of Sanitary Reform* (1867), p. 5. These Reports of the Health of Towns Commission led to the passing, in rapid succession, of 'the Acts for Promoting the Establishment of Baths and Wash-houses in Great Britain and Ireland, in 1846; the Towns Improvement Act, 1847; the Public Health, the Nuisances Removal, and the City of London Sewers Acts, in 1848; the Metropolitan Interments Act, in 1850, followed in 1853 by a similar act for the whole of England; the Act to Encourage the Establishment of Lodging-houses for the Labouring-classes, and the Lodging-houses Act, in 1851; the Metropolitan Water Act, in 1852; the Smoke Nuisance (Metropolis) Act, and the Act to Improve

Make Cor  
1853; the  
provisions  
merchant  
the Metr  
Building  
Acts, in  
which al  
vested i  
there hu  
for the  
1866; 'A  
Article  
Acts (in  
cluded  
wome  
dyeing  
factu  
cussi  
of f  
Act  
and  
in l  
Lat  
San  
The  
Pu  
wi  
fir  
tic  
ov

a  
c  
s  
c

of *post-mortem* examination may be provided. The third part of the act is headed 'Miscellaneous.' It treats of various points for the better management of lodging-houses, lays a penalty not exceeding £5 on any person with infectious disorder exposing himself, or on any person in charge of such a sufferer causing such exposure; and a penalty not exceeding £20 on persons letting houses, rooms, or part of a house in which infected persons have been lodging, without having such houses, or rooms, and articles therein, disinfected to the satisfaction of a qualified medical practitioner (the keeper of an inn is deemed to let part of a house to any person admitted as a guest into such inn). It is very much to be regretted that most of the provisions of this and other acts bearing on public health are permissive, and not peremptory.

We may note that since 1858 a Public Health Department has been established in the Privy Council, and that the Medical Officer of the Privy Council, Mr Simon, has, since that date, published an annual Report of the Proceedings taken under the Public Health Act, 1858. These Reports, of which nine have now appeared, are of the highest importance; and we should not omit to mention that the progress of sanitary science has been considerably advanced by the publication of an annual volume (of which seven have now appeared) of statistical, sanitary, and medical army reports, by the establishment of the Epidemiological Society and the Social Science Congress, and by the publication of their Transactions.

It is much to be regretted that the Privy Council does not more energetically carry out the powers conferred on them by the Diseases Prevention Act, 1855, and the Public Health Act, 1858. Unfortunately, however, it requires some comparatively rare and startling disease, as yellow fever, plague, cholera, or cattle-disease, to stir that august body into activity; while typhus, typhoid, and small-pox may ravage our crowded towns and undrained villages, and carry off their thousands of victims, unless in very extreme cases, to which the public press may have called attention. (Of the half million deaths that occur annually in England, more than 20,000 are due to typhus and typhoid; † while in England and Scotland, more than 5000 persons annually fall victims to small-pox. ‡) By the Sanitary Act, 1866, the Home Secretary is empowered to interfere, if he see fit, on complaint made to him of the default of any local authority. It is sincerely to be hoped that he will unsparingly put forth the power intrusted to him.

Passing from what has, and what has not, been done by government, let us consider what are the duties of local authorities, and how they discharge them. On this subject, Dr Stewart gives us much information in his pamphlet already referred to. To such an extent has non-interference prevailed that, except in London, the appointment of Medical Officers of Health, and even of inspectors of nuisances, is optional. He ascertained, that of 570 places under the Local Government Act, 1858, and the Public Health Act, 1848, with populations varying from 214 to 200,000, 50 have no inspectors

\* Liverpool alone, so far as we know, has as yet taken advantage of this clause. The Council have erected three mortuaries; and a mortuary chapel for the Roman Catholics has been built partly at the expense of Mr Hutcheson, a Protestant gentleman, and partly by subscription. (Stewart, *op. cit.*, p. 74.)

† According to Dr W. Budd, typhoid alone is the cause of from 15,000 to 20,000 deaths in England.

‡ For data on this subject, see the foot-note to p. 713.

inspector, and collector. In the metropolitan districts, with a population of above 3,000,000, the sanitary force is most unequally divided, for, while 2 subdistricts, with a population of 4000 and 10,000 respectively, have the services of one inspector, St Marylebone and St Pancras, with respective populations of 163,000 and 211,000, have each of them only two.

A few words on the duties, qualifications, and position of the Medical Officer of Health, will find a fitting place here.\* His duties and qualifications are thus laid down in an Instructional Minute of the General Board of Health, dated December 20, 1855: 'He will make himself familiar with the general features of the place, with its previous sanitary state, and with its existing provisions for health—viz., the levels, inclinations, soil, wells, and water-springs; with its meteorological peculiarities; with its burial-grounds, slaughter-houses, lodging-houses, &c.; he will see to the general healthiness of his district, inquire into the cleanly and waterproof condition of houses, examine the drinking-water, and observe whether diseased meat or adulterated articles of food are exposed for sale; and will report weekly and annually to the Local Board.' These are but a few of his duties, for the proper performance of which (as the Minute goes on to add), special qualifications in science are required. 'These lie in pathology, including vital statistics, in chemistry, and in natural philosophy.' For these accomplishments, the town of Aberdare offers 8*s.* a day, or 12 guineas a year, for looking after the health of its 35,000 inhabitants; while Paisley gives £20 for the sanitary superintendence of a population of 48,000. Fifty pounds is a common salary, except in the metropolis; the most liberal salaries are £350 at Birkenhead and Hackney, £400 at St Marylebone, £500 at Edinburgh and Leeds, £600 London (Proper), while Liverpool has nobly raised the salary to £1000. Surely £500, £600, and £1000 are not too much for Edinburgh, London, and Liverpool to pay, in order to secure the services of such men as Littlejohn, Letheby, and Trench. Dr Russell, the medical sanitary officer for Glasgow, has £600 a year; and Dr Gairdner, one of the first of our living hygeists, is retained as consulting officer at £100 a year. Not only is the medical officer's salary dependent on the caprices of the local board, who may dismiss him at pleasure, but, as Dr Stewart truly observes, 'the very efficiency with which he performs his duties may be an unpardonable sin in the eyes of a majority of his masters. His statements of facts may touch the interests of some, his suggestions of remedies may excite the displeasure of others; and if the soundness of his position cannot be assailed by reasoning, passion may suggest—as it has before now suggested—a reduction of salary or a threat of dismissal, as likely to bring the offender to his senses.' Not only is this disgraceful form of pressure brought to bear *directly* on the Medical Officer of Health, but *indirectly* on those who have the power of electing or dismissing him. An amusing incident of this nature is mentioned in Dr Stewart's pamphlet. When Dr Robinson was appointed Officer of Health for Leeds, he found that he had to grapple with unparalleled privy abominations,

\* On this subject Dr Letheby has published an excellent Memoir, which will be found in the *Medical Press and Circular* for August 7 and 14, 1867; and Dr Rumsey's address *On State Medicine in Great Britain and Ireland* (Lond. 1867), may also be consulted with advantage.

piggeries by hundreds, numerous slaughter-houses, the gigantic smoke-nuisance, and an average death-rate of 30 in 1000. The battle between science and filth was prolonged and terrific, and the piggeries were made the battle-field. The pig-owners, taking alarm at Dr Robinson's energy, formed themselves into a 'Pig Protection Society,' summoned ward-meetings, and commenced an active canvas for the purpose of turning out of the council all who would not pledge themselves to vote for Dr Robinson's dismissal. The case, after being twice heard before the magistrates, who declared that the pigs were a nuisance, and must be removed, was finally settled on appeal by the recorder, who gave an order, not for the eviction of the pigs, but for the daily removal of the manure, for the due enforcement of which a separate inspector would be required for every pig-sty! Under these conditions, is a Medical Officer of Health fairly encouraged to discharge his proper duties?

The next points to which we shall direct attention are the NUMBER OF DEATHS occurring annually in England and Wales, and the CAUSES OF THESE DEATHS; and we shall then proceed to inquire how far the deaths from some of our most fatal diseases might have been prevented by due attention to sanitary measures. We learn from the Twenty-eighth Annual Report of the Registrar-general of Births, Deaths, and Marriages in England, which was published in 1867, and gives the results for the year 1865, the following statistical facts, which bear more or less closely on our subject. The population of England, the births, deaths, and excess of births over deaths, are tabulated from the year 1838, when the system of registration came in force; and from this table we extract the numbers for 1838, 1848, 1858, and for 1861—1865 inclusive:

Years ending Dec. 31.	Estimated Population in middle of year.	Births (exclusive of still-born).	Deaths.	Excess of Births.
1838.	15,312,256	463,787	342,769	121,017
1848.	17,340,492	563,059	389,833	163,226
1858.	19,471,291	655,481	449,636	205,845
1861.	20,119,314	696,406	456,114	240,292
1863.	20,536,417	719,664	436,566	273,118
1865.	20,654,137	737,417	473,837	263,580
1864.	20,772,308	740,275	496,531	243,744
1865.	20,990,946	748,069	490,909	257,160

From these figures, we learn, *inter alia*, that in a quarter of a century the population has added 5,000,000 to its strength, and that there is a steady increase (with occasional exceptions) in the annual number of births and deaths, and in the excess of the former; the number of births having increased during that period 46 per cent., and that of deaths 43 per cent. The following is an abstract of Dr Farr's letter to the Registrar-general on the causes of death in England in 1865: In every 1000 deaths, 381 of the population fell before local diseases, 235 were struck down by zymotic diseases, 182 by constitutional diseases, 160 by developmental diseases, and 36 died violent deaths; the remaining 6 were deaths from causes not ascertained. *Local diseases*—the inflammations and functional diseases of organs—carried off 184,877 persons in England, causing 9 of the 23 deaths per 1000 of the living. It is the deaths from diseases of the vital organs that swell this number so high—22,272 deaths from heart diseases, nearly as many (21,774) from diseases of the digestive organs, more than thrice as many (69,952) from diseases of the respiratory organs so essential to life, and a number nearly as large as this last (60,264) from diseases of the nervous system. The number of deaths in England ascribed to bronchitis has rapidly increased; it was but 21,528 in

1856, had advanced to 32,346 in 1860, and in 1865 reached 36,423. Softening of the brain is another disease that has increased rapidly of late years, and in 1865 was fatal to 1051 males and 627 females: these deaths would formerly have been classed under paralysis and other heads. The deaths from diseases of the nervous system include 26,722 from convulsions, occurring chiefly in children. Among the rarer deaths from local diseases, 5 are referred to fright, 3 to grief, and 43 to melancholy. The second most fatal class of diseases—the *zymotic* (epidemic and contagious)—is swelled chiefly by fevers and by diarrhoeal disease. It swept from life in England 113,948 persons in 1865, the majority of them young children under 5 years of age. The deaths by cholera in England in 1865 were 1291; by diarrhoea, 23,531. The deaths by fever—typhus, typhoid, and typhina\*—which were 13,012 in the year 1860, rose to 23,034 in 1865, and five-tenths of them were registered among four-tenths of the population. The deaths from scarlatina were 17,700, and from diphtheria, 4145. The deaths attributed to syphilis rose to 1647; 437 persons died from intemperance, and 612 from *delirium tremens*; 74 from privation; 19 from hydrophobia; 4 from glanders, for horses as well as dogs communicate some of their diseases to men. Worms are put down as the cause of death in 153 cases, one of which is ascribed to *Trichina spiralis*. The third class of deaths is from constitutional diseases, diathetic or tubercular, which were fatal to 88,504 persons in 1865. These diseases have this in common with the zymotic, that they are diffusive; and human tubercle is, even when introduced by inoculation, capable of inducing tubercular deposits in the organs of animals. The prevalence of phthisis in the armies of Europe is considered to be probably due in part to the inhalation of expectorated tubercular matter, dried, broken up into dust, and floating in the air of close barracks. Dr Farr remarks that to test this may be difficult, but the origin and propagation of the most fatal of all human diseases deserves full investigation. The inquiry should also extend to cancer and the other constitutional diseases, among which should perhaps be included diabetes. Among the deaths from constitutional diseases may be noted gout, as increasing every year. Gout is five times as common in men as in women, and is very rarely fatal under 35 years of age. To it, 361 deaths were attributed in 1865. Unlike gout, dropsy is most fatal to women; and the substitution of dropsy in women for gout in men after the age of 45 is worthy the attention of pathologists. Cancer is more than twice as fatal to women as it is to men. The mortality by all constitutional diseases is rather less than it was in the

\* In the National Returns, all cases of fever are set down as Typhus, which is thus made to include pure Typhus, with blood-spots (*petechia*) on the skin, which is exceedingly fatal (more than 20 per cent of the cases in the London Fever Hospital proving fatal), is generated in crowded populations, and is very infectious; Typhoid or Typhoid Fever, which is endemic, is characterised by an eruption of rose-red spots on the skin, and by ulceration of Peyer's glands, and is usually generated by the intestinal evacuations of typhoid patients, which should therefore always be submitted to the action of disinfectant agents (its mortality in the London Fever Hospital is rather less than 20 per cent.); and, lastly, Typhina, which is commonly known as relapsing or *jaundice fever* (it is epidemic and infectious in times of scarcity and famine, and is comparatively harmless, the deaths amounting to only 2 per cent.). For the introduction of the terms Typhoid and Typhina, we are indebted to Mr Farr (see his 24th Annual Report of Births, Deaths, and Marriages in England, 1863, p. 214.

still these deaths reached 53,734 in 1865, the greater part of them occurring in adults; and more than half the deaths of young women between 20 and 25 were caused by phthisis. The fourth class of diseases—the *developmental*—were fatal to 77,806 persons in England in 1865: 8791 infants born alive died from being premature; and other 22,436 died of debility before they were a year old. Besides 1333 deaths by puerperal fever, and 2490 ascribed to childbirth, 490 women died of specific diseases complicated by parturition. The deaths by ordinary diseases of the 560,000 *enquire* women, constantly existing in the population of England, could not be entirely distinguished from the deaths of other women of the same age; of course they were subject to the same diseases as others, but probably the class of mothers belongs to what, in a certain sense, the insurance offices call select lives. The list of developmental diseases closes with the deaths of 28,709 persons from old age, 154 of the men and 402 of the women being of the age of 95 and upwards. Thus we reach the last class of deaths—the 17,374 persons who were destroyed by *violent deaths*; 15,232 by accident or negligence, 443 under circumstances bringing the case under the legal denomination of homicide, 1392 by suicide, 6 on the scaffold, and the remaining 301 not classed. These are the several ways in which 490,909 persons died in England in 1865.

Now let us see how many of the above diseases are more or less preventable, and how far we have already been successful in diminishing them. There are parts of England in which, for each 1000 persons living, there die annually only 15;\* while there are other parts that, of each 1000 persons, 30 or more† die annually. The 15 and the 30 are said to be the respective death-rates of these places. The average London death-rate is 25; and the most common death-rate in country districts and small towns through all England and Wales is 20. The Registrar-general's Return, published in January 1868, shewing the annual rate of mortality in the large towns of the United Kingdom for the year 1867, enables a comparison to be made of the death-rates in the last three years—1865 being the first year of the publication of these results. Thus, the average annual rate of mortality per 1000 persons living in the great cities in each of the years 1865, 1866, and 1867 respectively, was as follows: Birmingham, which is on one of the healthiest sites in the kingdom, 25, 24, and 24; the density of population (persons to an acre) in 1867, was 44. Hull, 27, 24, and 25; density, 30. Bristol, 24, 25, and 23; density, 35. Edinburgh, 28, 27, and 27; density, 40. Dublin, 26, 28, and 27; density, 33. Salford, 29, 29, and 29; density, 22. Glasgow, 33, 30, and 29; density, 87. Manchester, 33, 32, and 31; density, 81. Leeds, 31, 33, and 27; density, 11.

\* In an article on 'Public Health,' in the *Quarterly Journal of Science* for January 1868, it is stated that at Sandown, in the Isle of Wight, which is thoroughly drained and well supplied with pure water, the death-rate for the last five years has been only 11 in 1000. As a contrast, we may take the village of Child's Hill, in the parish of Hendon, in which there is no efficient drainage, and where the open cesspools connected with the privies often overflow into the ditches and discharge their contents into the river Brent. Here, out of an entire population of 1000, there were 70 deaths in 1867, mainly from epidemic typhoid.

† We have already mentioned that the death-rate at Liverpool not very long ago reached 70; see also the preceding note.

1867, was 28 and 25; density, 10. In Newcastle-on-Tyne the annual mortality, in 1866 and 1867 respectively, was 32 and 31. The results for London, in each of the three years 1865—1867 respectively, were, annual mortality per 1000 of population, 25, 26, and 23; density, 40. In comparing the rate of mortality in one town with that of another, it should be borne in mind that of the English towns, Bristol, Leeds, and Liverpool have each a medical health officer. Birmingham, Hull, Salford, Manchester, Sheffield, and Newcastle-on-Tyne have no medical health officer, but most of these towns, however, have benefited from the efficacy of hygienic measures. It is obvious that if, by sanitary precautions, we could reduce all the death-rates to 15, or even to 20, an enormous saving of human life would result.\* In the year 1865, Mr Simon suggested that the time was come for attempting to ascertain the amount of benefit to the public health that had been derived from the works of sanitary improvement—especially of drainage and water-supply—that had been already completed, and he was authorized to institute the inquiry, with the assistance of Dr Buchanan as an inspector. The result of the inquiry, which relates to 24 towns,† with an aggregate population of more than 600,000 persons, is now published, and we shall give a brief abstract of the results which have been obtained. The numerical results are given in the accompanying table (page 728), where A shews at each place in the list what difference there has been, since sanitary works were established, in the *general death-rate* in 10,000 of the population, this number being taken instead of 1000 to obtain more accurate numerical results. B gives the general death-rates of A, *minus* the inconstant influence which has been exerted by the chief infantile epidemics; and similarly E gives the means of eliminating from A the influence of the cholera epidemics of 1848—1849, 1854, and 1866. The columns C to G inclusive are for comparing the quantities of particular kinds of deaths caused in each of the places in the two compared periods. Such 'special death-rates,' used with caution, yield the most useful of all conclusions as to changes wrought in the public health.

From the table, which is fraught with the most valuable information, in the most condensed form, we learn that, omitting the influence of cholera, there has been a diminution in the death-rate in all but five cases, where the rate has been stationary. In four of the towns—viz., Cardiff, Newport (Mon.), Macclesfield, and Croydon—the reduction amounted to 24, 23, 20, and 18½ per cent. With regard to the *contagious diseases*, *small-pox*, which is capable of being rooted out by an efficient system of vaccination, is not noticed here, and *typhus fever* has scarcely occurred in the towns selected for inquiry. The time has hardly come for estimating the effect of works of sewerage and water-supply upon measles, scarlatina, and hooping-cough, inasmuch as epidemics of these diseases may revolve in long periods. *Measles* and *hooping-cough* seem, however, to have slightly declined. *Typhoid* has very much diminished with the ample supply of good water, and the

\* As in the year 1865, the population of England was 20,990,946, while the deaths were 490,909; the general death-rate for that year is 23.4. If this rate could have been reduced to 15, the number of lives thus saved in that year would have amounted to 176,324!

† Twenty-five towns were visited, but we have omitted Ottery St Mary, because it seems to have yielded no information.

SANITARY SCIENCE.

purification of the atmosphere from decomposing organic matter, by the abolition of cess-pools, by draining, &c. In Salisbury, Stratford, Croydon, and Merthyr, the annual death-rate from typhoid has diminished 75, 67, 63, and 60 per cent. respectively;

and in all the towns except three there was more or less diminution. In these exceptional cases, it was found that sewage gases were, by a defect of the outfall arrangement, forced into the houses.\* *Diarrhoea* appears to have been reduced by puri-

TABLE ILLUSTRATING THE IMPROVEMENTS OF PUBLIC HEALTH WHICH RESULT FROM PROPER WORKS OF DRAINAGE AND WATER SUPPLY.

Population in 1861.	Towns in Order of their Population.	Periods for which the Death-rates are compared.		DEATH-RATES PER ANNUM, TOTAL AND PARTICULAR, PER 10,000 OF GENERAL POPULATION, FOR EACH OF THE COMPARED PERIODS.																
				A		B		C		D		E		F		G		H		
				General Death-rates.	General Death-rates, after excluding Small-pox and other Infantine Epidemics.	Typhoid Fever.	Diarrhoea, excluding Cholera so called.	Cholera in each of the three Epidemics.	Phthisis.	Phthisis and other Pulmonary Diseases of Women aged 15-55.	Death-rates of Infants under one year of Age.									
160,714	Bristol, . .	1847-51	1862-65	245	242	215	205	10	6	10	9	82	11	1	31	25	16	13	54	53
				Before the Works.	After the Works.	Before the Works.	After the Works.	Before the Works.	After the Works.	Before the Works.	After the Works.	1848-50.	1864.	1864.	Before the Works.	After the Works.	Before the Works.	After the Works.	Before the Works.	After the Works.
65,036	Leicester, . .	1845-51	1862-64	264	252	236	225	14	7	16	19	1	10	..	43	29	17	16	84	81
				Before the Works.	After the Works.	Before the Works.	After the Works.	Before the Works.	After the Works.	Before the Works.	After the Works.	..	..	..	..	..	..	..	..	..
52,778	Merthyr, . .	1845-55	1862-65	332	262	292	221	21	5	11	6	267	84	20	38	34	15	13	80	61
				Before the Works.	After the Works.	Before the Works.	After the Works.	Before the Works.	After the Works.	Before the Works.	After the Works.	..	..	..	..	..	..	..	..	..
39,693	Cheltenham, . .	1845-57	1860-62	194	185	182	172	8	4	8	7	..	..	..	28	21	15	11	40	37
				Before the Works.	After the Works.	Before the Works.	After the Works.	Before the Works.	After the Works.	Before the Works.	After the Works.	..	..	..	..	..	..	..	..	..
32,954	Cardiff, . .	1847-54	1859-66	332	226	294	191	17	10	17	4	208	66	15	34	28	66	58	?	?
				Before the Works.	After the Works.	Before the Works.	After the Works.	Before the Works.	After the Works.	Before the Works.	After the Works.	..	..	..	..	..	..	..	..	..
30,229	Croydon, . .	1845-50	1857-64	237	190	207	178	15	5	10	7	27	21	2	?	?	59	49	?	?
				Before the Works.	After the Works.	Before the Works.	After the Works.	Before the Works.	After the Works.	Before the Works.	After the Works.	..	..	..	..	..	..	..	..	..
29,417	Carlisle, . .	1845-53	1858-64	284	261	244	225	10	9	11	12	22	6	..	32	35	16	16	71	65
				Before the Works.	After the Works.	Before the Works.	After the Works.	Before the Works.	After the Works.	Before the Works.	After the Works.	..	..	..	..	..	..	..	..	..
27,475	Macclesfield, . .	1845-52	1857-64	298	237	263	217	14	8	11	11	9	1	..	51	35	28	22	77	59
				Before the Works.	After the Works.	Before the Works.	After the Works.	Before the Works.	After the Works.	Before the Works.	After the Works.	..	..	..	..	..	..	..	..	..
24,756	Newport, . .	1845-49	1860-65	318	269	275	187	16	10	11	6	112	12	37	25	14	12	14	57	53
				Before the Works.	After the Works.	Before the Works.	After the Works.	Before the Works.	After the Works.	Before the Works.	After the Works.	..	..	..	..	..	..	..	..	..
25,108	Dover, . .	1843-53	1857-65	225	209	203	187	14	9	9	7	40	10	4	26	21	13	11	47	46
				Before the Works.	After the Works.	Before the Works.	After the Works.	Before the Works.	After the Works.	Before the Works.	After the Works.	..	..	..	..	..	..	..	..	..
10,570	Warwick, . .	1845-55	1859-64	227	210	209	191	19	9	5	8	10	..	..	40	32	16	14	51	46
				Before the Works.	After the Works.	Before the Works.	After the Works.	Before the Works.	After the Works.	Before the Works.	After the Works.	..	..	..	..	..	..	..	..	..
10,238	Banbury, . .	1845-53	1857-64	234	205	214	184	16	8	11	5	2	1	..	26	15	14	9	53	45
				Before the Works.	After the Works.	Before the Works.	After the Works.	Before the Works.	After the Works.	Before the Works.	After the Works.	..	..	..	..	..	..	..	..	..
9,414	Penzance, . .	1843-50	1856-65	221	222	197	200	7	5	5	9	..	..	..	30	29	13	14	?	?
				Before the Works.	After the Works.	Before the Works.	After the Works.	Before the Works.	After the Works.	Before the Works.	After the Works.	..	..	..	..	..	..	..	..	..
9,030	Salisbury, . .	1844-52	1857-64	275	219	253	198	7	1	6	2	180	14	..	44	22	53	38	43	40
				Before the Works.	After the Works.	Before the Works.	After the Works.	Before the Works.	After the Works.	Before the Works.	After the Works.	..	..	..	..	..	..	..	..	..
8,664	Chelmsford, . .	1843-52	1855-65	196	215	180	187	12	12	7	8	4	..	..	32	32	53	38	44	42
				Before the Works.	After the Works.	Before the Works.	After the Works.	Before the Works.	After the Works.	Before the Works.	After the Works.	..	..	..	..	..	..	..	..	..
7,847	Ely, . .	1845-52	1859-64	228	205	210	186	10	4	3	4	..	22	..	31	16	48	36	50	42
				Before the Works.	After the Works.	Before the Works.	After the Works.	Before the Works.	After the Works.	Before the Works.	After the Works.	..	..	..	..	..	..	..	..	..
7,818	Rugby, . .	1845-51	1855-64	191	186	164	164	10	9	2	7	..	..	..	28	16	15	7	42	45
				Before the Works.	After the Works.	Before the Works.	After the Works.	Before the Works.	After the Works.	Before the Works.	After the Works.	..	..	..	..	..	..	..	..	..
7,189	Penrith, . .	1845-52	1856-64	253	250	235	230	10	4	3	4	9	2	..	39	37	17	19	55	45
				Before the Works.	After the Works.	Before the Works.	After the Works.	Before the Works.	After the Works.	Before the Works.	After the Works.	..	..	..	..	..	..	..	..	..
6,823	Stratford, . .	1845-53	1860-64	217	202	212	178	12	4	11	5	..	..	..	26	26	14	13	45	48
				Before the Works.	After the Works.	Before the Works.	After the Works.	Before the Works.	After the Works.	Before the Works.	After the Works.	..	..	..	..	..	..	..	..	..
6,494	Alnwick, . .	1845-51	1856-64	262	247	240	221	13	8	7	4	205	..	..	28	53	13	17	?	?
				Before the Works.	After the Works.	Before the Works.	After the Works.	Before the Works.	After the Works.	Before the Works.	After the Works.	..	..	..	..	..	..	..	..	..
6,334	Brynmawr, . .	1843-52	1856-65	273	232	209	23	23	10	5	42	100	..	..	28	30	14	13	76	69
				Before the Works.	After the Works.	Before the Works.	After the Works.	Before the Works.	After the Works.	Before the Works.	After the Works.	..	..	..	..	..	..	..	..	..
5,805	Worthing, . .	1843-52	1857-65	155	153	139	136	7	9	4	2	5	..	..	30	19	14	9	24	22
				Before the Works.	After the Works.	Before the Works.	After the Works.	Before the Works.	After the Works.	Before the Works.	After the Works.	..	..	..	..	..	..	..	..	..
4,490	Morpeeth, . .	1845-52	1856-64	262	247	234	225	16	10	8	14	14	11	..	30	28	14	14	56	57
				Before the Works.	After the Works.	Before the Works.	After the Works.	Before the Works.	After the Works.	Before the Works.	After the Works.	..	..	..	..	..	..	..	..	..
3,840	Ashby, . .	1845-51	1855-64	216	202	213	184	13	3	4	8	..	..	..	25	31	16	13	48	31
				Before the Works.	After the Works.	Before the Works.	After the Works.	Before the Works.	After the Works.	Before the Works.	After the Works.	..	..	..	..	..	..	..	..	..

fication of air and water. Removal of subsoil water has not affected it. While in three towns the death-rate from this disease has been diminished 50 per cent. or more, in Ashby it has increased 100, and in Rugby, 200 per cent. These anomalous results are ascribed to the prevalence of the disease in the respective workhouses. *Cholera epidemics* appear, says Dr Buchanan, to have been rendered practically harmless in the towns examined, as may be seen by the comparison of the death-rates per 10,000 in the three last epidemics :

	1848-1849.	1864.	1866.
Merthyr, . . . . .	267	84	20
Cardiff, . . . . .	308	66	15
Alnwick, . . . . .	205	..	..
Salisbury, . . . . .	180	14	..
Newport, . . . . .	112	1	12
Brynmawr, . . . . .	100	..	..

*Pulmonary phthisis* has diminished in certain of the towns, and the diminution seems due to the drying of the soil, which has in most cases

accompanied the laying of main sewers; and the greater the influence of the sewerage in drying the subsoil is, so much the greater is the diminution of the death-rate from this disease. At Salisbury, it is 49 per cent. of its former rate; at Ely, 47; at Rugby, 43; at Banbury, 41; and at Worthing, 36. Failure to reduce consumption is

\* Worthing is the town in which the increase of fever is greatest, and this need not excite surprise when we learn that on the side of the water-tower of the town is a shed containing the engine which performs the double duty of distributing the water to the houses and the sewage to the land. To enable this to be effected, there are two wells within 50 feet of one another, sunk in a porous soil, one for the reception of the sewage, and the other for the drinking-water. Moreover, the water-well is in bad condition, and the water-supply is neither constant nor sufficiently abundant. See the article 'Seaside Drainage—Worthing,' in *The Medical Press and Circular*, December 4, 1867. No arrangement for the propagation of typhoid could have been more ingeniously devised!

drainage consisted of impervious pipes, laid down in compact channels, so that no extensive drainage of water could occur either through or alongside of them. It does not seem that the sewerage of towns, by the removal of excreta and house-slops, has acted to reduce the amount of their death-rate by consumption. Diseases of the lungs other than consumption have undergone no regular reduction. Dr Buchanan concludes this most valuable Report with the observation, that the progress made by the inhabitants of most of the towns in decency, cleanliness, self-respect, and morality, was at the least as striking as the improvement in their health, measured by the mortality returns.

In various articles on special disorders, as Scurvy, Small-pox, and Typhoid Fever, we have pointed out how completely they are under the control of sanitary or dietetic measures. In his excellent chapter 'On the Prevention of Diseases in the Army,' Dr Parkes gives the following list of diseases, with the methods to be adopted for their prevention—viz: (1) *Specific Diseases*—paroxysmal fevers, yellow fever, cholera, typhus exanthematicus, bubo plague, typhoid fever, relapsing fever, bilious remittent fever, eruptive fevers, erysipelas, hospital gangrene; and (2) *Non-specific Diseases*—dysentery and diarrhoea, liver disease, insolation, phthisis, scurvy, military ophthalmia (gray granulations on the palpebral conjunctiva), and venereal diseases.\*

It is the miasmatic diseases which form the first order of the class of zymotic diseases, which seem most under our control. We have shewn in a previous page that recent researches tend to shew that various of these diseases owe their origin to fungi. We shall conclude this imperfect sketch of the history, progress, and results of sanitary science with a history of the recently-discovered *cholera-fungus*, and with a notice of the other recent scientific investigations regarding the nature and prevention of this disease (which may be regarded as a supplement to the article CHOLERA). At the international congress held at Weimar, in 1867, the cholera-fungus was the great centre of interest. The subject had been investigated by Professors Hallier and De Bary, two of the leading German mycologists, and the latter drew up a Report, the following abstract of which is given by Mr Simon†: 'Both observers find in cholera evacuations, and in the intestinal mucus of the dead body, definite organic structures, zoogloea, consisting of excessively fine granules, clustered more or less densely in the interspaces of a jelly, which more or less abundantly surrounds them. The granules divide and subdivide themselves, to form beaded threads, which interlace, in immense numbers, into felted masses in the mucus. The further develop-

ment, and also abundant filamentous fungi (*cylindro-tenium*), on which grew cylindrical spores, capable of developing again to filaments. Views as to the mutual relations of these cells, filaments, and spores, are for various reasons to be expressed only with reserve; and the study of them is so immensely difficult, that definite results cannot at once be expected. The significance of these fungi would be greatly increased if they should be shewn to exist in the blood as well as in the bowels of the sick; but this, though from some inquiries it seems probable, must at present be deemed questionable.' It has been since ascertained that this fungus requires a high temperature (86° to 112° F.) for its fructification, and therefore cannot be of European origin. 'The doctrine of the cholera-fungus,' says Mr Simon—'the alleged discovery that the specific zymosis of cholera, the bowel-fermentation in respect of which it is contagious, has essentially associated with it, and perhaps as its immediate cause, a definite multiplying organic form—is not only of the utmost philosophical interest, but, should it be substantiated, may also, hereafter, be found capable of very important practical application. For, as one reflects on the doctrine in all its bearings, specially, as one considers Professor Hallier's conjecture (based on botanical considerations), that perhaps the *cylindro-tenium* is originally a blight of rice, something like a clue is for the first time suggested for investigations, which may hereafter conduce to the prevention of cholera in its eastern centres of origination. But for us in Europe, meanwhile, the doctrine may be absolutely sterile of results. In its broad signification, indeed, the discovery would not be a surprise to pathologists. The possibility has for some years past been recognised, that perhaps every fermentatory or putrefactive change of organic material has with it, and possibly as its cause, a characteristic molecular living thing; and however sure it may have become, that the choleraic zymosis answers to that possibility, it remains yet untried whether disinfection (which, after all, is but a doubtful resource) can deal better with the process on that basis, than on the purely chemical basis which has hitherto been the ground of our proceedings.'

'It cannot,' adds the same high authority, 'be too distinctly understood that the person who contracts cholera in this country is *ipso facto* demonstrated, with almost absolute certainty, to have been exposed to excremental pollution; that what gave him cholera was (mediately or immediately) cholera-contagium, discharged from another's bowels; that, in short, the diffusion of cholera among us depends entirely upon the numberless filthy facilities which are let exist, and specially in our larger towns, for the fouling of earth, and air, and water, and thus,

\* In connection with diseases or affections which may be totally, or in a very great measure prevented, is short-sightedness. Dr Cohn, of Breslau, has examined the eyes of 10,060 school-children, out of which number 1730, or 17·1 per cent, were found to be short-sighted. No village-children were affected until they had been at least half a year at school. Dr Cohn attributes the evil, in a great measure, to the bad construction of the school-benches, which force the children to read with their books close to their eyes, and with their heads inclining downwards.

† A much fuller abstract (by Dr Buchanan) of Professor Hallier's recent researches into the natural history of the cholera contagion, as contained in his pamphlet, entitled *Der Cholera-Contagion: Botanische Untersuchungen, Aertzen und Naturforscher mitgetheilt*,

1867, is given in pp. 512—515 of the Appendix to Mr Simon's Ninth Report, to which that able pathologist has added a most instructive note on the earlier microscopic observations that had been instituted, especially by our own countryman, on the cholera evacuations. On the subject of cholera the reader should also consult Dr Parkes's *Sanitary Report (Army Medical Department) for 1865* (published in 1867), in which he discusses the recent additions to our knowledge of (1) The specific cause of cholera—the cholera-fungus; (2) The spread of cholera by intercourse; (3) Its communication by the so-called premonitory diarrhoea; (4) Its spread by the agency of water; (5) and its prevention by disinfecting the discharges by means of carbolic acid, sulphate of iron, and salts of zinc.

'Cholera, ravaging here at long intervals, is not nature's only retribution for our neglect in such matters as are in question. Typhoid fever and such endemic diarrhoea are, as I have often reported, incessant witnesses to the same deleterious influence; typhoid fever, which annually kills some 5,000 to 20,000 of our population, and diarrhoea, which kills many thousands besides. The mere want of this wasted life is horrible to contemplate, and the mode in which the waste is caused, is surely nothing less than shameful. It is to be hoped that, as the education of the country advances, his sort of thing will come to an end; that so much preventable death will not always be accepted as a fate; that, for a population to be thus poisoned by its own excrement, will some day be deemed ignominious and intolerable.'

In conclusion, we may remark, that Mr Simon's fifth Report for 1866 (published in 1867) is one of the most valuable contributions to the literature of cholera that has ever been presented to the profession. The history of this disease in England in 1866 is not given. This is followed by a series of scientific investigations on the following points: (1.) Examination of the degrees of success attained by different methods of *treatment* of cholera at Guy's, St Bartholomew's, the London, and St Thomas's Hospitals; (2.) Study of the successive *chemical changes* undergone by the body in cholera; (3.) Similar study, chiefly *microscopical*, of the successive *anatomical changes* of the affected body; (4.) Collection of facts as to the non-coincidence of local epidemics of cholera with such conditions of the local ground-water as are indicated by a foul state of the surface-wells. The results of these studies are given in the appendix. Unfortunately, the practical result of these inquiries is, that in cases of developed cholera 'our utmost power is but perhaps some very little ability of palliation, and in the treatment of incipient cholera competent physicians are not agreed that even here their art has much efficiency.' In contrast with the powerlessness of curative medicine, the power of preventing it is about the happiest possession of science. The evidence of Dr Buchanan and others clearly shows that cholera may be prevented by due attention to sanitary works, which provide for the prompt and complete removal of *fæcal impurities*, and the plentiful supply of water which cannot have been exposed to this form of contamination. In addition to the works quoted in this article, we may refer those of our readers who wish to study the subject more fully, to the French treatises on hygiene by Becquerel, Levy, Tardieu, Vernois, and others. There is, however, no work on the subject in any language equal to that of Dr Parkes, from which we should not have ventured to borrow so freely if we had not had the author's kind permission to do so.

**SAN JUAN DE LA FRONTERA**, a town of the Argentine Republic, the capital of a province of the same name in the extreme west of the Republic. The town, 660 miles north-west from Buenos Ayres, stands on the right bank of a river, also called San Juan de la Frontera, which rises in the Andes, and falls into the large salt lake of Luanacache. The province is as yet only very partially settled, but exports considerable quantities of fruits and wine. The chief seat of trade is this town, which has a pop. of 20,000, almost one-third of that of the whole province.

**SAN LUIS DE LA PUNTA**, the chief town of the province of San Luis in the Argentine Republic,

and furs. Pop. above 5000.

**SAN MARCO IN LA MISA**, a town of South Italy, in the province of Foggia, 18 miles north-north-east of Foggia. It has some trade in corn, wine, oil, and silk. Pop. above 15,000.

**SAN MATEO**, a town of Venezuela, South America, in the department of Cumana, and 50 miles south-south-west of the town of that name. Pop. 7000.

**SAN SALVADOR**, or **BANZA**—the former being the Portuguese, and the latter the native name—a town of Africa, the capital of Congo (q.v.). It is 120 miles south-east-by-east from the mouth of the estuary of the river Congo, in a mountainous district near the source of the river Lelunda. Pop. 20,000.

**SANTA ANNA**, or **ANA**, a town of Central America, in the state of San Salvador, and 32 miles north-west-by-west from the town of San Salvador. Pop. about 10,000.

**SANTA FE**, a town of the Argentine Republic, on the right bank of the Salado, a large branch of the Parana, 250 miles north-west-by-north from Buenos Ayres. Pop. 15,000.

**SANTA MARTA**, a town of the United States of Colombia, the capital of a province, on a bay of the Caribbean Sea, 400 miles east-north-east from Panama. There is a good harbour, defended by a castle and several batteries. Pop. 8000.

**SARAGOSSA**, or **ZARAGOZA**, a city of Spain, the capital of a province of the same name, and formerly of the kingdom of Aragon. It stands on the Ebro, here a muddy stream, which divides the city into two parts, and is crossed by a noble stone bridge, built in 1437. The city has an imposing appearance from a distance, being adorned with numerous slender towers and spires; but the traveller, on entering it, finds it full of narrow winding lanes, instead of streets, although the houses—which are built of brick—are of most solid structure, and many of them are the palaces of a nobility who have now ceased to reside here. These buildings, rich in finely carved decorations and magnificent cornices, are now mostly inhabited by agriculturists of a rude class; their spacious courts converted into farm-yards, and filled with dung-heaps. Everything about the city indicates decay and poverty. S. was the Celtiberian *Salduba*, but received the new name of *Cæsarea Augusta* in 25 B.C., of which the present name is a corruption. It was a place of importance under the Romans, but there are few remains of the Roman city. S. was one of the first cities of Spain in which Paganism was generally renounced and Christianity adopted; it afterwards became rich in relics, to which miraculous powers were ascribed. S. was taken by the Moors in the 8th c., and recovered from them in 1118, after a siege of five years, during which great part of the inhabitants died of hunger. It was taken by the French in 1809, after a siege of eight months, and one of the most heroic defences recorded in the history of modern warfare. See **PALAPOX**. S. has a university, founded in 1474. It has two cathedrals, both interesting as specimens of architecture; but the older is in a simple and severe style; the modern one—that of *Nuestra Señora del Pilar*—is very ornate. The latter cathedral boasts of a pillar on which the Virgin descended from heaven, 40 A.D.—an event so strongly attested, that Diego de Astorga, primate

neighbouring parts of Spain to this point and the image of the Virgin, which came down from heaven. S. suffered grievously at the hands of the French in 1809, and lost most of its treasures of art. It has a considerable trade in agricultural produce, mostly carried on by the Ebro; and manufactures of silks, woollens, and leather. Pop. about 63,500.

**SARANSK**, a town of European Russia, in the province of Penza, and 80 miles north from Penza, at the confluence of the Saranga and Insara, feeders of the Sura. Pop. (1867) 14,284.

**SATA'LIAH**, another name of Adalia (q. v.).

**SAU'GOR**, a town of India, the chief town of the British district of the same name, is situated in a hilly tract, on the Bees or Bes, a feeder of the Jumna, in lat. 23° 50' N., and long. 78° 49' E. S. is the seat of a military cantonment and of a collegiate school. The elevation is so considerable, that the climate is moderately cool; but the cantonment is unhappily in a swampy and unhealthy situation. Pop. about 50,000, mostly Maharrattas.

**SCY'LLI**, a town of Sicily, in the province of Noto, on the small river Scicli, 21 miles west-south-west from Noto. The woollen manufacture is carried on. S. is supposed to be the ancient *Casmena*. Pop. 10,029.

**SCOT AND LOT VOTERS**. The old legal phrase *Scot* (Ang.-Sax. *scet*, pay) and *Lot* embraced all parochial assessments for the poor, the church, lighting, cleansing, and watching. Previously to the Reform Act, the right of voting for members of parliament and for municipal officers was, in various English boroughs, exclusively vested in payers of *Scot* and *Lot*.

**SCRIBE, AUGUSTIN EUGÈNE**, a French dramatic writer, son of a wealthy silk-mercator of Paris, was born in 1791. Educated for the legal profession, he soon deserted it for dramatic authorship. His first piece, *Les Dervis*, written by him in conjunction with Germain Delavigne (brother of Casimir Delavigne), was played in 1811, but till 1816 he cannot be said to have achieved a decided success. Since that time, pieces, chiefly vaudevilles, from his pen have followed each other with the most astonishing rapidity; and in such demand were they at the hand of theatrical managers, that S. established a sort of dramatic manufactory, in which numerous *collaborateurs* were constantly at work under his supervision. His plots are interesting, and his dialogue light and sparkling; and not a few of his pieces have been adapted for the English stage. S. also wrote various novels, and composed the *libretti* for a considerable number of well-known operas, including *Masaniello*, *Fra Diavolo*, *Robert le Diable*, and *Les Huguenots*. He was admitted a member of the French Academy in 1834, and died February 20, 1861.

**SEMMES, RAPHAEL**, American naval officer, was born in Maryland about 1810, in 1828 entered as midshipman in the sloop-of-war *Lexington*, and was employed in the service as passed midshipman and lieutenant until 1855, when he attained the rank of commander. In 1858, he was appointed Secretary to the Light-house Board; but resigned March 26, 1861, joined the naval service of the Confederate States, and was appointed to the command of the war-steamer *Sumter*. The career of Captain S. until the sinking of his famous ship, the *Alabama*, by the American war-steamer *Kearsage*, is described at length in the article ALABAMA in the

*Deerhound*, and brought to England, where he expected to take command of one of two rams built at Liverpool for the Confederates, but which were seized by the British government. He returned to America, was included in the surrender, and was elected Judge of Probate at Mobile, Alabama; but, being prohibited by the Federal authorities, he was, in 1866, appointed Professor of Moral Philosophy in a southern university. He published the *Cruise of the Alabama and the Sumter*, in 1864; and *My Adventures Afloat* in 1869.

**SERAING**, a town of Belgium, in the province of Liege, and between three and four miles south-west from Liege, on the right bank of the Meuse. It is a station on the railway between Namur and Liege, and is connected by a handsome suspension bridge with the village of Jemeppe, on the left bank of the Meuse. S. is a place of great activity, and contains a manufactory of steam-machinery, locomotives, &c., which is probably the largest in the world. This manufactory was established by an Englishman, John Cockerill, in 1816; the king of Holland, to whose dominions Belgium then belonged, joining him in the enterprise. After the revolution of 1830, Cockerill bought up the shares belonging to the king of Holland, and the works became entirely his own. On his death in 1840, a company was formed, called *La John Cockerill Société*, to which they now belong. They occupy the former palace of the Prince-bishops of Liege, which still forms their front, the extensive gardens behind it having been covered with buildings, where all the processes of machine-making are carried on. Forty or fifty tall chimneys are clustered on this spot. The town depends on these works for its prosperity. Pop. (1870) about 22,000.

**SEWAGE EARTH-CLOSET**. In addition to the various arrangements noticed under *SEWAGE* for getting rid of the excreta unavoidably present in every dwelling-house, there is partially in use an *earth-closet*, depending on a peculiar principle. In the cess-pool system, night-soil accumulates in a way and to a degree that render removal very noisome and repulsive; if this removal be delayed too long, the atmosphere of the house becomes tainted in an unwholesome degree. In the water-closet system, the refuse, when flushed with water, is carried off through a costly system of brick sewers, too often into a river, the water of which becomes sadly polluted thereby. In the former case, the soil may possibly be made available as agricultural manure; and in the latter case, a similar useful application may be possible, if the sewage in a liquefied state be so diverted as to be conveyed by pipes to fields or farms. But in the earth-closet system, the refuse is made innocuous almost from the first. Experience has shewn that dry powdered earth, whether field-mould or fire-ash, has a remarkable deodorising effect on night-soil, doing that which no dilution by water is able to effect. The fact has been known more or less, for a long time, to chemists engaged in sanitary inquiries; but the Rev. Henry Moule, vicar of Fordington, in Dorsetshire, has pursued the subject to a successful issue, first for the benefit of villages, and then of towns, hospitals, barracks, and other places in which large bodies of persons congregate. Having found that 1½ lbs. by weight, or 1¼ pints by measure, of dry earth is sufficient for each time of using the earth-closet, he has devised various modes of applying it.

The *commode* form is the smallest, for use in bedrooms, sick-rooms, &c. Under the seat is a metal



## SEWAGE EARTH-CLOSET.

pail, removable through a front door; while at the back, and above the level of the seat, is an earth-box, filled from the top. Either by a handle which pulls upwards, or by a lever hinge which makes the seat itself move slightly, a valve at the bottom of the earth-box is opened, and a definite quantity of earth falls into the pan. If the quantity is about as above stated, and if the earth be perfectly dry, the prevention of offensive odour is surprisingly complete. The earth-box will hold from 20 to 30 of these portions. The contents of the pail may be emptied at leisure, for they remain nearly inodorous from first to last. They may be either applied at once as a manure to garden or field, or may be kept in a heap under cover till wanted. One remarkable fact in this system is, that the same earth may be used two, three, or even seven times over, if it be well dried after each using; it becomes then exceedingly rich as a manure, and yet less offensive to the senses than what results from the use of cess-pools or water-closets.

The *single fixed closet* is adapted for use in the places usually occupied by a privy or a water-closet; indeed, the earth-measuring and delivering apparatus may be applied to most existing closets, as a substitute for the water-tank and pipes. Unlike the commode, there is a cell or vault instead of a pail beneath the seat; this cell may be four feet by three, and of a depth depending on the frequency with which it is intended to be emptied; the sides should be lined with cement, and the bottom paved with stone or asphalt. An existing cess-pool, emptied, cleansed, and perhaps made shallower, would in many cases be available. The mixture of refuse and earth might go on accumulating for a whole year, with very little appreciable odour. In places where a pit or cell cannot conveniently be made, a movable iron trough may be substituted, emptied more frequently.

*Compound closets*, for use in schools, barracks, and other places, may consist of as few as two or as many as twenty, placed side by side. There may be a great saving of material and construction; but the earth-apparatus must be applied to each separately.

Two important conditions apply to the success of this system—the obtaining of the earth, and the disposal of the deposit. Dr Mouat, Inspector-general of Jails in India, has caused experiments to be made which shew that dry earth is really better than any chemical disinfectants for removing all odour from night-soil. If earth is not readily obtainable, it may be supplemented by sifted ashes. Iron drawers or trays under a kitchen-range, portable dryers of various kinds, and fixed dryers, have been devised for drying the earth; this is a matter that can soon be brought into working order, if the system were adopted in other ways. Dry earth might be procured in the summer, and stored in a cellar or vault for winter use, just as we are wont to lay in a store of coals. No sand should be used with the earth and ashes; it is not suitable. No house-slops of miscellaneous kinds should be thrown down into the pail or pit; the deposit should not artificially be liquefied. The dry-earth system is applicable to urinals at railway stations and other places where the present existing system produces most offensive and unhealthy odours; but a peculiar adjustment of apparatus would be necessary.

The disposal of the deposit, like the obtaining of the earth, is more practicable in the country than in towns; for the simple reason, that fields are near at hand; and it is probable that country districts and large establishments will test the efficacy of the system before it is much tried in ordinary dwelling-

houses in towns. From twenty to thirty shillings per ton may be obtained for the refuse.

Many evidences have been brought forward of the successful adoption of this system. Captain Armytage, governor of the West Riding Prison at Wakefield, stated, in 1867, that earth-closets have been placed in the cells of that building, with a manifest diminution of the unpleasant odour which used to pervade many sections of the prison during the existence of the water-closet system. A small kiln has been built for drying the earth, and a store for earth provided; the used earth is turned over and pulverised a few times during a month, and is then fitted to act as manure; and it is expected that this manure will gradually defray all the expenses incurred by the adoption of the system. In the Dorset County School at Dorchester, where a severe sickness was attributed by the medical men to the noisome effluvia from the school-privies, the earth-closet has produced a marked improvement. The same result has followed in a large private school in Sussex. In the villages of Halton, Buckland, Weston Turville, and Aston Clinton, on Baron Rothschild's estate in Buckinghamshire, the earth-closets have been adopted, with a complete removal of the offensive results of the former cess-pool system; the earth is used six or eight times over, becoming in the end a very rich manure; and one man and a boy, with a horse and cart, suffice for all the carrying and removal at the four villages. The Registrar-general of Births, Marriages, and Deaths, in his Quarterly Return for July 1867, speaks of the earth-closets as promising 'to be as useful in the departments of public health and national agriculture as the Rev. Edward Cartwright's invention is in the cotton manufacture.'

Arrangements have been made by the government for the adoption of the earth-closet system on a very large scale in India. In the hospitals, jails, and lunatic asylums of Bengal; in the jails of the North-west Provinces; in the dispensaries and prisons of the Punjab; in the jails of Oude, the Mahratta Provinces, Mysore, Coorg, and Hyderabad; in the *latrines* of some of the barracks and military stations—in all of these, the system is now adopted. The medical officers with one voice speak of the favourable result. The Secretary of State for India, in September 1867, made public a communication from Major Malleon, Sanitary Commissioner for Bengal, enclosing Reports which he had received from the various provinces concerning the earth-closet system. In one of these Reports, Dr Mouat, already mentioned as Inspector-general of Jails in India, went so far as to characterise the introduction of this system as 'the greatest public benefit conferred by a private individual, in a matter so essential to public health, with which I am acquainted.' The Council of India have very properly made a recognition of the services rendered, without any intention of profit, by the clergyman who has pursued this subject to a successful result.

The Metropolitan Association of the Medical Officers of Health, has advantageously devoted a portion of its attention to the discussion of the comparative merits of the water-closet and dry-earth systems. Opinions are mostly in favour of the dry-earth system, in consequence of the readiness with which water-closets get out of order (especially in the dwellings of the poor), and thus become sources of grave danger. On this subject, Dr Parkes, in one of his annual reports on hygiene (*Army Medical Reports*, 1867), observes: 'That the earth plan, which has proved most useful in India, can be applied in England advantageously on a small scale, is certain; but it is still a question

One hundred pounds of earth per week would be required for a household of six persons. Sewerage in the great towns is advancing more generally than the earth-closet system.

**SHAHJEHANPORE**, a town of British India, the principal place of a district of the same name, North-west Provinces. It stands on the Gurrah, a feeder of the Ramgunja, 94 miles north-west from Lucknow. Pop. (1871) 71,719.

**SHAKERS**, the name commonly given to a small religious sect existing in the United States of America. The proper or official description of this sect is the United Society of Believers in Christ's Second Appearing; but its members seem to have accepted the designation of Shakers, though it was originally applied to them in ridicule, on account of certain rhythmical movements of the hands and arms which form part of the ceremonial of their worship. Though the Shaker Societies are found only in the United States, their creed had an English origin. The founder of the sect, in whose person they believe that Christ has appeared a second time, was an Englishwoman, named Ann Lee, a native of Manchester, who emigrated to New York with a small band of disciples, shortly before the outbreak of the revolutionary war.

Ann Lee was the daughter of a blacksmith, who lived in Toad Lane in Manchester; a very poor man, who gave her no education, and sent her while a mere child to work in a cotton-mill. She seems to have been a violent, hysterical girl, ambitious of notice, and fond of power, and to have always possessed, in virtue of her strong will and vehement temper, a great deal of influence over the people around her. She married, while very young, a blacksmith named Stanley. She had four children, all of whom died in infancy—to this, perhaps, may be ascribed the preference of the celibate to the married life, which she ultimately raised into a part of her religious system. She became one of the earliest believers in a prophetess, who appeared about a hundred years ago, in the town of Bolton-on-the-Moors, in Lancashire—a poor woman, named Jane Wardlaw, the wife of a tailor, who believed she had 'received a call' to go forth and testify for the truth. The burden of Jane Wardlaw's message was, that the end of all things was at hand, that Christ was coming to reign upon the earth, and that his second appearance would be in the form of a woman, as prefigured in the Psalms. In subordination to this, she took up several of the tenets of the Society of Friends, to which she and her husband originally belonged; especially, she raised her voice against war and against profane swearing. Her followers believed that she was filled with the Holy Spirit; they received her utterances as the voice of God; and she acted as if all the powers of earth and heaven had been given into her hands. Ann Lee, on her conversion, began to preach the same message in Toad Lane and the adjacent streets of Manchester; but she soon went beyond her teacher, and gained the leadership of her co-believers for herself. It happened that she was brought before a magistrate, charged with an obstruction of the streets, caused by the crowd collected to hear her preach, and she was sent to the Old Bailey Prison in Manchester. When she came out of prison, she gave forth, that one night, a light had shone upon her in her cell; that the Lord Jesus stood before her; and that He became one with her in form and spirit. Her pretension was, that Christ was come to reign in her person. It was favourably entertained by the followers of Jane Wardlaw; and they

received a revelation that she should seek in America a home for herself and her few disciples—that it was in America that the foundations of Christ's kingdom were to be laid. So she went to New York, accompanied by seven disciples—five males and two females. Her husband also went with her; but he seems to have had no faith in her, and he left her soon after their arrival, in consequence of one of the features then introduced into her system. This was the practice of celibacy, which she had not previously enforced upon her followers, though she had enjoined it as a duty. Her teaching was, that men called into grace must live as the angels do, among whom there is no marrying or giving in marriage; that no form of earthly love could be allowed in the Redeemer's kingdom. Finding a populous city unfavourable to her designs, she removed, with her followers, first to Albany, then far into the wilderness to Niskenna, and there founded the settlement which still exists, of Water Vliet. It was in the spring of 1780—when she had been three years and a half at Niskenna, looking for new believers to come in, but making no attempt to win them—that the first American converts joined her Society. A revival had taken place at Albany, and had spread through the surrounding districts; and from Hancock and New Lebanon a deputation was sent to Niskenna, to see what light its inhabitants enjoyed as to the way of salvation. The deputation consisted of Joseph Meacham and Lucy Wright—subsequently the heads of the Shaker Society. These persons became believers in Ann Lee; and through their agency, other converts were won, and a Shaker Society established at New Lebanon. Towards the close of 1780, the revolutionary war being then in progress, notoriety was given to Ann Lee's pretensions, through an incident seemingly unfavourable. Owing to her British origin, her denunciations against war, and her refusal to take the colonial oaths, Ann was imprisoned for some time at Poughkeepsie, on suspicion of being a British spy. Before she was let out of prison, in December 1780, all the colonies had heard of 'the female Christ.' In the following year, she started upon a missionary tour through New England and adjacent colonies; she found the people everywhere curious to see her, and she made not a few converts. She did not return to Water Vliet till September 1783; and about a year after, she died. Her death was a surprise to many of her followers, who believed that she was to live among them for ever; but her successors—the Joseph Meacham and Lucy Wright already mentioned—to whom, on her death-bed, she had made over the headship of the Society, were ready with a theory accounting for it. 'Mother Ann,' they said, could not die, and was not dead, and had not ceased to live among her people. She had only withdrawn from the common sight; she was still visible to eyes exalted by the gift of grace; she had cast the dress of flesh, and was now clothed with a glory which concealed her from the world. So it would be with every one of the saints in turn; but the spirits of those who 'passed out of sight' would remain near and be in union with the visible body of believers. This explanation was generally accepted, and has become a vital part of the Shaker creed.

By Joseph Meacham and Lucy Wright, the successors of 'Mother Ann,' the S. were gathered into

settlements, ten in number; and a covenant was drawn up embracing the chief points of their creed, and of the social system since associated with it. Their head was, of course, 'Mother Ann'—that is, Christ—of whom Joseph and Lucy were temporarily the representatives; elders and deacons, male and female, were appointed; the institution of celibacy was confirmed; and a community of goods was introduced. On the death of Joseph Meacham in 1796, 'Mother Lucy' became the sole head of the Society, and she governed it with ample powers for 25 years. She named a female successor with the title of Eldress; and the name of 'Mother' has not, since that time, been applied to the female head of the community. The present female head is Eldress Betsy (Betsy Bates); the chief elder is Elder Daniel (Daniel Boler); and the ruling spirit of the Society, the official preacher and expositor of Shaker doctrine, is Elder Frederick of New Lebanon (Frederick W. Evans), who is by birth an Englishman. The S. were, at the census of 1870, about 9000 in number, included in 18 societies; of which three are in the state of New York, four in Massachusetts, two in New Hampshire, two in Maine, one in Connecticut, four in Ohio, and two in Kentucky. Their numbers have increased since 1870; the influence of their opinions has greatly increased; and the 18 separate settlements continue to form a united and peaceful Society.

Their doctrine has been to some extent developed as well as systematised since the death of 'Mother Ann.' They believe that the kingdom of heaven has come; that Christ has come upon earth a second time, in the form of 'Mother Ann,' and that the personal rule of God has been restored. Then they hold that the old law has been abolished, and a new dispensation begun; that Adam's sin has been atoned; that man has been made free of all errors except his own; that the curse has been taken away from labour; that the earth and all that is on it will be redeemed. Believers, on going 'into union,' die to the world, and enter upon a new life, which is not a mere change of life, but a new order of being. For them, there is neither death nor marriage; what seems death is only a change of form, a transfiguration which does not hide them from the purified eyes of the saints; and in union, as in heaven, there is no marrying or giving in marriage—the believer owes love to all the saints, but his love must be celibate in spirit and in fact. The believer, living in union, is in heaven. The S. believe that the earth, now freed from the curse of Adam, is heaven; they look for no resurrection besides that involved in living with them in 'resurrection order.' The believer, upon entering into union, leaves behind all his earthly relationships and interests, just as if he had been severed from them by death. And since to be in union is heaven, the S. hold that no attempts should be made by them to draw men into union: God, they say, will draw to them those whom he has chosen at his own time. Those who have 'passed out of sight' are still in union; and the S. live in daily communion with the spirits of the departed believers. The belief in a communion with angels and spirits, is no mere theory; it has a most important influence upon their lives; they profess to be more familiar with the dead than with the living. It being the work of the saints to redeem the earth from the effects of the curse, labour is a sacred and priestly function, especially when bestowed in making the earth yield her increase, and in developing her beauty. It should be done in a spirit of love; the earth, they say, yields most to those who love it; and love and labour will in time restore it to its primitive state.

According to Mr Dixon, they bestow upon their gardens and fields the affections which other men bestow upon family or worldly goods. Their country they regard only as it is a part of the earth, which they love, and as the favoured land in which God's kingdom is first to be established. In its politics and its fortunes, they take no interest; and, indeed, their whole system is a protest against the existing constitution of society, as well as against the ordinary lives of men. Consistently with their belief in the second appearance of Christ in the form of a woman, the S. seem to believe that there is a female as well as a male essence in the Godhead—in the motherhood as well as the fatherhood of God.

A Shaker settlement is, for convenience, divided into families, consisting of the brothers and sisters, who live in the same houses, each governed by an elder and an eldress. There are two orders of members, Probationers and Covenanters—that is, novices and full members. It is on becoming a covenanter that the Shaker puts his property into the common stock. On entering upon residence, he becomes subject to all the rules of the Society; but he is free—whether a covenanter or a probationer—to leave the body whenever he pleases. Both men and women wear a prescribed dress. The men wear a sort of Arab sack, with a linen collar and no tie; an under-vest buttoned to the throat, and falling below the thighs; loose trousers, rather short; and a broad-brimmed hat, usually of straw. The women wear a small muslin cap, a white kerchief round the chest and shoulders, a skirt dropping in a straight line from the waist to the ankle, white socks, and shoes. Some latitude is allowed as to the materials of the dress. Men and women, it is said, have the look of persons at peace with earth and Heaven. 'Apart from a costume,' says Mr Hepworth Dixon, 'neither rich in colour nor comely in make, the sisters have an air of sweetness and repose, which falls upon the spirit like music shaken out from our village bells.' [*New America*, by W. Hepworth Dixon (Lond. 1867), from which the materials of this sketch have in a great measure been derived.] All labour with their hands, both men and women; but the latter do only indoor work. Every man, whatever his rank in the church, follows some manual occupation, and most of them have more than one. Working not for gain, but with loving care, and with the sense that they are exercising a priestly function, the S. are unrivalled among their neighbours in the arts to which they apply themselves, especially the culture of their land, and the production of fruits and flowers. They pay great attention to ventilation and to all sanitary conditions; they live almost entirely upon the produce of the soil, and drink only water; they employ no doctors, and take no drugs, and are, nevertheless, among the healthiest of communities. Their Society is recruited mostly by young men and girls; but occasionally, married persons with their children come 'into union,' and make, it is said, 'very pretty Shakers.' Husbands and wives, when they have come 'into union,' become as brothers and sisters: it would be thought a weakness, says Mr Dixon, and almost a sin, for them to feel any personal happiness in each other's company—they live for God alone, and their love ought to be shed on all the saints alike. The education of the children attached to the Society is the work of the sisters, and they do it exceedingly well. The brothers and sisters take their meals in a common room, eating at six in the morning, at noon, and at six in the afternoon. Their meals are taken in silence, any direction that has to be given being given by a gesture or in a whisper. In their church-service, music bears a prominent part; the hymns and chants which are used being

all of Shaker origin, communicated to believers in dreams and reveries by the spirits with whom they have communion. A deputation of Shakers visited England in 1871, and made many converts.

**SHINGLES** (probably derived from Lat. *cin-gulum*, a belt) is the popular name for the variety of *Herpes* (q. v.) which is known as *H. zoster*.

**SHIP-BROKER, INSURANCE BROKER.**

A ship-broker is a person employed in the buying and selling and freighting of ships. His duties include adjusting the terms of charter-parties and bills of lading, settling with the master for his salary, collecting freights on goods brought into port, arranging with passengers for the terms of their passage, and generally managing all business transactions occurring between shipowners and the shippers or consignees of goods. The charges made by ship-brokers are generally about two per cent. on their gross receipts. Ship-brokers have been ruled not to be within the acts for the regulation and admission of brokers.

The business of an *insurance broker* is usually combined with that of a ship-broker. Marine insurance is in Great Britain to a large extent transacted by brokers. Those who insure are in most cases capitalists, who are known to the broker as persons prepared to undergo any risks which he recommends to them. The broker, who has a list of persons ready at a moment's notice to underwrite a policy, is the mutual agent for both parties. He procures the subscriptions of the underwriters, arranging with them the rate of premium and conditions of the risk, receiving from them the amount of their respective subscriptions, in the event of loss; and, when such loss is partial, arranging the proportion to be recovered from the different underwriters. An insurance broker charges as profit five per cent. on the premium, and one-half per cent. deducted from all claims recovered from the underwriters. An insurance broker is personally liable to the underwriters for the amount of the premium, but incurs no liability to make good the amount insured to the owner of the ship and goods, who, in case of loss, must look to the underwriter alone for indemnification.

**SHI'SDRA, or JISDRA**, a town of European Russia, in the government of Kaluga, and 80 miles south-west from Kaluga, on the Shisdra, a branch of the Oka. It has manufactures of woollen cloth, glass-works, iron-works, tanneries, oil-factories. Pop. (1867) 10,572.

**SYLLOTH**, a town and watering-place of England, of quite recent origin, in the county of Cumberland, at the terminus of a branch of the North British Railway, 20 miles west-north-west of Carlisle, is picturesquely situated on the Solway. The port is of growing importance, and possesses a good stone dock, with an area of five acres, having a fine jetty, 1000 feet long, projecting into the sea. S. is much resorted to for sea-bathing, the climate being mild and salubrious, and considered highly favourable for those affected with pulmonary complaints. The mean annual temperature is 49°, being the same as that of Worthing (q. v.) on the south coast of England, and only 1° below that of Torquay. According to the Registrar-general's returns, the mean average death-rate in S. for ten years is only 10.2 per 1000. S. is of easy access from all parts of England by railway, and steamers ply at stated intervals to and from Liverpool, Dublin, Belfast, and the Isle of Man.

**SIMMS, WILLIAM GILMORE**, American author, was born at Charleston, South Carolina, April 17,

1806, of Irish extraction. He made verses at the age of seven; and during the war of 1812, celebrated in rhyme the exploits of the American army and navy. Left in charge of his grandmother at Charleston, he was placed with a druggist; but at 18 began the study of law; was admitted to the bar at 22; published *Early Lays* and *Lyrical and other Poems* (1827); and became (1828) editor of *The City Gazette*, and published *The Vision of Cortes, Cain, and other Poems* (1829), and *The Tri-Colour*, a poetical glorification of the French revolution (1830). In 1832, his paper, opposing nullification, failed; and he lost his wife, father, and grandmother, and took refuge in New England, where, at Hingham, Massachusetts, he wrote his best poem, *Atalanta, a Story of the Sea* (1833); and the same year, *Martin Faber*, the story of a criminal. From this time, he poured out rather than wrote poems, novels, histories, and biographies in rapid succession, which may best be classed in groups. Of poems, he published *Southern Passages and Pictures* (1839); *Donna Anna* (1843); *Grouped Thoughts and Scattered Fancies* (1845); *Lays of the Palmetto*—ballads of Southern heroism in the war with Mexico (1848); *Poems Descriptive, Dramatic, and Legendary* (1854); *Arcytos, or Songs and Ballads of the South* (1860). Of dramas—*Norman Mauraia, or the Man of the People; Michael Bonham, or the Fall of the Alamo*; and a stage adaptation of *Timon of Athens*. Of prose romances of the imagination—*The Book of My Lady* (1833); *Carl Werner* (1838); *Confession, or the Blind Heart* (1842); *Castle Dismal* (1845); *The Wigwam and the Cabin*, two series (1845, 1846); *Marie de Berniere* (1853). Of historical romances—*The Yemassee* (1835); *Pelayo* (1838); *Count Julien* (1845); *The Damsel of Darien* (1845); *The Lily and the Totem, or the Huguenots in Florida* (1845); *The Maroon, and other Tales* (1855); *Vasconcelos* (1857); *Cassique of Kiawah* (1860). Of revolutionary stories—*The Partisan* (1835); *Mellichamp* (1851); *Katherine Walton* (1851); *The Scout* (1841); *The Kinaman, or the Black Riders of the Congaree* (1841); *Woodcraft* (1855); *The Foragers* (1855); *Eutaw* (1856); these five being stories of the war in the Carolinas. Of local tales—*Guy Rivers* (1834); *Richard Hurdis* (1838); *Border Beagles* (1840); *Beauchamps* (1842); *Helen Halsey* (1845); *The Golden Christmas* (1852); *Charlemont* (1856). His other works comprise a History of South Carolina; South Carolina in the Revolution; Lives of General Marion, Captain John Smith, Chevalier Bayard, General Greene; Civil War in the South; American Loyalists of the Revolution; Views and Reviews of American Literature; The Morals of Slavery, &c. Residing in South Carolina during the War of Secession, he sustained the Southern cause in a weekly newspaper, and had his house and library wrecked by Federal soldiers. Of his various and voluminous works, some are of high excellence. He died in 1870.

**SIMPSON, SIR JAMES YOUNG**, was born at Bathgate, Linlithgowshire, in 1811. He early shewed a peculiar talent for medical observation and research; and in the prosecution of his professional studies at the University of Edinburgh, so attracted the notice of his teachers as to inspire all of them with an active interest in his future career. He graduated as doctor in medicine in 1832, on which occasion his inaugural thesis won the highest admiration. Professor Thomson chose him as his professional assistant, and employed him in the preparation of his course of lectures on General Pathology. During the illness of the professor, Mr S. supplied his place in the lecture-room with unusual skill and address. He now began professional practice on his own account; and in 1840, succeeded Professor Hamilton as Professor of Midwifery in the University of

while popularly attractive, character of his prelections, has contributed greatly to the renown of the Edinburgh school, both at home and abroad. He was indefatigable, amid the distracting cares of an extensive practice, in promoting the scientific perfection of his art; and his two volumes of *Obstetric Memoirs*, edited by Drs Priestly and Storrer, contain the fruits of much patient and ingenious research. The discovery by which he will be more particularly remembered, however, is that of the anæsthetic virtues of chloroform. The so-called sulphuric ether had been employed in America by Morton to produce anæsthesia during labour; but to S. belongs the credit of having, in 1847, first introduced to the scientific world the far safer, more certain, and now universally adopted agent of chloroform. Another innovation which surgical practice owes to Professor S. is the stoppage of hæmorrhage by Acupressure (q. v. in SUPP., Vol. X.). In his own peculiar field of obstetrics, his improvements on the old methods of practice are numerous and valuable; while his contributions to antiquarian research would of themselves create an independent reputation in that field. Besides the *Obstetric Memoirs* already mentioned, he published a volume on Acupressure; and many papers and notices read before the Royal and Antiquarian Societies of Edinburgh. Among these may be enumerated: *Antiquarian Notices of Leprosy*; *On the Contagiousness of Cholera*; *Ancient Roman Medicine Stamps*; *Was the Roman Army provided with Medical Officers? Notes on some Ancient Greek Vases for containing Lykion, &c.*; *On Syphilis in Scotland*; &c. His scientific services were recognised by nearly every medical association in either hemisphere; while his professional distinction secured for him (1866) a baronetcy from the Queen. He died on the 6th of May 1870.

**SINCERE BRETHREN, or TRUE FRIENDS**, is the name of a semi-religious, semi-scientific Mohammedan order, the beginnings of which are shrouded in obscurity, but which, about 970 A.D., manifested its existence by one of the boldest and most comprehensive literary undertakings—viz., an encyclopædic treatment of philosophy, theology, science, ethics, and metaphysics, in a series of no less than fifty-one treatises. Under the head of **MOHAMMEDAN SECTS**, and more especially under **MOTAZILITES**, mention has been made of that immense religious struggle that arose but a few generations after Mohammed, in the bosom of Islam, bringing forth sect after sect; and which, under whatever name and war-cry, simply denoted the reaction of the thinking minds against the dead-weight of dogmas and formulas, such as the successors of the Prophet tried in his name, and often enough in direct contradiction to his explicit dicta, to impose upon the Faithful. What the Motazilites had attempted was the reconciliation of scientific speculation, as it had irresistibly grown up at the first contact of the Arabs with Greek literature, with the religious dogma of Islam. This new period of development of Arabic culture, which chiefly characterises the epoch of the first Abbaside rulers, however, was of no long duration. The representatives of the 'orthodox' schools, who would not hear of reconciliation, but insisted all the more uncompromisingly upon the most literal interpretation, dexterously used against them those same weapons of dialectics which their adversaries themselves had first taught them how to wield. Setting to work with proper systems and methods, they soon built up a scholastic edifice of theology, not easy to be attacked without the most direct

It was thus that the Motazilites soon disappeared from the arena. But their labours had not been in vain. Silently and by small degrees this new and mysterious union of the Sincere Brethren arose. Though widely spread, their schools, their houses of assembly, their rules, their doctrines—everything remained, for we do not know how long, a profound mystery; and apart from that which they themselves have thought fit to reveal of it, neither ancient nor modern investigation has been able to discover many traces of their inner organisation and activity. Not even many of their names have come down to us, though the 'treatises' they have left point to a multitude of authors, and to many stages of development. The tone of these treatises is much more free, and their entire tendency more radical than that of any of the books of their predecessors. Yet, the desire not to offend the law advanced in religious matters, and above all, to reunite rather than to make the breach wider, is perceptible in their endeavour to use what Koranic quotations and traditions can be pressed into the service of free thought, by often very unnatural processes of allegory and mysticism.

Before speaking of the treatises themselves, we shall briefly summarise what can be gathered as to the mutual relations of the brethren of this secret lodge, and the aims of their association. There is special mention made of the 'secret doctrine' which the Brethren should communicate to each other in their houses of assembly at those 'stated periods,' at which no stranger was to be admitted on any condition. The principal subjects towards which their conversation was to be directed were to be the knowledge of the soul or psychology, the knowledge of the action of the senses and the things perceptible through them, the contemplation and investigation of the mysteries of the sacred books, of the prophetic revelations, and the ideas contained in the divine laws. Their attention was further to be directed towards the four 'mathematical' sciences—arithmetic, geometry, astronomy, and (musical) composition. But the chief subject of their investigations should be the knowledge of divine things, which are the end and aim of all study. The most catholic spirit was to prevail among them with regard to the various sciences, systems, or books; since 'our own system comprises all, without exception, and includes all science.' 'The speculations of our school extend simply to all things—the sensual and the intellectual—from the moment of their beginning to their end, according to their outer and inner life—that which is palpable and clear about them, and that which is hidden and secret—the Truth, in fact. For the true essence in everything is derived from one primeval origin and general cause, since there is but one world and one supreme mind, to which all the most manifold phenomena, species and kinds, and divisions, are to be traced back.' With these words, the encyclopædic tendency of the lodge and their essays is best characterised.

All their knowledge they traced back to four sources—as indeed this number seems to have played a very considerable part in all their divisions—as follows: 1. 'The books that are known by the names of the sages and philosophers, in as far as they belong to mathematics and natural history.' They do not indicate them further; but it is easy to see from the treatises themselves that they allude to the translations of Greek works bearing the names of Pythagoras, Aristotle, Euclid, Ptolemy, Porphyry, &c. 2. 'The revealed writings derived from the prophets,' such as the five Books of

contents through inspiration by the angels and the 'deep mysteries hidden in these books. 3. 'Books treating of nature'—i. e., that describe and represent the things now in existence—the celestial circles, the motions of the stars, the transformation of matter, the individual species and kinds of animals, plants, &c. All these things point to abstract ideas and subtle mysteries of which men in general saw but the outside, ignoring the mysterious art and meaning of the Creator hidden within. But if, in this third division of the sources, the power of the mysterious and of spiritualism must needs have become very strong, it seems to have ruled absolute in that most mysterious and obscure of all sources, the fourth—viz., 'the divine books, or the books on the divine things, written by the angels from the tablet of Fate, upon which all the divine decrees regarding the world and man are inscribed. These contain all that refers to substances, species, kinds, and orders of the different souls; their actions, destinies, metamorphoses, phase after phase, the heavenly conjunctures and periods, &c.' For this the Koran was quoted: 'And upon the Arap' [the division between heaven and hell] 'there will stand men, who will recognise every one by their distinguishing mark.' These men, however, are souls who take a higher degree than other men, like the prophets and martyrs, or the elect among the believers and learned, or the angels who appear in human shape.' And that there might be no mistake as to the members of the secret brotherhood being alluded to in this passage, another passage from the same sacred volume is added, which reads: These are the men who live in houses which God has permitted to be erected, that His name might be praised therein, in which men proclaim His praise both morning and evening, whom even neither commerce nor trade intercourse keeps from the remembrance of God and the solemn fulfilment of the duty of prayer. 'This is the state of our brothers, the highly meritorious, the highly honoured.'

The supreme (outward) duty of the brethren was to support one another in case of need. Men are divided into four classes—those who have wealth without knowledge; those who have knowledge without wealth; those who have both; and those who have neither. And this at once points to the necessity of mutual support. Envy and ill-will are seriously reprobated, and here the ethical portions of the Koran and the Sunnah are appealed to. But these fundamental principles are further explained and detailed in the rules almost step by step; and it is shewn how each of the four classes named is to make its support of the Brethren more effective. Everything should be directed for the benefit of the soul, not of the body; everything for the future, nothing for this world. Moral qualities are the highest gift of heaven, and the characteristic sign of the angels and the blessed in paradise—a wise and happy way of comforting the poor of the community, who, by moral purity, may lift themselves to the same purity as the best and richest among the Brethren. In order further to prove how the soul is capable of the highest perfection by degrees, the various ages and stages of man are enumerated, and the gradual progression of all faculties is dwelt upon according to the 'strength of the soul.' The fourth degree is characterised as the angelic quality of the soul, which is obtained at fifty, and which prepares the way to everlasting life, and to the full separation from matter. To this succeeds the 'power of ascension,' whereby the member mounts

end, such as the resurrection, the last judgment, the dispersion, the meting out of rewards and punishments; how, further, 'the path is to be crossed, how he escapes the fire, enters Paradise, and becomes a denizen of the highest realms with the Father of all mercies.' And for this consummation, many passages in the Koran and the Gospel are adduced—no less than the words of Socrates on the day of his taking the hemlock; of Pythagoras at the end of his Golden Epistle, &c.

The encyclopædia of treatises which this secret association has left as the monument of its existence, was first compiled at Basrah about 1000 A. D.; but has (save one often reproduced chapter, called 'The Contest between Man and Animal') never been printed. The 51 treatises are divided into four classes: 1, the 'Mathematical,' in 13 dissertations or treatises; 2, the 'Physical,' in 17; 3, the 'Origins' of mental activity, or the thinking soul, in 10; and 4th and last, 'The Divine Law,' in 11 treatises, the last of which contains a general outline of the whole work.

The interest attaching to this production, as the earliest Encyclopædia deserving the name, reflecting, as it does, the state of science both of the East and West at the end of the first thousand years after the introduction of Christianity, is so great, that we append a sketch of the contents and method.

The first 13 treatises, belonging to what may be called the mathematico-philosophical division, treat of Arithmetic, Geometry, Astronomy, Geography, Music, followed by psychological and ethical reflections. This part concludes with introductions to Philosophy and Logic. Throughout, the authors only treat of the theoretical part of their subject, without entering into further details as to their practical side, or teaching them systematically one by one.

From these preliminaries, the work proceeds to its second part, the physical division, which comprises the whole cosmos in its special phenomena, and the laws that govern them: heaven and earth, the three natural kingdoms, the mysterious union of body and soul, how the latter pervades the former, and communicates itself to all its parts; the changes of life and death, joy and mourning, the senses, and all that is perceptible through them—all the great questions, in fact, which most vitally engage man's attention in this world of growth and decay. An attempt is made to ascertain how far human understanding can penetrate these dim regions of speculation and metaphysics, and even the languages and their original elements are drawn into the circle of these investigations, and subjected to philosophical scrutiny.

The third division treats of the origins of mental activity. Heterogeneous though some of its elements be, it yet keeps its subject sufficiently in view throughout. The elements of mental activity are investigated first according to Pythagoras, then according to the Brethren themselves. Next comes man both as microcosm and macrocosm. The revolutions of the heavenly bodies, love, resurrection, the world to come, motion, cause and effect, dogmas and customs are then treated of; each and all contributing their share to the aimed-at outward union between reason and faith.

The fourth division borders very closely on the supernaturalistic and purely speculative. At the same time, it touches vital doctrines of Islam, and treats them in an abstract and very free manner. How the knowledge of God is gained; the life of the soul after death; the relation of the Brethren

adopted by the lodge; and a number of similar points are taken up.

So far, in the most general outlines, those fifty-one treatises, which, though they be neither strictly systematically arranged nor methodised, nor free from repetitions, and by no means so instructive in detail as the enumeration of the contents would lead to believe, yet belong to the most comprehensive and creditable efforts of the human mind.

A small specimen of the manner and method of these treatises, taken from the chapter (20) on Plants may not be unacceptable:

'Know that the plants are only perceptible as the visible, palpable phenomena, but that their artistic working within is secret, invisible, and hidden before the eye. It is what we call the part-souls, what the philosophers call the natural powers, what religion calls angels, or divine hosts commissioned with the calling into being and development of the plants and creatures, with the creation of the stones, &c. The terms differ, but the sense and meaning is identical. Philosophers trace these things to the Powers of Nature; the religious Law to the Angels, but not directly to the Blessed and Exalted God. For the Blessed God is too exalted to form a natural body Himself—to move and to act bodily, just as kings, generals, and high dignitaries are too high to execute any work themselves, though they are considered their authors, through having ordered and willed them. If, e. g., you hear it said that Alexander built Alexandria, you must not, of course, fancy that he himself bodily did build the city—he ordered it to be built. Thus, the works of God's servants are traced back to the Exalted God, even as the Koran says: "It is not you who have killed them, but God."'

One of the most attractive portions of the work, and the one which alone has been repeatedly edited and translated into many languages (not into English), is the so-called 'Contest between Man and Animal,' which forms a part of the twenty-first treatise. In this one place alone, man and animals are introduced speaking; in all other portions, rhetoric, ornamented by allegories and metaphors, mostly well chosen and artistically wrought, forms the ordinary style. These dissertations may not have fulfilled their purpose any more than did the whole lodge; but they will be all the better appreciated when that darkest period of Mohammedan history, the 10th c., is taken into consideration. Hypocrisy stood for piety at the courts of the many emirs, low cunning for wisdom, the vilest adulation for fidelity, and oppression for justice. No wonder this manly and scientific protest was not received very favourably by so corrupt a generation. Besides which, the want of strict logical arrangement—a circumstance owing probably to the voluntary suppression of the intermediate portion—and the vagueness in which many of the most important points are treated, made even the few independent and faithful minds fail to appreciate it. The chief cause of the discontent which they excited among the contemporaries lay in their conciliatory tendencies. Theology pure and simple would not hear of philosophy. Religion, the orthodox champion said, was a revelation—divinely given, not to be understood even by human intelligence; philosophy, on the other hand, was a vain thing, treating of human things and other futile subjects. The philosophers, though they dared not be quite so outspoken on theology, felt no less keenly that there

We have treated this subject somewhat more fully than usual, both on account of its deep intrinsic interest, as forming the most striking refutation of the commonplace notion that the religion of Mohammed was a stationary, hard, fanatical, and dotard creed, never questioned or reasoned upon by the Faithful; and further, because little or no information on the subject is generally accessible. The work itself has, as we have said, with the exception of the one fairy-tale fragment, never been edited; and there are, even among the authorities on Mohammedan matters, but three or four who have paid special attention to this important subject, and what fragmentary information we possess lies scattered in Oriental 'Transactions,' in notes, and in prefaces.—See Sprenger, in *Asiatic Journal of Bengal*; Fittgel, in *Deutsche Morgenl. Zeitschrift*; De Saoy, *Notices et Extraits*; Diesterici, *Mensch und Thier*; Nauwerck; &c.

SIR-I-PUL, a town of Afghan Turkestan, 45 miles south-west from Balkh, in lat. 36° 21' N., and long. 66° 28' E., on a river which loses itself without reaching the Jihoon. It is the capital of an Uzbek chief. Pop. 18,000.

SLEAFORD, a town of Lincolnshire, England, on the right bank of the Slea, a branch of the Witham, 17 miles south-south-east from Lincoln, and 52 feet above the level of the sea. It is a well-built and well-paved town, and has a fine church, built in the 13th century. Pop. (1871) 3592.

SMITH, GOLDWIN, LL.D., son of a Berkshire physician, was born at Reading in 1823. He received his education at Eton, from whence he proceeded to Oxford, and matriculated at Christ's Church, but was soon afterwards elected to a Demyship at Magdalen. His undergraduate career was one of unusual brilliancy, only equalled, indeed, by Sir Roundell Palmer and Professor Couington. He gained both University Scholarships, the Latin Verse, and the two Prize Essays, and was placed in the first class in 1845. In 1847, he was elected Fellow of University College, where he officiated for a time as tutor. In the same year he was called to the bar at Lincoln's Inn. The ministry of the day availed themselves of Mr S.'s services in carrying out their plans of university reform. He was nominated Assistant-secretary to the first, and Secretary to the second Oxford Commission, by which the somewhat antiquated statutes of the university were reconstructed, and the rich endowments of the colleges opened to public competition. Mr S. was also a member of the Popular Education Commission appointed in June 1858. The chair of Modern History having been vacated about this time by the resignation of Professor Vaughan, was offered by Lord Derby to Mr S. He accepted the offer, and discharged his professional duties with zeal and efficiency until his resignation in 1866. In 1868, he was elected to the chair of English and Constitutional History in the university at Ithaca, New York. He has lately resided in Canada. Goldwin S. has long been known as a publicist of the highest class, and has completely identified himself with the more advanced school of reformers. During the American war, he was an earnest defender of Federal interests, and combated with success, in the *Daily News* and elsewhere, the singular theories of the rights of slavery and the duties of neutrals, which were then somewhat fashionable. He was also active in denouncing the Jamaica massacres, and in advocating an extended measure of reform. His lectures on 'Three English

that he was a 'wild man of the cloister, going about the country maligning men and things.' Mr S.'s writings are characterised by great extent and accuracy of information, by a style singularly vigorous and condensed, and by great powers of sarcasm. Among his principal publications may be enumerated: *Irish History and Character*; *Two Lectures on the Study of History, with a Supplementary Lecture on the Doctrine of Historical Progress*; *The Empire, a reprint from the Daily News of 1862-1863*; *England and America*, a lecture delivered before the Boston Fraternity, and reprinted from the *Atlantic Monthly*; *A Plea for the Abolition of Tests at Oxford*; *Rational Religion and the Objections of the Bampton Lecture in 1858*; several pamphlets on the American question; contributions to *Oxford Essays*; *A Short History of England*; &c. He is also the author of some of the most admired compositions in the *Anthologia Ozoniensis*.

**SNOW-BIRD** (*Junco* or *Fringilla hyemalis*), a North American bird of the Finch family (*Fringillidae*), common from Louisiana to the Fur Countries, in all the eastern parts of North America. The wings are rather short, the tail slightly notched. The whole length is rather more than six inches; the upper parts are lead-colour, the lower parts white, the two outer tail-feathers white, the next white margined with black. This bird migrates northwards early in spring, and southwards late in autumn. It is often to be seen in small flocks, visiting barn-yards, and hopping about with the domestic poultry. In cold weather, it retires to holes in haystacks. Its song is sweet. From its frequent familiar approach to human habitations, the S. is regarded with favour throughout great part of North America, as the Redbreast is in Britain. In the south, however, it is often brought to market, its flesh being very pleasant. In the western parts of North America, another but very similar species, the OREGON SNOW-FINCH (*F. Oregona*), takes the place of this.

**SOMBRERE'TÉ**, a town of Mexico, in the state of Zacatecas, and 90 miles north-west from Zacatecas, in a mountainous district celebrated for its rich silver mines, from which S. derives all its importance. Pop. 14,000.

**SOO-CHOW**, or **SU-TCHOU**, or **SOO-CHOW-FOU** (*foo* merely signifying *city*), a large city of China, in the province of Kiang-su, 60 miles west-north-west from Shanghai. It stands near the Grand Canal which connects Hang-chow with Nanking and Pekin, but its port is Shanghai, with which also it has water-communication. It is about ten miles in circumference, and is enclosed by fortifications, outside of which are four very large suburbs. The country around S. is level, and remarkable for its fertility, so that the Chinese speak of it as a terrestrial paradise. The city has silk manufactures, printing establishments, and a large trade in books. In 1857, S. was captured and sacked by the Taepings. In 1863, it was invested by the Imperialists, under a British officer, and the rebel chiefs having surrendered, were treacherously beheaded by the governor of the province.

**SPANISH MAIN** (i. e., *main-land*), a name generally given during the 16th c. and the earlier part of the 18th to the north-east coast of South America, from the Orinoco to the Isthmus of Darien. The name occurs very frequently in connection with the history and exploits of Buccaneers (q. v.).

**SPEKE, JOHN HANNING**, an African traveller, was born near Bideford, Devonshire, in May 1827,

and at the age of 17 went to India. He entered the native Bengal infantry as a cadet, and saw much service during the war in the Punjab. A keen sportsman, with a taste for natural history, he employed his rifle with success in collecting for the museums specimens of the rarer mammals and birds of India, and with this view he undertook several exploratory trips into the Himalaya. It was while so employed that he first conceived the idea of becoming an African traveller. The English government had resolved, in 1854, to despatch an expedition from Aden into the neighbouring region of Africa, under the command of Captain Burton (q. v. in SUPP., Vol. X.). S., then a lieutenant in the Indian army, reached Aden at this time, on leave of absence, and resolved to join Burton and his companions, Lieutenants Herne and Stroyan. Burton went to Harar; and S. was detached to visit the Dalbahantas, the most warlike of the Somaui tribes. On the return of the travellers to their starting-point on the coast, they were attacked by 160 men. Stroyan was killed, and S. made a narrow escape with 11 wounds. The attention of the Geographical Society of London had now been called to the subject of the great lakes of tropical Africa; and in June 1857, they despatched Burton and Speke. These travellers entered the country from Zanguebar, as the German missionaries Krapf and Kebmann had done in 1847, and discovered the great lake Tanganyika. The details of their discoveries till they reached Gondokoro, in March 1863, are given in the article NILE. S. and Grant had passed through the very heart of what remained of the *terra incognita* of Eastern Africa. On their return to England, they met with an enthusiastic reception, to which they were well entitled, as two of the most daring and successful of modern explorers; although, perhaps, some of S.'s most enthusiastic friends have gone too far in claiming for him a place above other travellers as 'the discoverer' of the sources of the Nile. On the 15th September 1864, S. was killed by a gun-accident while out shooting in the neighbourhood of Bath, to which he had come to be present at a meeting of the British Association.—S. is the author of a *Journal of the Discovery of the Source of the Nile*, and *What led to the Discovery of the Source of the Nile*.

**SPENCER, HERBERT**, an English author, born in Derby in 1820. He was educated by his father, W. G. Spencer, a teacher, chiefly of mathematics, and his uncle, the Rev. Thomas Spencer, a clergyman of the established church, well known for his liberal opinions on political and ecclesiastical questions. At the age of seventeen, he became a civil engineer; but after about eight years, abandoned the profession, in consequence of the large influx of young men brought into it during the railway mania, and the consequent undue competition. During the eight years of his engineering life, he contributed various papers to the *Civil Engineer's and Architect's Journal*. His first productions in general literature were in the shape of a series of letters on the 'Proper Sphere of Government,' published in the *Nonconformist* newspaper in 1842, which were some time after reprinted as a pamphlet. From the close of 1848 to the middle of 1853, he was engaged on the *Economist*, then edited by the late James Wilson, M.P.; and during this time he published his first considerable work, *Social Statics*. Shortly afterwards, he began to write for the quarterly reviews, most of his articles appearing in the *Westminster*, and others in the *North British, British Quarterly, Edinburgh, Medico-chirurgical*,



order the principles of biology, psychology, sociology, and morality. To this series belong, besides the *Psychology* (2 vols., new ed. 1871—1872), *First Principles* (1862, 2d ed., 1867); *Principles of Biology* (2 vols. 1864), and *Principles of Sociology* (1st vol. 1876). *Education* was published in 1861; *The Study of Sociology* in 1872; and *Descriptive Sociology* in 1873. S. has applied universally, and carried out into detail, the theory of evolution.

**SPERMATOZO'A** (derived from Gr. *sperma*, seed, and *zoa*, living creatures) is the term given to the true fertilising agents occurring in the male generative organs. They appear to be formed from the epithelial lining of the tortuous seminal tubes, of which the organ known as the *testis* is essentially composed. At the period of puberty in man, and at certain periods annually in other animals, the seminal tubes are seen to be filled with cells, from which the spermatozoa are developed. Without describing the various changes that ensue, we may observe, that the spermatozoa are finally set free by the bursting of the cell-walls, and arrange themselves in parcels, symmetrically placed, with the so-called heads in one direction, and the tails in the opposite direction. In the human subject, the spermatozoa may be described as clear, hyaloid bodies, each of which consists of a dilated portion, the head or body, from which a long tail, or filament, issues. The head is flattened from side to side, and of a conical form, the pointed extremity being anterior. The length of the spermatozoa is about  $\frac{1}{100}$ th of an inch. The spermatozoa of different animals vary extremely in size and form; and for a detailed account of these bodies, in different classes of animals, we must refer to the article 'Semen,' in the *Cyclopædia of Anatomy and Physiology*. It was formerly supposed that spermatozoa were independent organisms (like the infusoria, for example), but it is now known that they must be regarded as epithelial cells (or perhaps nuclei), modified in structure, and endowed with special properties. That the integrity of the spermatozoa is essential for the process of impregnation, is a fact that cannot be called in question; but of the nature of the force which they communicate to the ova, we know nothing.

**SPHYGMOGRAPH**, an instrument by which we ascertain, and permanently record, the form, force, and frequency of the pulse-beat, and the changes which that beat undergoes in certain morbid states. This instrument consists of two essential parts: (1) Of two levers, one of which is so delicately adjusted on the vessel the pulsation of which it is desired to examine, that on each expansion of the vessel the lever undergoes a corresponding slight elevation: this lever communicates by a perpendicular arm with a second, to which it transmits the impulse received from the vessel; the extremity of this second lever is armed with a pen-point, which records the movements thus indicated on a movable plate, controlled by the second part of the instrument. (2) The second portion consists of a plate, moved by watch-work, and bearing a strip of paper on which the *sphygmographic* tracery is formed.

*Mode in which the Tracery is formed.*—As the pulse transmits through the levers a vertical movement to the pen-point, and the plate, on which the tracery is formed, is moved steadily across the pen-point, an undulating line (fig. 1) is the result: the height of the elevations indicating the strength of the pulse; and the number of the elevations delineated in the time the pen takes to travel, its frequency.

are excellent examples of the tracings produced by



Fig. 1.

the pulse at the wrist in two common forms of cardiac disease, and exhibit the manner in which the tracing is modified in diseased states of the circulatory system. Fig. 2 represents the pulse of a patient suffering from an incompetent state of the valves guarding the orifice of the aorta, the great vessel conveying blood from the heart. The blood, in such a case, when propelled into the aorta distends it, and communicates a pulse throughout



Fig. 2.

the arterial system. When the vessel again contracts, regurgitation takes place into the cavity of the heart, as the valves, which should prevent this regurgitation, and maintain the arterial tension, are unable to perform their function. The pulse-beat is accordingly abrupt, and of short duration, and the sphygmographic tracing presents a series of abrupt elevations and depressions. Fig. 3 represents the pulse met with in a different form of



Fig. 3.

cardiac disease, in which the valves are so affected as to obstruct the passage of the blood into the circulation: the effect of this on the pulse is to render its beats weakly marked and irregular; and in the sphygmographic tracing, the elevations are diminished in height and regularity. The pulse, in extreme forms of this lesion, is represented in sphygmographic tracing by a slightly waving line.

**SPIITHEAD FORTS.** The troubled state of European politics which gave rise in 1859 to the Volunteer movement, led also to the recommendation of an extensive plan of defences for the arsenals and coast. A Board of Commissioners drew up a scheme for these defences, to cost about £5,000,000, of which a sum of £2,000,000 was for Portsmouth, Spithead, and the neighbouring coast. At present, the entrance to the important arsenal and dockyard at Portsmouth is defended by Fort Monckton on the Gosport side, Southsea Castle on the opposite side, Cumberland Fort at the entrance to Langston Harbour, Lumps and Eastney Forts between the two last named, and some defensive lines between the island of Portsea and the mainland. £580,000 was voted in 1860 as a beginning, to increase the number and strength of these forts, to build detached forts on shoals in the sea between the mainland and the Isle of Wight, and to raise fortified lines on Portsdown Hill (the principal work being Fort Southwick), wholly northward of Portsmouth Harbour. The works were commenced; but

can war led to much delay and endless variations of plan.

The National Defence Commissioners had proposed five advanced forts on the shoals known as Horse Sand, Noman or No Man's Land Shoal, Sturbridge Shoal, Spit Point, and a point intervening between Horse Sand and Portsea Island. But after much discussion and numerous alterations of plan, it was only in 1864 that it was determined to proceed with the foundations at least of two—the Horse and the Noman forts. The foundation of each fort consists of rings of stone-work, laid on the levelled bed of the shoal, tapering a little upwards from a width of 54 feet to one of 43 feet; the outer diameter of the ring gradually lessening from 231 to 213 feet. From 20 to 15 feet of submarine masonry is required. Outside the rings of stone are layers of rubble, to protect the stone-work from the action of tidal rush. Two years later, similar forts were begun on Spit Bank and St Helens shoal. In 1865 a mortar battery had been erected at Puckpool in the Isle of Wight, commanding at long range the approach to Spithead. In 1868, after it had been found impossible to secure a foundation for a fifth fort on the Sturbridge shoal, Puckpool Battery was strengthened and armed with 30 mortars and four 25-ton guns.

All this time the government had not determined which of three modes to adopt for constructing the forts—whether to form them entirely of iron; or of granite faced with iron; or simply of granite, leaving the facing for after-consideration. The plan most in favour with the government in 1866 was to erect on each of the foundations at Spithead a revolving iron fort or tower of enormous magnitude.

Circumstances in 1867 induced the government again to pause. Experiments on the Rodman 15-inch and 20-inch guns led some engineers to believe that no iron casing for forts could resist shot of 500 lbs. to 1100 lbs. from such ordnance; while the rolling of an armour-plate 15 inches thick (see ARMOUR-PLATES in SUPP., Vol. X.) revived the hopes of those who believe that armour will eventually vanquish guns. Finally, the forts are nearly finished, of a granite core, surrounded by a great thickness of iron plates. Above each fort are revolving turrets carrying 35-ton guns, which throw shells of 700 lbs. The inner line of defence has been strengthened by new works at Gilkicker, Southsea Castle, &c., and by the increase in the size of the guns, and the addition of iron shields in the embrasures.

STANFIELD, CLARKSON, a distinguished painter, was born of Irish parents, in the town of Sunderland, about the year 1793. At an early period of his life, he went to sea, and made frequent long voyages, among which was that to China. In the China seas, he passed some years of his life, and served for a time in the same ship with Douglas Jerrold; S. in the capacity of a common sailor, and Jerrold as a midshipman. While thus engaged, S. exhibited considerable talent both in painting and drawing. The first person of public note, however, to observe S.'s genius as a painter was the celebrated Captain Marryat, who met with him in the Mediterranean, serving in a king's ship as captain's clerk. S. and Marryat afterwards became intimate; and in 1840 the novelist employed the painter, then become famous, to illustrate his *Poor Jack*. S. left the navy, in consequence of an injury to his feet, through a fall from the fore-topgallant mast-head of his ship. He then took to scene-painting as a means of earning his bread. His first efforts in this direction were made in the Old Royalty Theatre, Wells Street, Wellclose Square, in the east end of London, about the year 1818. He was afterwards

sent that he produced some of his most extraordinary effects. He carried on this occupation until the year 1827, when he finally abandoned it, except on rare occasions. S., while painting for the theatres, had by no means neglected easel-painting. The first picture by him that attracted any considerable notice was 'Market-boats on the Scheldt,' exhibited at the British Institution in 1826. The picturesque grouping, variety of figures, and gay costumes were much admired. His 'Wreckers off Fort Rouge, Calais,' exhibited in the following year, also at the British Institution, was even more successful. In 1828, he obtained from the British Institution a prize of fifty guineas for another of his pictures. In 1830, S. made his first excursion on the continent, and in the same year exhibited at the Academy his 'Mount St Michael, Cornwall,' which placed him at once in the foremost rank as a marine painter. In 1823, S., in conjunction with David Roberts and others, founded the Society of British Artists. His election to the Academy as Associate took place in 1832; and in 1835 he was chosen R.A., in conjunction with Sir William Allan. In 1833, S. exhibited at the Academy the first of a series of pictures of Italian scenery, painted for the Marquis of Lansdowne for the banqueting-room at Bowater. In 1834, he commenced a similar series for the Duke of Sutherland. In 1836, he exhibited 'The Battle of Trafalgar,' painted for the Senior United Service Club; and in 1841, his celebrated 'Castello d'Ischia,' engraved by the Art-union in 1844. In 1843, he sent to the Academy 'Mazerbo and Lucello, Gulf of Venice,' said to be one of the finest landscapes he ever painted. 'A Skirmish off Helligoland' (1867) was S.'s last contribution to the exhibitions of the Academy, of which he was so distinguished a member. His great merit lies in the skillful combination of land and sea in the same view. Man and the works of man are not disdained by him in his portraiture of nature, and there is frequently a poetic feeling of the highest order in some of his conceptions, as in his pictures of 'The Abandoned,' and 'The Wreck of a Dutch East Indiaman.' S. died on the 18th of May 1867.

STA'TEN ISLAND, an island off the south-east point of Tierra del Fuego, from which it is separated by the Strait of Le Maire. It is about 45 miles in length from east to west, and about 10 miles at its greatest breadth, its shores most indented. Its eastern extremity is Cape St John, in lat. 54° 42' S., and long. 63° 43' W. The surface is mountainous, descending to the sea in steep slopes and precipices; its general character similar to that of Tierra del Fuego.

STAVANGER, a seaport town of the west coast of Norway, in the stift of Christiansand, 35 miles north-west from the Naze, and 100 miles south from Bergen, on the west side of a wide and sheltered bay of the Bukne-fiord. It is a very ancient town, with a very fine old Gothic cathedral, built in 1013. S. has cloth-manufactories and distilleries. Ship-building is carried on. There is a considerable export trade in timber, oak-bark, lobsters, herring, and stock-fish. Pop. (1870) 17,653.

STA'VESACRE (*Delphinium staphisagria*), a species of Larkspur (q. v.), a native of the south of Europe. The seeds have been used in medicine from ancient times. They are too violently emetic and cathartic to be safely employed; but in powder they are applied to cutaneous eruptions, and are used for killing lice. Their properties depend upon an alkaloid, *Delphinia* ( $C_{22}H_{15}NO_7$ ), which is now used in medicine instead of the seeds, chiefly in rheumatism and neuralgia.

## STEAM-CARRIAGE—STEEL.

**STEAM-CARRIAGE.** It has been a favourite idea for many years with amateur and professional mechanics (especially the former) to make a light carriage which could be used upon ordinary roads, and which should contain a steam-engine and boiler to propel itself. In spite of innumerable attempts, no permanent success has yet been obtained in this direction, notwithstanding that great progress has been made in constructing steam traction engines for common roads. The fact seems to be, that while a self-propelling steam-carriage to carry only the weight of a passenger or two *can* be made without much difficulty, its cost will be proportionately so heavy, and the trouble of keeping it in order as well as of working it, so great, that it will not succeed commercially.

The true application of steam upon common roads is in the drawing of heavy loads which would otherwise require an inconveniently large number of horses. Engines for this purpose are called *traction-engines*, and their use, notwithstanding determined, and too often ignorant, opposition, seems to be yearly on the increase. Traction-engines may be divided into two classes—those with rigid tires on their wheels, and those with flexible tires. The former class is the older, and includes many ingenious but mistaken contrivances for laying down what was equivalent to an endless railway for the engine to run upon, which was at one time thought by many essential to its success. The best engines at present made with rigid tires are those of Messrs Aveling and Porter of Rochester, which are simple and substantial in construction, and are used largely both in this country and abroad. Of the second class of traction-engines, those fitted with Thomson's patent india-rubber tires, and by the inventor called *road-steamers*, are the only ones that have come into anything like extended use. These tires are simply rings of india-rubber, four or five inches thick, stretched over the rim of the wheel, and protected by a flexible circle of steel shoes from being damaged by stones, &c. The advantage of flexible tires is the greater adhesion (in proportion to weight) which they give to the engine, and the saving the machinery from shocks and jars. They will doubtless be still more largely used when more lengthened experience has perfected their construction, but the great cost of the india-rubber has hitherto much hindered their extended adoption.

**STEAM-CRANE.** The application of steam to the working of cranes was an obvious one, and is now universal where much hoisting work has to be done; it not only effects a great saving in labour, but causes the work to be much more quickly done, a consideration quite as important. Steam-cranes and winches are now almost invariably used on board all large steam-boats, both for loading and unloading, heaving the anchor, warping the ship along by means of a cable, and other purposes. When working on a wharf, and in many other situations, it is often very convenient that the crane should be movable, so that it may go to its work in the multitude of cases where that arrangement is more convenient than the converse. For this purpose it is mounted on a plain railway truck, either of wood or iron, the truck being generally provided with clamps at the ends, by which it can be firmly secured to the rails when lifting weights. The balance construction, now universally adopted for portable cranes, was invented or suggested by the late Mr R. W. Thomson, C.E., in 1856—its essential feature being the use of the boiler as a counterpoise to the weight to be lifted,

as shewn in the figure. The principal parts of a steam-crane are: 1. The boiler, which must be of some very simple construction, as it has so frequently to be worked with excessively dirty water; 2. The framing, which is generally made of cast-iron, and supports the boiler, the engine and gear,

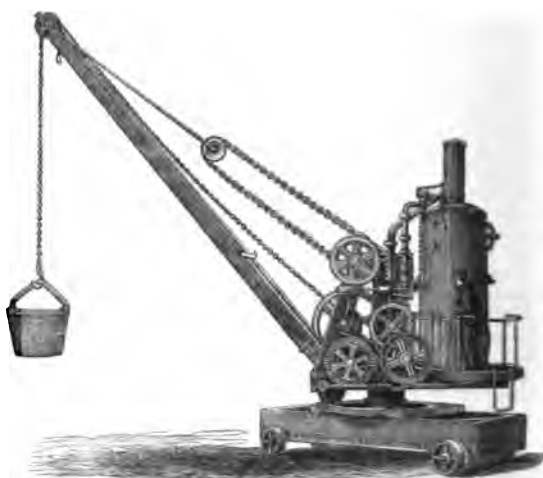

and the jib; 3. The engine (which has almost always two small cylinders, and is fitted with reversing gear), and the pinions, wheels, drums, &c., for the hoisting and other motions; 4. The 'jib' (either of wood or iron), over a pulley in the top of which the chain passes, and the purpose of which is to enable the different objects to be lifted quite clear of the ground, and deposited, when necessary, on trucks, &c.; 5. The pillar, which is firmly attached to the truck, and which, passing upwards through the centre of the frame, forms the pivot on which it turns round; 6. The truck itself, which supports the whole machine. If the crane is stationary, the truck, of course, is not required, the bottom of the pillar being imbedded in masonry; and for large cranes the boiler is generally made separate from the machine itself, and sometimes the engines also. A portable balance steam-crane, like that in the engraving, is, when complete, fitted with the following motions: 1. Gear for hoisting, generally with two or more speeds, to be used according to the weight to be lifted; 2. Gear for raising or lowering the outer end of the jib; 3. Gear for slewing the jib (with boiler and frame attached to it); 4. Gear for propelling the truck along the rails. Our illustration shews a complete and well-designed crane of this kind, made by Messrs Alexander Chaplin and Co., of the Cranstonhill Works, Glasgow. It will lift from 5 to 7 tons, according to the position of the jib.

**STELL, JOHN, R.S.A.**, an eminent Scottish sculptor, the son of a carver and gilder in Edinburgh, was born at Aberdeen in 1804. He received his education as an artist at the Edinburgh Academy, and afterwards at Rome. On returning thence in 1830, he executed a colossal group of 'Alexander and Bucephalus,' which was instantly recognised as a work of great merit. The promise of this early work he has since amply fulfilled; and is now admitted to stand in the front rank of his profession. His chief works are in Edinburgh: the colossal figure of the Queen crowning the front of the Royal Institution, which procured him the honorary appointment of Sculptor to Her Majesty in Scotland; the statue of Scott in the Scott monument,

## STOCK-BROKER—SUEZ CANAL

a commission which was won in competition; the equestrian statue of the Duke of Wellington (1852), and statues of Professor Wilson and Allan Ramsay (1865). In 1873, a duplicate of the statue of Scott was erected in the Central Park, New York.

**STOCK-BROKER, or SHARE-BROKER,** a person employed in buying and selling stock in the public home and foreign funds, also in stock or shares of joint-stock companies. In most of the principal towns stock exchanges are established, and the stock or share brokers are members of such exchanges, and are bound to transact business in terms of the rules and regulations of the exchange to which they belong. In London, in addition to ordinary brokers, there are what are called sworn brokers, who require a license from the city corporation, for which certain fees are exacted, before being entitled to transact business in the public funds. In the provincial exchanges, the brokers require no license, nor do they pay any fee to government or other authorities. The charge for brokerage or commissions varies from  $\frac{1}{4}$  in consols to  $\frac{1}{2}$  per cent. in railway stocks; the rates for shares being charged according to the amount of the share, and in accordance with a scale adopted by the stock exchanges.

**SUEZ CANAL.** In the former article on this subject, the nature of the scheme was briefly described, and illustrated by a small map; and the progress of the works noticed down to the year 1865. In this place, some of the features will receive a little further explanation, now that the canal is finished and in operation. The canal is 85 m. long.

*The Port Said Entrance.*—Port Said or Saïd, a town now containing 10,000 inhabitants, had no existence in 1860. It became the dépot of the Company, the metropolis of vast bodies of labourers and other persons employed on the works of the canal. As the Mediterranean Sea is very shallow near this point, an artificial deep channel had to be made, bounded east and west by piers stretching far out into the sea. Stone for these piers was, in the first instance, brought from a long distance; but afterwards artificial stone was made on the spot, consisting of two parts of sand and one part of hydraulic lime ground into a paste, and poured into wooden boxes or moulds. When the mixture solidified, the mould-boards were removed, and the solid blocks of artificial stone were left from three to six months in the open air to dry and harden. The blocks contain 10 cubic metres each, weigh 20 tons, and were made at a contract price of 42 francs per *mètre cube*. The western pier has a length of 7000 feet, and the eastern of 6000 feet: they are 4600 feet apart at the shore, but gradually approach towards each other, so that their outer ends are only 2300 feet apart. The western pier is continued in an arc of 1100 yards extent, so as, with the eastern pier, to shelter the harbour from all winds. Within this outer harbour is an inner port, 870 yards by 500, which is kept at a uniform depth of 30 feet, by means of steam-dredging. The lighthouse, with its electric light, is 180 feet high.

*From Port Said to Temsah Lake.*—From Port Said, the canal crosses about 20 miles of Menzaleh Lake, a salt-water shallow, closely resembling the lagoons of Venice, having from 1 to 10 feet depth of water. The canal through this lagoon is 112 yards wide at the surface, 26 yards at the bottom, and 26 feet deep. An artificial bank rises 15 feet on each side of this channel. Beyond Menzaleh Lake, heavier works begin. The distance thence to Abu Ballah Lake is 11 miles, with a height of ground above the level of the sea varying from 15 to 30 feet. Crossing the last-named lake, there is

another land distance of 11 miles to Temsah Lake, cutting through ground to a depth varying from 30 to 70 or 80 feet; and then 3 miles further across this little lake itself. At El Guisar, or Girsch, occurs the deepest cutting in the whole line, no less than 85 feet below the surface; at the water-level it is 112 yards wide, at the summit-level 173 yards, from which the vastness of the gap may be estimated. Ismailia (pop. 5000) on Temsah Lake, is regarded as the central point of the canal. While the canal was being made, it grew up rapidly from an Arab village to a French town, with the houses of engineers and managers, hotels, shops, cafés, a theatre, and a central railway-station, from which railways stretch to Alexandria and Suez.

*The Fresh-water Canal.*—This extends from the Nile to Temsah Lake, and was constructed purposely to supply with water the population accumulating at various points on the line of the canal; but is also used by small sailing-vessels. This fresh-water or 'sweet-water' canal comprises three portions or sections: (1) from the Nile east or north-east to Ismailia, on Temsah Lake; (2) from Ismailia, nearly south to Suez, on the western side of the great ship or maritime canal; (3) from Ismailia nearly north to Port Said, also on the west side of the ship canal. The first and second of these sections are really canals, large enough to accommodate small steamer and barge traffic; but the third section consists simply of a large iron pipe, through which the water is conveyed to the several stations. Plugs are inserted in the pipe wherever needed, to allow water to be drawn off for everyday wants.

*From Temsah Lake to Suez.*—The route crosses Temsah Lake to Toussoum and the Serapeum cutting, through a plateau 46 feet above the sea, where the waters were let in by the Prince and Princess of Wales, February 28, 1869. There is a space of 8 miles from Temsah Lake to the commencement of the Bitter Lakes, which had to be dug to a depth varying from 30 to 62 feet, according to the undulations of the surface. In these deep cuttings, owing to the great width of the canal, the quantity of sand to be dug out (for it is nearly all sand, though sometimes agglomerated with clay) was enormous, requiring the constant labour of a large number of powerful dredging machines and elevators. In passing through the Bitter Lakes, there was more embanking than excavating to be done, seeing that the bottom of this region is only two or three yards above the intended bottom of the great canal. From the southern end of the Bitter Lakes to Suez, a distance of about 13 miles, there is another series of heavy cuttings through the stony plateau of Chalouf, varying from 30 to 56 feet in depth. Where cutting is thus difficult, the surface width is reduced considerably from the regular width of 327 feet. The canal is intended throughout to be 72 feet wide at the bottom, and 26 feet deep.

On November 16, 1869, the S. C. was opened in form, with a procession of English and foreign steamers, in presence of the Khedive, the Empress of the French, the Emperor of Austria, the Crown-Prince of Prussia, and others. On November 27, the *Brazilian* went through; a ship of 1809 tons, 380 feet long, 30 feet broad, and drawing from 17 $\frac{1}{2}$  to 20 $\frac{1}{2}$  feet of water. Since then, the canal has continued in successful operation, and passages have been made almost daily, chiefly by British vessels. The cost of construction of the canal was said to have reached, in December 1869, the total of £11,627,000. In 1870, 491 ships, of 436,618 tons, passed through; and in 1874, 1264 ships, of 2,424,000 tons. About 70 per cent. of the shipping and tonnage belongs to Great Britain. The great advantage of the canal is, of course, the shortening of the distance between

Europe and India. From London or Hamburg to Bombay is by the Cape about 11,220 miles, but by Suez only 6332—that is, the voyage is shortened by 24 days. From Marseille or Genoa there is a saving of 30 days; from Trieste, of 37. The rate at which steamers are allowed to pass through, is from 5 to 6 knots an hour. The canal charges are, 10 francs per ton, and 10 francs per head for passengers. The receipts for 1873 amounted to 22,755,862 francs, or £911,032; and those for 1875 (when 1494 ships passed through), to 28,879,735 francs, or £1,155,185.

**SULPHUROUS ACID** some years ago became one of the most popular articles in our Pharmacopœia. This sudden popularity was mainly due to the researches of a Scottish provincial physician, Dr Dewar of Kirkcaldy, who, from beginning his experiments on cattle during the period of the late pestilence, extended them to other animals and to man, and finally obtained a series of results, which, if they stand the test of experience, will insure for him a place in any future history of medicine. There is, of course, nothing new in applying sulphur-fumes—which in reality are composed of sulphurous acid gas—as a disinfectant. The classical scholar will recollect that Ulysses employed them to remove the unpleasant smell arising from the dead bodies of Penelope's murdered lovers. 'Bring brimstone, the relief of evils,' he exclaims, 'and bring me fire that I may sulphurise the house.'—Hom. *Od.* xx. 481, 482. It is also recorded by Ovid (*Fast.* iv. 735) and other writers that the shepherds of Italy yearly purified their flocks and herds with 'the blue smoke of burning sulphur.' Professor Graham's remark, that of gaseous disinfectants, sulphurous acid (obtained by burning sulphur) is preferable, on theoretical grounds, to chlorine, and that no agent checks so effectually the first development of animal and vegetable life, may be said to contain all that was known with regard to the medicinal value of this gas, till Dr Dewar began his investigations. In his experiments in connection with the cattle-plague, he found that the most safe and convenient apparatus consists of a chafer two-thirds full of red cinders, a crucible inserted in the cinders, and a piece of sulphur-stick. A piece of sulphur as large as a man's thumb will burn for nearly twenty minutes, and will suffice for a cow-house containing six animals; and it appears undoubted that if there be due ventilation, this process may be performed four times a day for at least four months with positive advantage to the animals. When this system had been efficiently carried out—and it has been largely tried by his friends—no case of illness, not to say of death, occurred. In Mr Crookes's Report *On the Application of Disinfectants in arresting the Spread of the Cattle-plague*, that able chemist observed that 'the value of sulphurous acid in arresting the progress of the cattle-plague has been proved beyond a doubt by the experiments of Dr Dewar, and my own results entirely confirm his.' His experiments in relation to the cattle-plague led Dr Dewar to the further discovery of the value of sulphur fumigation in other departments of veterinary medicine. Peripneumonia, ringworm, mange, are amongst the diseases which rapidly disappear under its influence; and in the sudden undefined illnesses known in Scotland as 'drows' and 'towts,' to which most of our domestic animals are liable, sulphurous fumigation, if applied at the outset, rarely fails to cut short the attack.

In medical practice, there are three different forms, independently of the sulphites, in which sulphurous acid may be employed—viz. (1) As the sulphurous acid of the British Pharmacopœia, which contains 9.2 per cent. by weight, or about twenty times the volume of sulphurous acid gas

dissolved in water; (2) in the form of spray, which escapes from the preceding compound under the action of an apparatus called a Spray-producer; and (3) as a gas evolved by sprinkling at intervals small quantities of 'flowers of sulphur' on red-hot cinders placed on a common shovel, resting on a stool in the middle of the room. A mixture of equal parts of sulphurous acid and water is highly recommended by Dr Dewar as a healing agent in all cases of 'breaches of the skin,' as primary wounds, whether resulting from injuries or from surgical operations, in ulcers, burns, bed-sores, chapped hands, chilblains, saddle-sores (whether of man or beast), sore nipples, and in cases of bruises, such as black-eye, &c. Moreover, in erysipelas, its soothing properties, if diluted with two or three parts of water, are very striking. According to Dr Dewar, the feverish irritability of young children is speedily relieved by dropping from time to time a few minims (5 to 30, according to age) of the acid on a few folds of muslin fastened on the breast: here, however, the action is not local, but is due to the evolution of the gas which is inhaled. Amongst the cases in which the acid is serviceable, when applied in the form of spray or inhaled as gas, are asthma, bronchitis, catarrh, croup, diphtheria, facial neuralgia, laryngeal affections, phthisis (at all events as a palliative), scarlatina, and typhoid. Dr Dewar ascribes the healing action of sulphurous acid to its power of destroying fungi. That the acid has this power, we freely admit, but we cannot so readily admit the correctness of his view that all the diseases in which he has found it serviceable (including piles and chilblains) are dependent on fungous growths. Dr Dewar reports a case of severe sciatica, in which immediate and perfect relief was afforded by the injection of an ounce of sulphurous acid in a breakfast-cupful of gruel into the rectum. There is one affection of this class, to which Dr Dewar does not refer, in which it has been prescribed with advantage—viz., the form of gastric disorder in which *Sarcina Ventriculi* (q. v.) occurs in the vomited matter, the dose being half a drachm, largely diluted with water.

None of the *sulphites* or *hyposulphites* have as yet been introduced into the Pharmacopœia. We notice them here because their action is supposed to depend upon the liberation of sulphurous or hyposulphurous acid when the salt comes in contact with the acid juices of the stomach. It is mainly to Dr Polli that we are indebted for the introduction of the sulphites and hyposulphites of the alkalies and alkaline earths (soda, potash, and magnesia) into medicine. From the year 1857 to the present time, he has devoted almost all his time to the study of these agents. His labours are briefly summed up as follows by Dr Sanson in an excellent Memoir on 'The Germs of Cholera, and the Means of their Destruction,' published January 22, 1868, in the *Medical Press and Circular*: 'It was found that animals could, without any apparent ill effects, swallow and absorb large doses of the sulphites. It was then observed that when the animals were killed, they long resisted the putrefactive process. Another series of experiments—and in this series 300 dogs were the basis of the deductions—shewed that the sulphites exerted a prophylactic and curative power when septic poisons were introduced into the economy. Then, as regards the human subject, it was found that the stomach would tolerate large doses of the sulphites of soda or magnesia. They were tried in the various eruptive fevers, intermittent, diphtheria, typhus, typhoid, cholera and choleraic diarrhoea, pyæmia, puerperal fever, dissection wounds, malarial infection, &c. The records of cases treated in this way shew an

*Journal* for November 16, 1867, he states that since the promulgation, in 1861, of his views regarding the therapeutic value of the sulphites, no less than 153 papers on the subject have appeared; and with the exception of five or six containing certain criticisms on his labours, 'all the remainder confirm, in the strongest terms, by many hundreds of detailed observations, the value of these remedies.' A scruple of the salt dissolved in a wine-glassful of water flavoured with tincture of orange-peel, is the average dose, and it should be taken every four hours; and in some cases, as in typhoid, a grain of quinine may be advantageously added to each dose. M. de Ricci (*Dublin Quarterly Journal*, November 1866) prefers the sulphite of magnesia on the grounds, that it is less unpalatable, and contains a larger proportional quantity of acid than the soda salt. He predicts (and Dr Sanson and other physicians of repute agree with him) that eventually the treatment of zymotic diseases by the administration of the sulphites will be as fully recognised as that of ague by cinchona.

In consequence of the powerful antiseptic properties of sulphurous acid, either in the form of gas or gaseous solution in water, and of the sulphites, these substances have been employed for the purpose of preserving meat from putrefaction. A joint of meat or a fowl submitted to a daily sulphur fumigation, may be kept fit for use for many weeks. The bisulphite of lime has been found to be the most applicable of the various compounds of this class as a preservative; and Messrs Medlock and Bailey have patented a method of preserving meat by means of a preparation of this salt. In hot weather, a few drops of a strong solution of this salt will serve to keep fresh a pint of soup, jelly, milk, &c. Dr Dewar patented a method of preserving meats by sulphurous acid, or some of its compounds; but as yet the process has not come into extensive use.

**SUMNER, CHARLES**, American statesman, was born at Boston, Massachusetts, January 6, 1811. His father was a lawyer, and for many years sheriff of the county. He was educated at Harvard College, where he graduated in 1830; studied law at the Cambridge Law School; was admitted to the bar in 1834, and entered upon a large practice; edited the *American Jurist*; published three volumes of Sumner's *Reports of the Circuit Court of the United States*; gave lectures at the Law School, but declined a proffered professorship; and from 1837 to 1840, visited England and the continent of Europe. On his return, he edited *Vesey's Reports*, in 20 vols., and in 1845, made his debut in politics in a 4th of July oration, on the True Grandeur of Nations—an oration against war and the war with Mexico, pronounced by Mr Cobden the noblest contribution by any modern writer to the cause of peace. Identifying himself with the Free-soil party, he was, in 1850, chosen U. S. senator from Massachusetts, in place of Daniel Webster, where he opposed the Fugitive Slave Law, and declared 'freedom national—slavery sectional.' In 1856, he made a two days' speech on 'the Crime against Kansas,' some of which was of a violently personal character, in consequence of which he was attacked in the Senate Chamber, May 22, and severely beaten by Preston C. Brooks, and so severely injured that his labours were suspended for three or four years; during which he visited Europe for repose and health. Returning to the Senate, he supported the election of Mr Lincoln, urged upon him the proclamation of emancipation, and became the leader of the Senate, as chairman of the Committee on Foreign Relations.

tion of Hayti to the United States. He published *White Slavery in the Barbary States* (18 Orations and Speeches (1850); *Recent Speeches Addresses* (1856), &c. He died in 1874.

**SUPPLE JACK**, a name given in the southern parts of the United States of America to *Berchemia volubilis*, a twining shrub of the natural order *Rhamnaceae*, which is found as far north as Virginia. It has oval leaves, small flowers, violet-coloured berries. It abounds in the Dis Swamp and in similar situations, and ascends the tops of the highest trees. The genus *Berchemia* contains a number of species of twining shrubs natives of warm climates in different parts of the world.—The name S. J. is also given in the West Indies and tropical America to *Serjania* (or *Seria tritermata*, a shrub of the natural order *Sapindaceae* with a long, flexile, woody stem, which climbs the tops of the highest trees, and is used for walking sticks. It has poisonous properties, and is employed for stupefying fish.

**SVENIGORODKA**, a town of Russia, in the government of Kiev, 150 miles south from Kiev on an affluent of the Southern Bug. Pop. (1811), 201.

**SWAMMERDAM, JAN**, a distinguished naturalist, was born at Amsterdam, 12th February 1637. S., almost from his boyhood, shewed the greatest eagerness in the study of natural history. Having entered upon the study of medicine, particularly occupied himself with anatomy, a continued unremittingly to collect insects, to investigate their metamorphoses and habits, and, by the aid of the microscope, to examine their anatomical structure. He took his degree of Doctor of Philosophy at Leyden, in 1667, and entered upon the practice of his profession, which his bad health, however, soon compelled him to relinquish. He continued to be chiefly engrossed with anatomy and entomology. His treatise on Bees appeared in 1673; a treatise on Ephemera in 1675. It is impossible, however, for us to enumerate his many publications, all of which were first published in Dutch, and afterwards translated into Latin, and many of them into English, French, and German. S.'s discoveries were very numerous, both in human and comparative anatomy. His skill in using the microscope was very great, and his manipulation of the most minute subjects extremely dexterous. He succeeded in giving distinctness to the forms of very minute viscera, by inflating them with air; a method of his own invention. It is melancholy to add, that S., who had always displayed strong religious feelings, expressed them in his writings, was at last carried away by the fanatical extravagances of Antoinette Bourignon (q. v.), began to think all his former pursuits sinful, and relinquished them for a visionary religious life of mere meditation and devotion. His health rapidly declined, and he died at Amsterdam 17th February 1680. No man of his time contributed more than S. to the progress of natural history and physiology. He was the inventor of the method of making anatomical preparations by injecting the blood-vessels with wax, and also of the method of making dry preparations of the hollow organs, now generally employed.

**SWATOW, or CHAU-CROU**, a seaport town on the coast of China, in the province of Quang-tung 212 miles east-north-east from Canton. It is one of the ports which were opened to foreign trade by the treaty of Tien-tsin, and has a resident British consul. The trade is rapidly increasing. In 1871

SYME—TECHNICAL EDUCATION.

the imports were valued at £3,572,264, and the exports at £1,417,039; making an increase of £359,263 in the total trade since 1874. Opium is the chief article of importation, next to which rank cotton and woollen goods, metals, and cotton-yarn. The chief exports are sugar, rice, tea, and paper. S. is pleasantly situated on a sheltered bay.

SYME, JAMES, was born in 1799, in the county of Fife, and received a thorough education in art and medicine, in the University of Edinburgh. In his 19th year he began his anatomical studies under Liston, who appointed him his demonstrator. From 1825 to 1832, he lectured on Surgery in the Edinburgh school, and, while generously refusing to lecture in opposition to his old master in the Edinburgh Infirmary, he established a hospital at his own expense, where he delivered a clinical course for four years. In 1831, appeared his well-known treatise on *The Excision of Diseased Joints*; and in 1832, his *Principles of Surgery*, which has since gone through many editions, and which has established his reputation as a teacher of the first rank. In 1833, he was elected to the chair of Surgery in the

university of Edinburgh, which he filled with the highest distinction. In 1847, he gave up his Edinburgh chair to fill that vacated in London by the death of Liston; but collegiate misunderstandings induced him, after six months, to return to Edinburgh. As an operator, Mr S. had no superior; as a teacher, he had no equal. His innovations in the practice of his art were characterised by so much ingenuity, controlled by scientific caution, that they were adopted by all really great surgeons. The best of his pupils, who are numerous, and scattered over every quarter of the globe, have been heard to declare that their soundest ideas in surgery are derived from Syme. Besides the works already named, he was the author of valuable treatises on Diseases of the Rectum; on the Pathology and Practice of Surgery; on the Structure of the Urethra and *Fistula in Perineo*; on Incised Wounds; &c. He died at Edinburgh, June 26, 1870.

SZARVAS, a town of Hungary, in the county of Bekes, in a plain on the Körös, 22 miles north-east from Csongrad. It has a considerable trade in corn and cattle. Pop. (1869) 22,446.

T



AI-YUA'N, a city of China, in the province of Shan-si, on the Fuen-ho, an affluent of the Hoang-ho, 250 miles south-west of Pekin. It is said to be about ten miles in circumference, fortified and populous. Porcelain, iron wares, and carpets are manufactured.

TAVIRA, a seaport town of Portugal, province of Algarve, 20 m. N.-E. of Faro, pleasantly situated at the mouth of the Sequa. T. has decayed considerably since 1654, when, it is said, 40,000 people in the town and environs fell victims to the plague. Pop. about 11,000.

TOHERKA'SI, a town of Russia, in the gov. of Kiev, 100 miles south-east of the town of Kiev, on the Dnieper. Pop. (1867) 14,433.

TECHNICAL EDUCATION (Gr. *techné*, art) means special instruction and training for the industrial arts. This subject has received much attention of late years in consequence of comparisons drawn between the manufactures of Great Britain and those of other countries shewn in the great international exhibitions held in London, Paris, Vienna, and Philadelphia. Some good judges have asserted that owing to the superior training given in continental schools to young persons in the sciences specially bearing on the arts and manufactures, our neighbours are making much more rapid progress than we are. At all events, so much attention is now given to this kind of instruction abroad, that we can no longer afford to run the risk of falling behind in so important a matter. The subject was taken up by the Society of Arts in London in 1853, a committee of which body reported, after due inquiry, that the want of the technical element was a serious defect in the education of the country. In 1868 a select committee of the House of Commons (Mr Samuelson's) took much evidence, and made a report on this subject recommending that the state aid given to the teaching of science as applied to industry should be increased. Another parliamentary inquiry

in the form of a royal commission on the advancement of science took place in 1870, 1871, and 1872, at which a great mass of evidence was given by most of the prominent men of science in the country, and the commission has made several reports on the subject. This inquiry was not specially directed to what we may call the practical sciences, nevertheless much of the evidence bore upon these.

Government aid for the teaching of science to the industrial classes is now given through the Science and Art Department of the Committee of Council on Education, which, in 1859, established a system by which payments on results are given to certified teachers, and prizes to successful pupils. The examination questions are framed by a staff of eminent scientific men, and examinations are held all over the country in May. For a number of years past the subjects have been as follow, with exception of No. 24, which has been recently added: 1, Practical plane and solid geometry; 2, Machine construction and drawing; 3, Building construction; 4, Naval architecture and drawing; 5, Pure mathematics; 6, Theoretical mechanics; 7, Applied mechanics; 8, Acoustics, Light, and Heat; 9, Magnetism and electricity; 10, Inorganic chemistry; 11, Organic chemistry; 12, Geology; 13, Mineralogy; 14, Animal physiology; 15, Elementary botany; 16 and 17, Biology, including animal and vegetable morphology and physiology; 18, Principles of mining; 19, Metallurgy; 20, Navigation; 21, Nautical astronomy; 22, Steam; 23, Physical geography; 24, Principles of agriculture. It is announced that in 1878 a new subject called Physiology will take the place of physical geography.

The success of this scheme is shewn by the great increase (seen in the following table) which has taken place in the number of schools, and pupils that avail themselves of it.

	No. of Schools.	No. of Students.
1860.....	9	509
1866.....	153	6,835
1873.....	1182	48,544
1876.....	1484	53,330

table alone refers, was in the financial year 1876-77 £50,000, besides a sum of £3500 for prizes to students, and a further sum of £2500 for examples, books, materials, &c. About an equal sum was voted for the encouragement of art (chiefly free-hand drawing) in night schools for artisans, and in public elementary schools.

Besides the government scheme of science instruction for artisans, there are a number of private or semi-private institutions where prelections of a technological nature are given. Among the most successful of the older ones are the Watt Institution (School of Arts) at Edinburgh, and the Andersonian University at Glasgow. The former was established in 1821, and for more than 30 years the principal subjects taught were mathematics, natural philosophy, chemistry, and mechanical drawing. Within the last 20 years other subjects have been added, and the total number of students is now between 800 and 1000 annually. The evening courses of the Andersonian University, where much the same subjects are taught, are likewise very largely attended by artisans. Colleges for teaching science with special reference to the useful arts, but science of a more advanced character than can easily be taught during evening hours only, have been quite recently established in several localities, such as that of Newcastle, in connection with the university of Durham, the Yorkshire College of Science at Leeds, and the college founded and endowed by Sir Josiah Mason at Birmingham. Of a high character also is the instruction given in the Royal School of Mines, London, established in 1851, and the Royal College of Science in Dublin, both government institutions. The naval and military colleges are essentially of a like nature. At Cirencester there is a fully-equipped Agricultural College established about 30 years ago. Several of the London Corporations are now about to provide technical instruction.

Technical schools have existed for a long time on the continent. Of the more recently organised ones those of Zürich and Karlsruhe are the most extensive. The former is a college and polytechnic school combined, having about 500 students and a large staff of professors. At Karlsruhe, which is simply a polytechnic school, there are 600 students and 40 professors and lecturers. Several polytechnic schools of a high class exist in France, and some have lately been founded in the United States.

The Journal of the Society of Arts, the Reports of the Science and Art Department, and the Reports of Select Committee and the Royal Commission above referred to, contain much interesting information on this subject.

**TEGUCIGALPA**, a town of Honduras, Central America, is situated on a table-land 3426 feet above the sea, 25 miles south-east of Comayagua. T. is the largest and finest city in the state. In the vicinity are gold, silver, and copper mines; and in the north-west of the dep. of which T. is the capital, is the mountain of Agalteca, a vast mass of pure magnetic ore. Pop. 12,000.

**TELLICHERRY**, a seaport town and military station of British India, in the district of Malabar, 90 miles south-west of Seringapatam. The site of the town is very beautiful, and the neighbouring country highly productive, the low lands producing two, and in some cases three, crops of rice in the year. The cocoa-nut tree also grows in great abundance, and is put to many uses by the inhabitants. On account of its salubrity, T. has been called the Montpellier of India. There is a natural

within suitable for ships of 500 or 600 tons. Pop. about 20,000.

**TEPEIC**, a town of Mexico, in the state of Jalisco, on a height 400 miles north-west of the city of Mexico. T. is the residence, during the rainy season, of most of the wealthy inhabitants of the port of San Blas, about 25 miles distant. Pop. 10,000.

**THEODORE**, king of Abyssinia, otherwise described as Negus, Emperor or King of Kings of Ethiopia, a prince whose extraordinary career has excited much interest since war was declared against him by the English government. At the time when the article **ABYSSINIA** first appeared in this work, the subject was not of much importance to English readers, and a few additional remarks were therefore necessary to explain the leading events in the life of Theodora. Abyssinia forms, it will be recollected, a table-land, which, although lying within the tropics, has, owing to its great elevation, a cool and equable climate. Its inhabitants, who have a Caucasian or European physiognomy, profess Christianity, acknowledge a bishop or abuna selected and consecrated by the Coptic patriarch of Alexandria, make use of a system of law based on the code of Justinian, and have otherwise preserved some share of the civilisation of ancient Rome. The Abyssinian Empire was at the height of its power in the 6th c., when it extended to the shores of the Red Sea, and even included a part of Southern Arabia. The Mohammedan conquests drove back the frontier to the limits of the table-land; and since the 7th c., the inhabitants have been engaged in a ceaseless warfare with negro tribes, and with the great Mohammedan powers. They have been surrounded on all sides by hostile races. The tradition of the great power of the Negus lingered in Europe throughout the middle ages; and although separated from the West, the Abyssinians continued to consider themselves one of the Christian and civilised communities. In the 15th c., when on the point of yielding to the invaders, they appealed to the Portuguese for assistance, and it was granted, on condition that they should abandon the rites of the Coptic Church, and yield unqualified submission to the pope. The promise was given, and the invaders were driven back. The royal family received the Roman Catholic priests, and professed the tenets of the Latin Church. They could not, however, induce the native clergy and the people to follow them; and their adoption of a foreign creed was the first step to the weakening of the royal power, which had been absolute for ages, and which rested on a firm basis of tradition and custom, particularly strong among a people in the stage of progress attained by the Abyssinians. The royal family still represented are of great antiquity, and are devoutly believed by their subjects to have sprung from Menelek, a son of Solomon and the queen of Sheba. The Abyssinian Church certainly dates from the 4th c., when the first bishop, or abuna, settled at Axum. The abuna is appointed and consecrated by the Coptic patriarch of Alexandria, whose supremacy he recognises. The dissensions introduced by Catholicism in the 16th c. were followed by invasions of the Gallas on the south, and the Turks on the north. The bitterness of the struggle with the latter has been increased by the large contribution exacted by the Egyptian government on the consecration of an abuna, and represented to be a tribute or acknowledgment of suzerainty. A frantic jealousy of the Turks among all ranks of Abyssinians is now one of the most prominent facts



repeated both in India and Europe. Just as the Merovingian kings of France became mere titular monarchs, the emperors of Ethiopia became 'puppet kings.' They were chosen from the royal stock by the great feudatories, but retained the mere insignia of royalty. When the great chiefs could not agree in the selection of a monarch, any one who found himself strong enough would march upon the capital, and place upon the throne one of the royal stock, and in his name retain supreme power, under the name of Ras (head or chief), until in turn unseated by a rival adopting the same course. In this way, there have been as many as twelve puppet emperors at one time, representing the same number of rival chiefs. The country has in consequence been kept in a perpetual state of revolution. From its great natural features, it must, however, be always divided into three leading parts: (1) Tigré, forming the northern promontory of the table-land, where the Geez, a Semitic dialect, is spoken, and through which passes the chief route to the Red Sea; (2) Amhara, the middle province, where the language is the non-Semitic Amharic, and in which is Gondar, the capital and seat of supreme power; and (3) Shoa, a southern prolongation of the table-land, where the language is also Amharic, but which is isolated from the rest of the country by intruding tribes of Gallas, an alien race. Among the minor provinces, the chief are Lasta and Waag, Semen, Godjam, and Kuara. In the last century, Gooska, a Galla adventurer, entered Amhara, the central province, and securing possession of the puppet emperor, assumed the title of Ras, and fixed his family in power at Debra Tabor. He was succeeded by his son, and his grandson, Ras Ali, who, within the last quarter of a century, confirmed the power of his family by successful military enterprises against the frontier tribes and the great chiefs, and by the marriage of his mother, Waizero Menin, a beautiful and clever woman, to Johannes, the nominal emperor. Such was the success of Ras Ali, that his supremacy was acknowledged by all the great chiefs except Dejaz Berro of Godjam, and that anarchy seemed about to cease for a time in Abyssinia. It was then for the first time that relations were opened between the central province and England. So early as 1810, while Great Britain was engaged in her struggle with Napoleon, Mr Salt was sent as her envoy to Abyssinia; but he went no further than Tigré, the Ras of which was treated as an independent sovereign. When the power of the French was destroyed in the eastern seas by the capture of the Mauritius, and the destruction of the French settlements in Madagascar, the English government ceased to take any interest in Abyssinia, and Mr Salt was recalled. One member of the English mission, however, a Mr Pearce, remained behind, and acquired the confidence of Dejaz Sabagadis, who, in 1816, on the death of Walda Selasies, acquired the government of Tigré. The favour manifested by the prince last named to Englishmen induced the Church Missionary Society to establish a mission within his territories, with which was connected Dr Gobat, since Anglican Bishop of Jerusalem. Tigré was conquered, however, by Dejaz Oubié of Semen; and the missionaries, who remained faithful to the family of the displaced chiefs, were compelled to leave the country. An opening was thus made for the Roman Catholics. They seized the opportunity, and under Padre de' Jacobis, a very able Neapolitan, established themselves in Tigré, and succeeded in making a strong impression on the population, among whom their leader became known as the

in consequence of the large sum exacted by the Egyptian government on the consecration of an abuna, the office had remained vacant for many years. To secure the influence of the native church, however, Dejaz Oubié sent a mission to Egypt to obtain the appointment of a new abuna, and the Padre de' Jacobis accompanied it, to secure, if possible, the selection of a priest favourable to Rome. He was, however, thwarted by the Coptic patriarch, who appointed Abba Salama, a young man, partly educated in the English Church Mission at Cairo, and who was afterwards to be mixed up with the fortunes of King Theodore. Shoa had also been brought into contact with Europe by a Protestant mission in 1838. Two years afterwards, the same country was visited by Major Harris; but owing to deplorable jealousy, no permanent result followed. The first direct intercourse with Amhara, the central province, was brought about by Mr John Bell, an officer of the Indian navy, who had married an Abyssinian, the daughter of a chief, and settled in the country. He had taken service in the army, in which he commanded the matchlockmen, and he had become the most trusted friend and adviser of Ras Ali. He liked the country, and thought it could be opened to English commerce and colonisation with incalculable advantage to both countries. In 1842, he was visited by Mr Walter Plowden, a Calcutta merchant, on his way to Europe from India, to whom he communicated his schemes, and imparted his own enthusiasm. The two Englishmen became bosom friends, and remained together five years in Abyssinia. In 1847, Mr Plowden proceeded to England to lay his views before the English government. He was less successful than he expected; but he convinced Lord Palmerston that under Ras Ali a central and permanent government had been established in Abyssinia, and that it was desirable to open commercial relations with the country. He was appointed consul, but unfortunately his headquarters were fixed at Massowah, a seaport within the Egyptian frontier, a choice which at once excited the suspicion, and wounded the vanity of the Abyssinians. On the 2d of November 1849, a treaty was entered into between Ras Ali and Mr Plowden, and there seemed every prospect of a close connection being established with this country, when all that had been done was rendered useless by the rise of T., and the entire destruction of the power of Ras Ali.

In the early part of the century, Kuara, a district of Amhara, south-west of Lake Tzana, was ruled by Dejaz Comfu. The brother of this frontier chief died young, leaving a widow in great poverty, and a son born in 1820, named Kassai, afterwards Theodore. She was compelled to seek refuge with her boy in Gondar. There she lived in great obscurity, earning her bread by selling *kosso*, a specific against tapeworm. What her rank was, is doubtful; and it is not known how far her son was justified in claiming for her descent from the family of the titular kings. Kassai was admitted to a monastery, where he spent many years; but his asylum was afterwards attacked by an insurgent chief, and he escaped with difficulty to Kuara. He joined the army of his uncle, then fighting the Turks; and he distinguished himself so much by courage, intelligence, activity, and tact, that he obtained a wonderful influence over his fellow-soldiers. Dejaz Comfu died suddenly, and his three sons quarrelled. To settle their dispute, Birru Goahu, chief of Godjam, was called in. He entered Kuara, and conquered the best part of it. Kassai, however, resisted him,

attacked by Waizero Menin, the mother of Ras Ali, who, as we have seen, had married the titular emperor, Johannes, and who at that time ruled Dembea, the district near Gondar, the capital. Kassai encountered her troops, defeated them several times, and recovered possession of Kuara. Ras Ali thought it prudent to come to terms, recognised him as governor of Kuara, and gave him his daughter in marriage. This alliance did not, however, reconcile Kassai and Waizero Menin. They again quarrelled, and again Kassai was victorious. He captured Waizero Menin, and compelled his father-in-law to acknowledge him as Ras of Kuara and Dembea. Ras Ali had, however, become alarmed at the power of Kassai, and determined to crush him. As representing the Ras, Birru Goshu attacked him with a powerful army, and compelled him again to seek refuge in the mountains of Kuara. In the following year, Kassai entered the field against Birru Goshu, conquered him, and slew him with his own hand. He then marched against Ras Ali, and drove him to Debra Tabor, the old stronghold of his family. There he maintained for a time a determined resistance, but he was compelled at last to yield, and he then sought refuge in the country of the Gallas, where he died. Kassai then attacked the Dejaz of Godjam, son of the chief he had killed, and defeated him. The whole of Amhara thus fell into his possession. Having secured the person of the titular emperor, he called upon Dejaz Oubié of Tigré and Semen to pay tribute to him. This demand was refused with insult. Such, however, was the power of this chief, that Kassai dreaded to attack him. The rivals met in February 1854, and to avert bloodshed, agreed to allow the magnates of the empire to decide which had the best right to the throne. The abuna was more under the control of Oubié than Kassai, and the latter felt that the weight of the church would be against him. Padre de' Jacobis, as already mentioned, had acquired considerable influence in Tigré. T. made advances to him, and offered that, if he, as head of the Latin Church, would support his cause, and crown him king, he would compel the people to adopt the Romish rites. Dr Beke asserts that the Padre de' Jacobis accepted the offer. Kassai marched against Oubié, and in February 1855, a battle was fought at Debireakié, in which the latter was captured, as well as the Abuna Salama. Kassai, unscrupulously disregarding his promise to the Roman Catholic prelate, now made advances to the Abuna Abba Salama, and obtained his consent to acknowledge his descent from Solomon and the queen of Sheba, and to crown him emperor. The conditions exacted were, that Kassai should support the Coptic Church, and banish the Roman Catholics. A few days after the battle, Kassai was accordingly crowned by the abuna as Theodore of Abyssinia. It was not without reason that this name was chosen. According to an old tradition, a King Theodore was to reign in Abyssinia, conquer the kingdom of Solomon, and restore the ancient glory of Ethiopia. Kassai believed, or affected to believe, himself the man thus announced. He proclaimed himself a descendant of Solomon, but it does not appear that he ventured to ignore the titular king; on the contrary, since his coronation, he is represented as standing in the presence of the latter, naked to the waist, as is the custom of an Abyssinian servant in presence of his master. On the annexation of Tigré, T. resolved to attack Shoa, the third great province of the old empire. He invaded the country of the Wollo Gallas, defeated them, and reached Ankobar, the

out a struggle. T. now resolved to extend his conquests to the Red Sea, and enter on a crusade against the Turks for the recovery of the sea-board. He had treated up till this time the conquered provinces with great leniency, generally leaving one of the ruling family in power, and to Mr Bell and Mr Plowden he extended the same protection they had from Ras Ali. He heartily adopted many of their schemes, and was anxious to open up intercourse with England. It was difficult, however, to negotiate with him. He believed himself to possess the same claim to respect as a European monarch, and was kept in perpetual torture by imaginary slights, and more especially by the respect shewn to the Turks, whom he regards as barbarians. His vanity and touchiness were aggravated by reverse. The conquest of Shoa had not long been completed, when the Dejaz of Godjam and the prince of Tigré rebelled, the latter being supported by the French. At the time when the Roman Catholic missionaries were banished by T., Dr Krapf and the Rev. Martin Flad entered Central Abyssinia to found a Protestant mission under the auspices of Bishop Gobat of Jerusalem. They proposed to introduce handicraftsmen, not priests, who were to follow their usual avocations, and, in addition, merely to read the Scriptures, and distribute copies in the native languages. The scheme met with T.'s approval. In April 1856, the first member of the mission arrived, and others followed. Encouraged by their success, the Rev. H. A. Stern afterwards went to Abyssinia as agent of the Society for Promoting Christianity among the native Jews or Falashas, and obtained the consent of the king and abuna to found another mission. He went back to Europe, but returned early in 1863, accompanied by Mr and Mrs Rosenthal. A third, known as the Scotch mission, was founded, and all were well received. The first quarrels of T. were with the diplomatists. He was indignant at the proposal made by the English Foreign Office to exercise jurisdiction over criminals in Abyssinia, without granting him reciprocal rights. In November 1855, he was still further irritated by our refusal to receive any embassy from him without an assurance that he was to renounce all idea of reconquering from Egypt the Abyssinian territory of which it had taken possession. At this period, our government are accused of having systematically ignored complaints against the Turks. They certainly, without justification, expressed great dissatisfaction with the failure of Mr Plowden to realise the advantages of intercourse with Abyssinia, although he, in a series of admirable papers, unfortunately not published at the time, proved that it had arisen from causes he could not have anticipated. Personally, Mr Plowden remained on the best terms with T., and if he had lived, all might have gone well. The consul, however, exposed himself to great risks. He was returning to Massowah from Gondar, when he and a company of fellow-travellers were attacked by Garod, a rebel chief. He was wounded, and died of the injury he received. The king and Mr Bell marched against Garod, and killed him. Garod's brother then killed Bell, and a horrible slaughter of the insurgents ensued. After the death of Mr Plowden, Captain C. D. Cameron was appointed consul. T. was not consulted, and the new consul was coldly received in October 1862. The Egyptians were at the time advancing within the northern frontier of Tigré, and Abyssinian Christians had been subjected to indignities at Jerusalem. T. resolved to appeal to the English and French governments, and wrote letters claiming their protection. That to the Queen

was forwarded to Aden, but unfortunately did not reach London until February 1863, when it was thrust into a pigeon-hole, and ignored or forgotten. In the meanwhile, Consul Cameron was directed to visit Sennaar, on the frontier of Egypt and Abyssinia, to judge of its fitness to become a cotton-producing country. The object of this journey was not explained to T., and he naturally believed it to be a visit by a spy to his enemies the Turks. His suspicions were not allayed when the consul, on his return to Gondar, could produce no answer to the letter. He had received a dispatch, but it simply ordered him to go back to Massowah, and not to interfere with Abyssinian politics. 'So your queen,' said T., 'can give you orders to return to Massowah, but she cannot send a civil answer to my letter to her. You shall not leave till that answer comes;' and the consul was detained on parole at Gondar. In reply to the French letter, M. Lejean was sent to Abyssinia. A written answer to T. was read, in which, as if it had been intended to irritate him, something was said of the protection accorded by the Emperor of the French to all Roman Catholics in the East. This aggravated the offence already committed by the French—that of aiding the prince of Tigré. The letter was torn and trampled upon, and M. Lejean, imprisoned for a few days, was ordered off to Massowah. T. declared he would no longer be 'humbugged by missionaries and consuls like a rajah of Hindustan,' and the European residents all felt that a crisis had come. In October 1863, Consul Cameron sent letters to Massowah. His messengers were stopped, deprived of their dispatches, and beaten. On the same day, Mr Stern, who happened to pay a visit of ceremony to the emperor, inadvertently gave him offence; and he and his two servants were ordered to be beaten. The servants died the same night. Mr Stern himself was so seriously hurt that his life was despaired of. His papers were then examined, and found to contain remarks derogatory to the emperor. He and Mr Rosenthal were arrested, and on the 20th of November, they were publicly tried with all the formalities of Abyssinian law—on a charge of having committed the *crimen læsæ majestatis*. Mr Stern was accused of having circulated the report in Europe of T. being the son of a beggar-woman who sold kosso, and of his not being the descendant of Solomon and the queen of Sheba; while Mr Rosenthal was accused of having said that the country would fare better under the Turks than Theodore. The prisoners were condemned to death, but the sentence was not carried out. Two days after the trial, dispatches arrived for Captain Cameron, but there was no reply to T.'s letter. Under these circumstances, the consul was injudicious enough to apply for permission to leave. He was arrested and thrown into the prison at Gondar with the missionaries, where they remained till the following summer, when they were removed to Magdala. The English government did not seem to interest themselves about the consul; but the case of the missionaries was warmly taken up by Lord Shaftesbury and the religious public. A letter of Captain Cameron's was published, in which he said: 'No release until an answer is sent to the letter to the Queen.' The subject was brought before parliament, and the government were compelled to search for this document. It was found in the pigeon-hole where it had been put, endorsed by Lord John Russell. It had been written in 1862; it was answered in June 1864. The reply was intrusted to Mr Hormuzd Rassam, a native of Mosul, who had been employed in diplomatic service at Aden. The choice of this envoy was most unfortunate—

he being, in the eyes of Theodore, a mere Turk, and therefore a spy and an enemy. He was not received till January 1866, and then a second error was committed. Mr Rassam accepted a large present from T., and did not, or was not enabled to repay it, as was expected, by a gift equal in value, although the necessity of doing so had been fully explained to the government. T. then sent the English envoy, who was treated as a mere beggar, to prison with the other captives. This was his first distinct breach of the law of nations. After this period, he conducted himself like a madman: he caused women and children to be tortured, dishonoured, and starved in an unheard-of manner. 'Out of 3,000,000 inhabitants,' says Dr Blanc in June 1867, 'he has destroyed more than a third by war, famine, and murder.' After some unsuccessful attempts to negotiate with T., through Mr Flad, in the early part of 1867, Lord Stanley, in April, ordered him within three months to deliver up the prisoners. He took no notice of the communication, and accordingly an expedition was fitted out at Bombay for the invasion of the table-land. The force consisted of upwards of 10,000 soldiers. Early in November the advanced brigade landed at Zulla, on the Red Sea. From this point, the expedition advanced successfully in spite of many difficulties, and, in the beginning of April 1868, came within sight of Magdala. On the 10th of April, near Magdala, T. gave battle to the British forces, and sustained a defeat so decided that he forthwith made submission to the extent of surrendering all the European captives in his power; and on the 13th, Magdala, into which he had retired, was stormed, and with little difficulty was taken possession of by our forces. Neither in the battle nor the assault was there any loss of life on the British side, only a few being wounded; the Abyssinians sustained a loss of 500 killed and 1500 wounded, the most notable among the former being T. himself, who was found dead, shot in the head.—See *The British Captives in Abyssinia*, and other works, by C. T. Beke, Ph.D.; the government blue-books; an article in No. 65 of the *Westminster Review*, New Series; the works of Harris, Rudolph, Lejean, and Dufton.

THE RMO-DYNA'MICS, or the DYNAMICAL THEORY OF HEAT, though literally merely the science of the relations of Heat and Work, is now very generally employed to denote the whole science of ENERGY. See FORCE. We propose in this place to give a general sketch of this grand modern generalisation, supplementary to what will be found in the article just referred to; but, for the sake of continuity, we must repeat a little of what was there given, though in a somewhat different form.

Energy is strictly defined as the power of doing Work (q. v.), and is of one or other of two kinds—*Potential* or *Kinetic*. A raised weight, a wound-up spring, gunpowder, and the food of animals, are instances of stores of potential energy. A missile in motion, wind, heat, and electric currents are instances of kinetic energy. Sound, Light, and other forms of Wave-motion (see WAVE), are all instances of mixed potential and kinetic energy.

The modern theory of Energy contemplates it

CONSERVATION,  
TRANSFORMATION, and  
DISSIPATION.

The CONSERVATION OF ENERGY is the statement of the experimental fact, that Energy is, like Matter (q. v.), indestructible and uncreatable by any process at the command of man.

The TRANSFORMATION OF ENERGY is the statement of the experimental fact, that any one form of energy may in general be transformed wholly or

subject to the condition derived from the first fact, that the portion transformed retains its amount unchanged. It is also subject to the law of DISSIPATION, or Degradation, which is a statement of the experimental fact, that Energy generally tends at every transformation to at least a partial transformation into heat; and that, once in that form, it tends to a state of uniform distribution, in which no further transformation is possible.

The original energy of the universe, therefore, though still of the same amount as at creation, being in a state of ceaseless transformation, has been in great part frittered down into heat, and will at length take wholly that final form.

The history of the grand discoveries which are briefly summarized in these few lines, has been much discussed of late—especially in the *Philosophical Magazine*—and is now pretty clearly ascertained.

Newton took the first great step. In a Scholium to his Third Law of Motion (q. v.), he lays down in a few clear words the Conservation of Energy as the embodiment of the experimental results known in his day with reference to forces and visible motions. Part of this statement of Newton's was afterwards reinvented under the name of Conservation of Vis-viva; but all that Newton really wanted to enable him to complete the Conservation of Energy was an experimental knowledge of the nature of Heat, Electricity, &c. That heat is motion of some kind, not matter, and that the laws of its communication are the same as those of the communication of visible motion, was experimentally proved at the very end of last century by Davy. Rumford had almost completed a proof a year or two before; but he had also made a very fair attempt to determine the 'Mechanical Equivalent' of heat—i. e., the quantity of heat which is equivalent to a given amount of mechanical work. That there is such an equivalent is at once evident by looking at Davy's discovery in the light of Newton's Scholium already referred to. But though the Dynamical Theory of Heat was thus really founded in 1799, it was not generally received. The first to recall attention to it was Séguin, nephew of the celebrated Montgolfier (from whom he states that he derived his views), who, in 1839, distinctly enunciated the equivalence of heat and mechanical work, and sought to prove by experiment that heat disappears, or is put out of existence, in the production of work from a steam-engine.

In 1842, Mayer published a short note, in which he enunciated the Conservation of Energy as a metaphysical deduction from the maxim, *Causa æquat effectum*. He made no experiments to prove this general statement, but he made a calculation of the mechanical equivalent of heat from the specific heats of air—assuming that when heat is produced by compression, its amount is the equivalent of the work spent in compressing. His result was erroneous, because his data were imperfect. But it appears that his assumption, quite unwarranted as it was, is really very nearly true for air.

In 1843, Colding, led also by some metaphysical speculations, propounded the doctrine, but endeavoured to base it upon actual experiments.

Finally, Joule (q. v.), also in 1843, published an experimental determination of the mechanical equivalent of heat (770 foot pounds as the work required to heat a pound of water one degree F.), which is within half per cent. of the most trustworthy results since obtained. Joule had been, since 1840 at least, making quantitative determinations of equivalence between various forms of energy; and was led to propound the general law of Conservation of Energy

what ought to be. The complete foundation of the science on a proper basis is thus due to him; and though as we have seen, portions of it were established thoroughly by Newton and by Davy.

Before we consider what are the principal features of the theory as now developed, it is necessary to refer to the admirable investigations of Fourier and Carnot, which, though in some respects defective, must be considered as real advances. Fourier's great work, *Théorie de la Chaleur*, is devoted to the laws of conduction and radiation, i. e., to the dissipation, of heat, and is one of the most remarkable mathematical works ever written. Carnot's work *Sur la Puissance Motrice du Feu*, is the first in which any attempt is made to explain the production of work from heat. It is unfortunately marred by his assumption, that heat is a material substance though it is only fair to say that he expresses grave doubts as to the truth of this hypothesis.

(We borrow our notice of Carnot from a paper by Sir W. Thomson (q. v.) in the *Transactions of the Royal Society of Edinburgh*, 1849.)

He begins his investigation by premising the following correct principle, sadly neglected by many subsequent writers: 'If a body, after having experienced a certain number of transformations, be brought identically to its primitive physical state as to density, temperature, and molecular constitution, it must contain the same quantity of heat as that which it initially possessed.' Hence he concludes, that when heat produces work, it is in consequence of its being *let down* from a hot body to a cold one, as from the boiler to the condenser of a steam-engine. His investigation, though based on an erroneous hypothesis, is extremely ingenious and forms the foundation of the modern theory. We give a sketch of it, preparatory to our account of the present state of the theory, and for this purpose we choose a somewhat hypothetical case, simpler than the most common practical one. This is the case of a piston working air-tight in a cylinder closed at the bottom.

Suppose we have two bodies, A and B, whose temperatures, S and T, are maintained uniform, S being the warmer body, and suppose we have a stand, C, which is a non-conductor of heat. Let the sides of the cylinder and the piston be also non-conductors, but let the bottom of the cylinder be a perfect conductor; and let the cylinder contain little water, nearly touching the piston when pushed down. Set the cylinder on A; then the water will at once acquire the temperature S, and steam at the same temperature will be formed, so that a certain pressure must be exerted to prevent the piston from rising. Let us take this condition as our starting-point for the cycle of operations. 1. Allow the piston to rise gradually; work is done by the pressure of the steam, which goes on increasing in quantity as the piston rises, so as always to be at the same temperature and pressure. An *heat is abstracted from A*, namely, the latent heat of the steam formed during the operation. 2. Place the cylinder on C, and allow the steam to raise the piston further. More work is done, more steam is formed, but the temperature sinks on account of the latent heat required for the formation of the new steam. Allow this process to go on till the temperature falls to T, the temperature of the body B. 3. Now, place the cylinder on B; there is of course no transfer of heat; because two bodies are said to have the same temperature when, if they be put in contact, neither parts with heat to the other. But if we now press down the piston, we do work upon the contents of the cylinder, steam is liquefied, and

operation, and place the cylinder on the non-conductor C. The temperature of the contents is now T, and the amount of caloric in them is precisely the same as before the first operation. 4. Press down the piston further, till it occupies the same position as before the first operation; additional work is done on the contents of the cylinder, a further amount of steam is liquefied, and the temperature rises.

Moreover, it rises to S exactly, by the fundamental axiom, because the volume occupied by the water and steam is the same as before the first operation, and the quantity of caloric they contain is also the same—as much having been abstracted in the third operation as was communicated in the first—while in the second and fourth operations, the contents of the cylinder neither gain nor lose caloric, as they are surrounded by non-conductors.

Now, during the first two operations, work was done by the steam on the piston; during the last two, work was done against the steam; on the whole, the work done by the steam exceeds that done upon it, since evidently the temperature of the contents, for any position of the piston in its ascent, was greater than for the same position in the descent, except at the initial and final positions, where it is the same. Hence the pressure also was greater at each stage in the ascent than at the corresponding stage in the descent; from which the theorem is evident.

Hence, on the whole, a certain amount of work has been communicated by the motion of the piston to external bodies; and the contents of the cylinder having been exactly restored to their primitive condition, we are entitled to regard this work as due to the caloric employed in the process. This, we see, was taken from A, and wholly transferred to B. It thus appears that caloric does work by being let down from a higher to a lower temperature. And the reader may easily see that if we knew the laws which connect the pressure of saturated steam, and the amount of caloric it contains, with its volume and temperature, it would be possible to apply a rigorous calculation to the various processes of the cycle above explained, and to express by formulae the amount of work gained on the whole in the series of operations, in terms of the temperatures (S and T) of the boiler and condenser of a steam-engine, and the whole amount of caloric which passes from one to the other.

Though the above process is exceedingly ingenious and important, it is to a considerable extent vitiated by the assumption of the materiality of heat which is made throughout. To shew this, it is only necessary to consider the second operation, where work is supposed to be done by the contents of the cylinder expanding without loss or gain of caloric, a supposition which our present knowledge of the nature of heat shews to be incorrect. But it is quite easy, as seems to have been first remarked by J. Thomson in 1849, to put Carnot's statement in a form which is rigorously correct, whatever be the nature of heat. J. Thomson says: "We should not say, in the third operation, 'compress till the same amount of heat is given out as was taken in during the first.'" But we should say, "compress till we have let out so much heat that the further compression (during the fourth stage) to the original volume may give back the original temperature." It is but bare justice, however, to acknowledge that Carnot himself was by no means satisfied with the caloric hypothesis, and that he insinuates, as we have already seen, more than a mere suspicion of its correctness.

back again from B to A, by performing the same operations in the opposite order, requires that we expend on the piston, on the whole, as much work as was gained during the direct operations. This most important idea is due to Carnot, and from it he deduces his test of a perfect engine, or one which yields from the transference of a given quantity of caloric from one body to another (each being at a given temperature) the greatest possible amount of work. And the test is simply that the cycle of operations must be reversible.

To prove it, we need only consider that, if a heat-engine, M, could be made to give more work by transferring a given amount of caloric from A to B, than a reversible engine, N, does, we may set M and N to work in combination, M driven by the transfer of heat, and in turn driving N, which is employed to restore the heat to the source. The compound system would thus in each cycle produce an amount of work equal to the excess of that done by M over that expended on N, without on the whole any transference of heat; which is of course absurd.

The application of the true theory of heat to these propositions was made in 1849, 1850, and 1851 respectively, by Rankine, Clausius, and W. Thomson. Rankine employed a hypothesis as to the nature of the motion of which heat consists, from which he deduced a great many valuable results. Clausius supplied the defects of Carnot's beautiful reasoning; accommodating it to the dynamical theory by a very simple change, and evolving a great number of important consequences. But by far the simplest, though at the same time the most profound, writings on this subject, are those of W. Thomson, to be found in the *Transactions of the Royal Society of Edinburgh*; and these must be consulted by any reader who desires to have a clear statement and proof of thermo-dynamical laws, not complicated by unnecessary hypotheses or formulae, and yet perfectly general in its application.

In its new form, thermo-dynamics is based on the two following laws:

Law I. (Davy and Joule.) *When equal quantities of mechanical effect are produced by any means whatever from purely thermal sources, or lost in purely thermal effects, equal quantities of heat are put out of existence, or are generated.*

Law II. (Carnot and Clausius.) *If an engine be such that, when it is worked backwards, the physical and mechanical agencies in every part of its motions are all reversed, it produces as much mechanical effect as can be produced by any thermo-dynamic engine, with the same temperatures of source and refrigerator, from a given quantity of heat.*

The proof of this second law differs from that of Carnot (already given as regards reversible engines) by being no longer based on the supposition of the materiality of heat, but on the following axiom, in some of its many possible forms—It is impossible, by means of inanimate material agency, to derive mechanical effect from any portion of matter by cooling it below the temperature of the coldest of the surrounding objects. It will be easily seen that the pair of engines (one reversible) before mentioned would, if worked in combination, form a perpetual motion; and, besides, would constantly transfer heat from a colder to a warmer body.

One of the immediate and most important deductions from these principles is—that only a fraction of the heat employed in any engine is converted into useful work (the remainder being irreversibly

$$\frac{S - T}{S}$$

where S and T are the temperatures of the source and condenser, *measured from the absolute zero of temperature*. See HEAT. Thus, an air-engine, in which a far greater range of temperature can be safely used than in a steam-engine, employs effectively a much larger portion of the heat supplied to it; and there is no doubt that air-engines would supersede steam-engines, if we could get a material capable of enduring the great heat required.

**THERMO-ELECTRICITY AND THERMO-MAGNETISM.** If the ends of an iron wire be attached by twisting or soldering to the extremities of the copper wire of a galvanometer, and one of these junctions be heated, the galvanometer indicates the passage of a current in the circuit in a direction from copper to iron through the heated junction. The first application of the theory of energy to this phenomenon is of course as follows: Since heating the junction produces the energy of the current, part of the heat must be expended in this process; though it is of course entirely recovered as heat in the circuit, if the current be not employed to do external work. The existence of the current from copper to iron is thus associated with the cooling of the junction; and it had been experimentally shewn by Peltier, that if an electric current be passed through a circuit of iron and copper, originally at the same temperature throughout, it produced cold when passing from copper to iron, and heat when passing from iron to copper. If the two junctions be maintained each at a constant temperature, a constant current passes from the warmer to the colder junction through the iron wire; and by the conservation of energy, the heat developed in the circuit (together with the equivalent of the external work done, if the current be employed to drive an electro-magnetic engine) is equal to the excess of the heat absorbed at the warmer junction over that given out at the colder, precisely as in the case of a heat-engine. So far the process presents no difficulties. But it was discovered by Cumming in 1822, that not only is the strength of the current *not* generally proportional to the difference of temperatures of the junctions, but that if the difference be sufficiently great, the current may, in many cases, pass in the opposite direction. Thus, in the copper-iron circuit, at the temperature 300° C. of the hot junction, the current passes through it from iron to copper. Thomson (Bakerian Lecture—*Phil. Trans.* 1855—'On the Electrodynamic Properties of Metals') applied the principle of energy to this case, and derived from it the conclusion, that one of three things must happen, the most unexpected of which was found by experiment to be the actual one—viz., the startling result, that a *current passing in an iron bar or wire from a hot to a cold part produces a cooling, but in copper a heating, effect*. This very remarkable discovery, which, taken in connection with that of Peltier, gives the key to the whole subject of thermo-electricity, has been made the subject of a valuable experimental investigation by Le Roux (*Annales de Chimie*, 1867).

The theory of such phenomena (and of others far more complex, involving, for instance, crystalline arrangement), in complete accordance with the conservation of energy, has been given by Thomson (*Trans. Royal Soc. Edin.* 1854); but it would be inconsistent with the character of this work to enter into any details on so abstruse a subject. A similar remark must be made regarding his application of

stances to their temperature; one or two of his results may, however, be mentioned. Thus, iron at a moderate or low red-heat experiences a heating effect when allowed to approach a magnet, and a cooling effect when slowly drawn away from it; while in cobalt, at ordinary temperatures, exactly the opposite effects are produced. Similar effects are in general produced when a doubly-refracting crystal is turned in the neighbourhood of a magnet.

**THOUROUT**, a town of Belgium, in the province of West Flanders, 11 miles west-south-west of Bruges. There are manufactures of starch, mustard, hats, and wooden shoes. T. was a place of great commercial importance in the middle ages. Pop. (1870) above 8000.

**TILlicOULTRY**, a manufacturing town of Scotland, beautifully situated in the county of Clackmannan, on the Devon, nine miles east-north-east of Stirling, with which it is connected by railway. There are large manufactures of shawls and plaidings. Pop. (1871) 3745.

**TINNEVELLY** (*Tiru-nel-veli*), chief town of the British district of the same name, is situated near the river Chindinthoora, 350 miles south-west of Madras. The town of T. is connected with the town and military station of Pallamcottah, on the opposite bank of the river. Pop. about 20,000.

**TISCHENDORF**, LOBEGOTT FREDERICK CONSTANTINE VON, a very eminent Biblical scholar, was born at Lengenfeld, in Saxony, on January 18, 1815. His labours in search of the best and rarest MSS. in reference to the Bible, in which he was liberally assisted by the Saxon and Russian governments, were exceedingly valuable. Among the most important of his numerous excellent works are the editions of the *Sinaitic MS.* (1862, 1863, 1865), the *Eighth Critical Edition of the New Testament* (1864—1872), and the *Monumenta Sacra Inedita* (1855—1870). After being an extraordinary and ordinary professor at Leipsic, from 1845, he became Professor of Theology and of Biblical Palæography in 1859, a chair in the latter subject having been instituted for him. He was created a Count of the Russian empire, an LL.D. of Cambridge, a D.C.L. of Oxford, &c. He died on December 1, 1874.

**TODMORDEN**, a market-town of England, in the county of Lancaster, on the border of Yorkshire, 8 miles north-north-east from Rochdale, on the Manchester Railway. The town is well built, has several churches and schools, and manufactures of cotton. Coal abounds in the vicinity. The town proper of T. is composed of houses belonging to three townships, the pop. (1871) being 11,998.

**TOTEM.** The ruder races of men are found divided into tribes, each of which is usually named after some animal, vegetable, or thing which is an object of veneration or worship to the tribe. This animal, vegetable, or thing is the *totem* or *god* of the tribe. From the tribe being commonly named after its totem, the word is also frequently employed to signify merely the tribal name. Numerous tribes with totems exist in America, in Australia, the South Pacific Islands, and in Central Asia; and there are some reasons for thinking that such tribes were once numerous even in Europe among races belonging to what is called the Indo-European division of the human family.

Among the Red Indians of America, the following are totems of tribes existing or known to have existed: the Wolf, Bear, Beaver, Turtle, Deer, Snipe, Heron, Hawk, Crane, Duck, Loon, Turkey, Musk-rat, Sable, Pike, Cat-fish, Sturgeon, Carp,

tralians, the totems are similarly, for the most part, selected from the fauna of the country. The totems of the Kirghiz tribes of Central Asia are all of them animals to which (in explanation of their reverence for them) the tribes trace back their descent.

It has been suggested that the explanation of the crests and emblems of the now disrupted tribes and clans of our own country, and of Europe generally, is to be found in the supposition, that the creature or thing on the crest was originally the totem of the clan or tribe. On this supposition, the widespread clan Chattan or Cattan, for instance, which is represented in the Scotch Highlands, and can be traced in France, Germany, and Egypt, would fall to be recognised as the *Cat* tribe, the cat having once been its *totem*, as it is still its crest or emblem. It has also been thrown out, that many of the mythical traditions of ancient Greece admit of a reasonable meaning, if we suppose that there were anciently in Greece tribes with *totems*—bull, boar, and lion tribes; snake, ant, and dragon tribes. These suggestions have not yet been put to the test of a thorough investigation; but so far as inquiry has gone, the results are in favour of the conclusions to which they point as to the early condition of human tribes all over the world. A single instance may be given of success in tracing back a totem to old times and in widely separated countries. There are numerous existing Snake tribes both in America and the South Sea Islands, and there is something like *proof* that the snake was the totem of very many and powerful ancient races. Its worship can be traced among Semitic races; there are traces of it in the traditions of the Pelasgi; there are proofs of it among the Celts; and the most magnificent ecclesiastical architecture in the world is that of the Nagas—the serpent-worshippers of Cambodia—still existing, and only recently brought to light. We may believe that, in the period of primitive animal-worship, when the serpent was a creature of so much importance, other animals also had their worshippers, and that snake-tribes were not the only tribes with animal totems in those times, any more than they are among existing primitive peoples.—See *Cambrian Journal*, vol. iii., 2d series, p. 149; *Grey's Journals*, vol. ii. chap. xi.; Mitchell's *Russians in Central Asia*; Latham's *Descriptive Ethnology*; Sydenham's *Baal Durstrogenis*; and foot-note to *Kinship in Ancient Greece*, by J. F. M'Lennan; *Fortnightly Review*, 15th April and 1st May 1866.

**TRADES' UNIONS**, in their character of benefit and sick societies, do not fall within the range of this article. We have principally to consider them as associations of workmen against employers, for the purpose of gaining, either in time or money, a larger share of the profits of their trade. A brief historical sketch of the growth of the principle of combination may fitly introduce the subject.

In one form or other, combination has always existed, ever since the employed and employing classes became distinguishable from each other. For a long time after the Conquest, the inhabitants of England were of two classes, freemen and slaves. These relations not permitting work for wages, there could be then no combination in the modern sense. About the middle of the 13th c., we find that wages had begun to be paid, so that for 600 years there have been labourers receiving a money price for their services, competing for employment, and arranging terms with employers. The power of legislation was, however, with men who believed

the reduced number of labourers demanded better pay, it was enacted that carters, ploughmen, and agricultural servants generally should be content with their previous rate of liveries and wages; they were to continue to be paid in kind where payment in kind had been customary; they were forbidden to hire themselves for the day, but must take service for a year or other fixed period; a rate of wages was fixed for weeders, haymakers, mowers, and reapers; and their hiring for the future was to be in public. A little later, in 1363, the diet and clothing of artificers and servants were fixed by act of parliament, and clothiers were required to make, and tradesmen to sell, cloth of a regulated quality at a regulated price. The rate at which labour should be purchased was fixed after this fashion for almost two centuries, and the practice declined solely because of the impossibility of preserving it. But even within the last 150 years, a relic of the old superstition revived, so characteristic as to be worth notice. A tariff of wages, drawn up in 1725 by the Manchester justices, declares that any workman conspiring to obtain more than the rate thereby fixed, should for the third offence stand in the pillory, and lose an ear. Economical error, it will be seen, is by no means the monopoly of the poor.

One of the earliest forms assumed by combination is shown by the statutes, passed about 1400 A.D., which excluded from city labour all who had been trained to the plough up to the age of 12 years. The evasion of these acts was the subject of bitter complaints from the city inhabitants, whose practical union against agriculturists was defeated by the sending of country children into towns as apprentices before they reached that age. For generations, this jealousy of corporation against corporation continued with more or less intensity.

In the more ancient forms of associated labour, such as guilds and chartered companies, combinations such as those which now prevail could not exist. There were no masters and workmen as separate and opposed classes. Producers were united as against the community, and they had no reason, so long as the guild was prosperous, for internal dissension. When, by the abuse of their power in prosperity, they incurred hostile legislation, they became disintegrated; workmen were employed who had never been apprentices; and ultimately the owners of capital and the owners of labour became distinct and often opposing camps. Instead of a guild or trade being any longer a compact monopolist body, acting for itself against the community, the tendency was thenceforward for combination of one section against the other.

Trades' unions, organised for purposes such as those which contemporary unions contend for, have existed for more than three centuries. So early as 1548, a statute of Edward VI. is directed, amongst other culprits, against certain 'artificers, handicraftsmen, and labourers,' who had 'sworn mutual oaths' to do only certain kinds of work, to regulate how much work should be done in a day, and what hours and times they should work. The usual penalties of fines, pillory, and loss of ears were to follow a breach of its enactments. Add the regulation of wages to the objects enumerated in this statute, and we have in effect the trades' unions of the present day. Many fruitless acts were afterwards passed to prevent combinations for raising wages. So long as a tacit bond existed, and unquestionably one did and does exist, amongst employers, reprisals on the part of workmen were certain, and the only question was, whether the

should be driven into secrecy and illegality. But it was not till 1824 that the legislature had sufficient wisdom to repeal the numerous and vexatious acts of parliament by which it had been sought to prevent the union either of masters or workmen. By the celebrated act of that year, the combination of either workmen or capitalists was legalised, so long as the unions refrained from violent interference with persons who might refuse to join them. This act was supplemented by another, passed in 1825, which in effect declared legal all combinations to settle rates of wages or hours of work, and illegal all such as aimed at other methods of controlling employers in the use of capital, or in processes of manufacture. The latest legislation (see COMBINATION) goes further still, declaring combinations legal even when acting (peaceably) in restraint of trade.

A modern trades' union is a rather complex organisation. Perhaps the best definition of them is the one given by the Social Science 'Committee on Trade Societies,' appointed at Bradford in 1859, and which published its Report in 1860. The committee included Dr Farr, Professor Fawcett, Mr W. E. Forster, and many other well-known names, and its investigations were very searching and valuable. Indeed, its Report is even yet by far the best repository of facts on the subject. A trade society is therein defined as 'a combination of workmen to enable each to secure the conditions most favourable for labour.' The capitalist's accumulations afford him an advantage which the labourer, without association, does not possess. The funds of the union are intended to supply this deficiency. As accessories, the unions collect funds for other purposes, such as benefit societies, insurance of tools, libraries, and reading-rooms; but their trade objects are those with which we are especially concerned. The following means of assisting and defending the trades associated are enumerated by the committee as now in general use—1. Publishing periodically the state of the trade in different parts of the country; 2. Keeping registers of men unemployed and of masters wanting men; 3. Assisting men from town to town in search of employment, and occasionally to emigrate; 4. Regulating the number of apprentices in the trade; 5. Maintaining men in resistance to employers; 6. Regulating number of working-hours, and preparing trade rules; 7. Organising strikes.

The advocates of the unions insist that they are the only means by which workmen can defend themselves against the aggression of employers. It is argued that the individual labourer has no chance of resisting the capitalist on equal terms; that starvation treads too closely on his heels to permit his successfully opposing a reduction of his wages, however arbitrary or unjust. It is urged that associations of employers are practically universal, and that their object is mainly to secure for themselves the largest possible share of the profits which are the product of capital and labour united. It is further said, that in the event of any depression of trade, the masters invariably attempt to reduce wages; and that when trade improves, they defer as long as possible the restoration of the former rate. Thus, workmen are the first to feel commercial disaster, and the last to benefit by better times. Any attempt to remedy this state of things by individual action would, it is conceived, be abortive. The capitalist might easily do without the services of any single labourer, while to the latter the loss of employment might be ruin. Association on the part of the employed class becomes, therefore, a necessity, and their organisation puts them at once

is a constant gravitation against the workman seems to be admitted by most who have considered the subject, and there is difficulty in suggesting any effective resistance to the downward tendency, except that of combination. Unionists point to many regulations in the interests of workmen which combination has enabled them to introduce, and while they freely admit that in numerous instances the contest between labour and capital has resulted in the apparent defeat of the former, yet they assert that, in the long run, most of the points contended for have been gained. They maintain that, in very many trades, they have succeeded in preventing abuses, and that the unions have contributed, more than any other agency, to make 'the workman's life regular, even, and safe.' Further, it is contended that the necessity for strikes will become continually less as organisation becomes more perfect and uniform; the just limits of their action will be more fully comprehended; the sufferings and losses of past strikes will act as a warning against too precipitate action in the future, either on the part of masters or men; and that, in the end, the main results of combination will be secured, without the necessity of having recourse to the arbitrament of force, either in the shape of strikes or lock-outs—the latter of which, indeed, is only a strike of the employers against the employed.

Yet it cannot be concealed that against this catalogue of uses may be set many and serious evils. Some unions dislike the exertion of special or superior ability by any of their members, deeming it an injustice to the rest that one should gain higher pay or win a loftier position. In many cases, as a matter of deliberate policy, they set themselves against and discountenance any elevation of the standard of labour, and so act as an effectual bar to the industrial progress of their class. In other instances, strikes are determined upon by unions at times when the position of the market renders success impossible, resulting in severe and prolonged suffering; while in some 'highly skilled and limited trades,' a far higher rate of wages has been enforced for a time than the value of the labour performed would justify, in the end materially checking production, or transferring the industry itself to other countries. The same effect has been produced by the arbitrary enforcement, in some branches of manufacture, of obnoxious restrictions upon the hours and mode of working. Thus, Birmingham lost much of that portion of its hardware manufacture which is now carried on by machinery, in consequence of the resistance offered by the Birmingham artisans to the introduction of machine-labour; and the steel manufacture threatened at one time to migrate from Sheffield, on account of trades' union dictation. There is, moreover, another and serious class of objections. There can be no doubt that unions foster an unfortunate spirit of antagonism. Being constantly and consciously on the defensive, they come at last to suspect evil in every movement, and to put a sinister interpretation on every action of employers. The special interests of the trade affected are too often the only objects cared for; and narrow, selfish, and unjust regulations are enacted for its supposed benefit. One trade is isolated from another; one class of labourers fences itself off against incursions upon its peculiar territory, and tries, by the limitation of the number of apprentices, the enforcement of objectionable terms of service, and other coercive methods, to remain a close monopolist corporation. It is needless to point out how injuriously such a policy affects



In some trades, the practice of coercion has grown into systematic terrorism and crime. The Sheffield grinders and the Lancashire brickmakers began with merely refusing to work with non-unionists; but their methods of procedure have ended in frequent brutal and murderous outrage. The revelations of the special commissions of 1867 are among the saddest contributions to English history.

One of these special commissions—that of Mr Overend and his colleagues at Sheffield—is of sufficient importance and interest to warrant rather special reference. Out of about sixty trades' unions in that town, thirteen are proved to have promoted or encouraged outrages of various degrees of criminality, from theft and intimidation up to personal violence and murder. The most ordinary method of coercion in use bears the name of 'rattening,' and it is employed to enforce payment of contributions to the unions, and to compel obedience to their rules. If any workman fall into arrears with his payments, or infringe the rules of the trade to which he belongs, his wheelbands, tools, or other materials of work are secretly removed, and held in pledge, until he submits to the requirements of the union. This is done most frequently under the direct orders of the union officers; but sometimes a private member 'rattens' another, who is known to be in some way at issue with his society, and takes the risk of his action being adopted by the remainder. In the majority of cases, on due submission and a moderate payment, the property rattened is restored to its owner. The practice is defended on the ground that it is the readiest and most effectual means of compelling the regular payment of contributions to the union funds, and of enforcing obedience to union orders. So thoroughly is it understood that rattening is the work of a trade society, that a man whose tools are taken never thinks of applying to the police for restitution; he communicates with the secretary of the union which governs his trade. In cases of contumacy on the part of a member, it is sometimes attempted to saddle his employer with the cost of the rattening, even when he is no party to the dispute, on the ground, that he ought to compel his workmen to comply with the rules of the union. Rattening is generally successful in securing its ends; but if it fail, an anonymous letter is sent to the refractory person, threatening vengeance in the event of further resistance; and in only too many instances, the threats have been carried out to the last extremity. Thus, in 1854, a man named Elisha Parker had his house blown up by gunpowder, his horse was hamstringed, and he himself disabled by a pistol-shot, because he worked with non-union men, after being warned to leave his employment. In 1857, James Linley was shot at and wounded for changing his business of grinding scissors for that of grinding saws, and keeping a greater number of apprentices than the rules of the trade prescribed. As he still persisted, he was shot to death with an air-gun in 1859. At other times, powder has been mixed with filings or other materials near the working apparatus of obnoxious persons, who have often suffered serious injuries from its explosion. The list of outrages, fatal and other, might be largely extended; but those we have given are not unfair representatives of the whole. It is only fair to add that of late years the evil pre-eminence of Sheffield has not been so obvious, but the old spirit occasionally asserts itself still, though happily in somewhat milder forms.

The ballows-cutting by the chainmakers of the

the inquiry before Mr Pickering and others in Manchester, also in 1867. We have not space to go into detail; but the examples of Sheffield, Dudley, and Wolverhampton were faithfully repeated. Powder explosions, personal injuries, the wholesale destruction of bricks by trampling upon them while soft, a shed destroyed by naphtha, the insertion of needles into the clay, so as to disable the workmen; such were among the characteristic confessions made by the witnesses. Among other reasons given for a strike was one that an employer had himself 'set a brick,' a task expressly reserved for brick-setters; and among the restrictions on trade was one forbidding the use in Manchester of bricks not made within the Manchester district, a circle about eight miles across.

Although in very many instances strikes have been begun and concluded without the intervention of trades' unions, yet, as a matter of fact, all the more notable strikes have either been organised by them, or had their direct support; and of late, the tendency has been to associate the unions of different trades into one body, so far as this particular policy is concerned. This article would therefore be incomplete without a brief reference to some of the more remarkable contests between masters and workmen.

Among the leading strikes, few, if any, have occupied the attention of the public more than the struggle between the Amalgamated Society of Engineers and their employers, which took place in 1851—1852. It originated in the determination of the workmen to abolish piecework and overtime. The dispute was further complicated through a demand made by the mechanics at Messrs Hibbert & Platt's works, in Oldham, insisting that certain self-acting machines in use there should be attended to by skilled labourers only. Thirty-four Lancashire firms entered into a written agreement to meet any action on the part of the men by the immediate closing of their establishments, which furnished employment to 10,000 people. A similar resolution was adopted by the master engineers of the London district. The men left work on the 1st of January 1852, and the works were formally closed on the 10th. The strike virtually ended on the 30th March, when the men conceded the points in dispute, with the exception of an obnoxious declaration insisted upon by the masters that none of the men employed should, for the future, either directly or indirectly support trades' unions. The cost of the strike is understood, besides the enormous loss of wages, to have exceeded £40,000, including moneys contributed to non-society men. Great numbers of the men emigrated, and fearful suffering was endured by thousands of families. The Amalgamated Society still exists, and is one of the most extensive and powerful organisations in the interest of labour in the world. In 1862, after its failure in the great struggle, it started with 7000 members. In 1860, its members exceeded 17,000, and in 1872 they numbered 41,075. The total income of the society for 1872 was above £105,000, and its accumulated funds were £149,000. It has branches in every part of the world where English engineers are employed.

The strike of 1853 in the cotton trade at Preston was also met by a lock-out. About 18,000 people were thrown out of work. The struggle lasted seven months, and during its progress public feeling was keenly roused. The 10 per cent advance in wages contended for was successfully resisted by the masters, the last chances of the workpeople

The cost of the strike to the workmen and their friends, in actual money paid, was £105,000.

In 1859, there occurred a strike and lock-out in the building trades of London. The object of the strike was to reduce the working day from ten to nine hours, the existing rate of wages being retained. It was met by the simultaneous closing of 225 building establishments, at which 24,000 men were employed. The contest lasted for nearly seven months, and ended in the surrender of the men, after an enormous loss in wages and trade funds. No less than £23,000 was contributed by other trade societies, in aid of the men concerned in this dispute.

The mining trades—coal and iron—have within the last few years shewn marked triumphs of labour over capital. The great Forest of Dean and South Wales strikes in the coal-trade terminated at the beginning of 1873, substantially in favour of the employed. Yet there are some later facts which tell the other way. A determined strike of the Edinburgh book-printers (1872—1873), for the 51 hours limit, which lasted 13 weeks, terminated in favour of the employers. Notwithstanding the absolute necessity which exists for coal in a climate and a manufacturing country like ours, and the close unions maintained by the working colliers, the coal-masters have succeeded in maintaining the upper hand, and wages are sinking back towards the old level, though now they will probably always remain at a somewhat higher point than they had reached up to 1872. The failure of the farm-labourers in 1873—1874 to carry their struggle to a successful issue, even under the singularly able leadership of Mr Joseph Arch, and notwithstanding the fact that large numbers were assisted to emigrate, so reducing the competition for employment upon which the farmers relied for victory, is another proof that triumph is not always with the men. It is only right to add that the men could scarcely be expected to succeed in their first organised attempt against a system centuries old, and one which could avail itself so readily of unskilled and imperfectly instructed labour. The executive committee of the tailor's union in New York, in closing their strike of 1869, decided to abandon the policy of strikes for the future, and to fight with the 'stronger weapon of co-operation.'

The nine-hours movement created great excitement for a time, but it is now settled in favour of the labour-classes. The first strike for it was by the Edinburgh masons in 1861. After an exhaustive struggle, the masters yielded the men's demand for a limit of 51 hours a week. Every year after that, agitation was kept up by different trades in succession; and now the hours of labour for a workman, all but universally in England, and pretty generally in Scotland, are so fixed.

The lowering of the franchise to household suffrage has lent a new significance to trades' unions. They have now become a great power in politics. There is the Trades' Congress, which holds an annual conference in the different leading towns, and discusses questions affecting the interests of labour. They have not yet begun to publish transactions; but, no doubt, they soon will, for this congress is undoubtedly to be one of the controlling social powers of Great Britain. It appoints a committee every year, which sits in London, to look after the acts of parliament and other public movements affecting trade. Another object they contemplate is to get working-men returned as members of parliament; and this they have at last accomplished by the election to the parliament of 1874 of Mr

of the Social Science Committee on Trades' Societies, 1860. For recent legislation on the subject of trades' unions, see the article COMBINATION.

TRING, a town of Hertfordshire, England, 32 miles north-west from London, near the right bank of the Ouzel, a branch of the Ouse. It is a neatly built town; has manufactures of silk, canvas, and straw-plait, and is a station on the London and North-western Railway. The Grand Junction Canal passes not far from it. Pop. (1871) 4045.

TUBE-WELL is an American contrivance, introduced into England in 1867, having for its object the obtaining of a small supply of water in a very short space of time by the application of a limited amount of manual power.

The apparatus comprises three parts—a tube or well, a rammer or monkey, and a pump. Fig. 1 shews the several parts, and fig. 2 the state when driven into the ground. The tube, AA, consists of an iron pipe about 1½ inch diameter, made in pieces of convenient length, which can be screwed together end to end. The pipe terminates at the lower end with a solid tempered steel point, and is perforated for about 16 inches from the end with small lateral apertures. The pipe is driven a short way into the

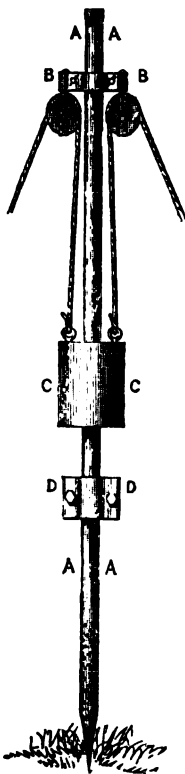

Fig. 1.

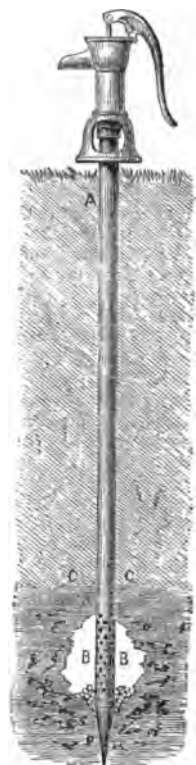

Fig. 2.

ground, just sufficient to keep it upright without falling, and is temporarily kept in that position by hand. A strong iron clamp, DD, is fixed to the tube by clamping-screws at a short distance above the ground; and another clamp, BB, is similarly fixed higher up. Two pulleys are supported by the upper

clamp. The rammer or monkey, CC, consists of a 56-lb. iron weight, which slides up and down the tube, encircling it like a ring or belt. The rammer, being raised by two men, is allowed to fall with its full weight on the lower clamp; thus giving a series of blows which drive the tube into the ground. When the lower clamp becomes level with the surface of the ground, it is raised up the tube; as is likewise the other clamp, which supports the two pulleys. Successive lengths of tube and successive shiftings of the clamps afford the means of enabling the perforated end of the tube to reach soil whence water can be obtained. When the symptoms appear of water having been reached, at CC, a small suction-pump, shewn at the top of fig. 2, is applied, and the water pumped. It is only when water is expected to be reached at a moderate distance below the surface that this apparatus is available, as it is not powerful enough for great depths, nor is the bore of the tube sufficient for a large influx of water; but the required conditions being found to exist, the apparatus saves a large amount of ordinary boring. As the water is pumped up, the loose sand and gravel disappear from the point of the tube, allowing the formation of a small pool or well (BB, fig. 2); while small pebbles which collect around the perforations act as a sort of filter. The tube can be extracted from the ground by forcing the rammer upwards against the upper clamp.

During a trial of this apparatus in the cricket-ground at Old Trafford, Manchester, the tube was sunk to a depth of 10 feet in 22 minutes, and water had been reached in even less than that time. Such a form of well, it is considered, will be free from the liability of receiving dirty surface-water; and no accident is possible from foul air or from the falling in of the sides. A well 15 feet deep was sunk in one hour in the Botanical Gardens at Manchester, and excellent water reached. Another was sunk in the grounds of St Cloud in half an hour, and pumped up water at the rate of 20 litres (18 quarts) per minute. The inventor accompanied the American Federal army, and enabled the troops frequently to obtain water by the aid of these pumps. On one occasion, to try the capabilities of the tube, he sank one to a depth of 150 feet, at Ithaca, in New York state. Tube-wells were sent out with the British military force to Abyssinia.

**TUNKERS**, a religious sect, occupying settlements in New England, New York, Pennsylvania, Ohio, Indiana, &c., and thus pretty widely scattered throughout the northern and middle parts of the United States. They are nowhere numerous, and are chiefly occupied in the cultivation of the soil. The name which they take for themselves is simply that of Brethren, and they profess that their association is founded on the principle of brotherly love. The name T. is of German origin, signifying Dippers, and is due to their dipping in baptism. It is very commonly, by corruption, pronounced and written *Dunkers*. In the vicinity of their settlements, they are generally known as the *Harmless People*. They derive their origin from a small village on the Eder in Germany, but have been an exclusively American sect since the beginning of last century, when they all emigrated to America. They had 52 communities or churches in 1859, and their number is estimated as about 8000. They reject infant baptism, and have no ministers specially devoted to the ministry as a profession. Every brother is allowed to stand up in the congregation and exhort; and when one is found particularly apt to teach, he is ordained by laying on of hands with fasting and prayer, and is expected to devote himself in some measure to the ministry, although without any stipend or pecuniary

reward, even if his own crops should suffer by his neglect of them. There are deaconesses as well as deacons among the Tunkers. Like the Quakers, they use great plainness of dress and language; they refuse to take oaths or to fight; and they will not go to law. They celebrate the Lord's Supper, and accompany it with love-feasts, washing of feet, the giving of the right hand of fellowship, and the kiss of charity. They anoint the sick with oil in order to their recovery, depending upon this unction and prayer, and rejecting the use of medicine. They generally believe in the doctrine of universal salvation; but it is not a tenet of the sect. They do not insist upon celibacy as an absolute rule; but they commend it as a virtue, and discourage marriage. They are industrious and honest, and universally held in good repute among their neighbours.

Sole dependence upon prayer for the cure of the sick is the characteristic also of a small religious sect, of which a few members are to be found in England, calling themselves the *Peculiar People*. In Switzerland, the name of Dorothea Trudel (d. 1802) was long famous for the cure of ailments by prayer. She did not, however, in all cases, refuse to call in medical advice. In Germany, a Protestant pastor, Blumhardt, pursues a similar system on a large scale, and it is said with great success.

**TUNSTALL**, a prosperous market-town of England, in the county of Stafford. Pop. (1871) 13,540.

**TYLDESLEY**, a well-built and increasing town of Lancashire, England. Pop. (1871) 6408.

**TYNDALE**, or **TINDALE**, **WILLIAM**, an eminent English reformer and martyr, well known as a translator of the Bible, was born about 1484. He was educated first at Oxford, and afterwards at Cambridge, and was, from his youth, as Foxe says, 'singularly addicted to the study of the Scriptures.' After leaving Cambridge, he became tutor and chaplain in the house of Sir John Walsh, a knight of Gloucestershire, where he frequently engaged in religious disputes with the clerical dignitaries of the neighbourhood, and soon incurred their wrath by what they deemed the heresy of his opinions. He went to London about the middle of 1523, bent upon the fulfilment of his long-cherished desire of translating the New Testament into English. Failing, however, to obtain the patronage he expected in carrying out this intention, he retired to Germany in 1524. Here his translation of the New Testament was published in 1525 or 1526, and conveyed into England. This work, although denounced by government, was yet so eagerly received by the English, that several reprints of it were produced by the Dutch printers within the next few years. T. continued on the continent, writing tracts in advocacy of the reformed doctrines; in 1530 he published a translation of the Pentateuch, and in 1531, one of the prophet Jonah. In 1533 he took up his abode in Antwerp, where, in 1534 and 1535, he published two revised editions of his New Testament. In 1535 he was treacherously arrested, and, after a confinement of 16 months, was publicly strangled and burned as a heretic at Antwerp in 1536.

T. was a man of great learning as well as talent, and his own writings, in addition to his translations, shew how well adapted he was for the great work of his life, so fearlessly carried out. Our modern version of the New Testament is substantially T.'s translation with modernized spelling. See *William Tyndale*, by Rev. R. Demaus, M.A. (1871).

**TYNDALL**, **JOHN**, physicist, was born 21st Aug. 1820, at Leighlin Bridge, County Carlow. He had few educational advantages. On returning from the continent, where he received part of his education, he found employment in one of the subordinate

grades of the Ordnance Survey. He was afterwards appointed Teacher of Natural Philosophy at Queenwood College, Stockbridge, and there commenced those original investigations which have distinguished him among the explorers of science.

In January 1853, T. communicated his first paper to the Royal Society, *On Molecular Influences—Transmission of Heat through Organic Structures*. It exhibits much of that skill in experimenting and fertility of resource which characterise his subsequent researches, and illustrates certain important questions in natural philosophy.

Year by year from the date above mentioned, T. has extended our knowledge of science. His field of research is wide and varied, as exemplified by the subjects of his papers published in the *Philosophical Transactions—On the Vibrations and Tones produced by the Contact of Bodies having Different Temperatures* (1854); *On the Physical Phenomena of Glaciers* (1857); *On some Physical Properties of Ice* (1858—1859); *On Transmission of Heat through Gaseous Bodies* (1859); a series on *Radiation*, six papers (1861—1865); *On Calorescence* (1865); *On the Invisible Radiation of the Electric Light* (1865). During the year 1867, he lectured on *Sounding and Sensitive Flames*.

In 1855, and again in 1861, T. was appointed to deliver the Bakerian Lecture to the Royal Society: the subjects were: *On the Nature of the Forces by which Bodies are repelled from the Poles of a Magnet*; and *On the Absorption and Radiation of Heat by Gases and Vapours, and on the Physical Connection of Radiation, Absorption, and Conduction*, the latter being one of the series on *Radiation* above mentioned. The publication of this series of papers marks a period in the history of scientific research, for the facts therein set forth, and the conclusions drawn from them, demonstrate the relation of aqueous vapour to radiant heat, and elucidate certain meteorological phenomena which connect themselves with some of the profoundest and most interesting questions of cosmical science.

In 1864, the Council of the Royal Society awarded to T. their Rumford medal, in recognition of his scientific researches, particularly as bearing on Light and Heat. As a lecturer on scientific subjects, T. enjoys a high reputation. His lectures at the Royal Institution and the School of Mines have been marked by fullness of knowledge and clearness of illustration. He has distinguished himself also as a traveller, particularly in the Alps.

In 1852, T. was elected a Fellow of the Royal Society, since when he has served twice on the Council. In 1853, he was appointed Professor of Natural Philosophy in the Royal Institution, where, as successor to Davy and Faraday, he sustains the reputation of the place for original scientific research. His lectures at the School of Mines have been attended by crowds of workmen. He is LL.D. of Cambridge, and is a member of a number of the scientific societies of the continent. He was chosen President of the British Association in 1874. Besides his papers for the Royal Society, T. has written articles in the *Philosophical Magazine* and *The Fortnightly Review*. His separate works comprise *The Glaciers of the Alps, being a Narrative of Excursions and Events* (1860); *Mountaineering in 1861* (1862); *Heat considered as a Mode of Motion* (2d ed., 1865); *Radiation*, being the Rede Lecture, delivered at Cambridge in 1865; *Lectures on Sound* (1867); a memoir of Professor Faraday (1868); *Fragments of Science, and Hours of Exercise in the Alps* (1871); *Six Lectures on Light* (1873); and *Address delivered before the British Association in 1874, with Additions* (1874). In 1876, T. was married to a daughter of Lord Claud Hamilton.

**TYPE-SETTING MACHINES.** The first type-composing machine on the records of the English Patent Office appears to be that of Mr W. Church, and the specification of his patent is dated March 1822. This, after a lapse of twenty years, was followed by a number of others, scarcely a year passing without one or more being made the subject of a patent. Moreover, some of them, among others those of Young and Delcambre, were for a long time before the public. For at least half a century, therefore, the construction of a useful type-setting machine has been a problem which a number of ingenious men have tried to solve, but it is only within the last year or two that there has been anything more than the mere appearance of success. If the reader will look carefully at a page of printed matter, he will notice that the spaces between the words are not equal, and he will easily understand that to reduce this inequality to a minimum, requires skill and experience if the work is to go on swiftly. It is in the doing of this, which is called 'justifying,' where a machine fails, because another operator must afterward space the machine-setting into lines of equal length. It is comparatively easy to construct a machine which will, by some mechanical arrangement, drop any required letter from a series of files or reservoirs of types, through a channel which conveys it to a composing-stick—that is, which will set up type, in any required order, but with *exactly equal spaces* between the words; but the difficulty of justifying has not yet been got over. Still, as that operation can be performed by girls at comparatively little cost, there is a decided advantage in favour of the machine.

In the early composing-machine by Church, 'the types are arranged in files in a case at the top, each file being directly over a slit in a horizontal frame. One of a number of jacks protrudes through each of these slits, each jack being connected with a key in a manner somewhat similar to the jacks and keys of a harpsichord.' On the depressing of any particular key, the undermost type of the file is pushed into a race, from which it passes to a composing-stick. It is surprising how closely this description conveys to us the leading idea in most of the type-composing machines invented since 1822. Hattersley's machine, for example, which was patented in 1837, has somewhat analogous movements, but the keys are arranged more like those of a *concertina*, and the details are different. This machine, which occupies a space of about 2 feet by 3, has a horizontal top stage on which is placed a partitioned tray, containing the rows of types running from back to front, each row being of course all the same letter. Descending vertically along the front of this tray is a series of as many wires with pistons as there are rows of types, and these pistons are depressed by the keys acting by bell-cranks, and then return to their first position by means of india-rubber bands or springs. A propeller kept in a state of tension by an india-rubber string is placed in the rear of each row of types, and draws them forward to the piston. When the girl working the machine presses down, say an *e* key, it depresses the *e* piston, which pulls down with it an *e* type, and drops it into a tube or channel which conveys it to what represents the composing-stick, and so on with every other letter, figure, comma, or 'space.' The series of channels converge to a focus or common outlet, through which every type in succession passes to its proper place. Machines on Hattersley's principle, with the details much improved by Mr Fraser of Edinburgh, are at present in use by a large printing firm there. With one of these machines a girl can compose from 'copy' at the rate of from 10,000 to 12,000 types per hour, but this rate can hardly be maintained con-

done by another girl, who, with the aid of a slip of brass of the desired length of line, forms the matter into pages, spacing out each line as she proceeds.

The want of an efficient distributing machine has hitherto been the great drawback to the adoption of compositors, but Mr Fraser has met this difficulty by constructing a distributor which bids fair to supply the want. It separates the different letters by a series of switches acted upon by keys similar to those of the composing-machine. On the depression of a key, the corresponding switch is opened, and the type guided to its proper compartment in the composing-machine reservoir. Type-setting and distributing machines like the above in their plan of working, have been in operation for several years at the *Times* office, one of which was exhibited at South Kensington in 1872. Another composing-machine, by Mr Mackie of Warrington, deserves notice for the ingenuity shewn in its construction. It is much more elaborate than any of those above referred to. The first operation is to perforate slips of stiff paper, which is done by a separate machine. These slips, when perforated, represent the words to be composed, and are then passed to the composing-machine proper. In it the types are placed by hand in a series of boxes above the circumference of a large wheel, which is made to revolve, and at each revolution a certain part, acting in concert with the previously perforated paper, comes in contact with mechanism which releases the desired types at the proper time, and carries them forward to a point, where they are pushed off into lines in the composing-stick.

**TYRCONNEL, RICHARD TALBOT, DUKE AND EARL OF**, born early in the 17th century. In his youth, according to Lord Macaulay, he was 'one of the most noted sharpers and bullies of London.' Soon after the Restoration, he endeavoured to obtain the favour of the royal family by blackening the reputation of Anne Hyde, so as to furnish the Duke of York with a pretext for breaking his promise of marriage to her. Though unsuccessful in this, he succeeded in gaining the favour of the duke, and contrived to make himself welcome at the palace both as a votary of its pleasures and as counsellor in affairs of state. Immediately on the accession of James II., he was made Earl of T., and it in command of the troops in Ireland; and in 1687, by fawning, bullying, and bribing, he got possession of the office which had long been the object of his ambition—he was appointed Lord-deputy of Ireland. His arrival in that country read terror and dismay through the English

in the country was soon transferred to the hands of the Roman Catholics. The Protestant party, so long dominant, complained bitterly that they had become a laughing-stock even to their own servants, and that to appeal to law was vain; judgment in every case being given for the native against the Englishman. But this state of matters did not last long. The revolution of 1688 had a sudden and sobering effect upon the rule of the Lord-deputy; and there can be little doubt that he would have submitted to William III.; but the Irish people threatened that if he dared to sell them for wealth or honour, they would burn the castle and him in it, and put themselves under the protection of France. On the arrival of James in Ireland in 1689, he created the earl, Duke of Tyrconnel. After the fatal battle of the Boyne, at which he held high command, he retired to France. In 1691, he returned to Ireland, with a view to furthering the efforts in favour of James, which were still being made by his adherents. Notwithstanding the defeat of Aghrim (12th July 1691), and the capitulation of Galway, he made preparations for the defence of Limerick, binding himself and his countrymen by an oath not to surrender until they received permission from James, then at Saint Germain. He at the same time despatched a letter in which he stated his conviction that all was lost. On the 11th August, before an answer could arrive, he was struck with apoplexy. He died on the 14th of the same month. He has been characterised by Macaulay as 'the fiercest and most uncompromising of all those who hated the religion and liberties of England.' He was survived until 1730 by his wife—'La belle Jennings' of the court of Charles II. This lady, so famed for her beauty and fascinating manner, entered life as maid of honour to the Duchess of York; in which position she conducted herself with a propriety which, time and place considered, may almost be pronounced unique. As wife of the Duke of T., during his rule in Dublin, her conduct seems to have been characterised both by dignity and purity. It is narrated that when James and her husband, fleeing from the defeat of the Boyne, reached her residence so bespattered with mud as to be scarcely recognisable, she dressed herself richly, and received the fugitive king and his attendants with all the splendour of court etiquette. She died in a small private nursery in Dublin in circumstances of great poverty.—See Macaulay's *History of England*, vols. ii., iii., and iv.; Chambers's *Book of Days*, vol. i. ed. 1863, p. 310; Mrs Jameson's *Memoirs of Beauties of the Court of Charles II.*, vol. ii., p. 223.

## U



**UCAYALI**, a great river of South America, one of the chief head-waters of the Amazon. It joins the Amazon from the south, in south latitude 4° 40', and west longitude 73° 30', opposite the town of Nauta in Ecuador; but the whole course of the river is in Peru. It is the largest river that joins the Amazon above the Brazilian territory, and on account of its length, has been regarded by some as the main stream of the Amazon, but at its mouth it is not above

half the width of the Amazon. The Marañon and Huallaga from the south, with many smaller but still large rivers from the north, have united to form the Amazon. The sources of the U. are in the Andes, Cuzco being situated on one of its feeders, which rises considerably further south; whilst another has its rise on the western side of the Andes, to the north-west of Lima, and after flowing southward for about 150 miles, makes its way through a cross valley, and takes a northward course. Attention has of late been very strongly directed to the U. as affording means

in 1846, by Lieutenant Herndon and Mr Gibbon of the United States navy in 1851, and more recently by an expedition sent out by the Peruvian government. It has been found to be navigable by steamers from its mouth to towns not far distant from Lima, 3700 miles from the mouth of the Amazon. On the branch which comes from Cuzco, there are falls and rapids, which form an impediment to navigation more than 100 miles below that city. The course of the U. is winding, but generally northward. Without regard to any but its principal windings, the length of its course is not less than 1100 miles. It receives many large branches. The name U. is not given to any of its head-waters, the chief of which is the Tambo, formed by the junction of the Mantaro, a river which has its sources to the north-west of Lima, and the Apurimac, which comes from a more southern region. The greater part of the country through which the U. flows is covered with forest; but it seems very suitable for colonisation, if easy communication with the rest of the world were established, the soil being fertile, whilst the mountains abound in valuable minerals.

**UGOLINO DELLA GHERARDESCA**, COUNT, an Italian nobleman of the 12th century, chiefly known for his cruel death, which Dante has immortalised in his *Inferno*. U. was for a time the head of the party of the Guelphs at Pisa, but a conspiracy, led by Archbishop Ubal dini, a Ghibeline leader, was formed against him, and with his sons and grandsons he was cast into the tower of Gualandi, and left to perish miserably by starvation.

**UMA'N**, a town of Russia, in the government of Kiev, 120 miles south of the town of Kiev, on the Umanka. It is enclosed by earthen ramparts. Pop. (1867) 14,791.

**UMBA'LLA**, or **AMBALA**, a walled town of India, in a division of the same name in the Panjab, 120 m. N.N.W. of Delhi. Under the walls of the fort are the British cantonments. Pop. (1868) of city, 24,040; of cantonments, 16,622; of division, 1,652,728.

**UMRO'HAH**, a town of British India, in the district of Moradabad, N.W. Provinces, 80 miles east-north-east of Delhi. Pop. (1871) 32,314.

**URICONIUM**, an ancient Roman city of Britain, the site of which is about four miles to the east of Shrewsbury, and is partly occupied by the village of Wroxeter. The original name seems to have been *Viroconium*, which was changed in the later Roman-British period to Uriconium. It is mentioned by Ptolemy as existing in the beginning of the second century A.D. The remains of the city shew it to have been a place of much importance. The wall can still be traced near the banks of the Severn, forming an irregular oval rather more than three miles in circumference. It appears that one of the principal streets of the city occupied the line of the *Wallington Street Road*. The remains of U. have recently been explored by an association formed for the purpose at Shrewsbury, and many

tions which have been made, affording proof of death by violence or by suffocation, shew that the city did not slowly decay, but was sacked and burned by enemies, which probably took place about the 5th century. Of this, however, there is no certain historic record. The ruins seem to have remained with little change, except the gradual process of decay, till about the 12th c., when they were used as materials for other buildings. Some of the churches of the neighbourhood were built of the old Roman bricks. The walls of buildings are now found, perfect as far as the previous accumulation of earth rendered it difficult to remove the bricks of which they were constructed. The most remarkable relic of antiquity in U. is the *Old Wall*, a great mass of Roman masonry, which appears to have been the side of a great edifice, remains of mosaic pavements having been found near it, and apparently connected with it. The edifice to which the Old Wall belonged is supposed to have occupied a corner at the junction of two principal streets. The excavations which have been made, however, leave it very difficult to explain the character and purpose of the remains discovered. Several inscriptions have been found at U., but none of great interest. A museum has been formed at Shrewsbury, in which most of the antiquities from this spot are collected. Hair-pins, combs, and rings are particularly numerous amongst them.

**U'RINE**, **INCONTINENCE OF**, or **ENEURESIS**, is a troublesome affection, far more common in childhood than in more advanced life. The child may have no bad symptom of any kind that can be detected, but it is in the constant habit of discharging its urine in bed during sleep. It sometimes wakes with a consciousness that it is performing the act, but most commonly it is not disturbed. The act may take place once, or several times, during the night, and sometimes there is an interval of a night, but seldom more. The child may often be broken off this unpleasant habit by proper domestic management, as withholding any excess of fluids before going to bed, and by waking it, and making it discharge the contents of the bladder at the time when the elder members of the family retire to bed. When such means as these fail, recourse must be had to medical advice. Blisters to the sacrum, which prevent the patient from lying flat on the back, and consequently prevent the urine from gravitating towards the most irritable part of the bladder, are often useful; and cold douches to the spine, combined with the internal use of chalybeates, are frequently serviceable. The most certain remedy, however, is extract of belladonna, given at first, according to the age of the patient, in doses varying from  $\frac{1}{4}$ th to  $\frac{1}{2}$ th of a grain, twice daily, and increasing it, if required, till it gives rise to marked constitutional disturbance.

The various forms of mechanical pressure that have been suggested, with the view of preventing the passage of the urine, cannot be too strongly reprobated.



**V**ALENCIA, a town of South America, Venezuela, in the province of Caracas, 85 miles west-south-west of Caracas, about two miles east of a lake of the same name, and about 20 miles from Puerto Cabello on the coast, with which and with Caracas it carries on an active trade. V. is finely situated in an exceedingly fertile district, in which cattle and horses are raised in great numbers. Population said to be 16,000.

**VALGUARNERA**, a town of Sicily, in the province of Caltanissetta, 48 miles north-east of Girgenti, in a mountainous district. Pop. about 9500.

**VALLS**, an old-fashioned town of Spain, in the province of Tarragona, in a plain watered by the Francoli, 55 miles west of Barcelona. V. is surrounded by ancient walls, has manufactures of cotton, woollen, silk, leather, and soap. The French, under St Cyr, defeated the Spanish here in 1809; but were in their turn defeated in 1811. Pop. 12,655.

**VAMBERY**, ARMINIUS, traveller and philologist, was born in Hungary in 1832. He was compelled to leave his country after the revolution of 1848, and went to Constantinople, where he devoted himself to studying Oriental languages. In 1861—1864 he travelled, in the disguise of a dervish, by routes unknown to Europeans, through the deserts of the Oxus to Khiva, and thence by Bokhara to Samarkand. His position precluded him from making instrumental observations for the purposes of geography, but was eminently favourable to an insight into the customs and language of the peoples visited. On this account, therefore, his *Travels and Adventures in Central Asia*, published at London in 1864, is a very valuable work. His other publications are *Wanderings and Adventures in Persia* (1867); *Sketches of Central Asia* (1868); *History of Bokhara* (1873); and *Central Asia and the Anglo-Russian Question* (1874). V. is now professor of Oriental languages at the University of Pesth.

**VELLORE**, a town and fort of British India, presidency of Madras, in the district of Arcot, 79 miles west of Madras, on the right bank of the Palar. The fort is extensive, is surrounded by a ditch cut in the solid rock, and contains barracks, hospitals, &c. The town is large, clean, and airy, and has an extensive and well-supplied bazaar. The town contains a most remarkable and splendid pagoda, dedicated to Krishna, whose adventures with the *gopis*, or milkmaids, are represented in a series of elaborate sculptures. Although the heat of V. is great, it is considered one of the healthiest stations in the Carnatic. V. was the residence of Tipoo Saib's family from 1799 to 1806, when they were removed on account of a sepoy mutiny, which resulted in a terrible massacre of Europeans. Pop. 38,022.

**VERDEN**, a walled town of Prussia, capital of a duchy, in Hanover, on the right bank of the Aller, here crossed by a bridge, and on the railway to Hanover, from which it is distant north-north-west 42 miles. Pop. (1871) 6837.

**VERVICK**, or **WERVICQ**, a town of Belgium, in the province of West Flanders, near the French frontier, on the Lys, 8 miles south-east of Ypres. Pop. (1870) about 6800.

**VIERSEN**, a prosperous and beautiful manufacturing town of Rhenish Prussia, 18 miles west of Düsseldorf. V. has extensive manufacture of woollen and flax, as also of woollen, damask, silk and velvet stuffs, and ribbons; there are also dyeworks and many other industries, which give employment to thousands of workmen. The population of V. has more than doubled itself within the last few years, being in 1871, 18,474.

**VIERZON-VILLE**, an ancient and handsome town of France, in the dep. of Cher, 48 miles south of Orleans. V. has blast-furnaces, forges, and steel-refineries, manufactures of porcelain and earthenware, and a trade in cereals and wine. Pop. (1872) 8276.

**VINAROZ**, a town of Spain, in the province of Castellon de la Plana, on the coast of the Mediterranean, 83 miles north-north-east of Valencia. Ship-building is carried on, and there are active fisheries. The bay is open and unsafe. Pop. 9793.

**VIRCHOW**, RUDOLF, pathologist and publicist, was born in 1821 at Cöslin, in Pomerania. He was a pupil of the great physiologist, Johann Müller; graduated in medicine in 1843; and became, in 1847, prosecutor to the university of Berlin. The same year, he was commissioned by the government to investigate the cause and cure of typhus in Silesia; and also, in conjunction with Reinhardt, founded the *Annals of Pathological Anatomy and of Clinical Medicine*. The political commotions of 1848 dragged him, in common with many other votaries of science, into the revolutionary vortex. He established a journal entitled the *Medical Reformer*, and also a democratic club, where he soon distinguished himself as an orator. He was, in consequence, elected a member of the National Assembly, but was not admitted because he was, in a parliamentary sense, a minor. With the conservative reaction, V. had his journal suppressed, and lost his post, but was elected to the chair of Pathological Anatomy in Würzburg. His lectures at that university were widely popular for the novel views which he struck out, particularly in cellular pathology. His reputation grew so great that he was recalled by Manteuffel, in 1856, to Berlin, where he re-occupied the chair of Pathological Anatomy, and rendered it the most famous of its kind in Europe. In 1859, when the liberal cause revived, he became member of the municipal council of Berlin, where he distinguished himself as a reformer of the arbitrary police system then rampant; and soon after, was chosen deputy by the electoral college of Saarbrück, and by two of the Berlin colleges. He soon rose to the leadership of the Opposition, and proved a most effective antagonist of the encroachments made in the name of the royal prerogative. He took the lead, in January 1863, in carrying the address in which the ministry were accused of having violated the constitution. Such was the energy of his opposition, that in June 1865 he was challenged to a duel by

stitution, and only reserves the right of objecting to those measures which seem opposed to its spirit. Among his works are his inaugural thesis, *De Rheumate Cornæ* (1843); *The Colloid Tumours of the Ovaries, and on Cancer* (1847); *Cholera* (1848—1849); *Flexions of the Uterus, Scrofula, Tuberculosis, Typhoid Fever* (1850); *Cellular Pathology* (1850); *Amyloid Degeneration* (1853); *Morbus Speæalska* (a disease peculiar to the Norwegian coasts, 1859); *Trichiniasis* (1860); *Tumours* (1862); *Cellular Pathology in its foundation on Physiological and Pathological Histology* (1871). During the wars of 1866 and 1870—1871, V. took an active interest in the sanitary arrangements for the troops in the field, and he has also written on this subject. He was elected Honorary Member of the Royal Medical Society of London in 1856, and in 1859, Corresponding Member of the Medical Society of Paris.

**VIVIPAROUS FISH.** It has been mentioned in the articles **FISHES** and **REPRODUCTION** that a few species of fishes are viviparous, or rather ovoviviparous, the eggs being hatched within the ovary. An example of this occurs in the Viviparous Blenny of the British coasts. See **BLENNY**. But it is the common characteristic of a whole family of the order *Pharyngognathi*, therefore designated by the popular name of Viviparous Fish, and by the scientific name of *Embiotocida*—a name formed from the Greek, and signifying *viviparous*. The general aspect of fishes of this family is somewhat perch-like; the scales are cycloid, the gill-covers are entire; the lips are thick. On the north-west coast of America from San Francisco to Sitka, species of this family are very abundant. They come into shallow water near the coasts, when the time approaches for producing their young, which is about the middle of summer. They swim in vast shoals close to the surface, and

to those measures which seem opposed to its spirit. The terrified fish leaping out of the water, many of them fall into the canoes. The Indians also capture these fishes by thrusting a spear with four barbed points into the midst of a dense shoal. They can be easily taken by nets, but are not of great value for the table. Our figure represents a

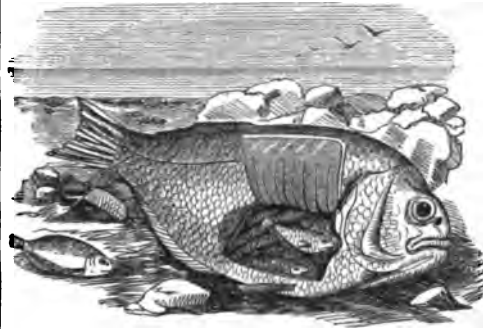

Viviparous Fish (*Ditrema argenteum*).  
(From Lord's *Naturalist in Vancouver Island and British Columbia*.)

female, cut open to show the manner in which the young are arranged within the mother.

**VOU-CHANG, or WOO-CHANG,** a city of China, in the province of Hoo-pe, on the Yang-tse-kiang, at the influx of the Han-kiang, about 350 miles south-west of Nanking. This is said to be one of the finest cities of China, famous for its learning and for its manufactures in metals. The pop. is stated at nearly 2,000,000.

## W

**WALSSEND,** a parish of the county of Northumberland, England, four miles east-north-east from Newcastle, celebrated for its collieries, which produce a very large quantity of coal of very superior quality. About 2,000,000 tons of W. coal are annually imported into London.

**WARREN, HENRY,** president of the Institute of Painters in Water-colours, was born in London, September 24, 1798. W.'s father inherited considerable wealth, which, however, he contrived to dissipate, and his children were left to shift for themselves. The subject of this memoir at first got a situation in a counting-house; but afterwards, having an intense love for art, was placed in the studio of Nollekens, the celebrated sculptor of the day. At Nollekens's, he was associated with Bonomi and Gibson. Through Benjamin West, W. obtained an introduction to the sculpture-room of the British Museum, where he practised both drawing and modelling, and where he used to meet Haydon's pupils, Bewick,

Christmas, and the Landseers. In 1818, he became a student of the Royal Academy, where he attended regularly for many years in the company of Etty, the Landseers, F. R. Lee, Webster, and others less distinguished. W.'s first paintings were in oil. He exhibited several of these from time to time at the Academy. One was a subject from Collins's *Ode to the Passions*. Etty thought very highly of this picture, and W. repeated it in water-colour, and sent it for exhibition to the 'New Society of Painters in Water-colours,' of which he became a member at its foundation in 1835. Of this society, now known as the 'Institute of Painters in Water-colours,' W. has been president for the last thirty years, during which time, both by his teaching and example, he has done much towards raising the English school of water-colour drawing to the proud eminence that it now occupies in comparison with the same branch of art in foreign countries—namely, the highest place of all. W.'s first great picture in water-colours was 'The Happy Valley,' from *Rasselas*—a piece embodying both landscape and figures, and displaying great power both in its



Some persons to suppose that he has lived a long time, or at least travelled much, in Egypt, the Holy Land, Arabia, &c. But this is not the case. Among these Eastern subjects, many are Scriptural, as—'Rebecca at the Well,' 'Hagar and Ishmael cast out into the Wilderness,' 'Christ and the Woman of Samaria,' 'Joseph's Coat brought to Jacob,' 'Christ with his Disciples in the Cornfield,' 'The Death of the First-born,' 'The Flight into Egypt.' Of eastern subjects not scriptural may be named—'The Dying Camel in the Desert,' well known by the engraving so deservedly popular; 'A Halt in the Nubian Desert;' 'Moslem Charity;' 'The Crusaders' First Sight of Jerusalem;' and 'The First Sunset witnessed by our First Parents.' This picture, with its beautiful landscape and admirably drawn figures, is said by a good authority to be 'worthy of being classed with the best works of John Martin and Danby.' Of subjects not Eastern there may be mentioned—'Alfred in the Wineherd's Cottage,' 'The Warrant exhibited to the Lady Abbess of a Benedictine Nunnery for the suppression of her Convent,' 'Incipient Courtship,' 'Happy Nutting Days,' &c., besides numerous English landscapes done from nature with much feeling and truthfulness. W. is an honorary member of the 'Société Belgique des Aquarellistes,' and of the Pennsylvania Academy of Arts; he is also Professor of the Fine Arts at Queen's College, London. He was one of the Committee of Selection in the Fine Arts Department for the Great International Exhibition at Paris in 1855; again for that of London in 1862; and for that of Paris again in 1867. W. has written a little book on *Artistic Anatomy*, which has gone through many editions; also a book on *Water-colour Painting*; two funny books, *Notes upon Notes*, and *Hints upon Hints*; and an antiquarian work, *On the River Ravensbourne*. In 1829, W. was married to Isabella, niece of John Martin the painter, and has a son, Edmund George, also a water-colour artist, whose drawings of landscape—especially when he deals with wood-land scenery—have, by their originality and truthfulness, placed their author in the foremost rank of landscape painters.

**WAR-SERVICES.** The science of destruction had made such rapid progress during the publication of the *Encyclopædia*, that to render the more important descriptive articles complete, it was necessary to add a few words in the SUPPLEMENT, to bring the information down to the standard of 1868. The articles most requiring supplement were the following, in their alphabetical order. (The bill more recent state of things will now be found in the several articles in the body of the work.)

**ADMINISTRATION, MILITARY.**—This is the comprehensive title for all that complicated machinery by which the military force and energy of a nation are endowed with cohesion and vitality. The expression Staff (q. v.) applies in a somewhat similar sense to the governing and ministering centre of a specific army, but is as much inferior to the general Military Administration as a single army is less than the country's aggregate military strength. In every nation the head of the whole administration is the minister of war, whatever exact title he may bear. Under him are the great officers charged with superintending the discipline, payment, and supplies of the army or its parts wherever situated; the military manufactures, and the national reserves. It is not necessary here to specify the various sub-departments under these chief officers; but there is a head-quarters a section representing each civil

department with all things required to maintain its efficiency.

**ADMIRAL.**—The distinction of flag—red, white, or blue—has been abolished, and the flag-officers now constitute three classes only—viz, admirals, vice-admirals, and rear-admirals, all carrying the white ensign and pendant, and the St George's cross on a white ground as their distinguishing flag, hoisted according to rank at the main, fore, or mizzen mast-head respectively.

**AMBULANCE CORPS.**—The functions of this body of men are at present undertaken by the Army Service Corps in the British army.—In the French army, the duty is confided to a section, specially trained, of the *Trains des Equipages Militaires*.

**ARTILLERY, ROYAL REGIMENT OF.**—The terms Battalion, Company, and Troop have been abolished, in favour of Brigade and Battery, which apply both to horse and foot artillery. The regiment in 1858 consisted of 33,500 men, thus distributed:

6	brigades of horse artillery, comprising 30 batteries.	
8	" field (foot) artillery, "	62 "
14	" garrison (foot) artillery, "	103 "
3	" mixed (foot) artillery, "	19 "
		214
1	" coast artillery, not in batteries.	
1	" dépôt artillery, "	
33		

This force represented from 1200 to 1300 guns fully equipped for action.—See also ARTILLERY, ROYAL REGIMENT OF, Vol. I.

**BALLISTIC PENDULUM.**—The use of this apparatus as a test of the initial velocity of projectiles has nearly ceased, its place having been taken by the Electro-ballistic Apparatus of Major Navez, a distinguished Belgian officer. This apparatus consists of a pendulum moving on a graduated arc of a circle, at a known velocity, at the top of which it is held by an electro-magnet. The projectile is fired through two screens at a known distance apart. In passing through the first screen, it breaks the electric circle, and demagnetises the magnet, causing the pendulum to fall. As the ball passes the next screen, it restores the circuit and the magnetic power, instantly arresting the pendulum in its downward course. The portion of the circle passed over by the pendulum shews the time occupied by the ball in passing from screen to screen; and that distance being known, the initial velocity becomes a question of very simple calculation. Of course, the magnet and the two screens are connected by wires with a voltaic battery.

**BARRACKS.**—The office of Barrack-master-general had been abolished in 1822, and the duties transferred to the Board of Ordnance. On the extinction of that Board in 1855, barracks came under the control of the Secretary of State for War, who confided the executive to two departments of his office—the Director of Works in regard to buildings and lands, and the Superintendent of the Barrack Department in regard to the personnel. The system of government was so far altered, that all the barrack-masters in any military district were supervised by one of their number, who ranked as district barrack-master. The correspondence of the whole district with the War Office was conducted through this officer. Barrack-masters were granted relative rank and increased pay, with some other minor advantages.—For the most recent changes, see BARRACKS, Vol. II.

**BOOTY.**—A very important decision was given by Dr Lushington, judge of the Court of Admiralty, in 1846, on the subject of the degree of co-operation

prize-money, captured in 1857—1858 by the Central India Field-force; and, speaking broadly, the decision was that only those divisions of an army could share the booty which were either directly concerned in its capture, or contributing to that operation by co-ordinate fighting within a reasonable distance of the principals. This excludes those portions of the army which inferentially contribute by keeping the enemy employed in other theatres of war. The commander-in-chief of the whole army, with his general and personal staff, take a share as well as the staff immediately in command of the capturing division. In the case in point, the capture was made in Central India, and the divisions at Delhi, the Punjab, and Oude were held to be excluded.

**BREVET.**—General promotion by brevet has for many years been abolished in the navy, and in 1854 was abolished for the army. Brevet rank can at present be obtained in three ways only, and never extends above the grade of colonel. Captains or majors may receive brevet promotion for distinguished service before the enemy. Lieutenant-colonels have brevet promotion to colonel, after commanding battalions or holding certain staff appointments for five years. When a general officer dies, the senior major and captain in the army receive each a step of brevet rank. Surgeons of twenty years' total service (or of less service for distinguished conduct) receive brevet rank as surgeons-major. These are the only modes in which brevet rank can be obtained. In the United States army, however, brevet rank is given in any grade; and we find officers with the puzzling title of 'Brevet-major-general.'

**BRITISH NAVY.**—In 1859, the navy was made a steam-navy, and sailing-vessels of war ceased, practically, to exist. No sooner was this accomplished, at great expense, than, at a still more enormous outlay, it was found necessary again to reconstruct the navy by building vessels more or less encased in iron plates, varying in thickness from 4½ to 7 inches. There were in 1867 thirty-four iron-cased ships in the British navy, of which the *Minotaur* and *Northumberland* were the largest war-ships in the world. Monitors or turret-vessels are being added.—For later information, see **BRITISH NAVY, Vol. II.**

**CANNON.**—The following table now shews the qualities of ordnance in use in the British army and navy:

BREECH-LOADING RIFLED GUNS.

Name.	Calibre.	Length.	Weight.	
	Inch.	Feet. Inches.	Tons.	Cwts.
7-inch, . . .	7	10 0	4	2
7 " . . .	7	9 11	3	12
64-pounder, . . .	6.4	9 2	3	1
40 " . . .	4.75	8 2	1	12
20 " . . .	3.75	5 6		16
12 " . . .	3	6 0		8
9 " . . .	3	5 2		6
6 " . . .	2.5	5 0		3

MUZZLE-LOADING RIFLED GUNS.

13-inch, . . .	13	14 2	23	0
9 " . . .	9	12 3	12	0
8 " . . .	8	11 4	9	0
7 " . . .	7	11 10	7	0
64-pounder, . . .	6.3	9 2	3	4

SMOOTH-BORE WROUGHT-IRON MUZZLE-LOADERS.

150-pounder, . . .	10.5	12 3	12	0
100 " . . .	9	10 3	6	5

In addition to the above, there are in all fortresses and in many ships numbers of the old cast-

**CANNON-FOUNDING.**—Guns, whether of iron or brass, have ceased to be cast at Woolwich. All new guns are now formed of iron or steel bars, wound while red-hot into a coil round a mandril, and welded together into a solid barrel. Such a coil never bursts explosively.

**CLOTHING, ARMY.**—All uniforms are now issued to the soldier without charge against him. It is merely for the renewal of 'necessaries' that the price is debited against him, the price being precisely the wholesale cost to government, and far less than that at which the soldier could purchase it.

**COAST-GUARD** has been organised under the chief direction of a comptroller, who has the rank of commodore, and is at the head of a department at the Admiralty.

**COLONEL.**—The colonelcy of a regiment is always held, as a sinecure, by a general officer, who receives £1000 a year in line regiments, and somewhat higher pay in the Guards, the best appointment being to the Grenadier Guards at £2200 a year. The rank of colonel, when held by an officer who is not a general officer, is always, except in the artillery and engineers, brevet or army rank, carrying no regimental function or precedence with it.

**COLONIAL CORPS.**—Of those mentioned in the original article, the following were disbanded by 1863: Newfoundland Veterans, Ceylon Invalids, St Helena Regiment, Gold Coast Artillery, Falkland Islands Company. On the other hand, a fourth West India Regiment was added; and a second battalion of the Ceylon Rifles was in course of formation for service in the Straits Settlements and in Hong-kong. The Malta Fencibles have been converted into a corps of artillery, and are highly efficient. For the latest changes, see **COLONIAL CORPS, Vol. III.**

**CONTROL DEPARTMENT**—sometimes called the **COMPTROL DEPARTMENT**—a presiding civil department of the army, the creation of which furnished ground for much public controversy throughout 1867, and for much misapprehension since the appointment of a Controller-in-chief to the War-office in January 1868. The common idea seemed to be, that this officer, who held high rank in the military hierarchy, was to control the whole War-office, and consequently the Minister of War himself. His title was not a very felicitous one; but his functions were merely to control the departments charged with army supplies—that is, the Commissariat, Store, Purveyors, Transport, and Barrack departments. The appointment was the result of an inquiry in 1866 and 1867 by a committee of officers, of whom Lord Strathnairn was chairman. The recommendation was, that the departments specified should not only be concentrated at headquarters; but that in every command there should be a controller, or deputy or assistant controller, according to the importance of the charge, whose duty it should be to harmonise the same departments within the command. It was the corporation formed by the controller-in-chief and these local controllers which constituted the Control Department. (The department was formed in 1870. The Controller-in-chief was in the same year replaced by the Surveyor-general of the Ordnance, a parliamentary officer under the War Secretary. In 1875, the united Control Department ceased to exist, and was divided into a Commissariat Department and an Ordnance Store Department.) See the article **COMMISSARIAT, Vol. III.**, and the article **ORDNANCE DEPARTMENT, Vol. VII.**

**CROSS, VICTORIA.**—This distinction is also applicable to the navy.

of training and recruiting at the new depot centres. The headquarters of the battalion are not at the dépôt, but with the service companies. Each battalion has two companies at the dépôt, and in time of war these would be the nucleus of a third battalion for that particular sub-district. See DÉPÔT, Vol. III.

**DOCKYARD BATTALIONS** no longer exist, with the exception of a small corps at Malta.

**ENLISTMENT, ARMY.**—By an act of 1867, the first period is fixed at 12 years, and the second at 9 years, for all arms of the service. Men are also empowered and encouraged to enlist for general service, as distinguished from enlisting for particular regiments.

**ENSIGN.**—The use of the white ensign is now peculiar to the British navy; the red ensign being assigned to yacht-clubs and non-combatant government vessels; and the blue ensign to vessels of the merchant service.

**FIFER.**—A fifer now receives pay at 1s. 1d. a day; and a fife-major, 1s. 11d.

**FLYERWOOD.**—The School of Musketry at this port has been discontinued.

**GUN-CARRIAGES.**—In consequence of the great weight of modern artillery, and the enormous strain produced by its discharge, it has been found cheaper and more efficient to construct carriages of wrought iron for all naval and garrison guns of or exceeding 6½ tons in weight.

**GUN FACTORIES, ROYAL.**—The establishment of Sir William Armstrong & Co. at Elswick, has ceased to be connected with government. When, in 1863, the government work was withdrawn, a sum of £85,000 was paid to the Company as compensation for the plant, &c. they had set up for the purposes of the manufacture.

**LAUNCH (boat).**—The launches of the largest ships of war are now usually decked vessels, fitted with steam-engines, and capable of cruising and fighting on their own account. They are hoisted inboard when the ship is on her course.

**MUSKETRY, SCHOOLS OF.**—The school at Fleetwood has been discontinued, duplicate establishments being found an unnecessary expense.

**PALLISER GUNS AND PROJECTILES.**—Since the issue of that portion of the *Encyclopædia* devoted to great guns, a considerable step in advance has been taken under the auspices of Major Palliser, a cavalry officer on half-pay. His guns have resisted charges that would have instantly shattered any others yet brought forward; and by the aid of his hardened projectiles, shields have been pierced which had defied the heaviest bolts of all other ordnance. Although only prominently before the public during the last few years, this indefatigable officer has been experimenting from time to time since 1854, always in the one direction. Cavalry service in the Crimea and in India interrupted the investigations, but they were resumed when opportunity offered. The principle of Major Palliser's gun is readily understood.

With the large charges used in this country, cast-iron guns were unequal to projecting modern shot and shell, and wrought-iron ordnance were introduced. These answered their purpose to a certain extent, as in the Armstrong and other guns; but there was an element of uncertainty in their texture, and some of them had burst with bad effects. To this might be added their enormous expense; and the fact that thousands of large cast-iron guns were in store, to all appearance useless. Many attempts have therefore been made to utilise these cast-iron guns, the means adopted being generally

preposterously cumbersome. Next, the cast-iron guns were bored up to a greater calibre, and then a thinner cannon (called a tube) was inserted, this tube being a cylinder of wrought iron or steel bored to the proper calibre. The strength thus added to the gun has been but little. Major Palliser's system for converting guns is to insert a tube of wrought iron; but that tube is coiled, as in an Armstrong gun, by winding a bar of iron round a mandril, and then welding it into a continuous barrel. These guns have withstood the utmost strain brought to bear upon them. For the preferable and cheaper process of making new guns the iron would be cast in the ordinary way around the wrought-iron tube. For the purposes of this tube, Major Palliser finds the softest and most ductile wrought iron the best, having a certain stretch in it. The authorities had already found out that thick iron plates could not be penetrated except by steel projectiles; but their use was greatly limited by their great cost. Major Palliser came, by experiment, to the conclusion, that toughness was not a necessary feature in the shot, and that hardness—no matter how brittle the material might be—was the real thing necessary for extreme penetration. With this view, he selected white iron, and cast it *in chill*, which secures the requisite amount of brittle hardness. To cast in chill, an iron mould of the exact shape is employed, with raised studs of sand inside it. The liquid metal is poured in (the sand studs forming holes for the studs of the future shot or shell to be fixed in); and the rapid conduction of heat by the iron mould causes so sudden a cooling from the outside of the mass, that the particles of iron are driven closer together than in their normal state. This produces intense hardness. The same inventor has ascertained the proper shape for the head of a shot or shell, as opposed to the flat head, the pointed conical head, and the hemispherical head already in use. He determined that the form of greatest power is the *conoidal*, which lies between the conical and the hemispherical, the conoid consisting of the intersection of two circles, each with a radius equal to twice the diameter of the projectile.

**RECRUITING.**—The competition of the labour-market at home and abroad telling very disadvantageously against the recruiting-sergeant, a Royal Commission was appointed in 1866 to consider by what means the evil might be lessened. Although all the recommendations of the commission have not been adopted, several have taken effect. Among others, an Inspector-general has been appointed to superintend and harmonise all the recruiting operations; to render the conditions of service more attractive, the pay of every soldier has been increased twopence a day, with an additional penny in prospect, if he continue to serve after the expiration of his first period of service. In 1872—1873, further changes were made. See RECRUITING, Vol. VIII.

**RESERVE FORCES OF THE UNITED KINGDOM.**—By two acts of 1867—one for an 'Army Reserve' of 50,000 men, and the other for a 'Militia Reserve' not exceeding one-fourth the number of militia—power has been given to organise a more effective body of trained men of previous good service in the army or militia, who shall be immediately available in case of invasion or imminent danger, for being drafted for the period of danger into the regular army. It was for a time understood to be under contemplation to allow soldiers to commute their last five years of army service into a double period in the Army Reserve, which would leave them at

their services as soldiers. (See, however, the article RESERVE in Vol. VIII.) With a view to harmonise the several constituents of the Reserve, and to give them that corporate organisation which is still wanting, a high officer, the Inspector-general of Reserve Forces, was appointed at the War-office.

There is a growing feeling throughout the country, as well expressed in 1867 by Lord Elcho in the House of Commons, that every citizen should be ready to bear arms in defensive war; and that, with this view, every young man should serve for two years or some other short period with the army on home service. That such a measure would raise the character of the army, while it diminished the cost of recruiting, it is impossible to doubt.

**RIFLED ARMS.**—Adverting here simply to the system adopted for rifling—whether by grooves or otherwise—the bore of the gun or rifle, and irrespective of the construction of the arm in other particulars, the scientific inquiries of the Government may be said to have been brought to a close.

In small-arms, the competition long lay between the Enfield, Lancaster, and Whitworth systems. Of these, taking all considerations into account, it was held that the Enfield system was incomparably the worst; and the Lancaster system of oval bore the best. In 1871, however, a special committee, appointed to consider the merits of the various breech-loading rifles, decided that, out of 104 different kinds of breech-loading small-arms, the Henry .45-inch bore barrel was the best adapted to the requirements of the service. The Martini breech was adopted along with the Henry barrel, to form the new small-bore rifle of the British army, known as the Martini-Henry. See RIFLED ARMS, Vol. VIII.

In great guns, after protracted experiments with the systems which gave the most favourable prospects—viz., those of Armstrong, Whitworth, Lancaster, Scott, and the French rifling—it has been decided to give the preference to the French plan, with the exception that the grooves are wider and shallower. All rifled cannon now made in the Royal Arsenal are constructed on this system, which is called the 'Woolwich' system, with a variable number of grooves according to the calibre of the piece.

**RODMAN GUN.**—This has been extensively used for large ordnance (smooth bore) in America, and is said to stand heavy charges. The guns are of cast iron, cast hollow, and then cooled from within, the process producing great hardness round the bore. A 15-inch gun was tried in 1867 at Shoeburyness; but the results, though on the whole not unfavourable, were scarcely such as would lead to its introduction in the British service. It has been suggested that a Rodman gun lined with wrought iron on Palliser's system, would prove a highly effective weapon.

**WATLING STREET**, one of the great Roman highways of Britain, commencing at Dover, passing through Canterbury and Rochester to London, and thence through Uriconium and Chester to Caer-Seiont, the ancient *Segontium*, in Caernarvonshire. From Uriconium, a branch proceeded north by Manchester, Lancaster, and Kendal, into Scotland. Traces of the ancient road are still to be found in many parts of its course, and in some it is still an important highway. A street in London retains its name. The origin of this name is very uncertain; the most probable supposition is that the original name was *Stratum Viellianum*.

**WATTS, THOMAS**, a distinguished philologist and librarian, was born in London early in the present

century distinguished himself by his attainments in English. He read every book that came in his way, and he wrote, apparently with the utmost ease, tales, essays, and poetry, very much above the average, not alone of school-boy composition, but of the magazine-writing of the day. To a knowledge of the classics and French, W. soon added an acquaintance with the other languages of the Latin family—as Italian, Spanish, and Portuguese; likewise with the German, Dutch, Swedish, Danish, and Icelandic. The facility with which he acquired these several languages, encouraged him to undertake, from time to time, the study of some of the oriental tongues, viz., Hebrew, Arabic, Persian, Turkish, and even Chinese. In each of these he made considerable progress, but cannot be said to have mastered any of them as he did those languages before named, and as he subsequently mastered the Russian, Polish, and Hungarian. There are few Englishmen who know anything of the three languages last named, which W. could read and translate with the utmost ease—being as familiar, in fact, with their great writers as he was with those of Germany or France. It remains only to mention that W. was also well acquainted with the Welsh language and literature, besides having some knowledge of the Gaelic and Irish as well. Upwards of 20 languages have thus been named with which he was well acquainted. No other Englishman has approached him as a linguist, considering the variety as well as the number of languages which he acquired; while of foreigners, it is not too much to say that Mezzofanti alone appears to have surpassed him.

In 1832, W. first became a 'reader' in the Reading-room of the British Museum, where, in studying some of the languages mentioned, he became acquainted with the deficiencies in the literature of other countries under which our national library then laboured. In 1837, the Rev. Mr Baber, then keeper of the Printed Books, purchased, at his recommendation, a small collection of Russian books, which W. offered to catalogue as a volunteer. This brought him the acquaintance of Mr Panizzi, who, becoming aware of his attainments, recommended him for employment in the library. Accordingly, he was engaged as an assistant in the department of Printed Books, January 1838. At that time, the books were being transferred from the old rooms in Montague House to the new library. It was W.'s duty to assist in the rearrangement of the books, and when this was finished, he was intrusted with the responsible duty of arranging and placing on their shelves, according to subjects, all the new works purchased or otherwise acquired for the library. For this his vast acquirements as a linguist eminently qualified him. In other respects also his knowledge of languages was brought to bear in the service of the Museum. He drew up lists of desiderata in all the languages of Europe. It was at his suggestion also that the first large orders were given for American books. 'The object' (says W. in a letter to the principal librarian in 1861, printed by order of the House of Commons in 1866) 'which has been kept in view during the last three-and-twenty years has been to bring together from all quarters the useful, the elegant, and the curious literature of every language; to unite with the best English library in England or the world the best Russian library out of Russia, the best German out of Germany, the best Spanish out of Spain, and so for every language from Italian to Icelandic, from Polish to Portuguese. In five of the languages in which it now claims this species of supremacy, in

haps fifty volumes, every book that has been purchased by the Museum within the last three-and-twenty years has been purchased at my suggestion. I have the pleasure of reflecting that every future student of the less known literatures of Europe will find riches where I found poverty.' The number of books classified and arranged by W., while only an assistant in the library, is reckoned at about 400,000 volumes, and of these as many as 100,000 were arranged upon a plan of his own invention, now known as 'the elastic system.' 'One of the advantages,' he says, in the letter before mentioned, 'obtained by this system is, that when the new library, which surrounds the new Reading-room, was ready for the reception of books, these 100,000 volumes were removed to their new locality without the necessity of altering a single press-mark: had the operation of altering the press-marks been still required, as under the former system, the amount of labour necessary to effect it would have been enormous, and the expense not less than some thousands of pounds.' Here it may be mentioned that it was W. who first suggested the erection of a library and large reading-room in the vacant quadrangle, where now rises the splendid dome erected under the auspices of Panizzi. The suggestion was originally made in a series of articles contributed anonymously to the *Mechanics Magazine* for 1836 and 1837, since that time acknowledged by W. as his own. In one of these, speaking of the quadrangle, he says: 'The space thus unfortunately wasted would have provided accommodation for the whole library. A reading-room of ample dimensions might have stood in the centre, and been surrounded on all four sides by galleries for the books, communicating with each other, and lighted from the top.' In 1856, W. was promoted to be assistant-keeper of the Printed Books; and on the opening of the splendid new Reading-room in 1857, he was most fitly appointed its superintendent. In August 1866, W. was appointed keeper of the department of Printed Books. He died 9th September 1869. W. was a member of the Philological Society of London; he was also an honorary member of the Hungarian Academy, to which he was elected at the same time as the late Lord Macaulay. Among the literary productions of W. may be mentioned: 'Notes of a Reader,' contributed to a weekly periodical entitled *The Spirit of Literature*, 1830; numerous poetical pieces contributed to Linnington's *Rhetorical Speaker and Poetical Class-Book*, 1833; *A Letter to Antonio Panizzi, Esq., on the reputed Earliest Printed Newspaper, 'The English Mercurie, 1588,'* 1839; *A Sketch of the History of the Welsh Language and Literature* (reprinted from Knight's *English Cyclopædia*), 1839; more than a hundred biographies of eminent men, Russian, Hungarian, Bohemian, &c., contributed to the same *Cyclopædia*; numerous articles in the *Biographical Dictionary* of the Society for the Diffusion of Useful Knowledge; papers in the *Transactions of the Philological Society*, among which are an 'Essay on the Hungarian Language,' and a biographical notice of Cardinal Mezzofanti; also contributions to the *Quarterly Review*, the *Athenæum*, and other literary periodicals.

**WEAVING.** There is no branch of manufacture in which inventions and improvements are more rapidly succeeding each other than in weaving; but, as a rule, they are of minor importance, and rarely affect the general principles of the process. In 1867, however, the novelty of *Convex* weaving by machinery was introduced, and although only at present applied to ladies' stays, seems to promise a

Out of the numerous attempts that have been made during the last ten years to weave by machinery a convex surface, such as is required in several articles of clothing, hardly one, up to the present time, has succeeded. This failure has been owing partly to deficiencies in the various inventions of this kind, and partly to the costliness of carrying them out. At last, after long and patient trials, a patent convex weaving-loom has been invented that not only answers all the purposes of the hand-loom, hitherto exclusively used, but also possesses the advantage, which is absolutely necessary in a country where labour is scarce, of doing ten times the amount of work in the same space of time. With the hand-loom, one man can make, at the very utmost, only four pair of stays in a day, whereas the new-invented convex weaving-machine turns out 40 pair daily. The superior lightness and flexibility of woven stays, and their perfect freedom from hard seams, have increased to a very large extent the demand for this class of goods. Up to the present moment, hand-labour alone has been employed in France and Württemberg, two countries where they have been most extensively manufactured. In the United States, however, where the high wages for hand-labour have necessitated the most extensive use of machinery, this system could not be adopted with any possibility of pecuniary success; and, in consequence of this fact, a loom for weaving of stays and other convex goods had to be invented. This loom, which was constructed under the superintendence of M. Opper, for the Convex Weaving Company in New York, does the work automatically and to perfection.

The principle of a constant length of travel for the shuttle was adopted for the sake of simplicity; but, as it is necessary, in weaving the gores, that the weft-thread should pass through only a part of the breadth of the warp, the Jacquard has been employed for the purpose of taking up the portion of the warp required to be woven in that part. It is impossible by mere verbal description to give any adequate notion of this ingenious machine without seeing it in operation.

**WEIR, or WEAR**—called also a dam, and in the north of England and south of Scotland, a cauld— a structure placed across a river or stream, for the purpose either of diverting the water into a mill-lade, of raising the level of the surface of the river, and thereby increasing its depth for the purpose of navigation, or of providing the means of catching salmon and other fish. There is also the waste-weir, for the purpose of preventing a reservoir embankment being overtopped by floods; and the gauge-weir, for the purpose of computing the quantity of water flowing over it, from a measurement of the difference of level between the crest of the weir and the surface of the still water above it. The word is also sometimes used, though perhaps not quite correctly, to denote a training-wall or other structure parallel with the general line of a river, for the purpose of remedying or preventing loops or sinuosities. A weir may—according to the purpose for which it is intended, to the nature of the materials at command, or to other circumstances—be formed either of stone, timber, or brush-wood, or a combination of any two. It is generally placed obliquely across the stream, in order to make the length of its crest considerably greater than the width of the channel (fig. 1), and thereby prevent the water in floods from rising to so great a height as it would do with a shorter crest, to the risk of damaging the adjoining low lands, and probably putting the mills above in backwater. 1a

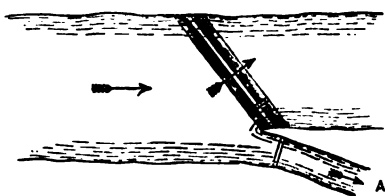

Fig. 1.  
A, intake.

makes the current to impinge against and to cut into the side of the river opposite the lower face of the weir, and to prevent that effect, weirs are sometimes made of the shape of two sides of a triangle, or rather of that of a hyperbola, with its apex pointing up stream, which arrangement is peculiarly applicable to the case of there being an intake for a mill on each side of the river (fig. 2), and the apex is a

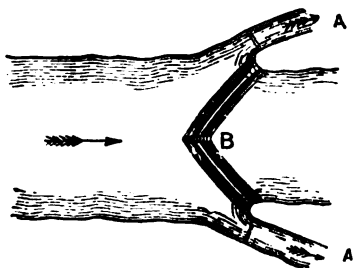

Fig. 2.  
A, A, intakes; B, fish-pass.

very suitable place for a fish-pass or ladder. Not unfrequently, when at a wide part of the river, the weir is placed at right angles across, and with a slight curve upwards (fig. 3); and a natural shelf of

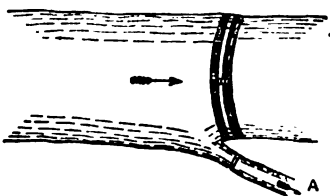

Fig. 3.  
A, intake.

rock is often very advantageously made use of for either a mill or fishing weir, the low parts being made up where necessary with stone or timber.

The down-stream face of a weir is generally a pretty flat slope of stone 'pitched' or set on edge, and with its toe, or lower edge, either sunk into rock, or protected from being underwashed by a row of timber-sheeting piles, and frequently also by an apron of timber-planking. This slope is either straight, or made with a hollow curve (fig. 4), so as to check the tendency of the water to acquire increasing velocity as it descends; and it is frequently divided into panels by timber-framing, so as, in the event of a portion of the pitching being

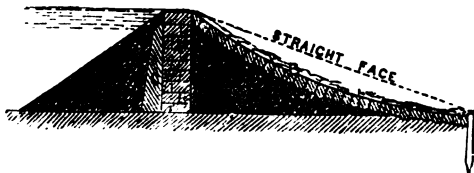

Fig. 4.  
A, masonry; B, pitching; C, clay puddle.

stone pitching, but it is sometimes a perpendicular wall. In order to render an ordinary sloping weir water-tight, sometimes there is under the crest or coping a row of well-jointed and close-driven timber sheeting-piles; but those being liable to decay, without their decay being visible, a better, though a more difficult and expensive arrangement, is to build a perpendicular wall of water-tight masonry under the crest. In either case, generally there is the additional precaution taken of having a wall of pounded clay on the up-stream side of the wooden or stone barrier; and sometimes a mere wall of pounded clay alone, in the centre of the weir, is trusted to, as the sole means of making it water-tight; but the latter is not a satisfactory arrangement, unless the stone-work next to the clay be so closely compacted by an admixture of gravel and sand as to prevent any current of water from reaching the clay, and cutting into it. The down-stream face is sometimes made a nearly perpendicular wall, which, unless for the obstacle which it presents to the ascent of the salmon, is a very good arrangement, where the bottom of the channel is solid rock, so as not to be liable to be scooped out by the falling water; else it must have at its foot a level apron of heavy masonry for the water to fall on (fig. 5).

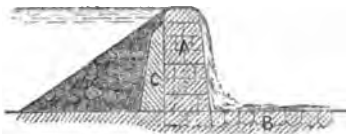

Fig. 5.  
A, masonry; B, pitching; C, clay puddle.

The down-stream face is also sometimes made of a series of steps, so forming a succession of levels and light falls (fig. 6), which is a very good plan for



Fig. 6.  
A, masonry; B, pitching; C, clay puddle.

breaking the force of the falling water; but it, like the perpendicular face, presents obstacles to the ascent of the salmon, unless a fish-pass or ladder be provided.

The weir for the purpose of navigation need not be in any way different from the mill-weir, otherwise than that, instead of an intake sluice, there

as the largest vessels navigating the river. Fishing-weirs are generally provided with a sort of cage,

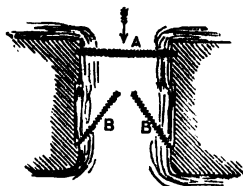

Fig. 7.

A, heck; B, B, inscales.

called in Scotland a cruiwe, a word which has been made English by having been used in English fishing-acts. The cruiwe consists of a chamber (fig. 7), generally about four or five feet in width, and as much or a little more in length, having at the upper end a portcullis grating, called the heck, with the bars vertical, and three inches apart, so as to let small fish get through, and at the lower end two folding horizontally sparred doors called the inscales, pointing upwards, but set so as to leave a small opening between the points, through which the ascending salmon enter. Partly from the inward pointing of the inscales, and partly from the instinct of the fish to ascend the river, they seldom get out again, and are easily caught. Frequently, weirs serve the purpose both of mill-dams and of fishing-weirs.

A weir sometimes made use of for catching salmon and other fish in tidal rivers, consists of a sort of horse-shoe shaped structure of loose stone-work, through which the water can percolate freely, with its heel or open end pointing up-stream. The fish ascend the river with the flood-tide, and falling back with the ebb, part get embayed within the walls at low water, and are either left dry, or are shut in so as to be easily caught.

Weirs, either of stone or of wicker work, are also sometimes made use of as an accessory to what in English fishing-rivers are called putts and putchers, being a sort of combination of wooden gratings acting something like those of the cruiwe and network; and in many cases, weirs, either natural, as formed by rocks or islands, or strictly artificial, are used for catching fish by means of an attached poke-net extended by the current.

By the English common law, no fishing mill-dam or fishing weir is legal except it be ancient, and even an ancient fishing-weir must have a free gap, and every fishing mill-dam must have a proper fish-pass.

The following are provisions as to weirs in the English Salmon Fishery Act, 1861: For the purpose of clearly indicating the rights of mill-owners, &c., in the first place, the expression 'dam' is defined to mean all weirs and other fixed obstructions used for damming up water; 'fishing weir,' a dam used for the exclusive purpose of facilitating the catching of fish; and 'fishing mill-dam,' a dam used partly for facilitating the catching of fish, and partly for supplying water for milling, &c. (24 and 25 Vict. c. 109, s. 4).

The following regulations are to be observed with respect to dams: No dam, except such fishing weirs and fishing mill-dams as were lawfully in use on the 6th August 1861, by grant, charter, or immemorial usage, must be used for facilitating the catching of salmon. Any proprietor of a fishery, with the consent of the Home Office, may attach to every dam which existed on the 6th of August 1861, such a fish-pass as the Home Office may approve, so that no injury be done to the milling power, or to the supply of water to or of any navigable river, canal, or other inland navigation. Every person who, in waters where salmon are

already constructed, must attach and maintain in an efficient state such a fish-pass as may be determined by the Home Office. By the Tweed Act, mill-dams, weirs, cauda, and other permanent obstructions are to be so constructed as to permit the free run of salmon in the ordinary state of the river. In Ireland, as in England, weirs are legal, if they can be traced back to statute 25 Edward III. Special Fishery Commissioners have power to inquire into legality of all fishing weirs, and every fishing weir must have a free gap.

By the old Scotch law, a provision as to mill-dams is given in the Act 1696, as follows: 'In respect that the salmon-fishing within the kingdom is much prejudiced by the height of mill-dams that are carried through the rivers where salmon are taken, His Majesty, with consent of the Estates of parliament, orders a constant slope in the mid-stream of each mill-dam dyke; and if the dyke be settled in several grains of the river, that there be a slope in each grain (except in such rivers where cruiwes are settled), and that the said slope be as big as conveniently can be allowed, providing always the said slope prejudice not the going of the mills situate upon any such rivers.' Cruiwes are by various old acts declared to be illegal in tidal waters, except the cruiwes and yairs of the Solway, which is exempted as being a Border river.

By the Scotch Fishery Act of 1862, the commissioners are empowered 'to make general regulations with respect to the construction and alterations of mill-dams, or lades, or water-wheels, so as to allow a reasonable means for the passage of salmon;' and they made a by-law, which has been sanctioned by the Home Secretary, providing that every dam should have a salmon pass or ladder, and also making provision for hecks at the intakes and lower ends of mill-lades, and immediately above the wheels, and regulations whereby the water, when not used for the mills, should be sent down the natural channel of the river. The commissioners are also required to make, and have made, general regulations as to the construction and use of cruiwes, which implies their legality, but only where there is a prescriptive right.

WELLINGTON, a town of New Zealand, the capital of a province of the same name, and now also the capital of the whole colony, the residence of the governor, and place of meeting of the 'General Assembly,' or colonial parliament. W. was the first settlement of the New Zealand Company, and was planted under the direction of Colonel Wakefield, with a band of pioneer colonists, in 1840. The town is beautifully situated on a bay of Port Nicholson, itself an inlet of Cook's Strait, on the southern coast of the North Island. The surrounding country is richly wooded, but the dense forests have begun to yield to the axe of the settler. The harbour is a fine expanse of water, six miles long and five broad, and has an excellent wharf, affording accommodation to ships of any tonnage, and considered one of the best in the Australian colonies. Since the removal of the seat of government hither, the town has made very rapid progress; it possesses a number of good public buildings; a handsome pile has recently been erected for the use of the House of Representatives and Legislative Council. The streets are generally spacious, and have good dwelling-houses. W. possesses a cathedral, together with fourteen other places of worship, in connection with the Episcopalians, Presbyterians, Methodists, Roman Catholics, and Jews. There are also several banks and numerous insurance agencies. Two papers are published daily, and one weekly. In

**WHITTINGTON, RICHARD.** As the existence of this remarkable man is by many supposed to be wholly mythical, it has been thought not out of place here to state briefly the few authentic facts of his life. W. was descended from a good Gloucestershire family, and was born probably about 1360, the younger son of Sir William Whittington, who possessed the estate of Pauntley in that county. His father died not long after W. was born, and Richard, who had no fortune, set out for London, to endeavour to make one by means of trade. That he left London on account of ill-usage, but was induced to return by his interpretation of the friendly sound of Bow Bells, and that he afterwards made his living through the instrumentality of a cat, are stories not improbable, but which cannot be well authenticated. He appears, however, to have apprenticed himself to a mercer, and to have rapidly risen in the world. It is not known at what date he set up for himself, but we find him a member of the Mercers' Company in 1392, in which year he was elected an alderman of the city, and in the following year was appointed sheriff. In 1398, W. was elected Lord Mayor of London; was again chosen to fill that office in 1406; was elected member of parliament for the city in 1416; and in 1419, for the third time, filled the office of Mayor. These statements accord with the popular story of W.'s having been 'thrice Lord Mayor of London,' although some antiquaries doubt if he filled that office oftener than twice. W., on account of various services rendered to Henry V., received from that sovereign the honour of knighthood. We are not informed of the date of W.'s marriage; but from various authentic sources we learn that his wife's name was Alice, daughter of Sir Hugh Fitzwarren. She appears to have died several years before her husband, and to have left no issue. W. died in the spring of 1423, aged about 63 years. There can be no doubt that W. was diligent and exceedingly prosperous in business, upright and liberal in character—'a virtuous and godly man, full of good works (and those famous)'—and in many respects considerably in advance of his time. His liberality appears to have been unbounded. At his death, he left the bulk of his property to be laid out in purposes of charity, and in completing those works which had been commenced under his own superintendence. For further details concerning the life of this remarkable man, we refer the reader to the Rev. Samuel Lysons's *Model Merchant of the Middle Ages* (Lond. 1860), an admirable and judicious biography of W.; also to various volumes of *Notes and Queries*.

**WILKINSON, SIR JOHN GARDNER,** a distinguished traveller and archaeologist, was the son of the late Rev. John Wilkinson, of Hardendale, in Westmoreland, and was born on the 5th of October 1797. Having lost both his parents at an early age, he was left under the guardianship of the Rev. Dr Yates, by whom he was sent to Harrow School in 1813, and to Exeter College, Oxford, three years later. While a boy, young W. had a strong desire to enter the navy, principally with a view to seeing foreign countries. He also in early life shewed a great fondness for architecture and sculpture. While at Harrow, he made sketches of all the churches within a radius of some miles from the school; and while at Oxford, often employed himself in drawing from the objects contained in the Arundel Collection. He still further cultivated his taste for architectural antiquities by trips on the continent made during

his travels. While in Italy, he became acquainted with Sir W. Gell, who, perceiving his taste for archaeological research, strongly urged him to make an extensive survey of the remains of Egyptian civilisation; and in October 1821, he set out for Alexandria, as a starting-point for his explorations. He took up his abode at Cairo, where he learned Arabic, both to read and speak; he also studied Coptic. Making Cairo his head-quarters, he now travelled through and investigated almost every part of Egypt and Lower Nubia. Twice he ascended the Nile as far as the Second Cataract, and several times as far as Thebes. At the latter famous site, he spent more than 12 months in making explorations; he also visited the deserts on either side of the river, and the Egyptian oases. During subsequent visits, he completed the exploration of those deserts, and, in fact, made a complete survey of Egypt, on a scale of about ten inches to a degree, which unfortunately, for the interests of science, has not yet been published. The same might have been the case with his *Survey of Thebes*, had not the author engraved and published it at his own expense. As a result of his first visit to Egypt, W. transmitted to the British Museum more than 300 antiquarian objects, besides numerous specimens of natural history. W.'s first residence in Egypt extended over a period of twelve years, during which time he composed and published his first two works on Egyptian subjects—viz., *Materia Hieroglyphica; containing the Egyptian Pantheon and the Succession of the Pharaohs, from the Earliest Times to the Conquest by Alexander, and other Hieroglyphical Subjects: with Plates and Notes explanatory of the same.* The preface to this work is dated 'Pyramids of Gezeh, July 1828;' but it was printed and revised for the author at Malta in the same year. This work was followed by *Extracts from several Hieroglyphical Subjects, found at Thebes and other parts of Egypt, with Remarks on the same*—also printed at Malta in 1830, but with a dedication to Sir W. Gell, dated 'Thebes, 1827.' In the same year (1830), he published his *Topographical Survey of Thebes, Tapt, Thaba, or Diospolis Magna*, in six sheets. In 1833, W., in consequence of ill health, was obliged to return to England. In 1835, he published *Topography of Thebes, and General View of Egypt* (Lond. John Murray). This was followed in 1837 by *Manners and Customs of the Ancient Egyptians, including their Private Life, Government, Laws, Arts, Manufactures, Religion, and Early History; derived from a Comparison of the Paintings, Sculptures, and Monuments still existing with the Accounts of Ancient Authors: illustrated by Drawings of those Subjects.* (3 vols. Lond. John Murray). This work at once obtained great popularity, both from the extent and soundness of its information, and the agreeable style in which it was written. It was highly spoken of by the critics; and obtained for him also the honour of knighthood, with which he was invested in 1839. Many things of importance were, however, omitted in it, which he afterwards published in *A Second Series of the Manners and Customs of the Ancient Egyptians, including their Religion, Agriculture, &c.* (2 vols. and a volume of plates, Lond. Murray, 1841). W. again visited Egypt in 1841 and in 1843. He also visited Syria, Constantinople, Tunis, and Sicily, returning to England after an absence of two years, by the Illyrian coast of the Adriatic. During his two years' absence, he also visited Dalmatia and Montenegro, which gave occasion to the publication of his *Dalmatia and Montenegro, with a Journey to Mostar, in Herzegovina, and*



*Remarks on the Slavonic Nations; the History of Dalmatia and Ragusa; the Uscocs, &c.* (2 vols., Lond. Murray). W.'s other works are—*Modern Egypt and Thebes; being a Description of Egypt, including the Information required for Travellers in that Country; with Wood-cuts and a Map* (2 vols., Lond. Murray, 1843); *Hand-book for Travellers in Egypt; new edition condensed of Modern Egypt and Thebes* (Lond. 1847, and again in 1858); *The Architecture of Ancient Egypt, with a Large Volume of Plates Illustrative of the Subject* (Lond. 1850); *The Fragments of the Hieratic Papyrus at Turin, containing the Names of Egyptian Kings, with the Hieratic Inscription at the Back* (Lond. 1851); *A Popular Account of the Ancient Egyptians, revised and abridged from his larger Work* (Lond. 1854); *The Egyptians in the Time of the Pharaohs; to which is added an Introduction to the Study of Egyptian Hieroglyphs*, by S. Birch (Lond. 1857), published as a companion to the Crystal Palace guides: *On Colour, and on the Necessity for a General Diffusion of Taste among all Classes; with Remarks on laying out Geometrical Gardens: illustrated by Coloured Plates* (Lond. 1858). W. also contributed notes to the Rev. G. Rawlinson's edition of *Herodotus*. In 1848, he paid a fourth visit to Egypt, and a fifth in 1855, when, as he was drawing at Thebes under excessive heat, he received a *coup de soleil*, which compelled him to return home. There W. occupied himself in examining ancient British remains in England and Wales. In 1874, he presented to the governors of Harrow School his collection of coins, about 1000 in number, having previously given to the same body his large collection of Egyptian, Greek, and other antiquities, for the purpose of founding a museum at the school. His death took place in 1875.

**WOMEN'S RIGHTS.** In 1851, an article in *The Westminster Review* attracted attention to the novel subject of the enfranchisement of women. Since that time, the agitation for women's rights has in this country, and to a still greater extent in America, attained the dimensions of a political movement. The subject has therefore become one of general interest. The following is an account of the claims included in women's rights, and a brief statement of the chief arguments by which those claims are supported.

1. *The Political Rights of Women.*—The discussion has hitherto turned upon the right to the suffrage. The right to vote is claimed in accordance with the principles of political reasoning that are held conclusive in the case of men. The argument applies with peculiar force to a democratic constitution. Democracy involves two ideas. It is a protest against privilege and against despotism; it maintains that every individual is born with an equal right to the protection and consideration of the law; and it affirms that every one must have a vote in order to secure this fundamental right. The practice of the United States shews a gradual approach to those principles. Till lately, the negroes were refused the benefit of them; but the privilege founded on colour has perished, and there remains now only the privilege founded on sex.

In England, the right to vote has been made to rest on the principles of English law. A petition of women to the House of Commons, presented on 7th June 1866, set forth, that the possession of property in this country carries with it the right to vote in the election of representatives in parliament. From the earliest times, the principle of the English constitution, and the spirit of the English people, have required that no man's property should be taken for the purposes of government without his consent. Since, therefore, the English law

permits women to hold and manage property, it seems anomalous and inconsistent that it should refuse them a vote to protect their property from inordinate taxation. Other persons allowed by the law to hold property, but excluded from the suffrage, are minors, idiots, lunatics, and criminals. But the principle of disqualification in those cases does not apply to women. Moreover, there is alleged to be historical evidence that women have voted both in counties and boroughs. The disuse of the privilege is traced to historical causes. Such was the violence of the time, that women were often unable to administer their property, and it was therefore natural that they should take little part in elections. Besides, the right to vote was at first regarded, not as a privilege, but as a burden; for the power of the Commons was low, and the expense of paying members of parliament was considerable. The disfranchisement of women is therefore held to be an anomaly in the constitution, as it was an accident in history.

The objections to female suffrage are various. In an argument in the *Times*, it is said: 'There exists, as it were, a tacit concordat guaranteeing to the weaker sex the protection and deference of the stronger, upon one condition only: that condition is the political dependence of women.' This asserts a claim on the part of men to make laws for women, in return for protection and deference. Now, protection to person and property every one has a right to who obeys the laws and contributes to the support of the government. The reason for refusing votes to women must lie deeper. It may be said that, inasmuch as women are weak and at the mercy of men, men abstain from abusing their superiority only on one condition; that condition is, that women shall have no legal rights except those that men are pleased to give them. In the last resort, the rights and privileges of any class of men depend on their might. The nobility established their privileges when they had power. The working-class has been admitted to the franchise because its power has increased. But women have no physical power to enforce their rights. If rights are to be measured by might, women will occupy the bottom of the scale. This is their position among savages. But, as civilisation has advanced, men have learned to renounce the advantage of their physical superiority, and freely to give women privileges that could not have been extorted. It would therefore seem that the rights women actually enjoy do not depend upon, and are not to be measured by, their physical strength. The rights of women flow from the prevailing sense of justice, and justice now means that the interests of women be consulted with as much impartiality as the interests of men. An unjust preference of either would be mischievous to both. Since, then, the interests of women should be fairly considered, what reason can there be to prevent them voting, and thereby intimating what views they take of their own interests?

Another objection to the enfranchisement of women is, that women have no business with politics, and that politics would withdraw them from their proper duties. Is this apprehension well founded? Granting that domestic life is the proper sphere of women, is it really impossible to unite an interest in politics with attention to a family? Upon this subject, we are not altogether without experience. In the great dissenting churches in Scotland, women, though excluded from office, vote equally with men in the appointment of ruling-elders, ministers, and in everything that is decided by a popular vote. But this privilege has not 'hardened' them, or made them 'unfeminine,' or interfered with their

household work. On the other hand, it has largely contributed to the success of the voluntary system, and to the strength of the church. The chimerical nature of the alarm felt on this subject has been illustrated by the objections that might be made against allowing clergymen to vote. 'We should be told that clergymen have no business with politics; that it was their province to attend to spiritual matters, and that they ought to confine themselves to their proper sphere; that if they were permitted to participate in political affairs, it would deteriorate from the sanctity of their character; that the passions roused by political contests were inconsistent with that spirit of meekness and holiness which we look for in preachers of the gospel.' Women are not wholly excluded from politics. In some countries, a woman may be sovereign; and history affords many examples of women that have had the highest capacity for government. Women in this country, if they have the same qualification as men, have parochial votes. And few would go so far as to propose that women should not only be shut out from public affairs, but also be kept ignorant of politics. Even if family-life be made their sole occupation, it surely is not to bound the horizon of their knowledge and sympathies.

The remaining objections may be taken together. They are of the same kind as those recently employed against the enfranchisement of the working-class. They are briefly: That the interests of women are not neglected, for they are represented by their male connections; that women are ignorant of politics; that they would be exposed to intimidation at home, and to violence at the polling-booths; and lastly, that women do not want votes. It is not allowed that women are sufficiently represented by their male connections. Such indirect influence is not considered, in other cases, to be a reason for withholding the suffrage. Rich men have a great indirect influence, but they have also votes. It is an old argument, that operatives were represented by their employers; but that argument never convinced the operatives, and it has now ceased to affect the legislature. Why, then, should a *vicarious* representation, which is repudiated by every class of men, be considered sufficient for women? On the contrary, if women had votes, their interests would be better attended to, because no member can disregard with impunity any important section of his constituents. It would be the policy of statesmen to devise and carry out measures for their benefit.

But, it is said, women are ignorant of politics. This objection has lost much of its weight, now that household suffrage has been established. Educated women are surely not behind many of the new voters in political knowledge. Still, women, in general, know less of politics than men. They are constantly told that politics form no part of their business, and their opinions, like those of non-electors, have little direct and palpable influence on affairs. Political knowledge generally follows political power. Women have not the stimulus that acts on men; they have not the knowledge that their opinions form part of the legislative power.

There is little reason to fear that the possession of a vote would expose women to coercion and improper influence. The law has already defied a more serious danger. It permits women, and by special arrangement, even married women, to hold property, and it trusts its ability to protect them from the importunities of relations. If women can defend their property from greedy relatives, they will be no less able to give independent votes. The objection that women would be exposed to violence at

the polling-booths, is not formidable. If such were the fact, it would be no argument against female suffrage; it would be an argument against polling-booths. Should the police, however, be unable to protect female voters, there is the easy resource of voting-papers, already in use in the elections in the English universities.

The last objection is, that women do not want votes. A large number petitioned the Commons in favour of extending the franchise to women that possessed a household qualification; those petitioners represent a very much larger number, who are kept back by the various social checks that prevent women taking part in political agitation. Nor can there be any doubt that a proposal that makes way with men simply on the ground of justice, will find still more favour with women, since their interest is ranged on the same side.

The claim of women to the suffrage is not without support from practical considerations. History teaches that women must have votes in order to protect their interests; men, through all the vicissitudes of history, have shewn a constant preference of their own interests. In the words of Lord Macaulay: 'If there be a word of truth in history, women have been always, and still are, over the greater part of the globe, humble companions, playthings, captives, menials, beasts of burden. Except in a few happy and highly civilised communities, they are strictly in a state of personal slavery. Even in those countries where they are best treated, the laws are generally unfavourable to them, with respect to almost all the points in which they are the most deeply interested.'

In this country, women suffer from serious grievances. They are excluded from the universities, and no provision is made to give them the high education that men value. In consequence of this, men enjoy almost a monopoly of educated labour. Most of the charitable endowments for education in England were destined by the founders for girls as well as boys; but they have been generally appropriated to boys. Christchurch Hospital was intended for boys and girls; it educates 1100 boys and 26 girls. Women also are excluded from the professions and the higher branches of industry. The situation of a governess is almost the only one open to educated women; from other occupations they are shut out, partly by rules, partly by neglected education.

The law is unfair to women, especially the law of marriage. Marriage is constituted by free consent, and is supposed to imply the approval of both parties. Now, it would be a hard bargain, where one of the parties was offered all the terms of it in the lump, and was therefore obliged to take everything or reject the whole; yet all the incidents of marriage, all the terms of the contract, are fixed by the law, and the law is made by men. In constituting the relation of marriage—a relation of even greater importance to women than to men—women have no voice, they have only a barren and impracticable veto. The result is familiar to every lawyer. By the law of England, the custody of a woman's children, after seven years of age, belongs exclusively to her husband; after they reach that age, she has no right even to see them. The common law strips a woman of her property, and leaves her fortune at the mercy of her husband; the husband also can seize his wife's earnings, unless she is protected by a judicial separation, or by an order from a magistrate. A married woman cannot enter into contracts. In practice, this bad law is avoided by settlements made before marriage; but this protection involves expense, and is in a great measure confined to the rich. More recent

legislation is as unfair as the older law. In 1857, the Divorce Court was established, and it was enacted that, for adultery on the part of a wife, the husband could obtain a divorce; but for the adultery of a husband, a wife was not allowed a divorce. In addition to adultery, the husband must be guilty of cruelty or desertion. This inequality goes to the root of the marriage-contract: it means that, in consideration of maintenance, a woman gives her person to her husband, and therefore, unless she is ill-used or abandoned, she gets in substance what she bargained for. The law is severe on offences against property; it is comparatively lenient in punishing brutal assaults by husbands on wives; garroters are flogged, but not wife-beaters. Finally, in the words of Lord Brougham: 'There must be a total reconstruction of the law, before women can have justice.'

**2. The Industrial Rights of Women.**—These embrace admissibility to all offices, occupations, and professions; also admission to the universities, or some adequate provision for the education of women so as to fit them for high posts. This raises the question of the proper sphere of women. The prevailing ideas point to marriage as the true, if not the sole end of a woman's existence; but this theory is inadequate to meet our social difficulties. Many women are unmarried. What is to be done with them? To hinder them from doing the best they can for themselves, would be a manifest injustice; therefore, in the interests of single women, all occupations should be open. But the claims on behalf of women do not stop there. It is denied that men have any right to exclude women from active life, and so drive them into marriage as their only livelihood. On grounds of justice, the right of women to enter into industry is conceived as almost too clear for argument.

The objections to the Industrial Rights of Women must be noticed briefly. It is said that the proper sphere of woman is domestic life, and that she is by nature unfit for the struggles of industry. It appears from the census that just one half of women above twenty years of age are confined to domestic life. About a third of the adult female population are either of independent means, or support themselves by non-domestic industry; the rest occupy a secondary position in the industrial world, by assisting their husbands in business. But though the number of women engaged in industry is great, they are confined to poorly paid occupations, and their labour is for the most part unskilled. Generally speaking, the women of the middle class take no part in industry. The real issue is therefore narrow. It is not, shall women be admitted to industry? for that is settled; but, shall skilled and educated female labour be allowed? There is no evidence that women have no capacity but for the meanest employments. What they are fit for, can be finally determined only by actual trial. All that the advocates of women's rights ask is, do not anticipate the result, or foreclose the experiment. Some think that while it is desirable women should not be left unoccupied, they should not be admitted to industrial occupations, but society should seek a field for unmarried women in some works of charity or religion, or in some semi-domestic pursuit. This proposal is an attempt to establish, in this country, that provision for unmarried women that is supplied by the monastic system in Roman Catholic countries. The objection to it is clear. If this semi-domestic pursuit is the most agreeable and lucrative to women, they will, of course, hail the discovery of it with gladness; but if it is not, they may decidedly object to make martyrs of themselves.

A common objection is, that to take women from domestic work would harden them, and destroy the peculiar traits of their character. Now, a great part of what used to be the work of the household has passed to another province, spinning, weaving, brewing, and baking were at one time domestic work. If women are to do their ancient customary work, they must follow it abroad. Those who believe that the peculiar attributes of women are an artificial product of civilisation, may feel alarmed at any disturbance of the present condition. But the genuine distinctions between the sexes flow from organisation, and will not be obliterated by similarity of education and employment; on the contrary, no feminine charm would be lost, but women would be more spirited, more intelligent, and fitter companions for men.

It is an argument sometimes relied upon, that an admission of women to industry would be prejudicial to men, because it would increase the supply of labour, and thereby lower the rate of wages. This objection is founded on the principle, that, when the wage-fund is constant, the rate of wages falls as the labourers are more numerous, and rises as they become less numerous. But the competition of women is, to some extent, an exception, for if they do not work for themselves, they must be supported out of the wages of men. If, however, wages were to fall below the ordinary standard of comfort, the tendency would be, by fewer births or emigration, to reduce the excess of labourers, till the supply of labour should be adjusted to the required standard of wages; and experience shews that wages are not permanently lowered by the admission of women to industry. In the working-class, wages adjust themselves to a scale enabling a working-man to maintain a wife and family.

In the last place, it is said that active life is inconsistent with the cares of maternity. This, of course, has no application to the large class of childless women; and there can be no necessity for prohibiting women from entering into industrial life, if their situation renders it impracticable. The incompatibility between active life and maternity may safely be left to look after itself. From the returns in the census, it appears that one out of eight married women are employed in non-domestic labour; but, since many of their occupations are not incompatible with household duties, and since many have no children to attend to, it seems probable that only among a small number of the working-class, the duties of maternity are sacrificed to out-door employment. It is, however, a moot-point how far maternity interposes a barrier to the industrial education and employment of women. In the working-class, the mother usually nurses her children, for she could seldom make a profit by engaging in another employment, and hiring a servant; but if women were employed in skilled and well-paid occupations, they would probably leave nursing, which at present is unskilled labour, to servants. The solution of the problem must, however, be left to trial and experience. One principle, at any rate, is clear; except in so far as women are occupied as mothers, they should be employed in the most remunerative work. That would be beneficial to men, for it would relieve them of a pecuniary burden; it would be beneficial to women, for it would make them independent.

The women of the middle class, led astray by a mistaken aspiration to aristocratic leisure, have held aloof from the struggles and rewards of industry. This operates injuriously in various ways. It creates an unnatural competition with working-women, as in needle-work. Middle-class women

often discharge duties that might well be left to upper servants. If they entered into commerce and trade, they would fit themselves for, and require, a higher kind of occupation than those thankfully accepted by poor and untaught women. At present, the higher walks of business, and even subordinate offices of trust and skill, are monopolised by men; hence women engaged in the lower employments derive little pecuniary benefit from trustworthiness, experience, or judgment, and have no hope of rising. If they should attempt to better their condition, they are left without encouragement or support. The exclusion of women of the middle class from industry is hurtful to themselves. It often leads to poverty of the bitterest kind—the poverty of gentlewomen. It leaves them without occupation, a prey to ennui and bad health. It also forbids perfect companionship and sympathy between the sexes. The whole scope of a man's education is towards industry. In it he lives, and moves, and has his being. But of this world, women have no direct knowledge. Hence a want of intellectual sympathy between men and women, and an absence of any common standard of reasoning and evidence. Nor is this all. The virtues upon which industrial and public life repose, do not derive due support from women. They are ignorant of the difficulties that beset moral problems under circumstances of which they have no experience, and their moral wisdom can hardly go beyond traditional saws. Indeed, their influence is sometimes on the wrong side. A man will be reluctant to injure his family in their pecuniary interests, for some point of conscience that his wife does not sympathise with, or for objects that she does not understand.

No account of women's rights would be complete without some notice of the claim to equality in marriage. This is the goal to which history points. 'Among tribes which are still in a primitive condition, women were and are the slaves of men for purposes of toil. All the hard bodily labour devolves on them. In a state somewhat more advanced, as in Asia, women were and are the slaves of men for purposes of sensuality. In Europe, there early succeeded a third and milder dominion, secured, not by blows, nor by locks and bars, but by sedulous inculcation on the mind; feelings also of kindness, and ideas of duty, such as a superior owes to inferiors under his protection, became more and more involved in the relation. But it did not for many ages become a relation of companionship, even between unequals.' That stage has now been attained, and, 'for the first time in the world, men and women are really companions.' Women cannot be good companions for men unless they are equals. If they are kept inferior in education and knowledge, their influence will tend to drag men down to their own level. The intercourse, moreover, that is of value is not intercourse between an active and a passive mind, but between two active minds. The theory of the subordination of women involves several bad consequences; for women being unable to attain their ends directly, have recourse to management and artifice.

The general movement of society is from subordination to equality. Under the feudal system, society was constituted on the principle of subordination. The land was tilled by serfs, and there were few but said that serfdom was the natural position of a creature so low as an agricultural labourer. But serfdom did not endure, and we have learned that it is happier for all parties that the land should be tilled by freemen. And now, too, negro slavery, the most plausible form of slavery, has been abolished. The tendency of social changes is towards equality, as the most satisfactory relation

between man and man; it also seems to point to equality as the highest relation between man and woman.

In the year 1869, an important step was taken towards the recognition of the claim for the concession of political franchises to women. In a bill passed in parliament respecting municipal elections, a clause was inserted extending the right of voting at such elections to women. Similarly, by the English and Scotch Education Acts of 1870 and 1872, women are permitted to vote at the elections of school boards.—The subject of women's rights is discussed in the following: *Dissertations and Discussions*, by J. S. Mill, vol. ii, 'Enfranchisement of Women'; *The Political and Social Dependence of Women*, 1867; *The Industrial and Social Position of Women*, 1857; Speech by J. S. Mill in House of Commons, May 21, 1867; *The Westminster Review*, Jan. 1867; Professor Cairnes in *Macmillan's Magazine*, Sept. 1874.

WORKSHOP REGULATION ACT, 1867 (30 and 31 Vict. c. 146), is an important act for regulating the education of children, and the hours of labour for children, young persons, and women who are employed in places not subject to the Factory Acts. Its application is wide, as the definition of a 'workshop' includes every place where any handicraft is carried on, 'and to which, and over which, the person by whom such child, young person, or woman is employed, has the right of access and control.' The principal provisions of the act as to the hours of labour are: (1) That no child under the age of eight shall be employed in any handicraft in any workshop; (2) that no child under thirteen shall be employed for more than six hours and a half each day, or before 6 A.M., or after 8 P.M.; (3) that no young person under eighteen, and no woman shall be employed more than 12 hours out of any period of 24 hours, or shall be employed between 9 P.M. and 5 A.M., and that the intervals for meals and rest shall not be less than an hour and a half in all; (4) that, except in retail establishments employing not more than five persons, no such child, young person, or woman shall be employed after two o'clock on Saturday, and that in no case shall they be employed on Sundays; and (5) that no child under eleven shall be employed in grinding in the metal trades or in fustian-cutting. From these general rules, the act itself makes a few exceptions, and a limited power is given to the Home Secretary to make others. The regulations as to education are: (1) That every child under thirteen, who is employed in a workshop, shall attend school for at least 10 hours in every week; and (2) that in computing the time at school, no time shall be included in excess of three hours at once, or of five hours in one day; or on Sundays; or before 8 A.M. or after 6 P.M. The obligation to carry out the regulations as to education, is laid (under penalties) both on the parent and on the employer; and the latter is authorised, on the application of the teacher, to pay him for the schooling a weekly sum out of the child's wages.

The act was amended in 1871 (c. 19), so as to make Jews who closed their workshops on Saturday, exempt from penalties should they work on Sundays. It was also amended in the same year (c. 104), so as to give the Home Secretary power to make exemptions from its strict operation in the case of trades which depend on the weather and seasons. The duty of enforcing the provisions of the Workshop Acts was placed on the inspectors of factories.

WORKSOP (anciently *Wirkesop*), a town of Nottinghamshire, England, 24 miles north from Nottingham, on the right bank of the Ryton, a

branch of the Idle, and near the Chesterfield Canal, which communicates with the Trent. It is situated near the northern extremity of Sherwood Forest. The town is generally well built, and great sanitary improvements of drainage and sewerage have recently been effected. There is a fine old church in the Norman style, with two lofty towers. W. was formerly noted for its Augustine monastery, of which, however, there are few remains. Malting is carried on here to a very great extent. Much barley is grown in the neighbourhood. There is

some trade in flour, timber, &c. W. is also a station on the Manchester, Sheffield, and Lincolnshire Railway. Pop. (1871) 10,409.

WUDWA'N, a town of India, in the peninsula of Kattywar, province of Guzerat, 105 miles west-by-north from Baroda. It is situated on a small river, which falls into the great salt marsh known as the Runn of Cutch. Pop. 32,220. The surrounding district is in a high state of cultivation, and is celebrated for the excellence of the cotton which it produces.

## X



ERES-DE-LA-FRONTERA, or JEREZ-DE-LA-FRONTERA, an important town of Spain, in the province of Cadiz, and 14 miles directly north-east-by-north from Cadiz, near the right bank of the Guadelete, and on the railway between Cadiz and Seville. The houses are generally well built, and the streets and squares clean, spacious, well paved, and well lighted. The wealthy wine-merchants mostly reside in the suburbs. X. is an ancient town supposed by many to be the *Asta Regia Casariana* of the Romans. X. has manufactures of woollen cloth and leather, and a considerable trade in corn; but all these are of little consequence in comparison with its wine-trade. *Sherry* derives its name from Xeres-de-la-Frontera.

Some of its *bodegas*, or wine-stores, are of vast dimensions. They are not wine-vaults, but stores erected above ground. The greater part of the wine of X. is exported to England; and some of the principal wine-merchants are of French and Scottish extraction. Pop. about 50,000.

XERES-DE-LOS-CABALLEROS, or JEREZ-DE-LOS-CABALLEROS (anc. *Esuris*), a town of Spain, in the province of Badajoz, and 40 miles south from Badajoz. X. is a picturesque old town, partly surrounded by a Moorish wall. The ecclesiastical edifices are remarkably numerous. There are manufactures of woollen and linen cloth. Amongst the chief articles of trade, besides the produce of the manufactures, are pigs and fruit. Pop. about 6000.

## Y



EADON, a town of the West Riding of Yorkshire, England, six miles north-north-east from Bradford. It stands on a hill, on the left side of the valley of the Aire. It has considerable woollen manufactures. Pop. (1871) 5246.

YORUBA, or YARRIBA, a country of Guinea, West Africa, lying to the east and north-east of Dahomey, in N. lat. 6°—9°, and E. long. 2°—6°. Its area is about 70,000 sq. m.; and the pop. is estimated at 2,500,000. Palm-oil, cotton, and ivory are the principal articles of export. Lagos (q. v. in SUPPLEMENT) is the port through which trade with foreign countries is chiefly carried on. There are numerous large towns in Y., but the people are little if at all less barbarous in their customs than their neighbours of Dahomey.

YO-SEMITE, YO-HAMITÉ, or AHWAHNE, a valley and waterfall of California, in the east of the state, about 57 miles from Coulterville, on a large feeder of the San Joaquin, and on the western side of the Sierra Nevada. The scenery of California is remarkable for its combination of loveliness

with sublimity; and in no part of the country yet explored are these characters so strikingly displayed as in the Y. valley—a valley of from 8 to 10 miles long, and a little more than a mile wide; in some places filled with noble oaks, in others opening out into broad grassy fields; with a river rushing through it about 40 yards in breadth; pine-covered mountains towering with very steep slopes to the height of 3500 feet; a precipice or 'bluff' in one place rising perpendicularly 3089 feet above the valley; in another, a rock almost perpendicular, 3270 feet high; waterfalls pouring over its sides from heights of 700 to almost 1000 feet; and one great waterfall, broken into three leaps, but of which the whole height is 2550 feet. Of the other waterfalls on the sides of the valley, the Pohono, or Bridal Veil Waterfall, is particularly to be remarked for its beauty, as well as for its height, which is 940 feet, and almost unbroken. The Y. Valley, first entered by white men in 1855, has begun to attract visitors since California has become peopled, and has already its hotels and guides, like the valleys of Switzerland and the Falls of Niagara.

## Z



**Z**ARSKOE-SE'LO, or SAINT SOPHIA, a town of Russia in the government of St Petersburg, and seventeen miles south from the city of St Petersburg, with which it is connected by a railway. It has a college and a military school. The palace of Z. is a summer residence of the emperor, founded by Peter the Great in 1710, and the favourite abode of Catherine II. The church of St Sophia is a miniature copy of the mosque of that name at Constantinople. Population in 1867, 6741.

**ZNAIM, or ZNAYM**, a town of the Austrian Empire, in Moravia, on a rising ground close to the left bank of the Taja, 48 miles north-by-west from Vienna. It is celebrated for the conflict which took place here between the French and Austrians, on June 14, 1809, in which the French were victorious (see WAGRAM). A castle on a height, the ancient residence of the princes of Moravia, is now a military hospital. Near it is a circular church, supposed to be as old as the 12th c. Pop. (1869) 10,600.

**ZO'ETROPE, or WHEEL OF LIFE**, an optical instrument, so named from its exhibiting pictures of objects as if endowed with life and activity. Although only of late years introduced from America, under this name, the instrument itself, which is simply a cylindrical thaumatrope, was invented and made the subject of a patent so long ago as the year 1860. Mr Peter Hubert Desvignes, the inventor, in his published specifications, has very fully described various modifications of the cylindrical thaumatrope; and the instruments which, under the name of Mimoscope, he contributed to the London Exhibition of 1862, being furnished with pictures of exquisite artistic finish and beauty, were deservedly rewarded with 'honourable mention.' Mr Desvignes also proposed a stereoscopic form of the instrument, in anticipation of the one already described under Stereoscope (q. v.), and has employed models, insects, and other objects, instead of pictures, with perfect success. The truly marvellous results shewn in this instrument depend, primarily, on the well-known fact, that vision 'persists' for a certain short interval of time after the occlusion of the visual ray. It follows from this principle, that, if

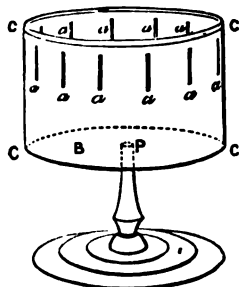

Fig. 1.

a series of pictures, representing the different attitudes successively assumed by an object in completing a given movement, be presented to the eye so quickly that the visual impression of each picture shall continue until the incidence of the one next following, the object will remain constantly in view, and its various parts will appear to execute the movement delineated by the

pictures. The mechanical means for effecting this result will be understood from fig. 1, which represents the zoetrope in its most popular, but by no means most excellent, form. C, a cylinder of strong card-board, 12 inches in diameter, and 7½ inches in depth, with a metal rim at the top, and fastened to a circular piece of wood, B. The latter is screwed at its centre to a pivot, P, which moves freely within the upright of the stand, S, and forms a vertical axis, round which the cylinder may be made to revolve with any desired rapidity; a, thirteen equidistant apertures, each ¼ inch in width, and 3 inches long. Each series of pictures is printed on a strip of thick paper, 3¼ inches in breadth, and 36 inches in length. In using the instrument, illuminate it well from above, and, having placed the picture-strip within the cylinder, immediately beneath the apertures, a, rotate the cylinder with the requisite velocity (which will vary according to the nature of the subject), and look through the apertures at the pictures upon the opposite side of the cylinder. To avoid the grotesqueness of a number of groups

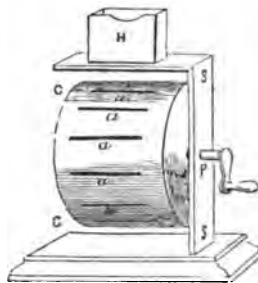

Fig. 2.

all seen performing the same movement at the same time, Mr Desvignes devised the thaumatrope, shewn in a somewhat modified form by fig. 2, in which the cylinder, C, turns upon a horizontal axis, P; and by means of an aperture at the bottom of the hood, H, the sight is limited to the space occupied by a single group on the opposite side of the cylinder, and, both eyes being brought into consentaneous activity, the clearness and pleasantness of the illusion are greatly enhanced. In this arrangement, the groups are arranged, on the strips, one above another, and not side by side, as in the former; and they are perforated with apertures to correspond with those on the cylinder. As has been pointed out by Mr Desvignes, the width of the apertures should never exceed one-sixteenth of an inch; and the exterior of the instrument should be painted mat black.

We will now speak of the principles which determine the character and distinctness of the illusion, and first of all, will endeavour to explain why it is that the pictures, looked at through the apertures, are plainly visible; whereas, viewed over the top of the revolving cylinder, they run into an indistinguishable mass.

The effect of the apertures, in this regard, is twofold; they limit the *time* during which each group is pictured upon the retina; and they limit, or should be made to limit, the *quantity* of each group at any one instant so depicted. Obviously, if the view be *instantaneous* only, the group in that minute interval of time will not have moved to a *perceptible* degree, and will therefore appear stationary. It is for this reason that the apertures should be made very narrow (not exceeding one-sixteenth of an inch, as above stated), and then, the eye being placed close to them, the retinal images will not be blurred — as with wider apertures, and consequent increased motion of the pictures while under view, they would

be—and the maximum of *definition* is thus attained. But, in this case, both the quantity of light reaching the eye, and the time of its operation, are insufficient, which defects can only be compensated by setting the instrument in violent motion, thus occasioning an inconveniently rapid recurrence of the retinal impressions. Instead, therefore, of letting the whole picture be seen for a *single* instant, let us increase the total time of visibility by arranging that successive small portions of the pictures shall be seen in *successive* instants. This is effected by withdrawing the eye a few inches from the aperture; for the eye being at the apex of the visual angle, the further it is removed from the aperture, the greater is the distance *within the visual angle* through which the aperture must travel; and prolonged in a like degree will be the *total time of visibility* for each picture. But here another difficulty is evoked, manifesting itself in one of the most puzzling phenomena of this curious instrument. The pictures are seen as *sensibly diminished in breadth*, the explanation of which is as follows: The longer the time of visibility, the greater will be the onward movement of the picture while under view; therefore, if the left-hand side of the picture come first into view, by the time the advance of the aperture permits of the right-hand side being seen, the latter will have progressed *towards* the left, and it will accordingly be seen relatively nearer to the left side than is its natural position. And this com-

pression, of course, takes effect over the whole of the picture. In the exquisitely elaborate drawings prepared by Mr Desvignes, this compression was allowed for, to the great enhancement of the effect.

Lastly, of the effects due to the pictures themselves. If the pictures on the strip be the same in number as the apertures, the pictures will either coincide with the apertures, in point of position, or will be equidistant, each from its adjacent aperture: in which case there will be no apparent shifting of the pictures either to right or left. But if there be 12 pictures and 13 apertures, the picture-interval will be greater than the aperture-interval, and only one picture on the strip can be coincident with an aperture; the rest will be situated in advance of the apertures, each succeeding one slightly more than its predecessor; and, as a consequence, seen through the apertures of the revolving cylinder, they will appear continuously to advance. The contrary will be the case, if the number of the pictures exceed that of the apertures. These curious properties, which make it possible to exhibit figures moving either backwards or forwards, as well as with movements proper to themselves, were fully investigated by the late Professor Faraday; and we would recommend those interested in the subject to refer to his *Memor on Optical Deceptions*, contained in his *Experimental Researches in Chemistry and Physics*, pp. 291, *et seq.*

# INDEX

## OF MATTERS NOT HAVING SPECIAL ARTICLES.

It has been thought unnecessary to repeat in the Index the titles of the 27,000 articles composing the body of the work. Any person consulting the Encyclopædia is supposed, in the first instance, to look for the subject he is in quest of in its proper alphabetical place. If it is not to be found there, by turning to the Index he is likely to get a reference to it under another name, or as coming in for notice in connection with some other subject. It frequently happens that subjects, having articles of their own, are further noticed under other heads; and where it seemed of importance, a reference is given in the Index to this additional information. The subjects treated in the Supplement, both principal and secondary, have also been incorporated in the Index, so as to prevent the necessity of further search.—The title of the article referred to is printed in *Italics*; and when the article is of considerable length, the page is given in which the information is to be found.

ABBREVIATIONS: *r.*, river; *l.*, lake; *Suppl.*, Supplement; *mt.*, mountain; *i.*, island; *c.*, cape.

- |  |  |   |  |
|--|--|---|--|
| <p>Aa, <i>Emu</i>.<br/>Aabenrade Fiord, <i>Slesvig</i>.<br/>Aachi, <i>As</i>.<br/>Aachen, <i>Aix-la-Chapelle</i>.<br/>Aahmes, <i>Egypt</i>, 789.<br/>Aar, <i>Nassau</i>.<br/>Aarau, <i>Aargau</i>.<br/>Aath, <i>Ath</i>.<br/>Aathlum, <i>Laaland</i>.<br/>Abade, <i>Nubia</i>.<br/>Abaca, <i>Plantain</i>.<br/>Abaco, <i>Bahamas</i>.<br/>Abai, <i>Abyssinia, Nile</i>.<br/>Aballo, <i>Avallon (Suppl.)</i>.<br/>Abana, <i>Barrada, Syria</i>.<br/>Abang, <i>Giama, British</i>.<br/>Abatambu, <i>Tembu</i>.<br/>Abbasides, <i>Abbas, Calif.</i><br/>Abbate, <i>Abbt.</i><br/>Abba Yared (<i>mt.</i>), <i>Africa</i>, 66.<br/>Abbeville, (<i>Suppl.</i>)<br/>Abbey Craig, <i>Clackmannansh.</i><br/>Abbiat-Grasso, (<i>Suppl.</i>)<br/>Abbot of Unreason, <i>Pools, Feast of</i>.<br/>Abbotsford Club, <i>Roxb. Club</i>.<br/>Abdallah, <i>Wahabis</i>, 40.<br/>Abd-el-aziz, <i>Spain</i>, 16.<br/>Abdelmoumen, <i>Almohades</i>.<br/>Abdera, <i>Adra (Suppl.)</i>.<br/>Abderrahman, <i>Ommiades</i>.<br/>Abd-ul-Aziz, <i>Ot. Emp.</i> 150.<br/>Abd-ul-Aziz, <i>Wahabis</i>, 39.<br/>Abd-ul-Hamid, <i>Ot. Emp.</i> 149.<br/>Abd-ul-Medjid, <i>Ot. Emp.</i> 150.<br/>Abdulmelek, <i>Ommiades</i>, 71.<br/>Abecedarian Hymns, <i>Acrostic</i>.<br/>Abel, <i>Algebra</i>.<br/>Abella, <i>Avilla (Suppl.)</i>.<br/>Abookuta, (<i>Suppl.</i>)<br/>Aberavon, (<i>Suppl.</i>)<br/>Aberbrothwick, <i>Arbroath</i>.<br/>Aberche (<i>r.</i>), <i>Tagus</i>.<br/>Aberconway, <i>Conway</i>.<br/>Abercorn, Lords of, <i>Hamilton Family</i>, 213.<br/>Aberdare, <i>Cardiff, Merthyr Tydfil</i>.<br/>Aberdeen, Earls of, <i>Gordon Family</i>, 9.<br/>Aberffraw, <i>Anglesey</i>.<br/>Abergavenny, (<i>Suppl.</i>)<br/>Aberpele, <i>Denbighsh.</i>.<br/>Aberhonddu, <i>Brecon</i>.<br/>Abertawy, <i>Swansea</i>.<br/>Abingdon (<i>l.</i>), <i>Galapagos Is.</i><br/>Abington, (<i>Suppl.</i>)<br/>Abjuration of the realm, <i>Sansuery</i>.<br/>Abolitionists, <i>Republican</i>.</p> | <p>Abomasus, <i>Ruminantia</i>.<br/>Abomey, <i>Dahomey</i>.<br/>Aboo Ariah, <i>Yemen</i>.<br/>Abortion, (<i>Suppl.</i>)<br/>About, E. F. V. (<i>Suppl.</i>)<br/>Aboyna, <i>Dec.</i><br/>Aboyne, Earls of, <i>Gordon Family</i>, 9.<br/>Abrona, <i>Bytmeriacae</i>.<br/>Abseon, <i>Aze</i>.<br/>Abeinthe, <i>Liquor</i>.<br/>Abstraction, <i>Generalization</i>.<br/>Abu, <i>Elephantind.</i><br/>Abu (<i>mt.</i>), <i>India</i>, 537, (<i>Suppl.</i>)<br/>Abubekr-ibn-Tofail, <i>Arabian Lang. &amp; Lit.</i> 348.<br/>Abu-Hannes, <i>Ibis</i>.<br/>Abu-Jafar, <i>Calif.</i><br/>Abul-Abbas, <i>Calif.</i><br/>Abul-Abu, <i>Arab. Lang. &amp; Lit.</i> 348.<br/>Abul-Aswad-al-Duli, <i>Arab. Lang. &amp; Lit.</i> 349.<br/>Abu'l-Faraj, <i>Anthology</i>, 289.<br/>Abul-Hasan-Ali, <i>Arab. Lang. &amp; Lit.</i> 348.<br/>Abul-Kasem, <i>Arab. Lang. &amp; Lit.</i> 347, <i>Distillation</i>.<br/>Abuna, <i>Abyssinia</i>.<br/>Abuquerque, U.S., (<i>Suppl.</i>)<br/>Abury, <i>Avebury</i>.<br/>Abu Saïd, <i>Karmathians</i>.<br/>Abu Tahir, <i>Karmathians, Perrian Lang. &amp; Lit.</i> 408.<br/>Abyla, <i>Ceuta</i>.<br/>Abyssinia, <i>Theodor (Suppl.)</i>.<br/>Acacia, false or thorn, <i>Robinia</i>.<br/>Acacia formosa, <i>Sabice</i>.<br/>Acacia, German, <i>Sloe</i>.<br/>Academy, <i>Royal, Painting</i>, 195.<br/>Acadia, <i>Annapolis</i>.<br/>Acanthopia, <i>Adler, Viperida</i>.<br/>Acanthosoma, <i>Bug</i>.<br/>Acarus folliculorum, (<i>Suppl.</i>)<br/>Acayucan, (<i>Suppl.</i>)<br/>Accent (in verse) <i>Rhythm</i>.<br/>Acceptor, <i>Bill of Ex.</i> 93.<br/>Accipenser, <i>Sturgeon</i>.<br/>Accipiter, <i>Sparrow-hawk</i>.<br/>Accommodation bill, <i>Bill of Exchange</i>, 95.<br/>Accrington, (<i>Suppl.</i>)<br/>Acephalocyst, <i>Hydatid</i>.<br/>Acerina, <i>Ruffe</i>.<br/>Aceris, (<i>Suppl.</i>)<br/>Aceral, (<i>Suppl.</i>)<br/>Acetification, (<i>Suppl.</i>)<br/>Acetone, <i>Synthesis</i>.<br/>Acetum cantharidis, <i>Vesicants</i>.<br/>Acetyl, (<i>Suppl.</i>)</p> | <p>Ach, <i>As</i>.<br/>Achaean League, <i>Achaia</i>.<br/>Achalgañj, (<i>Suppl.</i>)<br/>Acheen, <i>Atcheen, Sumatra</i>.<br/>Acheron, <i>Albania</i>.<br/>Acherusia (<i>l.</i>), <i>Cocytus</i>.<br/>Acherusia Falus, <i>Fusaro (Suppl.)</i>.<br/>Acheus, <i>Sleth</i>.<br/>Achievement, <i>Hatchment</i>.<br/>Achinuind Castle, <i>Lismore</i>.<br/>Achlamydeous, <i>Apetalous, Flower</i>.<br/>Achlya, <i>Alga</i>.<br/>Achmet I., II., III. <i>Ot. Emp.</i> 148, 149.<br/>Achmet (vizier), <i>Ot. Em.</i> 149.<br/>Achores, (<i>Suppl.</i>)<br/>Achorion, <i>Parasitic Diseases</i>.<br/>Achradina, <i>Syracuse</i>.<br/>Achray (<i>l.</i>), <i>Kabrine (l.)</i>.<br/>Acid, <i>Chemistry (Suppl. 462)</i>.<br/>Acid tartrate, <i>Tartaric Acid</i>.<br/>Acidulated drops, <i>Tartaric Acid</i>, 304.<br/>Acidulous waters, <i>Carbonated Waters</i>.<br/>Acne, <i>Whell (Suppl.)</i>.<br/>Acne rosacea, <i>Rosacea</i>.<br/>Aconagua, <i>Andes</i>, 239.<br/>Aconagua, <i>San Felipe de Aconagua</i>.<br/>Acoono Coono, <i>Calabar</i>.<br/>Acquaviva, (<i>Suppl.</i>)<br/>Acquia, <i>Potomac</i>.<br/>Acra, <i>Jerusalem</i>.<br/>Acra, <i>Palazzo (Suppl.)</i>.<br/>Acri, (<i>Suppl.</i>)<br/>Acrita, <i>Zoology</i>, 359.<br/>Acritochromacy, (<i>Suppl.</i>)<br/>Acroceramian promontory, <i>Albania</i>.<br/>Acrolein, (<i>Suppl.</i>)<br/>Acromion, <i>Scapula</i>.<br/>Actinis, <i>Anemone, Sea</i>.<br/>Actinocrinites, <i>Silurian Rocks</i>.<br/>Actinophrya, <i>Rhipisoda</i>.<br/>Actitis, <i>Sandpiper</i>.<br/>Acupressure, (<i>Suppl.</i>)<br/>Acuyori wood, <i>Teca (Suppl.)</i>.<br/>Ada, (<i>Suppl.</i>)<br/>Adafudia, (<i>Suppl.</i>)<br/>Adamantine spar, <i>Corundum</i>.<br/>Adam of the Hale, <i>Opera</i>.<br/>Adamnan, St., (<i>Suppl.</i>)<br/>Adampore, <i>Allahabad</i>.<br/>Adams (<i>mt.</i>), <i>Washington (ter.)</i>.<br/>Adams (<i>mt.</i>), <i>White Mt.</i>.<br/>Adanara (<i>l.</i>), <i>Solor Is., Timor</i>.<br/>Adasi, <i>Black Sea</i>.</p> | <p>Addax, <i>Antelope</i>.<br/>Adder, <i>Viper</i>.<br/>Adder (<i>r.</i>), <i>Tweed</i>.<br/>Adder's tongue, <i>Ophioglossa</i>.<br/>Addison's disease, <i>Supra-renal Capsules</i>.<br/>Addressed, <i>Indorsed</i>.<br/>Address, forms of, <i>Forms of Address</i>.<br/>Adelaide (<i>r.</i>), <i>S. Australia</i>.<br/>Adenanthera, <i>Red Wood, Sandal-wood</i>.<br/>Adentia, (<i>Suppl.</i>)<br/>Adenocoele, (<i>Suppl.</i>)<br/>Aderbajan, <i>Azerbaijan</i>.<br/>Aderno, (<i>Suppl.</i>)<br/>Adhesiveness, <i>Pharmacology</i>, 514.<br/>Adi, <i>Navarra</i>.<br/>Adiabene, <i>Assyria</i>.<br/>Adighé, <i>Circassians</i>.<br/>Adipic acid, (<i>Suppl.</i>)<br/>Adipose fin, <i>Salmonida</i>.<br/>Adityas, <i>Varnas</i>.<br/>Adjudications, Register of, <i>Registration of Deeds and Writs</i>.<br/>Adjutage, <i>Hydrodynamics</i>, 484.<br/>Adjyghur, (<i>Suppl.</i>)<br/>Admiral, <i>War Serv.</i> (<i>Suppl.</i>)<br/>Admiralty, <i>Board of Admirals</i>.<br/>Adossé, <i>Abissin</i>.<br/>Adowa, <i>Abyssinia, (Suppl.)</i><br/>Adoxa, <i>Aralia</i>.<br/>Adpar, <i>Cardiganshire</i>.<br/>Adra, (<i>Suppl.</i>)<br/>Adranum, <i>Aderno (Suppl.)</i>.<br/>Adranum, battle of, <i>Timoleon</i>.<br/>Adrogation, <i>Adoption</i>.<br/>Adullamites, (<i>Suppl.</i>)<br/>Adulteration of food, <i>Food and Drink</i>, 408.<br/>Adur (<i>r.</i>), <i>Suzes</i>.<br/>Adventure, <i>Joint Trade</i>.<br/>Ædesius, <i>Asium</i>.<br/>Æetes, <i>Argonauts</i>.<br/>Ægida, <i>Capo d'Istria</i>.<br/>Ægilops, <i>Wheat</i>, 156, 157.<br/>Ælia Capitolina, <i>Ferus</i>, 714.<br/>Æmilian Provinces, <i>Emilian Provinces</i>.<br/>Ænaria, <i>Ickia</i>.<br/>Ængermund, <i>Angermannland</i>.<br/>Ænoce, <i>Ægina</i>.<br/>Æoliople, <i>Steam-engine</i>, 99.<br/>Æolus (<i>l.</i>), <i>Ulysses</i>.<br/>Æqui, <i>Volci</i>.<br/>Ærolites, <i>Aero-siderites, Meteoris (Suppl.)</i>.<br/>Ærogo nobilis, <i>Acacemite</i>.</p> |
|--|--|---|--|



Ethelung, Anglo-Saxons, 261.  
 Aëtius, *Attila, Rome*, 321.  
*Valentinianus*.  
 Affective faculties, *Phrenology*, 513.  
 Affinity, *Consanguinity* (Supp.)  
 Affricque, St. (Supp.)  
 Affronté, *Abaisse*.  
 Afium-Kara-Hissar, (Supp.)  
 African hair, *Chamarapt*.  
 African Society, the, *Africa*, 66.  
 After-birth, *Piacenta*.  
 After-glow, *Twilight*.  
 Agalactia, (Supp.)  
 Agalochium, *Aloe Wood*.  
 Aga Mohammed, *Persia*, 423.  
 Agaric, Fly, *Amanita*.  
 Agaricon, *Amadou*.  
 Agasias, *Scythians*, 577.  
 Agata de Goto, *Sta.* (Supp.)  
 Agave vivipara, *Razor-strop*.  
 Agbatana, *Echatana*.  
 Age, Golden, Silver, &c. *Ages*.  
 Agealdas, *Sculpture*, 577.  
 Age of Bronze, Iron, &c. *Bronze* (Age of).  
 Age of Reason, *Paine*.  
 Aggerhus, *Christiania*.  
 Agglutinative languages, *Philology*, 481-484.  
 Aghmet, (Supp.)  
 Agha wood, *Aloe Wood*.  
 Agincourt, *Asincourt*.  
 Aglabites, *Barbary*.  
 Aglar, *Agnieja*.  
 Agnew, Sir And. *Sabbath*, 403.  
 Agnomem, *Name*.  
 Agnone, (Supp.)  
 Agosta, (Supp.)  
 Agows, *Abyssinia, Africa*, 69.  
 Agri, *Basilicata*.  
 Agricultural gangs, *Gangs* (Supp.)  
 Agriculture, Board of, *Agricultural Societies*.  
 Agridagh, *Anatolia*, 226.  
 Agri Decumates, *Alemanni*.  
 Agrostis, *Bent Grass*.  
 Aguan, *Honduras*.  
 Aguara dogs, *Dusicyon*.  
 Aguara fox, *Cercocyon*.  
 Aguare, *Carlos, San* (Supp.)  
 Ague-cake, *Splen*.  
 Aguilar de la Frontera, (Supp.)  
 Agur, (Supp.)  
 Aharun, *Arabian Lang. & Lit.* 348.  
 Ahmednuggur, (Supp.)  
 Ahmedpur, (Supp.)  
 Ahuramazda, *Zoroaster*, 360, 361.  
 Ahwahné, *Yo-Semite* (Supp.)  
 Ai, *Slith*.  
 Aichstadt, *Eichstadt*.  
 Aidan, *Scotland*, 555.  
 Aidan, *St.* (Supp.)  
 Aidone, (Supp.)  
 Aiguebellette (L), *Savoy*.  
 Aiguillon, Bay of, *Vendée, L.*  
 Aiguissé, *Abaisse*.  
 Aigun, *Sakhalin*.  
 Aile, *Dartmoor*.  
 Ailurus fulgens, *Panda*.  
 Aime, *Dartmoor*.  
 Ain-eh-Shems, *Bethshemesh*.  
 Ain-Tab, (Supp.)  
 Aiou, *Cook Is.* [723].  
 Air, *Sanitary Science* (Supp.)  
 Air-cells, *Respiration*, 208.  
 Aird, *Ar.*  
 Aire (r.), *Yorkshire*.  
 Aire-sur-l'Adour, (Supp.)  
 Aire-sur-le-Lys, (Supp.)  
 Air martyrs, *Pillar Saints*.  
 Aitoo, *Casuarina*.  
 Aix. *Aa*.  
 Aixanes, *Azum*.  
 Aizoon, *Tetragoniaceae*.  
 Ajuga, *Buple*.  
 Ajuroca, (Supp.)  
 Akabah, Gulf of, *Edom, Red Sea*.  
 Akális, *Sikhs*.  
 Akals, *Druzes*.

Amatebele tribe, *Zambesi, Zulu.*  
 Amativeness, *Phrenology, 514.*  
 Amatrice, (*Suppl.*)  
 Amazon stone, *Felspar.*  
 Amazulu, *Zulu.*  
 Ambaree hemp, *Hibiscus.*  
 Ambato, (*Suppl.*)  
 Amber (f.), (*Suppl.*)  
 Amberbackin (mts.), *Papua, 250.*  
 Ambernoon, *Papua, 250.*  
 Ambert, *Puy-de-Dome.*  
 Ambiguous middle, *Fallacy.*  
 Amblycephalus, *Hop Froth-Fly (Suppl.)*  
 Ambo, *Pulpit.*  
 Amboyna wood, *Kiaboucca.*  
 Ambracia, *Arta.*  
 Ambrefin, *Ambergria.*  
 Ambrette, *Hibiscus.*  
 Ambulance corps, *War Services (Suppl.)*  
 Ameland, *Zuider Zee.*  
 Amelia, (*Suppl.*)  
 Amenemha I., *Egypt, 789.*  
 Amenophis, *Egypt, 790.*  
 Amen Ra, *Egypt, 787.*  
 Ament, *Amenites.*  
 Amental Alliance, *Amentacea.*  
 America, *Amelia (Suppl.)*  
 American aloe, *Agave.*  
 American blight, *Aphis.*  
 Ameshaspentas, *Zoroaster, 361.*  
 Amhara, *Abyssinia.*  
 Amherst (i.), *Magdalen Is.*  
 Amherst province, *Tenasserim.*  
 Amia, *Mud-fish (Suppl.)*  
 Amice, *Vestments.*  
 Amida, *Diarrhoe.*  
 Amides, (*Suppl.*)  
 Amiens cathedral, *Gothic Architecture, 26.*  
 Amines, *Organic Bases.*  
 Amiot, *Amyot.*  
 Amiternum, *Aquila.*  
 Amlwch, (*Suppl.*)  
 Ammania vesicatoria, *Lith-raceae.*  
 Ammer, *Bavaria.*  
 Ammonis, *Cornua, Ammonites.*  
 Ammonium, *Ammonia.*  
 Ammonoosuck (r.), *White Mountains.*  
 Amoeba, *Rhizopoda.*  
 Amol, (*Suppl.*)  
 Amorgos, *Groeca, 85.*  
 Ampanam, *Lombok.*  
 Ampelides, *Vitacea.*  
 Amphiarus, *Ornuc.*  
 Amphipneusta, *Respiration, 207, note.*  
 Amphibiaeidae, *Serpents, 626.*  
 Amphiuma, (*Suppl.*)  
 Amplexical, *Leaves.*  
 Amrawati, *Oomrawuttie (Suppl.)*  
 Amrita, *Ambrosia.*  
 Amru, *Omar.*  
 Amstelland, *Amsterdam.*  
 Amu, *Amu-Daria (r.), Oxus.*  
 Amun-Ra, *Ammon.*  
 Amur, *Amoor, Manchuria.*  
 Amurath I., II., III., IV., *Ottoman Emp. 148.*  
 Amurnath, (*Suppl.*)  
 Amygdalin, (*Suppl.*)  
 Amyl, (*Suppl.*)  
 Anabrace, *Arabgir (Suppl.)*  
 Anacanthus, *Malacopterygia.*  
 Anacharis Cloots, *Cloots.*  
 Anacletus, *Pope, Roger II.*  
 Anaconda, *Boa, Python.*  
 Anacostia (r.), *Washington City.*  
 Anadir, *Gulf of, Siberia, 702.*  
 Anadoli, *Anatolia.*  
 Anaesthetics, *Methylene (Suppl.)*  
 Anagni, (*Suppl.*)  
 Anaïma, *Zoology, 357.*  
 Analatti, *Coleocon.*  
 Analache, *Andes, 239.*  
 Analytical Chemistry, *Analysis (in Chem.).*  
 Analytical machine, *Calculating Machine.*  
 Anasae, *Droptz.*  
 Anastase, *Titanium.*  
 Anatiside, *Anas.*  
 Ancaste, (*Suppl.*)  
 Ancenia, *Loire-inférieure.*  
 Ancisies, *Encaes.*  
 Ancholme (r.), *Lincolnshire.*  
 Anclam, *Anklam (Suppl.)*  
 Ancylus, *Limnaea.*  
 Andalgala, *Fuente de Andalgala (Suppl.)*  
 Andegavum, *Angera.*  
 Andenne, (*Suppl.*)  
 Andерб., (*Suppl.*)  
 Andersonian University, *Anderson, John.*  
 Andes (mts.), *Queensland.*  
 Andkhuy, (*Suppl.*)  
 Andöe, *Lofoden.*  
 Andran, *Engraving, 69.*  
 Andre, *Loire.*  
 Andrea Pisano, *Sculpture, 577.*  
 Andreianowky Islands, *Alexian Islands.*  
 Andrews, *St. America, 196.*  
 Andria, (*Suppl.*)  
 Androcides, *Painting, 191.*  
 Andromachus, *Med., Hist. of.*  
 Andromeda arborea, *Sorrel Tree.*  
 Andros, (*Suppl.*)  
 Andros, *Bahamas.*  
 Androscoggin (r.), *Maine.*  
 Androsphinx, *Sphinx.*  
 Andujar, *Suppl.*  
 Aneorhiza Capensis, *Umbellifera.*  
 Aneurin, *Welsh Lang. & Lit. 135.*  
 Anezo, *Navarre.*  
 Anfora, *Amphora.*  
 Angara (r.), *Yenisei, Baikal.*  
 Angaziya, *Comoro Isles.*  
 Angioloecitis, *Adenitis (Suppl.)*  
 Angiology, *Anatomy, 227.*  
 Angelica Salutiata, *Ave Maria.*  
 Angelim, *Partridge-wood.*  
 Angeln, *Angles.*  
 Angels, *Bishop, 117.*  
 Anghiari, (*Suppl.*)  
 Angina pectoris, *Heart, Diseases of.*  
 Angle, *Trisection of, Quadrature of the Circle.*  
 Anglican Church, *Anglo-Catholic Church.*  
 Anglin, *Indre.*  
 Angornow, (*Suppl.*)  
 Angoumois, *France, 469.*  
 Angra Pequena, *Namaqualand.*  
 Angr, (*Suppl.*)  
 Angrivarii, *Saxons.*  
 Angus, earls of, *Stewart Family, 141.*  
 Angustura bark, *Angustura Bark.*  
 Anhulvarra, *Rajpoots.*  
 Anhulvar, *Puttus (Suppl.)*  
 Anhydrides, (*Suppl.*)  
 Ani, *Crotophaga.*  
 Aniene (r.), *Tiber.*  
 Anil, *Indigo.*  
 Aniline, *Phenyl (Suppl.)*  
 Aniline green, *Dye-stuffs.*  
 Aniline purple, *Dye-stuffs.*  
 Animal Kingdom, *Animal.*  
 Animé, *Incensed.*  
 Anio (r.), *Tiber.*  
 Anion, *Anode.*  
 Anis (mt.), *Puy, Le.*  
 Aniseed cordial, *Liqueur.*  
 Aniva Bay, *Sakhalin.*  
 Anjana, *Marut.*  
 Anjouan, *Comoro Isles.*  
 Anklam, (*Suppl.*)  
 Annaberg, (*Suppl.*)  
 Annalee (r.), *Cavan.*  
 Annandale and Man, lords of, *Stewart Family, 123.*  
 Annat, *Ana.*  
 Annatom, *New Hebrides.*  
 Annatto, *Arnatto.*  
 Anney, *Savoy, (Suppl.)*  
 Annonacium, *Annonium, Annona (Suppl.)*  
 Annos, *Egypt, 789.*  
 Annotta, *Arnatto.*  
 Annuities, *Post-office Insurance (Suppl.)*  
 Annulata, *Worms, 279.*  
 Annuloida, *Radiata.*  
 Annulosa, *Worms, 278.*  
 Anomaly, *Analogy.*  
 Anona palustris, *Razor-strop.*  
 Anoplura, *Parasita (Suppl.)*  
 Ansari, *Persian Lang. & Lit. 427.*  
 Ansbach, *Anspach (Suppl.)*  
 Ansharius, *Ansparg.*  
 Anspach, (*Suppl.*)  
 Anstruther, *Fife-shire.*  
 Anta, *Egypt, 787.*  
 Antacids, (*Suppl.*)  
 Antakieh, *Antioch.*  
 Antalo, *Abyssinia.*  
 Antanaranga Pass, *Andes, 238.*  
 Anthea Cereus, *Aumone, Sea, 250, 251.*  
 Anthelmintics, *Vermifuges.*  
 Antheraea, *Silk and Silkworm, 724.*  
 Antherosoids, *Phytosoa.*  
 Anthochæra, *Wattle-Bird.*  
 Anthocyan, *Blue.*  
 Antholites, *Trigonocarpon.*  
 Anthomyia, *Cabbage Fly, Turnip Fly.*  
 Anthonomus, *Weevil.*  
 Anthriscus, *Chervil.*  
 Anthropopathism, *Anthropomorphism.*  
 Antiburghers, *U. P. Church, 645.*  
 Anticara, *Antequera.*  
 Antidorca, *Springbok.*  
 Anti-federalists, *Republican, U.S. 655.*  
 Antilia, *Tortona.*  
 Antiochia ad Sarum, *Adana.*  
 Antiochia ad Taurum, *Ain-Tab (Suppl.)*  
 Antipater, *Stoics, 137.*  
 Antipolis, *Antibes.*  
 Anti-renters, *Republican.*  
 Antisana, *Andes, 239, 240.*  
 Antiscorbatic beer, *Spruce, Essence of.*  
 Antispasmodics, *Spasm.*  
 Antjar, *Upas.*  
 Antlers, *Ruminantia.*  
 Anton (r.), *Hampshire.*  
 Antongil Bay, *Bemabatooka.*  
 Antonia, *Jerusalem.*  
 Antony (mt.), *New York.*  
 Antony of Padua, *Antonius, St.*  
 Antony of Thebes, *Antony, St.*  
 Antrostomus, *Whip-poor-Will.*  
 Ant-thrush, *Ant-catcher.*  
 Antua, *Aveiro (Suppl.)*  
 Antuco, *Andes, 239, 240.*  
 Antunnacum, *Andernach.*  
 Auuka, *Egypt, 787.*  
 Anunghoy, *Bocca Tigris.*  
 Anupahuhur, (*Suppl.*)  
 Anus, and its diseases, (*Suppl.*)  
 Anus, *Rectum.*  
 Anvers, *Antwerp.*  
 Anwoth, *Vitrified Forts.*  
 Aonlaganj, (*Suppl.*)  
 Aoudad, *Sheep, 662.*  
 Aounlah, *Aonlaganj (Suppl.)*  
 Apa, *Paraguay River.*  
 Apatoen pedestris, *Archegosaurus.*  
 Apathin, (*Suppl.*)  
 Apeiba, *Tiliacea.*  
 Apeldorn, (*Suppl.*)  
 Aperiaemic, *Albumen.*  
 Apes, *Nest-building Apes (Suppl.)*  
 Aphante, *Trap.*  
 Aphasia, (*Suppl.*)  
 Aphelandra, *Acanthus.*  
 Aphemia, *Aphasia (Suppl.)*  
 Aphis-lions, *Golden-eye Fly.*  
 Aphonia, (*Suppl.*)  
 Aphrodisia, *Aphrodite.*  
 Aphrodite, *Sea Mouse.*  
 Aplysia, *Tectibranchiata.*  
 Apolda, (*Suppl.*)  
 Apollinapolis Magna, *Edfou.*  
 Apollonia, *Cyrenaica.*  
 Aponeurotic membranes, *Skeleton, 750.*  
 A-posteriori, *A-priori.*  
 Apostolists, *Anabaptists, 219.*  
 Apparent distance, *place, Vision, 821.*  
 Appellants, *Unigenitus, Bull.*  
 Appendix vermiformis, *Alimentary Canal.*  
 Appin, *Argyleshire.*  
 Apple (mts.), *Irakhs.*  
 Applescore Sound, *Rassay.*  
 Apples, oil of, *Valerianic Acid.*  
 Appomattox (r.), *James River, Virginia.*  
 Appreciation, *Appraisers.*  
 Apries, *Egypt, 791.*  
 Apt, *Vaucluse.*  
 Aptenodytes, *Penguin.*  
 Apuleius, *Apuleius.*  
 Apulum, *Carlsburg.*  
 Apurimac, *Peru, 437.*  
 Aquæ Gratiarum, *Aix.*  
 Aquæ Pannoniæ, *Baden-Baden.*  
 Aquæ Sextiæ, *Aix.*  
 Aqua Ferenatina, *Marino (Suppl.)*  
 Aqua-Sextiæ, *battle of, Rome, 318.*  
 Aqueduct, *right of, Servitude.*  
 Aquilina, *Brake.*  
 Aquilonia, *Agnone (Suppl.)*  
 Aquis Granum, *Aix-la-Chapelle.*  
 Arabah, *Syria, Red Sea.*  
 Arabgir, or Arabirk, (*Suppl.*)  
 Arabian tea, *Catha (Suppl.)*  
 Arachthus, *Arta.*  
 Aracynthus, *Ætolia.*  
 Aradus, *Phœnicia, 491.*  
 Aragona, (*Suppl.*)  
 Aragua, *Cumana.*  
 Araguay-Guaso, *Pilkomayo.*  
 Araguay-Mino, *Pilkomayo.*  
 Aramaic lang. *Aramæa.*  
 Araneiformes, *Pylagonida.*  
 Arapey (r.), *Uruguay.*  
 Arara, *Macaw.*  
 Aras, *Armenia, Azerbaijan.*  
 Arausio, *battle of, Rome, 318.*  
 Aravulli (mts.), (*Suppl.*)  
 Araxes, *Aras, Azerbaijan.*  
 Arba, *Dominis, M. A. de.*  
 Arber (mt.), *Bavaria, 759.*  
 Arbigny, *Chiserois.*  
 Arbil, *Arbela.*  
 Arbogastes, *Valentinianus.*  
 Arbor Diane, *Amalgam.*  
 Arborfeld, *Eichstadi.*  
 Arce, (*Suppl.*)  
 Archæology, *Biblical, Biblical Archaeology.*  
 Archæopteryx, *Solenhofen Stone.*  
 Archagathus, *Agathocles, Medicine, Hist. of.*  
 Archambaud I., *Bourbon.*  
 Archibishop (is.), *Bonin.*  
 Archedemus, *Stoics.*  
 Archegonia, *Vegetable Physiology, 737.*  
 Archer, *Photography, 509.*  
 Archil, *Dye-stuffs.*  
 Archilochian Verse, *Archilochus.*  
 Archimandrite, *Greek Church, 87.*  
 Arcidosso, (*Suppl.*)  
 Arctostaphylos, *Arbutus.*  
 Arcubalest, *Arbalest.*  
 Arculfus, *Adamnan (Suppl.)*  
 Arcus Senilis, (*Suppl.*)  
 Ardakilitin (r.), *Cranmoges.*  
 Ardebil, *Azerbaijan.*  
 Ardia, *Guadiana.*  
 Ardish, *Akhal (Suppl.)*  
 Ardishur, *Sassanida.*  
 Ardmeanach, *Ross and Cromarty.*  
 Ardnaree, *Sligo.* 781

Arecibo, *(Suppl.)*  
 Aregu, *Genoa*  
 Arenicola, *Scarabaeidae*  
 Arenig beds, *Silurian Rocks*  
 Arensburg, *Ossol (Suppl.)*  
 Argalus, *Fish-louse*, 350.  
 Argas, *Acarus*  
 Argiles, *Pyrites, Hautes*  
 Argens (r.), *Var.*  
 Argemosa, *Spanish Lang. & Lit.* 50.  
 Argenta, *(Suppl.)*  
 Argentario (*mta.*), *Albania*  
 Argentan, *Oran*  
 Argentic, *Glance*  
 Argel, *Argel*  
 Argo, *Argonauts*  
 Argos, *Argolis*  
 Argostol, gulf of, *Lixuri (Suppl.)*  
 Argour, *Amoor*  
 Argovio, *Aargau*  
 Arguenco, *Cote-du-Nord*  
 Argun, *Blanco*  
 Argumentum, *Wildfowl*  
 Argumentum ad hominem, *Fallacy*  
 Argun (r.), *Siberia*, 702.  
 Arguro Castro, *Albania*  
 Arhata, *Jamaica*  
 Aria, *Pyria*  
 Ariana, *Afghanistan*  
 Ariano, *(Suppl.)*  
 Aricari, *Aracari*  
 Arichat, *Capo Breton*  
 Aricia, *Roma*, 308.  
 Aricine, *Quinia*  
 Arimens, *Alexander the Gt.*  
 Ariminum, *Rimini*  
 Arinag, *Inverness-shire*  
 Arithometer, *Calculating Machine*  
 Arizona, *U. S.*, 647, *(Suppl.)*  
 Arjal, *Transylvania*  
 Ark-shell, *Arc*  
 Arktos and Arktus, *Ursa Major*  
 Arles, *Earnest*  
 Arlon, *(Suppl.)*  
 Armagh, book of, *Irish Lang.*  
 Armed bullhead, *Pagev.*  
 Armentieres, *(Suppl.)*  
 Armidale, *New South Wales*  
 Armiger, *Esquire*  
 Arming-press, *Book-binding*  
 Armoric Hills, *Cote-du-Nord*  
 Armour-plates, *(Suppl.)*  
 Arms, *Breech-loading Arms (Suppl.)*  
 Army Hospital Corps, *Staff Corp.*  
 Army of Reserve, *Reserve*  
 Arna, *Aruse*  
 Arnold, of Brescia, *Arnold*  
 Arnatto, *Arnotta*  
 Arnauts, *Albania*  
 Arnette (r.), *Masanet (Suppl.)*  
 Arney, *Fermanagh*  
 Arnold, Abbot of Citeaux and Milo, *Albigenses*  
 Arnold, General, *Andr.*, *Y.*, *U. S.*, 654.  
 Arnulph, *Carolingians*  
 Arnut, *Earthnut*  
 Aroe, *Slerwig*  
 Aroksallas, *(Suppl.)*  
 Aromatic, *(Suppl.)*  
 Aromatics, *Gems*, 664.  
 Arosia, *Cratagus, Pyrus*  
 Aroostook (r.), *White Mountains*  
 Arosa (b.), *Spain*, 13.  
 Arpa (r.), *Arus*  
 Arpa (r.), *Tipperrary*  
 Arreacan, *Aracac*  
 Arnan Mowddy, *Merioneth*  
 Arzatz, *Gerr*  
 Arthes, *Diligence*  
 Arriege, *Arage*  
 Aroo, *Papua*, 251.  
 Aroux, *Cote d'Or*  
 Arrow (k.), *Sligo*  
 Arrow (r.), *Hertfordshire*  
 Arrow (r.), *Otago*  
 Arrow (r.), *Superior, Lake*  
 Arrow-headed, *Cuneiform*

Babagan, *Peruvia*, 422.  
 Babi, *Sumatra*.  
 Babine (L.), *Columbia, British*.  
 Babul, *Accie*.  
 Babur, *Baber*.  
 Babuyan (L.), *Philippine Is.*  
 Bacchantes, *Bacchus*, 60a.  
 Bacchigione (r.), *Austria, Vicenza*.  
 Bacchus-wine, *Naxos*.  
 Bachelors' buttons, *Ranunculus*.  
 Backilo (r.), *Magdala* (Suppl.)  
 'Backing the field,' *Horse-racing*, 428.  
 Backplate, *Brassplate*.  
 Backstays, *Rigging*.  
 Back-water, *Water-power*, 94.  
 'Backwaters,' *Ghaats*.  
 Bacolor, (Suppl.)  
 Bacon beetle, *Clavicornis*.  
 Bacomiama, *Ana*.  
 Bacs Canal, *Zombor*.  
 Bactra, *Bactria*.  
 Baup, (Suppl.)  
 Badarka, (Suppl.)  
 Baden, *Germany* (Suppl.), 535  
 Badenoch, Lords of, *Gordon Family*, 8.  
 Bael, *Arantiacae*.  
 Bael, *Bhal*.  
 Baetica, *Andalusia, Spain*, 15.  
 Baffa, *Bazza*.  
 Bagaria, (Suppl.)  
 Bagenalstown, *Carlton*.  
 Baggit, *Salmon*, 446.  
 Bagheria, *Bagaria* (Suppl.)  
 Baghistan, *Bekistan*.  
 Bagirmi, *Bagharni*.  
 Bagna-Cavallo, (Suppl.)  
 Bagni di Lucca, (Suppl.)  
 Bagno a Ripoli, (Suppl.)  
 Bagnol, *Muscadel*.  
 Bagnolo, (Suppl.)  
 Bagradas (r.), *Tunis*.  
 Bahar, (Suppl.)  
 Bahia, *Cotton*, 268.  
 Bahour, *Pondicherry*.  
 Bahr-el-Abiad, *Nile*.  
 Bahr-el-Asirad, *Abyssinia, Nile*.  
 Bahr-el-Azrek, *Nile*.  
 Bahr-el-Gazal, *Nile*.  
 Bahr-el-Merj (L.), *Damascus*.  
 Bahr-Jusuf, *Maria* (L.).  
 Bahr Loot, *Dead Sea*.  
 Baiern, *Bavaria*.  
 Bailey, Sam, (Suppl.)  
 Bailie, *Baillif*.  
 Bailment, (Suppl.)  
 Bailments, *Contract*.  
 Bails, *Cricket*.  
 Bain, *Telegraph*, 340.  
 Bain, A. (Suppl.)  
 Bainbridge, *Dowm*.  
 Baiocco, *Bajocco*.  
 Bairam, *Bairam*.  
 Baise (r.), *Coronno, Gers*.  
 Bait-fishing, *Angling*, 257.  
 Baitool, (Suppl.)  
 Bajada de Santa Fé, *Entre Rios*.  
 Bajan, *Bejan*.  
 Bajazet I., II., *Ottoman Empire*, 148.  
 Bajjerkait, *Pangolin*.  
 Bajmak, (Suppl.)  
 Bajra, *Ajmer*.  
 Bakar, *Buccari* (Suppl.)  
 Baker (mt.), *Washington* (ter.)  
 Baker, Sir S. W. (Suppl.)  
 Bakhtegan (L.), *Fars, Persia*, 420.  
 Baki, *Turk Lang. & Lit.*  
 Bakwains, *Betjwans*.  
 Bal, *Bally*.  
 Bala beds, *Coradoc Sandstone*.  
 Balachian, *Cochin-China*.  
 Balaghat districts, (Suppl.)  
 Balais, *Balay*.  
 Balan, *Travertina*.  
 Balance-sheet, *Book-keeping*.  
 Balaninus, *Worvil*.  
 Balanites *Egyptiaca, Amyridaceae*.

Barcelona, *Cumana*.  
 Barcelona nuts, *Hasel*.  
 Barclay, Dr John, (Suppl.)  
 Bardi, (Suppl.)  
 Bardits, *Esot*.  
 Bardou Hill, *Leicestershire*.  
 Bardey Isle, *Cardigan Bay*.  
 Barbedones Parliament, *Ramp Parliament*.  
 Barga, (Suppl.)  
 Barga Pass, (Suppl.)  
 Bargander, *Barnacle Goose*.  
 Bargemel, *Barr*.  
 Bargusiu, *Bahial*.  
 Baratinaky, *Shemyl*.  
 Barisan (mt.), *Sumatra*.  
 Barium, *Barr*.  
 Bark, *Barquo*.  
 Barkhusen, Hermann, *Reynard the Fox*.  
 Barking, (Suppl.)  
 Barking marmot, *Prairie Dog*.  
 Barking squirrel, *Prairie Dog*.  
 Bark-speeler, *Cropper*.  
 Barlaam, *Hoychasts*.  
 Barle, *Esot*.  
 Bar-le-duc, *Meuse*.  
 Barley midge, *Cocidomyia*.  
 Barmouth Bay, *Merioneth*.  
 Barnaul, *Altai Mts.* (Suppl.)  
 Barnburner, *Republican*.  
 Barnes, Rev. W. (Suppl.)  
 Barnes, Thomas, *Times, The*.  
 Barnett, battle of, *Richard III.*  
 Barnum, P. T. (Suppl.)  
 Baroach, (Suppl.)  
 Barouche, *Coach*.  
 Barquesimeto, (Suppl.)  
 Barr, *Bar*.  
 Barracks, *War Services* (Suppl.)  
 Barraconda, *Gambia*.  
 Barraconda, *Sphyrenidae*.  
 Barrada, *Damascus*.  
 Barra Mansa, (Suppl.)  
 Barrancas, *Mexico*.  
 Barras, *Directory*.  
 Barrastera, *Barristera*.  
 Barretry, *Barvatry*.  
 Barrington Isle, *Galapagos Is.*  
 Barrow, *Kildare, Queen's County*.  
 Barrow (r.), *Barrow-in-Furness* (Suppl.)  
 Barrow-in-Furness, (Suppl.)  
 Barrulet, *Barr*.  
 Bars, *Barock*.  
 Bars Khotan, *Baras Khotan*.  
 Bar-sur-Ornain, *Bar-le-Duc*.  
 Bart, Jean, *Barth*.  
 Barthelemy, A. M. (Suppl.)  
 Barton beds, *Bagshot Beds*.  
 Barwon (r.), *Victoria*, 785.  
 Barygaza, *Baroach* (Suppl.)  
 Basantganj, (Suppl.)  
 Basento (r.), *Basiento*.  
 Bashee (r.), *Philippine Is.*  
 Bashee (r.), *Tombu*.  
 Bashkirs, *Turks*.  
 Basic water, *Salts*.  
 Basilia, *Basel*.  
 Basilus I., II., *Byzant. Emp.* 471.  
 Basle, *Basel*.  
 Basoche, *Bazoche*.  
 Basrah, *Basorra*.  
 Bass, *Base*.  
 Bass, *Basit*.  
 Bass, *Don*.  
 Bassadore, *Basidok*.  
 Bassein, *Pegu*.  
 Basselin, Olivier, *Vandreville*.  
 Bassenthwaite Water, *Cumbrian Mts.*  
 Basses-Alpes, *Alpes, Basses*.  
 Basseterre, *Christopher's, St.*  
 Basic acid, *Stearic Acid*.  
 Bassorin, *Mucilage*.  
 Bastan, *Navarra*.  
 Bastard, *Parrot and Child*.  
 Bastard cedar, *Chittagong Wood* (Suppl.)  
 Bastard group, *Thymus Glend*.  
 Bastard guava, *Eugenia*.

Beakneer, *Bikanir* (Supp.)  
 Beemah, *Calburga*.  
 Beer, *Alc*, *Barley*.  
 Beeroo, *Birn*.  
 Beet coffee, *Beet-root Sugar* (Supp.)  
 Beet-root sugar, (Supp.)  
 Beet-spirit, *Beet-root Sugar* (Supp.)  
 Befort, *Belfort*.  
 Beggars, *The*, *Gueuz* (Supp.)  
 Beggars of the Sea, *William, Prince of Orange*.  
 Begging Hermits, *Augustines*.  
 Beghards, *Beguines*.  
 Beglerbeg, *Beg*.  
 Bego (r.), *Thais*.  
 Beguttas, *Beguines*.  
 Behar, *Bahar* (Supp.)  
 Behbahan, *Fars*.  
 Behring's Island, *Behring's Strait*.  
 Beigerland, *Beyerland*.  
 Beikos, *Beghos*.  
 Bei-kul, *Baikal*.  
 Beilune, *Beilain*.  
 Beirut, *Bevront*.  
 Beit-al-Haram, *Beit*.  
 Beit-el-Maa, *Daphn*.  
 Beith, *Ayrshire*.  
 Beit-laham, *Bethlehem*.  
 Beitool, *Baitool* (Supp.)  
 Beit Ullah, *Mecca*.  
 Beja, *Alemjejo*.  
 Bel, *Baal*.  
 Belceru, *Greenheart*.  
 Belem, *Para*.  
 Belfast, U.S. *Penobscot*.  
 Belfast (I.), *Down*.  
 Belize, *Balize*.  
 Beljune, (Supp.)  
 Bell, Melville, *Shorthand*, 693.  
 Bellac, *Vienna, Haute*.  
 Bellagio, *Como* (I.).  
 Bell animalcules, or Bell-flower animalcules, *Vorticellidae*.  
 Bellano (I.), *Como* (I.).  
 Bellary, *Balaghat* (Supp.)  
 Bellay, J. du, *Ronsard*.  
 Bell-bird, *Honey-eater*.  
 Bellenz, *Bellinsona*.  
 Belleville, (Supp.)  
 Bellevue, *Iowa*.  
 Bellino, *Bandit*.  
 Bellotto, Bernardo, *Canaletto*.  
 Bellows, *Blowing-machines* (Supp.)  
 Belluno, Duke of, *Victor*.  
 Bellur, (Supp.)  
 Bel-lush, *Assyria*.  
 Belly (r.), *Saskatchewan*.  
 Bellyache, *Colic*.  
 Bel-merodach, *Assyria*.  
 Beloit, (Supp.)  
 Belpasso, (Supp.)  
 Belper, *Derbyshire*, (Supp.)  
 Bel-sazar, *Belshazzar*.  
 Beltane, *Beltein*.  
 Beltidium, *Rosary*.  
 Belturbet, *Cavan*.  
 Belu, *Amherst*.  
 Beluchias, *Sind*.  
 Belud-el-Jerid, *Barbary, Tunis*.  
 Beluga, *Dolphin*.  
 Beluka (mt.), *Altai Mts.* (Supp.)  
 Belus, *Baal, Dido*.  
 Ben-a-Main, *Banffshire*.  
 Benary, *Kinross-shire*.  
 Ben-avenna, *Daventry*.  
 Benavente, (Supp.)  
 Benchal, or Benchleugh, *Clackmannanshire*.  
 Ben Creach, *Argyleshire*.  
 Ben Cruachan, *Grampians*.  
 Bender, *Gombroon*.  
 Benedetto Odescalchi, *Innocent XI*.  
 Benedict, Jules, (Supp.)  
 Benedict Biscop, (Supp.)  
 Benedict XIII., Pope, *Schism, Western*.  
 Benet College, *Corpus Christi*.  
 Bengal Fire, Red, *Strontium*.  
 Bengies, *India*, 539.  
 Beni, *Bolivia*.  
 Beni, *Madaira*.  
 Beni-Hassan, *Necropolis*.  
 Ben Ima, *Argyleshire*.  
 Benjamin tree, *Bensoin*.  
 Ben-jemma, *Malla*.  
 Ben Klibert, *Sutherland*.  
 Ben Lomond, *Tasmania*, 306.  
 Ben Lui, *Tay*.  
 Ben More, *Grampians*.  
 Ben More in Assynt, *Sutherland*.  
 Benmore Head, *Fair Head*.  
 Ben-na-buid, *Aberdeenshire*.  
 Benn, *Niger*.  
 Bennear, *Cantire*.  
 Bennington, *Vermont*.  
 Ben Rinnes, *Banffshire*.  
 Bensart (I.), *Tunis*.  
 Ben Starvie, *Etive*.  
 Bentang, *Eriadendron*.  
 Ben Vorlich, *Dumbartonshire*.  
 Ben Wyvis, *Ross & Cromarty*.  
 Ben-y-Gloe, *Glentill*.  
 Benzerta, *Bierra*.  
 Benzine, *Bensole*.  
 Benzoin odoriferum, *Allepice*.  
 Benzoyle, *Bensile*.  
 Bepur, (Supp.)  
 Berat, *Albania*.  
 Beraun, *Moldav*.  
 Berbera, *Somali Land*.  
 Berberin, *Dye-stuffs*.  
 Berbers, *Barbary*.  
 Berceeto, (Supp.)  
 Berchemia, *Supple Jack*, (Supp.)  
 Bere, *Barley Bear*.  
 Berengaria, *Richard I*.  
 Beresina (r.), *Dnieper, Vilno*.  
 Berydab, *Wahabis*, 42.  
 Beresina (r.), *Beresina*.  
 Berezov, *Beresoff*.  
 Berga, (Supp.)  
 Bergamah, *Pergamus*.  
 Bergedorf, (Supp.)  
 Bergeronette, *Wagtail*.  
 Berghen, *Moss*.  
 Berg-mehl, *Animalcule*, 270.  
 Berg-Zabern, *Zabern*.  
 Bari, (Supp.)  
 Berkeley's theory of vision, *Vision*, 820-825.  
 Berkhamstead, Great, (Supp.)  
 Berlin Decree, *Continental System, Orders in Council*.  
 Berlin-work, *Embroidery*.  
 Bermudes, Geronimo, *Spanish Lang. & Lit.* 20.  
 Berna, *Berni*.  
 Bernalda, (Supp.)  
 Bernard, Claude, (Supp.)  
 Bernard, Richard, *Sabbath*, 402.  
 Bernardin Pass, *Alps*.  
 Bernay, (Supp.)  
 Berne, *Bern*.  
 Bernese Oberland, *Bern*.  
 Bernesga, *Leon*.  
 Bernhard, St. *Abelard*.  
 Bernia, *Berni*.  
 Bernicle, *Barnacle*.  
 Bernstorff, *Christian VII*.  
 Beroo, *Birn*.  
 Berothai, *Beyrout*.  
 Berou (r.), *Borneo*.  
 Berre, l'Etang de, *Rhone*.  
 Berri, *Berry*.  
 Berry-bearing alder, *Buckthorn*.  
 Berthelot, *Satire*.  
 Bertinor, (Supp.)  
 Bertrand de Born, *Troubadour*.  
 Berubium, *Dumcanby Head*.  
 Bervie, *Kincardineshire*.  
 Bervies, *Haddock*.  
 Berytus, *Beyrout, Phenicia*.  
 Bes, *Saugor* (Supp.)  
 Besanty Cross, *Besants*.  
 Besseges, (Supp.)  
 Besenova, (Supp.)  
 Bessi, *Serota*, 630.  
 Bessus, *Alexander the Great*.  
 Bethel-nut palm, *Arca*.  
 Bethesda, *Caernarvonshire*.  
 Bethlehemite Order, *Cross*.  
 Order of.  
 Bethlem Gabor, (Supp.)  
 Bethune, Cardinal, *Beaton*.  
 Bethune, *Pas-de-Calais*.  
 Betik, *Betick*.  
 Betle, *Betel*.  
 Betony, *Stachys*.  
 Betula, *Birch*, 103.  
 Betulineæ, *Betulaceæ*.  
 Betwa (r.), *Sumna*.  
 Beukels, *Beukelaan*.  
 Beust, F. F. von, (Supp.)  
 Beuthen, (Supp.)  
 Bey, *Beg*.  
 Bey-Keme (r.), *Yemsel*.  
 Beyeore, *Beyur* (Supp.)  
 Bezant, *Roualle*.  
 Bezant argent, *Plate*.  
 Bezantæ, *Besants*.  
 Bezdan, (Supp.)  
 Beziers, *Albigenses*.  
 Bezoar-stones, *Coprolites*.  
 Bhabhur, *Cotton Grass*.  
 Bhadarsa, (Supp.)  
 Bhadri (r.), *Bellur* (Supp.)  
 Bhagerette (r.), *Bhadrinath*.  
 Bhaghireti (r.), *Ganges*, 614.  
 Bhagruttee (r.), *Burhamporre* (Supp.)  
 Bhagutti (r.), *Ganges*, 615.  
 Bhagul, *Bagul*.  
 Bhamo (r.), *Irrawadi*.  
 Bhamputra, *Bamputra* (Supp.)  
 Bharuch, *Baroach* (Supp.)  
 Bhatgong, (Supp.)  
 Bhat's, *India*, 539.  
 Bhavani, *Uma*.  
 Bheel, *India*, 539.  
 Bhel, *Bael*.  
 Bhewannee, *Bhowan* (Supp.)  
 Bhlisa, *Bilza* (Supp.)  
 Bhojpur, (Supp.)  
 Bhowani-Kudar, *Bhavani-Kudar*.  
 Bhowan, (Supp.)  
 Bhugeisur, *Allahabad*.  
 Bhuij, (Supp.)  
 Bia (r.), *Ob*.  
 Biafo glacier, *Tibet*.  
 Biagrod, *Akjermannu*.  
 Bialy, *Bialystok*.  
 Biانا, (Supp.)  
 Bianson (r.), *Var*.  
 Bibawan, *Atlas Mt.*  
 Bible Christians, *Methodists*.  
 Bible Communists, *Perfectionists* (Supp.)  
 Biboate of soda, *Borax*.  
 Bibracte, *Autun*.  
 Biceps muscle, *Hand*, 223.  
 Bichacz, *Bihack*.  
 Bichir, *Polypterus*.  
 Bicker, *Beaker*.  
 Bidouze, *Pyrenees, Basses*.  
 Biela (r.), *Bohemia*, 189.  
 Biela, *Sturgeon*.  
 Bielaia (r.), *Timur, Ufa*.  
 Bieloe, *Nougorod*.  
 Bielstein, *Bielshöhle*.  
 Bièvre, *Seine*.  
 Bigahpur, (Supp.)  
 Bighorn, *Argali, Sheep*, 662.  
 Big Laurel, *Magnolia*.  
 Bigonelles, *Alpes, Basses*.  
 Big Sandy River, *Tennessee*.  
 Big Vermilion (r.), *Wabash*.  
 Bihar, (Supp.)  
 Bijapore, (Supp.)  
 Bijawur, (Supp.)  
 Biji, *Bhujji* (Supp.)  
 Bijnour, (Supp.)  
 Bijuga (I.), *Bissagos*.  
 Bikashu, *Buddhism*, 407.  
 Bila, *Bilin*.  
 Bilbilis, *Catalayud*.  
 Bilharzia, *Trematoda*.  
 Biling, *Reformation*, 159.  
 Bilious Fever, *Typhus and Typhoid Fevers*, 615.  
 Bill-book, *Book-keeping*, 227.  
 Bill of Pains and Penalties, *Bill of Attainder*.  
 Bills (in part), *Parliament*, 288.  
 Bilsa, (Supp.)  
 Bimah, *Kistna*, (Supp.)  
 Bimo, *Sumbawa*.  
 Bindloes (I.), *Galapagos I.*  
 Bingerloch, *Bingen*.  
 Bingol-su, *Aras*.  
 Binnen Bay of, *Ambony*.  
 Binny, *Barbel*.  
 Binondo, (Supp.)  
 Binue, *Benue*.  
 Biorneborg, (Supp.)  
 Bippinate, *Leaves*.  
 Birbhoom, *Berthoorn*.  
 Birch, Samuel, (Supp.)  
 Birch-oil, *Birch*, 104.  
 Birch-tar, *Birch*, 104.  
 Bird (I.), *America*, 104.  
 Bird (I.), *Chaos Islands*.  
 Bird-mite, *Ephias*.  
 Bireh-jik, *Bir*.  
 Biren, *Birn*.  
 Bir-es-teba, *Berricks*.  
 Biretum, *Vestments*.  
 Birgus, *Paras-crab*.  
 Biribi, *Rouge-et-noir*.  
 Birkenfeld, *Oldenburg*.  
 Birket-el-Kerun, *Maria I*.  
 Birket-el-Maruit, *Mersin*.  
 Birlaw, *Byrlan*.  
 Birs Nimrud, *Pyramid*, 31.  
 Birth, *Berth*.  
 Bisanagar, *Bimabuggur* (Supp.)  
 Bisceglie, (Supp.)  
 Biscoe's Range, *Graveni Land*.  
 Biscuit root, *Quassack*.  
 Biserta (I.), *Tunis*.  
 Bishari, *Africa*, 69 *Nabia*.  
 Bishop-Wearmouth, *Sunderland*.  
 Bishop-weed, *Custard*.  
 Bismark-Schoenhausen, (Supp.)  
 Bissayas, *Philippine Islands*.  
 Bisulauggur, (Supp.)  
 Bisulphide of carbon, *Sulphur*, 200.  
 Bisulphur, (Supp.)  
 Bisutun, *Bekistan*.  
 Biswamintri, *Bernia*.  
 Biterate, *Leaves*.  
 Bitlis (r.), *Tigrit*.  
 Bitolia, *Monastir*.  
 Bito-tree, *Hajiti*.  
 Bittacle, *Bismack*.  
 Bittenfeld, H. von, (Supp.)  
 Bitter apple, *Colocynth*.  
 Bitter cucumber, *Colocynth*.  
 Bitter (I.), *Suez, Suez* (Supp.)  
 Bitter liquid, *Bittern*.  
 Bitter of senna, *Cathartic*.  
 Bitter waters, *Mineral Waters*.  
 Bjelbog, *Slaves*.  
 Black (I.), *Ross & Cromarty*.  
 Black (I.), *Polynesia*.  
 Black (mt.), *Montenegro*.  
 Black (r.), *Yamnia*.  
 Black (r.), *Mississippi*.  
 Black (r.), *Niger*.  
 Blackadder (r.), *Berwickshire*.  
 Black-ash, *Soda*, 799.  
 Blackbird, *Buckland*.  
 Blackbird, Moor, *Ring Ouzel*.  
 Blackburn, (Supp.)  
 Black Country, *West Brumwich*.  
 Black cumis, *Corkle*.  
 Black Death, the recent, (Supp.)  
 Black Down, *Montip Hill*.  
 Black draught, *Magnesia, Senna*.  
 Black-eyed pea, *Dalichis*.  
 Blackfish, *Taslay*.  
 Black gram, *Kilney-bean*.  
 Black goose, *Broni Goose*.  
 Black grouse, *Blackcock*.  
 Black Hawk War, U.S. 657.  
 Black helmet, *Cannon*.  
 Black lark, *Dumfriesshire*.  
 Black leg, *Black Quarter*.  
 Black locust, *Honey Locust Tree*.  
 Black oak, *Quercitron*.  
 Black orang, *Chimpzee*.

Black Saturday, Perth, Five Articles of.  
 Black-shouldered hawk, *Elanet*.  
 Black spald, *Black Quarter*.  
 Black squitch, *Bent Grass*.  
 Blackstairs (mt.), *Wexford*.  
 Blackstone (r.), *Woodschoet*.  
 Black tang, *Wrack*.  
 Black Town, *Bombay*.  
 Black varnish tree, *Melanorrhæa*.  
 Black vomit, *Yellow Fever*.  
 Black water, *Carriem Crow*.  
 Blackwater, *Essex*.  
 Blackwater, *Oversydel*.  
 Black whale, *Casing Whale*.  
 Blackwood, *Rosewood*.  
 Blad-el-Djerid, *Algeria*, 138.  
 Bladenoch (r.), *Wigtown*.  
 Blair-Drummond, *Bog*.  
 Blanch Town, *South Australia*.  
 Blankenstein, *Blankenburg*.  
 Blanquette, *Sprai*.  
 Blanquilla, *Antilles*.  
 Blantyre, Lord, *Stewart Family*, 126.  
 Blasquets, *Kerry*.  
 Blastema, *Cells*, 706.  
 Blau (r.), *Ulm*.  
 Blauw, *Blauw*.  
 Blavia, *Blaye*.  
 Blaze, *Brash*.  
 Blazing star, *Melanthaceæ*.  
 Bleeding, *Venesection*.  
 Eleiberg, *Blieback*.  
 Bleking, *Carlscrena*.  
 Blelham (l.), *Windermere*.  
 Blemmyes, *Nubia*.  
 Bleth holding, *Blanch*.  
 Blennorrhagia, *Gonorrhæa*, (Supp.)  
 Bleone, *Durance*.  
 Blera, *Gravina*.  
 Blessington, Earls of, *Stewart Family*, 126.  
 Bleu de Paris, *Dye-stuffs*.  
 Blewfields, *Nicaragua*.  
 Blimbing, *Carambola*.  
 Blind Bay, *Nelson* (Supp.)  
 Blindheim, *Blenheim*.  
 Blind rat, *Mole-rat*.  
 Blister copper, *Electro-metal-lurgy* (Supp.)  
 Blistering agents, *Vesicants*.  
 Blistering paste, *Camtharis*.  
 Bloaters, *Herring-fishery*, 347.  
 Bloem Fontein, *Orange River Free State*.  
 Blonde, *Chantilly*.  
 Blood-feud, *Vendetta*.  
 Blood-letting, *Venesection*.  
 Blood-striking, *Black Quarter*.  
 Blood-worm, *Midge*.  
 Bloody Council of the Netherlands, *Alba*.  
 Bloody urine, *Red Water*.  
 Blooms, *Iron*, 636.  
 Blossom, *Flower*.  
 Blower, *Spinning*, 46.  
 Blowing Cave, *Virginia*.  
 Blowing-machines, (Supp.)  
 Bluebell, *Harebell*.  
 Blue-bottle, *Centauræa*.  
 Bluebreast, *Bluetthroat*.  
 Blue-cheeked honey-eater, *Blue-eye*.  
 Bluefish, (Supp.)  
 Blue gum, *Tasmania*, 307.  
 Blue light, *Bengal Light*.  
 Blue-light Federalist, *Republican*.  
 Blue Mull Sound, *Yell*.  
 Blue wren, *Malurus*.  
 Blundeville, *Veterinary Medicine*.  
 Boarding, *Board*.  
 Board of Green Cloth, *Steward of the Household*.  
 Boatbill, (Supp.)  
 Boat-fish, *Dory*.  
 Boat-tail, *Quiscalus*.  
 Boavista, *Cape Verd Islands*.  
 Bobetays, *Rigging*.

Bocland, *Bochland*.  
 Boco, Capo, *Sicily*, 704.  
 Bode (r.), *Bielschöle*.  
 Bode, Barons de, (Supp.)  
 Bodjong, *Samarang*.  
 Bodrog (r.), *Theris*.  
 Böhmeria, (Supp.)  
 Boel, *Engraving*, 69.  
 Bog (r.), *Bug*.  
 Bogdo-lama, *Lamaism*.  
 Bogdshe-Adassi, *Tenedos*.  
 Boghaz, *Samos*.  
 Boghead coal, *Torbanehill Mineral*.  
 Boghra (mts.), *Cork*.  
 Bogles, *Goblins*.  
 Bog orchis, *Bryophyllum* (Supp.)  
 Bogue, *Bocca Tigris*.  
 Bohemian Deists, *Abrahamites*.  
 Bohemian glass, *Cassius*, *Purple of*.  
 Böhmervald, *Bohemia*, 189.  
 Bohodukhov, *Bogodoukhov*.  
 Bofda, *Bos*.  
 Boiling-point, *Thermometer*, 403.  
 Boisdale (L), *Uist*.  
 Bois de Chypre, *Cordiaceæ*, *Elm*.  
 Boissonade, J. F. (Supp.)  
 Boium, *Doris*.  
 Bojaha, *Nubia*.  
 Bojana (r.), *Scutari*.  
 Bökel, *Beukelaon*.  
 Bola, *Hibiscus*.  
 Boldu, *Monimiaceæ*.  
 Boli, (Supp.)  
 Bolivar, *New Grenada*.  
 Bol, *Lettuce*.  
 Bolor-tag (mts.), *Turkestan*, 583.  
 Bolsec, Jerome, *Calvin*, 526.  
 Bolward, (Supp.)  
 Bolwert, *Engraving*, 69.  
 Bolt-bar, *Lacc*.  
 Bolton, Captain, *Signale*.  
 Boly, *Boli* (Supp.)  
 Bomarsund, *Åland Is.*  
 Bombay duck, *Bummaloti*.  
 Bombelli, *Algebra*.  
 Bomb-ketch, *Bomb-vessel*.  
 Bombus, *Humble-bee*.  
 Bombycidæ, *Silk & Silk-worm*, 723.  
 Bombyllia, *Wax-wing*.  
 Bom Jardim, (Supp.)  
 Bon, Cape, *Africa*, 66. *Tunis*.  
 Bona Bona, *Bola Bola*.  
 Bonacca, *Bay Is., Ruatan*.  
 Bonaccio, *Algebra*.  
 Bon Air, *Buen Ayrt*.  
 Bonaparte, Ile de, *Reunion*.  
 Bona Vista, *Newfoundland*.  
 Boncherie process, *Wood-preserving*.  
 Bond of presentation, *Custion, Judicial*.  
 Bonduc, *Guilandina*.  
 Bone-bed, *Lias*.  
 Bone-cave, *Kent's Cavern* (Supp.)  
 Bone-earth, *Bone-ash*.  
 Bonelli, *Telegraph*, 340.  
 Bone-oil, *Tar*.  
 Bones, *Borvoustonnuss*.  
 Bonhard, *Bonyhad* (Supp.)  
 Boniface (governor of Africa), *Rome*, 321, *Valentinianus*.  
 Bonillo, (Supp.)  
 Bonington, *Painting*, 196.  
 Bonmahon, *Waterford*.  
 Bonnet, *Fortification*, 441.  
 Bonnet (r.), *Leitrim*.  
 Bonnet limpets, *Calyptrea*.  
 Bonnet-piece, *Nemimaticæ*, 5.  
 Bonneville, *Savoie*.  
 Bonniton Linn, *Clyde*.  
 Bonny, *Niger*.  
 Bonplandia, *Angostura Bark*.  
 Bont Quagga, *Dawu*.  
 Bony, *Boni*.  
 Bonyhad, (Supp.)  
 Boobialla, *Tasmania*, 308.

Bok-society, *Book-club*.  
 Boolak, *Bonlak*.  
 Bool-work, *Buhl-work*.  
 Boomkin, *Bumkin*.  
 Boondee, *Bundi* (Supp.)  
 Bootan, *Bhotan*.  
 Booth, John Wilkes, *Seward*, 644, *U.S. 661*.  
 Bootikin, *Booi*.  
 Boots, *Shoes*.  
 Booty, *War Services* (Supp.)  
 Bora, *Alps*.  
 Bora Bora, *Bola Bola*.  
 Bora-dagh (mts.), *Albania*.  
 Bora Samba, (Supp.)  
 Borate of lime, *Hayesine*.  
 Borcette, *Bartscheid*.  
 Bordeu, *Anatomy*, 227.  
 Border (Heraldry), *Bordure*.  
 Bordoe, *Favæ Isles*.  
 Bordone, *Ambrogioatto*, *Giotta*.  
 Bore, *Bristol Channel*, *Hang-Chow-Foo*.  
 Boreal crown, *Aurora*.  
 Borecole, *Kale*.  
 Borer, *Hag*.  
 Borgetto, (Supp.)  
 Borgholm, *Öland*.  
 Borgomanero, (Supp.)  
 Borgonone, *Painting*, 195.  
 Borgo San Donino, (Supp.)  
 Borgotaro, (Supp.)  
 Borlazzo, *Iseo (l)*.  
 Bormida, *Po*.  
 Borne, *Bourbonnes-les-Bains*.  
 Borocalcite, *Hayesine*.  
 Borofak, *Borovsk*.  
 Boroihme, *Brian Boroihme*.  
 Borovitchi, (Supp.)  
 Borrowdale, *Kerwick*.  
 Bort, *Diamond*.  
 Borysthemes, *Dnieper*.  
 Borzna, (Supp.)  
 Bos, *Jungly Gau* (Supp.)  
 Bos Arnee, *Arnee*.  
 Bos brachyceros, *Zamouze*.  
 Bosch Vark, *Wart-hog*.  
 Bosco Reale, (Supp.)  
 Boshes, *Blast Furnace*.  
 Bosjesman's (r.), *Bushman's River*.  
 Bosna (r.), *Turkey*, 586.  
 Bosok, *Anatolia*, 227.  
 Bosporus, *Kertch*.  
 Boston Port Bill, *U. S. 653*.  
 Böttsörmeny, *Haiducks* (Supp.)  
 Botany Bay Kino, *Eucalyptus*.  
 Botaurus, *Bittern*.  
 Bothrioccephalidæ, *Tapeworm*, 290.  
 Botley Hill, *Downs, Surrey*.  
 Botrophis actæoides, *Actæa*.  
 Botkay, *Transylvania*.  
 Botta, *Buccino*.  
 Botticelli, *Engraving*, 69.  
 Bottlehead, *Dolphin*.  
 Bottle-nosed whale, *Bottle-head*.  
 Bouched, *Gun*.  
 Boucher, *Engraving*, 70.  
 Boucicault, D. (Supp.)  
 Boudroum, *Boodroum*.  
 Boufarik, (Supp.)  
 Boulac, *Boalak*.  
 Boulton, Matthew, *Watt*.  
 Bound, Dr Nicolas, *Sabbath*, 402.  
 Bounty, mutiny of, *Bligh, W*.  
 Bourbon FArchambault, *Allier*.  
 Bourbon-Vendéc, *Napoleon-Vendéc* (Supp.)  
 Bourg, *Ain, Ardeche*.  
 Bourgaueuf, *Creuse*.  
 Bourgeois, *Type*, 607.  
 Bouraa, *Broussa*.  
 Bourun, *Boodroon*.  
 Boussac, *Creuse*.  
 Bout-du-monde, *Cascade of Savoie*.  
 Bouvardia, (Supp.)  
 Bouza, *Abyssinia, Beer*.  
 Bovele, *Rhinoceros*.  
 Bovey coal, *Brown Coal*.  
 Bovills, *Marino* (Supp.)  
 Bow (r.), *Sasbathewan*.

Bowman's root, *Gillenia*.  
 Bow-window, *Bay-window*.  
 Bow-wow theory, *Onomatopæia*.  
 Box-tortoises, *Chelonia*.  
 Boyaca, *New Grenada*.  
 Boyana (r.), *Barnia*.  
 Boyar, *Bojar*.  
 Boyce, *Booce*.  
 Boyle, Plain of, *Roscommon*.  
 Boyne, *Banffshire*.  
 Boyne (r.), *Queensland*.  
 Bozrah, *Edom*.  
 Bourboure, *Sabbath*, 402.  
 Bracadale (l.), *Skye*.  
 Brachiale, *Brasartis*.  
 Brachionus dorcas, *Rotatoria*.  
 Brachirus, *Sola*.  
 Brachycephalus, *Skull*, 760.  
 Brachy-y-Fwill, *Cardigan Bay*.  
 Bracklen, *Brake*.  
 Bracklesham beds, *Bagshot Beds*.  
 Bracks, *Braxy*.  
 Bractea, bracteoles, bractlets, *Bract*.  
 Braddon M. E. (Supp.)  
 Braerich (mt.), *Dev*.  
 Bragança, *Braganza*.  
 Bragg, General, *U.S. 660*.  
 Brahe (r.), *Vistula*.  
 Brahmadundu oil, *Curuhu Oil* (Supp.)  
 Brâhmanas, *Veda*, 723.  
 Brahmany kite, *Erne*.  
 Brahmin, *Brahman*.  
 Brahminy bull, *Zebu*.  
 Braid, Mr., *Animal Magnetism*, 268.  
 Braik, *Braxy*.  
 Brailöf, *Brakilov*.  
 Brain, diseases of, *Brain*, 304.  
 Brain-fever, *Brain*, 304. *Typhus and Typhoid Fevers*, 615.  
 Brake, *Flax-dressing*.  
 Brama Raii, *Chatodontide*.  
 Brambanan, *Indian Architecture*.  
 Bramber, Rape of, *Sussex*.  
 Brancher, *Falcony*, 228.  
 Branchie, *Gills* (Supp.)  
 Branchiostegal rays, *Fishes*, 353.  
 Brancursine, *Acanthus*.  
 Brandano, *Basilicane*.  
 Brandon (mt.), *Kilbenny*.  
 Brandt, *Struensee*.  
 Brandywine, *Pennsylvania*.  
 Branecki, *Targovits*.  
 Branks, *Mumps*.  
 Branning, *Leather*.  
 Bras d'Or, *Nova Scotia*.  
 Brass instruments, *Wind Instruments*.  
 Brasso, *Cronstadt*.  
 Brass soldering, *Brasing*.  
 Brassy, *Bib*.  
 Bratfish, *Chub*.  
 Brathay (r.), *Windermere*.  
 Brattocks, *Eider*.  
 Brava, *Cape Verd Islands*.  
 Bray, *Wicklow*, (Supp.)  
 Bray, Mrs A. E. (Supp.)  
 Brazélin, *Brazil Nuts*.  
 Brazil cabbage, (Supp.)  
 Brazilian eagle, *Eagle Hawk*.  
 Brazil plum, *Hog Plum*.  
 Brazilian tea, *Gervais*.  
 Brazil pine, *Araucaria*.  
 Brda, *Montenegro*.  
 Bread, fermented, *Unfermented Bread*.  
 Bread, unleavened, *Unleavened Bread*.  
 Breadsalbæ, *Perthshire*.  
 Bread-nut, *Cow Tree*.  
 Bread-plants, *Cervalia*.  
 Bread-root, *Psoralea*.  
 Bread-tree, *Zamia*.  
 Bread-trees, *Caffer Bread*.  
 Break-bone fever, *Dengue*.  
 Breakspare, Nicolas, *Adrian*.  
 Breast-wheel, *Water-power* 94.  
 Brechan, Gulf of, *Corrievreckin*.

Breech-loading arms, (Supp.)  
 Breese, *Bot.*  
 Brege, *Danube.*  
 Brehon Laws, *Irish Laws.*  
 Bremen, *Bergamo.*  
 Bremer Pass, (Supp.)  
 Brenta, *Austria.*  
 Brent barnacle, *Barnacle Goose.*  
 Brentella, *Cittadella.*  
 Brent geese, *Barnacle Goose.*  
 Bressaire, *Staves, Deux.*  
 Bressmer, *Breast-summer.*  
 Brethren of Social Life, the  
 Common Lot, or of Good  
 Will, *Brotherhoods, Relig.*  
 Brethren of the Sword, *Tru-  
 tonic Knights.*  
 Bretwalda, *Anglo-Saxons, 26.*  
 Breveca (mt.), *Chamouni.*  
 Brevet, *War Services (Supp.)*  
 Brevier, *Type, 607.*  
 Bresova, (Supp.)  
 Briancion chalk, *Streatle.*  
 Briancion manna, *Larch.*  
 Bride, *St. Bridget, St.*  
 Bridge of boats, *Bridge, Millit.*  
 Bridges, suspension, *Suspension  
 Bridges.*  
 Bridgetown, *Barbadoes.*  
 Bridgetown, *Tolmes.*  
 Brielle, *Briel, Holland, South.*  
 Brienne-Napoleon, *Brienne-  
 le-Chateau.*  
 Briery Hill, (Supp.)  
 Brieve, *Breve.*  
 Brie, *Moselle.*  
 Brigach, *Danube.*  
 Brigg, *Glandford Brigg (Supp.)*  
 Bright, Sir Charles, *Tele-  
 graph, 335.*  
 Brightelmstone, *Brighton.*  
 Brigitte, *Bridget.*  
 Brihuega, battle of, *Vendome.*  
 Brill, the, *Briel.*  
 Brilliant, *Type, 607.*  
 Brilliant, *Methodists.*  
 Brimstone Hill, *Christo-  
 pher's, St.*  
 Brinjal, *Egg-plant.*  
 Brioude, *Loire, Haute.*  
 Brisbane, *Moriton Bay.*  
 Brisbane (r.), *Queensland.*  
 Brise, *Brizere.*  
 Bristol, *Rhode Island.*  
 Bristol Bay, *Alaska.*  
 Bristol brass, *Alloy.*  
 Brisures, *Abatement.*  
 Britannia metal, (Supp.)  
 British America, *American,  
 British.*  
 British Channel, *English  
 Channel.*  
 British Columbia, *Canada  
 (Supp.), 448.*  
 Britons, *Celtic Nations.*  
 Britzschka, *Coach.*  
 Brivas, *Brioude.*  
 Brive, *Correze.*  
 Brixham, (Supp.)  
 Brixham Cave, *Torquay.*  
 Brize, *Brizere.*  
 Broach, *Baroach (Supp.)*  
 Broad Bay, *Louis-mith-  
 Herrie.*  
 Broad Church, *England and  
 Ireland, Church of.*  
 Broadford, *Shye.*  
 Broadstairs, *Thanet.*  
 Broadstone, *Cromack.*  
 Broadway Hill, *Coteswold.*  
 Broang Pass, *Buende Pass  
 (Supp.)*  
 Broche, *Broach.*  
 Brochel Castle, *Racey.*  
 Brock, *Budger.*  
 Brock, General, *U.S. 656.*  
 Brocket, *Stag.*  
 Brogie, *Seven Years War,  
 636.*  
 Brogue, *Brog.*  
 Broken Bay, *Haushbury.*  
 Bromberg, *Posen.*  
 Booms Grove, (Supp.)  
 Bromus, *Bromo-grass.*  
 Bromochole, *Throat.*

Brook, C. Shirley, (Supp.)  
 Brookwood, *Pimperial.*  
 Broom-corn, (Supp.)  
 Brora (r.), *Sutherland.*  
 Brosimum, *Broad-leaf.*  
 Brosimus, *Torsk.*  
 Brostra (r.), *Shanman.*  
 Brothers of Christian Schools,  
 Schools, *Brothers of Chris-  
 tian.*  
 Brothock, *Arbroath.*  
 Brougham, *Coach.*  
 Brouwer, *Braunver.*  
 Brown-ague, *Hemicrania.*  
 Brown, Chas. Foster, (Supp.)  
 Brown, John, *Sabbath, 402.*  
 Brown (mt.), *Columbia, Brit-  
 ish, Rocky Mountains.*  
 Brown Bear, *Rifted Arms.*  
 Brown hemp, *Swiss.*  
 Brown ptarmigan, *Moorefowl.*  
 Brown University, *Rhode Is.*  
 Broyle, *Freiburg.*  
 Brshesny, (Supp.)  
 Bruck, *Brugg.*  
 Brude, *Picts.*  
 Bruggemann, Hans, *Carving.*  
 Bruhma, *Brakona.*  
 Bruise, (Supp.)  
 Bruisers, *Crushers.*  
 Brum, *Gomuto.*  
 Brummagem, *Birmingham.*  
 Brun, *Burnley.*  
 Bruna (r.), *Castiglioni, L. of.*  
 Brunai (r.), *Borneo.*  
 Brunanburgh, battle of, *Scot-  
 land, 556.*  
 Brundisium, *Brindisi.*  
 Brunjuka, *Broussa.*  
 Brusa, *Bithynia.*  
 Brusche (r.), *Strasbourg.*  
 Brush turkey, *Talagalla.*  
 Brussa, *Anatolia, 227.*  
 Bruses-point, *Lace.*  
 Brutians, *Rome, 324.*  
 Bryantia, *Methodists.*  
 Bryge-bot, *Trinoda nocentia.*  
 Bryher, *Scilly Islands.*  
 Bryophyllum, (Supp.)  
 Brusast, *Egypt, 79.*  
 Bubastis agria, *Belbeza.*  
 Bubble-shells, *Bulla.*  
 Bucbude, *Whelk.*  
 Buccari, (Supp.)  
 Buccinari (i.), *Caprove (Supp.)*  
 Bucco, *Atellana.*  
 Buceros, *Hornbill.*  
 Buchan, Earls of, *Stewart  
 Family, 126.*  
 Buchan Deeps, *Buchan-Ness.*  
 Bucinaris Islands, *Bonifacio,  
 Strait of.*  
 Buck, *Fallow Deer.*  
 Buck-eye, *Horse-chestnut.*  
 Bucket fever, *Dengue.*  
 Buckie, *Banffshire.*  
 Buckie, *Whelk.*  
 Bucking, *Bleaching, 228.*  
 Buckingham, Duke of, *Rich-  
 ard III.*  
 Buckland, F. T. (Supp.)  
 Bucksport, *Penobscot.*  
 Bucktails, *Republican.*  
 Buczacz, (Supp.)  
 Budaon, or Budayoon, (Supp.)  
 Budd, Dr William, *Typhus  
 and Typhoid Fevers, 624.*  
 Buddhism, *Ceylon, 738.*  
 Buddle, *Tim, 448.*  
 Bude, Guil., *Budava.*  
 Budhanub, (Supp.)  
 Budissin, *Bautaria.*  
 Budjak, *Bessarabia.*  
 Budukshaban, *Badakhshan.*  
 Budytes, *Wagtail.*  
 Buech, *Durmar.*  
 Buena Vista, battle of, *Taylor,  
 Zachary, U.S. 658.*  
 Buffalo (r.), *Kaffraria, Brit-  
 ish, Natal.*  
 Buffalo-fish, *Charotontide.*  
 Buff-headed duck, *Gorvet.*  
 Buffo, (Supp.)  
 Bufo and Bufonide, *Toad.*  
 Bugio, *Desonine.*

Built (r.), *Kishenui (Supp.)*  
 Built, *Bruckochshire.*  
 Buitenzorg, *Jawa (Supp.), 579.*  
 Bukharest, *Bucharest.*  
 Bukharia, Little, *Turkistan,  
 585.*  
 Bukke Fiord, *Caroline.*  
 Bukkur, (Supp.)  
 Bulgarians, *Cathari.*  
 Bulge, *Bilge.*  
 Bulbani, *Boudou.*  
 Bull, sacred, *Zebu.*  
 Bulla, *Seal.*  
 Bullas, (Supp.)  
 Bullas, (Supp.)  
 Bullion bar, *Glass.*  
 Bullock's heart, *Custard Apple.*  
 Bull of the bog, *Bittern.*  
 Bull Run, *U.S. 659.*  
 Bull Run (mts.), *Virginia.*  
 Bull's mouth, *Cameo.*  
 Bully-tree, *Bullet-tree.*  
 Bulrampur, (Supp.)  
 Bular, (Supp.)  
 Bulistan, *Tibet.*  
 Buluburg, (Supp.)  
 Bum-bailiff, *Boned-bailiff.*  
 Bum-bee, *Humble-bee.*  
 Bunas, *Banas (Supp.)*  
 Buncrana, *Swilly, Lach.*  
 Rundelcund Hills, *India, 537.*  
 Bundemeer, *Fars.*  
 Bunder Abbas, *Gombroon.*  
 Bungarus, *Bongour.*  
 Bungay, (Supp.)  
 Bunion, (Supp.)  
 Bunker's Hill, *Boston.*  
 Bunsen-burner, *Warning, &c.*  
 Bunzlau, (Supp.)  
 Buoyancy, *Hydrostatics, 490.*  
 Buoys, *Lighting of Beacons,  
 &c. (Supp.)*  
 Burada, *Barrada.*  
 Burasa, (Supp.)  
 Burbure, *Bay Islands.*  
 Burdekia (r.), *Queensland.*  
 Bureauary, *Bureau.*  
 Bu-Regreb (r.), *Rabat.*  
 Burenda Pass, (Supp.)  
 Bureng, (Supp.)  
 Burette, *Volumetric Analysis.*  
 Burg, *Femora.*  
 Burg, *Leysen.*  
 Burg, burgh, *Burg.*  
 Burg-bot, *Trinoda nocentia.*  
 Burghaz, *Burgas.*  
 Burghhead, *Argyleshire.*  
 Burgher, *Burgins.*  
 Burgher Synod, *U.P. Church,  
 645.*  
 Burgh-Mouza, *Mouza (Supp.)*  
 Burhampore, (Supp.)  
 Burhampur, (Supp.)  
 Burina, *Siberia, 702.*  
 Burina, *Chivvotz.*  
 Burke, R. O'Hara, *Austra-  
 lian Explorations (Supp.),  
 410.*  
 Burke and Hare, *Anatomy.*  
 Burlaw, *Byrlaw.*  
 Burler, *Woolen and Worsted  
 Manufacturers, 265.*  
 Burlington, *Iowa.*  
 Burnoose, *Beduins.*  
 Burns, Rev. Jabez, (Supp.)  
 Burnside, General, *Richmond,  
 U.S. 660.*  
 Buraugger, (Supp.)  
 Burr, Aaron, *U.S. 655, 656.*  
 Barra, *South Australia.*  
 Bursche, *University, 664.*  
 Burslem, *Stake-nipon-Trent.*  
 Burtah, *Mango Fish.*  
 Burton, Henry, *Sabbath, 402.*  
 Burton, Rich. Fr. (Supp.)  
 Buru, *Malacca.*  
 Burunhom, *Burunhom.*  
 Burwell, *Erie, Lake.*  
 Busaquino, *Buachina.*  
 Busento, *Coanusa.*  
 Bush (r.), *Austria.*  
 Bush-cat, *Scroed.*  
 Bush-cow, *Zammar.*  
 Bushehr, *Abuckher.*  
 Bush-hog, *Hog.*

Buwoza, *Bassora.*  
 Bustian-foul, *Rharmanian.*  
 Busto-Arsizio, (Supp.)  
 Butte, Earls and Marquiss of,  
*Stewart Family, 124.*  
 Butte, *Buzard.*  
 Butera, (Supp.)  
 Butler, Ben. F. (Supp.)  
 Butom, *Beathen (Supp.)*  
 Butt, *Leather.*  
 Butzer-and-tallow tree, *Fato  
 drama, Tallow Tree.*  
 Butter bar, *Tussilage.*  
 Butter-moss, *Caryox.*  
 Buttes (mt.), *Sierra Nevada.*  
 Button ankeroot, *Eryng.*  
 Butty gangs, *Rainies, &  
 Byzantium, Barbary.*  
 Bzewieski, *Targowita.*  
 Caama, *Keama.*  
 Cabades, *Sassanide.*  
 Cabbage-tree, *Andra.*  
 Cabenz del Bucy, (Supp.)  
 Cabotoure, *Moriton Bay.*  
 Cabotville, *Chicago (Supp.)*  
 Cabrera, *Promora.*  
 Cabrera, *Cabral.*  
 Cabriolet, *Coach.*  
 Cabrit, *Promora.*  
 Cacolet, *Amuletora.*  
 Cadaburi (r.), *Rio Negro.*  
 Cadamba, (Supp.)  
 Cad-bait, *Caddis.*  
 Cadet Froemen, *Danish  
 shire.*  
 Cadesia, battle of, *Sassanide.*  
 Cadge, *Falconry, 229.*  
 Cadwalloga, *Cathago.*  
 Caelebs, *Chafack.*  
 Caelostera, *Radiata.*  
 Caelian Hill, *Rome, 322.*  
 Caer-Gwent, *Wickiter.*  
 Caer-Seiont, *Cornewa.*  
 Caesarca Augusta, *Saragosa  
 (Supp.)*  
 Cassaron, *Clopheta.*  
 Cassium, *Rubidium.*  
 Cassius, *Blam.*  
 Cassus, *Cashu.*  
 Caete, *Cabell (Supp.)*  
 Cahete, (Supp.)  
 Caiman, *Alligator.*  
 Caintas, *Caia.*  
 Cairngorm, *Aberlandshire,  
 Banffshire, Greenlans.*  
 Carobharow, *Kirkcubright.*  
 Cairnsore, *Kirkcubright.*  
 Cauretol, *Aberlandshire.*  
 Cairo, *Ilbanis.*  
 Calte (r.), *Burgoyne.*  
 Calithness, Earls of, *Sinclair  
 Family.*  
 Calivasa, (Supp.)  
 Cajetan, *Bonifacio, Pope.*  
 Calabar bean, (Supp.)  
 Calacalla, *Chalk.*  
 Caladium, *Brazil Calings  
 (Supp.)*  
 Calah, *Assyria.*  
 Calappa, *Coccosand.*  
 Calascibetta, (Supp.)  
 Calaveras, mammoth mass of,  
*Wallingfama.*  
 Calawa, *Durwen.*  
 Calbe, *Kalbe.*  
 Calcareous alabaster, *Cal-  
 sinter.*  
 Calcraft, *Excavation.*  
 Calc-spar, *Calcareous Spar.*  
 Calc-tuff, *Calcareous Tuff.*  
 Caldecot, *Mammoth mass of.*  
 Calder, *Color.*  
 Caldern, *Chili, Volcanos.*  
 Calderson, battle of, *Serius.*  
 Caldeosa, *Caldez.*  
 Caldew, *Carlisle.*  
 Caldwell, C. *Pharmacy, 20.*  
 Caldeousian, *Celtic Nations.*  
 Calala, *Canacolema.*  
 Caltepine Lexion, *Faciolati.*  
 Calf of Man, *Man, Isle of.*  
 Calico bush, *Kalamin.*  
 Calidris, *Sanderling.*  
 California vulture, *Coaler.*

Calixtus III. *Borgia*.  
Calla, (*Supp.*)  
Callan, *Armagh, Kilkenny*.  
Callan, Mount, *Clare*.  
Callcedra wood, *Flindersia*.  
Callernish, (*Supp.*)  
Calloma, *El Dorado*.  
Callon, *Sculpture*, 577.  
Calmont Creek, *Sierra Leone*.  
Calmont (r.), *Mayenne*.  
Calocophagus, *Scol.*  
Calonyction bona nox, *Balls de Nuit*.  
Caloo-a-hatchee, *O-hoo-choo-bee*.  
Calore, *Benevento*.  
Caltabellota, (*Supp.*)  
Caltagirone, *Calatagirone*.  
Caltaro, *Dalmatia*.  
Caltavuturo, (*Supp.*)  
Calvert, *Raisley, Wordsworth*.  
Calvi, *Corsica*.  
Calvinistic churches, *Reformed Churches*.  
Calve, (*Supp.*)  
Camaletus griseus, *Manuscripts*.  
Camassia, *Onamash*.  
Cambo, *Pyrrhus, Basses*.  
Cambodia (r.), *Cochin China*.  
Camboja, *Cambodia*.  
Camboose, *Caboos*.  
Camden, (*Supp.*)  
Camden Fort, *Convict*.  
Camden Society, *Ros. Chb.*  
Camel (r.), *Cornwall*.  
Camerlengo, *Cardinal*.  
Camille, *Cordeliers*.  
Camirus, *Rhodes*.  
Camorra, (*Supp.*)  
Camowea (r.), *Tyrosa*.  
Campanella Cape, *Capri*.  
Campanella, (*Supp.*)  
Campador, *Cid Campeador*.  
Campelophilus, *Woodpecker*.  
Camp fever, *Typhus*, 615.  
Camphilene, *Camphene*.  
Campinas, *Rio Grande do Sul*, (*Supp.*)  
Campine, *Belgium*, 2, *Ghesl.*  
Campo Felice, *Italy*.  
Camulodunum, *Mallon*.  
Canaan, *Phanicia*, 490-491.  
Canada, (*Supp.*)  
Canada Creek, West, *Tranton Falls*.  
Canadian boat-song, *Ottawa*.  
Canadian hemp, *Apocynacea, Dogbane*.  
Canadian rice, *Cervalia, Rice*.  
Canale, *Cavaletto*.  
Canandaigua, (*Supp.*)  
Canandaigua (l.), *Susquehanna*.  
Canarese language, *Tamil*.  
Canatix, *Felanicha* (*Supp.*)  
Cancer, chimney-sweepers', *Scol.*  
Cancer of the stomach, *Stomach*.  
Cancer of the womb, *Womb, Diseases, &c. of the*, 252.  
Canche, *Pas-de-Calais*.  
Cancroma, *Boatbill* (*Supp.*)  
Cancrum oris, *Mouth*, (*Supp.*)  
Candela, (*Supp.*)  
Candle-fish, (*Supp.*)  
Cane straw or trash, *Bagasse*.  
Canha, *Estromadura*.  
Canicula, *Sirius*.  
Canje, *Gniana, British*, 132.  
Canker, *Month*.  
Canna, *Canca*.  
Cannaceae, *Marantacea*.  
Cannon, *Billiards*, 98.  
Cannon, *War-services* (*Supp.*)  
Cannon bone, *Ruminantia*.  
Cannor (l.), *Cranvogas*, 305.  
Canobus, *Canopus*.  
Canon, *Type*, 607.  
Canonisation, *Saints*.  
Canons, *Regular Canons*.  
Canque, *Cang*.  
Canso, *Troubadour*.  
Cantabria, *Basque Provinces*.  
Cantago, *Costa Rica*.

Cantharus, *Scarabans*.  
Cantharus, *Cantalliver*.  
Canto, *Rhaphanites*.  
Canto Fermo, *Plainsong*.  
Canto (r.), *Bayamo* (*Supp.*)  
Cant-timbers, *Shipbuilding*, 684.  
Cantu, *Centurio*.  
Canvas (in painting), *Painting*, 147.  
Canvas-back duck, *Pochard*.  
Caouana olivacea, *Turdle*.  
Capac (Manco, Huayna, &c.), *Peru*, 438.  
Capana, Monte della, *Elba*.  
Cap ash, *Melacca*.  
Cape Cod Bay, *Massachusetts Bay*.  
Cape Fear River, *Carolina, N.*  
Cape guaves, *Kleena Bac* (*Supp.*)  
Cape of Good Hope, *Papua*, 250.  
Cape sheep, *Abatross*.  
Capitation grant, *Volunteers*.  
Capitation tax, *Richard II.*  
Capitolium, *Rome*, 308.  
Cap la Rocca, *Portugal*.  
Capnio, *Ruchlin*.  
Cap of dignity, *Maintenances, Cap of*.  
Capollin, *Cherry*.  
Cappouin, *Waterford*.  
Capra, *Capella*.  
Capevolus, *Ros.*  
Capra, (*Supp.*)  
Caproic acid, (*Supp.*)  
Caprus, *Boar-fish*.  
Caprylic acid, *Capric Acid* (*Supp.*)  
Capsella, *Shepherd's Purse*.  
Capsular, *Ligaments*.  
Capulets & Montagues, (*Supp.*)  
Caqueta, *Yapora*.  
Carabineers, *Carabiners*.  
Carabost, *Shye*.  
Caraccioli, *Afonso V. of Aragon*.  
Caracol, *Guayaquil*.  
Caradoc, *Welsh Lang. & Lit.*, 136.  
Caradrina, *Willow-moth*.  
Carannia, *Karaman*.  
Caranbole, *Billiards*.  
Caranaiba Palm, *Carnahuba Palm*.  
Carapano, *Cumana*.  
Carapata, *Tick*.  
Carausius, *Saxons*.  
Caravats, *Ribbonism, White-boy*.  
Carbides, (*Supp.*)  
Carbo-hydrates, *Vegetable Chemistry*, 732.  
Carbolic acid, (*Supp.*)  
Carbonates, *Carbonic Acid*.  
Carburets, *Carbides* (*Supp.*)  
Carcaaso, *Carcassons*.  
Carcavela, *Rattlesnake*.  
Cardener (r.), *Cardona*.  
Carder, *Woolen and Worsted Manufactures*, 265.  
Carders, *Ribbonism*.  
Cardigan B. Pr. Edward I.  
Cardinal (beverage), *Bishop* (beverage).  
Cardinal de Lugo's powder, *Cinchona*.  
Cardiospermum, *Sapindacea*.  
Cardone, *Manresa* (*Supp.*)  
Carduchi, *Druses, Kurdistan*.  
Carduelis spinus, *Aberdein*.  
Caremata Passage, *Billiton*.  
Caretta, *Tortoiseshell, Turtle*.  
Carham Burn, *Border*.  
Caribou, *Reindeer*.  
Caribs, *Christopher's, St.*  
Caricenes, *Cyperacea*.  
Caries of the teeth, *Tooth*, 330.  
Carigliano, *Muscato*.  
Carina, *Papilionacea*.  
Caripe, (*Supp.*)  
Carisbrooke Castle, *Wight, Isle of*.  
Carjacou, *Cariacou*.  
Carle Sunday, *Carle Sunday*.

Carlisle Bay, *Barbadoes*.  
Carlisma, *Caroliungians*.  
Carlos, San, (*Supp.*)  
Carlishama, (*Supp.*)  
Carlsten, *Sweden*, 237.  
Carlyle Fort, *Coniack*.  
Carmania, *Kerman*.  
Carmathians, *Karmathians* (*Supp.*)  
Carmatives, *Narcotica*.  
Carnarvon, Earl of, (*Supp.*)  
Carnedd-Llawelyn (mt.), *Snowdon*.  
Carnore Point, *Wexford*.  
Carolina catchfly, *Diomaa*.  
Carolina parrot, *Macaw*.  
Carolina rail, *Crake*.  
Caroni, *Orinoco*.  
Carora, (*Supp.*)  
Carouge, (*Supp.*)  
Carpal bones, *Hand*, 222.  
Carpat, *Carpathian Mts.*  
Carpathos, *Scarpanto*.  
Carpi, *Transylvania*.  
Carpophore, *Umbellifera*.  
Carr, Viscount Rochester, *Overbury, Sir T.*  
Carran-tual, *Magillycuddy Rocks*.  
Carrapato, (*Supp.*)  
Carrara-water, *Atrated Waters*.  
Carrera, Rafael, *Guatemala*.  
Carriacou, *Grenadines*.  
Carrick, *Ayrshire*.  
Carrick-beg, *Waterford*.  
Carrick Road, *Cornwall*.  
Carrion-bird, *Jay*.  
Carrot-fly, *Carrot*.  
Carrotting, *Fur*.  
Carrying-trade, *Carriers*.  
Carson City, *Nevada*.  
Carson's (r.), *Washes*.  
Cart, Black (r.), *Kenfrew*.  
Cart, White (r.), *Kenfrew*.  
Carte, *Fencing*, 283.  
Carter, Dr. *Parasitic Diseases*.  
Carter Fell, *Cheviot Hills*.  
Carthamus, *Safflower*.  
Carthusian Powder, *Kermes Mineral*.  
Carton-pierre, *Papier-maché*.  
Cartridge, Snider, *Breech-loading Arms* (*Supp.*), 438.  
Carum, *Caraway*.  
Carvin-Epinoy, (*Supp.*)  
Caryll, *Crait*.  
Carystos, *Euboea*.  
Cascade (mts.), *Oregon*.  
Cascade City, *Washington Territory*.  
Caselli, *Telegraph*, 240.  
Cashan (mts.), *Transvaal Republic*.  
Cash-book, *Book-keeping*, 207.  
Cashen, *Kerry*.  
Casherbox, *Glass*, 779.  
Cashmere (town), *Seringapur*.  
Cassia, (*Supp.*)  
Cask-bridge, *Bridge, Milit.*  
Caskets (Rocks), *Alderney*.  
Casmarynchus, *Bell-bird*.  
Cassada bread, *Manioc*.  
Cassia, oil of, *Cinamomic Ac.* (*Supp.*)  
Cassidaria, (*Supp.*)  
Cassirpe, *Caesareop*.  
Cassis, *Currant*.  
Cassis, *Helmet-shell* (*Supp.*)  
Cassiterite, *Tin*, 448.  
Cassowary tree, *Casuarina*.  
Casumunar, *Ginger*.  
Castalian Spring, *Castri*.  
Castanum, *Chestnut*.  
Castanulas, *Carlaneta*.  
Castel, *Chateau*.  
Castello, *Monte-Catini*.  
Castello, Lago di, *Albano*.  
Castelnau, Petes of, *Albigenses*.  
Castel Nuova, *Mandaryna*.  
Castel St. Angelo, *Tough*.  
Castiglione, (*Supp.*)  
Castine, *Pembecol*.  
Castle Blayne, *Monaghan*.

brighshire.  
Castle Harbour, *Bermudas*.  
Castlemilk, *Snuarts of, Stewart Family*, 125.  
Castleria, *Roscommon*.  
Castleragh (r.), *Darling*.  
Castleturn, Lords and Earls of, *Stewart Family*, 123.  
Castleton, *Dundalk*.  
Castri, *Delphi*.  
Castro, *Chiloé*.  
Catacaustic, *Ceustic*.  
Cataract (mts.), *U.S. Gap*.  
Cat Bells, *Derwentwater*.  
Cat Castle, *Cat*.  
Catechist, *Catechism*.  
Catesby, R. *Gunpowder Plot*.  
Cat-fall, *Cat (shipboard)*.  
Catfish (r.), *Four Lakes*.  
Cat-fish, *Wolf-fish*.  
Catha, (*Supp.*)  
Catharines, *Prunes*.  
Cat-harpings, *Cat (shipboard)*.  
Cathartes, *Vulture*.  
Cat-head, *Cat (shipboard)*.  
Catharine wheels, *Pyrotechny*.  
Catherine Archipelago, *Aleutian Islands*.  
Catholic rent, *Roman Cath. Emancipation*.  
Cat-hook, *Cat (shipboard)*.  
Cat (i.), *Bahamas, Guanahani*.  
Catlaw, *Forfarshire*.  
Cat's-foot, *Cudweed*.  
Cat's gold, *Mica*.  
Cat shark, *Contraction*.  
Cat Stane, *Standing Stone*.  
Cat's silver, *Mica*.  
Catsup, *Ketchup*.  
Cat thyme, *Germander*.  
Cattle-plague, (*Supp.*)  
Catwater, *Plymouth Sound*.  
Cauci, *Wicklow*.  
Caudal artery, *Aorta*.  
Caura, *Orioco*.  
Causality, *Phrenology*, 577.  
Cauterets, *Pyrites, Hautes*.  
Cautey, *Bleeding*, 152.  
Caux (mts.), *Seine-Inférieure*.  
Cavado (r.), *Entre D. e Minho*.  
Cavillon, *Vaucluse*.  
Cavazzere, (*Supp.*)  
Cave Hill, *Belfast*.  
Cavendish, *Tobacco*, 463.  
Caverns, *Caves*.  
Cavour (town), *Cavour*.  
Cawdor, *Nairnshire*.  
Cawsand Bay, *Plymouth Sound*.  
Cayamba, *Andes*, 220.  
Cayo Hueso, *Key West*.  
Cayos, *Caioco*.  
Cazanare, *Boyaca*.  
Cazes, *Turkey*, 587.  
Cazique, *Cacique*.  
Cedar, bastard, *Toon*.  
Cedar of Goa, *Cypress*.  
Cedar, white and red, *Teica* (*Supp.*)  
Cedrela angustifolia, *Alliaceus Plants*.  
Cedrela Toona, *Toon*.  
Cedron, *Simarubacea*.  
Cefalonia, *Cephalonia*.  
Cefola, *Sofala*.  
Ceglie, (*Supp.*)  
Ceroog, *Dee*.  
Celandine, *Lesser Ranunculus*.  
Celeriac, *Celery*.  
Celestial Mountains, *Thian-Shan*.  
Cell, *Grecian Architecture*, 97.  
Cellular plants, *Spiral Vessels*.  
Celtic Society, *Raz. Club*.  
Celts' pipes, *Tobacco-pipes*.  
Cement, *Tooth*, 327.  
Cemeteries, *Sanitary Science* (*Supp.*), 722.  
Cenchree, *Corinth*.  
Cenchris, *Trigonoccephalus*.  
Ceneda, (*Supp.*)  
Cenis (mt.) Tunnel, *Tunnel, Compressed Air engine* (*Supp.*)  
Centaureia, *Centaury*, 787



Central America, *America*, 194, 205.  
 Centricus, *Trumpet-fish*.  
 Centrolophus, *Blackfish*.  
 Centropomus, *Sea-pike*.  
 Centuriators, *Magdeburg Centuries*.  
 Ceos, *Greece*, 85.  
 Cephalopus, *Impoon* (Supp.), *Klema Boc* (Supp.).  
 Cephalothorax, *Spider*.  
 Cephalus, *Attica, Baotia, Orchemonos*.  
 Cephus, *Rotcha*.  
 Cephus pygmaeus, *Sawfly*.  
 Cerastium, *Chickweed*.  
 Cerasus, *Cherry*.  
 Cerbera Tanghin, *Tanghin*.  
 Cerendo, *Cusco*.  
 Cereal grasses, *Cerealia*.  
 Cerebellum, *Phrenology*, 513.  
 Cerebral hemispheres, *Brain*, 302.  
 Ceret, *Pyrrhus Orientales*.  
 Cerin, or Cerotic acid, *Wax*.  
 Cerne, *Atlas Mt.*  
 Cernobog, *Slaves*.  
 Cerolin, *Wax*.  
 Cerro de Pasco, *Pasco*.  
 Cerro de Potosi, *Andes*, 239.  
 Ceruminous glands, *Skin*, 756.  
 Cervetri, *Cervetori*.  
 Cervino, Cardinal, *Trent, C. of*.  
 Cervo, *Bella*.  
 Cervus Canadensis, *Wapiti*.  
 Cestrotium, *Cerostrotum*.  
 Cetonina, *Ross Beetle, Turnip*.  
 Cetrarine, *Lichen*.  
 Cettigne, *Montenegro*.  
 Cettina (r.), *Dalmatia*.  
 Cettinji, *Montenegro*.  
 Cevadic acid, *Sabadilla*.  
 Ceylon moss, *Plocaria*.  
 Ceylon tea-tree, *Bloodendron*.  
 Chabert, *Animal Heat*.  
 Chaco, *Paraguay*, 257.  
 Chad, *St. Anglo-Catholic Church*, 258.  
 Chasophyllum, *tuberosum, Umbellifera*.  
 Chastognathus, *Worms*, 279.  
 Chailla, P. B. de, (Supp.).  
 Chain-armor, *Chain-mail*.  
 Chained book, *Book*, 224.  
 Chairs, railway, *Railways*, 88.  
 Chairya, *Tape*.  
 Chak-Chak, *Pemba* (Supp.).  
 Chalcis, *Carlo-Syria*.  
 Chalcopyrite, *Pyrites*.  
 Chalk, red, *Reddle*.  
 Chalk formation, *Cretaceous Group*.  
 Chalk-stones, *Uric Acid*.  
 Chalonnaia, *Sabno-et-Loire*.  
 Chalylbeates, *Mineral Waters*.  
 Chamba, *Cashmere*.  
 Chamber acid, *Sulph. Acid*, 203.  
 Chambered limpet, *Calyptrea*.  
 Chambord, *Renaissance*.  
 Chambre Introuvable, (Supp.).  
 Chamburu, *Papaw*.  
 Chamelon silk, *Taffety*.  
 Chamelicon (r.), *Honduras*.  
 Chamonix, *Chamouni*.  
 Champ Levé, *Enamel*.  
 Chance, *Messrs, Glass*, 783.  
 Chancellary, *Chancery*.  
 Chancellorsville, battle of, *Rappahannock*.  
 Chancres, *Syphilis*, 258.  
 Chandah, (Supp.).  
 Chanderi, *Chandhaira* (Supp.).  
 Chandhairee, (Supp.).  
 Chandpore, (Supp.).  
 Chandragupta, *India*, 548.  
 Chank-shell, (Supp.).  
 Chanson, *Ring*.  
 Chansons de Geste, *Roland*.  
 Chantaburi, *Siam*.  
 Chantelle-le-Chateau, *Allier*.  
 Chanter, *Bagpipe*.  
 Chão, *Desiras*.  
 Chaoyen, *Corra*, 788.

Cheops, *Egypt*, 780, *Pyramid*.  
 Cheribon, *Java* (Supp.).  
 Cheroot, *Tobacco*, 465.  
 Cherry-brandy, *Kirschwasser*.  
 Chersonese, *Heracleotic, Sebastopol*.  
 Cherty, *Chert*.  
 Cherubini, (Supp.).  
 Cherwell, *Oxfordshire, Thames*.  
 Chesil Bank, *Portland Island*.  
 Chessart, *Chesse*.  
 Chesterfield coal-field, *U.S.* 670.  
 Cheviv, *Chab*.  
 Chewing of the cud, *Ruminantia*.  
 Chiari, battle of, *Victor-Amadeus*.  
 Chibchas, *New Grenada*.  
 Chichmeca, *Mexico*, 434.  
 Chickadee, *Blackcap Titmouse*.  
 Chickahay, *Pascagonia*.  
 Chickahominy (r.), *Virginia*.  
 Chickamauga, battle of, *U.S.* 660.  
 Chickrassia, *Chittagong Wood* (Supp.).  
 Chicopee, (Supp.).  
 Chiff-chaff, (Supp.).  
 Chicoutin, *Fraser River*.  
 Child-crowing, *Thymus Gland*.  
 Children, *Parents and Child*.  
 Chilianism, *Millennium*.  
 Chilicothe, *Chillicothe* (Supp.).  
 Chilliheque, *Auchenia*.  
 Chili pine, *Araucaria*.  
 Chlika, *Cuttack, Ganjam*.  
 Chilli, *Chili*.  
 Chillothee, (Supp.).  
 Chilon, *Seven Wise Men*.  
 Chilopoda, *Chilognatha*.  
 Chimney swallow, *Swift*.  
 Chimney-sweepers' cancer, *Soot*.  
 Chin-tai, *Corra*.  
 China-blue, *Calico Printing*.  
 Chinandega, (Supp.).  
 Chincha (r.), *Peru*, 435.  
 Chincha bug, *Epicna*.  
 Chine-felon, *Rheumatism*.  
 Chinese, *Wight* (i).  
 Chinese arrow-root, *Nalumbo*.  
 Chinese edible dog, (Supp.).  
 Chinese fire, *Pyrotechny*.  
 Chinese sugar-cane, *Durra*.  
 Chinghai, *Ningpo*.  
 Chinoline, *Dye-stuffs*.  
 Chioggiua, *Chioggia*.  
 Chip, *Pip* (Supp.).  
 Chipmuck, *Squirrel*.  
 Chippewa (r.), *Wisconsin*.  
 Chipping squirrel, *Ground Squirrel*.  
 Chipse, *Cyprus*.  
 Chiretta, *Chirata*.  
 Chirimoya, *Chirimoyer*.  
 Chirton, *Tymemouth*.  
 Chisels, *Carpentry*.  
 Chittagong wood, (Supp.).  
 Chittah, *Chectah*.  
 Chiua, *La*, (Supp.).  
 Chlamydosaurus, *Agama*.  
 Chloral, *Alcohols* (Supp.), 384.  
 Chloride of sulph. Sulphur, 200.  
 Chlorocarbonic acid, *Phosgene Gas*.  
 Chlorodyne, (Supp.).  
 Chloroform, *Alcohols* (Supp.), 384.  
 Chlorohydric acid, *Hydrochloric Acid*.  
 Chloromethyl, *Methylene* (Supp.).  
 Chlorometry, *Chlorimetry*.  
 Chlorophyll corpuscles, *Cells*, 709.  
 Chloroxyton, *Satin-wood*.  
 Chobanata (mt.), *Samarhaud*.  
 Chobe (r.), *Zambesi*.  
 Choctawhatchee, *Florida*.  
 Chocaim, *Chotyng*.  
 Cholera, *Sanitary Sc.* (Supp.) 729.  
 Cholopus, *Sloth*.

Chonka (r.), *Chogra*.  
 Choo-Keang, *Caetan, China*, 815.  
 Chopin, *Fred.* (Supp.).  
 Choquard, *Chocari*.  
 Chorasmia, *Khiva*.  
 Chorisia, *Silk-cotton*.  
 Choroid, *Eye*, 202.  
 Choroid plexus, *Brain*, 37.  
 Chorolque, *Nev. de Andes*, 13.  
 Chota Valley, *Andes*, 21.  
 Chott Mel'bir, *Sahara*.  
 Chotusitz, battle of, *Saxonian Wars*, 179.  
 Chow, *Heva*.  
 Chowan, *Carolina, North*.  
 Chowries, *Yak*.  
 Chowninghee, *Calcutta*.  
 Christ Cross Row, *Hornsea* (Supp.).  
 Christiansa Creek, *Braniswines Creek*.  
 Christianshavn, *Copenhagen*.  
 Christians of St John, *Zakim*, 329.  
 'Christian Year,' *Kelbi* (Supp.).  
 Christmas, *Gerard, Elisabeth Arktikatore*.  
 Christopher North, *Wils. Yaka*.  
 Chromatic aberration, *Eye*, 202.  
 Chrome yellow, *Lead*.  
 Chromogen, *Serotonin*.  
 Chromograph, (Supp.).  
 Chryselephantine statues, *Sculpture*, 576.  
 Chryses, *Diale*.  
 Chrysoalanaxia, (Supp.).  
 Chrysoberyl, *Mineral Jewels*.  
 Chrysograph, *Manuscript*.  
 Chrysolite, *volcanic, Vesuvius*.  
 Chrysoimitris, *Yellow-hrd.*  
 Chrysophrys, *Gilthead*.  
 Chrysopolis, *Ingolditi, Sc. Iart*.  
 Chucks, *Turnip*.  
 Chucuito, (Supp.).  
 Chuenpeo, *Becc Tigris*.  
 Chui (r.), *Semipalatinsk, Siberia*, 702.  
 Chulin (r.), *Tonak*.  
 Chulos, *Bull-fight*.  
 Chumalari, *Himalaya*.  
 Chumalea, *Ghogra*.  
 Chumie (r.), *Kaffria, Brit.*  
 Chunam, (Supp.).  
 Chundni (r.), *Gaugri*, 614.  
 Chun Quoit, *Cromick*.  
 Chupat, *Patagonia*.  
 Chuquibamba, *Nerado de Andes*, 239.  
 Chuquito, *Chucuito* (Supp.).  
 Chur, (Supp.).  
 Churchyard beetle, *Bele*.  
 Churn (r.), *Thames*.  
 Churu busco, battle of, *U.S.* 665.  
 Chur-worm, *Mole-cricket*.  
 Chusan Han-tai, *Amarant.*  
 Chuttees, *Guany Beg.*  
 Chuttree, *Cast.*, 657.  
 Chwolson, *Zakim*, 331.  
 Ciabiese, *Savoy*.  
 Cialdini, (Supp.).  
 Ciaran, *Ireland*, 626.  
 Cibao, *Haiti*.  
 Ciber, *Sculpture*, 577.  
 Cibol, *Welsh Onion*.  
 Cibiutum, *Pudu*.  
 Cibro, *Cyprus*.  
 Cicero, *Type*, 607.  
 Cicester, *Cirmaceter*.  
 Cincidela, (Supp.).  
 Ciconia argala, *Arnia*.  
 Cidaos, *Calahorra*.  
 Cmandef, *Bourton*, 112.  
 Cimolos, *Greece*, 85.  
 Cimone (mt.), *Apeninaz*.  
 Cinaloa, (Supp.).  
 Cinchoa alkaloids, *Quinia*.  
 Cinchonin, *Quinia*.  
 Cinchonine, *Quinia*.  
 Cinchonidine, *Quinia*.  
 Cincinurus, *Bird of Paradise*.  
 Cincel Bana, *Adamawa* (Supp.).  
 Cincture, *Vestments*.

Cinnamon, oil of, *Cinnamomum*.  
 Acid (Suppl.), 719.  
 Clothing, army, *War Services* (Suppl.), 719.  
 Cloth, *Suppl.*.  
 Cloths, *Puff-adder*.  
 Clotted Cream, *Clouted Cream*.  
 Clouet, François, *Painting*, 195.  
 Clova, *Forfarshire*.  
 Clove pink, *Carnation*.  
 Clown, *Harlequin*.  
 Club Breton, *Jacobins*.  
 Club-root, *Anbury*.  
 Clubs, golf, *Golf*.  
 Club-shell, *Clavagella*.  
 Clugny, *All-Souls Day*.  
 Clusium, *Chiussì*.  
 Clusius, *Botany*, 266.  
 Clutha, *New Zealand*.  
 Clypeus, *Shield*.  
 Clyweddog, *Dea*.  
 Cnicus, *Thistle*.  
 Coach-dog, (Suppl.)  
 Coal-naphtha, *Tar*.  
 Coalsey, *Coal-fish*.  
 Coal-supply, (Suppl.)  
 Coary (r.), *Amazon*.  
 Coast-guard, *War Services* (Suppl.)  
 Coat-rat, *Mole-rat*.  
 Coatbridge, (Suppl.)  
 Coatzacoalcas, *America*, 196.  
 Cobades, *Sassanida*.  
 Cobaltine, *Arsenical Minerals*, *Pyrites*.  
 Coban, (Suppl.)  
 Cobble, *Coble*.  
 Cobbold, Dr, *Sclerostoma*.  
 Cobquid (mts.), *Nova Scotia*.  
 Cobham, Lord, *Oldcastle*, *Sir Yahu*.  
 Cobs, *Maize*.  
 Coburg, *Ontario*.  
 Coccagne, *New Brunswick*.  
 Cocomillia, (Suppl.)  
 Cocculus, *Guluncha* (Suppl.)  
 Cochlearia, *Snail*.  
 Cock, J., *Coccyzus*.  
 Cockburn Isle, *Manitowlin Islands*.  
 Cockburn Sound, *Buache*.  
 Cockle, *Warming and Ventilation*, 64.  
 Cock-metal, *Alloy*.  
 Cock of the rock, *Rock*, *Cock of the*.  
 Cock paidle, *Lumpstucker*.  
 Cocktail, *Rove Beetle*.  
 Cock-up, *Lates*.  
 Coco, *Cocca*, *Samatra*.  
 Cocoa-nut fibre, *Coir*.  
 Cocoa-root, *Cocco*.  
 Cocumiglia, *Coccolilia* (Suppl.)  
 Cocum oil, (Suppl.)  
 Cocus wood, *Kokra Wood*.  
 Codarium, *Tamarind*.  
 Codbeck (r.), *Thirsk*.  
 Code Henri, *Christophe*.  
 Codex Argentens, *Uffilas*.  
 Codex Aureus, *Trèves*.  
 Coendus, *Porcupine*.  
 Coffee-bug, *Coccus*.  
 Coffe-fish, *Ostracion*.  
 Coffin, *Magdalen Island*.  
 Coffre de Perote, *Mexico*.  
 Cognation, *Agnate*.  
 Cognomen, *Name*, *Surname*.  
 Cohesion figures, (Suppl.)  
 Cohesion of metals, *Alloy*.  
 Cohorn, *Coehoorn*.  
 Coire, *Chur* (Suppl.)  
 Coiruang (r.), *Skye*.  
 Coix, *Cervalia*.  
 Coke-oil, *Gas-tar*.  
 Col, *Con*.  
 Colaba, *Bombay*.  
 Colair (r.), *Ellora*.  
 Colchicia, *colchicine*, *Colchicum*.  
 Col de Tenda, *Apennines*.  
 Cold frame, *Cold Pit*.  
 Cold Harbour, battle of, *U.S.* 661.  
 Coldingham, *Berwickshire*.  
 Col-di-Tenda, *Alps*.  
 Colebrook, *Fermanagh*.  
 Colkitto, *Cranoges*, 303.  
 Colla parte, *Ad Libitum*.  
 Collapae, *Shock*.  
 Collar-bone, *Clavicle*.  
 Collateral relationship, *Consanguinity* (Suppl.)  
 Collet, *Colewort*.  
 Collie, *Shepherd's Dog*.  
 Collier, Elisha H. *Revolver*.  
 Collimation, line of, *Circle*, *Mural*.  
 Collines Nantaises, *Vendée*, *La*.  
 Colloidon, *Photography*, 509.  
 Colloidon cantharidis, *Vesicants*.  
 Colloidum vesicans, *Vesicants*.  
 Colloids, *Osmaos*.  
 Collop Monday, *Shrovetide*.  
 Coln (r.), *Thames*.  
 Colne (r.), *Buckinghamshire*.  
 Colocasia macrorhiza, *Tara*.  
 Colombo, *Calumba*.  
 Colonel, *War Services* (Suppl.)  
 Colonial corps, *War Services* (Suppl.)  
 Colonne, Cape, *Cortout*.  
 Colophoniac acid, *Rosin*.  
 Colpetry, *Colombo*.  
 Col Roburent (mt.), *Alps*.  
 Cols, *Pyrenees*.  
 Colt, Colonel Samuel, *Revolver*.  
 Columbia, *Tennessee*.  
 Columbine, *Harlequin*.  
 Columbus, *Colombo*.  
 Columbus, *Mississippi*.  
 Comana, *Bostan*.  
 Coma vigil, *Typhus and Typhoid Fevers*, 612.  
 Comayagua, (Suppl.)  
 Combativeness, *Phrenology*, 514.  
 Comb-bar, *Lacc*.  
 Comino, *Malta*.  
 Cominotto, *Malta*.  
 Comitas gentium, *Law*.  
 Comitias, *Rome*, 311.  
 Commander's balsam, *Bonoin*.  
 Commandery, *Monastery*.  
 Commedia buffa, *Buffo* (Suppl.)  
 Commemoration, (Suppl.)  
 Commenry, (Suppl.)  
 Commercy, *Meuse*.  
 Commissariat staff corps, *Staff Corps*.  
 Commissions, army, *War Services* (Suppl.)  
 Commissure, *Brain*, 302.  
 Committees, parliamentary, *Parliament*, 288.  
 Committee's Punchbowl, *Athabasca*.  
 Common milkwort, *Polygala*.  
 Communion table, *Altar*.  
 Company of the Indies, *Mississippi Scheme*.  
 Company of the West, *Mississippi Scheme*.  
 Compass Hill, *Canna*.  
 Complement, *Trigonometry*.  
 Complutensian Bible, *Alcala de Henares*.  
 Composing-machine, *Typesetting Machine* (Suppl.)  
 Composition, *Tin*, 447.  
 Composer, matrix, *Printing* (Suppl.)  
 Comprehension, *Extension*.  
 Compressed-air engine, (Suppl.)  
 Comptrol department, *War Services* (Suppl.)  
 Comrawatee, *Berar*.  
 Comyn, *Cumyn*.  
 Comynes, *Comines*.  
 Cona, *Glencoe*.  
 Conal Gulban, *Adamnan* (Suppl.)  
 Conan, *Cromarty Firth*.  
 Conca d'Oro, *Sicily*, 704.  
 Concealment of birth, *Birth*, *Concealment of*.  
 Concepcion de la China, *Entre Rios*.  
 Conception, *Newfoundland*.  
 Conciergerie, *Paris*.  
 Condamine, *Darling*.  
 Condenser, *Liebig's*, *Retort*.  
 Condé-sur-Noireau, *Condé*.  
 Condiments, *Food and Drink*, 406.  
 Condom, (Suppl.)  
 Condrieu, *Rhone*.  
 Conduction, *Heat*, 281.  
 Condy's ventilating grate, *Warming and Ventilation*, 69.  
 Conessi bark, *Wrightia*.  
 Conestoga, *Lancaster*, *U.S.*  
 Confection of sulphur, *Sulphur*, 200.  
 Confederate States, *U.S.* 659.  
 Confessors, *Saints*.  
 Confitures, *Sweets*.  
 Conflans, *Savoie*.  
 Confolens, *Charante*.  
 Confronté, *Abaisif*.  
 Congestion, (Suppl.)  
 Congestion in rectum, *Rectum*.  
 Congoon, (Suppl.)  
 Congo pea, *Pigeon Pea*.  
 Congregation, *Oxford University*.  
 Congreve, Sir W. *Rocket*.  
 Conia or Conine, *Hemlock*.  
 Coniomycetes, *Fungi*.  
 Conisborough Castle, *Rotherham*.  
 Conister, *Douglas*.  
 Coniston Lake, *Lancashire*.  
 Conistone Water, *Cumbrian Mts.*  
 Connemara, *Galway*.  
 Conodonts, *Fishes*, 355.  
 Conolly, Captain, *Bokhara*.  
 Conon, *Antalcidas*.  
 Conon (r.), *Ross & Cromarty*.  
 Conrad, *Kowrad*.  
 Consanguinity, (Suppl.)  
 Conservation, *Thermodynamics* (Suppl.)  
 Conservatorium, *Conservatoire*.  
 Consignee, *Bill of Lading*.  
 Consignor, *Bill of Lading*.  
 Consolato del Mare, *Mercantile Law*.  
 Consonants, *Letters*.  
 Constable, *Painting*, 196.  
 Constantine, King, *Andrews*, *St. Scotland*, 555.  
 Constantine III., IV., V. *Byzantine Empire*, 470.  
 Constantine VI., VII., VIII., IX., X. *Byzantine Empire*, 471.  
 Constitucion, *Chili*.  
 Constitutional Associate Presbytery, *U.P. Church*, 646.  
 Constitutions, *Apostolice*, *Apostolic Canons*.  
 Constrictor muscles, *Digestion*, 559.  
 Constructiveness, *Phrenology*, 514.  
 Contas, *Bahia*.  
 Contessa, Gulf of, *Athos*.  
 Contilene, *Castabile*.  
 Continued fractions, *Fractions*, *Continued*.  
 Contorniat, *Medal*.  
 Contradiction, *Identity*.  
 Contralto, *Singing*.  
 Contraposition, *Conversion*.  
 Contra Remonstrants, *Gomarists*.  
 Contreras, battle of, *Scott*, *Winfield*, *U.S.* 658.  
 Control Department, *War Services* (Suppl.)  
 Contusion, *Bruise* (Suppl.)  
 Convalescent hospitals, (Suppl.)  
 Convection, *Heat*, 282.  
 Conversion, *Coverse*.  
 Convocation, *Oxford University*.  
 Conway, *Denbighshire*.  
 Coo, *Billiards*, 98.  
 Cook (mt.), *New Zealand*.  
 Cooke & Wheatstone, *Telegraph*, 334, 339, 340.

Coodia Hills, *Seyge*.  
 Cool Tankard, *Borago*.  
 Coomb, *Comb*.  
 Coonour, *Ootacemund*.  
 Cooper, *Shaftebury*.  
 Cooper (r.), *Charlston*.  
 Cooper's River, *Tybee*.  
 Co-ordinates, *Polar, Radius*.  
 Coosa (r.), *Alabama*.  
 Coosy, *Coosy*.  
 Copains, *Copains*.  
 Copifera, *Purple Wood*.  
 Copaline, *Copal*.  
 Copping, *Cope*.  
 Copper (mts.), *Cuba*.  
 Copper-green, *Chrysoctolla*.  
 Copperhead, *Republican*.  
 Copper-nickel, *Pyrites*.  
 Copper powder, *Bronzing*.  
 Coppice, *Cope*.  
 Copra, (*Supp.*)  
 Coprolites, *Phosphorus*.  
 Coprophagi, *Scarabacidae*.  
 Coptis, (*Supp.*)  
 Coquet (r.), *Chicot Hills*.  
 Coquilla-aut palm, *Pisacaba*.  
 Coquito, (*Supp.*)  
 Coracle, *Currack*.  
 Coracoid process, *Scapula*.  
 Corales, *Nicaragua Lake*.  
 Coral rag, *Oolite*.  
 Coral-root, *Dentaria (Supp.)*.  
 Cora-mota, *Ophicephalus*.  
 Coranich, *Coranach*.  
 Corato, (*Supp.*)  
 Coray, *Corais, Adamantium*.  
 Corbel table, *Cornice*.  
 Corcobado, *Andes, 239, 240*.  
 Corcya Nigra, *Curcua*.  
 Cordelier, *Lacs d'Amoner*.  
 Cordilleras, *Andes, 239*.  
 Cordoba, *Cordoba*.  
 Corduba, *Cordoba*.  
 Corduroy, *Molekin (Supp.)*.  
 Cordylone Tl, *Tl*.  
 Coré, *Cors*.  
 Cori, *Cors*.  
 Coriaria myrtifolia, *Smack*.  
 Corio Harbour, *Geelong*.  
 Corkwing, *Wrasse*.  
 Corkwood, *Cork*.  
 Cormac, *Aidan (Supp.)*.  
 Cormontaigne, *Fortification*.  
 Corn-crake, *Crake*.  
 Corn-drill, *Sowing*.  
 Corn-drum, *Trap*.  
 Cornelian, *Carnelian*.  
 Cornelian cherry, *Cornel*.  
 Cornelissen, *Flemish Lang.*  
 & Lit.  
 Cornet-a-piston, *Cornet*.  
 Corn-flag, *Iris*.  
 Corniche, *La, Alps*.  
 Cornings, *Beer*.  
 Cornish literature, *Celtic Nations*.  
 Corn marigold, *Chrysanthemum*.  
 Corno, Monte, *Gran Sasso d'Italia*.  
 Corn-plants, *Cerealia*.  
 Corn sawfly, *Sawfly*.  
 Cornua Ammonis, *Ammonites*.  
 Cornwallis, C. F. (*Supp.*)  
 Corn-worm, *Corn Moth*.  
 Coronella laevis, *Serpents, 677, Snake*.  
 Corporal punishment, *Flogging*.  
 Corpora quadrigemina, *Cerebrum*.  
 Corpora striata, *Cerebrum*.  
 Corporation Acts, *Test Acts*.  
 Corpse-gate, *Lychnis*.  
 Corpulence, *Obesity*.  
 Corpus callosum, *Brain, 303*.  
 Corpus Christi, *Texas*.  
 Corpus striatum, *Brain, 303*.  
 Corradi, Domenico, *Gibraltar-dajo, Domenico*.  
 Corra Linn, *Clyde*.  
 Correggio (town), (*Supp.*)  
 Correspondences, science of, *Swedenborg*.  
 Corroch, *Cork, City of*.

Cyrus (r.), *R. m.*  
 Cystic oxida, *Cystin.*  
 Cystidiana, *Silurian Rocks.*  
 Cystifera, *Cerigo, Phœnicia, 199.*  
 Cythnos, *Groes, 85.*  
 Cytancon, *Riscanham.*  
 Cytisine, *Labrumum.*  
 Cythoblastema, *Cells.*  
 Czackowski, *Berhamia, 190.*  
 Czernki, *German Catholics.*  
 Czirknitz (L.), *Zirknitz, L.*

Dabrowski, *Dombrowski.*  
 Dacca Jelapur, *Furidpur.*  
 Dacota, *Dakota.*  
 Dacotah, *Dakota.*  
 Dactylobranchia, *Pyrosomida.*  
 Daddy Long-legs, *Cranefly.*  
 Dadoxyton, *Trigonocarbon.*  
 Daft, *Leitrim.*  
 Daff, *Leitrim.*  
 Daguerrotype, *Photography, 508-509.*  
 Dago Island, *Rigo, Gulf of.*  
 Dagon, *Coanes, Philistines.*  
 Dagops, *Togo.*  
 Dahgops, *Dagoba.*  
 Dahrel Khotib, *Lahonan.*  
 Daiman (r.), *Uruguay.*  
 Dai Nipon, *Japan.*  
 Dak, *Dansk.*  
 Dalshina, *Decan.*  
 Dal (r.), *Sweden, 256.*  
 Dalarnia, *Dalarnia.*  
 Dalbo (L.), *Weyer, Labr.*  
 Dalby, *Queniam.*  
 D'Alembert's principle, *Right Dynamica.*  
 Dalfina, *Overysel.*  
 Dalina, *(Supp.).*  
 Dalkeith, Earl of, *Buccleuch.*  
 Dalmatia, Duke of, *South.*  
 Dalmatian dog, *Coach-dog (Supp.).*  
 Dalry, *Ayrshire, (Supp.).*  
 Dalrymple, *Repat, Signo.*  
 Dalton, *(Supp.).*  
 Damar, *Yemen.*  
 Damaras, *Osmamp.*  
 Damascening, *Damascening.*  
 Damaum, *India, Portuguese.*  
 Damboul, *Cydon, 199.*  
 Dambrod, *Dranghtis.*  
 Dammer (L.), *Pomerania.*  
 Damper, *Brand.*  
 Dampier, *Pianoforte.*  
 Dampremont, General, *Algeria, 121.*  
 Dam-stone, *Blast Furnace.*  
 Dan (r.), *Rouahs.*  
 Danaide, *Danab.*  
 Danda (r.), *Angola.*  
 Dando, *Cong.*  
 Dandriff, *Pyrriasis.*  
 Dane (r.), *Compton.*  
 Dane law, *Dane-laws.*  
 Danemora, *Sweden, 236.*  
 Dane's Hill, *Davertry.*  
 Dancer's pipes, *Tobacco-pipes.*  
 Danewort, *Elder.*  
 Danholm, *Stralsund.*  
 Danigan, *Philidor.*  
 Danilevski, *Russ. Lang. & Lit.*  
 Danish tongue, *Scandinavian Lang. & Lit. 500.*  
 Danzig deal, *Pr.*  
 Darab, *Farr.*  
 Darabگرد, *Farr.*  
 Daraganj, *(Supp.).*  
 Darbyites, *Plymouth Brethren.*  
 Dare, *Dec.*  
 Darent (r.), *Thames.*  
 Darik, *Shekel.*  
 Darius I., *signet of, Gonn, 664.*  
 Darjeeling, *(Supp.).*  
 Darling, *Dorking.*  
 Darkling beetle, *Blaf.*  
 Darnley, *Earls of, Stewart Family, 124.*  
 Darton, *Darlington.*  
 Darrampoor, *Coombators.*  
 Dart, *Dec.*  
 Dart (r.), *Dartmoor.*  
 Dasypocta, *Agouti.*

Dausle, *Guayaguil.*  
 Davenport, *Iron, (Supp.).*  
 David, Emperor, *Byzantine Empire, 178.*  
 Davies, *Rev. E. Anagram.*  
 Davies, Rev. Edward, *Welsh Lang. & Lit. 128.*  
 David's Land, *Eastern Island.*  
 Davydd ab Owilym, *Welsh Lang. & Lit. 126.*  
 Dawley Magna, *(Supp.).*  
 Dawson (r.), *Queensland.*  
 Day-cook, *Book-herping, 207.*  
 Ddaw (r.), *Cowbridge.*  
 Dead, *lineal of, Sanitary Science (Supp.), 729.*  
 Dead man fingers, *Akynonim, Coral.*  
 Dead-ol, *Gov-lar.*  
 Deadwood, *Shipbuilding, 64.*  
 Deak, *F. (Supp.).*  
 Deak, *ursi, Rival Dean.*  
 Dearborn, *For., Chicago.*  
 Dearborn, General, *U.S. 656.*  
 Dearne, *Dan.*  
 Deathadder, *Adder, Viperrida.*  
 Deben (r.), *Woodbridge.*  
 Debits recovery of, *(Supp.).*  
 Decade, *Deca.*  
 Decanaron, *Baccacis.*  
 Decanpa, *A. G. (Supp.).*  
 Decatur, *Commodore, U.S. 656.*  
 Deckanee hemp, *Hibiscus.*  
 Deck-cargo, *Cargo.*  
 Decker, *Paper, 213.*  
 Declinator, *action of, Action.*  
 Declaratory statutes, *Act of Parliament.*  
 Decomound, *Leaves.*  
 Decorus, *Decrement.*  
 Decoy-duck, *Wild-fowl.*  
 Decree-arbitral, *Arbitration, 361.*  
 Decrescent, *Decrement.*  
 Dectum, *(Supp.).*  
 Decurrent, *Leaves.*  
 De Donia, *statute, Recovery.*  
 Deed, *execution of, Execution of deed.*  
 Deed, *register of, Records, Public.*  
 Deel, *Boys, Limerick.*  
 Dee Nettle, *Dead Nettle.*  
 Deer Barry, *Gaultheria.*  
 Deer's Hair, *Scirpus.*  
 Deemed, *Infamed.*  
 Degradation, *Orders, Holy.*  
 De Grasse, *Count, Rodney.*  
 Dehincenzo, *Fruit.*  
 Deir, *Old Deer, Old.*  
 Deir-el-kamr, *Deir-el-Kamar.*  
 Delabole, *Camelford.*  
 De laine, *Calico Printing, 512.*  
 De la Rue, *Sw.*  
 Delaware Water Gap, *New Jersey.*  
 Delfshaven, *(Supp.).*  
 Delgado, *Cape, Yanga Bay.*  
 Delirium ebriatum, *(Supp.).*  
 Delirium nervosum or traumaticum, *(Supp.).*  
 Delirium tremens, *(Supp.).*  
 Delitzsch, *(Supp.).*  
 Della Porta, *Sculpture, 577.*  
 Delya, *(Supp.).*  
 Delphinorhynchus, *(Supp.).*  
 Delphinus, *Dauphin.*  
 Delundung, *(Supp.).*  
 Delvenau, *Drenmark.*  
 Delvigne, *Captain, Risted Arms.*  
 Demavend (mt.), *(Supp.).*  
 Dementia, *Faustly.*  
 Demer (r.), *Diet.*  
 Demetrius, *Russian Lang. & Lit.*  
 Demiriugos, *Geotica, 802.*  
 Democrats, *Republican, U.S. 655.*  
 Demodex folliculorum, *Acerus Folliculorum (Supp.).*

Dender (r.), *Abot, Scheldt.*  
 Dender (r.), *Nils, 177.*  
 Dendroessa spona, *Summer Duck.*  
 Denham, *traveller, Africa, 66.*  
 Denization, *Alien.*  
 Denner, *J. C. Clarinet.*  
 Denner, *A. P. (Supp.).*  
 Denmet, *Coach.*  
 Denroos, *Hibiscus.*  
 Dentaria, *(Supp.).*  
 Dentine, *Tooth, 27.*  
 Denys, *Transfusion of Blood.*  
 Deobund, *(Supp.).*  
 Departure, *Settings.*  
 Dephlogisticated air, *Oxygen.*  
 Dephlogisticated marine air, *Chlorine.*  
 Deposition, *Orders, Holy.*  
 Deptha, *War Services (Supp.).*  
 Dera Deen Punah, *Derajat.*  
 Dera Futti Khan, *Derajat.*  
 Dera Ghasee Khan, *Derajat.*  
 Dera Ismail Khan, *Derajat.*  
 Derayah, *Derayah El, (Supp.).*  
 Derbenzoa, *Diablerets.*  
 Deroceto, *Dezyn.*  
 Dereysehah, *Derajah (Supp.).*  
 Derg (L.), *Domagal.*  
 Derna, *Skin, 754.*  
 Derna, *Derah.*  
 Derrist, *Toburn.*  
 Derwent (r.), *Cumberland, Derbyshire, Onse, Trent.*  
 Desaret, *Utah.*  
 Descabizado (mt.), *Andes, 299.*  
 Desenda, *Antilles, Desirade.*  
 Desio, *(Supp.).*  
 Desmodus, *Vampire.*  
 Desmoncus, *Facitara Palm (Supp.).*  
 Desmond, *Tippary.*  
 Desna, *Dnieper, Orcl.*  
 Desnoyers, *Engraving, 70.*  
 Desolation (L.), *Patagonia.*  
 Des Patos (L.), *Rio Grande do Sul.*  
 Despoto Dagh (mts.), *Turkey, 586.*  
 Development, *hypothesis of, Tribe.*  
 Development, *progressive, Species.*  
 Deveron, *Doveron.*  
 Devt Saktas, *Umab.*  
 Devil-in-a-bush, *Nigella.*  
 Devil-in-a-mist, *Nigella.*  
 Devil's bit, *Melanthacca.*  
 Devil's Bit, *Tippary.*  
 Devil's Ditch, *Cambridgeshire.*  
 Devil's Lake, *Wisconsin.*  
 Devil's leaf, *Nettle.*  
 Devil's Throat, *Crozer.*  
 Dewar, *Dr., Sulphurous Acid (Supp.).*  
 Dewas, *(Supp.).*  
 Dewi, *St. David, St.*  
 Dew-point, *Rain, 94.*  
 Dew-worm, *Earthworm.*  
 Dexter, *Base.*  
 Dextro-racemic acid, *Tartaric Acid, 304.*  
 Dhanchi, *Dhanchee.*  
 Dharmastatra, *Sanscrit Lit. 475.*  
 Dhi, *Indore.*  
 Dhi mastic, *Leid, 60.*  
 Dhiuliba, *Niger.*  
 Dholka, *(Supp.).*  
 Dhoo (r.), *Douglas.*  
 Dhoona, *Danmar.*  
 Dhoul, *Ghagra.*  
 Dhuns, *Himalaya.*  
 Dialium Indicum, *Tamarind.*  
 Dialysis, *Osmose.*  
 Dialytic telescope, *Achromatic.*  
 Diamond, *Type, 609.*  
 Diamond Hill, *Boston.*  
 Diapason regulator, *(Supp.).*

Dibrachia, *Cephalopoda.*  
 Dichroism, *(Supp.).*  
 Dichuill, *Island.*  
 Dick, *Veterinary Medicine.*  
 Diego Ramares, *Andes, 239.*  
 Diepenvoer, *Overysel.*  
 Diet, *Sanitary Science (Supp.).*  
 Dieterich, *F. C. (Supp.).*  
 Dietrich of Bern, *(Supp.).*  
 Dieu et mon droit, *Glor.*  
 Diemenova, *Oder, Pomerania.*  
 Dican, *Mass.*  
 Difference engine, *Calculating Machine.*  
 Differential axle, *Windlass.*  
 Digby, *Sir Edward, Gunpowder Plot.*  
 Digena, *Trematoda.*  
 Digenes, *Reproduction, 199.*  
 Digging, *Gold, 816.*  
 Diamalli, *(Supp.).*  
 Diko, *Dyke.*  
 Dikova, *(Supp.).*  
 Dilem, *Perisa, 429, Samand Hill (r.), Nassau.*  
 Dilly, *Timor.*  
 Dillo (L.), *Zambot.*  
 Dilwara, *Abu (Supp.).*  
 Dim, *(Supp.).*  
 Dimidiation, *(Supp.).*  
 Dimorphodon, *Pterodactyl.*  
 Din, *Mohammedanism, 304, 306.*  
 Dinar, *Kuffic Coins.*  
 Dindigul, *(Supp.).*  
 Dimanara, *Monte, Sicily, 704.*  
 Diocles, *Anatomy, 224.*  
 Diocletianus, *(Supp.).*  
 Diogenes, *(Supp.).*  
 Diogenes of Babylon, *Stoic.*  
 Dioryssa, *Baccha.*  
 Diourina, *Colchis.*  
 Diopolis, *Anticon, Thabes.*  
 Diphe, *Shull, 759.*  
 Dip of the horizon, *Depression.*  
 Dipomania, *(Supp.).*  
 Diplocarpacens, *Dipteracea.*  
 Dipteryx odorata, *Tonka Bean.*  
 Dipteryx, *Parabola.*  
 Dirhams, *Kuffic Coins.*  
 Dirigent, *Conductor.*  
 Dia, *Rom. Relig. Anc. 302.*  
 Disant, *Decant.*  
 Discharge style, *Calico Printing, 515.*  
 Discharge with infamy, *Infamens Discharge.*  
 Diaco (L.), *Baffin's Bay.*  
 Discretion, *years of, Age.*  
 Discus, *Quoit.*  
 Disinfectants, *Sanitary Science (Supp.), 714.*  
 Devil's Bit, *Tippary.*  
 Diainfectant, *Everlasting, Aqua Regina.*  
 Devil's Lake, *Wisconsin.*  
 Dismembered, *Dremembrd.*  
 Disona (r.), *Vilno.*  
 Dispersion, *irrationality of, Refraction.*  
 Dismembered, *(Supp.).*  
 Dissection wounds, *(Supp.).*  
 Dissentia, *Rissa.*  
 Distaff, *Spinning, 46.*  
 Distance, *apparent, Vision, 82.*  
 Distend, *Cyanis.*  
 Distoma hepaticum, *Rot.*  
 Distomide, *Trematoda.*  
 Distortion, *Spira, Curvat. of.*  
 Ditchelling Beacon, *Dovna.*  
 Dittander, *Croze.*  
 Dives (r.), *Canadae.*  
 Dividers, *Compass.*  
 Dividing Range, *New South Wales.*  
 Divina Commedia, *Dante.*  
 Divirig, *(Supp.).*  
 Divis (mt.), *Belfast.*  
 Divot, *Red.*  
 Diyala, *Kurdistan.*  
 Dion, *Chlo-O'Or.*  
 Dizziness, *Vertigo.*  
 Djaferre, *Nubia.*  
 Djialal Eddin, *Perisian Lang. & Lit. 497.*

Djati, *Sambora, Sambour.*  
 Diggeret, *Daigretkai.*  
 Djinn, *Gemii.*  
 Djirihk (*r.*), *Tashkend.*  
 Djokjakarta, *Java (Suppl.)*, 380.  
 Djowabera, *Nubia.*  
 Dmitri, *Russia*, 385.  
 Dmitriev, *Russian Lang. & Lit.*  
 Dobbo, *Arru Islands.*  
 Dobchick, *Græbe.*  
 Doobundee, *Cabul.*  
 Dochart (*l.*), *Perthshire.*  
 Dochart (*r.*), *Tay.*  
 Docks floating, *Floating Docks (Suppl.)*  
 Dock-wall, *Retaining Walls.*  
 Doctor Seraphicus, *Bonaventura.*  
 Dodabeta, *Peak of, Ghauts.*  
 Dodekaskoinos, *Egypt*, 786.  
 Dodesa (*r.*), *Enarea.*  
 Doe, *Fallow Deer.*  
 Doesburgh, *(Suppl.)*  
 Döning-knife, *Carding of Cotton.*  
 Dog, edible, *Chinese Edible Dog (Suppl.)*  
 Dogberry, *Dogwood.*  
 Dogmatic school, *Medicine, History of.*  
 Dog-star, *Sirius.*  
 Dog-tailed baboon, *Cercopithecus.*  
 Dog-tooth spar, *Calcareous Spar.*  
 Dog-tooth violet, *Erythronium.*  
 Dokkum, *(Suppl.)*  
 Dolabella, *P. C. Rome*, 314.  
 Dolichocephalus, *Skull*, 760.  
 Dolina, *(Suppl.)*  
 Doll, *Pigeon Pea.*  
 Dollinger, *J. J. I. von, (Suppl.)*  
 Dolly-shop, *Pawnbroking.*  
 Dolo, *(Suppl.)*  
 Dombrek (*r.*), *Troy.*  
 Domes, *India*, 539.  
 Dömfrent, *Orme.*  
 Dominica, *America*, 205.  
 Dominica in Albis, *Albe, Quasimodo Sunday.*  
 Dominica, *Dominica.*  
 Dominium utile, *Superior.*  
 Don, *Don.*  
 Don (*r.*), *Tasmania*, 306.  
 Dona, *San, (Suppl.)*  
 Donald Bane, *Scotland*, 556.  
 Donaldson, *A. Book-trade*, 232.  
 Donato di B. Bardi, *Donatello.*  
 Donetz, *Don, Belgorod.*  
 Doniphan, *Kansas.*  
 Don Juan d'Austria, *John of Austria.*  
 Donnai (*r.*), *Saigon.*  
 Donogh, *Ireland.*  
 Doobelloo, *Dhalac.*  
 Doom-book, *Doom-book.*  
 Doopgezinden, *Anabaptists*, 219.  
 Doorba, *Cymodon.*  
 Doornik, *Tourney.*  
 Dora Baltes (*r.*), *Alpe, Aosta, Po.*  
 Dora Riparia (*r.*), *Po, Turin.*  
 Doras, *Callichthys.*  
 Dorchester, *(Suppl.)*  
 Dorchester Heights, *Boston.*  
 Doré, *P. G. (Suppl.)*  
 Dorema, *Ammoniacum.*  
 Doris Cove, *Gilbert Islands.*  
 Dorking fowl, *Fowl.*  
 Dormitor (*mt.*), *Montenegro.*  
 Doro Channel, *Andros (Suppl.)*  
 Dorog, *Haiducks (Suppl.)*  
 Dorstbranchiata, *Annelida.*  
 Dou, *Don.*  
 Double entry, *Book-keeping*, 277.  
 Double vision, *Sight, Defects of.*  
 Douglas pine, *Vancouver's Island.*  
 Douglass, *Fr. (Suppl.)*

Ellezelles, (Supp.)  
 Ellichpore, *Beyr.*  
 Ellis, A. J. *Phonetic Writing*, 500.  
 Ellis, W. (Supp.)  
 Elodea Canadensis, *Anacharis*.  
 Elohistas, *Pentateuch*, 383.  
 Elorn, *Finistère*.  
 El Pao, *Cumana*.  
 Elphin, *Roscommon*.  
 Elsler, F. (Supp.)  
 Elswick, *Gun Factories*.  
 Eltham Palace, *Hall*, 201.  
 El Ufian, *Algeria*, 140.  
 Elvas, *Aleméjo*.  
 Elvina, *Coruña*.  
 Elwick Bay, *Shapinsay*.  
 Elwy, *Denbighshire*.  
 Elytra, *Coleoptera*.  
 Els (r.), *Black Forest, Rhine*.  
 Embarras (r.), *Wabash*.  
 Ember goose, *Diver*.  
 Embiotocidae, *Viviparous Fish (Supp.)*.  
 Embolism, (Supp.)  
 Embossed printing, *Blind*, 157.  
 Embroid, *Imbrued*.  
 Embs (r.), *Nassau*.  
 Emerald, *Type*, 607.  
 Emeraldine, *Dye-stuffs*.  
 Emerita Augusta, *Spain*, 15.  
 Emetine, (Supp.)  
 Emeu wren, *Malurus*.  
 Emgedesic language, *Agades*.  
 Emir-ul-mumenin, *Morocco*.  
 Emmanuel Coll., *Cam. (Supp.)*.  
 Emmen, *Bern*.  
 Empirics, *Medicine, Hist. of*.  
 Empyrean air, *Oxygen*.  
 Enaima, *Zoology*, 357.  
 Encenia, *Commemoration (Supp.)*.  
 Encapsulation, *Infusoria*.  
 Encaustic, *Painting*, 191.  
 Encephalocoele, (Supp.)  
 Enchanter's nightshade, *Circæa*.  
 Enchondroma, (Supp.)  
 Encounter Bay, *South Australia*.  
 Encrome mineral, *Cappagh Brown*.  
 Encumbered Estates Court, *Incumbered Estates Court (Supp.)*.  
 Encysting, *Infusoria*.  
 Enderby, *Dampier Arch*.  
 Enderby's Land, *Antarctic Ocean*.  
 Endemic method of treatment, (Supp.)  
 Endophloeum, *Bark*.  
 Endopleura, *Seed*.  
 Endorsed, *Indorsed*.  
 Endosperm, *Albumen*.  
 Endrick (r.), *Stirlingshire*.  
 Endröd, (Supp.)  
 Energy, *Force*.  
 Energy, conservation, transformation, &c., of, *Thermodynamics (Supp.)*.  
 Enfield rifle, *Rifled Arms*.  
 Enfs (r.), *Aghmet (Supp.)*.  
 Enflourage, *Perfumery*, 397.  
 Engelhardtia, *Walnut*.  
 English, *Type*, 607.  
 English Harbour, *Antigua*.  
 English mercury, *Chenopodium*.  
 Engrossing, *Ingressing*.  
 Engraulis, *Anchorvy*.  
 Enhallow Sound, *Pomona*.  
 Enköping, *Maclar, L.*.  
 Enlistment, army, *War Services (Supp.)*.  
 Enna, *Castro-Giovanni*.  
 Ennistymon, *Clare*.  
 Ens, *Transcendental*.  
 Enschede, (Supp.)  
 Ensete, *Plantain*.  
 Ensign, *War Services (Supp.)*.  
 Entails, register of, *Records, Public, Registration of Deeds and Writs*.  
 Entomomya, *Blue-eye*.  
 Entre Rios, *Argentine Republic*.  
 Entrochites, *Beads, St Cuthbert's*.  
 Enz (r.), *Black Forest, Neckar*.  
 Enza, *Po*.  
 Enzie, *Banffshire*.  
 Eötvös, J., *Baron, (Supp.)*.  
 Epaceto, *Lepanto*.  
 Epencephalon, *Skull*, 761.  
 Eperva, *Wallaba Tree*.  
 Ephedra, *Sea-grape*.  
 Ephelia, *Macula*.  
 Ephyre, *Corinth*.  
 Epidaurus, *Ragus*.  
 Epidemic cerebral meningitis, (Supp.)  
 Epigynous, *Stamen*.  
 Epilatories, *Defilatories*.  
 Epimachus, *Plume-bird (Supp.)*.  
 Epiphegus, *Cancer-root*.  
 Epiphloeum, *Bark*.  
 Epiphysia, *Osification*.  
 Episcopal Church, *American, Anglo-Catholic Church*, 259.  
 Episperm, *Seed*.  
 Epistaxis, *Nostrils, Dis. of*.  
 Epistle, the, *Lesson (Supp.)*.  
 Equations, polar, *Radius*.  
 Equilibrium, *Statics*.  
 Equilibrium, stable, *Stability*.  
 Equinia, (Supp.)  
 Equites, *Equestrian Order, Legion*.  
 Equivalent number, *Triads*.  
 Equivocation, *Reservation*.  
 Eradicated, *Erased*.  
 Erasistratus, *Medicine, Hist. of*.  
 Erastianism, *Erastus*.  
 Erbia, *Yttrium*.  
 Erbil, *Arbela*.  
 Erclidoune, *Earlston, Rhymer*.  
 Ericilla y Zubiga, *Alonso de, Spanish Lang. & Lit.* 20.  
 Ercmann, E. E. (Supp.)  
 Erdre (r.), *Nantes*.  
 Erebus (mt.), *Antarctic Ocean*.  
 Eredia, *Costa Rica*.  
 Erema (r.), *Segovia*.  
 Ergent (r.), *Albania*.  
 Ergios (r.), *Basel*.  
 Eria, *Silk & Silkworm*, 724.  
 Erich Edmundo, *Sweden*, 238.  
 Eridanus, *Po*.  
 Erie Canal, *Buffalo*.  
 Erigal, *Donagel*.  
 Eriodendron, *Razor-strop*.  
 Erisort (L.), *Lewis-with-Harris*.  
 Eristalis, *Rat-tail Maggot*.  
 Erlenbach (r.), *Zabern*.  
 Erlitz (r.), *Bohemia*, 189.  
 Erme, *Dartmoor*.  
 Ernée (r.), *Mayenne*.  
 Ernst, H. W. (Supp.)  
 Erotemata, *Lascaris*.  
 Errocht, *Ericht*.  
 Erromango, *New Hebrides*.  
 Eryum, *Tarr*.  
 Erythaca, *Blue Bird, Red-breast*.  
 Erythron dorsatum, *Urson*.  
 Erythrae, *Ionis*.  
 Esaro, *Cotond*.  
 Escambia (r.), *Florida*.  
 Eschweiler, (Supp.)  
 Escocido, *Nicaragua*.  
 Escrow, *Execution of Deed*.  
 Escuage, *Scutage*.  
 Escuintla, *Esquintla (Supp.)*.  
 Esdraillon, *Carmel*.  
 Esdud, *Aotus*.  
 Esemi, *Persian Lang.* 427.  
 Esk, *Cumberland*.  
 Eskar, (Supp.)  
 Eskdale Muir, *Esk*.  
 Eski-Hissar, *Ladicea*.  
 Esparsa, *Costa Rica*.  
 Esparto, *Murcia*.  
 Espinosa, *battle of, Victor*.  
 Espiritu Santo, *New Hebrides*.  
 Esquiline Hill, *Rome*, 322.  
 Esquintla, (Supp.)  
 Es Saïd, *Egypt*, 787.  
 Essences, (Supp.)  
 Estats (mt.), *Arige*.  
 Esterlings, *Sterling*.  
 Esthwaite (L.), *Windermerre*.  
 Estienne, *Stephens*.  
 Estrella, *Costa Rica*.  
 Eswan, *Assoman*.  
 Eteocles, *Antigone, Oedipus*.  
 Etesian winds, *Wind*, 215.  
 Ethbaal, *Phanicia*, 493.  
 Ethelred, *England*, 59.  
 Ether, *Quintessence*.  
 Etherow (r.), *Glossop (Supp.)*.  
 Ethiopian pepper, *Guinea Pepper*.  
 Ethyl sulphate of, *Sulphuric Ether*.  
 Ethylene, *Alcohol (Supp.)*, 384.  
 Etruscan language, *Etruria*.  
 Etruscans, *Rome*, 307.  
 Ettrick Pen, *Dumfriesshire*.  
 Etzel, *Attila*.  
 Eucaly, *Sugar*, 187.  
 Eudoxia, *Alexei Petrowitch*.  
 Eudoxia, *Rome*, 321.  
 Eulachon, *Candle-fish (Supp.)*.  
 Eulophia, *Salop*.  
 Eumenides, *Wasp*.  
 Euphodie, *Trap*.  
 Euphorion, *Alexandrine Age*.  
 Eupomus, *Painting*, 191.  
 Euptea humata, *Butterfly*.  
 Eureka, *Archimedes*.  
 Euric, *Spain*, 16.  
 Europa Point, *Gibraltar*.  
 European lotus, *Date Plum*.  
 Eurydice, *Orpheus*.  
 Euscaldunac, *Basque Prov.*.  
 Euscaleria, *Basque Provinces*.  
 Euscara, *Basque Provinces*.  
 Eustrongylus, *Strongylus*.  
 Eustyle, *Intercolumniation*.  
 Eutychnus, *Arabian Lang. & Lit.* 347.  
 Evans, Mr, *Welsh Lang. & Lit.* 137.  
 Evans, Miss M. A. (Supp.)  
 Eve or Even, *Vigil*.  
 Eventuality, *Phrenology*, 577.  
 Everest (mt.), *Himalaya*.  
 Evergreen oak, *Ilex*.  
 Ewe (r.), *Marve (L.)*.  
 Exalbuminous, *Albumen*.  
 Exchange, bill of, *Bill of Exchange*.  
 Excision of joints, *Resection of Joints*.  
 Excluded middle, *Identity*.  
 Excrementitious products, *Secretion*.  
 Exequatur, *Consul, Mercantile*.  
 Exequatur, *Placetum Regium*.  
 Exercise, *Sanitary Science (Supp.)*.  
 Exergue, *Numismatics*, 1.  
 Exhibitions, industrial, (Supp.)  
 Exidium, *Jew's Ear (Supp.)*.  
 Exostosis, *Osification*.  
 Extine, *Vegetable Physiology*, 735.  
 Extract of flesh, *Soup*.  
 Extrados, *Arch*, 366.  
 Exuma, *Bahamas*.  
 Eyder, *Denmark*.  
 Eye (r.), *Berwickshire*.  
 Eyemouth, *Berwickshire*.  
 Eyeo, *Katunga (Supp.)*.  
 Eyes, *Mining*.  
 Eyess, *Falconry*, 228.  
 Eylkhanians, *Persia*, 423.  
 Eynort, *Loch, Uist*.  
 Eyre, *Eire*.  
 Eyre, E. J. (Supp.)  
 Eyub, *Constantinople*.  
 Eyun, *Wahabie*, 41.  
 Eziongeber, *Edom, Red Sea*.  
 Ezra, *Pentateuch*, 382.  
 Faale, *Alhaurin el Grande (Supp.)*.  
 Fabrizio, *Fabricius, Girolamo*.  
 Fachingen, *Nassau*.  
 Facial angle, *Ethnology*.  
 Factory Acts, (Supp.)  
 Faculty to burden, *Appointment*.  
 Fagopyrum, *Buckwheat*.  
 Faham, *Faam*.  
 Fahlun, *Falun*.  
 Fair Isle, (Supp.)  
 Fairway, *Diomed Islands*.  
 Fairy pipes, *Tobacco-pipes*.  
 Fal (r.), *Cornwall*.  
 Falaise, treaty of, *William the Lion*.  
 Falashas, *Abyssinia*.  
 Falcon, J. Ch. *Venezuela*.  
 Fall (r.), *Oregon*.  
 False acacia, *Locust Tree*.  
 False calabash, *Bottle-gourd*.  
 False decretals, *Isidorian Decretals*.  
 Falsetto voice, *Voice*.  
 Famagosta, *Cyprus*.  
 Family of Love, *Agapemones*.  
 Fan, *Blowing-machines (Supp.)*, 429.  
 Fanad Point, *Swilly*.  
 Fancy franchises, *Reform (Supp.)*.  
 Fane, *Dumalk, Louth*.  
 Fanners, *Blowing-machines (Supp.)*, 429.  
 Faradisation, *Tabes Dorsalis*.  
 Farcy, *Eguntia (Supp.)*.  
 Fardingale, *Crinoline*.  
 Fario, *Salmon*, 445.  
 Farmworth, (Supp.)  
 Faro, *Benué*.  
 Faro, Capo del, *Sicily*, 704.  
 Farragut, D. G. (Supp.)  
 Faristan, *Fars*.  
 Fasa, *Fesa*.  
 Fasting-tide, *Shroove-tide*.  
 Fast-mass, *Shroove-tide*.  
 Fat glands, *Skin*, 756.  
 Fauna, arctic, tropical, &c. *Geographical Distribution of Animals*.  
 Faunus and Fauna, *Roman Religion, Ancient*, 302.  
 Faustrecht, *Golden Bull*.  
 Faustus, Bishop of Riez, *Semi-pelagianism*.  
 Fawer, Valley of, *Sawoy*.  
 Fawn, *Fallow Deer*.  
 Fayence, *Faïence*.  
 Feale (r.), *Shannon*.  
 Fear, *Emotion*.  
 Fearné, *Ferne Isles*.  
 Featherfoil, *Hottonia*.  
 Feathering, *Oar*.  
 Fecht, *Colmar*.  
 Fechter, C. A. (Supp.)  
 Federalists, *Republican, U.S.* 655.  
 Ferdsee, *Württemberg*.  
 Feeders, *Mining*.  
 Feejee, *Fiji Islands*.  
 Felaniche, (Supp.)  
 Feldberg, *Black Forest*.  
 Fellows, *University*, 664.  
 Felsina, *Bologna*.  
 Feme Sole, *Feme Coverts*.  
 Fenian Society, (Supp.)  
 Fens, *Middle Level (Supp.)*.  
 Fen Town, *Finsbury*.  
 Feodor, *Romanoff, House of*.  
 Feral races, *Wolf*, 243.  
 Fer de Moulin, *Millrind*.  
 Ferdinand III. of Castile, *Spain*, 27.  
 Fergal, *Ireland*.  
 Fergus, *Scotland*, 555.  
 Fergus (r.), *Shannon*.  
 Ferid Eddin Attar, *Persian Lang. & Lit.* 427.  
 Ferishtah, *Persian Lang. & Lit.* 428.  
 Ferment, *Wine*, 221.  
 Fern Isles, *Ferne Isles*.  
 Fernandina, *Cuba*.  
 Fernando de Noronha, (Supp.)  
 Fernand Vas (r.), *Ogobai (Supp.)*.  
 Ferney, *Voltaire*.  
 Ferolia Guianensis, *Satin-wood*.  
 Ferozabad, (Supp.)  
 Ferrari, Ludovico, *Algebra*.  
 Ferreo, Scipio, *Algebra*.  
 Feruchi, *Persian Lang. & Lit.* 427.

Ferula, *Carotigeron* s. *St.*  
Ferulea, *Ammanniacum*.  
Fervencia (r.), *Broganum*.  
Fesch, Jos. (Supp.)  
Fesq, *Dev.*  
Fesules, (Supp.)  
Fever, relapsing, *Relapsing Fever*.  
Fever, remittent, *Remittent Fever*.  
Fever, rheumatic, *Rheumatism*.  
Fever, scarlet, *Scarlatina*.  
Fever-bush, *Bonoin*.  
Feyul, *Wahabie*, sp.  
Fex, *Morocco*.  
Fibre-plating, *Goldlac*.  
Fibro-muscular tissue, *Vascular Tissue*.  
Fibrous tumour, *Womb, Diseases*, &c. of, 251.  
Fibula, *Foot*, 409.  
Fichtelgebirge, *Main*.  
Fidaria, *Atolia*.  
Field, C. W. (Supp.)  
Field-glass, *Opera-glass*.  
Field-rush, *Luzula* (Supp.)  
Fier (r.), *Sawey*.  
Fife, Earl of, *Stewart Family*, 123.  
Fifer, *War Services* (Supp.)  
Fighine, *Fighine* (Supp.)  
Fighine, (Supp.)  
Figueira, (Supp.)  
Figues-conques, *Data Plum*.  
Figure, *Sylogism*.  
Filadelfia, (Supp.)  
Filament, *Stamen*.  
Filaria hominis bronchialis, *Strongylus*.  
Filaria piscium, *Spiroptera*.  
Filature, *Silk & Silkworm*, 705.  
File, *Label*.  
File-fish, *Balister*.  
Filinia marble, *Philippovilla*.  
Filla, *Malta*.  
Fihota, *Mut*.  
Filtmore, *Utah*.  
Finales, (Supp.)  
Fine, *Repat*.  
Fines and Recoveries, *Fine of Land, Records, Public*.  
Fin-fish, *Royalty*.  
Fingering, *Salmon*, 447.  
Fingueria, *Bengrowing*, 69.  
Finlay (r.), *Columbia, British*.  
Finnan haddock, *Haddock*.  
Finow Canal, *Germany*, 718.  
Finsterberg (mt.), *Thuringerwald*.  
Fiorentino, *Italy*, 657.  
Fiorenzuola, (Supp.)  
Firebold, (Supp.)  
Fire-backed pheasant, *Macartney Cock*.  
Fireballs, *Asterites*.  
Fire-draught, *Warming & Ventilation*, 68.  
Fire-flare, *Siting Ray*.  
Firewood, *Senecio*.  
Fire-worship, *Sun & Fire Worship*.  
Firmity, (Supp.)  
Firos, (Supp.)  
Firm-fruits (in law), *Amatois*.  
Firth of Lorn, *Colony*.  
Fish-culture, *Pisciculture*.  
Fish-berry, *Musselburgh*.  
Fishes, showers of, *Showers of Fishes*.  
Fishguard Bay, *Pembroke-shire*.  
Fishing, (Supp.)  
Fishing eagle or hawk, *Osprey*.  
Fish-ladders, *Salmon*, 446.  
Fish-maws, *Mango Fish*.  
Fish-plate, *Railways*, 88.  
Fish salamander, *Batrachia*.  
Fish-skin disease, *Ichthyosis*.  
Fish-stairs, *Salmon*, 446.  
Fissiparus multiplication, *Reproduction*, 195.  
Fissure of the anus, *Anus* (Supp.)  
Fistula lachrymalis, *Lachrymal Organ*.

Fitz-weet, *Lyryng*.  
Fitz-alan, *Stewart Family*, 123.  
Fitzroy (r.), *Queensland*.  
Fiumara, *Pisane*.  
Fiumicino (r.), *Rubicon*.  
Five-day fever, *Relapsing Fever*.  
Five fingers, *Star-fish*.  
Flaccus Albius, *Alwin*.  
Flag, *War Services* (Supp.)  
Flagellum, *Ranunc*.  
Flagstade, *Lofoen*.  
Flaiah, *Counts do*, (Supp.)  
Flail, *Thrashing*.  
Flammingo, *Dionisio, Calvert*.  
Flan of Monasterboice, *Irick Lang*, & *Lit*, 630.  
Flanques, *Planches*.  
Flap operation, *Amputation*.  
Flashed glass, *Glass*, 78a.  
Fleabane, *Corymb*.  
Fleawort, *Plantaginina*.  
Fleche, *Fortification*, 444.  
Fleetwood, *War Services* (Supp.)  
Flemingites, *Sigillaria*.  
Flies artificial, *Angling*, 256.  
Flinders (r.), *Queensland, Australian Explorations* (Supp.), 412.  
Flint (r.), *Tennessee*.  
Flittermouse, *Bat*.  
Flix-weed, *Hedge-mustard*.  
Floating docks, (Supp.)  
Floating gardens, *Floating Islands*.  
Floating mattress, *Water-bed*.  
Floating sweet meadow grass, *Manna Grass*.  
Floating warehouses, (Supp.)  
Flora, *Lodru*.  
Flora, *Azore*.  
Florets, *Flower*.  
Florida, (Supp.)  
Floripendio, *Thorn-apple*.  
Flos Adonis, *Adonis*.  
Floscularia, *Rotatoria*.  
Flotation, *Hydrostatics*, 490.  
Flote fescue, *Manna Grass*.  
Flotow, Fr. von (Supp.)  
Flower City, *Springfield*.  
Flowering fern, *Osmunda*.  
Flowering rush, *Butomus*.  
Flowers of arsenic, *Arsenious Acid*.  
Flowers of sulphur, *Sulphur*, 192.  
Flowk-wort, *Hydrocotyle*.  
Fluke, *Fleander*.  
Flunk, *Flinders*.  
Flushing, *Long Island*.  
Flushing, *Pistularia*, 356.  
Fly agaric, *Amanita*.  
Fly-fishing, *Angling*, 257.  
Flying fox, *Flying Lemur*.  
Flying opossum, *Flying Phalanger*.  
Foeniculum Capense, *Umbellifera*.  
Foggie, *Humble Bee*.  
Fogo, *Cape Verd Islands*.  
Fokshany, *Sovors*, (Supp.)  
Folio, *Book*, 225.  
Folkland, *Saxony*, 514.  
Follicle, *Glands*.  
Follicle, *Legume*.  
Folquet de Marseille, *Troubadour*.  
Fonka, *Cape, Cos*.  
Fontaine, *Algiers*.  
Fontainebleau, *Romissance*.  
Fontange (mt.), *Ariège*.  
Foot, *Heem*.  
Food, (Supp.), *San. Science* (Supp.), 720.  
Foramen magnum, *Spinal Cord*.  
Forbes, *Lough, Shannon*.  
Forecastle, *Fore*.  
Forefang, *Forfang*.  
Forest Courts, *Forest Laws*.  
Forest Ridge, *Sussex*.  
Forest wool, *Pine*.  
Form, *Type*, 609.  
Formartin, *Aberdeenshire*.

Fort Dauphin, *Madagascar*.  
Fort du Quene, *U.S.*, 653.  
Forteviot, *Scotland*, 285.  
Forth (r.), *Tasmania*, 306.  
Fort Hope, *Columbia, British*.  
Fort Madison, *Iowa*.  
Fort Moultrie, *Sumter, Fort*.  
Fortunate Islands, *Phoenicia*, 499.  
Fortune Bay, *Newfoundland*.  
Fortune, *Robert*, (Supp.)  
Fort Wayne, *Indiana*, (Supp.)  
Fort William, *California*.  
Fossil alkali, *Sodium*, 801.  
Fouets, *Homer-lark*.  
Foula, (Supp.)  
Fount, *Bill of Health*.  
Foumart, *Polcat*.  
Fourchambout, (Supp.)  
'Four Lads', the, *Bergendoy* (Supp.)  
Fous, *Homer-lark*.  
Fousel-oil, *Fusel*.  
Foveaux Strait, *New Zealand*.  
Fovilla, *Vegetable Physiology*, 735.  
Foxting, *Beer*, 809.  
Fox-tailed monkey, *Sabb*.  
Foy, *France*.  
Foyers, *Theatre*, 388.  
Foynes, *Limerick, Shannon*.  
Fraga, (Supp.)  
Fraises, *Fortification*, 440.  
Frambocasia, *Yew*.  
France, education in, *National Education* (Supp.)  
Franchise, *Parliament*, 283.  
Reform (Supp.)  
Frankenburg, *Aix-la-Chapelle*.  
Frankenwald (mt.), *Thuringerwald*.  
Franklin (mt.), *White Mts*.  
Frachellon, *Awe L*.  
Fra Paolo, *Sargi*.  
Frasers County, *Inverness-shire*.  
Frauds, statute of, *Statute of Frauds*.  
Frederick-August I. and II., *Saxony*, 515.  
Frederick-Charles, *Prince*, (Supp.)  
Frederick City, (Supp.)  
Fredericksburg, *Sweden*, 237.  
Fredericksburg, *Africa*, 66.  
Fredericksburg, *Virginia*, (Supp.)  
Frederickssoord, *Drenth, Pauper Colonies*.  
Frederick the Wise, *Saxony*, 515.  
Frederick-William, *Prince*, (Supp.)  
Frederikshavn, *Copenhagen*.  
Free livers, *Perfectionists* (Supp.)  
Free-soil Democrats, *Republican*.  
Free-stone Party, *U.S.*, 658.  
Free-stones, *Peach*.  
Frégate (r.), *Seychelles Is.*  
Fregenal de la Sierra, (Supp.)  
Freiberg, battle of, *Seven Years War*, 637.  
Freitra, (Supp.)  
Fremont's Basin, *Great Basin*.  
Fremont's Peak, *Rocky Mts*.  
French chalk, *Steatite*.  
French pie, *Woodpecker*.  
French rye-grass, *Arrhenatherum*.  
French willow, *Epilobium*.  
Freshford, *Kilkenny*.  
Freshman, *Cambridge University*, 531.  
Fresh-water polype, *Hydra*.  
Fresh-water shrimp, *Gammarus*.  
Fresnillo, (Supp.)  
Freudenstadt, (Supp.)  
Freycinet's Peninsula, *Tasmania*, 306.  
Freystädte!, (Supp.)  
Fribourg, *Pruburg*.  
Friction-wheels, *Friction*.

Fructification, *Fructe*, 1.  
Alexander I. of Russia.  
Friedrichs-stadt, *Leipzig*.  
Friedrich-Wilhelm's (mt.), *Germany*, 718, *Spain*.  
Frigga, *Prozia*.  
Fringilla spinus, *Aberdeen*.  
Frio, *Nicaragua Lake*.  
Frio, *Cape, Rio de Janeiro*.  
Frit, *Glass*, 774.  
Fritih, *Reformation*, 19.  
Fritigen, *Valais*.  
Frog-ty, *Frucht*.  
Frog-hopper, *Frucht*.  
Frog-spittle, *Frucht*.  
Froude, R. H. *Tractarianism*.  
Fruit-sugar, *Frucht*.  
Fuschine, *Dy-stuff*.  
Fucus vesiculosus, *Alga*.  
Fuente Alamo, (Supp.)  
Fuertes, *Count of, Azori*.  
Fuerte, (Supp.)  
Fuerte de Andalgalá, (Supp.)  
Fuhl, *Honan*.  
Fu-kian, *Pak-han*.  
Fulgentius, *Semi-paganism*.  
Fulham, *Convent*.  
Fulmar, *Polcat*.  
Fulling, *Woolen & Worsted Manufacture*, &c.  
Fullness of blood, *Condition of Blood*.  
Fulwa tree, *Bania*.  
Furniture, common, *Furniture*.  
Funaria, (Supp.)  
Funcha, *Begonia*.  
Fünfhaus, (Supp.)  
Fung, *Pine*.  
Fungus, *Naghi*.  
Fungic acid, *Fungi*.  
Fungus medicum, *Cannarium*.  
Fungus salicis, *Amada*.  
Funiculus, *Sed*.  
Funny bone, *Brachial Artery*.  
Furnace, reverberatory, *Reverberatory Furnace*.  
Furnarius, *Omnivori* (Supp.)  
Furness, *Lancashire*.  
Fur seal, *Oleary*.  
Fusaro (r.), (Supp.)  
Fusible alloy, *Alumina*.  
Fusia, *Lact*.  
Fusiyama, *Japan*.  
Fustic, young, *Sassa*.  
Futteh-Ali, *India*, 125.  
Futtlecks, *Ship-building*, 83.  
Futwa, *Futwa*.  
Fyrd, *Teutonic Nations*.  
Fytte, *Rhapsodie*.  
Gabi, *Roma*, 324.  
Gachus, *Guthrie*.  
Gachus, *Ottobrunn*.  
Gadajoz, *Comalapat*.  
Gaddi, *Taddeo, Painting*, 192.  
Gadenolite, *Potrium*.  
Gades, *Castra*.  
Gadetic, *Carlic Lang & Lit*.  
Gadjath, (Supp.)  
Gaga, *Kidney-stone*.  
Gagali, *Pak-carym*.  
Gagea, *Star of Bethlehem*.  
Gaisin, (Supp.)  
Galam butter, *Bania*.  
Galates, *grotes of, Ad-Rak*.  
Galaxias, *Salmonidae*.  
Gallegos, *Lisbon*.  
Galenists, *Anachoretic*, 209.  
Galeus canis, *Tape*.  
Galgacus, *Arctica*, C. J.  
Galigos, *Peripatetic* (Supp.)  
Galissae, *Rubiacae*.  
Galileans, *Yemish Sect*.  
Galipot, *Roma*.  
Gall, *James, Sunday School*.  
Gallanda, *Calli St. Constantine*.  
Gallarate, (Supp.)  
Gallstock, *Paint*.  
Gallstones, *Gallstone*.  
Galleys, *Type*, 624.  
Gallia Belgica, *Belgium*, 4

Gallia, (Supp.)  
 Gallianism, *Gallian Church*, 386.  
 Gallinago, *Snipe*.  
 Gallinazo, *Vulture*.  
 Gallinsecta, *Cecoco*.  
 Gallitain, *Galathea*.  
 Galloway breed, *Ox*.  
 Galloway, Earls of, *Stewart Family*, 195.  
 Gallus, *Ireland*, 666.  
 Gally-worms, *Yalus*.  
 Galofaro, *Scylla & Charop*.  
 Galoshes, *Galoshes*.  
 Galston, *Ayrshire*.  
 Galtees (mt.), *Tipperary*.  
 Galvanic pair, *Galvanism*, 994.  
 Galvanometers, *Galvanism*, 601.  
 Gal-wihara, *Ceylon*, 739.  
 Galtant, *Abyssinia*.  
 Gamber, *Gambir*.  
 Gambet, *Sandpiper*.  
 Gambetta, *Yellowlegs*.  
 Game-licences, *Game*.  
 Gamagee, John, *Veterinary Medicine*.  
 Gaming, *Gambling*.  
 Gamble-by, *Copenhagen*.  
 Gamble, *Banffshire*.  
 Gamtoos, *Camtoos*.  
 Ganger Rolf, *Harald I.*  
 Gangli, (Supp.)  
 Gangrene of the mouth, *Mouth*.  
 Gangs, agricultural, (Supp.)  
 Ganguo, (Supp.)  
 Gan-king-foo, *Gan-hway*.  
 Gansfort, *Wessel*.  
 Gapau (r.), *Var*.  
 Garagantua, *Rabelais*.  
 Garay, B. de, *Steam-engine*, 97, *Siam-navigaton*.  
 Garcia de la Huerta, *Spanish Lang. & Lit.*, 80.  
 Garcinia, *Cocum Oil* (Supp.)  
 Garden Island, *Buache*.  
 Gardeners' garters, *Canary Grass*.  
 Garden warbler, *Brecaflco*.  
 Gare (L.), *Dumbrintonshire*.  
 Garioch, *Aberdeenshire*.  
 Garlic, crow, *Allium*.  
 Garnet, pyramidal, *Peninsular*.  
 Garrock, *Ayrshire*.  
 Garou bush, *Daphna*.  
 Garreg, *Flintshire*.  
 Garroque (r.), *Sligo*.  
 Garry, Glen, *Inverness-shire*.  
 Garry (r.), *Tay*.  
 Gartan, *Columbia*.  
 Gartempe (r.), *Vienne*.  
 Garum, *Anchorovy*.  
 Garvock, *Kincardineshire*.  
 Gaseng, *Koc*.  
 Gas-engine, (Supp.)  
 Gas-lighting, railway, (Supp.)  
 Gasten, treaty, *Germany* (Supp.), 532.  
 Gasterosteus, *Stickleback*.  
 Gastrodynia, *Gastralgia*.  
 Gastro-entertia, *Gastritis*.  
 Gastropoda, *Gasteropoda*.  
 Gatehouse, *Kirkcudbrightsh.*  
 Gath, *Philistines*.  
 Gatun, Plateau de, *Vende, La.*  
 Gatto, Cape, *Cyprus*.  
 Gau, *Pyrenees, Basses*.  
 Gaudens, St., *Geneve*.  
 Gaulanites, *Jewish Sects*.  
 Gauls, *Celtic Nations, Rome*, 307.  
 Gaultheric acid & gaultheri-  
 lene, *Winter Green, Oil of*.  
 Gauntlet, *Castlet*.  
 Gavarnie Falls, *Waterfall*.  
 Gavra, battle of, *Foman Society* (Supp.).  
 Gawler (r.), *South Australia*.  
 Gay-Lussac's Law, *Atrostatics*.  
 Gayndah, *Queensland*.  
 Gaze, *Phenicia*, 491.  
 Gaze, battle of, *Selim I.*  
 Ge, *Gaea*.  
 Geas, *Cherry*.  
 Gebatsch (mt.), *Tyrol*.  
 Gedronia, *Belochistan*.  
 Geelviuk Bay, *Papua*, 250.  
 Geer, Cape, *Blanco*.  
 Geilman, *Nassau*.  
 Gelatine, sugar of, *Glyster*.  
 Gelders, duchy of, *Rhenish Prussia*.  
 Gelimer, *Vandals*.  
 Gell-ale, *Ground-ivy*.  
 Gelya, *Cambay*.  
 Gemmiparous generation, *Gemmation*.  
 Gemmi Pass, *Alps, Valais*.  
 Gemmula, *Seed*.  
 Gemoma, (Supp.)  
 Generationism, *Traducianism*.  
 Genivre (mt.), *Alps*.  
 Genipi & Genapp, *Achilles*.  
 Genzano, *Genoa* (Supp.)  
 Genzonné, *Gironnolats*.  
 Genzano, (Supp.)  
 Geometers, *Caterpillar*.  
 Geophilus, *Cottigede*.  
 Geordie lamp, *Safety-lamp*.  
 George Eliot, *Evans* (Supp.)  
 George of Denmark, Prince, *Anne, Queen*.  
 George's Town, *Biafra*.  
 Georgetown, *Delaware*.  
 Georgetown, Pr. Edward's I.  
 Georgetown, Pr. of Wales I.  
 Georgina, *Daklia*.  
 Geophyes, *Worms, egg*.  
 Geraniacae, (Supp.)  
 Geranium, oil of, *Grass Oil*.  
 Geranium maculatum, *Alum Root*.  
 Gerard, Balthasar, *William, Prince of Orange*.  
 Gère (r.), *Vienne*.  
 German acacia, *Sloe*.  
 German carp, *Crucian*.  
 German catfish, *Lychotis*.  
 German greens, *Kale*.  
 German rice, *Barley*.  
 Germanstown, *Pennsylvania*.  
 Germany, (Supp.)  
 Gernersheim, (Supp.)  
 Gerome, J. L. (Supp.)  
 Gerrag, *Guatemala*.  
 Ghadames, *Gadames*.  
 Ghagra, *Ghagra, Oude*.  
 Ghardaia, *Gardania*.  
 Ghazel, *Ghael*.  
 Ghobres, *Gobres*.  
 Ghent, pacification of, *Wil-  
 liam, Prince of Orange*.  
 Gherkins, *Cucumber*.  
 Ghetto, *Rome*, 323.  
 Ghore, *Ghar*.  
 Ghori (r.), *Andrab* (Supp.)  
 Ghosts, optical, (Supp.)  
 Ghurkas, *Nepaul*.  
 Giacomo da Ponte, *Bassano*.  
 Giarre, (Supp.)  
 Giarretta (r.), *Sicily*, 704.  
 Gibbe (r.), *Enarna*.  
 Gibing, *Cybing*.  
 Gibson, *Veterinary Med.*  
 Giczin, *Gitschin* (Supp.)  
 Gid, *Sturdy*.  
 Gien, *Loiret*.  
 Gier-eagle, *Lammergeier*.  
 Gig, *Boat, Boating*.  
 Gig-mill, *Woolen & Wor-  
 sted Manufacturers*, 265.  
 Gigueta, *Guadiana*.  
 Gilbert de la Porrée, *Scholastics*.  
 Gilge (r.), *Niemen*.  
 Gill (L.), *Sligo*.  
 Gill John, (Supp.)  
 Gill-ale, *Ground-ivy*.  
 Gillespie, Thomas, *U.P.C.*, 646.  
 Gillot, Joseph, *Pen*.  
 Gills, *Hickles*.  
 Gills, (Supp.)  
 Gillyflower, *stock, Stock*.  
 Gimignano, *Sao*, (Supp.)  
 Gimmel, *King*.  
 Gimona, *Gere*.  
 Ginneling, *Fishing* (Supp.)  
 Giorgio Barbarelli, *Giorgioni*.  
 Giovanni di Bologna, *Sculpt-  
 ure*, 577.  
 Giovanni (San) in Fiore, (Supp.)  
 Gipsy herring, *Pilchard*.  
 Giraffe (r.), *Nile*.  
 Girard, *Algebrs*.  
 Girard College, *Philadelphia*.  
 Girouette, *Ept*.  
 Gitanos, *Cypriots*, 170.  
 Gitschin, (Supp.)  
 Gizeh, *Gizeh*.  
 Gizard, *Birds*, 109.  
 Glacé, *Taffety*.  
 Gladbach, (Supp.)  
 Glade-net, (Supp.)  
 Gladova, (Supp.)  
 Gladheim, *Walkalla*.  
 Glanders, *Egmania* (Supp.)  
 Glandford Brigg, (Supp.)  
 Glasnevin, *Agricultural Edu-  
 cation*, 684.  
 Glass, earliest use of, in Eng-  
 land, *Benadict Biscop* (Supp.)  
 Glass-snake, (Supp.)  
 Glasbury thorn, *Hawthorn*.  
 Glatt (r.), *Zürich*.  
 Glead, or Gled, *Kite*.  
 Glect, *Conorrhans* (Supp.), 544.  
 Glem (r.), *Bedford Level*.  
 Glendalough, *Wicklow*.  
 Glendalure, *Wicklow*.  
 Glenelg, *Inverness-shire*.  
 Glenelg (r.), *Victoria*, 785.  
 Glenelg, Lord, *Grant, Ch.* (Supp.)  
 Glenever, *Vitristed Fort*.  
 Glengariff, *Bantry Bay*.  
 Glen Garry, *Inverness-shire*.  
 Glen Morriston, *Inverness-sh.*  
 Glen Ness, *Doon*.  
 Glenaboe, *Perthshire*.  
 Glen Urquhart, *Inverness-shire*.  
 Gliadin, *Gluten*.  
 Globe animalcules, *Monad*.  
 Globe-fish, *Diodon*.  
 Globiocephalus, *Casain Whale*.  
 Giobules, *Homonopathy*, 401.  
 Giomach, Fall of, *Ross & Cromarty*.  
 Glommen, *Norway*.  
 Glonoin, *Nitro-glycerine* (Supp.)  
 Glory, *Halos*, 206.  
 Glory, *Nimbus*.  
 Gloesmia morsitans, *Tacter*.  
 Glossitis, *Tongue*.  
 Glossop, (Supp.)  
 Gloucester nut, *Hickory*.  
 Glover, Miss, *Tonic Solfa*.  
 Glover's roll, *Roll of Arms*.  
 Glue, liquid, marine, &c. *Co-  
 ments*.  
 Gluten, *Gelatigenous Tissues*.  
 Glycinium, *Glucinum*.  
 Glycocine, glyccocol, *Glycine*.  
 Glycosides, *Salicin*.  
 Glyde (r.), *Louth*.  
 Glykys (r.), *Albania*.  
 Gmelina, (Supp.)  
 Gmunjen, (Supp.)  
 Gnidia, *Thymelaeae*.  
 Gnidoe, *Cnidus*.  
 Goat's beard, *Fungit*, 558.  
 Godfrey, *Gottfried*.  
 Godounof, Boris, *Russia*, 386.  
 Godrun, *Alfred*.  
 God's gift, *Dutch College*.  
 Goenang Api, *Moluccas*.  
 Goersee, *Holland, South*.  
 Goes, Hugo Vander, *Painting*, 292.  
 Goetz von Berlichingen, *Arti-  
 scial Limbs* (Supp.)  
 Goff, *Golf*.  
 Goggra, *Oude* (city).  
 Gohanuh, (Supp.)  
 Gohfeld, battle of, *Sveon Year's War*, 636.  
 Goito, battle of, *Radetzky*.  
 Gold, extraction by sodium amalgams, (Supp.)  
 Goldberg, (Supp.)  
 Golden Age, *Agas, Pastoral Poetry*.  
 Goldea carp, *Goldfish*.  
 Golden charter, *Transylvania*.  
 Golden Gate, *San Francisco*.  
 Golden Horn, *Constantinople*.  
 Golden Plain, *Nordhausen*.  
 Golden maidenhair, *Polytri-  
 chum* (Supp.)  
 Golden-tailed flies, *Chryala*.  
 Golden Vale, *Limerick*.  
 Golden Vein, *Tipperary*.  
 Gold farthing, *Ross-noble*.  
 Goldfanny, *Goldsinny*.  
 Goldilocks, *Polytrichum* (Supp.)  
 Goldings, *Hops*.  
 Gold powder, *Bronzing*.  
 Gold purple, *Purple of Cassius*.  
 Gold-seed, *Dog-tail Grass*.  
 Gölek Bôghas, *Cilicia*.  
 Golo, *Cortica*.  
 Golyzin, *Galysin*.  
 Gombo, *Hibiscus*.  
 Gomphrena, *Amaranth*.  
 Gomul Pass, *Goolairee* (Supp.)  
 Gonaive, *Hayti*.  
 Gônd, *Tamil*.  
 Gondokoro, *Baker* (Supp.)  
 Gondo, *India*, 539.  
 Goniaia, *Lichen*.  
 Gonoma, *Moluccas*.  
 Gonorrhoea, (Supp.)  
 Gonaubi, *Kaffraria, British*.  
 Gonzaga, Card. Trent, C. of.  
 Good, *Storia*.  
 Good Henry, *Chenopodium*.  
 Goodsir, Professor J. (Supp.)  
 Goodyear, Ch. (Supp.)  
 Goolairee Pass, (Supp.)  
 Gooma, *Cambay*.  
 Goor, *Disguthai*.  
 Goorjun tree, *Dipterocae*.  
 Gooseberry gourd, *Momordica*.  
 Goosefoot, *Chenopodium*.  
 Goose-grass, *Bed-straw*.  
 Goræ (r.), *Ganges*, 614.  
 Gordon, Mr., *Esse* (Supp.)  
 Gorebill, *Garfisk*.  
 Gorey, *Wexford*.  
 Gorge, *Bastion*.  
 Gorges, *Gorges*.  
 Gorica, (Supp.)  
 Gorigunga (r.), *Ghogra*.  
 Gôritz, *Gôra*.  
 Gorse, *Phura*.  
 Goshob, *Abyssinia*.  
 'Gospel', the, *Lesson* (Supp.)  
 Gosselies, (Supp.)  
 Gôta (r.), *Sweden*, 236, *Wener*.  
 Götaland, *Götland*.  
 Gôtarika, *Götland*.  
 Gottesgabe, *Ergebirge*.  
 Gotthelf, *Jeremias, Bittus*.  
 Gouet, *Côtes-du-Nord*.  
 Gouges, *Carpentry*.  
 Gough, J. B. (Supp.)  
 Goulard's extract, *Lead*.  
 Goulburn, *New South Wales*.  
 Goumod, F. C. (Supp.)  
 Gour, *Gaur*.  
 Gourami, *Gouramy*.  
 Gourdon, *Lot*.  
 Gourmah, *Necropolis, Thobes*.  
 Gout, in corn, *Corn-Ry*.  
 Gout, rheumatic, *Rheumatism*.  
 Gout powder, Duke of Por-  
 tland's, *Gentian*.  
 Governor, *Steam-engine*, 109.  
 Gowan, *Daisy*.  
 Gowdie, *Dragonet*.  
 Goyt, *Murray*.  
 Gradiska, *Kastenland*.  
 Grafenberg, *Rhein-wine*.  
 Gräfrath, (Supp.)  
 Grafton, *New South Wales*.  
 Graham's Dike, *Antonineus, Wall of*.  
 Grakle, *Carlew*.  
 Grakle, purple, *Quincalus*.  
 Gran, *Grass*.  
 Grana, *Caraglio*.  
 Granard, *Longford*.  
 Granico, *River-croft*.  
 Grand Lake, *New Brunswick*.  
 Grand Bè Island, *Saint Malo*.  
 Grand Bernard, *Geneve, Italy*.  
 Grandbourg, *Marie Calanda*.  
 Grand Charter, *Chartis*.  
 785



INDEX.

Grand Chute, *Appleten*.  
 Grand-Colombier, *Syria*.  
 Grande-Combe, *La* (Suppl.).  
 Grande Port, *Mauritius*.  
 Grand River, *Utah*.  
 Grand seigneur, *Turkey*, 587.  
 Grand vizier, *Turkey*, 587.  
 Grangeneuve, *Gironde*.  
 Granier de Cassagnac, (Suppl.).  
 Granite State, *New Hampshire*.  
 Gramiciele, (Suppl.).  
 Gran Sasso d'Italia, *Corno Monti*.  
 Grant, *Chaa*, (Suppl.).  
 Grant, *Fr.* (Suppl.).  
 Grant, Mrs Anne, (Suppl.).  
 Grant, Mrs (of Carron), (Suppl.).  
 Grant, Pat (Suppl.).  
 Grant, Sir Francis, (Suppl.).  
 Grant, Sir R. (Suppl.).  
 Grant, Sir Wm. (Suppl.).  
 Grant, Ulysses S. (Suppl.).  
 Granta, *Cam*.  
 Granville, Earl, *Carteret*.  
 Grap, *Guadalquivir*.  
 Grape disease, *Oidium* (Suppl.).  
 Grape-hyacinth, (Suppl.).  
 Graphis, (Suppl.).  
 Graphotype, (Suppl.).  
 Grapple-plant, (Suppl.).  
 Grass-moth, (Suppl.).  
 Grass tree, *Tasmania*, 308.  
 Grass week, *Perambulation*.  
 Grates, *Warming & Ventilation*, 62.  
 Graubünden, *Grisons*.  
 Grave, *Tenpo*.  
 Gravel-rot, *Eupatorium*.  
 Gravenstein apple, *Alsen*.  
 Graver, *Burns*.  
 Gravity, *Gravitation*.  
 Gray (explorer), *Australian Explorations* (Suppl.), 410.  
 Gray hen, *Blackcock*.  
 Gray, Jn. Ed. (Suppl.).  
 Gray powder, *Mercurials*.  
 Gray salts, *Rectifying*.  
 Gray Sisters, *Brothers and Sisters of Charity*.  
 Gray trout, *Bull Trout*.  
 Gréal, *Graal*.  
 Grease, (Suppl.).  
 Great Eastern, (Suppl.).  
 Great Felber, *Nassau*.  
 'Great Go,' *Cambridge Univ.*  
 Greathand, *Life-boat*.  
 Great Island, *Cork*.  
 Great Sound, *Bermudas*.  
 Great Swan (i.), *Falkland Is.*  
 Great Thorn (r.), *Cedar Mts.*  
 Greek Empire, *Byzantine Empire*, 469.  
 Greek mythology, *Greek Religion*.  
 Greek valerian, *Polemoniacea*.  
 Green (r.), *Utah*.  
 Green almonds, *Pistacia*.  
 Greenbacks, (Suppl.).  
 Greenbone, *Gargny*.  
 Green Cloth, *Board of Steward of the Household*.  
 Green gage, *Plum*.  
 Green grosbeak, *Greenfinch*.  
 Green Hill, *Lanarkshire*.  
 Greenland dove, *Cuillemot*.  
 Greenland bear, *Beaverkshire*.  
 Green linnets, *Greenfinch*.  
 Green-manuring, *Rape*.  
 Greens monkey, *Cercopithecus*.  
 Green-room, *Theatre*, 390.  
 Greenshank, *Sandpiper* (Suppl.).  
 Gregorians, *Brotherhoods*.  
 Grenelle, *Paris*, 211.  
 Gréoula, *Alpes Basses*.  
 Greuze, *Painting*, 195.  
 Grewia, (Suppl.).  
 Griaes, *Anchovy Pear*.  
 Grief, *Amotion*.  
 Grift (r.), *Auldorn* (Suppl.).  
 Grig, *Scotland*, 555.  
 Grignan, *Madame de Sevigné*.  
 Grignon, *Agriculi Education*.  
 Grigoriopol, (Suppl.).  
 Grim, Cape, *Tasmania*, 306.  
 Grimaldi, *Genoa*, 684.  
 Grimaldi, *Harlequin*.  
 Grimaldi, *Optic*.

Grimsel Pass, *Alps Valais*.  
 Grindstone (i.), *Magdalen Is.*  
 Gripes, *Colic*.  
 Gripping pains, *Termina*.  
 Grisvigné, (Suppl.).  
 Groatitch, *Ecthyma* (Suppl.).  
 Grodek, (Suppl.).  
 Grook, (i.), *Carpentaria*.  
 Grooves, *Mendip Hills*.  
 Groschea, *Penny*.  
 Gros de Naples, *Taffety*.  
 Gros des Indes, *Taffety*.  
 Gross-Beerberg (mt.), *Thuringerwald*.  
 Grosseto, (Suppl.).  
 Gross-Glogau, *Glogau, Oder*.  
 Grossjägerdorf, battle of, *Seven Years War*, 636.  
 Grotte, (Suppl.).  
 Ground puppy, *Menopoma*.  
 Grudek, *Caradek* (Suppl.).  
 Gruener, *Engraving*, 70.  
 Gryffe (r.), *Renfrew*.  
 Gryphite limestone, *Lias*.  
 Guaco, *Eupatorium*.  
 Guadajocillo, *Castro del Rio*.  
 Guadalefra, *Castuera*.  
 Guadaletta (r.), *Puerto de Santa Maria*.  
 Guadalete, battle of, *Cangas de Onis*.  
 Guadalhorca (r.), *Granada, Spain*.  
 Guadalquivir, *Guadalquivir*.  
 Guadalo (r.), *Ebro*.  
 Guadarmen, *Alcaras* (Suppl.).  
 Guadarama (r.), *Tagus*.  
 Guadiato, *Guadalquivir*.  
 Guadiela (r.), *Tagus*.  
 Guajan, *Ladrones*.  
 Gualleguarchu, *Entre Rios*.  
 Gualaguay, *Entre Rios*.  
 Gualtieri, *Andes*, 239, 240.  
 Guana, *Iguana*.  
 Guanaco, *Huanaco*.  
 Guanches, *Canaries*.  
 Guanine, *Urinary Sediments*.  
 Guanonien, (Suppl.).  
 Guardian, *Addison*.  
 Guastalla, *Parma*.  
 Guaviara, *Orinoco*.  
 Guasuma, *Pipteriacaea*.  
 Gueddling, *Fishing* (Suppl.).  
 Guebwiler, (Suppl.).  
 Guer (r.), *Cotes-du-Nord*.  
 Gueve, *Cress*.  
 Guernsey lily, *Amaryllis*.  
 Gueuz, *Klévee Bac* (Suppl.).  
 Guicor, (Suppl.).  
 Guido (of Siena), *Painting*, 191.  
 Guier (r.), *Sevoy*.  
 Guigliano, (Suppl.).  
 Guillocho machine, *Machine-engraving*.  
 Guipure, *Lace*.  
 Guisborough, (Suppl.).  
 Guise, (Suppl.).  
 Guiza, *Suizar*.  
 Guldborggrund, *Falster*.  
 Gulliver's Travels, *Swift*.  
 Guluncha, (Suppl.).  
 Gum animal, *Calago*.  
 Gum, elastic, *Caoutchouc*.  
 Gumping, *Fishing* (Suppl.).  
 Gun-carriages, *War Services* (Suppl.).  
 Gun-cotton, (Suppl.).  
 Gun-factories, royal, *War Services* (Suppl.).  
 Gunera (Suppl.).  
 Gunera cabra, *Avallia*.  
 Gunong Gunton, *Bandong*.  
 Guns and projectiles, *Palliser War Service* (Suppl.).  
 Gunter's scale, *Gunter's Chain*.  
 Gurio, *Caspian Sea, Doryat*.  
 Gurlup tree, *Dipterocaea*.  
 Gurfeld, (Suppl.).  
 Gurmukeswar, (Suppl.).  
 Gurney, Mr., *Bude Burner*.  
 Gurrak, *Shakjhanpore* (Suppl.).  
 Gutzbrun, *Alyrid*.  
 Guze, *Romule*.  
 Guzerat, *Cajerat*.  
 Guzeh, *Gaza*.  
 Gwydir, *Darling*.  
 Gwynedigion, *Welsh Lang.* & *Lit.* 137-138.

Gyarmat-Balassa, (Suppl.).  
 Gyanta, *Donia*.  
 Gymnospermæ, *Coniferae*.  
 Gynn, *Gimp*.  
 Gynsokology, *Midwifery*.  
 Gyona (r.), *Tenasserim*.  
 Gyona, (Suppl.).  
 Gypogeranus, *Secretary*.  
 Gyps, *Vulture*.  
 Gypsophila, *Snapwort*.  
 Gypsy-wort, *Horseshoe* (Suppl.).  
 Gyrodactylus, *Trematoda*.  
 Gyronny, *Gironad*.  
 Gyroscope, (Suppl.).  
 Gyrostat, *Gyroscop* (Suppl.).  
 Haaksbergen, *Overyssel*.  
 Haardrade, *Haruld III*.  
 Haarfinger, *Harald I*.  
 Haase, *Emu*.  
 Habit, *Phrenology*, 518.  
 Habsburg, *Hapsburg*.  
 Hacho Mount, *Cuba*.  
 Hackee, *Ground Squirrel*.  
 Hack-hawk, *Falconry*, 228.  
 Hackles, *Hechles*.  
 Hackles, *Royal*.  
 Hackluyt, *Hakluyt*.  
 Haco, *Alex. III of Scotland*.  
 Haddington, *Earls of Hamilton Family*, 271.  
 Hadhaz, *Haiduck* (Suppl.).  
 Hadramout, *Arabia*, 344.  
 Hadrumetus, *Barbary*.  
 Hæmal spine, *Skeleton*, 751.  
 Hæmantus, *Blood-flower*.  
 Hæmapophyses, *Skeleton*, 751.  
 Hæmatocrya, *Vertebrata*.  
 Hæmatococcus, *Black Quarter*.  
 Hæmatotherm, *Vertebrata*.  
 Hæmylia, *Falconry*, 228.  
 Haggard, *Falconry*, 228.  
 Hage, *Hajj*.  
 Hagmatana, *Hobanana*.  
 Hagmana, *Hobanana*.  
 Haidarabad, *Hyderabad*.  
 Haiduck, (Suppl.).  
 Haifa, *Cairo*.  
 Haigh, D. H., *Runes*.  
 Haikh, *Bedouine*.  
 Haimburg, *Hainburg*.  
 Hain, *Grosshain*.  
 Haines (r.), *Somali Land*.  
 Hainchina, (Suppl.).  
 Hair-moss, *Polytrichum* (Suppl.).  
 Hair Stone, *Stinking Stones*.  
 Hair-stone, *Rock Crystal*.  
 Hairumbo, *Cachar*.  
 Haje Nasser, *Asp*.  
 Haj, (Suppl.).  
 Hala, *Halla*.  
 Hale S. J. (Suppl.).  
 Haleb, *Syria*.  
 Halicarnassus, *Caria*.  
 Halimodendron, *Saline Plants*.  
 Halle, *Cherles*.  
 Halleck, *Fitz-Greene*, (Suppl.).  
 Hallein, *Halle*.  
 Hallowmas, *All Saints Day*.  
 Hallstadt (i.), *Salskammerguit*.  
 Haltin, (Suppl.).  
 Haloylin, (Suppl.).  
 Halsfang, *Weregild*.  
 Halteres, *Insects*, 588.  
 Halya, *Anatolia*, 226.  
 Hamadani, *Arabian Lang.* & *Lit.* 348.  
 Hamah, (Suppl.).  
 Hamamat, *Egypt*, 789.  
 Hamata, *Urns Major*.  
 Hamato, *Evador*.  
 Hambleton Hills, *Yorkshire*.  
 Hamburg, white, *Baryta*.  
 Hamesucken, *Haimuckern*.  
 Hamites, *Ammonites*.  
 Hamlet, or Hamleth, *Amleth*.  
 Hamme, *Hanover*.  
 Hammer shell, *Mollusca*.  
 Hamoaze, *Dromoport*.  
 Hampton, *Waterhampton*.  
 Hamsa, *Arabian Lang.* & *Lit.* 347.  
 Hanbalites, *Sunnites*.  
 Hand-ball, *Tennis*.  
 Handeck, Falls of, *Aar*.  
 Handicapping, (Suppl.).  
 Handiron, *Andros*.  
 Handspike, *Windlass*.

Hand-tennis, *Fives*.  
 Handites, *Sunnites*.  
 Hangendenlissen, *Fünfhams* (Suppl.).  
 Han-kiang (r.), *Corna*.  
 Han-kiang (r.), *Yang-tze-kiang*.  
 Hanley, (Suppl.).  
 Hants, *Hants*.  
 Happiness, theory of, *Stoics*.  
 Hara, (Suppl.).  
 Hardenberg, *Overyssel*.  
 Hard Shells, *Republiken*.  
 Hardt (mts.), *Prussia*.  
 Hardware, *Blistered Steel*.  
 Hare Bay, *Newfoundland*.  
 Hareid, (Suppl.).  
 Haren, *Seraglia*.  
 Haren-gula, *Sprat*.  
 Haricot, *Kidney-bean*.  
 Harling, *Rough-cast*.  
 Harmanite, *Harmanite*.  
 Harmony Hall, *Oswestry, Robert*.  
 Harold's Cross, (Suppl.).  
 Harouka, *Moluccas*.  
 Harpagon, *Falcon*.  
 Harport, *Shyn*.  
 Harpy, *Harrier*.  
 Harquebus, *Argentine*.  
 Harsu-kari, *Sagan*.  
 Harrington Sound, *Bermudas*.  
 Harsu, Dr., *Encyclopadia*, 42.  
 Harus (r.), *Tun*.  
 Hart Fell, *Dumfriesshire*.  
 Hartford, *Connecticut*.  
 Haruco, *Ambrosia*.  
 Haruja, *Wart-hog*.  
 Harvest-fly, (Suppl.).  
 Harvest-mo, *Phalangiada*.  
 Harvey, William, *Wood-co-graving*, 258.  
 Harvey (whaling), *Coak Is.*  
 Hase, *Wakab*, 42.  
 Hasam (r.), *Assassins* (Suppl.).  
 Hashish, *Assassins*.  
 Hasli, *Born*.  
 Hasenbeck battle of, *Seven Years War*, 636.  
 Hastings, *Minerata*.  
 Hatchetine, *Mineral Tallow*.  
 Haukabee, *Haukabee*.  
 Haurur, (Suppl.).  
 Haus, *Houssa*.  
 Haute-combe, *Savoy*.  
 Haute-Alpes, *Alpes Hautes*.  
 Haut M. (r.), *Almond-gew* (Suppl.).  
 Havildar, *Zemindar*.  
 Hawaki, *Maria*.  
 Hawarden, *Flintshire*.  
 Hawk's Nest, *Virginia*.  
 Hawking, *Falconry*.  
 Hawks, Dr. L. (Suppl.).  
 Hawiboline (i.), *Cork*.  
 Hay, *Brockenburgh*.  
 Hayel, *Wakab*, 42.  
 Hayes, Aug. Allen, (Suppl.).  
 Hayes, Is. I. (Suppl.).  
 Hazard, *Billiards*, 98.  
 Headers, *Bricklaying*.  
 Head-quarters, *Quarterm*.  
 Head-rope, *Bolt-rope*.  
 Health, public, *Sanitary Science* (Suppl.).  
 Heame, Lieut. *Coppermine* (r.).  
 Hearse, *Herse*.  
 Heartburn, *Cardialgia*.  
 Heart's Content, *Atlantic Tel*.  
 Heart's ease, *Viola*.  
 Heart-stroke, *Angina Pectoris*.  
 Heart-wood, *Duramen*.  
 Heat, *Thermo-dynamics* (Suppl.).  
 Heat, animal, *Animal Heat*.  
 Heat apoplexy, *Sun-stroke*.  
 Heath-fowl, *Blackcock*.  
 Heavy spar, *Canak*.  
 Hebdonadal Board, *Oxford University*.  
 Hébert, *Coralliers*.  
 Hebron, *Ladader*.  
 Hebrus, *Martina*.  
 Heccate, grove of, *Aurona*.  
 Heccatompnyk, *Parthia*.  
 Hechingen, *Hohenollern*.  
 Heddles, *Headles*.

Hefia, *Caifa*.  
 Hegelianism, *Hegel, G.*  
 Hegius, A. *Agricola, R.*  
 Hegumenos, *Greek Church, 87.*  
 Hegyallya (r.), *Tokay.*  
 Heidenauer, *Ribawville.*  
 Heka, *Egypt, 787.*  
 Hekla, *Halia.*  
 Helamys, *Jumping Hare (Supp.)*  
 Helena, *Bay Is., Ruatan.*  
 Helenin, *Elcampane.*  
 Heligoland, *Heligoland.*  
 Helical year, *Canicular.*  
 Heliand, *Germany, 72.*  
 Helianthemum vulgare, *Cistus.*  
 Heliocantharus, *Scarabaeus.*  
 Heliostat, *Heliotrope.*  
 Heliotypography, *(Supp.)*  
 Hellbender, *Batrachia, Menopoma.*  
 Hellenom, *Overyssel.*  
 Hell Kettles, *Darlington.*  
 Helmet-shell, *(Supp.)*  
 Helmond, *(Supp.)*  
 Helmsdale Water, *Sutherland.*  
 Helonia, *Sabadilla.*  
 Helsingborg, *(Supp.)*  
 Helveticus, *Helvetius.*  
 Hemerolopia, *Sight, Defects of.*  
 Hemerobaptist, *Jewish Sects.*  
 Hemionus, *As.*  
 Hemling, Hans, *Painting, 192.*  
 Hemp agrimony, *Eupatorium.*  
 Hempholme, *Chiltern Hundreds.*  
 Hemp-nettle, *Dead Nettle.*  
 Hemp-palm, *(Supp.)*  
 Hemp-seed, oil of, *Hemp.*  
 Hen and chickens, *Daisy.*  
 Henderd, East, *Chiltern Hundreds.*  
 Hengstbury, *Christchurch.*  
 Hen-hawk, *Bussard.*  
 Henley-on-Thames, *(Supp.)*  
 Henry VIII's Survey, *Records, Public.*  
 Henty, *Victoria, 786.*  
 Henware, *Badderlocks.*  
 Henzada, *Pegu.*  
 Hep, *Hij.*  
 Herald's visitations, *Visitations, Herald.*  
 Heraz (r.), *Amal (Supp.)*  
 Herb Bennett, *German.*  
 Herb Christopher, *Actaea.*  
 Herbert family, *Carnarvon (Supp.)*  
 Herb Gerard, *Goat-weed.*  
 Herb of grace, *Rus.*  
 Herb Robert, *Geranium.*  
 Herb St Barbara, *Cress.*  
 Heri, *(Supp.)*  
 Herisau, *Aghersau.*  
 Herjedal, *Sweden, 236.*  
 Herin, *Jersey.*  
 Hermanese, *Shetland.*  
 Hermanic, *Valene.*  
 Herman-schlacht, *Varus.*  
 Hermes, *George, (Supp.)*  
 Hermetianism, *Hermes (Supp.)*  
 Hermon, *Paletinus.*  
 Hermopolis, *Syria.*  
 Hermosillo, *(Supp.)*  
 Hermus (r.), *Anatolia, 226.*  
 Hernad (r.), *Thetis.*  
 Hernandia Guianensis, *Andou.*  
 Herodesand, *Angermannland.*  
 Herodians, *Jewish Sects.*  
 Heroic Age, *Age.*  
 Heron, *Hiero.*  
 Herophilus, *Medicine, Hist. of.*  
 Herpestes, *Ichnemom.*  
 Herring, Vancouver Island, *(Supp.)*  
 Herring, king of the, *Shad.*  
 Herring salmon, *Coregonus.*  
 Herra, *Harris.*  
 Herrnhut and Herrnhuters, *Zinendorf.*  
 Heristal, *Heristal.*  
 Hertford, Earls of, *Seymour.*  
 Hertha Lake, *Rugen.*  
 Herts, *Hertfordshire.*  
 Hesperides Insule, *Scilly Is.*  
 Hesperis, *Rocket.*  
 Hesse-Darmstadt, *Germany (Supp.), 535.*  
 Hestia, *Vesta.*  
 Hesuirus (r.), *Sutlej.*  
 Heteroclitus grouse, *Syrhaptes.*  
 Heterogenesis, *Reproduction, 195.*  
 Heteropoda, *Nucleobranchiata.*  
 Heyn, *Heijn, P. P.*  
 Heytesbury, *Wiltshire.*  
 Heywood, *(Supp.)*  
 Hexhamshire, *Shire.*  
 Hialland, *Shetland.*  
 Hiamum, *Fuk-ken.*  
 Hiawasee (r.), *Tennessee.*  
 Hibernia, *Ireland.*  
 Hidalgo, *Mexico.*  
 Hiddekel (r.), *Tigris.*  
 Hielmar (r.), *Sweden, 236.*  
 Hieres, *Hytres.*  
 Hieronymites, *Brotherhoods.*  
 Hierro, *Ferro.*  
 High Church, *England and Ireland, Church of, 62.*  
 Highgate resin, *Copal.*  
 High Harrogate, *Harrogate.*  
 Highland and Agri. Soc. of Scot., *Agricultural Societies.*  
 High Peak, *Derbyshire.*  
 High Peak, *Sidmouth.*  
 High Peak (mt.), *Catskill Mts.*  
 Hildburghausen, *Saxe-Meiningen.*  
 Hildebrandisul, *District of Bern (Supp.)*  
 Hilden, *(Supp.)*  
 Hillah, *Babylon, 600.*  
 Hill mustard, *Bunias.*  
 Hillsborough Bay, *Prince E. I.*  
 Hilum, *Seed.*  
 Hilversum, *(Supp.)*  
 Himyarites, *Yemen.*  
 Himyaritic Lang., *Shemitic Lang. 670-672.*  
 Hind Stag, *(Supp.)*  
 Hindley, *(Supp.)*  
 Hindbe, *Lofoden.*  
 Hindon, *Yuma.*  
 Hinkelhahn (mt.), *Saxe-Witmar-Eisenach.*  
 Hinna, *Henna.*  
 Hiong-nu, *Turks.*  
 Hipp Indian, *Gillenia.*  
 Hippobroma, *Sapindaceae.*  
 Hippo Diarrhytus, *Biserta.*  
 Hippolyte, *Amazons.*  
 Hippophagy, *(Supp.)*  
 Hippo Regius, *Namidia.*  
 Hiram, *Phanicia, 403; Tyrr.*  
 Hirding, *Salmon, 449.*  
 Hispania, *Spain, 15.*  
 Hitchin, *(Supp.)*  
 Hitites, *Rameses.*  
 Hiu, *Moluccas, 52.*  
 Hiz (r.), *Hitchin (Supp.)*  
 Hoazin, *(Supp.)*  
 Hobbina, *Painting, 195.*  
 Hocco, *Curassow.*  
 Hochelaga, *Montreal.*  
 Hochst, *Nassau, Tilly.*  
 Hochwald, *Prussia.*  
 Hod, *Bricklaying, 340.*  
 Hodeida, *Yemen.*  
 Hoi-he, *Seljuks.*  
 Hoffmann, A. H. *(Supp.)*  
 Hoffmann, E. T. A. *(Supp.)*  
 Hoffmann, Melchior, *Anabaptists, 218.*  
 Hoffmann von Fallersleben, *Hoffmann, A. H. (Supp.)*  
 Hofhub, *Wahabis, 42.*  
 Hog-apple, *Podophyllum.*  
 Hog-fish, *Scorpena.*  
 Hog-gum, *(Supp.)*  
 Hog-nut, *Cob-nut.*  
 Hog-weed, *Cow Parsnip.*  
 Holscheid, *(Supp.)*  
 Holaganz, *Bohar.*  
 Hold, *Hulda.*  
 Holbut, *Halibut.*  
 Holland Inlet, *Prince Ed. I.*  
 Hollenhacken, *Rhine.*  
 Holle Pass, *Black Forest.*  
 Hollow-ware, *(Supp.)*  
 Holly (poet), *Slovaks.*  
 Holm, *Peel.*  
 Holm oak, *Ilex.*  
 Holston (r.), *Tennessee.*  
 Holt, *Denbighshire.*  
 Holt, T. *Elizabethan Arch.*  
 Holy birds, *Pillar Saints.*  
 Holy bitter, *Hiera Picra.*  
 Holy fire, *(Supp.)*  
 Holy Innocents Day, *Chil-dermas.*  
 Holy Isle, *Buteshire.*  
 Holy Office, the, *Inquisition.*  
 Holy of holies, *Tabernacle.*  
 Holy Sepulchre, *Holy Places.*  
 Holy Thursday, *Ascension Day.*  
 Holy-water font, tap, &c., *Benitier.*  
 Home, D. D., *Spiritualism.*  
 Home Mission, of Germany, *Wichern.*  
 Homerite, *Arabia, 346; Yemen.*  
 Hominy, *Maize.*  
 Homogenesis, *Reproduction, 195.*  
 Homophony, *Antiphony.*  
 Homs, *Hems.*  
 Honda, *Magdalena.*  
 Honey bear, *Kinkajou.*  
 Honey berry, *Melicocca (Supp.)*  
 Honeycomb bag, *Ruminantia.*  
 Honey-sucker, *Honey-eater.*  
 Honi soit qui mal y pense, *Garter, Order of.*  
 Honuman, *Entellus Monkey.*  
 Hood Isle, *Galapagos Islands.*  
 Hood's Canal, *Washington (territory).*  
 Hooker (mt.), *Rocky Mts.*  
 Hooker, General, *Richmond, U.S. 660.*  
 Hooks, fishing, *Angling, 256.*  
 Hoolock, *Gibbon.*  
 Hooper, *Swan.*  
 Hoorn Count, *William, Prince of Orange.*  
 Hoosic (r.), *Hudson.*  
 Hopenthal, *Labrador.*  
 Hop frog-fly, *(Supp.)*  
 Hop (rth-ly), *(Supp.)*  
 Hopkins (r.), *Victoria, 785.*  
 Hopkins, M., *Witchcraft, 236.*  
 Hopping Dick, *Trush.*  
 Horse Pauline, *Palsy.*  
 Horaforas, *Ambeyna.*  
 Horde, *(Supp.)*  
 Horeymelah, *Wahabis, 41.*  
 Hormazd, *Ormuzd.*  
 Hormesta, *Oronius.*  
 Hormuz, *Ormuz.*  
 Hormuzan, *Susa.*  
 Horn, *Lippe.*  
 Hornbook, *(Supp.)*  
 Horn, Cape, *Cape Horn.*  
 Horned hog, *Babryrousa.*  
 Horned owl, *Eagle Owl.*  
 Horned ray, *Cephaloptera.*  
 Horned viper, *Cerastes.*  
 Hornel, *Launce.*  
 Hornstone, *Chert.*  
 Horodenka, *(Supp.)*  
 Horopter, *Vision, 823.*  
 Horse-bee, *Bot.*  
 Horse-flesh as food, *Hip-pophagy (Supp.)*  
 Hørsel, *Eisenach.*  
 Horse mackerel, *Scad.*  
 Horse-tail, *Equitum.*  
 Horta, *Fayal.*  
 Hospital fever, *Typhus and Typhoid Fevers, 615.*  
 Hospital gangrene, *Phagedana.*  
 Hostie, *Lord's Supper, 193.*  
 Hotch-potch, *(Supp.)*  
 Hotham's Island, *Grakame's I.*  
 Hottentot's bread, *Elephant's Foot.*  
 Hottentot's fig, *Menembyacca.*  
 Houghton-le-Spring, *(Supp.)*  
 Hougomont, *Waterloo.*  
 Hovellers, *Goodwin Sands.*  
 Hovenia dulcis, *Rhamnaceae.*  
 Howdah, *Elephant, 4.*  
 Howe, General, *U.S. 654.*  
 Howling whale, *Caating Whale.*  
 Hoyle, Edmond, *Whist.*  
 Huaco, *Eupatorium.*  
 Huallaga (r.), *Peru, 437.*  
 Huanchaco, *Truxillo.*  
 Huasco, *Chili.*  
 Hubertusburg, *(Supp.)*  
 Hucho, *Salmon, 449.*  
 Huckleberry, *Whortleberry.*  
 Hudibras, *Butler, S.*  
 Hueque, *Auchenia.*  
 Hufeland, C. W., *(Supp.)*  
 Hughes, Thos., *(Supp.)*  
 Hugo Capet, *Capetian Dynasty.*  
 Hugri (r.), *Mysoor.*  
 Humsne, *Orne.*  
 Huizilpochtli, *Mexico, 434.*  
 Hulls, Jonathan, *Steam-navi-gation.*  
 Humboldt (r. and mts.), *Utah.*  
 Humboldt's Bay, *Pagaya, 251.*  
 Humbercopp, *Allahabad.*  
 Humerus, *Hand, 222.*  
 Humin, *Hummus.*  
 Hummel, J. N., *(Supp.)*  
 Hums, *Hems.*  
 Hungarian balsam, *Pine.*  
 Hungarian wines, *Wine, 226.*  
 Hungary, *Germany (Supp.), 536.*  
 Hungry Hill, *Bantry Bay.*  
 Hung-sew-teuen, *China, 821.*  
 Hung-tsin-hu, *China, 815.*  
 Hungus, *Picts.*  
 Hunkar, *Turkey, 587.*  
 Hunnerberg, *Nijmegen.*  
 Hunterian Museum, *Owen, Richard.*  
 Hunting dog, *Lycan.*  
 Hunting leopard, *Cheetah.*  
 Huntly, Marquises of, *Gordon Family, 8.*  
 Hunze, *Croningen.*  
 Huon (r.), *Tasmania, 306.*  
 Huon pine, *Dacrydium.*  
 Huri, *Heri (Supp.)*  
 Hurigate, *Hull Gate.*  
 Hurt, *Roundell.*  
 Husch, *(Supp.)*  
 Huso, *Sturgeon.*  
 Hut, *Edfou.*  
 Hutia, *Hog Rat.*  
 Huxley, T. H., *(Supp.)*  
 Hyacinth, *Pyrop.*  
 Hyacinth, volcanic, *Vesuvian.*  
 Hyæna dog, *Lycan.*  
 Hyalite, *Opal.*  
 Hybla Minor, *Ragusa.*  
 Hydatid disease of the breast, *Adenocle (Supp.)*  
 Hydrona, *(Supp.)*  
 Hydrastis, *(Supp.)*  
 Hydraulic cranes, *(Supp.)*  
 Hydraulic engines, *(Supp.)*  
 Hydraulic lifts, *Hydraulic Cranes (Supp.)*  
 Hydrocorisæ, *Water-bug.*  
 Hydrogen acids, *Hydracids.*  
 Hydromancy, *Divination.*  
 Hydrostatic bed, *Water-bed.*  
 Hydrostatic bellows, *Hydrostatics, 490.*  
 Hygiene, *Hydrophathy, Sanitary Science (Supp.)*  
 Hyle and Hylande, *Tree-frogs.*  
 Hyemense, *Anime.*  
 Hyemium, *Fungi.*  
 Hylod bone, *Tongue.*  
 Hyperæmia, *Congestion of Blood.*  
 Hyperborean Mts., *Ural Mts.*  
 Hyperite, *Trta.*  
 Hyperodon, *Bottlehead.*  
 Hyphomyces, *Fungi, 557.*  
 Hypnum, *(Supp.)*  
 Hypodermic, *Endermic (Supp.)*  
 Hypogynous, *Stamen.*  
 Hypsulphuric acid, *Sulphur, 199.*

Hypoanthine, *Urinary Sediments, Urine*.  
 Hysterotomy, *Cæsarean Operation*.  
 Hythe, (*Suppl.*)  
 Hywel Dha, *Welsh Lang. & Lit.* 136.  
 Ialysus, *Rhodes*.  
 Iambia, *Iambo*.  
 Iambus, *Iambic Verses*.  
 Iapygian Peninsula, *Otranto*.  
 Iapygians, *Rome*, 307.  
 Iar Connaught, *Galwoy*.  
 Ibernia, *Hibernia*.  
 Iberus, *Ebro*.  
 Ibi-Gamin Pass, *Himalaya*.  
 Ibi, wood, *Tantalus*.  
 Iblis, *Mohammedanism*.  
 Ibn, *Ben*.  
 Ibn Batuta, *Arabian Lang. & Lit.* 347.  
 Ibn Mayman, *Aberris*.  
 Ibn Yahya, *Arabian Lang. & Lit.* 348.  
 Ibo, *Woolo*.  
 Ice-knees, *Whale*, 150.  
 Iceland spar, *Calcareous Spar*.  
 Ichnuus, *Sardinia*, 10. *f.*  
 Icium, (*Suppl.*)  
 Ico, (*Suppl.*)  
 Icon Amlac, *Abyssinia*.  
 Iconium, *Koniah*.  
 Iconium, sultanate of, *Othoman*.  
 Icononzo, bridge of, *Bogota*.  
 Icos, *Greece*, 85.  
 Icriok, *Ecriok* (*Suppl.*)  
 Ictia, *Wight, Isle of*.  
 Idaho, *U.S.* 647, (*Suppl.*)  
 Ideality, *Phrenology*, 513.  
 Ideographs, *Hieroglyphics*, 361.  
 Ideology, *Idea*.  
 Idle (*r.*), *Trent*.  
 Idola tribus, *specus, &c. Fallacy*.  
 Idumæa, *Edom*.  
 Idru, Cape, *Simoda*.  
 Ierne, *Hibernia*.  
 Iesi, *Jesi* (*Suppl.*)  
 Ignis sacer, *Rosé*.  
 Ignoratio elenchi, *Fallacy*.  
 Igle, *Berg*.  
 Ihne, *Oder*.  
 Ij, *Amsterdam*.  
 Ijssel, *Yssel*.  
 Ile de la Camargue, *Bouches-du-Rhône*.  
 Neo-cæcal valve, *Digestion*, 565.  
 Ilberda, *Lerida*.  
 Ilex Paraguaysensis, *Matt.*  
 Ilhavo, (*Suppl.*)  
 Ili, *Kudjia*.  
 Iliac foam, *Alimentary Canal*.  
 Iliac passion, *Ileus*.  
 Iliad, *Homér*.  
 Iliissia, *Attica*.  
 Iltz, *Servia*, 631.  
 Ilkva, *Odenburg* (*Suppl.*)  
 Ill, *Rhin, Bas*.  
 Iller (*r.*), *Alps*.  
 Illiger, *Ornithology*.  
 Illinois nut, *Hicory*.  
 Ilm (*r.*), *Saxe-Weimar-Eis-nach*.  
 Imenau, *Saxe-Weimar-Eis-nach*.  
 Iloitio, *Miagao*.  
 Il Passatore, *Bamdit*.  
 Ilz, *Bavaria*, 760.  
 Imago, *Insects*, 501.  
 Imail, *Wicklow*.  
 Imabura, *Ibarra*.  
 Imbricaria, *Sapotacea*.  
 Imhampora, *Sofala*.  
 Imoschi, (*Suppl.*)  
 Impari-pinnate, *Leaves*.  
 Impasto, *Ground in Painting*.  
 Imperial liquid, *Cream of Tartar*.  
 Imphee, *Sugar-cane*.  
 Imping, *Falconry*, 220.  
 Implacental, *Mammalia*.  
 Impoof, *Eland*.  
 Impoon, (*Suppl.*)  
 Imposition of hands, *Orders, Holy*.  
 Inchmarnoch, *Buteshire*.  
 Incisors, *Tooth*, 309.  
 Incumbered Estates Courts, (*Suppl.*)  
 Indal (*r.*), *Sweden*, 256.  
 Indefatigable Isle, *Galapagos Islands*.  
 Indemnity, Bill of, *Bill of Indemnity*.  
 Inderab, *Anderab* (*Suppl.*)  
 Indian ass, *Rhinoceros*.  
 Indian Caucasus, *Hindu Kush*.  
 Indian cress, *Tropæolum*.  
 Indian hemp, *Hashish, Hemp*.  
 Indian jade, *Nephrite*.  
 Indian millet, *Durra*.  
 Indian oil tree, *Bassia*.  
 Indianola, *Texas*.  
 Indian oat, *Zebu*.  
 Indian physic, *Gillenia*.  
 Indian tobacco, *Lobelia*.  
 Indicator, *Steam-engine*, 100.  
 Indicolite, *Tourmaline*.  
 Indicolpustes, *Cosmas*.  
 Indigo bird, (*Suppl.*)  
 Individuality, *Phrenology*, 516.  
 Indragiri, *Rivno*.  
 Indrapura (*r.*), *Sumatra*.  
 Induration, *Softening and Induration*.  
 Industrial exhibitions, *Exhibitions* (*Suppl.*)  
 Inebriates, establishments for, *Dipsomania* (*Suppl.*), 500.  
 Infantile remittent fever, *Worm Fever*.  
 Inflected languages, *Philology*, 485.  
 Infundibula, *Respiration*, 208.  
 Ingathering, feast of, *Tabernacles, Feast of*.  
 Ingleborough, *Yorkshire*.  
 Inglis (*r.*), *Tasmania*, 306, 307.  
 Ingulvis, *Digestion*, 567.  
 Ingolf, *Iceland*, 506.  
 Ingres, J. D. A. (*Suppl.*)  
 Inguinal glands, *Anal Glands*.  
 Inhabitiveness, *Phrenol.* 514.  
 Inhambane, *Sofala*.  
 Injector, *Giffard's*, (*Suppl.*)  
 Ink marking, *Silber*, 720.  
 Inkpen Bacon, *Wiltshire*.  
 Innakilly, *Yongkah*.  
 Innerhoden, *Aphenack*.  
 Innes, Thomas, (*Suppl.*)  
 Innehansson, *Bandon* (*Suppl.*)  
 Innehsharkin (*r.*), *Coré*.  
 Innocent II., *Pope, Roger II.*  
 Innuus, *Inuus*.  
 Inoculation, *Budding*.  
 Inosin, or Inosite, *Sugar*, 187.  
 Inselberg (*r.*), *Thuringen-wald*.  
 Insomnia, *Sleep*.  
 Insipissated juice, *Extracts*.  
 Instér, *Prugal*.  
 Insurance, post-office, *Insurance* (*Suppl.*) (1) (*Suppl.*)  
 Insurance-broker, *Ship-broker*  
 Intendant-general, *Staff*.  
 Interama, *Teramo*.  
 Intercostal spaces, *Ribs*.  
 Internuncio, *Legatos, Nuncios*.  
 Intestinal fever, *Typhus & Typhoid Fevers*, 615.  
 Intestinal juice, *Digestion*, 569.  
 Intine, *Vegetable Physiol.* 735.  
 Intrados, *Arch*, 366.  
 Inverury, *Aberdeenshire*.  
 Invoice-book, *Book-keeping*, 227.  
 Ionidium, *Violacea*.  
 Ios, *Greece*, 85.  
 Ipek, *Petek*.  
 Ipe-tobacco, *Bignoniacea*.  
 Ipo, *Upas*.  
 Ipewich, *Queensland*.  
 Ireton, Henry, (*Suppl.*)  
 Iriarte andicola, *W.a.s.-palm*.  
 Iris (*r.*), *Anatolia*, 506.  
 Irmenseule, *Yegdrasil*.  
 Iron, Age of, *Bronze, Age of*.  
 Iron Island, *Tenasserim*.  
 Iron, wine of, *Tartaric Acid*, 304.  
 Iron-bark tree, *Eucalyptus*.  
 Iron-rod, *Beuzomer's Process*.  
 Iron-sand, *Ladstone*.  
 Ironsides, *Cromwell's, Cromwell*.  
 Ironstone, *Black-band Ironstone*.  
 Ironstone Mount, *Tasmania*, 306.  
 Iron-wood, *Dado Plum*.  
 Iron-wood, white, *Xanthoxylum*.  
 Irrationality of dispersion, *Refraction*.  
 Irritability of muscles, *Tonicity, Muscular*.  
 Irún, *Spain*, 14.  
 Isaac Angelus, *Andronicus*.  
 Isaac II., *Byzantine Emp.* 471.  
 Isaacs River, *Queensland*.  
 Isabella II., *Spain*, (*Suppl.*)  
 Isabnormal lines, *Isothermal Lines*.  
 Isatis, *Wood*.  
 Ischys, *Asculapius*.  
 Isel, *Draus*.  
 Iser, *Flanders, West*.  
 Iser, *Bunzlau* (*Suppl.*)  
 Iserine, *Titanium*.  
 Isgaur, *Colchia*.  
 Isak-ben-Soleiman, *Arabian Lang. & Lit.* 348.  
 Isis, *Ostria*.  
 Iskanders, *Scutari*.  
 Iskelib, (*Suppl.*)  
 Isker (*r.*), *Turkey*, 566.  
 Islamabad, *Cashmere*.  
 Islampoor, *Dacca*.  
 Island of Desolation, *Kerguelen's Land*.  
 Islandshire, *Shiru*.  
 Islebius, *Agricola, Yoko*.  
 Isle of Bourbon Tea, *Faoua*.  
 Isle of Serpents, *Black Sea*.  
 Isle Royal, *Superior Lake*.  
 Isles, Lords of the, (*Suppl.*)  
 Ismail, *Perzia*, 423.  
 Ismaili, *Suez Canal* (*Suppl.*)  
 Ismailis, (*Suppl.*)  
 Ismid, *Nicomedia*.  
 Isogonic lines, *Terrrestrial Magnetism*, 571.  
 Isolating languages, *Philology*, 481, 484.  
 Isonandra, *Pouchenti* (*Suppl.*)  
 Isonza (*r.*), *Austria*, 568.  
 Israfil, *Mohammedanism*.  
 Issik-kul (*r.*), *Semipalatinsk*.  
 Issoudun, *Indre*.  
 Issuant, *Yezant*.  
 Istacuibaud (*mt.*), *Marion*, 420.  
 Italian paste, *Macaroni*.  
 Italians, ancient, *Rome*, 307.  
 Italy, (*Suppl.*)  
 Itaparica (*r.*), *All Saints Bay*.  
 Itapicuru (*r.*), *Bahia*.  
 Itchen (*r.*), *Southampton*.  
 Ithon (*r.*), *Radnorshire*.  
 Itri, (*Suppl.*)  
 Itu, (*Suppl.*)  
 Iturbide, Emp. of Mexico, (*Suppl.*)  
 Itz (*r.*), *Saxe-Coburg-Gotha*.  
 Ivan Kalita, *Russia*, 385.  
 Ivanovo, (*Suppl.*)  
 Ivay, *Parana*.  
 Ivel, *Bedfordshire, Ouse*.  
 Iverduin (*r.*), *Neyfchatel*.  
 Ivernia, *Hibernia*.  
 Ivisan, *Copia*.  
 Ivory, battle of, *Henry IV. (France)*.  
 Izodes and Izodides, *Tich*.  
 Izmid, *Nicomedia*.  
 Jablonovy (*mts.*), *Irutsk*.  
 Jacare, *Alligator*.  
 Jacitara palm, (*Suppl.*)  
 Jack, *Pike*.  
 Jackatahah, *Ootacamund*.  
 Jack-by-the-hedge, *Allieria*.  
 Jackson, *England*.  
 Jackson, *Tennessee*.  
 Jacobean style of architecture, *Renaissance*.  
 Jacova, (*Suppl.*)  
 Jagers, *Chazars*.  
 Jahnvi (*r.*), *Gaoga, 614*.  
 Jait (*r.*), *Ural*.  
 Jailum, *Bijahar*.  
 Jalen (*r.*), *Calatayud*.  
 Jalun, *Bundelcund*.  
 Jamaica, *Long Island*.  
 Jamaicina, *Andira*.  
 James Isle, *Galapagos Is.*  
 Jamestown, *Barbados*.  
 Jamuri, *Abania*.  
 Janiculum, *Moon, and the Janiculum, Rome*, 22, 23.  
 Jankovitz, (*Suppl.*)  
 Jantra (*r.*), *Tirum*.  
 Japan earth, *Catcha*.  
 Jarama (*r.*), *Tago*.  
 Jarchi, *Rachi*.  
 Jardin des Plantes, *Botanic Garden*.  
 Jargonnella, *Peor*.  
 Jarool, *Lagerstræmia*.  
 Jaroslaf, *Russia*, 364.  
 Jar-ra-warnang, *Baritah*.  
 Jasmine tree, *Pyrotach*.  
 Jason (*r.*), *Falkland Is.*  
 Jatropha nana, *Physic-nut*.  
 Jats, *Punjab, Sikkim*.  
 Jaulna, (*Suppl.*)  
 Jauru, *Paraguay, river*.  
 Java, (*Suppl.*)  
 Javonia, *Guadiana*.  
 Javorskij, *Russian Lang. & Lit.*  
 Jaw-fall, *Trismus Nausepticus*.  
 Jaworow, (*Suppl.*)  
 Jaxt, *Necher*.  
 Jay, W. (*Suppl.*)  
 Jazyges, *Transylvania*.  
 Jean Paul, *Richter*.  
 Jebel Ahd (*mt.*), *Perzia*, 419.  
 Jebel-el-Bied, *Bham, Capé*.  
 Jebel-er-raban, *Ararat Mt.*  
 Jebel-esb-shahi, *Lohann, Anti-*.  
 Jebel Hadjar, *Atlas Mts*.  
 Jebel Katharin, *Sinaï*.  
 Jebel Mita, *Sinaï*.  
 Jeddah, *Yiddah*.  
 Jefferson (*mt.*), *White Mts*.  
 Jegan, *Abania*.  
 Jehovists, *Pentateuch*, 39.  
 Jechrom, *Perz*.  
 Jisk, (*Suppl.*)  
 Jijunum, *Alimentary Canal*.  
 Jillingboe (*r.*), *Bangal, Ganga*, 615.  
 Jelly-fish, *Acalephe*.  
 Jemmingen, battle of, *William, Prince of Orange*.  
 Jemmland, *Sweden*, 574.  
 Jenibazar, *Nevshar*.  
 Jenil, *Granada, Spain*.  
 Jenner, Dr., *Typhus and Typhoid Fevers*, 611.  
 Jeres, *Xeres* (*Suppl.*)  
 Jer-falcon, *Gyr-falcon*.  
 Jericho's Ford, battle of, *U.S.* 661.  
 Jerusalem oak, *Chenopodium*.  
 Jesi, (*Suppl.*)  
 Jesses, *Falconry*, 226, 227.  
 Jessui's drops, *Bosnia*.  
 Jete, *Asclepiadacea*.  
 Jethou, *Jersey*.  
 Jew's apple, *Egg-plant*.  
 Jew's ear, (*Suppl.*)  
 Jerebel, *Ahal*.  
 Jikadam, (*Suppl.*)  
 Jiloca, *Ebro*.  
 Jimena, (*Suppl.*)  
 Jinn, *Genii*.  
 Joachim, Jos. (*Suppl.*)  
 Jochimihal, (*Suppl.*)  
 Joannes Christians, *Zelium*, 379.  
 Joannes Brenita, *Cassiana*.  
 Joannine, *Abania*.  
 Joacste, *Edipon*.  
 Joe Miller's Jest, (*Suppl.*)  
 Jogg, *Jong*.  
 Johannes, emperor, *Byzantine Empire*, 474.  
 John of Brienne, *Byzantine Empire*, 472.

Johnson, Andrew, (Supp.)  
 Johnsoniana, Ana.  
 John the Almoner, *Chrysostom.*  
 John Trismistes, *Egyptian*  
*Empire, 471.*  
 John XXIII., Pope, *Schism,*  
*Western.*  
 Jointed pipewort, *Eriocaula-*  
*cea.*  
 Joints, resection or excision of,  
*Resection of Joints.*  
 Joints, stiffness in, *Ankylosis.*  
 Jokgrim, *Zabern.*  
 Joliffes, *Africa, 70.*  
 Jonathan ben Uzziel, *Targum.*  
 Jones, Owen, *Welsh Lang. &*  
*Lit. 137.*  
 Jongleur, *Trombadour.*  
 Jonzac, *Charente-Inférieure.*  
 Jonaghour, (Supp.)  
 Jorat, Mont, *Vaud.*  
 Jordanes, *Gornades.*  
 Jordshani, *Arabian Lang. &*  
*Lit. 340.*  
 Josa, *Tarifa.*  
 Jötuns, *Giants and Dwarfs,*  
*741.*  
 Joubert, *Glass, 703.*  
 Jouffroy, Marquis de, *Steam-*  
*navigation.*  
 Journal, *Book-keeping, 227.*  
 Jovinus, *Valentinianus.*  
 Jowaree, *Dwra.*  
 Juana, *Cuba.*  
 Juan Manuel, *Spanish Lang. &*  
*Lit. 19.*  
 Juarez, Benito, (Supp.)  
 Juba, *Muscat.*  
 Jubal, or Jublah, *Strait of,*  
*Red Sea.*  
 Jubell, *Bybos.*  
 Jublanik, *Boevia.*  
 Juca, *Manioc.*  
 Juckock, *Sibir.*  
 Jug (r.), *Volaga.*  
 Juggs, *Yours.*  
 Juggulars, *Circulation, 47.*  
 Juyuy, (Supp.)  
 Julapur, (Supp.)  
 Julia, (Supp.)  
 Julian, Count, *Roderic.*  
 Juliana, *Prunes.*  
 Julian Period, *Period.*  
 Ulrich, (Supp.)  
 Juliers, *Julich (Supp.)*  
 Jumarts, *Hybrid.*  
 Jumper, *Blasting.*  
 Jumping hare, (Supp.)  
 Jumping mouse, *Deer-mouse.*  
 Ungineae, *Alismaceae.*  
 Uncus, *Rush.*  
 Une-berry, *Amelanchier.*  
 Ungferaspung (ml.), *Saxony,*  
*513.*  
 Jungle, (Supp.)  
 Jungly gau, (Supp.)  
 Junguann, *Bohemia, 190.*  
 Junata (r.), *Susquehanna.*  
 Junior optime, *Wrangler.*  
 Junjera, *Concan.*  
 Jupiter, *Planet.*  
 Junraçon, *Pyritides, Basses.*  
 Jurassic, *Oolite.*  
 Jurat, *Affidavit.*  
 Jure devolutio, *Patronage.*  
 Jurnut, *Earth-nut.*  
 Jurua (r.), *Amazon.*  
 Justicia, *Acanthus.*  
 Justin I., *Byz. Empire, 470.*  
 Justinian II., *Byz. Empire, 470.*  
 Jusuf-ben-Jakub, *Alfonso I.*  
 Jutay (r.), *Amazon.*  
 Jute manufactures, (Supp.)  
 Jutes, *Anglo-Saxons, 261.*  
 Juts, *Sinde.*  
 Jyhuu (r.), *Zelthua.*  
 Kaab-ben-Zobair, *Arabian*  
*Lang. & Lit. 347.*  
 Kabinda, *Loango.*  
 Kabiri, *Phenicia, 194.*  
 Kabus, *Perlian Lang. &*  
*Lit. 427.*  
 Kabylen, *Berber.*  
 Kachugak, *Lena.*  
 Kadoe, *Yava (Supp.), 380.*  
 Kadam, (Supp.)  
 Kämpferia pandurata, *Tur-*  
*meric.*  
 Kafu, *Nile.*  
 Kahlamba (mts.), *Zutoland.*  
 Kahoolani, *Sandwich Is.*  
 Kaid, *Sheep-louse.*  
 Kaifung-fu, *Honan.*  
 Kaila, *India.*  
 Kailasa, Temple of, *Elora.*  
 Kaimakans, *Turkey, 307.*  
 Kaisersjeh, *Anatolia, 226.*  
 Kaiserstuhl, *Black Forest.*  
 Kakapo, (Supp.)  
 Kakatera tree, *Dacrydium.*  
 Kakerlak, *Cochroach.*  
 Kakerlaken, *Athinos.*  
 Kaki, *Date Plum.*  
 Kalabagh (mts.), *Salt Range.*  
 Kalagwe (l.), *Zambesi.*  
 Kalambi (ml.), *Koffraria.*  
 Kalambu, *Colombo.*  
 Kalamita, Bay of, *Atma.*  
 Kalany-ganga, *Colombo.*  
 Kaldera, *Screw Pine.*  
 Kall, *Uma.*  
 Kalihara Desert, *Namagua-*  
*land.*  
 Kali-mas (r.), *Surabaya.*  
 Kalimazoo, *Michigan.*  
 Kali Nuddi (r.), *Kunwoj*  
*(Supp.)*  
 Kalipani, *Chogra.*  
 Kalouga (r.), *Borodino.*  
 Kamburg, *Saxo-Meisingen.*  
 Kamechameha I., II., &c.  
*Sandwich Islands.*  
 Kamela, *Vormisagus.*  
 Kamtchadales, *Kamtchatha.*  
 Kanarak, *Cuttack.*  
 Kandakal, Gulf of, *White Sea.*  
 Kandyans, *Ceylon, 738.*  
 Kangaroo apple, (Supp.)  
 Kangaroo rat, *Potoroo.*  
 Kangaroo vine, *Vitacea.*  
 Kang-tung, *China, 817.*  
 Kanizza, (Supp.)  
 Kankari, (Supp.)  
 Kanowry, *Bornu.*  
 Kanpoo, *Hang-Chow-Foo.*  
 Kan-su, *China, 817.*  
 Kapunda, *South Australia.*  
 Karadagh, *Montenegro.*  
 Karague, *Albert N'yanza*  
*Kara Kerman, Babalag.*  
 Kara-kool, *Bohara.*  
 Karakorum (mts.), *Tibet.*  
 Kara-kum, *Kisil-bum.*  
 Karasch, *Banat.*  
 Kara See, *Russia, 377.*  
 Karatchi, *Sinde.*  
 Karlsruhe, *Carlsburg.*  
 Karmathiana, (Supp.)  
 Karmoot, *Silivida.*  
 Karmob, *Carmob.*  
 Karoefa, *Papua, 250.*  
 Karotcha, *Korotcha (Supp.)*  
 Karr, J. A. (Supp.)  
 Karshi, (Supp.)  
 Karun (r.), *Skustor.*  
 Kasanlik, (Supp.)  
 Kasbe (ml.), *Terek.*  
 Kasbin, *Perzia, 422.*  
 Käsenburg, *Schwarzburg.*  
 Kashin, (Supp.)  
 Kasipoor, *Kumaon.*  
 Kasu, *Catechu.*  
 Kastron, *Antiparva.*  
 Katahdin (ml.), *White Mts.*  
 Katchi, *Tibet.*  
 Katherinenberge, *Radom.*  
 Katif, *Wahabi, 42.*  
 Katschalinskala, *Dubooka.*  
 Katskill (mts.), *New York,*  
*state.*  
 Kattagat, *Cattagat.*  
 Katiyar, *Guzerat.*  
 Katune, *Ob.*  
 Katunga, (Supp.)  
 Katensk (mts.), *Altai Mts.*  
*(Supp.)*  
 Kaul, *Sandwich Islands.*  
 Kava, *Ava.*  
 Kazbeck (mt.), *Tiflis.*  
 Kazembe, *Casimb.*  
 Karvin, *Casbin.*  
 Kea, *Cang.*  
 Keang-se, *China, 877.*  
 Keang-su, *China, 817.*  
 Kearsage, the (ship), *Alabama*  
*(Supp.), 380.*  
 Keble, John, (Supp.)  
 Kedah, *Quedah (Supp.)*  
 Kedirie (r.), *Surabaya.*  
 Kedron, *Kidron.*  
 Keedah, *Quedah (Supp.)*  
 Keeper (ml.), *Tipperary.*  
 Kee-wee-naw, *Superior, Lake.*  
 Keffing, *Moluccas.*  
 Keft Cana, *Canal of Gallio.*  
 Keg-fig, *Date Plum.*  
 Keilberg, *Erzgebirge.*  
 Keith, *Banffshire.*  
 Keith, Marshal, (Supp.)  
 Keitloa, *Rhinoceros.*  
 Kelanonesia, *Polynesia, 659.*  
 Keller, *Engraving, 70.*  
 Kellet Straits, *Melville I.*  
 Kelp ware, *Wrack.*  
 Kelt, *Salmon, 446.*  
 Kemi, *Egypt.*  
 Kemi, *Lapland.*  
 Kempen, (Supp.)  
 Kempfenfeldt, Admiral, *Royal*  
*George.*  
 Ken, *Cane.*  
 Ken (l.), *Dev.*  
 Kenia, *Maon, Mountains of.*  
 Kennare Bay, *Kerry.*  
 Kennet (r.), *Thames.*  
 Kenneth, *Scotland, 535, 556.*  
 Kenosha, *Wisconsin.*  
 Kent's Cavern or Hole, (Supp.)  
 Kentucky coffee tree, *Gym-*  
*nocladus.*  
 Kenwyn (r.), *Truro.*  
 Keppel, *Falkland Islands.*  
 Keppel Bay, *Queensland.*  
 Keptchak, *Kiptchak.*  
 Keratose, *Sponge.*  
 Kerka, *Dalmatia.*  
 Kerkhah, *Perzia, 422.*  
 Kerki, (Supp.)  
 Kern, J. C. (Supp.)  
 Kernwald, *Unterwalden.*  
 Kerrera, *Hebrides.*  
 Kerry Head, *Shannon.*  
 Kershope Water, *Border.*  
 Kertch, Strait of, *Yemkale*  
*Strait.*  
 Keswick (l.), *Derwentwater.*  
 Kut, *Ob.*  
 Ketch, Jack, *Executioner,*  
*Tyburn.*  
 Kelly, *Shropshire.*  
 Key, *Moluccas.*  
 Key Islands, (Supp.)  
 Keys, *Casco.*  
 Keys, relative, *Relative Keys.*  
 Keystone, *Arch, 366.*  
 Kezanlik, *Kasanlik (Supp.)*  
 Khabs, *Cabes.*  
 Khafaloun, (Supp.)  
 Khafren, *Egypt, 789.*  
 Kham, *Tibet.*  
 Khamzin, *Egypt, 785.*  
 Khan, *Caravanserai.*  
 Khanpur, (Supp.)  
 Khapalu, *Khafaloun (Supp.)*  
 Khafah, *Wahabi, 42.*  
 Kassou-Kayo, *Khaya.*  
 Khât, *Catha (Supp.)*  
 Khaurem, *Khiva.*  
 Khnum, *Egypt, 787.*  
 Khoi, (Supp.)  
 Khond, *Tamil.*  
 Khonds, *India, 539, Orissa.*  
 Khopah, *Trebond.*  
 Khoper (r.), *Don, Penza.*  
 Khor, *Tibet.*  
 Khora, *Samos.*  
 Khoten, *Turkistan, 285.*  
 Khudavenkiar, *Anatolia, 227.*  
 Khur, *Daggethal.*  
 Khurja, (Supp.)  
 Kia-ling (r.), *Yang-tsu-liang.*  
 Kiang, *Daggethal.*  
 Kichenev, *Kichenau (Supp.)*  
 Kikinda, (Supp.)  
 Kilauva (l.), *America, 194,*  
*Sandwich Islands.*  
 Kilbirnie, *Argyleshire.*  
 Kilbrennan Sound, *Arran.*  
 Kildrum, *Waterford.*  
 Kileh-shegar, *Assyria, 498.*  
 Kilimane, *Zambesi.*  
 Killaloe, *Clare.*  
 Killington Peak, *Appala-*  
*chians, 321.*  
 Killybegs, *Donegal.*  
 Kilmichael Point, *Wexford.*  
 Kilmair (r.), *Tray.*  
 Kimbri, *Cimbri.*  
 Kimberidge coal, *Shale.*  
 Kimploung, (Supp.)  
 Kingchew, (Supp.)  
 King, explorer, *Australian*  
*Explorations (Supp.), 410.*  
 Kingarth, *Vitriol Fort.*  
 King-bird, *Tyrant Shrike.*  
 King Charles's South Land,  
*Terra del Fuogo.*  
 King-duck, *Eider.*  
 King-ki-tao, *Coron.*  
 King of the herrings, *Shad.*  
 King's hood, *Ruminantia.*  
 King's Island, *Bengal, Bay of.*  
 King's Island, *Limerick.*  
 Kingtang, *Ningpo.*  
 King vulture, *Cendor.*  
 King William's Town, *Kap-*  
*Fraria, British.*  
 King-wood, (Supp.)  
 Kisi Balu, *Borneo.*  
 Kino, Jamaica, *Seaside Grapt.*  
 Kintpu, *Coron.*  
 Kin-to-Ching, (Supp.)  
 Kintore, *Abderdeenshire.*  
 Kinzig (r.), *Black Forest.*  
 Kipper, *Salmon, 446.*  
 Kippure (ml.), *Dublin.*  
 Kirchheim, (Supp.)  
 Kirsensk, *Irmsk.*  
 Kiraghuna, *Acletoptera.*  
 Kirkdale Cavern, *Caves.*  
 Kirk-kiliasia, (Supp.)  
 Kirton, *Crediton.*  
 Kirynasaa, *Ganges, 614.*  
 Kishenau, (Supp.)  
 Kishengunga, *Manufwabed*  
*(Supp.)*  
 Kishon, *Carmel.*  
 Kish-Tsbai, *Nucha (Supp.)*  
 Kisil (r.), *Ural.*  
 Kisil-Irmak (r.), *Anatolia, 226.*  
 Kisly Thomas nut, *Hichory.*  
 Kissavo, *Ossa.*  
 Kitchen middens, *Recent*  
*Period.*  
 Kitjap, *Sey.*  
 Kitta, *Magle.*  
 Kittalinnies, *Appalachians,*  
*321.*  
 Kizil-Uzen, *Azerbaijan.*  
 Klar (r.), *Wener Lake.*  
 Klaus Narr, *Court-foot.*  
 Kleene boc, (Supp.)  
 Klek (ml.), *Dinavic Alps.*  
 Klephts, *Armatolos.*  
 Kletgau, *Schaffhausen.*  
 Klip (r.), *Natal.*  
 Klip-dasse, *Daman.*  
 Klipspringer, (Supp.)  
 Kliuchi, *Zlatoust.*  
 Kliutschewsk, *Volcanoes.*  
 Kliodnitz, *Oder.*  
 Kloster-Erbacher, *Rhino-wina.*  
 Klutha, *Olego.*  
 Kneading by machinery,  
*(Supp.)*  
 Knees, broken, *Broken Knees.*  
 Kneph, *Ammon.*  
 Knashnin, *Russian Lang. &*  
*Lit.*  
 Knight-heads, *Shipbuilding,*  
*684.*  
 Knock (ml.), *Banffshire.*  
 Knockmahon, *Waterford.*  
 Knockmeledown (ml.), *Tip-*  
*perary.*  
 Knot, bird, (Supp.)  
 Knot of Cusco and Paeco,  
*Peru, 436.*

Knyana Inlet, *Cape of Good Hope*.  
 Kobdo (r.), *Altai Mts.* (Supp.)  
 Kobrin, (Supp.)  
 Kocher (r.), *Neckar*.  
 Kocbia, *Baloderr*.  
 Koepang, *Timor*.  
 Koeti, *Borneo*.  
 Kohik, *Bokhara*.  
 Ko-kor-no, *Tibet*.  
 Kokum oil, *Cocum Oil* (Supp.)  
 Kolberg, *Colberg*.  
 Koleh, *Algeria*, 141.  
 Kolorum, *Niger*, *Tippoo Sahib*.  
 Koles, *India*, 539.  
 Kolguet, *Kalguel*.  
 Kolubara (r.), *Servia*, 609.  
 Koluri, *Salamis*.  
 Komorn, *Comorn*.  
 Komotapur, *Loll Basaar* (Supp.)  
 Komul, *Turkestan*, 585.  
 Komuldsina, *Ghummurajina*.  
 Konaie (r.), *Brakmaputra*.  
 Konevitz, *Ladoga*.  
 Kongsberg, *Silver*, 730.  
 Kongun, *Congoon* (Supp.)  
 Königgrätz battle, *Germany* (Supp.), 534.  
 Königsbora, salt-works of, *Umsa*.  
 Königsmark, Countess A. *Saxs*, *Count of*.  
 Königstein (mt.), *Saxony*, 513.  
 Königswarth, (Supp.)  
 Koolokamba, *Gorilla*.  
 Koombar, *Gmelina* (Supp.)  
 Kooth, *Putchuk*.  
 Köping, *Maalar*, L.  
 Köppli, *Moh. Ol. Emp.* 149.  
 Koree (r.), *Ajmeer*.  
 Korkilo, *Cape, Cos*.  
 Kormachiti, *Cape, Cyprus*.  
 Koro, *Fiji Islands*.  
 Korona, *Carlstadt*.  
 Körts (r.), *Thesis*.  
 Korotcha, (Supp.)  
 Kosala, *Oude*.  
 Kosciusko (mt.), *N. S. Wales*.  
 Kosel, *Oder*.  
 Kosi, *Little (r.), Purneah*.  
 Kosila (r.), *Almora* (Supp.)  
 Kosmos, *Chaos*.  
 Koso, *Cuzco*.  
 Kotelnoi, *New Siberia*.  
 Köthen, *Cöthen* (Supp.)  
 Kotoroi, *Yaroslav*.  
 Kotoura, *Khot* (Supp.)  
 Kottagerry, *Ootacamund*.  
 Kottbus, *Cottbus*.  
 Kotzebue's Sound, *America, Russian*.  
 Kowek, *Ain-tab* (Supp.)  
 Kowno honey, *Lime (Linden)*.  
 Kowrie, *Kauri*.  
 Krafla, *Iceland*, 505.  
 Krakow, *Cracow*.  
 Krakowska (r.), *Jaworow* (Supp.)  
 Kral, *Padisah*.  
 Krame, *Booth*.  
 Kranen, *Peter, Vondel*.  
 Kranichfeld, *Saxs-Meiningen*.  
 Krapina, (Supp.)  
 Krasnoi-yar, *Caspian Sea*.  
 Krensiir, (Supp.)  
 Kriegsberg, battle, *Nisch* (Supp.)  
 Kris, (Supp.)  
 Kronenberg, (Supp.)  
 Krotalon, *Castanets*.  
 Krückau, *Elmskorn*.  
 Krupp's steel, (Supp.)  
 Krusenstern, *Chev. von* (Supp.)  
 Krylov, J. A. (Supp.)  
 Kuang nam, *Quang nam* (Supp.)  
 Kuban (r.), *Caucasus*.  
 Kudamba, *Cadamba* (Supp.)  
 Kuilenburg, *Culenburg*.  
 Kukolnik, *Nestor, Russian Lang. & Lit.*  
 Kulpa (r.), *Carniola*.  
 Kuluglis, *Barbary*.  
 Kunawur, *Buzsakar* (Supp.)  
 Kund, *Tamil*.

Leo Africanus, Africa, 65.  
 Leon, Lizard, Spanish Lang. & Lit. 20.  
 Leonde, *Rovuma* (Supp.).  
 Leonine City, Rome, 323.  
 Leonisti, Waldenses.  
 Lepoldinia, *Chiquichiqui*.  
 Lepanto, Gulf of, Corinth, Gulf of.  
 Lepidolite, *Mica*.  
 Lepidostrobos, *Sigillaria*.  
 Lepisma, (Supp.).  
 Leporidae, *Hydris*.  
 Lepidides and Leptus, Tick.  
 Leptis, *Barbary*.  
 Le Puy, Puy, La.  
 Lercara de' Freddi, (Supp.).  
 Lernean Marsh, *Argolis*.  
 Le Rocher d'Aaron, *St Malo*.  
 Lescon, *Navarre*.  
 Les Saintes, *Guadeloupe*.  
 Lease (r.), *Namur*.  
 Leasesp, M. de, *Suez*, (Supp.).  
 Lesson, (Supp.).  
 Lestocq, *Elizabeth Petrovna*.  
 L'Estrange, H. Sabbath, 402.  
 Lestria, *Sinau*.  
 Letter-book, *Book-keeping*.  
 Letterkenny, *Dougal*.  
 Lettran, *Lectern*.  
 Letters-patent, *Letters*.  
 Leuckart, *Tapeworm*, 294, *Trichina*.  
 Leucothopos, and leucopathy or leucosis, *Albinos*.  
 Leucorhœa, (Supp.).  
 Leucosia, *Leukosia*.  
 Leukœmia, *Leucocythemia*.  
 Leutschau, (Supp.).  
 Leuze, (Supp.).  
 Le Vaillant, Fr. (Supp.).  
 Levanter, *Mediterranean Sea*.  
 Levator ani, *Anus* (Supp.).  
 Levellers, *Whiteboy*.  
 Leven (r.), *Dumbartonshire*.  
 Leven (r.), *Lancashire*.  
 Leven (r.), *Tasmania*, 306.  
 Leveson Gower, *Bilemerv*.  
 Levico, (Supp.).  
 Levisticum, *Umbellifera*.  
 Lewanda, *Russian Lang. & Lit.*  
 Lewis, *Dampier Archipelago*.  
 Lewis (r.), *Washington* (territory).  
 Lewis, Ch. *Bookbinding*.  
 Lewis's Fork, *Snake River*.  
 Lex Hortensia, Rome, 313.  
 Lex Julia, *Sumptuary Law*.  
 Ley, John, Sabbath, 402.  
 Leyden, John, (Supp.).  
 Leyte, *Philippine Islands*.  
 Ley-Timor, *Moluccas*.  
 Lez, *Herasuit*.  
 L'hombre, *Quadrille*.  
 Lhoughor, *Caermarthenshire*.  
 Li, (Supp.).  
 Liakhoff Islands, *Siberia*, 702.  
 Liaou, *New-Chuang* (Supp.).  
 Libertines, *Calvin*, 525.  
 Libra, *As*.  
 Libri-Carrucci, (Supp.).  
 Licata, *Alicata* (Supp.).  
 Licentiate, *Orders*, *Holy*.  
 Lichen, *Prickly Heat*.  
 Lichen starch, *Iceland Moss*.  
 Liche-wache, *Wake*.  
 Lichtenberg, *Rhenish Prussia*.  
 Lichtenstein (trav.), *Africa*, 66.  
 Licinian Law, *Agriarius Law*.  
 Licking (r.), *Kentucky*.  
 Liddel (r.), *Chiviot Hills*.  
 Liebfrauenmilch, *Worms* (town).  
 Liebig's condenser, *Retort*.  
 Liebig's extract, *Soup*.  
 Liebig's soup for children, *Soup*.  
 Liedertafel, *Vaudeville*.  
 Lienz, *Tyrol*.  
 Life-line, *Life-preservers*.  
 Life mortars and rockets, (Supp.).  
 Life-rocket department, (Supp.).

Ligament, *Bivalve Shells*.  
 Light, undulatory theory of, *Undulatory Theory of Light*.  
 Lighting of beacons and buoys at sea, (Supp.).  
 Lighting, accidents from, (Supp.).  
 Lightning-meal, *Lycopodiacea*.  
 Lign aloes, *Aloes Wood*.  
 Lillenstein (mt.), *Saxony*, 513.  
 Lily, Guernsey, *Amaryllidea*.  
 Lima (r.), *Entre Douro e Minho*.  
 Limassol, *Cyprus*.  
 Limbara (mts.), *Sardinia I.*  
 Limber, *Shipbuilding*, 684.  
 Limbs, artificial, *Artificial Limbs* (Supp.).  
 Lime-ball light, *Drummond Light*.  
 Limestone shales, lower, *Carboniferous System*.  
 Limmat (r.), *Alps*, *Zürich*.  
 Linne, *Hytte* (Supp.).  
 Limousin, *France*, 469.  
 Limoux, (Supp.).  
 Limpopo (r.), *Oori*.  
 Linacre, *Medicine*, *Hist.* of, 386.  
 Linares, *Toad-flax*.  
 Linaria, *Toad-flax*.  
 Lincoln College, *Oxid.* (Supp.).  
 Lindisfarne, *Holy Island*.  
 Lindsay, Family of, (Supp.).  
 Lines, fishing, *Angling*, 256.  
 Ling, *Heath*.  
 Lingavats, *Saivos*.  
 Lingga (is.), *Rionov*.  
 Linguagrossa, (Supp.).  
 Lingual bone, *Tongue*.  
 Lingua Romana rustica, *Romanic Languages*.  
 Linguetta, Cape, *Albania*, 104.  
 Lingula, (Supp.).  
 Links, *Golf*.  
 Linthe (r.), *Argyleshire*.  
 Linoleum, (Supp.).  
 Linth, *Glarus*.  
 Linton, *Cambridgeshire*.  
 Lion monkey, little, *Tamarin*.  
 Lipalula, *Oori*.  
 Liparis vulgaris, *Sucking Fish*.  
 Ippia, *Alyssa*.  
 Ippstadt, (Supp.).  
 Ippation, *Tin*, 449.  
 Liquidation, *Joint-stock Coy.*.  
 Liria, (Supp.).  
 Lismore, *Waterford*.  
 Lismore, Dean of, his book, *Gaelic Lang. & Lit.*  
 Lissum, *Cable*.  
 Lithang, *Tibet*.  
 Lithobius, *Centipede*.  
 Litho-fracteur, *Nitro-glycerine* (Supp.).  
 Lithomancy, *Divination*.  
 'Little Go, *Cambridge Univ.* 531.  
 Little Snake (i.), *Anguilla*.  
 Littorina, *Periwinkle*.  
 Littré, M. P. E. (Supp.).  
 Livas, *Turkey*, 587.  
 Liver-rock, *Quarry*.  
 Liverworts, *Hepatica*.  
 Livingston, Ed. (Supp.).  
 Livingston, R. R. (Supp.).  
 Lixum, (Supp.).  
 Ljungan, *Sweden*, 236.  
 Ljusne (r.), *Sweden*, 236.  
 Llandello-vawr, *Caermarthenshire*.  
 Llandello rocks, *Silur. Rocks*.  
 Llandowery, *Caermarthenshire*.  
 Llandowery rocks, *Silur. Rocks*.  
 Llanerch-y-meddi, *Anglesey*.  
 Llangefni, *Anglesey*.  
 Llanrwst, *Denbighshire*.  
 Llerena, (Supp.).  
 Llobregat, *Catalonia*.  
 Lloyd's Bonds, (Supp.).  
 Llumayor, (Supp.).  
 Loading, *Tontine*.  
 Loapula (r.), *Zambesi*.  
 Löbau, (Supp.).  
 Loblolly Bay, *Gordonia*.  
 Lobolobo, *Violaceæ*.

Lob-worm, *Lug-worm*.  
 Locality, *Phrenology*, 516.  
 Locarno, *Ticino*.  
 Lochaber, *Inverness-shire*.  
 Lochan-Eilean, *Crannogog*, 305.  
 Lochar, *Dumfriesshire*.  
 Lochgilphead, *Argyleshire*.  
 Lochindorb, *Crannogog*, 305.  
 Loch Lochy, *Caled. Canal*.  
 Lochmaben, *Dumfriesshire*.  
 Loch Muick, *Balmoral*.  
 Loch-na-gar, *Aberdeenshire*.  
 Loch-na-Keal, *Mull*.  
 Lochy (r.), *Inverness-shire*.  
 Lochy (r.), *Tay*.  
 Lockyer, *Sun*.  
 Locofoco, *Republican*.  
 Locomotive, *Railways*, 89.  
 Locust (r.), *Black Warrior*.  
 Locusta, *Libster*.  
 Locust-bean, *Carob*.  
 Loddon (r.), *Thames*.  
 Lodomeria, *Galicia, Austrian*.  
 Lods, (Supp.).  
 Loewy, *Sun*.  
 Logan, *Queenland*.  
 Logan stones, *Cornwall*, *Rocking Stones*.  
 Logcock, *Woodpecker*.  
 Log-hut, *Hut*.  
 Logon (r.), *Begharmi*.  
 Logan, *Rove*.  
 Loing (r.), *Seine*.  
 Lokao, *Indigo*.  
 Lolland, *Laaland*.  
 Loll Bazaar, (Supp.).  
 Loma (mt.), *Niger*.  
 Lombardo-Venetian Kingdom, *Venice*, 754.  
 Lomnitz, *Carpathian Mts.*  
 Lomond (mts.), *Fifeshire*, *Kinross-shire*.  
 London pride, *Saxifrage*.  
 London rocket, *Hedge-mustard*.  
 Long-beard, *Bromeliacea*.  
 Long Bird (i.), *Bermudas*.  
 Long Forties, *Buchan-Ness*.  
 Long Hope, *Hoy*.  
 Long Island, *Bahamas*.  
 Longobardi, *Lombards*.  
 Long-sight, *Sight*, *Defects of*.  
 Longton, (Supp.).  
 Lougue (i.), *Seychelles Is.*  
 Longueville, *Duchesse de*, *Rambouillet*.  
 Long-wall, *Mining*.  
 Lonneker, *Overysel*.  
 Loon, *Diver*.  
 Loopers, *Caterpillar*.  
 Loop Head, *Shannon*.  
 Lope de Rueda, *Spanish Lang. & Lit.* 20.  
 Lopez, *Paraguay*, 258.  
 Lopez, Cape, *Guinea*, *Gulf of*.  
 Lopez, Gen. *Maximilian* (Supp.).  
 Lophiodon, *Tapir*.  
 Lophophanes, *Tit*.  
 Lophorina, *Bird of Paradise*.  
 Lorca, *Murcia*.  
 Lord Howe's Isl. *Society Is.*  
 Lord of Misrule, *Revels*, *Master of Election*, *Trinds*.  
 Lords of Prayer, *Pater-noster*.  
 Loreley, *Sirens*.  
 Lorenzo Marquez, *Sofala*.  
 Loricata, *Reptiles*, 197.  
 L'Orient, *Morbihan*.  
 Lorn, *Argyleshire*.  
 Lorn, Lords of, *Stewart Family*, 126.  
 Lorraine, Family of, *Guise*.  
 Los Pastos, *Andes*, 239.  
 Los Pinos, *Cuba*.  
 Losse, *Ger.*  
 Los Serranos, *Patagonia*.  
 Lossie, *Elginshire*.  
 Losva, *Pern.*  
 Lot (r.), *Villeneuve d'Agen*.  
 Lota, *Burbot*.  
 Lotarius I. *Carlovingians*.  
 Loudon, Marshal, *Seven Years' War*, 637.

Louis II., V. *Carlovingians*.  
 Louis VI., VII., VIII., X. *Capetian Dynasty*.  
 Louisburg, *America*, 126.  
 Louisiade Archipelago, *Pa-pua*, 251.  
 Loule, (Supp.).  
 Loup (r.), *Alpes Maritimes* (Supp.).  
 Loup-garou, *Werewolf*.  
 Louise, sheep, *Sheep-louse*.  
 Louven (r.), *Norway*, 799.  
 Louvre, *Paris*, 273.  
 Louvis (mt.), *Veliki-Louki*.  
 Love-feasts, *Agapa*.  
 Love-lics-bleeding, *Amaranth*.  
 Lover, Sam. (Supp.).  
 Low Archipelago, (Supp.).  
 Low Church, *England and Ireland Church of*, 61.  
 Lowe, Robt. (Supp.).  
 Lowea, *Rox.*  
 Löwenberg, or Löwenkopf, *Siebnberg*.  
 Löwes, Loch of the, *Yarrow*.  
 Lowthers, *Lancashire*.  
 Lowtherston, *Fermanagh*.  
 Loza, *Ecuador*.  
 Lozère (mt.), *Cevennes*.  
 Luabo (r.), *Zambesi*.  
 Lubber-line, *Compass*, *Mariners*.  
 Luca, *Lucra*.  
 Luca Borgo, *Algebra*.  
 Luca della Robbia, *Sculpture*, 577.  
 Lucas, traveller, *Africa*, 66.  
 Lucayoe, *Bahamas*.  
 Luca, *Pike*.  
 Luca (r and bay), *Wigtown*.  
 Lucken gowan, *Globe-flower*.  
 Lucky proach, *Father-lasher*.  
 Lucuma, *Sapotacea*.  
 Lucumo, *Tarquinus*.  
 Lucy, Sir T. *Shakspere*.  
 Ludenscheid, (Supp.).  
 Ludwig's Canal, *Germany*, 718.  
 Luffia (r.), *Africa*, 68.  
 Lugar, *Ayrshire*.  
 Lugdunum, *Lyon*.  
 Lugdunum Batavorum, *Leyden*.  
 Lugg (r.), *Radnershire*.  
 Lugna-quilla (mt.), *Wicklow*.  
 Logo, (Supp.).  
 Lugos, (Supp.).  
 Lulla (r.), *Sweden*, 236.  
 Lullu, *Opera*.  
 Lumpfish, *Lumpsucker*.  
 Lumps of delight, *Ratel-coum*.  
 Luna, *Selene*.  
 Luna, Gulf of, *Spesia*.  
 Luna cornea, *Photography*, 507.  
 Lunawaura, (Supp.).  
 Lundu (r and mt.), *Sarawak*.  
 Lundy Isle, (Supp.).  
 Lundy's Lane, battle of, *Scott*, *Winfield*.  
 Lunc, *Lancashire*.  
 Lunel, *Muscotel*.  
 Luni, *Sarmana*.  
 Lunule, *Bivalve Shells*.  
 Lupata (mts.), *Africa*, 66.  
 Lupuline, *Hept.*  
 Lure, *Falconry*, 227.  
 Luschnitz, *Moldau*.  
 Lusiad, *Camoens*.  
 Luso (r.), *Rubicon*.  
 Luss, *Dumbartonshire*.  
 Luta Nzinge, Little, *Albert N'yanza* (Supp.).  
 Lu-Tchu, *Loo-Choo*.  
 Lute, (Supp.).  
 Luternberg, *Seven Years' War*, 637.  
 Lutetia, *Paris*, 271.  
 Lutter, battle of, *Thirty Years' War*.  
 Lutterbach, *Bielefeld*.  
 Lütlich, *Liege*.  
 Lüttrighausen, (Supp.).  
 Luxemburg, *Germany* (Supp.), 536.  
 Luxor, *Thebes*.

Luzula, (Suppl.)  
 Lycium, Wolf, 344.  
 Lycium, Box-thorn.  
 Lycophron, Alexandrine Age.  
 Lycophron, Thesaur.  
 Lycopsis, Bugloss.  
 Lycopus, Gyssy-wort (Suppl.)  
 Lydch (L.), Ranoch.  
 Lyke-wake, Wake.  
 Lymphangitis, Weed.  
 Lympe, Hythe (Suppl.)  
 Lyon (r.), Tay.  
 Lyonia, Sorrel Tree.  
 Lyre pheasant, Lyre Bird.  
 Lyrie, Pogge.  
 Lysippus, Sculpture, 577.  
 Lystra, Bin-Bir-Kilisa.  
 Lythe, Pollack.  
 Lyton, Columbia, British.  
 Maanelvan Falls, Waterfall.  
 Mabinogion, Welsh Lang. & Lit. 136.  
 Mabol, Date Plum.  
 Macacus, Rhesus Monkey.  
 Macacus silenus, Wanderoo.  
 Macallister (r.), Victoria, 785.  
 Macaraca, (Suppl.)  
 Macarthy's Island, Gambia.  
 Macrauco, Lemur.  
 Maculube, (Suppl.)  
 M'Clellan, General, Richmond.  
 Macdonald, Flora, Stuart, Ck. Ed.  
 M'Dowell, General, U.S. 659.  
 Macduff, Banff.  
 Macduff's Cross, Sanctuary.  
 Macedonian war, Rome, 316.  
 Macfarren, G. A. (Suppl.)  
 Mac-Flecknoe, Shad.  
 M'Gregor, Robert, Rob Roy.  
 Machaon, Esculinus.  
 Machavanna, Delagoa Bay.  
 Mache, Corn Salad.  
 Machery, Atur (Suppl.)  
 Machetes, Ruff.  
 Mackarel midge, Rockling.  
 Mackenzie (r.), Queensland.  
 Mackerel-guide, Garfish.  
 M'Kinlay, explorer, Australian Explorations (Suppl.), 421.  
 Maclear, Sir T. Triangulation.  
 M'Leay (r.), New South Wales.  
 Macure, Sir R. J. le M., (Suppl.)  
 MacMurrrough, Wexford.  
 Macconnais, Saône-et-Loire.  
 Macot, Savoy.  
 Macouba, Martinique.  
 Macoya, Macaw-tree.  
 Macpherson, Major, Orissa.  
 Macquarie Harbour, Tasmania, 306.  
 Macrocystis pyrifera, Algw.  
 Macroon, (Suppl.)  
 Mada, Kama.  
 Madalena, Madeira River.  
 Mad-apple, (Suppl.)  
 Madwasca, Ottawa River.  
 Maddalena (L.), Caprera (Suppl.)  
 Madder style, Calico Printing, 512.  
 Maderno, Carlo, Peter's, St.  
 Madhuca-tree, Bassia.  
 Madiana, Martinique.  
 Madison (mt.), White Mts.  
 Mudoc, America, 198.  
 Madog of Powys, Prince, Welsh Lang. & Lit. 136.  
 Madre de Dios, Patagonia.  
 Madrepore glass, Glass, 774.  
 Mænon, Agathocles.  
 Maeshowe, (Suppl.)  
 Mæstral, Mistral.  
 Mæfia, Zanzibar.  
 'Maga', Blackwood.  
 Magalhaens, Magellan.  
 Magdala, Cennesaret, Sea of Magdala, (Suppl.)  
 Magdaahoe, Zanzibar.  
 Magelang, Java (Suppl.), 580.  
 Maghrib, Morocco.  
 Magi, Parsees, 309.  
 Magnesian water, Altrated Water.  
 Magnesium, magnesium light, (Suppl.)  
 Magnetic equator, meridians, and poles, Terrestrial Magnetism, 372.  
 Magnetism, Animal, Animal Magnetism.  
 Magnetism of rotation, Rotation, Magnetism of.  
 Magneto-electric machine, (Suppl.)  
 Magog, Gog & Magog.  
 Magonia glabrata, Tingi.  
 Magot, Barbary Ape.  
 Magvey, Agave.  
 Mahaica, Guiana, Brit. 132.  
 Mahaicomby, Guiana, Brit. 132.  
 Mahaleb, Cherry.  
 Mahameru (mt.), Yava (Suppl.), 579.  
 Maha Sarboji, Schwarz.  
 Maha-Singh, Ranjeet-Singh.  
 Mahawelli-ganga, Ceylon, 737.  
 Mahé, Pondicherry.  
 Mahé (L.), Seychelles Islands.  
 Mahabourg, Mauritius.  
 Mahee, Galle.  
 Mahi (r.), Balasinore (Suppl.)  
 Mahim, (Suppl.)  
 Mahmoudieh, canal of, Alexandria.  
 Mahmud I., II. Ot. Emp. 149, 150.  
 Mahon Bay, Nova Scotia.  
 Mahowa-tree, Bassia.  
 Mahren, Moravia.  
 Maiaisi, Society Islands.  
 Mainland, Calcutta.  
 Maiden of Norway, Alexander III. of Scotland.  
 Maiden Rocks, Antrim.  
 Maiden Stone, Sculptured Stones.  
 Maigue (r.), Shannon.  
 Main (r.), Antrim.  
 Maine (r.), Kerry.  
 Mainland, Pomona.  
 Mainland, Shetland.  
 Maio, Cape Verd Islands.  
 Mals del Agua, Victoria, 789.  
 Maitai (r.), Nelson (Suppl.)  
 Maista, Society Islands.  
 Maitland, (Suppl.)  
 Maitland Club, Rox. Club.  
 Maize beer, Chica.  
 Majak (r.), Borneo.  
 Majesty of bismuth, Bismuth.  
 Majoon, Hashish.  
 Majunga, Bembalooka.  
 Makarius, Russ. Lang. & Lit. Maki, Lemur.  
 Ma-kiang, Cochinchina.  
 Makololo tribe, Zambesi.  
 Makta, battle of, Algeria, 141.  
 Malabar rat, Bandicoot.  
 Malacca canes, Rattan.  
 Malachite green, Bice.  
 Maladetta, Pyreneas.  
 Malahite, Pyreneas.  
 Malakhoff, Duc de, Pelissier.  
 Malaskerd, battle of, Alps.  
 Malatia, Kurdistan.  
 Malayalam or Malayarma, Tamil.  
 Malbrouk, Cercoabius.  
 Malcolmia, Stock.  
 Malgha, (Suppl.)  
 Malégnano, Melagnano.  
 Malekites, Sunnites.  
 Mali, Maldive Islands.  
 Mallard, Duck.  
 Mallembe, Caongo.  
 Mallet, C. F. de, (Suppl.)  
 Malleus Malecharum, Witch-craft, 225.  
 Mallicollo, New Hebrides.  
 Maloewa, Ombay.  
 Malpighian corpuscles, Spleen.  
 Malta, Phœnicia, 490.  
 Maltese-point, Lacs.  
 Maltese work, Filigree.  
 Mambai, Bombay.  
 Mambone, Sefala.  
 Mammaliferous crag, Norwich Crag.  
 Mammary tumour, Adenocela (Suppl.)  
 Mammoth trees of Calaveras, Wellingtonia.  
 Mammurk (mt.), Galway.  
 Mamore, Madeira River.  
 Manacles, Torture.  
 Managua, (Suppl.)  
 Manama, Bakrin Islands.  
 Mana Pass, Bhadrinath.  
 Manbote, Weragid.  
 Manby, G. W. (Suppl.)  
 Manchester School, Gibbon.  
 Manchus, Tungus.  
 Manco Capac, Peru, 438.  
 Mandarin duck, Summer Duck.  
 Mandi, Kumson.  
 Mandibles, Bill, 91.  
 Mandioc, Manioc.  
 Mandrites, Abbot.  
 Mandu, (Suppl.)  
 Manetobah (L.), Red River Settlement.  
 Mangabeys, Cercoabius.  
 Mangle, Cook Islands.  
 Mango ginger, Curcuma.  
 Mangouste, Ichneumon.  
 Mangrove hen, Rail.  
 Manguaba (L.), Alagoas.  
 Man-hole, Boiler, 195.  
 Manice, Delagoa Bay.  
 Manillas, Ring Money.  
 Manille, Quadrille.  
 Maniple, Legion.  
 Manitch, Don.  
 Manitoba (L.), Winnipeg.  
 Manjera, Bander.  
 Mannheim gold, Alloy.  
 Manning (r.), New South Wales.  
 Manresa, (Suppl.)  
 Mansel, H. L. (Suppl.)  
 Mansourah, battle of, Egypt, 791.  
 Mansuetæ naturæ, Tame Animals.  
 Mantaro (r.), Ucayali (Suppl.)  
 Mantes, (Suppl.)  
 Mantis crab or shrimp, Squill.  
 Man-traps, Traps.  
 Mantras, Veda, 793.  
 Manuel, emperors, Byzantine Empire, 472.  
 Manuhērika, Otago.  
 Manukau, New Zealand, 741.  
 Man-wyrth, Weragid.  
 Mape, Incorpus.  
 Mapoota (r.), Zululand.  
 Mar, Aberdeenshire.  
 Marabhangha, Ganges, 614.  
 Maracanda, Samarband.  
 Maragatos, Leon.  
 Maraja palm, Bactris.  
 Marakah, Dougola.  
 Marakina, Tamarin.  
 Marangaba, Guava.  
 Maranoo, Darling.  
 Maranos, Amazon.  
 Marash, Kurdistan.  
 Maravi, Nyassa.  
 Mara wood, Icos (Suppl.)  
 Marazques, Liqueur.  
 Marburg, battle of, Seven Years War, 677.  
 Marcasita, Pyrites.  
 March, Morava River.  
 March, (Suppl.)  
 March, Karls of, Stewart Family, 123.  
 Marchan (r.), Athama (Suppl.)  
 Marcomanni, Bohemia, 90.  
 Marcy (mt.), New York.  
 Marden, Cuba.  
 Mareca, Wildgeon.  
 Marecchia (r.), Rivind.  
 Mare Erythraum, Arabian Sea.  
 Marennas, Charente-Inférieure.  
 Margy, (Suppl.)  
 Margurde (mt.), Leira.  
 Margosa tree, Malacca.  
 Mar, Niger.  
 Marie (L.), Tassonia, 26.  
 Mariakirch, St. Marie (Suppl.)  
 Mariampol, Mariopol.  
 Marianna (is.), Ladron.  
 Mariana, (Suppl.)  
 Marianna (L.), Seychelles I.  
 Maricucana, Bahamas.  
 Mariefried, Marler, Loh.  
 Marienberg, (Suppl.)  
 Marienthal, battle of, Tumm.  
 Mariguano, Melagnano.  
 Marigot, Marie Galante.  
 Marimooda, Atele.  
 Marineo, (Suppl.)  
 Marino, (Suppl.)  
 Marion, Alabama.  
 Marique, Ovi.  
 Maris, Sumatra.  
 Maritaska, Macaraca (Suppl.)  
 Marit-duren, Dèren.  
 Markelo, Overysel.  
 Mariken, Zaidler Za.  
 Markgrafenhain, Grossschick.  
 Marking-ink, Silver, 730.  
 Marking-out, (Suppl.)  
 Markobrunner, Klein-mis.  
 Marlborough dog, Bleskian Dog.  
 Marl-grass, Clover.  
 Marlistone, Lies, Oelle.  
 Marmotta, Ohio G, Rhode-Island.  
 Marony (r.), Guiana, French.  
 Maros (r.), Thais.  
 Maros Porto, Caribury.  
 Marquette, Superior, Lake.  
 Marrah, Darfur.  
 Marron d'Ëen, Trnja.  
 Marsaglia, battle of, Victor Amadeus.  
 Marsdiep, Helder.  
 Marshall, Michigan.  
 Marshall, Texas.  
 Marsh harrier, Buzzard.  
 Marsh hen, Rail.  
 Marshland, Middle Level (Suppl.)  
 Marsh pennywort, Hydrocotyle.  
 Marsh rosemary, Statice.  
 Marsh trefoil, Buchiana.  
 Marsiva, (Suppl.)  
 Marsupium, Eye, 208.  
 Marta and Mariana, Bohemia.  
 Martinach, Martigny.  
 Martin Garcia, Buenos Ayres.  
 Maru (L.), Timor-Laut.  
 Marusa, Society Islands.  
 Marvejois, Leira.  
 Marwar, Rajpoot.  
 Mary (L.), Queensland.  
 Maryborough, Queen's County.  
 Maryborough, Queensland.  
 Mary's grass, Iceland Moss.  
 Masaccio, Painting, 17.  
 Masagrau, Algeria, 141.  
 Masaya, (Suppl.)  
 Masbate, Philippines Islands.  
 Mascara, (Suppl.)  
 Masham, Mrs. Ann, Queen.  
 Mashona, (Suppl.)  
 Mask (L.), Corrid L., Guinea.  
 Maskat, Muscat.  
 Masora, Masorah, New, 71.  
 Masoretic text, Bible, 74.  
 Masoua, Masouah (Suppl.)  
 Masouga, Masouga, Bay of, Sefala.  
 Massilia, Marcellus.  
 Massilians, Senu-Peloponnesium.  
 Massinima, Caribage.  
 Massowah, (Suppl.)  
 Master and servant, (Suppl.)  
 Master of the Revolt, Leira.  
 Master of the, Mississippi.  
 Masts, iron and steel, (Suppl.)  
 Masudi, Arabian Lang. & Lit. 347.  
 Matachel, (Suppl.)  
 Matadorea, Queensland.  
 Mataram, Lombok.  
 Mataura, Otago.

of Materials, 160.  
 Mat-grass, *Nardus*.  
 Mathematical physicians.  
 Medicines, *Hist. of*.  
 Main dog, (Supp.)  
 Matrix, *Type*, 606.  
 Matrix Composer, *Printing*  
 (Supp.)  
 Matrona (r.), *Marna River*.  
 Matronalia, *Juno*.  
 Matsumai, (Supp.)  
 Mattawa, *Ottawa River*.  
 Matherhorn, *Cervin*.  
 Matthiesen, John, *Anabap-*  
*tists*, 218.  
 Matthiola, *Stock*.  
 Mattock (r.), *Boyna*.  
 Matula, *Sefala*.  
 Mauchline, *Ayrshire*.  
 Maud, Empress, *Stephen of*  
*England*.  
 Maudhold Head, *Man, Isle of*.  
 Maule (r.), *Chili*.  
 Mauléon, *Pyrenees, Bases*.  
 Mauna, *Navigators Islands*.  
 Mauna, *Sandwich Islands*.  
 Maunch, *Manch*.  
 Mauraneria, *Styx*.  
 Maurice of Saxony, (Supp.)  
 Maurolycus, *Optics*.  
 Mavinger, *Glass*, 778.  
 Mavrocardato, *Mavrocardato*.  
 Mawdchach (r.), *Mervioneth*.  
 Maw-worm, *Axaris*.  
 Maxillary arch, *Skeleton*, 753.  
 Maximilian of Mexico, (Supp.)  
 Maximiliana, *Inaja Palm*  
 (Supp.)  
 Maximin, *Alexander Severus*.  
 Maximus Planudes, *Anthol-*  
*ogy*, 288.  
 May, *Hawthorn*.  
 Maya, *Moluccas*.  
 May-apple, *Pedophyllum*.  
 Mayaguez, *Parro Rico*.  
 May-drink, *Cumarin, Wood-*  
*ruff*.  
 Mayer, *Anatomy*, 207.  
 Mayhem, *Beating & Wound-*  
*ing*.  
 Maymene, (Supp.)  
 Mayo (r.), *Sonora*.  
 Mayonnaise, *Remoulade*.  
 Mayotta, (Supp.)  
 Mays del Monte, *Rhizanthes*.  
 Mayweed, *Pteris*.  
 Mazamet, (Supp.)  
 Mazzaron, (Supp.)  
 Mazurabad, (Supp.)  
 Mbau, *Fiji Islands*.  
 Meade, General, *U.S.* 660.  
 Meadow lark, *Starling*.  
 Meadow sweet, *Spiraea*.  
 Meal, mountain, *Animacule*,  
 270.  
 Meander, *Caria*.  
 Meandrina, *Brainstone Coral*.  
 Measures, *Wrights &*  
*Measures*.  
 Meausros, *French, Chemistry*  
 (Supp.)  
 Meat, preserved, *Preservers*  
 (Supp.)  
 Meat-biscuit, *Biscuit, Meat*.  
 Meatus, external, *Ear*, 709.  
 Medeah, (Supp.)  
 Mediasch, *Transylvania*.  
 Medical officer of health,  
*Sanitary St.* (Supp.), 725.  
 Medina (r.), *Wight, Isle of*.  
 Medina de Rio Seco, (Supp.)  
 Medinat Habu, *Ramesses*,  
*Thebes*.  
 Mediolanum, *Milan, Santes*.  
 Medlock, *Oldham*.  
 Medium, *Porrus*.  
 Medusa's head, *Pentacrinus*.  
 Medviditsin(r.), *Dou (Rusia)*.  
 Meenas, *Bundi (Supp.)*.  
 Meerane, (Supp.)  
 Megakles, *Pelistratus*.  
 Megala Kastros, *Candia*.  
 Megalopolis, *Arcadia*.  
 Megapoda, *Young Plover*.  
 Megaptera, *Whale*, 120.



Mogony, *Irrawadi*.  
 Moguer, (Supp.)  
 Mohammed I., II., III., IV., *Ottoman Empire*, 148.  
 Mohammads, of Spain, *Omniades*, 72.  
 Mohammed Ali, *Mehemed*.  
 Mohammedan sects, (Supp.)  
 Mohammed - ben - Alhamar, *Spain*, 17.  
 Mohammed-ben-Jakub, *Arabian Lang. & Lit.* 349.  
 Mohammed-ben-Musa, *Algebra*.  
 Mohamed Ibn - Toumert, *Almohads*.  
 Mohar, *Millet*.  
 Mohaut, *Hibiscus*.  
 Mohilla, *Comoro Isles*.  
 Moha (i.), *Riga, Gulf of*.  
 Moikart, *Loch, Shields, Loch*.  
 Mokassin snake, *Trigonoccephalus*.  
 Moke, *Belgium*, 3.  
 Mokkalad (mts.), *Nummulites*.  
 Moko-moko (r.), *Sumatra*.  
 Mokaha, *Penza, Tambor*.  
 Mokshank, *Penza*.  
 Molars, *Teeth*, 329.  
 Mole (r.), *Surrey, Thames*.  
 Molecule, *Chemistry* (Supp.), 461.  
 Molekin, (Supp.)  
 Molina, *Tirso de, Alarcón y Mendosa*.  
 Molino el Rey, battle of, *Scott, Winfield*.  
 Mölln, *Lauenburg*.  
 Moloch, *Phanicia*, 494.  
 Moloch, nat. hist. (Supp.)  
 Moloe, *Cantharis*.  
 Mologa (r.), *Novgorod*.  
 Molokai, *Sandwich Islands*.  
 Molossi, *Epirus*.  
 Molothrus, *Troopial*.  
 Moltke, H. (Supp.)  
 Molucca beans, *Gaillardana*.  
 Mombacho, *Nicaragua* (i.).  
 Mombasa or Mombaz, (Supp.)  
 Mona, *Anglesy*.  
 Mona, *Cercopithecus*.  
 Monacacy, *Potomac*.  
 Monadhiadh (mts.), *Elginsh*.  
 Monads, *Triads*.  
 Monaldeschi, *Christina*.  
 Monamines, *Organic Bases*.  
 Monarchians, *Patrisiansians, Unitarians*, 641.  
 Monas, *Sabellius*.  
 Monastir, (Supp.)  
 Monada, *Orthes*.  
 Mondega (r.), *Paraguay* (r.).  
 Mondego (r.), *Portugal*.  
 Mondhar, *Omniades*, 72.  
 Monevolagh (mts.), *Waterford*.  
 Monfia, *Zansibar*.  
 Monganui, *New Zealand*.  
 Mongrel, *Hybrid*.  
 Monitor, *Turret-ship*.  
 Monkey-bread, *Adansonia*.  
 Monkey-flower, *Mimulus*.  
 Monk-fish, *Angel-fish*.  
 Monk-Wearmouth, *Sunderland*.  
 Monnica, *Augustine, A. St.*  
 Monochlamydeous, *Flower*.  
 Monogenea, *Trematoda*.  
 Monogenesis, *Reproduction*, 195.  
 Monokeros, *Unicorn*.  
 Monomotapa, *Zambesi*.  
 Monooch, *Rhinoceros*.  
 Monotropa, *Winter Green, Old of*.  
 Monroe (mt.), *White Mts.*  
 Monselico, (Supp.)  
 Montagne, *Montagnards*.  
 Montagnes Noires, *Côtes-du-Nord*.  
 Montagues, *Verona*.  
 Montagues, *Capulet* (Supp.)  
 Montaldi, *Genoa*, 684.  
 Montaña, *Peru*, 436.  
 Montcalm, *Arige*.  
 Montcalm, *Wolfe*.  
 Mont-de-Maran, (Supp.)  
 Mont d'Or, *Tura*.  
 Monte Epomeo, *Ischia*.  
 Montemayor, Jorge de, *Spanish Lang. & Lit.* 20.  
 Montesa, *Lady of Montesa*.  
 Monte Salvadore, *Lugano*.  
 Monté Santo, *Athos*.  
 Moates de Oca, *Venezuela*.  
 Monte Viso, *Alps*.  
 Monte Vulture, *Melfi* (Supp.)  
 Montferrier, *Clermont*.  
 Montgomery, Gen. U.S. 654.  
 Montmedy, *Meuse*.  
 Mont Mezière, *Ardèche*.  
 Montmorency, Falls of, *Quebec*.  
 Montmorillon, *Vienne*.  
 Montpellier scammony, *Cyananthum*.  
 Montpensier, Mademoiselle de, *Orleans, F. B. G., Duc d'*.  
 Mont Perdu, *Pyrenees*.  
 Montralier, *Ardege*.  
 Montreuil, *Pas-de-Calais*.  
 Montrose, Duke of, *Lindsay Family* (Supp.)  
 Monte de l'Estérel, *Var*.  
 Mont St Hubert, *Ardèche*.  
 Mount Saint Jean, *Waterloo*.  
 Mood, *Sylogism*.  
 Moodkee, *-Madki*.  
 Moog, *Kidney-bean*.  
 Mooriverdorp, *Transvaal Republic*.  
 Moonga, *Silk & Silkworm*, 724.  
 Moonta, *South Australia*.  
 Moonwort, *Botrychium*.  
 Moor-ball, *Conferoa*.  
 Moor buzzard, *Harrier*.  
 Moordilla, *Barringtoniacra*.  
 Moorfoot Hill, *Edinburghsh.*  
 Moor-ill, *Red Water*.  
 Moorra, *Bowstring Hemp*.  
 Moose gray, *Wapiti*.  
 Moosehead (i.), *Maine*.  
 Mooshillcock, *Appalachians*, 321.  
 Moquegua, (Supp.)  
 Moradabad, (Supp.)  
 Morales, *Spanish Lang. & Lit.* 40.  
 Moral expectation, *Probability*.  
 Moral sense, *Ethics*, 140.  
 Mora-stones, *Upala*.  
 Morat, *Bay Islands, Kuantan*.  
 Moravides, *Marabuts*.  
 Moray, *Earls of, Stewart Family*, 124.  
 Morbilli, *Measles*.  
 More, Antonio, *Painting*, 192.  
 Morelia, (Supp.)  
 Morella, (Supp.)  
 \* More port, *Podargus*.  
 \* Morei, *Encyclopedia*, 48.  
 Moreton Bay pine, *Araucaria*.  
 Morgagni, *Anatomy*, 220.  
 Morgan, Dr William, *Welsh Lang. & Lit.* 137.  
 Morgan, Henry, *Bucaners*.  
 Morgona (r.), *Villefranch-sur-Sabne*.  
 Moriah, *Jerusalem*.  
 Morinus, *Samar. Pentateuch*.  
 Moriscos, *Moors*.  
 Morkuk, *Kurdistan*.  
 Morlaks, *Dalmatia*.  
 Morland, Sir Samuel, *Speaking-trumpet, Waldenses*.  
 Mormond Hill, *Buchan*.  
 Mornington, Earl of, *Wellesley*.  
 Moroc, *Honey-guide*.  
 Moros, *Moors*.  
 Moroshkin, *Russian Lang. & Lit.*  
 Morotaba (r.), *Borneo*.  
 Morozite, *Apatite*.  
 Morphy, Paul, *Chess*, 801.  
 Morris, Hugh, *Welsh Lang. & Lit.* 137.  
 Mors, *Rhenish Prussia*.  
 Morse's recording instrument, *Telegraph*, 335.  
 Mortality, 95.  
 Mortars, *Life Mortars, &c.* (Supp.)  
 Mortgages, taking of, *Taking of Mortgages*.  
 Mortlach, *Banfikire*.  
 Morton, Dr, *Anaesthesia*.  
 Morven, *Argyleshire*.  
 Mosaic gold, *Alloy, Bronzing*.  
 Mosaic wool, (Supp.)  
 Mosayima, (Supp.)  
 Mosbach, *Biberack*.  
 Moschatel, tuberous, *Aralia*.  
 Moskhestrom, *Malstrom*.  
 Moskwa, (Supp.)  
 Muselman, *Musulman*.  
 Mosquitia, *America*, 205.  
 Moss agates, *Mocha Stones*.  
 Moss-bee, *Humble Bee*.  
 Mossierham, *Omniades*, 71.  
 Mostaganem, *Algeria*, 121.  
 Mostarda, *Serrisina*.  
 Motala (r.), *Wetter, Lake*.  
 Motassem, *Calif*.  
 Motasilites, (Supp.)  
 Motella, *Kochling*.  
 Motzebti, *Arabian Lang. & Lit.* 348.  
 Mother Goose, *Pantomime*.  
 Mother-of-pearl opal, *Cacholong*.  
 Moth-hunters, *Goatsuckers*.  
 Motions, *Puppet*.  
 Motir, *Maluccas*.  
 Motores oculorum, *Nervous System*.  
 Motte-de-Vesoul (mt.), *Vesoul*.  
 Mottin, *Sattre*.  
 Motley, J. Joe Miller (Supp.)  
 Motu Proprio, *Consulati*.  
 Moulden, *Mulden*.  
 Mouldboard, *Plough*.  
 Mouldiness of wine, *Wine*, 223.  
 Mouldwarp, *Mole*.  
 Moulin, *Glacier*, 767.  
 Moultrie, Fort, *Sullivan's Is.*  
 Mountain blue, *Bice*.  
 Mountain damson, *Simarubaceae*.  
 Mountain finch, *Brambling*.  
 Mountain flour, *Bergmehl*.  
 Mountain green, *Green Earth*.  
 Mountain House, *Appalachians*, 321.  
 Mountain laurel, *Orodaphne*.  
 Mountain tea, *Gaultheria*.  
 MountBarrow, *Tasmania*, 306.  
 Mount Desert, *Maine*.  
 Mountjoy, Viscounts, *Stewart Family*, 126.  
 Mount Leinster, *Wexford*.  
 Mount Lofty, *S. Australia*.  
 Mountmellick, (Supp.)  
 Mount Misery, *Christopher's, St.*  
 Mount's Bay, *Cornwall*.  
 Mount Seir, *Edom*.  
 Mount Wellington, *Tasmania*, 306.  
 Mousa, (Supp.)  
 Mousseron, *Mushroom*.  
 Moutan, *Paony*.  
 Moutiers, *Savoie*.  
 Movable, *Heritable*.  
 Mowee (i.), *America*, 194.  
 Moy (r.), *Sligo*.  
 Moydard, *Inverness-shire*.  
 Mozdarians, *Motasilites* (Supp.)  
 Mozdok, (Supp.)  
 Msta (r.), *Novgorod, Tver*.  
 Mualich, *Mualitch*.  
 Muchettes, *Espringal*.  
 Muchuo, *Rhinoceros*.  
 Much Woolton, (Supp.)  
 Muckers, (Supp.)  
 Mucus, *Blennorrhoea*.  
 Mud-fish, (Supp.)  
 Muffie, *Assay*.  
 Muggelsee, *Spreu*.  
 Muglitz (r.), *Saxony*, 513.  
 Mugwort, *Artemisia*.  
 Muhesur, (Supp.)  
 Mühlbach, *Transylvania*.  
 Muic (r.), *Deu*.  
 Muide (r.), *Saxony*, 513.  
 Muiceta, *Bull-fight*.  
 Mulgobian, *San Thier*.  
 Mulhacca (mt.), *Sierra Nevada*.  
 Müller, *Grinding*.  
 Müller, *Engraving*, 72.  
 Müller, G. F. *Roman Lang. & Lit.*  
 Müller, Jul. (Supp.)  
 Mullidze & Mullis, *Sarcellet*.  
 Mulliyak, *Armagh*.  
 Multilocular shells, *Urbair*.  
 Multiple proportion, av of *Atomic Theory*.  
 Mulinia (r.), *Atlas M.*  
 Mummelose, *Baden*.  
 Munchesgrätz, *baric, Germany* (Supp.), 533.  
 Münden, *Minden*.  
 Mundenian, *Anatomy*, 228.  
 Mundlauer, *Indur*.  
 Munsoepoor, *Cassy*.  
 Mungoo, *Kidney-bean*.  
 Mungah, *Mungah*.  
 Mumbaccs, (Supp.)  
 Münster, *Treaty of, Westphalia, Treaty of*.  
 Münster sheathing metal *Alloy*.  
 Muotta (r.), *Brunnen, Schyng*.  
 Mur (r.), *Croatia*.  
 Murad Bey, *Tunis*.  
 Mura Usa (r.), *Yangtze-kiang*.  
 Murchison (mt.), *Sashtaburgh*.  
 Murchisonborough, *Tennessee*, U.S. 660.  
 Murg (r.), *Black Forest, Rhine*.  
 Murgah, (Supp.)  
 Murgthal, *Black Forest*.  
 Muriated water, *Mineral Waters*.  
 Muro, (Supp.)  
 Muroong (r.), *Borneo*.  
 Muroyon, *Venezire*.  
 Murray, *Steppes, Catlin-plateau* (Supp.)  
 Murray, *Sanguine*.  
 Murrumbidgee (r.), *N. S. Wales*.  
 Murry, *Murra*.  
 Murumuru, *Astracarya*.  
 Murwa, *Elucania*.  
 Muscardine, *Dermone*.  
 Muscari, *Grape-hyacinth* (Supp.)  
 Muscatine, *Iowa*.  
 Muschiki, *Serbia*, 671.  
 Muscular force, *organs* (Supp.)  
 Mush, *Kurdistan*.  
 Musi (r.), *Kisao*.  
 Musi (r.), *Sumatra*.  
 Music, *Greek, Great Musi*.  
 Music recorder, (Supp.)  
 Musivum, *Bromus*.  
 Muskegon (r.), *Michigan*.  
 Musketry, *schools of, N. S. Service* (Supp.)  
 Muskingum (r.), *Ohio*.  
 Musmon, *Murgh*.  
 Muspelheim, *Scandinavian Mythology*, 524.  
 Mussel-bands, *Cardinis*.  
 Mussel Shoals, *Tennessee*.  
 Mustafa I., II., III., *Ottoman Empire*, 149.  
 Mustapha-ben-Abdalla, *Haji Khalifah*.  
 Mustarabians, *Messarian Liturgy*.  
 Mutanites, *Melanites* (Supp.)  
 Mutina, *Modena*.  
 Mutina, *barile of, Andrews, N.*  
 Mutisim, *Aphasia* (Supp.)  
 Mutton-bird, *Tasmania*, 371.  
 Muttra, (Supp.)  
 Mutwal, *Calcutta*.  
 Myrcas, *New Granada*.  
 Myrcle (mt.), *Saxony*.  
 Myrcium, *Pyramid*, 30.  
 Myrciona, *Parasitic Diptera*.

Mydaus, *Telau*.  
 Mygdonia, *Nisibis*.  
 Myhee (r.), *Cambay*.  
 Myletes, *Salmonida*.  
 Mynpuri, (*Supp.*)  
 Myology, *Anatomy*, 227.  
 Myopia, *Eye*, 207.  
 Myothera, *Ant-catcher*.  
 Myra, *Lycia*.  
 Myriandros, *Phoenicia*, 492.  
 Myricaria, *Tamarisk*.  
 Myricin, *Wax*.  
 Myrmecoon, *Ant-lion*.  
 Myrmica, *Ant*, 284.  
 Myrmidons, *Agina*.  
 Myron, *Sculpture*, 577.  
 Myropetra, *Wasp*.  
 Myrrh, *Cicely*.  
 Myzomela, *Blood-bird*.  
 Naab, *Bavaria*, 760.  
 Naango, *Biafra*.  
 Nabegha, *Arabian Lang. & Lit.* 347.  
 Nabon (r.), *Fars*.  
 Nadder (r.), *Wiltshire*.  
 Naftia, *Lago*, (*Supp.*)  
 Nāgas, *Savias*.  
 Nagasena, *Nagrujwa*.  
 Nagia Racee, *Eleusina*.  
 Nagna (r.), *Nowanagar* (*Supp.*)  
 Nagpore the Less, *Chota Nagpore*.  
 Nagy Karoly, (*Supp.*)  
 Nagy Kikinda, *Kikinda* (*Supp.*)  
 Nagy-Saombath, *Tyrnau*.  
 Naharro, *Spanish Lang. & Lit.* 20.  
 Nahavend, battle of, *Sassanids*.  
 Nahe (r.), *Rhenish Prussia*.  
 Nahiyehs, *Turkey*, 587.  
 Nahr-el-Asi, *Orontes*.  
 Nahr-el-Haleb (r.), *Aleppo*.  
 Nain, *Labrador*.  
 Nainital (r.), *Himalaya*.  
 Najerila, *Ebro*.  
 Nakir, *Mohammedanism*.  
 Nakshab, *Karshi* (*Supp.*)  
 Naksakov, *Laaland*.  
 Namagari (r.), *Vaal River*.  
 Namatote, *Papua*, 251.  
 Namaycush, (*Supp.*)  
 Namby-pamby, *Phillips, Amb*.  
 Namnanghan, *Turkistan*, 584.  
 Namoi (r.), *Darling*.  
 Nana Sahib, (*Supp.*)  
 Nānak, *Sikhs*.  
 Nanas, (*Supp.*)  
 Nanda Devi, *Himalaya*.  
 Naning, *Malacca*.  
 Nan-ling (mts.), *Chinese Empire*, 815.  
 Napo (r.), *Amazon*.  
 Napoleon II, *Reichstadt, Duke of*.  
 Napoleona, *Belvisia*.  
 Napoleon-Vendée, (*Supp.*)  
 Nar (r.), *Tiber*.  
 Nar (r.), *Wash*.  
 Naranganj, *Dacca*.  
 Narborough Isle, *Galapagos Islands*.  
 Nardō, (*Supp.*)  
 Narenta (r.), *Bosnia, Dalmatia*.  
 Narev, *Bialik*.  
 Narim, *Ob*.  
 Narin (r.), *Thian-Shan*.  
 Narova, *Petipa*.  
 Narr Klaus, *Court-foot*.  
 Narr, *Sinda*.  
 Narraganset Bay, *Rhode I.*  
 Narragansets, *Rhode I.*  
 Narrow, *Nevis Island*.  
 Narseberry, *Sagittilla Plum*.  
 Nashed, *Nassik* (*Supp.*)  
 Nasmyth, James, *Steam-hammer*, *Sass*, 202.  
 Nassik, (*Supp.*)  
 Nat, *Egypt*, 287.  
 National education, (*Supp.*)  
 National Sunday League, *Suburb*, 403.  
 Natone (r.), *Cividal*.  
 Natives, *Oyster*.  
 Natrium, *Sodium*, 801.  
 Natrix, *Snake*.  
 Natural Bridge, *Virginia*.  
 Natural selection, *Species*.  
 Nau, *Cape, Cotrom*.  
 Nauclea, *Cadamba* (*Supp.*)  
 Naupactos, *Etolia, Lepanto*.  
 Naussa, *Faros*.  
 Nautilus propeller, (*Supp.*)  
 Naval regulations, *Regulations, Mil. & Nav.*  
 Navel-string, *Umbilical Cord*.  
 Navier (r.), *Sutherland*.  
 Navies, *Canal*, 551 (*note*).  
 Navy, British, *War Services* (*Supp.*)  
 Navy retirement, *Retirement*.  
 Navy schoolmaster, *Schoolmaster, Army & Navy*.  
 Nazareth (r.), *Ogobai* (*Supp.*)  
 Naze, the, *Scandinavia*.  
 Nazza, *Saxe-Coburg-Gotha*.  
 Neapolis, *Naples*.  
 Near-sight, *Sight, Defects of*.  
 Neasbo (r.), *Kansas*.  
 Nechtansmere, battle of, *Scotland*, 555.  
 Neckar Highlands, *Baden*.  
 Necrophorus, *Burying Beetle*.  
 Necrosis, *Teeth*, 330.  
 Nectan, *Picts*.  
 Nectandra, *Greenheart*.  
 Nectanebes, *Egypt*, 791.  
 Nedjed, *Arabia*, 344.  
 Needle-furze, *Gesta*.  
 Needle-guns, *Breech-loading Arms* (*Supp.*)  
 Needles, the, *Wight, Isle of*.  
 Needle-woods, *Conifera*.  
 Neemuch, (*Supp.*)  
 Neenah, *Fox River*.  
 Neepigon (r.), *Superior, Lake*.  
 Negapatam, (*Supp.*)  
 Negative, *Photography*, 510.  
 Negrais, *Bengal, Bay of*.  
 Negro (r.), *Red River*.  
 Negrohead, *Tobacco*, 463.  
 Negro monkey, *Semnopithecus*.  
 Negus, *Abyssinia*.  
 Neilgherries, *Ootacamund*.  
 Neill, General, *Alahabad*.  
 Neiva, *Nevisian* (*Supp.*)  
 Nekao, *Egypt*, 791.  
 Nellore, (*Supp.*)  
 Nell's Point, *Barry Island*.  
 Nelson, (*Supp.*)  
 Nelson (r.), *Hudson's Bay*.  
 Nematoneura, *Zoology*, 359.  
 Nen, or Nene (r.), *Bedford Level, Cambridgeshire, Wash*.  
 Nenagh (r.), *Tipperary*.  
 Neo-Castro, *Navarino*.  
 Neokhorri, *Pella*.  
 Neopianta, *Neusatz*.  
 Nepal paper, *Daphn.*  
 Nepal plateau, *India*, 537.  
 Nepean Bay, *South Australia*.  
 Nepeta, *Catmint*.  
 Nephin (mt.), *Mayo*.  
 Nephites, *Mormons*.  
 Nephralgia, *Kidneys*.  
 Nephthys, *Egypt*, 788.  
 Nepidae, *Water-bug*.  
 Neptune, *Planets*.  
 Neptune's cup, *Alcyonium*.  
 Ner (r.), *Lods* (*Supp.*)  
 Nera (r.), *Tiber*.  
 Nerao, *Lot-el-Garonne*.  
 Nerchinsk (mts.), *Irkutsk*.  
 Nergal, *Assyria*, 500.  
 Neriad, (*Supp.*)  
 Neris-la-Bains, *Montluçon*.  
 Nero (r.), *Rostof, Greece*, 83.  
 Nervulus, *Greece*, 83.  
 Nervion (r.), *Bilbao*.  
 Nervous diseases, (*Supp.*)  
 Nest-building apes, (*Supp.*)  
 Nestorian Chronicle of *Russian Language & Literature*, 289.  
 Nestos (r.), *Macedonia*.  
 Netta (r.), *Angustosa* (*Supp.*)  
 Nettuno, *Antium*.  
 Netze, *Posen*.  
 Neu-Chwang, (*Supp.*)  
 Neuenburg, *Neuchâtel*.  
 Neuera, *Ceylon*, 737.  
 Neufahrwasser, *Danaig*.  
 Neuilly, (*Supp.*)  
 Neumünster, (*Supp.*)  
 Neural arch, *Skeleton*, 751.  
 Neuraophyses, *Skeleton*, 751.  
 Neurology, *Anatomy*, 227.  
 Neustadt, *Banya*.  
 Neustadt, *Saxe-Weimar-Eisenach*.  
 Neustettin, (*Supp.*)  
 Neusuls, *Saxe-Meiningen*.  
 Neutra, (*Supp.*)  
 Nevada de Tolima, *New Granada*.  
 Neviansk, (*Supp.*)  
 Neville, *Warwick, Earl of*.  
 Nevin, *Carnarvonshire*.  
 New Amsterdam, *Berbice, Essequibo*.  
 New Archangel, *Novoarkhangelsk*.  
 Newars, *Nepaul*.  
 Newborough, *Anglesey*.  
 New Braunfels, *Texas*.  
 New Brunswick, *Canada* (*Supp.*), 447.  
 Newcastle, *Delaware*.  
 Newcastle, *Limerick*.  
 Newcastle, *N. South Wales*.  
 Newchurch, (*Supp.*)  
 Newcomen, *Steam-engine*, 99.  
 Newfoundland, *Canada* (*Supp.*), 448.  
 New Galloway, *Kirkcubrightshire*.  
 New Georgia, *Antar. Ocean*.  
 New Grange (cairn), *Cairn*.  
 New Holland goose, *Cervopit.*  
 New Holland vulture, *Talgalla*.  
 New Jersey Tea, *Red Root*.  
 New Kingston, *Kingston-upon-Thames*.  
 New Lanark, *Owen, Robert*.  
 Newmilns, *Ayrshire*.  
 New Orkneys, *Antar. Ocean*.  
 New Orleans moss, *Bromeliaceae*.  
 New Philippines, *Texas*.  
 New Providence, *Bahamas*.  
 New River, *Great Kanawha*.  
 New River, *Middlesex*.  
 Newry (mts.), *Armagh*.  
 New Sarum, *Salisbury*.  
 New Spain, *Atacama*.  
 New Toledo, *Camana*.  
 Newton, *G. S. Painting*, 106.  
 Newtown, *Wight, Isle of*.  
 Newtownbarry, *Wexford*.  
 Newtown - Mount - Kennedy, *Wicklow*.  
 New Westminster, *Columbia, British*.  
 New-Year River, *Bogun*.  
 Ngan-Hoee, *Gan-Hwuy*.  
 Ngan-King, (*Supp.*)  
 Ngomano, *Rovuma* (*Supp.*)  
 Ngornu, *Angornow* (*Supp.*)  
 Ngoutane, *Oort*.  
 Ngouyai (r.), *Ogobai* (*Supp.*)  
 Niagara and Onondaga epochs, *America*, 202.  
 Niare, (*Supp.*)  
 Nib-nib, *Nib-nib*.  
 Nicander, *Alexandrine Agr.*  
 Nicaragua, (*Supp.*)  
 Niccolo of Fuligno, *Alunno*.  
 Nioce, *Alpes Maritimes* (*Supp.*)  
 Nicophorus Botanates, *Alexand. Commerce*.  
 Niephorus Phocas, *Byzantine Empire*, 471.  
 Nicholsjeak, *Assur*.  
 Nicholas, Jn., (*Supp.*)  
 Nickelino, *Aronical Minerals*.  
 Nicker-tree, *Guilandana*.  
 Nicolai, Otto, (*Supp.*)  
 Nicolas Kanabus, *Byzantine Empire*, 471.  
 Nidaros, *Trondhem*.  
 Nidd (r.), *Yorkshire*.  
 Nid-Elv (r.), *Trondhjem*.  
 Nidhugger, *Niflheim*.  
 Nidwald, *Unterwald*.  
 Niende, *Rovuma* (*Supp.*)  
 Niens (r.), *Maas*.  
 Nieumiedersce, *Alps*.  
 Nieuwe Diep, *Amstern*.  
 Nieuwer Amstel, (*Supp.*)  
 Nigger caterpillar, *Black*.  
 Night-blindness, *Sight defects of*.  
 Night-churr, *Goatsucks*.  
 Night-scented rocket, *D Violet*.  
 Nigritia, *Africa*, 61.  
 Nihau, *Sandwich Isla*.  
 Nijneuduinak, *Irkutsk*.  
 Nijni-Kamtchatk, *tchanka*.  
 Nikkul Seyn, *Nicholse* (*Supp.*)  
 Nikolsburg, armistice, *many* (*Supp.*), 534.  
 Nikosia, *Lebania*.  
 Nilgiri, *Neilgherry Mts*.  
 Nimach, *Nemuch* (*Supp.*)  
 Nimbus, *Clouds*.  
 Nimeguen, *Nijmegen*.  
 Nimrud, *Layard*.  
 Ning-thee, *Irrawadi*.  
 Ninth-day disease, *Tri Nascentium*.  
 Ninus, *Ninovah*.  
 Niobrara, *Nebraska*.  
 Nipissing (r.), *Canada*.  
 Nirmidea, *Parasitic Ani*.  
 Niscemi, (*Supp.*)  
 Nisch, (*Supp.*)  
 Nissa, *Nisch* (*Supp.*), *msud.*  
 Nisus, *Sparrow-hawk*.  
 Nith, *Dumfriesshire*.  
 Niti-Ghaut, (*Supp.*)  
 Nitocira, *Egypt*, 780.  
 Nitre-why, *Refrigeran*.  
 Nitro-benzol, (*Supp.*)  
 Nitro-glycerin, (*Supp.*)  
 Nivelle, *Pyrenées, Basses*.  
 Nizam-al-Mulk, *Seljuks, Arslan*.  
 Nizami, *Persian Lang Lit.* 427.  
 'No 200', *Alabama* (*Su*) 379.  
 No-Ammon, *Ammon*.  
 Nobili, *Thermo-electric*.  
 Noble, *Fogge*.  
 Noble, *Race-noble*.  
 Noctua, *Cabbage Moth*.  
 Noctule, (*Supp.*)  
 Nogal (r.), *Somali Lan*.  
 Nogat (r.), *Vistula*.  
 Nogays, *Turks*.  
 Noguera (r.), *Aragon*.  
 Nourmouter, *France*, 47.  
 Noma, *Cancerum Oris* (*Sa*)  
 Nombre de Dios, (*Supp.*)  
 None-so-pretty, *Saxifra*.  
 Nonnenstein (mt.), *Sax* 513.  
 Nonpareil, *Type*, 607.  
 Noosuch (r.), *Bermudas*.  
 Nopal, *Cochinal*.  
 Norborg, *Alern*.  
 Norden, (*Supp.*)  
 Nore (r.), *Tipperary*.  
 Norfolk Island pine, *A caria*.  
 Northampton, *Shire*.  
 Norse, *Scandinavian L. & Lit.* 522.  
 Norska, *Norway*.  
 North Anna, battle of, *U. S*.  
 North Branch (r.), *Tenne*.  
 North-east (r.), *Trane*.  
 Northern Light-houses, (*missioners of*, (*Supp.*)  
 Northern Lights, *Ar. Borealis*.  
 North German Confedera, *Germany* (*Supp.*), 535.  
 Northshead, *Chilterns I. dreds*.  
 805

INDEX.

North-west Passage, *Maclure*  
(Supp.)  
Norton Sound, *American*,  
*Russian*.  
Noss, *Brassy*.  
Nossi-Be, (Supp.)  
Nossi-Ibrahim, (Supp.)  
Notation, chemical, *Chem-*  
*istry* (Supp.)  
Notonectidm, *Water-bug*.  
Notornis, (Supp.)  
Notre Dame Inlet, *New-*  
*foundland*.  
Nottorno, *Sermade*.  
Nouba, *Wady*, *Nubia*.  
Noumenon, *Philosophy*, 487,  
*Substance*.  
Noussa-Laut, *Moluccas*, 52.  
Novara, battle of, *Radelzky*.  
Nova Scotia, *Canada* (Supp.),  
447.  
Novich, (Supp.)  
Novello, C. & V. (Supp.)  
Novgorod-Sjiewersk, (Supp.)  
Novograd-Volynski, (Supp.)  
Novi, battle of, *Sworof*.  
Novitiave, *Monachism*, 526.  
Novo, *Ladaga*.  
Novogrodek, *Lithuania*.  
Nowanagar, (Supp.)  
Noya Bay, *Spain*, 13.  
Noyes, J. H. *Perfectionists*  
(Supp.)  
Nahiego-Mbouvé, *Gorilla*.  
Nu, *Egypt*, 788.  
Nucha, (Supp.)  
Nueva Caceres, *Philippine Is.*  
*Nugget*, *Gold*, 815.  
Nuggina, (Supp.)  
Nuggur, *Bednore* (Supp.)  
Nukha, *Nucha* (Supp.)  
Nullification, (Supp.)  
Numb-fish, *Torpedo*.  
Numen, *Om*.  
Numenius, *Whimbrel*.  
Numitor, *Romulus*.  
Nun, *Niger*.  
Nunes, *Senegambia*.  
Nuphar, *Water-lily*.  
Nurzek, *Biltek*.  
Nuthé (r.), *Zerbst*.  
Nyborg, *Flakurs*.  
Nyiregyhaza, (Supp.)  
Nykjöbing, *Falster*.  
Nylandischen Skären, *Swen-*  
*borg*.  
Nyroca, *Scapp Duck*.

Oakingham, *Wokingham*.  
Oak-lungs, *Lungwort*.  
Oat-cakes, *Bread*, 318.  
Oaklike grass, *Arrhematherum*.  
Obcordate, *Leaves*.  
Obdorsk, *Ob*.  
O Bece, *Racz*.  
Ober-Hesse, *Germany* (Supp.)  
535.  
Obertyn, battle of, *Sigmund*.  
Obi (r.), *Moluccas*.  
Obi, *Ob*.  
Obion (r.), *Tennessee*.  
Object-lessons, *Urbis Pictus*,  
*Pestalozzi*.  
Obovate, *Leaves*.  
Obree, *Papua*, 250.  
Obstetrics, *Midwifery*.  
Obwald, *Unterwalden*.  
Ocean currents, *Gulf Stream*.  
Ochilree, *Lords*, *Stewart*  
*Family*, 123.  
Ochri (r.), *Albania*.  
Ochrbite, *Cerite*.  
Ock, *Berkshire*.  
Ockment, West (r.), *Dartmoor*.  
Octant, *Sextant*.  
Octave rule of the, *Rule of*  
*the Octave*.  
Octavo, *Book*, 225.  
Octodécimo, *Book*, 225.  
Oddern, *Christiansand*.  
Odenkirchen, (Supp.)  
Odét (r.), *Finisitve*.  
Odo, *Bishop of Bayeux*,  
*William I. & II. of England*.  
Odyliam, *Animal Mag.* 267.  
Odyseus, *Ulyssa*.  
Odysey, *Homer*.  
Oe, O.

Œa, *Tripoli*.  
Oedenburg, (Supp.)  
Œenante, *Water Dropwort*.  
Œerfá Jökul, *Iceland*, 505.  
Œesel, (Supp.)  
Œeair, *Scandinavian Myth*, 524.  
Œestre Bygd, *Greenland*.  
Œeta-Nata, *Papua*, 250.  
Œfen, *Buda*.  
Œffa's Dyke, (Supp.)  
Œffenbach, Jacques, (Supp.)  
Œfficers' allowances, *Allow-*  
*ances, Officers*.  
Œgechee lime, *Tupelo*.  
Œglio (r.), *Iseo (l.), Po*.  
Œogobai, (Supp.)  
Œgress, *Roundle*.  
Œguzian Turks, *Ottoman Em-*  
*pire*, 147.  
Œhiau, (Supp.)  
Œhm's law, *Galvanism*, 603.  
Œiech (l.), *Caledonian Canal*.  
Œidemia, *Scoler*, *Surf Duck*.  
Œidium, (Supp.)  
Œikel (r.), *Ross & Cromarty*.  
Œil City, *Oil-wells* (Supp.)  
Œil-fuel, (Supp.)  
Œil of apples, *Valerianic Acid*.  
Œil of spike, *Lavender*.  
Œil of verbena, *Lemon Grass*.  
Œil Springs (town), *Oil-wells*  
(Supp.)  
Œil-wells and oil-trade, (Supp.)  
Œinomania, *Dipsomania*,  
(Supp.), 499.  
Œintments, *Unguenta*.  
Œistin, *Barbadoes*.  
Œlak, *Labrador*.  
Œkanda (r.), *Ogobni* (Supp.)  
Œkavango (r.), *Zambesi*.  
Œkement, West (r.), *Dartmoor*.  
Œkonagan (r.), *Washington*  
*(territory)*.  
Œlan (mt.), *Alpes, Hautes*.  
Œlau and Œlawa, *Œhiau* (Supp.)  
Œldfieldia Africana, *Teak*.  
Œld Light Burghers, &c. U. P.  
*Church*, 646.  
'Œld Man of Coniston,' *Lan-*  
*cashire*.  
'Œld Man of the Mountain,'  
*Hassan-ben-Sabir*.  
Œld man pipes, *Tobacco-pipes*.  
Œld man's beard, *Bromeliacea*.  
Œld Woman's Isle, *Bombay*.  
Œlearos or Œliaros, *Antiparus*.  
Œlekma and Œlekminsk, *Lena*.  
Œlfactory bulb, *Brain*, 302.  
Œlhao, (Supp.)  
Œligulose, *Felispar*.  
Œlinda, (Supp.)  
Œliva, *Span Lang. & Lit.* 20.  
Œlive nuts, *Elocarpacea*.  
Œlivenza, (Supp.)  
Œlona (r.), *Milan*.  
Œlot, (Supp.)  
Œlympia, *Washington (ter.)*.  
Œlympian Mountains, *Van-*  
*couver's Island*.  
Œlympus (town), *Lycia*.  
Œlynthos, *Macedonia*.  
Œm (r.), *Tobolsk*.  
Œma, *Moluccas*.  
Œmaiades, *Ommiades*, 71.  
Œmar II. *Ommiades*, 71.  
Œmbre, *Quadrille*.  
Œmbres Chinoises, *Puppet*.  
Œmbrone (r.), *Grosseto* (Supp.)  
Œmenek, *Greenland*.  
Œmetepc, *Nicaragua* (l.).  
Œmmevides, *Ommiades*, 71.  
Œmototli, *Kamtchatka*.  
Œmun, *Calabar*.  
Œonatas, *Sculpture*, 577.  
Œonchus, *Fishes*, 355.  
Œondatra, *Musquash*.  
Œonegia, (Supp.)  
Œoneiromancy, *Divination*.  
Œoneyzah, *Wahabie*, 41.  
Œonion (r.), *Vermont*.  
Œonkaparinga (r.), *South Aus-*  
*tralia*.  
Œononis, *Rest-harrow*.  
Œonopordon, *Thistle*.  
Œonos agrios, *Unicorn*.  
Œontario, *Canada* (Supp.), 447.  
Œonteniente, (Supp.)  
Œoolowtee, *Cambay*.

Œomrawutti, (Supp.)  
Œoori (r.), *Transvaal Republic*.  
Œoaterschelling, *Terschelling*.  
Œootrum, (Supp.)  
Œopera buffa, *Buffo* (Supp.)  
Œophiology, *Zoology*, 357.  
Œophiosaurus, *Glass Snake*  
(Supp.)  
Œophr (mt.), *Malacca*.  
Œopossum shrimp, *Myzis*.  
Œoppa (r.), *Odor*, *Tropæum*.  
Œoppenheim, (Supp.)  
Œopposition (in astronomy),  
*Conjunction*.  
Œoptical ghosts, *Ghosts, Opti-*  
*cal* (Supp.)  
Œoptic thalamus, *Brain*, 302,  
303, *Cerebrum*.  
Œoral Law, *Talmud*.  
Œorange, *Roundle*.  
Œorange-root, *Hydrastis* (Supp.)  
Œorarium, *Stole*.  
Œorb (r.), *Herauld*.  
Œorbe (r.), *Neuchatel*.  
Œorbitolites, *Rhinopoda*.  
Œorkades, *Orkneys*.  
Œorcagna, A. *Painting*, 192.  
Œorchard grass, *Cock's Foot*  
*Grass*.  
Œorchids, *Orchidea*.  
Œorchy, *Awe* (l.).  
Œorco Falls, *Waterfall*.  
Œorcus, *Roman Religion*,  
*Ancient*, 302.  
Œorder-book, *Book-keeping*.  
Œorder of the day, *Parlia-*  
*ment*, 287.  
Œorellana, *Amazon*.  
Œorenburg gum, *Larch*.  
Œorensé, (Supp.)  
Œorestes, *Agamemnon*.  
Œorestes, *Odoacer, Rome*, 321.  
Œoria, *Edessa*.  
Œorgan, *Phrenology*, 513, 514.  
Œorganography or organology,  
*Botany*, 264.  
Œorganzine, *Silk & Silkworms*,  
724.  
Œoriental jade, *Nephrite*.  
Œoriental wood, *Carmine*.  
Œoriflammé, *Standard*.  
Œoriginal Burgher Presbytery,  
*U. P. Church*, 646.  
Œorizava (mt.), *Mexico*, 432.  
Œorkhan, *Ottoman Empire*,  
147.  
Œorkney (derivation of name),  
*Hebrides*.  
Œorkney, *Earls of, Hamilton*  
*Fam.* 213, *Sinclair Fam.*  
Œoria (r.), *Saxe-Weimar-Eis-*  
*nach*.  
Œorkil, *Orel*.  
Œormista, *Orosius*.  
Œormond, *Tipperary*.  
Œormuz, *Rock-salt*.  
Œormain, *Bar-le-Duc*.  
Œornithichnites, *Birds, Fossil*.  
Œornithogalum, *Star of Beth-*  
*lehem*.  
Œoronsay, *Colonsay*.  
Œorontiacæ, *Calla* (Supp.)  
Œoroshaza, (Supp.)  
Œorpine, *Sedum*.  
Œorsajo (mt.), *Parma*.  
Œorssa, battle of, *Sigmund*.  
Œortegal, *Cape, Spain*, 12.  
Œorthoclose, *Felispar*.  
Œorthognathous cranium, *Skull*,  
760.  
Œorthopædic surgery, *Surgery*,  
224.  
Œortler Spitz, *Tyrol*.  
Œortygia, *Alphius, Syracuse*.  
Œorus, (Supp.)  
Œorwell (r.), *Staffolk*.  
Œoryctognosy, *Minerology*.  
Œosborne, *Captain Sherard*,  
*Taeplings*.  
Œoschersleben, (Supp.)  
Œos innotinatum, *Felis*.  
Œosist, *Siout*.  
Œosma (r.), *Turkey*, 586.  
Œosmanli, *Othman*.  
Œosmanli, *Ottoman Empire*,  
147, *Turkey*, 587.  
Œosmerus, *Smell*.  
Œos sacrum, *Sacrum*.

Œossification, *Arteris, Di-*  
*of* (Supp.), 402.  
Œosteroe, *Færøe Isles*.  
Œostheim, *Saxe-Weimar-*  
*Eisenach*.  
Œostrich-farming, (Supp.)  
Œostuni, (Supp.)  
Œost Vaagen, *Lofoden*.  
Œotaha, *Society Islands*.  
Œothman I., II., III., *Ottoman*  
*Empire*, 147-149.  
Œothyl, *Acetyl* (Supp.)  
Œotis, *Bustard*.  
Œotjiherero, *Ovambo*.  
Œotoconia, *Ear*, 731.  
Œotolithus, (Supp.)  
Œotsego (l.), *Susnyehann*.  
Œotter, *Ghost-moth*.  
Œotter, *Peaks of, Appalachians*,  
321.  
Œotter (r.), *Norway*, 799.  
Œotocar, *Rudolf*.  
Œotochar, *Odoacer*.  
Œotto of roses, (Supp.)  
Œouchy, *Lausanne*.  
Œocades, *Amstel, Nimeur*  
*Amstel* (Supp.)  
Œoudon (r.), *Mayenne*.  
Œouessant, *Ushant*.  
Œouette, *Mayenne*.  
Œoughter (l.), *Cavan*.  
Œougreé, (Supp.)  
Œoulou-Keme (r.), *Yeni*.  
Œousel (r.), *Sussex*.  
Œousel, *Osnel*.  
Œousel (r.), *Buckinghamsh.*  
Œouycou, *Maniac*.  
Œovar, (Supp.)  
Œovarian tumour, *Ovaris*.  
Œovariotomy, *Ovaris*.  
Œoven bird, (Supp.)  
Œoverflacklee, *Holland, South*.  
Œovershot wheel, *Water-power*,  
94.  
Œovis, *Sheep*, 66.  
Œovoca, *Avoca*.  
Œovolau, *Fiji Islands*.  
Œovum angustum, *Viper*.  
Œowenmore (r.), *Skip*.  
Œowen Stanley (mt.), *Pepua*,  
250.  
Œowl parrot, *Kakapo* (Supp.)  
Œowynhee (r.), *Oregon*.  
Œowen-le-Field, *Darlington*.  
Œox-eye bean, *Crowæ*.  
Œoxford tracts, *Tractarianism*.  
Œoxidising flame, *Blow-pip.*  
Œox Mountains, *Skip*.  
Œoxychloride of carbon, *Pho-*  
*gene Gas*.  
Œoxysalts, *Salts*.  
Œoyapock, *Guiana, French*.  
Œoyster Bay, *Tasmania*, 26.  
Œoyster plant, *Salasfy*.  
Œozan, *Chisrovi*.  
Œozieri, (Supp.)  
Œozokerite, *Wax*.

Pabbay, *Skye*.  
Œpacasse, *Pagasse*.  
Œpachacamac, *Peru*, 43.  
Œpacheco, *Donna Maria de*  
*Padilla, Juan de*.  
Œpachyrizos, *Root*.  
Œpackenham, *Gen. U.S.* 66.  
Œpaco, *Alpaca*.  
Œpaci, *Salmoneida*.  
Œpadaviry (r.), *Rio Negro*.  
Œpadron, (Supp.)  
Œpadula, (Supp.)  
Œpadus, *Bird-cherry*.  
Œpaganes, H. de, *Templer*.  
Œpagani, (Supp.)  
Œpagci, *Sumatra*.  
Œpaget, *Hon. Wm. Anglam*,  
*Marquis of*.  
Œpago-Pago, *Tutuila*.  
Œpailion (r.), *Alpes Maritimes*  
(Supp.)  
Œpaimboruf, *Letro-Infrariv.*  
Œpainted tortoise, *Emys*.  
Œpainted pig, *Wart-hog*.  
Œpaint Rock (r.), *Tennessee*.  
Œpaknam, *Siam*.  
Œpaks, (Supp.)  
Œpalais, *Bellisita-en-Mer*.  
Œpalamedea, *Serenoar*.  
Œpalancia (r.), *Sagorbe*.

INDEX.

- Palar (r.), *Chingloput*.  
 Palay, (Supp.)  
 Palazzolo Acreide, (Supp.)  
 Palikat, *Pulicat* (Supp.)  
 Palitsch (L.), *Theresopol*.  
 Palki, *Palanquin*.  
 Pallet (in heraldry), *Pale*.  
 Palma, (Supp.)  
 Palmas, Cape, *Guinea, Gulf of*.  
 Palm cabbage, *Coccoloba*.  
 Palme, or Palm, (Supp.)  
 Palm-honey, *Cognito* (Supp.)  
 Palmistry, *Cheironomy*.  
 Palm-wine, *Palms*.  
 Palmyrene language, *Semitic Languages*, 67a.  
 Palo de Vaca, *Cow-troe*.  
 Palos, *Maguer* (Supp.)  
 Palos, Cape, *Spain*, 13.  
 Palshat, *Coimbatore*.  
 Paludina, *Walden Formation*.  
 Palmiers, *Arizide*.  
 Pampas hare, *Agouti*.  
 Pampero, *Wind*, 215.  
 Pamphilus, *Painting*, 291.  
 Pampur, *Cashmere*.  
 Pamunkey (r.), *York*.  
 Panacea, *Asculapius*.  
 Panætius, *Stoics*.  
 Panama hats, *Pandanus*.  
 Panaria, *Lipari*.  
 Panaro, *Po*.  
 Panay, *Philippine Islands*.  
 Pancake Tuesday, *Shrove-tide*.  
 Pancreatic sarcoma, *Adenocole* (Supp.)  
 Pancreatine, *Digestion*, 564.  
 Pandharpar, *Pundharpar* (Supp.)  
 Pandokrator, *Corfu*.  
 Panani, *Ponani* (Supp.)  
 Panic, *Poa*.  
 Panke, *Aralia*.  
 Panniers, *Pachhore*.  
 Panormus, *Palermo*.  
 Panphobia, *Fear*.  
 Pantagruel, *Rabelais*.  
 Pantaloon, *Harlequin*.  
 Pantar, *Solor Islands*.  
 Panthera, *Wildfowl*.  
 Papa, *Bishop*, 118.  
 Papandayang, *Volcanoes*.  
 Paphos, *Phœnicia*, 49a.  
 Papier d'Albespyres, *Venicians*.  
 Papicte, *Tahiti*.  
 Pappenburg, *Ewas*.  
 Papanha, *Guatemala*.  
 Papsa, *Borneo*.  
 Parac, *Belem*.  
 Paragoa, *Philippine Islands*.  
 Parallel motion, *Steam-engine*, 103.  
 Parallel roads, *Glenroy*.  
 Parameters, *Variation of*.  
 Paramo de los Papas, *Andes*, 239.  
 Parana (town), *Entre Rios*.  
 Parang Pass, *Himalaya*.  
 Parasita, (Supp.)  
 Parasites, root, *Koel-parasites*.  
 Paratartric acid, *Tartaric Acid*, 304.  
 Paraty, (Supp.)  
 Pardepis, *Sepindacae*.  
 Pardo, *Parana* (r.)  
 Parechia, *Paras*.  
 Parenchymatous worms, *Stenelmithes*.  
 Parens, *Landes*.  
 Paros, *Albania*.  
 Parotia, *Helos*, 206.  
 Paria, Gulf of, *Trinidad*.  
 Pariah, *Caste*, 657.  
 Parinarum, *Chrysolanacae* (Supp.)  
 Parkesite, (Supp.)  
 Parkhurst, *Convict*.  
 Parliament of Scotland, *Scotland*, 258.  
 Parma Duke of, *Cambacôrê*.  
 Parma (r.), *Po*.  
 Parmenio, *Alexander the Great*.  
 Parmesan, *Parma*.  
 Parocattuck, *Rhode Island*.  
 Paronychia, *Willow*.  
 Parras, (Supp.)  
 Parret (r.), *Somersetshire*.  
 Parrish's Chemical Food, (Supp.)  
 Parrot, owl, *Kakapo* (Supp.)  
 Parse, *Parts of Speech*.  
 Parson-bird, *Honey-eater*.  
 Partanna, (Supp.)  
 Parthenay, *Stures, Deux*.  
 Parthenon, *Grecian Architecture*, 77.  
 Parts of Holland, *Kesteven, Lindsey, Lincolnshire*.  
 Parus, *Tit*.  
 Par vagum, *Pneumogastric Nerve*.  
 Pashiuba, *Iriartes*.  
 Pashit, *Supp.*, 787.  
 Pasma, (Supp.)  
 Pasoroewan, *Java* (Supp.), 580.  
 Passage, right of, *Servitude*.  
 Passage-hawk, *Falconry*, 228.  
 Passamaquoddy (r.), *Croix, St*.  
 Passaro, Cape, *Sicily*, 704.  
 Passau, Peace of, *Maurice* (Supp.)  
 Passer, *Sparrow*.  
 Passiflora, *Passion-flower*.  
 Passir, *Borneo*.  
 Passover-cakes, *Bread*, 318.  
 Pasto, *New Granada*.  
 Pasture, right of, *Servitude*.  
 Patani, *Siam, Gulf of*.  
 Patana, *Punjab*.  
 Patarnes or Patarnes, *Cathari*.  
 Patent laws, (Supp.)  
 Patent Office, Library, and Museum, (Supp.)  
 Patent yellow, *Yellow Colours*.  
 Pater, *Pembroke*.  
 Paterno, (Supp.)  
 Pati, *Java* (Supp.), 580.  
 Patience, garden, or dock, *Spinach*.  
 Patience Gulf, *Sakhalin*.  
 Patino, *Palmas*.  
 Patta, *Muscul*.  
 Pattan, *Puthon* (Supp.)  
 Pattay, *Arnach*.  
 Patti, *Adelia & Carlotta*, (Supp.)  
 Pauchent tree, (Supp.)  
 Paulenelle, *Schwarzburg-Rudolstadt*.  
 Paume, *Tennis*.  
 Pausota (L.), *Low Archipelago* (Supp.)  
 Paunch, *Ruminantia*.  
 Paupers, removal of, *Removal of Paupers*.  
 Pawn, *Debit*.  
 Pawn, *Chest*, 799.  
 Pawtucket Falls, *Lowell*.  
 Pawtuxet (r.), *Rhode Island*.  
 Payne (L.), *Wiltland*.  
 Payne, R. *Bookbinding*.  
 Payta Bay, *Peru*, 435.  
 Paz (La) de Ayacucho, (Supp.)  
 Pazend, *Perrian Lang. & Lit.*, 426.  
 Peace (r.), *Columbia, Brit*.  
 Peach palm, *Cullinma*.  
 Peach-wood, *Dye-stuffs*.  
 Peacock, *Algebra*.  
 Peacock moth, *Empress Moth*.  
 Peak, the, *Dorsetshire*.  
 Peak Down, *Queensland*.  
 Peake, *Lifeboat*.  
 Pearl (r.), *Coar*.  
 Pearl (r.), *Canon*.  
 Pearl opal, *Catholign*.  
 Pearl spar, *Brown Spar*.  
 Pearson's solution, *Sodium, Soap*.  
 Pease, Edward, *Railways*, 85.  
 Pebble (L.), *Falkland Is.*  
 Pecan-nut, *Hickory*.  
 Pechib-ko, *Chih-ko*.  
 Pecten, *Eye*, 206.  
 Pectoral, *Pultrinal*.  
 Pectorales pedunculati, *Angler*.  
 'Peculiar People,' *Tunbers* (Supp.)  
 Peculum, *Scrf. Slavery*.  
 Pedal, *Organ*, 111.  
 Pedal-point, *Organ-point*.  
 Pediculidea, *Parasitic Animals*.  
 Pedilavium, *Washing of Feet*.  
 Pedrotallagalla, *Ceylon*, 731.  
 Peene (r.), *Order, Pomerania*.  
 Peep-of-day Boys, *Orangeman*.  
 Peers, trial of, *Parliament*, 293.  
 Pegannum, (Supp.)  
 Pegmatite, *Kaolin*.  
 Peiræus, *Athens*.  
 Peishwa, (Supp.)  
 Pekeea trees, *Caryocar*.  
 Pelagia, *Lampadusa* (Supp.)  
 Pelée (mt.), *Martinique*.  
 Pelias, *Viper*.  
 Pellegrin, Abbé, *Rameau*.  
 Pellegrino, Monte, *Sicily*, 704.  
 Pellestrina, (Supp.)  
 Pelletier, *Algebra*.  
 Pellicle, *Epidermis*.  
 Peloria, *Toad-flax*.  
 Peloric (mts.), *Sicily*, 704.  
 Pelt, *Falconry*, 228.  
 Pelt, *Leather*.  
 Pelitæ, *Leaves*, 67.  
 Peltier, *Thermo-electricity*.  
 Pelvoux (mt.), *Alpes, Hautes*.  
 Pemba, (Supp.)  
 Pembuan (r.), *Borneo*.  
 Pemphigus, *Bulla* (Supp.)  
 Pen, *Ben*.  
 Peña-de-Pediaranda (mt.), *Asturias*.  
 Pendle Forest and Hill, *Ciltshire*.  
 Pendulum, ballistic, *War Services* (Supp.)  
 Penedo, (Supp.)  
 Peneus or Peneus, *Thessaly*.  
 Peneus, *Thessaly*.  
 Penicillium, *Vinegar-plant*.  
 Pennant, *Pendant*.  
 Pennar (r.), *Mysore*.  
 Penny Dog, *Topo*.  
 Penny of gold, *Rose-noble*.  
 Pentamerus limestone, *Silurian Rocks*.  
 Pentapolis and Pentapolitana Regia, *Cyrenaica*.  
 Pentateuch, Samaritan, *Samaritan Pentateuch*.  
 Pentathionic acid, *Sulphur*, 199.  
 Pentelicus, *Attica*.  
 Penthesilea, *Amazons*.  
 Pentonville, *Convict*.  
 Pepin Lake, *Wisconsin*.  
 Pepper-brand, *Blight, Brand*.  
 Pepper-corn, *Ear-cockles*.  
 Peppercorn, *Cross*.  
 Peptones, *Digestion*, 561.  
 Perambulator, *Odometer*.  
 Per baroniam, *Parliament*, 281.  
 Perceptive faculties, *Physiology*, 517.  
 Perch, linear, *Red*.  
 Perching-birds, *Issosores*.  
 Percy Society, *Res. Club*.  
 Perdiccas, *Alexander the Great*.  
 Perdis, *Partridge*.  
 Perdu, Mont, *France*, 470.  
 Perejaslav, (Supp.)  
 Pereskia, *Cactae*.  
 Perfectionists, (Supp.)  
 Perfoliate, *Leaves*.  
 Pericles of Corinth, *Sreen Wise Men*.  
 Peridium, *Puff-ball*.  
 Periprignous, *Stomach*.  
 Perimbakum, battle of, *Tippoo Sahib*.  
 Periphery, *Circumference*.  
 Perisperm, *Albumen*.  
 Perispor, *Spora*.  
 Periwig, *Wig*.  
 Perjury, subornation of, *Subornation of Perjury*.  
 Perkins, *Engraving*, 68.  
 Perleberg, (Supp.)  
 Perowakite, *Titanium*.  
 Perry, Commodore, *U.S.* 666.  
 Perry, W. *Reporting, Parliamentary*.  
 Persepolis, *Perrian Architecture*.  
 Persian lilac, *Meliaceae*.  
 Persian wheel, *Agriculture*.  
 Persulphide of hydrogen, *Sulphur*, 200.  
 Pertuis Breton, *Ré, Ile de*.  
 Pertussis, *Whooping-cough*.  
 Perun, *Slaves*.  
 Petruwels, (Supp.)  
 Petasites, *Tussilago*.  
 Petaurist, *Flying Phalanger*.  
 Peterhof, (Supp.)  
 Peterhouse, *Cambridge University*, 530.  
 Peterli, *Carlisle*.  
 Petitions, *Parliament*, 291.  
 Petitio principii, *Fallacy*.  
 Petitot, Jean, *Enamel*.  
 Petöfi, S. (Supp.)  
 Petong, *Pachlong*.  
 Petrasowodsk, *Oloneta*.  
 Petrified fingers, *Belemnites*.  
 Petronius Maximus, *Rome*, 321.  
 Petrovsk, (Supp.)  
 Petricoat breeches, *Life Mor-lars, &c* (Supp.)  
 Petty, *Shelburne*.  
 Pettychaps, *Baccasce*.  
 Petty whin, *Genista*.  
 Peutingering Table, (Supp.)  
 Pévénsey Bay, *Sussex*.  
 Peyer's glands, *Digestion*, 563.  
 Pexophaps, *Solitire*.  
 Phacochærus, *Wart-hog*.  
 Phænogamous, *Phanerogamous*.  
 Phæton, *Coach*.  
 Phalanges, *Hand*, 222, *Foot*, 410.  
 Phalaris, *Canary Grass*.  
 Phantasiasts, *Monophynites*.  
 Pharaoh's hen, *Egyptian Vulture*.  
 Pharaoh's serpents, *Sulphocyanogen*.  
 Pharmacopœia, (Supp.)  
 Pharmaburus, *Alciobanda*.  
 Pharo, *Faro*.  
 Pharpur, *Barrada*.  
 Phascologynde, *Wombat*.  
 Pheasant, horned, *Trogonan*.  
 Pheasant's eye, *Adonis*.  
 Phege, *Damascus*.  
 Phelipea, *Cancer Root*.  
 Phenakistoscope, *Stereoscope*, 117.  
 Phenakite, *Glucina*.  
 Phene, *Benzole*.  
 Phenex, *Arctida*.  
 Phenetic acid, *Carbonic Acid*.  
 Phenomenon, *Substantia*.  
 Phial, philosophical, *Bologna Phial*.  
 Phidias, *Phœdrias*.  
 Philadelphia, *Ala-Shehr* (Supp.)  
 Philadelphia, *Ammonites*.  
 Philanthropy, *Philanthropy*.  
 Philibert I., II., &c. *Savoie, House of*.  
 Philippaugh, *Selkirk, Selkirkshire*.  
 Philippe I., IV., V. *Cæptian Dynasty*.  
 Philippeville, *Namur*.  
 Philippine Grosbeak, *Baya*.  
 Philippopolis, (Supp.)  
 Philippsburg, (Supp.)  
 Phillipib, *Phillibib* (Supp.)  
 Philohela, *Woodcock*.  
 Philoprogenitiveness, *Phrenology*, 514.  
 Philosopher's stone, *Alchymy*.  
 Philotarus, *Wooover-bird*.  
 Pincock, *Sadmon*, 449.  
 Pilegmatic diathesis, *Serofula*.  
 Phoca, *Seal*.  
 Phœnician lang. and lit. *Phœnicia*, 425.  
 Phœnicurus, *Bluetthroat, Redstart*.  
 Phonograph, *Music Recorder* (Supp.)  
 Phonograph, *Music Recorder* (Supp.)  
 Phouolite, *Clinkstone, Trap*.  
 Phormium, *Flax, New Zealand*.  
 Phosphorite, *Apatite, Phosphorus*.  
 Photo-galvanography, *Photography*, 511.

INDEX.

- Photoglyphography, *Photography*, 511.  
 Photo-heliography, *Heliography* (Supp.).  
 Photo-micrography, *Photography*, 510.  
 Photo-zincography, *Photographic Engraving*.  
 Phulowdi, (Supp.).  
 Phyllocladus, *Yew*.  
 Phyllophagi, *Scarabaeidae*.  
 Phyllostoma, *Spectre Bat*, *Vampire*.  
 Physalus, *Roryqual*.  
 Physomycetes, *Fungi*.  
 Physostigma, *Calabar Bean* (Supp.).  
 Phytogeography, *Botany*, 265.  
 Phytography, *Botany*, 264.  
 Phytotomy, *Botany*, 264.  
 Piababa, *Piassaba*.  
 Piana de Greci, (Supp.).  
 Piatra, (Supp.).  
 Piave (r.), *Alps*.  
 Piazza, (Supp.).  
 Picadores, *Bull-fight*.  
 Pic d'Anie, *Pyrenees*.  
 Pic du Midi de Barèges, *Pyrenees*.  
 Pic du Midi de Pau, *Pyrenees*.  
 Pic du Midi d'Ossau, *Pyrenees*.  
 Pichne-writing, *Writing*, 269.  
 Pickeler, *Pike*.  
 Pico Ruivo (mt.), *Madeira*.  
 Picric acid, *Carbasotic Acid*, *Dye-stuffs*.  
 Piction Island, *Tierra del Fuego*.  
 Picture-cleaning, *Painting*, 198.  
 Pictured Rocks, *Superior*, L.  
 Pictures, restoration of, (Supp.).  
 Piculet, *Woodpecker*.  
 Piddock, *Pholas*.  
 Pie, French or Wood, *Wood-acher*.  
 Piedimonte d'Alife, (Supp.).  
 Piedra Blanca, (Supp.).  
 Pietermaritzburg, *Natal*.  
 Pietra Nero, *Malta*.  
 Pieterperzia, (Supp.).  
 Pigeon (r.), *Superior*, L.  
 Pigeon-breasted, *Richets*.  
 Pigmy ape, *Barbary Ape*.  
 Pignero, *Pinerolo*.  
 Pig-nut, *Earth-nut*.  
 Pig-rat, *Bandidoot*.  
 Pig's faces, *Mesembryaceae*.  
 Pig-tail, *Tobacco*, 465.  
 Pike, *Lagomys*.  
 Pike whale, *Roryqual*.  
 Pilatus, Mt. *Alp-mach*.  
 Pilaya (r.), *Pilcomayo*.  
 Pileworm, *Teredo*.  
 Pilsen (r.), *Radom*.  
 Pillar, *Strength of Materials*, 161.  
 Pillar, Cape, *Tasmania*, 306.  
 Pillar of Elisy, *Llanollen*.  
 Pill beetle, *Armaddillo*.  
 Pilseden Pen, *Dorsetshire*.  
 Pillibhit, (Supp.).  
 Pilon, German, *Sculpture*, 577.  
 Pilza (r.), *Vistula*.  
 Pimpinella, *Anise*.  
 Pimple: copper, *Electro-metalurgy* (Supp.).  
 Pimple-mite, *Epfisaa*.  
 Pinana, *Custard Apple*.  
 Pinang, *Betel*.  
 Pinang palm, *Araca*.  
 Pinara, *Lycia*.  
 Pinaric acid, *Rosin*.  
 Pincers, *Torture*.  
 Pinchbeck, *Alloy*.  
 Pincia, *Valladolid*.  
 Pincian Hill, *Rome*, 322.  
 Pindova palm, *Attalea*.  
 Pindus (town), *Doris*.  
 Pine (r.), *Moriton Bay*.  
 Pine-apple oil, *Butyric Ether*.  
 Pinegra (r.), *Duwina*.  
 Pinetum, *Pine*, 547.  
 Pinha, *Custard Apple*.  
 Pincic acid, *Rosin*.  
 Pink, *Salmon*, 447.  
 Pink, brown, Dutch and English, *Yellow Colours*.  
 Pink salt, *Tin*, 447.  
 Pinna, *Ear*, 739.  
 Pinnatifid, *Leaves*.  
 Pinzon, *America*, 199.  
 Pioneer (r.), *Queensland*.  
 Pip, (Supp.).  
 Piper, *Cidaris*.  
 Piper, *Garnard*.  
 Piper, *Pepper*.  
 Piper, *Wild-fowl*.  
 Pipe Roll, *Records*, Public.  
 Pipes, flow of water in, *Hydrodynamics*, 484.  
 Pipe shrub, *Aristolochia*.  
 Pipette, *Volumetric Analysis*.  
 Pipe-vine, *Aristolochia*.  
 Pipholes, *Cathari*.  
 Pipul, *Peepul*.  
 Piquery, *Parana*.  
 Piramidig, *Night-hawk*.  
 Piran Round, *Theatre*, 388.  
 Pirate Isle, *Bobia*.  
 Piraticaba, *Campinas* (Supp.).  
 Pirn, *Bobbin*, *Spinning*, 46.  
 Pir Panjal Pass, *Dumdam*.  
 Pisano, Andrea, *Sculpture*, 577.  
 Pishtaka, *Fox River*.  
 Pisi-form limestone, *Pea-stone*.  
 Pismire, *Ant*, 282.  
 Pisolite, *Pea-stone*.  
 Pistojia, Cino da, *Italy*, 657.  
 Piston, *Pump*.  
 Pisuerga (r.), *Valladolid*.  
 Pit, *Thaava*, 388.  
 Pita fibre or flax, *Yucca*.  
 Pitea (r.), *Sweden*, 236.  
 Pithiviers, *Loiret*.  
 Pitulad, *Indora*.  
 Pitman, I. *Phonetic Writing*, 500, *Shorthand*, 692.  
 Pito, *Chica*.  
 Piton de Fournaise & Neiges, *Borbon*, *Ile de*.  
 Pi-tai, *Scirpus*.  
 Pittacal, *Dye-stuffs*.  
 Pittenweem, Lord, *Stewart Family*, 125.  
 Pitti Palace, *Ammanate*, B.  
 Pittwater (r.), *Susquehanna*.  
 Pitt, the Elder, *Chatham*.  
 Pitt Town, *Hawkesbury*.  
 Pitt Water, *Tasmania*, 306.  
 Pitzen, *Fairies*, 221.  
 Pixing, *Mint*.  
 Pix liquida, *Tar*.  
 Piziuba, *Vriartea*.  
 Pizzo, (Supp.).  
 Pizzo di Case, *Apennines*.  
 Placentia, *Newfoundland*.  
 Placerville, *California*.  
 Pladda, *Buteshire*.  
 Plain silk, *Taffety*.  
 Plains of Promise, *Queensland*.  
 Plane figures, regular, *Regular Plane Figures*.  
 Planera, *Zilkoua*.  
 Planetoids, (Supp.).  
 Planing, *Shipbuilding*, 684.  
 Planorbis, *Pulmonata*.  
 Plantain, *Plantagineae*.  
 Plantain, water, *Alismaceae*.  
 Plassey, (Supp.).  
 Plaster, court, *Sticking-plaster*.  
 Platani (r.), *Sicily*, 704.  
 Platanista, *Soovoo*.  
 Plateaux, *Table-lands*.  
 Plate-glass, *Glass*, 781.  
 Plate-layers, *Railways*, 89.  
 Platon, *Russian Lang. & Lit.*  
 Platyelmia, *Worms*, 279.  
 Playe Canal, *Germany*, 718.  
 Pleasant Mount, *White Mts.*  
 Plectrophanes, *Snow Bunting*.  
 Pleiscie, *Elster*.  
 Pleissengau, *Saxo-Altendurg*.  
 Plenum, *Germany*, 721.  
 Plessis les Tours, *Tours*.  
 Plessur (r.), *Chur* (Supp.).  
 Plettenberg Bay, *Cape of Good Hope*.  
 Pleurapophysis, *Ribs*.  
 Pliinlimmon, (Supp.).  
 Pliolophus, *Hyrcantherium*.  
 Ploermel, *Morbihan*.  
 Plojeshti, (Supp.).  
 Plotak, *Flock*.  
 Plough, the, *Urus Major*.  
 Ploughman's spikenard, *Conyza*.  
 Plover, great, and Norfolk, *Thick-knee*.  
 Pluck, *Pogge*.  
 Plumbers' solder, *Alloy*.  
 Plume-bird, (Supp.).  
 Plummer's pills, *Guaiaicum*.  
 Plum pudding-stone, *Conglomerate*.  
 Plusia gamma, *Y-moth*.  
 Plutchevsky (mt.), *Kamchatka*.  
 Pluviale, *Vestments*.  
 Plym (r.), *Dartmoor*.  
 Plymouth, *Montserrat*.  
 Plymouth, *Roanoke*.  
 Plymouth Bay, *Massachusetts Bay*.  
 Plymouth Breakwater, *Breakwater*.  
 Plyinlimmon, *Pliinlimmon* (Supp.).  
 Po (r.), *Yang-tse-kiang*.  
 Poached eggs, *Cowry*.  
 Podda (r.), *Paridgur*.  
 Podleys, *Coal-fish*.  
 Podol, battle of, *Germany* (Supp.), 533.  
 Podolian marmot, *Mole-rat*.  
 Podolinski, *Russian Lang. & Lit.*  
 Podolsk, *Kaminetz-Podolsk*.  
 Poephagus, *Yak*.  
 Pogodin, *Russian Lang. & Lit.*  
 Pohono Waterfall, *Yo-Semite Valley* (Supp.).  
 Point-a-Pitre, (Supp.).  
 Point d'Alençon, *Lacc.*  
 Pointed, *Glass*, 778.  
 Pointers, the, *Pole-star*.  
 Point of sight, *Perspective*, 430.  
 'Points d'appui', *Appui*.  
 Poisson, S. D. (Supp.).  
 Pokhurn, (Supp.).  
 Polabians, *Slaves*.  
 Polaris, *Pole-star*.  
 Pole, *Rod*.  
 Poligny, *Terra*.  
 Poling, *Tin*, 449.  
 Polite literature, *Belles-lettres*.  
 Polk, *Uklans*.  
 Pollanarru, *Ceylon*, 739.  
 Pollard, *Wheat*, 157.  
 Pollentia, battle of, *Alaric I.*  
 Pollen-tube, *Vegetable Physiology*, 736.  
 Pollet, *Dioppe*.  
 Pollinium, *Stamens*, *Vegetable Physiology*, 735.  
 Pollux, *Fugilium*.  
 Pollux, *Rubidium*.  
 Polonaise, *Polacca*.  
 Poltici, *Skye*.  
 Polycletus, *Sculpture*, 577.  
 Polygraph, *Zemindar*.  
 Polygnotus, *Painting*, 191.  
 Polygonatum, *Solomon's Seal*.  
 Polynes, *Antigone*, *Edipus*.  
 Polypharmacy, *Alchemy*.  
 Polyphemus, *Cave of, Aci Reale*.  
 Polyptych, *Triptych*.  
 Polystomide, *Trematoda*.  
 Polytichum, (Supp.).  
 Polzen (r.), *Leips* (Supp.).  
 Pommel cross, *Pommelitel*.  
 Pomelo, *Pomelimos*.  
 Pomeranus, *Bugenhagen*.  
 Pomerony, *Guiana*, Brit. 132.  
 Pomeroy, *Ohio*.  
 Pomfret, *Pontefract*.  
 Pommern, *Pomerania*.  
 Pompeiopolis, *Pamphlos*.  
 Pompholyx, *Pempkyona*.  
 Ponani, (Supp.).  
 Ponce, *Puerto Rico*.  
 Ponce de Leon, Juan, U.S. 653.  
 Pondicherry kite, *Erne*.  
 Pond-mail, *Limnaea*.  
 Pons Varolii, *Brain*, 303.  
 Pontac, *Pyrites*, *Basses*.  
 Pontano Salso, *Manfredonia*.  
 Pontarlier, *Doubs*.  
 Pontifical, *Episcoporum*, *Ritual*.  
 Poutiv, *Morbihan*.  
 Pontop Pike, *Durham*.  
 Pooah, *Behmeria*.  
 Pooh, *Pod.*  
 Pool, *Billiards*, 99.  
 Pool, the, *Thames*.  
 Poole's Hole, *Buxton*.  
 Poon, *Poona-wood*, *Tacama-hac*.  
 Poon spars, *Sterculiaceae*.  
 Pooree, *Cuttack*.  
 Poorhouse, *Workhouse*.  
 Poor man's herb, *Gratiola*.  
 Poor man's pepper, *Cress*.  
 Poonah, *Berar*.  
 Poor People of Lyon, *Wal-denses*.  
 Poorundur, *Poona*.  
 Pop-corn, *Maine*.  
 Pope (beverage), *Bishop*.  
 Poperinghe, (Supp.).  
 Popham, Sir Home, *Signals*.  
 Poplar Marshes, *Dogs*, *Isle of*.  
 Popolia, *Amphipolis*.  
 Populus, *Rome*, 308.  
 Pora, *Sumatra*.  
 Porcelain shell, *Cowry*.  
 Porcupine (mt.), *Michigan*.  
 Porcupine fish, *Diadema*.  
 Porcupine grass, *Australian Explorations* (Supp.), 410.  
 Porcupine wood, *Pakmyrwood*.  
 Pordenone, (Supp.).  
 Porpesse, *Porpese*.  
 Port, the, *Thames*.  
 Porta, Baptistia, *Camera Obicura*.  
 Port Adelaide, *S. Australia*.  
 Portage, *Genesee*.  
 Portalegre, *Alentejo*.  
 Port Anson, *Australian Explorations* (Supp.), 411.  
 Porta Pompe, *Cercus*.  
 Port Augusta, *S. Australia*.  
 Porta Trajani, *Balkans*.  
 Port Dalrymple, *Lanccaster*.  
 Port Davey, *Tasmania*, 306.  
 Port Douglas, *Columbia*, Brit.  
 Port Dover, *Erre*, *Lake*.  
 Port-du-Bouc, *Berre*, *Etang de*.  
 Porter, D. D. (Supp.).  
 Port Gaio, *Paso*.  
 Port Genessee, *Ontario*.  
 Port Hood, *Cape Breton*.  
 Port Hudson, *U.S.* 660.  
 Port Jackson, *Botany Bay*, *Sydney*.  
 Port Jackson shark, *Cestracion*.  
 Portland, *Oregon*.  
 Portland Harbour, *Weymouth*.  
 Portland powder, *Germaner*.  
 Port Lincoln, *South Australia*.  
 Port Macdonnell, *South Australia*.  
 Port Naloth, *Namagueland*.  
 Port Nicholson, *Wellington* (Supp.).  
 Porto-Cabello, *Puerto-Cabello* (Supp.).  
 Porto d'Anzo, *Antium*.  
 Port of Spain, *Trinidad*.  
 Porto Grande, *Cape Verd Is.*  
 Porto Imperial, *Tocantins*.  
 Porto-Mauricio, (Supp.).  
 Porto Praya, *Cape Verd Is.*  
 Portreeve, *Revos*.  
 Port Republican, *Port-au-Prince*.  
 Port Royal, *Martinique*.  
 Ports, *Pyrenees*.  
 Port Sorell, *Tasmania*, 306.  
 Portway, *Banffshire*.  
 Port Talbot, *Aberavon* (Supp.).  
 Portugal (derivational), *Oporto*.  
 Portogalete, *Bilbao*.  
 Portugal laurel, *Cherry-laurel*.  
 Portuguese man-of-war, *Physalia*.  
 Portus Trajani, *Civita Vecchia*.  
 Posidonius, *Sicily*.  
 Positive, *Photography*, 520.  
 Poso, *Chica*.  
 Post-office insurance, (Supp.).  
 Postulants, *Monachism*, 526.  
 Poy, *Ring*.  
 Pot (paper), *Paper*, 246.  
 Potatoes, *Naiades*.  
 Potash-water, *Abrus and Waterva*.  
 Potato spirit, *Puceil*.  
 Potato stomes, *Gooden*.

INDEX.

Potato War, *Succession Wars*, 177.  
 Potidea, *Macdonia*.  
 Pot-metal, *Glass*, 782.  
 Potociki, *Targovits*.  
 Potscherfstrom, *Transvaal Republic*.  
 Potsdam period, *America*, 202.  
 Potteries, *Stafford*.  
 Pottery style, *Calico Printing*, 514.  
 Pot tree, *Brazil Nuts*.  
 Pot-wallers or pot-wallipers, (*Suppl.*)  
 Poulton-le-Fyde, *Blackpool* (*Suppl.*)  
 Poundage, *Tonnage & Poundage*.  
 Pounds, *John, Ragged Schools*.  
 Pout, *Bib.*  
 Powtrail, *Clyde*.  
 Poyang (L), *Yang-tsu-kiang*.  
 Poyning's Act, *Parliaments*, 281.  
 Pozzo di Gotto, *Barcellona* (*Suppl.*)  
 Prades, *Pyrenæes Orientales*.  
 Prænomens, *Name*.  
 Prague, treaty, *Germany* (*Suppl.*), 535.  
 Prague Compact, *Taborites*.  
 Prairie apple, *Porsala*.  
 Prairie-du-Chien, (*Suppl.*)  
 Prangos, *Umbellifera*.  
 Prusias (L), *Cranagees*.  
 Prasilin Island, *Seychelles Island*.  
 Pratincoles, *Charadriada*.  
 Prato, (*Suppl.*)  
 Precelly Hills, *Pembrokeshire*.  
 Pregnancy, simulated, *Nervous Diseases* (*Suppl.*)  
 Premature labour, *Abortion* (*Suppl.*)  
 Premna esculenta, *Verbenacea*.  
 Premolars, *Teeth*, 329.  
 Preparation, *Anatomy*, 220.  
 Pre-Raphaelite, *Hunt, W. H.*  
 Presbyters, *Wandering*.  
 Presentation of the Child Jesus, feast of, *Purification of the Blessed Virgin Mary*.  
 Preservation powder, *Taxidermy*.  
 Preserved meat, *Antiseptics, Food and Drink*, 407.  
 Preserved provisions, *Preserves* (*Suppl.*)  
 Preserves, (*Suppl.*)  
 Presl *Bohemia*, 190.  
 Presque Isle, *Erie*.  
 Presteign, *Radnor, New*.  
 Preston, *Tynemouth*.  
 Preveza, (*Suppl.*)  
 Previous question, to move the *Parliament*, 287.  
 Prevost, Sir George, *U.S.*, 655.  
 Prevost's theory of exchanges, *Sum*, 208.  
 Price, Rev. T. *Welsh Lang. & Lit.*, 128.  
 Pricking at the belt, *Fast and Loose*.  
 Prick the garter, *Fast and Loose*.  
 Pride of India, *Meliacea*.  
 Pride's Purge, *Rump Parliament*.  
 Priego, (*Suppl.*)  
 Prien (r), *Chiem-see*.  
 Pripia, *Slaves*.  
 Prikas, *Ubas*.  
 Priluki, (*Suppl.*)  
 Primaries, *Birds*, 108.  
 Prime of opal, *Opal*.  
 Prime factors, *Chemistry* (*Suppl.*), 465.  
 Prime minister, *Treasury*.  
 Primer, Long, *Type*, 607.  
 Prime staff, *Clog Almanac*.  
 Primordial utricle, *Cells*, 709.  
 Prince, H. J. *Agaphomoe*.  
 Prince-berry, *Rubus*.  
 Prince Edward Island, *Canada* (*Suppl.*), 448.  
 Princesita, *Agaphomoe*.  
 Prince of Peace, *Alcudia*.

Prince of Wales, Cape, *America, Russian*.  
 Prince Patrick Island, *Melville Island*.  
 Prince's feather, *Amaranth*.  
 Prince's Island, *Biafra*.  
 Prince wood, *Cordilacea*.  
 Prinos glabra, *Tea*, 323.  
 Prinsepia, *Chrysobalanacea* (*Suppl.*)  
 Printing, (*Suppl.*)  
 Priodon, *Delandung* (*Suppl.*)  
 Pripet (r), *Volkynia*.  
 Privas, *Ardeche*.  
 Privat-docent, *University*, 664.  
 Privilege (in parliament), *Parliament*, 284.  
 Prizzi, (*Suppl.*)  
 Probolinggo, *Java* (*Suppl.*), 580.  
 Proboscis seal, *Elephant, Sea*.  
 Procellaria, *Petrel*.  
 Procidia, G. da, *Sicilian Vespers*.  
 Procidencia, *Womb, Diseases of*, 251.  
 Procopius, *Valens*.  
 Proctalgia, *Rectum*.  
 Proctor, General, *U.S.*, 656.  
 Product, chemical, *Educat* (*Suppl.*)  
 Professed houses, *Monastery*.  
 Proglottides, *Tape-worm*, 200.  
 Prognathous cranium, *Skull*, 760.  
 Prognostications, *Almanac*.  
 Prokopovitch, *Russian Lang. & Lit.*  
 Pro-legs, *Caterpillar*.  
 Prolocutor, *Conventions*.  
 Prolok, Mount, *Dinaric Alps*.  
 Prome, *Pegu*.  
 Pronation, *Hand*, 223.  
 Proof-spirit, *Alcohol*.  
 Propeller, *Nautilus Propeller* (*Suppl.*)  
 Propensities, *Phrenology*, 517.  
 Property, real, *Rent*.  
 Propontis, *Marmora, Sea of Propylæicite*.  
 Propylæicite, (*Suppl.*), 384 (note \*).  
 Prorogation, *Parliament*, 286.  
 Proscenium, *Theatre*, 388.  
 Prosencephalon, *Skull*, 761.  
 Prospopocia, *Personification*.  
 Prospero Lambertini, *Benedict*.  
 Protharax, *Insects*.  
 Protopterus, *Lepidosiren*.  
 Protoxide, *Oxides*.  
 Provençal, *Romanic Lang.*  
 Proventriculus, *Birds*, 109.  
 Prover, *Approver*.  
 Provisional order, (*Suppl.*)  
 Prove, *Slaves*.  
 Proxies (in parliament), *Parliament*, 282.  
 Prud'hon, *Painting*, 105.  
 Pruritus, *Rectum, Anus* (*Suppl.*)  
 Prusa, *Broussa*.  
 Prussia, *Germany* (*Suppl.*)  
 Prussia, education in, *National Education* (*Suppl.*)  
 Prussian carp, *Gibel*.  
 Przemysl, (*Suppl.*)  
 Prizbram, (*Suppl.*)  
 Psalms of the Steps, *Gradual Psalms*.  
 Psalterium, *Digestion*, 567.  
 Pseudonymous, *Anonymous*.  
 Pseudopodia, *Rhizopoda*.  
 Pseudoscope, (*Suppl.*)  
 Pseudo-scorpions, *Chelifer* (*Suppl.*)  
 Psila, *Carrot*.  
 Psilortia, *Ida*.  
 Psikoff (L), *Priput*.  
 Psocus, *Termite*.  
 Psophia, *Agami*.  
 Psophia, *Arcadia*.  
 Psora, *Itch*.  
 Psah, *Egypt*, 787.  
 Ptelea, *Ephesus*.  
 Pteris, *Brake, Tara Fern*.  
 Pteroglossus, *Aracari*.  
 Ptiloris, *Rifle-bird*.  
 Ptsan, *Tinan*.  
 Ptyaline, *Digestion*, 559.  
 Ptyalism, *Salivation*.  
 Puberty, legal, *Age*.

Pubes, *Pelvis*.  
 Publicans, *Cathari*.  
 Public health, *Sanitary Science* (*Suppl.*)  
 Publician laws, *Rome*, 313.  
 Publishing, *Book-trade*.  
 Puccinia, (*Suppl.*)  
 Puccoon, *Sanguinaria*.  
 Pucha-pat, *Patchouli*.  
 Puck, *Fairies*, 221.  
 Pudding-pipe tree, *Cassia*.  
 Puddling, *Iron*, 636.  
 Puebla, *Guarès* (*Suppl.*)  
 Puerto-Cabello, (*Suppl.*)  
 Puffinus, *Shearwater*.  
 Puget-Theniers, *Alpes Maritimes* (*Suppl.*)  
 Pughe, Owen, *Welsh Lang. & Lit.*, 137.  
 Puglia, *Apulia*.  
 Puglia, Francesco da, *Savonarola*.  
 Pug-mill, *Brick*, 328.  
 Pulcinella, *Punch*.  
 Pulicat, (*Suppl.*)  
 Pulmonaria, *Arachnida*.  
 Pulmonary artery and veins, *Respiration*, 200.  
 Pulsatilla, *Passy Flower*.  
 Pulteney-town, *Wick*.  
 Pulu-Buru, *Ambonyna*.  
 Pulwul, (*Suppl.*)  
 Puna, *Poons*.  
 Punching-machine, *Punch*.  
 Punctated tishue, *Wood & Woody Fibre*.  
 Punderpur, (*Suppl.*)  
 Punjnad, *Chenab, Punjab*.  
 Puno, *Ecuador*.  
 Puncos, *Venezuela*.  
 Punta Arenas, *Costa Rica, San Yosi*.  
 Punto, *Quadrille*.  
 Puntz, *Glass*, 779.  
 Pupilarity, *Age*.  
 Pupipara, *Homaloptera*.  
 Pur autre vie, *Estate*.  
 Purbach, *Almanac*.  
 Puri, *Jaggernaut*.  
 Purna (r), *Oomrawutti* (*Suppl.*)  
 Purnabada (r), *Dinagapore*.  
 Purples, the, *Purpura*.  
 Purple, *Colour* (her.).  
 Purree, *Indian Yellow*.  
 Purses, *Ray*.  
 Pursuk (r), *Kutaiak*.  
 Purus (r), *Amazon, Peru*, 437.  
 Puruvesi (L), *Finland*.  
 Pushtaneh and Pushtu, *Afghanistan*.  
 Pusterthal, *Tyrol*.  
 Puteaux, (*Suppl.*)  
 Puteoli, *Campania*.  
 Putten, *Holland, South*.  
 Putting-nets, *Pravun*.  
 Puttun, (*Suppl.*)  
 Pu-tu, *Chusan Islands*.  
 Putumayo (r), *Amazon*.  
 Puy-de-Sancy, *Dor*.  
 Puy-Vieux, Mont de, *Vienne, Haute*.  
 Pwllheli, *Caernarvonshire*.  
 Pycnonotus, *Bulbul*.  
 Pydna, *Macdonia*.  
 Pydna, battle of, *Scipio Emilianus*.  
 Pygmalion, *Tyre*.  
 Pygmies of W. Africa, (*Suppl.*)  
 Pyhäjärvi (L), *Finland*.  
 Pylos, *Messenia*.  
 Pyne, Louisa, (*Suppl.*)  
 Pyramus (r), *Zeithun*.  
 Pyrethrum carneum, *Peruvian Powder*.  
 Pyrgita, *Sparrow*.  
 Pyritz, (*Suppl.*)  
 Pyroxyline, *Collodion*.  
 Pyrrhic foot, *Pyrrhic Dance*.  
 Pyrrhula, *Bull-finch*.  
 Pyrus Japonica, *Quince*.  
 Pysang, *Moluccas*.  
 Pythias, *Damon*.  
 Pythogenetic fever, *Typhus & Typhoid Fevers*, 615.

Quadrat, *Type*, 608.  
 Quadri-equivalent elements, *Triads*.  
 Quaker bird, *Albatross*.  
 Quality, in logic, *Quantification of the Predicate*.  
 Quang-Nam, (*Suppl.*)  
 Quantity, in logic, *Quantification of the Predicate*.  
 Quantity, in verse, *Rhythm*.  
 Quantock Hills, *Somersetsh.*  
 Quarnero Bay, *Adriatic Sea*.  
 Quarry, *Falconry*.  
 Quarter evil, *Black Quarter*.  
 Quarter-pieced, *Square-pieced*.  
 Quarto, *Book*, 225.  
 Quartz resinite, *Girasol*.  
 Quartz, smoke, *Rock-crystal*.  
 Quaternate, *Leaves*.  
 Quathlamba, *Kaffraria*.  
 Quathlamba (mts.), *Natal, Orange River Free State*.  
 Quebec, *Canada* (*Suppl.*)  
 Quedah, (*Suppl.*)  
 Queen Elizabeth's Foreland, *Frobisher, Sir M.*  
 Queensberry (mt.), *Dumfriesshire*.  
 Queen's cadets, *Sandhurst*.  
 Queen's Coll., *Cam.* (*Suppl.*)  
 Queen's coroners, *Queen's Bench*.  
 Queen's conch, *Cameo*.  
 Queen's Pipe, (*Suppl.*)  
 Queen's ware, *Wedgwood*.  
 Queich (r), *Bavaria*, 760, *Landau*.  
 Quelpearts, *Correa*.  
 Quercine, *Oak*.  
 Quercite, *Sugar*, 188.  
 Quercus ballota, *Racahout*.  
 Quercus tinctoria, *Quercitron*.  
 Quercuedula, *Teal*.  
 Quersaltenango, (*Suppl.*)  
 Question, the, *Torture*.  
 Quetsch-Hahn, *Volometric Analysis*.  
 Queyles (r), *Tarazona*.  
 Quick grass, *Bent Grass*.  
 Quicks or quicksets, *Hawthorn*.  
 Quida, *Scandinavian Lang. & Lit.*, 522, 523.  
 Quiet, *Kusterland*.  
 Quiloa, *Muscet*.  
 Quillota, (*Suppl.*)  
 Quilon, (*Suppl.*)  
 Quina, *Cinchona*.  
 Quimate, *Leaves*.  
 Quinic acid, *Kinic Acid*.  
 Quinine, *Quinia*.  
 Quinidine, *Quinia*.  
 Quinism, *Quinia*.  
 Quinoline, *Dye-stuffs*.  
 Quinquina, *Cinchona*.  
 Quinte, Bay, *Ontario*.  
 Quippo, *Writing*.  
 Quippu, or Quippu, *Peru*, 438.  
 Quirinal, *Quirinus*.  
 Quiriquito (L), *Concepcion*.  
 Quirites, *Rome*, 310.  
 Quiver, *Archer*, 371.  
 Quoad sacra, *Paruk*.  
 Ra, *Ammon*.  
 Raab (r), *Alps*.  
 Rabato, *Gozo*.  
 Rabbath-Ammon, *Ammonites*.  
 Rabbits, *Shipbuilding*, 683.  
 Rabe, Martha, *Catharine I.*  
 Racaluto, (*Suppl.*)  
 Race, Cape, *Newfoundland*.  
 Race (current), (*Suppl.*)  
 Rachelberg, *Bavaria*.  
 Rachitis, *Rickets*.  
 Rack, *Arrack*.  
 Radagains, *Stilicho*.  
 Radaune, *Danig*.  
 Radle, *Raddle*.  
 Radegast, *Slaves*.  
 Radiaria, *Zoophyte*.  
 Radicle, *Seed*.  
 Raditchevitz, *Servia*, 632.  
 Radius, *Hand*, 222.  
 Rae Isthmus, *Melville I.*  
 Raffaello Santi, *Raphael*.  
 Raft-bridge, *Bridge, Military*.  
 Rafue (r), *Zambesi*.

- Ragalbuto, *Regalbio*.  
 Ragalunio, *Racalunio* (Supp.).  
 Ragatz, *Pfeffer*.  
 Rage, *Emotion*.  
 Ragged Robin, *Lychnis*.  
 Ragnarök, *Scandinavian Mythology*, 525.  
 Ragotski, *Transylvania*.  
 Rag-trade, (Supp.).  
 Rahad, *Nile*.  
 Rajajan (r.), *Borneo*.  
 Raia, *Ray, Thornback*.  
 Raiaza, *Coral Is., Society Is.*  
 Rain torpedo, *Electricity, Animal*, 821.  
 Railway trains, Gas-lighting in, *Gas-lighting* (Supp.).  
 Raim, *Caulking*.  
 Rain-doctors, *Beljans*.  
 Rajagriha, *Bahar*.  
 Rajasthan, *Rajpoots*.  
 Rajmahal Hills, *India*, 537.  
 Raki, *Arrack*.  
 Rakic Islands, *Radack*.  
 Rames, *Bahmeria* (Supp.).  
 Rame Head, *Cornwall*.  
 Ram feast, *Beltein*.  
 Ramgunga (r.), *Budalam* (Supp.).  
 Ramier, Mount, *Washington Territory*.  
 Ramisseram, *Manna, G. of*.  
 Ramnad, (Supp.).  
 Ramnaggar, battle of, *Sikh Wars*.  
 Ramps, *Rampion*.  
 Rampur, *Rohilkund*.  
 Rampura, *Indore*.  
 Ramree, *Aracan* (Prov.).  
 Ramseez, *Rameses*.  
 Ramsons, *Allium*.  
 Ram-tarsi, *Fibricus*.  
 Ramay, *Natuna Is.*  
 Rance (r.), *Côte-du-Nord*.  
 Randazzo, (Supp.).  
 Ranelagh, (Supp.).  
 Rank, relative, *Relative Rank*.  
 Ransome, Frederick, *Stone, Artificial*.  
 Rapaces, *Accipitres*.  
 Rape, *Riding*.  
 Raphoe, *Adaman* (Supp.).  
 Rapperschwyll, *Gulf, St. Canton of*.  
 Rapti (r.), *Ghagra, Oude*.  
 Raratonga, *Cook Is.*  
 Ras, *Abyssinia*.  
 Ras Mohammed, *Red Sea*.  
 Rasores, *Gallinaceous Birds*.  
 Rat Islands, *Australian Is.*  
 Rata, *Inocarpus*.  
 Ratamanow, *Diomed Is.*  
 Ratan, *Rattan*.  
 Ratanhia, *Rattany*.  
 Rathdrum, *Wicklow*.  
 Rathmelton, *Donegal*.  
 Rathmines, *Dublin*.  
 Ratnageriah, *Concan*.  
 Rattan, *Rattan*.  
 Rattening, *Trades Unions* (Supp.).  
 Rattles, *Respiratory Sounds*.  
 Rattlesnake fern, *Botrychium*.  
 Rattoons, *Sugar-cane*.  
 Ratzburg, *Lauenburg, Mecklenburg-Strelitz*.  
 Raucoux, battle of, *Saxe, Count of*.  
 Raenthaler, *Rhino-wine*.  
 Ravee or Ravi (r.), *Chenab, Punjab*.  
 Ravenala, *Traveller's Tree*.  
 Ravensbourne, *Deptford*.  
 Ravensburg, (Supp.).  
 Rawtenstall, *Newchurch* (Supp.).  
 Ray, Cape, *Newfoundland*.  
 Ray-grass, *Rye-grass*.  
 Raymond VI. and VII. Counts of Toulouse, *Albigenses*.  
 Rays of fine, *Fishes*, 352.  
 Razor-back, *Rorqual*.  
 Rea, *Rh.*  
 Rea (r.), *Birmingham*.  
 Read, Gabriel, *Olago*.  
 Real distance, *Vision, Opt.*  
 Reate, *Rieti*.  
 Rebaptizers, *Rasholik*.
- 'Rebecca' riots, *Caermarthenshire*.  
 Rebeira Grande, *Anores*.  
 Recanati, (Supp.).  
 Recorcelle, *Cercle*.  
 Reciprocal proportion, law of, *Atomic Theory*.  
 Recognition, *Wardholding*.  
 Record of Title Office, *Incorporated Estates* (Supp.).  
 Recreantitious products, *So-crimion*.  
 Recruiting, *War Services* (Supp.).  
 Rectified spirit, *Alcohol*.  
 Rectus muscle, *Patella*.  
 Reculet de Toiry (mt.), *Yura*.  
 Red bird, *Cardinal Bird*.  
 Red-breasted goose, *Barnacle Goose*.  
 Red charcoal, *Charbon Rouge*.  
 Red dog, *Dhole*.  
 Red flames, *Sun*.  
 Redif, *Turkey*, 588.  
 Redl, *Signals*.  
 Red lead, *Red Colours*.  
 Red-legged crow, *Chough*.  
 Redon, *Ille-et-Vilaine*.  
 Redondillas, *Spanish Lang. & Lit.*, 80.  
 Red River Settlement, *Canada* (Supp.), 448.  
 Red-tailed hawk, *Buzzard*.  
 Reed, *Ruminantia*.  
 Reed (r.), *Tyne*.  
 Reed bird, *Bob-a-link*.  
 Reed-mace, *Bulrush*.  
 Reed meadow grass, *Manna Grass*.  
 Reedy sweet water grass, *Manna Grass*.  
 Reek, the, *Westport*.  
 Reel, *Spinning*, 48.  
 Reel, angler's, *Angling*, 295.  
 Reeve, *Ruff*.  
 Reeves, Sims, (Supp.).  
 Referee, *Arbitration*, 359.  
 Reflecting faculties, *Physiology*, 517.  
 Reform, (Supp.).  
 Reformed Franciscans, *Recollct.*  
 Refrigerating machines, (Supp.).  
 Refrigeratory, *Still*.  
 Regalim, *Sveon*.  
 Regen (r.), *Bavaria*, 760.  
 Reggio, Duke of, *Oudinol*.  
 Regina, *Ymo*.  
 Regj Lagui, *Acerra* (Supp.).  
 Regnier, *Satire*.  
 Regnitz (r.), *Bavaria*, 760.  
 Regola de la Cosa, *Algebra*.  
 Regulus St. Andrews, *St. Reichenbach*, battle of, *Seven Years War*, 637.  
 Reidkjöbing, *Langeland*.  
 Rei interventus, *Locus Panti-tinia*.  
 Reims, *Rheims*.  
 Reineke Vos, *Reynard the Fox*.  
 Reiser work, *Buhl-work*.  
 Rejang (r.), *Sarawak*.  
 Relief, *Sculpture*, 575.  
 Relief Presbytery, *Scotland, Church of*, 562.  
 Religious Brotherhoods, *Brotherhoods, Religious*.  
 Rembang, *Java* (Supp.), 580.  
 Rembo (r.), *Opehai* (Supp.).  
 Remus, *Romulus*.  
 Rena, *Gloemen*.  
 Reni, (Supp.).  
 Renne's current, *Biscay, B. of*.  
 Rennet, *Ruminantia*.  
 Rental bolls, *Teinds*.  
 Reo, *Salmon*, 449.  
 Repeating circle, *Sextant*.  
 Repeating guns, *Revolver*.  
 Republican Fork, *Nebraska*.  
 Rescript, *Pragmatic Sanction*.  
 Reserve forces of the United Kingdom, *War Services* (Supp.).  
 Reshid Pasha, *Abdul-Medjid-Khan*.  
 Residual, *Compromis*.  
 Resist style, *Calico Printing*, 513.
- Resort (l.), *Lewis-with-Harris*.  
 Responsibility, *Belief*, 8.  
 Restitution edict, *Thirty Years War*.  
 Rete mirabile, *Circulation*, 47.  
 Reticulum, *Ruminantia*.  
 Retimo, (Supp.).  
 Retinitis, *Trop.*  
 Retort, gas, *Gas*, 635.  
 Retours of Services, *Records, Public*.  
 Retrone (r.), *Vicinas*.  
 Retroversion, *Womb, Diseases & Derangement of the*, 251.  
 Retting, *Flax-dressing*.  
 Return tickets, *Railways*, 90.  
 Reuse, *Newshatel*.  
 Reuss, *Germany* (Supp.), 535.  
 Reuss (r.), *Alps*.  
 Revivals of religion, (Supp.).  
 Rewah, (Supp.).  
 Rewbel, *Directory*.  
 Rewund, *Ruharab*.  
 Reynosa, battle of, *Spain*, 17.  
 Rhartrians, *Switzerland*, 246.  
 Rhaiadr Waterfall, *Drumhugh*.  
 Rhamnin, *Buchhorn*.  
 Rhamphorhynchus, *Pterodactyl*.  
 Rhazes, *Medicine, Hist. of*.  
 Rhea Silvia, *Romulus*.  
 Rheidol, *Cardiganshire*.  
 Rheta, *Ruharab*.  
 Rheineck, *Rhine*.  
 Rheinprovincen, *Rhenish Prussia*.  
 Rhein-Zabern, *Zabern*.  
 Rhenus, *Rhine*.  
 Rheostat, *Galvanism*, 602.  
 Rheum, *Ruharab*.  
 Rheydt, (Supp.).  
 Rhinencephalon, *Skull*, 761.  
 Rhins of Galloway, *Wigtown*.  
 Rhion, Cape, *Atolia*.  
 Rhippi Montes, *Ural Mts.*  
 Rhipiptera, *Strepsiptera*.  
 Rhithymos, *Cauda*.  
 Rhizocarpeæ, *Marsilaceæ*.  
 Rhizomes, *Cereæ*.  
 Rhizophagon, *Truffle*.  
 Rhodana, *Rhone*.  
 Rhodes, *Aveyron*.  
 Rhonchus, *Respiratory Sounds*.  
 Rhônegebirge, *Bavaria, Saxo-Meisingen*.  
 Rhun, *Moluccas*.  
 Rhus, *Sumach*.  
 Rhyddlan, *Flintshire*.  
 Rhyme, *Rhima*.  
 Rhymney, *Cardiff*.  
 Rhynchaspis, *Shorelloer*.  
 Rhynchites, *Weevil*.  
 Riad, *Wahabie*, 45.  
 Rialto, *Isola di, Venice*, 750.  
 Ribalta, *Francesco, Ribera*.  
 Ribbing, Count, *Anhaltström*.  
 Ribble, *Lancashire*.  
 Ribbon grass, *Canary Grass*.  
 Ribchester, *Preston*.  
 Ribeira Grande, *St Michael's*.  
 Ribes, *Gooseberry*.  
 Ribs, *Ship-building*, 684.  
 Rice bird, *Bob-a-link*.  
 Rice weevil, *Corn Weevil*.  
 Richardia, *Calla* (Supp.).  
 Richardson, Dr., *Methylene* (Supp.).  
 Richebourg, *Lille*.  
 Richelieu, *Canada*, 548.  
 Richibucto, *New Brunswick*.  
 Richmond, *Pr. Edward's I.*  
 Richmond (r.), *N. S. Wales*.  
 Richmond, Earl of, *Tudor*.  
 Ricimer, *Rome*, 321.  
 Ricinia, or Ricnia, *Rathlin*.  
 Ricord, Ph. (Supp.).  
 Rideau, *Ottawa* (r.).  
 Rideau Canal, *Canada*, 550.  
 Riders, *Wall-trees*.  
 Rieselstock (mt.), *Schwyz*.  
 Rieti, (Supp.).  
 Rifled arms, *War Services* (Supp.).  
 Rifles, *Breach-loading Arms* (Supp.).  
 Right-boys, *Whitby*.
- Rights of Man, *Paine, T.*  
 Right whale-porpoise, *Dol-phinaptera*.  
 Rille, *Orne*.  
 Rimi, *Eriodendron*.  
 Rimma (r.), *Ural*.  
 Rim stock, *Clog Abacus*.  
 Rinaldo, *Armad*.  
 Rind, *Yamma*.  
 Rinderpest, *Cattle-plague* (Supp.).  
 Ringed snake, *Cobler*.  
 Ringtail, *Harrier*.  
 Rink, *Curling*.  
 Rinman's green, *Cobalt*.  
 Rinn, Lough, *Leitrim*.  
 Riobamba, (Supp.).  
 Rio Coco, *Nicaragua*.  
 Rio de Aveiro, *Aveiro* (Supp.).  
 Rio del Monte, *Tagn*.  
 Rio del Rey, *Biafra*.  
 Rio de Senna, *Sofala*.  
 Rio Dulce, *Golfo Dulce*.  
 Rio Grande, *Texas*.  
 Rio Grande de Lerma, *Chap-ala*.  
 Rion, *Phasia, Poty*.  
 Rios di Senna, *Zambou*.  
 Rio Tinto, *Moguer* (Supp.).  
 Rippling, *Flax-dressing*.  
 Rissel, *Lille*.  
 Ristori, Ad. (Supp.).  
 Ritardando, *Lento*.  
 Ritualism, (Supp.).  
 Riva, *Tyrol*.  
 Rivis, *Nicaragua* (Supp.).  
 River limpet, *Limnea*.  
 Rivers, Mr., *Orchard-house*.  
 Rivesalt, *Muscadet*.  
 Rivesaltes, *Pyrenean Ori-entales*.  
 Rivière du Lièvre, *Ottawa* (r.).  
 Rivière du Moine, *Ottawa* (r.).  
 'Rivulet' controversy, *Dine-ney, Th.*  
 Rizah, (Supp.).  
 Rjev, *Rchern* (Supp.).  
 Roach (r.), *Hayward* (Supp.).  
 Road, right of, *Sevotude*.  
 Roag (l.), *Lewis-with-Harris*.  
 Roanne, *Loire*.  
 Roaring buckie, *Fusus*.  
 Robert, Louis, *Paper*, 944.  
 Robertus, *Sordanus*.  
 Roberts, David, (Supp.).  
 Robertson, Jos. (Supp.).  
 Robin, *Redbreast*.  
 Robin, (Supp.).  
 Robusti, *Jacopo, Tiberius*.  
 Rocca-bruna, *Monaco*.  
 Rochambeau, *Comt de, U.S.* 655.  
 Rochecouart, *Vicenz, Hantz*.  
 Rock, *Spinning*, 46.  
 Rock (r.), *Waterloo*.  
 Rock-cork, *Asbestus*.  
 Rocket, *dyer's, Weld*.  
 Rockets, *Life-mortar, &c.* (Supp.).  
 Rock-fish, *Basar*.  
 Rockhampton, *Queensland*.  
 Rockites, *Whitby*.  
 Rock-leather, *Asbestus*.  
 Rock manakin, *Rock, Cost of the*.  
 Rock-rose, *Clifton*.  
 Rock-shell, *Murex*.  
 Rock-snake, *Bongor, Python*.  
 Rock-wood, *Asbestus*.  
 Rocky Island, *Cork*.  
 Rocky Mt. sheep, *Angul*.  
 Rod, fishing, *Angling*, 294.  
 Rodach (r.), *Saxe-Coburg-Gotha*.  
 Rodger, Andrew, *Famen*.  
 Roding (r.), *Saxe, Thama*.  
 Rodman gum, *War Services* (Supp.).  
 Rodna, *Transylvania*.  
 Rod of Aaron, *Dancing Rod*.  
 Rodolf, *Rudolf*.  
 Rodriguez, *Island of, Solitaire*.  
 Roe, *Fishes*, 354.  
 Roe, soft, *Reproduction*, 97.  
 Roebuck, *Roe*.  
 Roebuck, Dr. *Wall*.  
 Roer (r.), *Maastricht*.  
 Rofia (r.), *Alphons*.

INDEX.

Rogenia, *Whitebait*.  
 Rogers, Professors, *America*, 202.  
 Rogues' Novel, *Spanish Lang. & Lit.* 20.  
 Rohan, Duke of, *Huguenots*, 452.  
 Rohtuk, (*Suppl.*)  
 Rohma, *Cadrelaca*.  
 Rojak (i.), *Alutian Is.*  
 Roker, *Sunderland*.  
 Rolandina, *Roland de la Platière*.  
 Rolling stock, *Railways*, 89.  
 Rolls, *Records, Public*.  
 Rom, *Gypsies*, 170.  
 Romaic Greek, *Greece*, 82.  
 Romaika, *Pyrrhic Dance*.  
 Roman candle, *Pyrotechny*.  
 Romance languages, *Romanic Languages*.  
 Romanche, *Idru*.  
 Romano, *Giulio Pippi*.  
 Roman order, *Roman Architecture*.  
 Roman strings, *Gut Manufacture*.  
 Romanus II. III. IV. *Byzantine Empire*, 471.  
 Romeo and Juliet, *Capulets* (*Suppl.*)  
 Romerwaal, *Beveland*.  
 Romney, *America, Owen, Robert*.  
 Romni, *Moldavia*.  
 Romulea, *Biaccia*.  
 Roman, *Adaman* (*Suppl.*)  
 Ronas Hill, *Shetland*.  
 Ronay, *Shyre*.  
 Roncal, *Navarre*.  
 Rondelet, W. (*Suppl.*)  
 Rønne, *Bornholm*.  
 Rood, *Kod*.  
 Roodpeer, *Phoberus*.  
 Room, *Acanthus*.  
 Roonerain, *Dalhousie*.  
 Root (r.), *Racine (town)*.  
 Root, crown of the, *Stem*.  
 Roper (r.), *Australian Explorations* (*Suppl.*) 412.  
 Roquefort cheese, *Affrique, St.* (*Suppl.*)  
 Rosalia's, *St. wreath of roses, Rosary*.  
 Rosa Maria, *Rose of Jericho*.  
 Rosamond, *Albion*.  
 Rosamond, *Henry II. of England*.  
 Rosario, (*Suppl.*)  
 Rosas Bay, *Catalonia*.  
 Rose, Rev. Hugh, *Tractarianism*.  
 Rose apple, *Eugenia*.  
 Rose bay, *Oleander*.  
 Roseberry Topping Hill, *Cleveland*.  
 Rose-chafar, *Turnip*.  
 Roseine, *Dye-stuffs*.  
 Rose laurel, *Oleander*.  
 Rosemary, *Dampier Archip.*  
 Rosemary, marsh, *Statics*.  
 Rosencranz, *General, U.S.* 660.  
 Roseneath, *Dumbartonshire*.  
 Rosenkreuz, *Father, Rosicrucians*.  
 Rose of the Virgin, *Rose of Jericho*.  
 Rose-point, *Lacc*.  
 Rose-spots, *Typhus and Typhoid Fevers*, 612.  
 Rosette, *Leaves*.  
 Rosewood, *Coccolobus*.  
 Rosmarinus, *Rosemary*.  
 Rosoglia, *Orange*.  
 Rosolic acid, *Tar*.  
 Rosieny, (*Suppl.*)  
 Rosslare Point, *Wexford*.  
 Rosso antico, *Trap*.  
 Rossoli, *Sunder*.  
 Ros solis, *Sunder*.  
 Rota, (*Suppl.*)  
 Rotation of crops, (*Suppl.*)  
 Rothay (r.), *Windermere*.  
 Rothenberger, *Rhine-wine*.  
 Rother (r.), *Don, Yorkshire*.  
 Rother (r.), *Midhurst*.  
 Rothschild, *Almaden*.  
 Rotomagus, *Rouen*.

Rotorus (i.), *New Zealand*.  
 Rottang, *Rattan*.  
 Rottlera, *Vermifugus* (*Suppl.*)  
 Rottum, *Bornholm*.  
 Rotuli Curis Regis, *Records, Public*.  
 Rotuli Hundredorum, *Records, Public*.  
 Rotuli Scotia, *Records, Public*.  
 Roubilliac, *Rybrach*.  
 Roucou, *Arnetio*.  
 Rouenneries, *Rouen*.  
 Roughan (i.), *Cranmages*.  
 Rough Bounds, *Inverness-shire*.  
 Rouher, *Eugène, (Suppl.)*  
 Rouillon, *Denis, St.*  
 Roumania, *Rumania* (*Suppl.*)  
 Roundpot, *Schedlt*.  
 Roundels, *Besants*.  
 Round-fish, (*Suppl.*)  
 Round-tail, *Bull-trout*.  
 Round Top (mt.), *Appalachians*, 321.  
 Roup, *Pip* (*Suppl.*)  
 Rovigo, *Duke of, Savary*.  
 Roving, *Spinning*, 46.  
 Rovuma, (*Suppl.*)  
 Row-lock, *Oar*.  
 Rowsa, *Rousay*.  
 Roxana, *Alex. the Great*.  
 Roxburghia, *Smilacae*.  
 Roxolani, *Sarmatians*.  
 Royal Canal, *Westmeath*.  
 Royal fern, *Osmunda*.  
 Royal Islands, *Moluccas*.  
 Roy Bareilly, *Oude*.  
 Royer-Collard, P. P. (*Suppl.*)  
 Roymala, *Calcutta*.  
 Royston, *Cambridgeshire*.  
 Rozenburg, *Netherlands*.  
 Rovingain, *Moluccas*.  
 Rahew, (*Suppl.*)  
 Ruabon, *Dunhighshire*.  
 Ruapahu, *New Zealand*.  
 Rubble, *Brash*.  
 Rubellite, *Tourmaline*.  
 Rubella, *Measles*.  
 Ruble, or rubel, *Kowle*.  
 Ruby, *Type*, 607.  
 Ruby, *Alamandine, Spinel*.  
 Ruby, *Bohemian, Rose-quartz*.  
 Ruby-tailed fies, *Chrysis*.  
 Rudnik Mts. *Serbia, Cap.*  
 Rudolf, *Christian, Algebra*.  
 Rudolphine Tables, *Rudolf II.*  
 Ruellia, (*Suppl.*)  
 Rufes, or Rufa (r.), *Alpheus*.  
 Ruffec, *Charente*.  
 Ruffed grouse, *Bonasia*.  
 Ruffigalic acid, *Gallic Acid*.  
 Rufus the Ephesian, *Anatomy*, 228.  
 Ruglen, *Rutherglen*.  
 Ruifsdaal, *Ruyssdael*.  
 Ruiz, Juan, *Spanish Lang. & Lit.* 19.  
 Rule, St. *Andrews, St.*  
 Rumania, (*Suppl.*)  
 Rumen, *Ruminantia*.  
 Rumez, *Sorrel*.  
 Rumination, *Ruminantia*.  
 Rumney (r.), *Glamorgan-shire, Monmouth*.  
 Rumons, *Romanic Languages*.  
 Rumsey, *Steam-navigation*.  
 Rumuni, *Austria*.  
 Run, *Victoria*, 787.  
 Runa, *Navarre*.  
 Runcinate, *Leaves*.  
 Runes, *Manhowe* (*Suppl.*)  
 Runic knotwork, *Runes*.  
 Runic staff, *Clog Almanac*.  
 Runn, *Cutch*.  
 Runstoffs, *Almanac*.  
 Rupel (r.), *Schedlt*.  
 Rupertsberg, *Bingen*.  
 Rupicola, *Rock, Cech of the*.  
 Ruremonde, *Roermond*.  
 Rush-out, *Cyperus*.  
 Rusky Mt. *Pruth*.  
 Russ (r.), *Niemen*.  
 Russell, W. H. *Times, Tho.*  
 Russia, *Great, White, Little, &c. Russias, All the* (*Suppl.*)  
 Russian America, *America, Russian, U.S.* (*Suppl.*)  
 Russians, *All the*, (*Suppl.*)

Rustenber, *Transvaal Republic*.  
 Ruta, *Rue*.  
 Rute, (*Suppl.*)  
 Rutheni, *Russians*.  
 Ruthenians, *Rom. Cath. Ch.*  
 Rutaric acid, *Caproic Ac.* (*Suppl.*)  
 Rusicilla, *Redstart*.  
 Rutland, *Vermont*.  
 Ruvigado, (*Suppl.*)  
 Ryland, *Engraving*, 68.  
 Rymnik, *battle of, Swoorof*.  
 Ryots, *Oude*.  
 Ryssen, *Overysel*.  
 Rytina, *Stellerine*.  
 Sa, *Sais*.  
 Saaba, *Africa*, 69.  
 Saale, *Main*.  
 Saal-Eisenberg, *Saxe-Allenburg*.  
 Saalfeld, *Saxe-Meiningen*.  
 Saane, *Friburg*.  
 Saarlouis, (*Suppl.*)  
 Saba, *Antilles*.  
 Sabbatarians, *Sabbath*, 402.  
 Sabbatharies, or Sabbathians, *Sabbathais Zwi*.  
 Sabbaths, *witches, Witchcraft*, 234.  
 Sabia (r.), *Transvaal Republic*.  
 Sabine women, *rape of the, Romulus*.  
 Sabinus, P. *Vitellius, Aulus*.  
 Sabor (r.), *Braganza*.  
 Sabre-fish, *Hair-tail*.  
 Saburmuttee, *Cambay*.  
 Sacadina, *Borneo*.  
 Saccharates, *Glucose*.  
 Saccharomyces, *Tortula Cervisia*.  
 Sacramedia, *Aorta*.  
 Sacred Isle, *Manitowlin Is.*  
 Sacred standard, *Relics*.  
 Sacrifice, *human, Orissa*.  
 Sadang (r.), *Sorowak*.  
 Saddle Peak, *Sierra Nevada*.  
 Sadler, *Engraving*, 69.  
 Saenredam, *Engraving*, 69.  
 Safeguard, *Dragon*.  
 Saffron, *bastard, Safflower*.  
 Saffronwood, *Eleodendron*.  
 Sagitta, *Worms*, 279.  
 Sagoakin, *Russian Lang. & Lit.*  
 Sagua-la-Grande, (*Suppl.*)  
 Saguenay (r.), (*Suppl.*)  
 Saharanpur, (*Suppl.*)  
 Sahel, *Algeria*, 142.  
 Sahidic, *Coptic*.  
 Sai, *Cobus*.  
 Safan (mts.), *Irkutsk*.  
 Saïd, *Port, Suez Canal* (*Suppl.*)  
 Saigon, *dock at, Floating Docks* (*Suppl.*)  
 Sail-sous-Couzan, *Loire*.  
 Saima (i.), *Finland*.  
 St Agnes, *Scilly Islands*.  
 St Alban, *Loire*.  
 St Alban Hall, *Oxf.* (*Suppl.*)  
 St Albans, *Vermont*.  
 St Alban's Head, *Dorsetshire*.  
 St Andool, *Arctiche*.  
 St Anne (i.), *Seychelles Is.*  
 St Anthony's Fire, *Raphania*.  
 St Anthony's Well, *Antony, St.*  
 St Bel, C. V. de, *Veterinary Medicine*.  
 St Bride's Bay, *Pembrokesh.*  
 St Cassian Beds, *Secondary*.  
 St Colme, *Lords, Stewart Family*, 124.  
 St Colum-cill, *Columba*.  
 St Cuthbert's duck, *Eider*.  
 St Denis, *Bourbon, Ile de*.  
 Ste Ampoule, *La, Arima*.  
 Ste-Beuve, C. A. (*Suppl.*)  
 Ste-Claire Deville, *H.E.* (*Suppl.*)  
 Ste Claude, *Yura*.  
 St Edmundsbury, *Bury St Edmunds*.  
 St Elmo, *Point of, Valetta*.  
 Ste Marie, *Nozzi-Ibrahim* (*Suppl.*)  
 Ste-Marie-aux-Mines, (*Suppl.*)  
 Ste-Ménchould, *Marme*.  
 Ste-Reine, *Ardia*.  
 St Francis, *Canada*, 548.

St Francis Bay, *Cape of Good Hope*.  
 St Galmies, *Loire*.  
 St George, *Grenada*.  
 St George's, *Newfoundland*.  
 St George's (r.), *Sulina*.  
 St Girons, *Ardge*.  
 St Helen, *Mount, Washington (territory)*.  
 St Helen's Beds, *Osborne Beds*.  
 St Helen's Roads, *Wight, Isle of*.  
 St Hubert dog, *white, Talbot*.  
 St Jacques, *Cape, Saigon*.  
 St Jago di Compostella, *Galicia*.  
 St Jean de Luz, *Pass of, Pyrenees*.  
 St Jean de Maurienne, *Savoie*.  
 St Jean Pied du Port, *Pass of, Pyrenees*.  
 St John, *Cape, Staten Island* (*Suppl.*)  
 St John, H. *Böllingbrohe*.  
 St John (r.), *Kaffraria*.  
 St John Long's liniment, *Turpentine*.  
 St John's (i.), *America*, 202.  
 St John's (r.), *New Brunswick*.  
 St Jorgo, *Azores*.  
 St Julian, *Savoie*.  
 St Kiits, *Christopher's, St.*  
 St Leonard's Forest, *Sussex*.  
 St Louis, *Nassi-Ibrahim* (*Suppl.*)  
 St Louis, (*Suppl.*)  
 St Louis (r.), *Lawrence, St (r.)*  
 St Louis (r.), *Superior, Lake*.  
 St Lucia (r.), *Zuluiland*.  
 St Marcellin, *Idru*.  
 St Margaret's Bay, *Nova Scotia*.  
 St Margaret's Hope, *Forth, Firth of*.  
 St Mark, *Grenada*.  
 St Martha wood, *Brazil Wood*.  
 St Martin, *Ré, Ile de*.  
 St Martin's, *Scilly Islands*.  
 St Martin's summer, *Weather*.  
 St Mary, *Azores*.  
 St Mary, *Lawrence, St (r.)*  
 St Mary's, *Newfoundland*.  
 St Mary's, *Scilly Islands*.  
 St Mary's Bay, *Nova Scotia*.  
 St Mary's Loch, *Yarrow*.  
 St Maur, *Seymour*.  
 St Maurice (r.), *Canada*, 548.  
 St Michel (mt.), *Avranches* (*Suppl.*)  
 St Myon, *Puy-de-Dome*.  
 St Patrick, *Grenada*.  
 St Paul (i.), *Amsterdam I.*  
 St Pauls (i.), *Lawrence, St, G.*  
 St Peter's Bay, *Pr. Edward's I.*  
 St Peter's (r.), *Minnesota R.*  
 St Pierre, (*Suppl.*)  
 St Pierre, *Hill of, Maastricht*.  
 St Pierre-les-Calais, (*Suppl.*)  
 St Pietro di Brazza, *Brassa*.  
 St Pol, *Pas-de-Calais*.  
 St Sauveur, *Pyrenées, Hautes*.  
 St Sebastian's Bay, *Cape of Good Hope*.  
 St Sever, *Landes*.  
 Saint's Isle, *Derg*.  
 St Sophia, *Zarsko-Selo* (*Suppl.*)  
 St Thomas, *U.S.* (*Suppl.*)  
 St Ube's, *Setubal*.  
 St Vincent, *Gulf, S. Australia*.  
 St Yrieix, *Vienne, Haute*.  
 Saïsang (i.), *Siberia*, 702.  
 Sajo (r.), *Roeman*.  
 Saka, *Enarua*.  
 Sakaria (r.), *Turkey*, 587.  
 Sakdyt-el-Kublee, *Boronica*.  
 Sakkariah, *Anatolia*, 206.  
 Sakky, *Lake of, Taurida*.  
 Sal, *Cape Verd Islands*.  
 Sal, *Don*.  
 Salar, *Salmon*, 445.  
 Salaria, *Leaping Fish* (*Suppl.*)  
 Salassi, *Aosta*.  
 Salawatti, *Papua*, 251.  
 Salcombe Hill, *Sidmouth*.  
 Salduba, *Saragossa* (*Suppl.*)  
 Sale, *bill of, Bill of Sale*.  
 Salem, *Oregon*.  
 Salembria (r.), *Trithala*.



INDEX.

Salemi, (Supp.)  
 Salisbury, William, *Welsh Lang. & Lit.* 137.  
 Salgado (r.), *Ice* (Supp.)  
 Salgir (r.), *Taurida*.  
 Salicaceae, *Willow*.  
 Salicaria, *Warbler*.  
 Salk lands, *Salk Law*.  
 Salient angles, *Fortification*, 141.  
 Sali, *Batavi*.  
 Saline (r.), *Washita*.  
 Salina, (Supp.)  
 Salisbury Cathedral, *Gothic Architecture*, 95.  
 Salisbury Crags, *Arthur's Seat*.  
 Salle, Abbé de la, *Schools, Brothers of Christian*.  
 Salice, (Supp.)  
 Salmalia, *Silk-cotton*.  
 Salmon of North-west America, (Supp.)  
 Salmon peel, *Salmon*, 448.  
 Salon (r.), *Aragon*.  
 Salisa (r.), *Alicata* (Supp.)  
 Salsilla, *Astromerica*.  
 Salso (r.), *Sicily*, 704.  
 Salsola, *Betoderr*.  
 Salsolaceae, *Chenopodiaceae*.  
 Salt (l.), *Holyhead*.  
 Salta, Sierra de, *Andes*, 239.  
 Saltementum ardicum, *Tunny*.  
 Saltanco, *Natron*.  
 Salter's balance, *Spring Balance*.  
 Salt Hill, *Montem Custom*.  
 Salt of sorrel, *Lemon, Salt of*.  
 Salt oil, *Bittern*.  
 Saltpetre, Chili, *Sodium*, 801.  
 Salt-water fluke, *Dab*.  
 Salvage, *Merchant Shipping Act* (Supp.), 632.  
 Salvia, *Sage*.  
 Salzwag, *Droitwich*.  
 Salween (r.), *Tenasserim*.  
 Salza (r.), *Enns, Salzburg*.  
 Salzburger Head, *Nassau*.  
 Samalov, *Russian Lang. & Lit.*  
 Samara (r.), *Somme*.  
 Samaria wood, *Licca* (Supp.)  
 Sambas, *Borneo*.  
 Sambawa, *Comodo*.  
 Sambor, New, (Supp.)  
 Sambre (r.), *Maas, Namur*.  
 Sambul, *Simoom*.  
 Samen or Samien (mts.), *Abyssinia*.  
 Samrahan (r. and mt.), *Sarawak*.  
 Samhara, *Abyssinia*.  
 Samiel, *Simoom*.  
 Samlet, *Salmon*, 447.  
 Samneas, *Shammai*.  
 Samnite war, *Rome*, 314.  
 Samogitia, *Lithuania*.  
 Samokrischtchina, *Raskolnik*.  
 Samolus, *Pimpernel*.  
 Samoo (l.), *Timor*.  
 Samoun, *Simoom*.  
 Samoyedic language, *Thracian Languages*.  
 Samp, *Maize*.  
 Sampet (r.), *Borneo*.  
 Sampson (l.), *Sicily Islands*.  
 Samshoo, *China*, 818.  
 Samson's Ribs, *Arthur's Seat*.  
 Samsun, *Black Sea*.  
 San (r.), *Vistula, Jaworow* (Supp.)  
 San Antioch Island, *Sardinia, Island of*.  
 San Antonio, *Cape Verd Is.*  
 San Bernardino, Mount, *Sierre Nevada*.  
 San Carlos, *Chilol*.  
 San Carlos, *Campinas* (Supp.)  
 Sancerre, *Cher*.  
 Sanctuary, *Tabernacle*.  
 Sand-box tree, *Hura*.  
 Sanders, *Sandal-wood*.  
 Sanders, Joseph, *Railways*, 85.  
 Sand Head, N. & S. *Goodwin Sands*.  
 Sandhurst, (Supp.)  
 Sand-mole, *Mole-rat*.  
 Sandomir Mts. *Radom*.

Sandoway, *Aracan* (prov.)  
 Sandown, *Wight, Isle of*.  
 Sand ray, *Homelyn*.  
 Sand reed, *Amorphilla*.  
 Sand smelt, *Atherine*.  
 Sandstone, red, *Red Sandstone*.  
 Sand-wasps, *Bembecida*.  
 Sandwich (is.), *America*, 194.  
 Sandwich Harbour, *Namaland*.  
 Sandwich Land, *Antarctic Ocean*.  
 Sandy Point, *Christopher's, St.*  
 San Fele, (Supp.)  
 San Fernando, *Trinidad*.  
 San Fratello, (Supp.)  
 Sanga, *Galla Or.*  
 Sangar, *Sumbawa*.  
 Sangar Strait, *Yesso*.  
 San Germano, vapour baths of, *Agnano*.  
 San Giuliano, Monte, *Sicily*, 704.  
 Sanguine diathesis, *Scrofula*.  
 San Ignacio de Agaña, *Ladrones*.  
 Sanitary science, (Supp.)  
 San Jacinto, battle of, *Texas*.  
 San Jose, *California*.  
 San Juan (l.), *Puca, Strait of*.  
 San Juan (r.), *Nicaragua*.  
 San Juan de la Frontera, (Supp.)  
 San Luis de la Punta, (Supplement.)  
 San Luiz de Maranham, *Maranham*.  
 San Luzia, *C. Verd Islands*.  
 San Marco in Lamis, (Supp.)  
 San Martin (r.), *Aragon*.  
 San Mateo, (Supp.)  
 San Miguel, G. of, *Darien*.  
 San Miguel de Ibarra, *Ibarra*.  
 San Pietro (l.), *Sardinia, I. of*.  
 Saopo (r.), *Dikong*.  
 Saouhar, *Dumfriessh*.  
 San Ramon, Fort, *Andes*, 238.  
 San Roque (r.), *Columbia*.  
 San Salvador, *Bahamas*.  
 San Salvador, *Bahia*.  
 San Salvador, *Bayamo* (Supp.)  
 San Salvador, *Congo*, (Supp.)  
 San Sebastian, *Cape, Catalonia*.  
 Sansevera, *Bovstring Hemp*.  
 Santa Anna, (Supp.)  
 Santa Anna de Tamaulipas, *Tampico*.  
 Santa Casa, *Loretto*.  
 Santa Clara, *Clair, St.*  
 Santa Croce (mt.), *Cyprus*.  
 Santa Croce, Cape, *Catania*.  
 Santa Cruz, *Croix, Sainte*.  
 Santa Cruz, *Patagonia*.  
 Santa Cruz, *U.S.* (Supp.)  
 Santa Fé, (Supp.)  
 Santa Fé de Guajuato, *Guajuato*.  
 Santala, *India*, 539.  
 Santalum, *Sandal-wood*.  
 Santa Maria de Puerto Principe, *Puerto Principe*.  
 Santa Marta, (Supp.)  
 Santander, *New Granada*.  
 Santa Rosa, *Chakulia*.  
 Santiago, *Cuba*.  
 Santones, *Saintes*.  
 San Vicente, *C. Verd Is.*  
 Sanzoo, *Raphael*.  
 Sao Jose do Norte, *Rio Grande do Sul*.  
 Sao Pedro do Rio Grande do Sul, *Rio Grande do Sul*.  
 Saparoua, *Moluccas*.  
 Sapindus's tears, *Fir*, 334.  
 Sapor, *Sassanida*.  
 Saporog, *Cossacks*.  
 Sappare, *Cyanite*.  
 Sappho's Leap, *Ducato, C.*  
 Sap-roller, *Gabion*.  
 Sap-wood, *Alburnum*.  
 Sara, *Moonjak*.  
 Sarabaita, *Monachism*, 595.  
 Sarabat (r.), *Anatolia*, 226.  
 Saragossa, (Supp.)  
 Sarajewo, *Borna-Serni*.  
 Saransk, (Supp.)  
 Sarapis, *Serapis*.  
 Sarca, *Tyrol*.  
 Sarcode, *Sponge*.

Sarcophaga, *Blow-fly*.  
 Sarcopites, *Episaa*.  
 Sard, *Omyx*.  
 Sardo, *Sardinia, Island of*.  
 Sardonix, *Omyx*.  
 Sargans, *Rhine*.  
 Sargasso Sea, *Alga, Gulfweed*.  
 Sargus, *Sheep-head, Sparidae*.  
 Sargut, *Ob*.  
 Sari-kol, *Oxus*.  
 Sarine (r.), *Freiburg*.  
 Sarmenaceae, *Vitacea*.  
 Sarmiento, *Andes*, 239.  
 Sarnen, *Unterwalden*.  
 Sarnet Aa (r.), *Unterwalden*.  
 Sarothamnus, *Broom*.  
 Sarp-foss, *Glommen*.  
 Sarre (r.), *Moselle*.  
 Sarsooty (r.), *Saraswatt*.  
 Sart, *Sardes*.  
 Sartene, *Corica*.  
 Sarts, *Turkistan*, 584.  
 Sarum, New, *Salisbury*.  
 Sasanqua tea, *Camellia*.  
 Sasignan (l.), *Alsatian Is.*  
 Sasinis, Register of, *Registration of Deeds and Writs*.  
 Sassafras nuts, *Pitchurim Beans*.  
 Satallah, (Supp.)  
 Satt, *Uma*.  
 Satin spar, *Arragonite, Gypsum*.  
 Sattara, *Sattara*.  
 Satureja, *Savory*.  
 Saturn, *Planets*.  
 Saturnia, *Silk and Silkworm*, 724.  
 Saucie-alone, *Alliaria*.  
 Sauchie Burn, *Bannockburn*.  
 Sa'ud, *Wahabis*, 39, 40.  
 Sauerland, *Prussia*.  
 Saugor, (Supp.)  
 Sault Ste Marie, *Superior (L.)*.  
 Saunders (l.), *Parkland Is.*  
 Saurophidia, *Blindworm, Serpents*, 626.  
 Sauegarde, *Monitor*.  
 Savage (r.), *Potomac*.  
 Savaii, *Navigator's Is.*  
 Savanna blackbird, *Crotophaga*.  
 Save (r.), *Garonne*.  
 Savena (r.), *Bologna*.  
 Savenay, *Loire-inférieure*.  
 Saverne, *Zabern*.  
 Savery, Captain, *Steam-engine*, 99.  
 Savoy Palace, *Savoy Conference*.  
 Saw-wort, *Composita*.  
 Saxe-Lauenburg, *Saxony*, 515.  
 Saxe-Weimar, *Duchess of*.  
 Amalia.  
 Saxe-Wittenberg, *Saxony*, 515.  
 Saxicola, *Stone-chat, Wheat-ear, Whin-chat*.  
 Saxifraga crassifolia, *Tea*, 323.  
 Saxony, *Germany* (Supp.), 535.  
 Saxony blue, *Indigo*.  
 Sayan, *Chay Root*.  
 Sayer's Law, *Berwickshire*.  
 Sazawa, *Moldau*.  
 Scab, *Potato*.  
 Scævola, *Advocate*.  
 Scalaria, *Wentletrop*.  
 Scala Santa, *Lateran*.  
 Scalops, *Shrew Mole*.  
 Scalpy, *Shy*.  
 Scandia, *Scandinavia*.  
 Scanning, *Metre*, 429.  
 Scapa Flow, *Pomona*.  
 Scaphites, *Ammonites*.  
 Scapular arch, *Skeleton*, 753.  
 Scapulars, *Birds*, 108.  
 Scarborough, *Tobago*.  
 Scardagh, *Bosnia*.  
 Scardian Mts. *Macedonia*.  
 Scarf-skin, *Epidermis*.  
 Scarifer, *Grubber*.  
 Scarlet fever, *Scarlatina*.  
 Scarlet grain, *Coccus Kerms*.  
 Scarlet rash, *Rossola*.  
 Scarpa's shoe, *Club-foot*.  
 Scarpe (r.), *Pas-de-Calais*.  
 Scarus, *Parrot-fish*.  
 Scauvg, Bay of, *Shye*.  
 Scavenger beetle, *Scarabeida*.

Scavenger's daughter, *Torture*.  
 Schafarik, *Bohemia*, 190.  
 Scham, *Syria*.  
 Schamyi, *Shamyi*.  
 Scharlachberger, *Rhino-mia*.  
 Schärulin, *Schmalbad*.  
 Schazk, *Chatsk* (Supp.)  
 Scheemakers, *Kybrack*.  
 Schellenberg, *Lichtenstein*.  
 Shelly, *Gwyniad*.  
 Schiedam, *Gu.*  
 Schiehallion, *Grampians*.  
 Schiermoonikooq, *Friesland*.  
 Schiller-spar, *Dialage*.  
 Schilling, Baron von, *Tibet*, 339.  
 Schirbe (mt.), *Gall, St*.  
 Schleitheim, *Schaffhausen*.  
 Schlina (r.), *Caspian Sea*.  
 Schloss-Johannisberger, *Rhinewine*.  
 Schneeberg, *Eriger* (mt.), *Salzburg*.  
 Schneekoppe (mt.), *Sudteng-birge*.  
 Schneekopf (mt.), *Thuringerwald*.  
 Scholckand, *Overyssel, Zaidr Ze.*  
 Scholar's mate, *Chess*, 800.  
 Schöngauer, *Engraving*, 69.  
 Schoodie (r.), *Croix, St.*  
 Schooley's Mt. *New Jersey*.  
 Schoolmen, *Scholastics*.  
 Schools, reformatory, *Reformatory Schools*.  
 Schoppe, *Scioptips*.  
 Schouten (is.), *Papua*, 151.  
 Schouwen, *Schildt*.  
 Schreckhorn (mt.), *Alps*, 177.  
 Schtuzar (mt.), *Serbia*, 629.  
 Schultheiss, *Luzern*.  
 Schumadia, *Serbia*, 629.  
 Schmitt (l.), *Comora*.  
 Schwalbach, *Nassau*.  
 Schwale (r.), *Nemastor* (Supp.)  
 Schwann, *Anatomy*, 227.  
 Schwarz, Hans, *Carving*.  
 Schwarz, *Schwabenberg-Rudolstadt*.  
 Schwarzkopf (mt.), *Wirttemberg*.  
 Schwarzwald, *Black Forest*.  
 Schwegler, *Beer*.  
 Schwielochsee, *Spre*.  
 Schyl (r.), *Danube*.  
 Scythos, *Greece*, 85.  
 Scilla, (Supp.)  
 Scilla, *Scall*.  
 Scilly (l.), *Society Islands*.  
 Scioto (r.), *Chillicothe* (Supp.)  
 Scipiones Runic, *Almanac*.  
 Sclerotic, *Eye*, 202.  
 Soodra, *Scutari*.  
 Scogan, *Court Fool*.  
 Scoglio Marfo (l.), *Malta*.  
 Scolex, *Cestoid Worms, Larva*.  
 Scolo del Casale, *Allia*.  
 Scopolini, *Piarist*.  
 Scones, *Bread*.  
 Scoor-nan-Gillean (mt.), *Shy*.  
 Scopeloes, *Greece*, 85.  
 Scopus, *Umbro*.  
 Scorpion fish, *Scorpens*.  
 Scorpion grass, *Forget-me-not*.  
 Scot and lot voters, (Supp.)  
 Scotch broth, *Soup*.  
 Scots, *Bretts and Scots*.  
 Scott family, *Bucknuck*.  
 Scottish Episcopal Church, *Scotland, Church of, St.*  
 Sootus, *Marianus, Ireland*.  
 Sougal, Henry, *Scottish Lang. & Lit.*  
 Scouring drops, *Lemon, O. of*.  
 Scrabster, *Thurso*.  
 'Scrated', *Horse-racing*, 428.  
 Screw-alley, *Ship-building*, 684.  
 Screw bean, *Menguite* (Supp.)  
 Scribe, A. E. (Supp.)  
 Scriptorium, *Book*.  
 Scripture, *Bible*, 72.  
 Scripture-wort, *Gryphid* (Supp.)

INDEX.

- Scrivener's palsy, *Writers' Cramp*.  
 Scrophula, *Scrophula*.  
 Scuir of Egg, *Egg*.  
 Scurvy grass, *Cress*.  
 Scutching, *Flax-dressing*.  
 Scutching-machine, *Cotton*, 275.  
 Scutum, *Shield*.  
 Scymnus, *Shark*.  
 Scyros, *Seyro*.  
 Scythia Minor, *Dobrudscha*.  
 Scythian lamb, *Baromets*.  
 Sea-bear, *Otary*.  
 Sea-beet, *Beet*.  
 Sea-blubber, *Acalepha*.  
 Sea-buckthorn, *Buckthorn*, *Sallow-thorn*.  
 Sea-calf, *Seal*.  
 Sea-cat, *Wolf-fish*.  
 Sea-centipedes, *Annelida*.  
 Sea-cow, *Manatee*.  
 Sea-crayfish, *Lobster*.  
 Sea-cucumber, *Bêche-de-mer*.  
 Sea-devil, *Angler*.  
 Sea-eagle, *Eru*.  
 Sea-eggs, *Echinida*.  
 Sea-fan, *Gorgonia*.  
 Sea-ford Bay, *Sussex*.  
 Sea-forth (L.), *Lewis-with-Harris*.  
 Sea-grapes, *Cuttle Fish*.  
 Sea-hare, *Tectibranchiata*.  
 Sea-holly, *Eryngo*.  
 Sea-horse, *Hippocampus*.  
 Sea-horse, *Morse*.  
 Sea Island cotton, *Cotton*, 267.  
 Sealed earth, *Lemnian Earth*.  
 Sea-lemons, *Doris*.  
 Sea-leopard, *Seal*.  
 Sea-loach, *Rockling*.  
 Sea-louse, *Fish-louse*, 356.  
 Sea lyme-grass, upright, *Ice-land*, 505.  
 Seamen, *Merchant Shipping Act* (Supp.).  
 Sea-mew, *Gull*.  
 Sea-milkwort, *Glaux*.  
 Sea-nettles, *Acalepha*.  
 Sea-pen, *Pennatula*.  
 Sea-pie, *Oyster-catcher*.  
 Sea-purses, *Shark*.  
 Search, Edward, *Tucker*.  
 Sea-reed, *Ammophila*.  
 Sea-rush, *Pennatula*.  
 Sea-scorpion, *Cottus*.  
 Sea-serpent, *Cymetrus*.  
 Sea-side balsam, *Cascarilla*.  
 Sea-side beech, *Caribbee Bark*.  
 Sea-snail, *Sucking Fish*.  
 Sea-trout, *Salmon*, 448.  
 Sea-unicorn, *Narwhal*.  
 Sea-ware, *Wrack*.  
 Sea-worms, *Annelida*.  
 Seb, *Egypt*, 787.  
 Sebaceous glands, *Skin*, 756.  
 Sebak, *Egypt*, 787.  
 Sebaste, *Samaria*.  
 Sebastes, *Beryll*.  
 Sebeknefru, *Egypt*, 789.  
 Sebesten plum, *Cordiacæ*.  
 Secollati (r.), *Uruguay*.  
 Seboua, *Wady*, *Nubia*.  
 Sebestieh, *Samaria*.  
 Secchia, *Po*.  
 Secession to the Sacred Hill, *Rome*, 312.  
 Secondaries, *Birds*, 108.  
 Secretiveness, *Phrenology*, 514.  
 Secular canons, *Regular Canons*.  
 Sedges, *Cyperacæ*.  
 Seebeck, *Thermo-electricity*.  
 Seebungee, *Ganges*, 614.  
 Seend, *Wiltshire*.  
 Seengoor, *Sumna*.  
 Seer (r.), *Gall*, 51.  
 Seftians, *Mohammedan Sects* (Supp.).  
 Seifton fancy, *Ramshik*.  
 Segarelli, Gerard, *Apostolic Brethren*.  
 Segnia, *Zengy*.  
 Segontium, *Caernarvon*.  
 Segovia, *Nicaragua*.  
 Segré, *Maine-et-Loire*.  
 Segré (r.), *Pyrenæus Orientales*.  
 Sehi, *Anthology*, 289.  
 Seille (r.), *Moselle*.  
 Seim (r.), *Derna*.  
 Seirah (L.), *Timor-laut*.  
 Selache, *Shark*.  
 Selachii, *Cartilaginous Fishes*.  
 Selenga, *Baikal*.  
 Self-baptisers, *Raskolnik*.  
 Self-ordinars, *Raskolnik*.  
 Selkirk, Earl of, *Red River Settlement*.  
 Selkirk, Earls of, *Hamilton Family*, 213.  
 Sellé (r.), *Lot*.  
 Selma (town), *Alabama*.  
 Selmas (town), *Aserbajan*.  
 Seltzogene, *Atrated Waters*.  
 Selu (L.), *Timor-laut*.  
 Selune (r.), *Manche*.  
 Selvas, *Silvas*.  
 Semaway (L.), *Sumatra*.  
 Semée, *Powdered*.  
 Sempal, *Courland*.  
 Semi-Saxon, *English Lang*, 64.  
 Semmes, Raphael, *Alabama* (Supp.), (Supp.).  
 Semola, *Macaroni*.  
 Semoun, *Sinoom*.  
 Sempronie, *Simplan*.  
 Sempronian Law, *Agrarian Law*.  
 Semur, *Côte-d'Or*.  
 Sena-Gallia, *Sinagopia*.  
 Senaji, *Persian Lang* & *Lit*, 427.  
 Senatus Academicus, *University*, 663.  
 Senayi, *Persian Lang* & *Lit*, 427.  
 Sendre (r.), *Charente-Inférieure*.  
 Seneferu, *Egypt*, 788.  
 Senior Optime, *Wrangler*.  
 Senj, *Zengy*.  
 Senkovski, *Russian Lang* & *Lit*.  
 Senna, *Rio de*, *Sofala*.  
 Senné (r.), *Brussels*.  
 Sense-capsules, *Skeleton*, 750.  
 Sentiments, *Phrenology*, 517.  
 Sentis (mt.), *Appenzell*.  
 Sepistan, *Sebesten*.  
 Sepphoris, *Galilee*.  
 Septinsular Republic, *Ionian Islands*.  
 Sequana (r.), *Seine*.  
 Sequillo, *Medina* (Supp.).  
 Seraing, (Supp.).  
 Serapeton, *Alexandria*, *Alexandrian Library*.  
 Serbal (mt.), *Sinai*.  
 Serbs, *Servia*, 630.  
 Serchio, *Lucca*.  
 Serendib, *Ceylon*.  
 Sergio (mt.), *Ragus*.  
 Seriboe (r.), *Bornuo*.  
 Serio (r.), *Bergamo*.  
 Seriphos, *Greece*, 85.  
 Serjania, *Supple Jack* (Supp.).  
 Sermione, *Garra*, *Lago di*.  
 Sermoeyr, *Chizrovi*.  
 Seromyctic sarcoma, *Adenocèle* (Supp.).  
 Serous diathesis, *Scrophula*.  
 Serpent, *Pyrotechny*.  
 Serpent-eater, *Secretary*.  
 Serpent's Mouth, *Trinidad*.  
 Serpent-worship, *Ophites*, *Totems* (Supp.).  
 Serra da Junto, *Portugal*.  
 Serra de Calderão, *Portugal*.  
 Serra de Estrella, *Portugal*.  
 Serra de Monchique, *Portugal*.  
 Serrassalmo piraya, *Portugal*.  
 Serrère (mt.), *Aridge*.  
 Serriere (r.), *New-Chatel*.  
 Sertularia, (Supp.).  
 Serum præparatum, *Suet*.  
 Servant, *Master and Servant* (Supp.).  
 Service-berry, *Beam-tree*.  
 Services, *Retours of Records*, *Public*.  
 Setia (r.), *Alps*.  
 Sequatchie (r.), *Tennessee*.  
 Sessile, *Flower*, *Leaves*.  
 Sestius, *Dardanelles*.  
 Sesuvium, *Tetragoniacæ*.  
 Set, *Egypt*, 787.  
 Setines, *Athens*, 517.  
 Set-off, *Offset*.  
 Setroonjee, *Cambay*.  
 Seulle (r.), *Calvados*.  
 Sevan (L.), *Armenia*.  
 Sevang, *Goukcha*, *Lake of*.  
 Sevastopol, *Sebastopol*.  
 Seven-day fever, *Relapsing Fever*.  
 Severians, *Monophysites*.  
 Severak, *Russia*, 384.  
 Sèvre-Nantaise (r.), *Nantes*.  
 Sèvre-Niortaise (r.), *Charente-Inférieure*.  
 Sewage Act, *Sanitary Science* (Supp.), 723.  
 Sewage earth-closet, (Supp.).  
 Sewalik (mts.), *India*, 537.  
 Sewen, *Bull Trout*.  
 Seyf-ud-deen, *Ghuri*.  
 Seyon (r.), *New-Chatel*.  
 Shachovski, *Russian Lang* & *Lit*.  
 Shaden, *Siluride*.  
 Shadoof, *Agriculture*.  
 Shahabad, *Oude*.  
 Shahjehanabad, *Delhi*.  
 Shahjehanpore, (Supp.).  
 Shahpur (city), *Pars*.  
 Shahpur I. and II. *Sassanide*.  
 Shah Sujah, *Afghanistan*.  
 Shahzadpore, *Alahabad*.  
 Shakers, (Supp.).  
 Shakspeare Society, *Roxburgh Club*.  
 Shaloo, *Durra*.  
 Sham, *Umbellifera*.  
 Shambles, *Portland Island*.  
 Shamil, *Suzsm*.  
 Shanavests, *Whiteboy*.  
 Shanfara, *Arabian Lang* & *Lit*, 347.  
 Shangalla, *Abyssinia*.  
 Shang-pe-shan, *Corea*.  
 Shang-tung, *China*, 817.  
 Shanklin, *Wight*, *Ile of*.  
 Shans, *Texaserin*.  
 Shapinsha, *Pomona*.  
 Shard-born beetle, *Dung Beetle*.  
 Share, *Plough*.  
 Share-broker, *Stock-broker* (Supp.).  
 Sharp, Granville, *Slavery*.  
 Sharps, *Wheat*, 157.  
 Shary (r.), *Bornuo*.  
 Shashank I., *Egypt*, 790.  
 Shasta, *California*.  
 Shaston, *Shafesbury*.  
 Shawanese salad, *Hydrophyllacæ*.  
 Shayook (r.), *Khafaloun* (Supp.).  
 Shea butter, *Bassia*.  
 Sheaf (r.), *Sheffield*.  
 Shearing strain, *Strength of Materials*, 163.  
 Sheat-fish, *Siluride*.  
 Sheba, *Queen of*, *Ethiopia*.  
 Sheben, *Sabbathais Zeit*.  
 Shechem, *Nabulus*.  
 Shedder, *Salmon*, 446.  
 Shediac, *New Brunswick*.  
 Sheep antelope, *Goat*, *Rocky Mountain*.  
 Sheep-dog, *Shepherd's Dog*.  
 Sheep-drains, *Waste Lands*.  
 Sheep's bone, *Hydrocotyle*.  
 Shehr, *Yemen*.  
 Sheikh-al-jibal, *Assassin*.  
 Sheikh-ul-islam, *Turkey*, 587.  
 Shekel, *Numeriatrics*, 2.  
 Sheksna (r.), *Billo-Overo*.  
 Shell (r.), *Algeria*, 138.  
 Shelton, *Hawley* (Supp.).  
 Shen-ae, *China*, 817.  
 Shepherd Kings, *Hykthos*.  
 Shepherd's needle, *Chervil*.  
 Sherif E. A. Vezdi, *Persian Lang* & *Lit*, 428.  
 Sheridon, *Cheribon*.  
 Sheridan, General, *Richmond*.  
 Sherwin, *Engraving*, 68.  
 Shetland, *temperature of*, *Great Britain*, 65.  
 Sheyga, *Nubia*.  
 Shieldrake, *Skelldrake*.  
 Shikarpur, *Desert of*, *Sinde*.  
 Shikatze, *Yikadaw* (Supp.).  
 Shilla, *Chaffinch*.  
 Shillalah (town), *Wicklow*.  
 Shillbeer, *Omnibus*.  
 Shillba, *Nile*.  
 Shin (r.), *Sutherland*.  
 Shinar, *Babylonia*.  
 Shing-king, *Manchuria*.  
 Shingies (disease), (Supp.).  
 Shingling, *Iron*, 636.  
 Ship-barrow, *Sepulchral Mound*.  
 Ship-broker, (Supp.).  
 Shipping, *Merchant Shipping Act* (Supp.).  
 Shire-gemot, *Gemote*.  
 Shire-reeve, *Reeve*.  
 Shirvan, *Kurdistan*.  
 Shisdra, (Supp.).  
 Shivers, *Brash*.  
 Shoalhaven, *New S. Wales*.  
 Shoay Dagon, *Rangoon*.  
 Shooting-stars, *Aerolites*, *Meteors* (Supp.).  
 Shoots, *Mining*.  
 Shores, *Launch*.  
 Shortbread, *Bread*, 319.  
 Short fever, *Relapsing Fever*.  
 Shorthorn breed, *Ox*.  
 Shot of grease, *Weed*.  
 Shot silk, *Taffety*.  
 Shouas, *Bornuo*.  
 Shoulder-blade, *Scapula*.  
 Shrapnel shell, *Cass-shot*.  
 Shrewsbury cakes, *Biscuits*.  
 Shrivng, *Shrove-tide*.  
 Shubenacadie, *Nova Scotia*.  
 Shupayon, *Cashmere*.  
 Shur (plant), *Moonjah*.  
 Shushan, *Susa*.  
 Siak, *Rionu*.  
 Siak (r.), *Sumatra*.  
 Sialia, *Blue Bird*.  
 Stamang, *Gibbon*.  
 Sias (r.), *Ladoga*.  
 Sibbens, *Yauu*.  
 Siberian stone pine, *Cedar*.  
 Sibylline Books, *Sibyl*.  
 Sicambria, *Alt-Ofen* (Supp.).  
 Sicca, *Namidia*.  
 Sicheu, *Nabulus*.  
 Sicinos, *Greece*, 85.  
 Sickle, *Reaping*.  
 Sid (r.), *Sidamout*.  
 Siddhartha, *Buddhism*, 403.  
 Sideral day, *Day*.  
 Siderolites, *Meteors* (Supp.).  
 Side-saddle flower, *Sarracenia*.  
 Sidé-Rached, *Oasis of*, *Algeria*, 142.  
 Sidon, *Phanicia*, 491.  
 Sidra, *Gulf of*, *Syrris*, *Tripoli*.  
 Siebold, *Tapeworm*, 294.  
 Sierra Anambahy, *Paraguay*, 257.  
 Sierra de Holucar, *Alpujarras*.  
 Sierra de Perija, *Venezuela*.  
 Sierra Maracaju, *Paraguay*, 257.  
 Sierra Nevada de Merida, *Venezuela*.  
 Sierra Seca, *Segura*.  
 Sierra Tejada, *Velez-Malaga*.  
 Sieve (r.), *Arno*.  
 Sivero Vostochmii, *Siberia*, 702.  
 Siffleur, *Widgeon*.  
 Sigmaringen, *Hohensollern*.  
 Sigmoid flexure, *Alimentary Canal*.  
 Signorelli, Luca, *Painting*, 192.  
 Sigogne, *Sattre*.  
 Sigutna (town), *Maclar Lake*.  
 Sigh (r.), *Schwyz*, *Zürich*.  
 Sihan, *Amorites*.  
 Sihar, *Nile*.  
 Sikok, or Sikop, *Japan*.  
 Sil (r.), *Galicia*, *Spain*.  
 Silberberg, *Frankenstein*.  
 Silenus venter, *Wanderer*.  
 Silix, *Silicon*.  
 Silhouette (L.), *Seychelles Is.*  
 Silicic acid, *Silicon*.  
 Silicule, *Silique*.  
 Siljan (L.), *Sweden*, 236.  
 Silk vegetable, *Silk-cotton*.  
 Silk-worm rot, *Botrytis*.  
 Sill (r.), *Bromer Pass* (Supp.).  
 Sillocks, *Coal-fish*.

- Swäbisch-Hall, *Hall*.  
Swainson, *Entomology, Ornithology*.  
Swakop, *Ovampes*.  
Swammerdam, Jan. (*Supp.*)  
Swamp oak, *Gasparina*.  
Swan River Settlement, *Western Australia*.  
Swatow, (*Supp.*)  
Sweating, *Beer, 807*.  
Sweet calabash, *Granadilla*.  
Sweet cane, *Calamus Aromaticus*.  
Sweet gale, *Candlberry*.  
Sweet juca, *Manioc*.  
Sweet locust, *Honey Locust Tree*.  
Sweet milk vetch, *Astragalus*.  
Sweet sultan, *Centaurea*.  
Sweet virgin's bower, *Clematis*.  
Sweet water grass, *Catabrosa*.  
Sweet woods, decoction of, *Sarsaparilla*.  
Swenta (*r.*), *Vikomir*.  
Sweyn or Swein, *Canule*.  
Swiatowitz, *Slaves*.  
Swift, *Silk & Silkworm, 726*.  
Swimming-bladder, *Air-bladder*.  
Swine (*r.*), *Pomerania*.  
Swinestone, *Stinkstone*.  
Swinge, *Hanoover*.  
Swing-flying bridge, *Bridge, Military*.  
Swiss tea, *Achillea*.  
Switzerland, Austrian, *Salshammergut*.  
Switzerland, education in, *National Education (Supplement)*.  
Syahee Rao, *Guicowar (Supp.)*.  
Syboes, *Onion*.  
Sychur, *Nabulna*.  
Sydney, *Cape Breton*.  
Sydney, Algeron, *Sidney*.  
Sylvia, *Chiff-chaff (Supp.)*.  
Sylvic acid, *Rosin*.  
Symbolism, *Writing*.  
Syme, James, (*Supp.*)  
Symmetry, *Rhythm*.  
Symonds, Rodolph, *Elizabethan Architecture*.  
Sympheia, *Willet*.  
Symphoria or Symphoricarpus, *Snowberry*.  
Symplegades, *Argonauts*.  
Synarthrosis, *Joints*.  
Syndesmology, *Anatomy, 227*.  
Synodites, *Canobites*.  
Synthesis, *Alcohols (Supp.)*.  
Synthetic method, *Analysis*.  
Syriam, *Bengal, Bay of*.  
Syrian rue, *Peganum (Supp.)*.  
Syriax, *Riddle*.  
Syros, *Greece, 85*.  
Szakolcza, *Skalitz*.  
Szamos (*r.*), *Thetis*.  
Szarvas, (*Supp.*)  
Szeklers or Szekhelyi, *Transylvania*.  
Szeksna (*r.*), *Nogovorod*.  
Szobozszo, *Haiducks (Supp.)*
- Taag, *Sunn*.  
Taas, *Yemen*.  
Tab, *Fars*.  
Tabah, *Medina*.  
Tabari, *Arabian Lang. & Lit. 347*.  
Tabaris, *Bamboo*.  
Tabeniow, *Banjermannis*.  
Tablature, *Lute (Supp.)*.  
Table Mt. *Sierra Nevada*.  
Table d'hote, *Hotel, 437*.  
Tabriz, Lake of, *Urumiyah (L.)*.  
Tabujong (*r.*), *Sumatra*.  
Tabur stycke, *Falconry, 227*.  
Taccap, *Capes*.  
Tacht-i-Suliman, *Suliman Mountains*.  
Tactus, *Ammianus, Marcelinus*.  
Tackle, *Block, Pulley*.  
Tacroary, *Paraguay River*.  
Tacon, *Claude, St.*.  
Tadla, *Tafsa*.
- Taff (*r.*), *Bristol Channel, Carmarthen, Glamorgansh.*  
Taflelet, *Morocco*.  
Tagal, *Java (Supp.), 580*.  
Tagherain, *Atlas Mts.*  
Taghmon, *Wexford*.  
Tagliamento (*r.*), *Alps, Austria*.  
Tahaa, *Coral Is.*  
Taher, *Calif.*  
Taherites, *Persia, 422*.  
Tahiti apple, *Hog Plum*.  
Taic language, *Turanian Languages*.  
Taida, *Calcutta*.  
Tai-hu, *China, 815*.  
Taisch, *Second Sight*.  
Tai-Yuan, (*Supp.*)  
Taj-al-Tuarikh, *Saad-ed-din*.  
Tajiks, *Turkestan, 584*.  
Tajulla (*r.*), *Brikuaga*.  
Takas, *Nubia*.  
Takazze, *Nile*.  
Tai-kiang (*r.*), *Yang-tso-kiang*.  
Takinos (*L.*), *Cranvoges*.  
Takkatu (*mt.*), *Beloochistan*.  
Takkatie (*r.*), *Abyssinia*.  
Taktvins, *Mohammedanism*.  
Talcabano, *Chili, Concepcion*.  
Tale of a Tub, *Swift*.  
Talha, *Mimosa*.  
Talicotian operation, *Rhinoplastic Operation*.  
Talesin, *Welsh Lang. & Lit. 135*.  
Tallaker, *Shye*.  
Tallahatchie (*r.*), *Yazoo*.  
Tallies in Exchequer, *Records, Public*.  
Tallow, *Waterford*.  
Tamanua, *Ant-eater*.  
Tamandua (*L.*), *Shirwa*.  
Tamar, *Devonshire*.  
Tamaricaceae, *Tamarisk*.  
Tamarind plum, *Tamarind*.  
Tambilan (*is.*), *Rionu*.  
Tambo (*r.*), *Ucayali (Supp.)*.  
Tambookie, *Tembu*.  
Tambora (*mt.*), *Sumbawa*.  
Tame (*r.*), *Birmingham*.  
Tamega (*r.*), *Amarant (Supp.)*.  
Tamas, *Squirrel*.  
Tamil, *Ceylon, 738*.  
Tamina, *Gall, St.*.  
Tanacetum, *Tansy*.  
Tanais, *Don*.  
Tananasia, *Savoy*.  
Tanaquil, *Tarquinius*.  
Tanaoro, *Cherasco, Po*.  
Tanera, *Summer Islands*.  
Tangent sailing, *Great Circle Sailing*.  
Tangleberry, *Whortleberry*.  
Tangau *Ula (mts.) Altai Mountains (Supp.)*.  
Tania, *Egypt, 789*.  
Taniat stone, *Standing Stones*.  
Tanjong Putri, *New Johore*.  
Tanna, *New Hebrides*.  
Tanrec, *Tenrec*.  
Tantallon Castle, *Haddingtonshire*.  
Taotl, *Mexico, 434*.  
Taom, *Laon-tse*.  
Tapanuli, *Sumatra*.  
Tapaos, *Phalanger*.  
Tapoa tafa, *Phacogale*.  
Tappan Zee, *Hudson, Tarrytown*.  
Taproban, *Ceylon*.  
Tapu, *Tabu*.  
Tapuar, *Coxim*.  
Tara, *Meath*.  
Tarabosan, *Anatolia, 227*.  
Taragur (*mt.*), *Ajmeer*.  
Taranka, *Sakalin*.  
Tarandus, *Reindeer*.  
Taranis, *Thor*.  
Tarapia, *Therapsia*.  
Tarbert, *Argyleshire*.  
Tardouere (*r.*), *Charente*.  
Tarentina, *Tarantism*.  
Tarentum, *Rome, 314*.  
Tarichaea, *Galilee*.  
Taria, *Bolivia*.
- Taro (*r.*), *Pos, 424*.  
Tarpun, *Horas, 424*.  
Tarquinii, *Carneto*.  
Tarraco, *Tarragona*.  
Tarsal spur, *Birds, 109*.  
Tarsu, *Tarsus*.  
Tarsus, *Birds, 108*.  
Tarsus, *Phanicia, 492*.  
Tartaglia, *Algebra*.  
Tartar bread, *Cramb.*  
Tartar emetic, *Tartaric Acid, 304*.  
Tartarian lamb, *Barometz*.  
Tartaro (*r.*), *Villafranca*.  
Tartessus, *Andalusia, Tarshish*.  
Tarturated iron, *Tartaric Acid, 304*.  
Tar Vale, *Clogheen*.  
Tasmanian devil, *Tasmania, 307*.  
Tasman's Peninsula, *Tasmania, 306*.  
Tasteless purging salt, *Sodium, 802*.  
Tatars, *Tartars*.  
Tate, Zouch, *Self-denying Ordinance*.  
Tatishshev, *Russian Lang. & Lit.*  
Tatler, *Addison*.  
Tatra (*mts.*), *Austria, Carpathian Mountains*.  
Tauber (*r.*), *Bavaria, Wurtemberg*.  
Taupo (*L.*), *N. Zealand, 741*.  
Tauranga Bay, *N. Zealand, 741*.  
Taurica, *Kertch*.  
Tauris, *Tauris*.  
Taut, *Thoth*.  
Tave, *Caermarthenshire*.  
Tavignano, *Corsica*.  
Tavira, (*Supp.*)  
Taviuni, *Fiji Islands*.  
Tavola, *Corsica*.  
Tavy, *Dartmoor*.  
Taw (*r.*), *Dartmoor, Devonsh. Brecknockshire, Glamorganshire*.  
Tawing, *Leather*.  
Taxaces and taxus, *Yew*.  
Taxila, *Attock, Indus*.  
Taxology, *Botany, 264*.  
Taxonomy, *Botany, 264*.  
Taylors of Norwich, *Austin, Mrs (Supp.)*.  
Tchadda (*r.*), *Benud*.  
Tchadir Dagh (*mts.*), *Alina, Crimea*.  
Tchany (*L.*), *Siberia, 702*.  
Tchar-dagh, *Balkan*.  
Tcherikas, (*Supp.*)  
Tchernaya (*r.*), *Sebastopol*.  
Tchernigof, *Russia, 384*.  
Tchernomorsk, *Cossacks*.  
Tehoras, *Kalmucks*.  
Tehutchis, *Siberia, 703*.  
Tehulum, *Ob*.  
Tehuruksd, *Trebisond*.  
Tehuvashes, *Russia, 381*.  
Tea, *New Jersey, Red Root*.  
Tea-cucumber, *Holothuria*.  
Teaser, *Woolen & Worsted Manufacturers, 265*.  
Tea-tree, *Leptospermum*.  
Tebu, *Air*.  
Technical education, (*Supp.*)  
Tecomia, *Trumpet-flower*.  
Tecumseh, *U.S. 656*.  
Teddington-machine, *Hay*.  
Tedla, *Tefsa*.  
Tee, *Curling*.  
Teetotal, *Temperance, 348*.  
Tef, *Egypt, 788*.  
Tegbahadar, *Sikka*.  
Teges, *Arcadia, Tripolizza*.  
Teguzin, *Monitor*.  
Tehama, *Arabia, 344, Yemen*.  
Tehuantepec (*r.*), *America, 196*.  
Teifu, *Caermarthensh. Cardigansh., Pembrokeh.*  
Teiga (*r.*), *Dartmoor*.  
Teith, *Callander*.  
Tejucigalpa, (*Supp.*)  
Tekedamp, *Algeria, 142*.  
Tekooh, *Bethlehem*.
- Telegraph, *Atlantic*.  
Tel-el-Amarna, *Egypt, 772*.  
Tell-es-Safret, *Galk*.  
Tell-hita, *Capernaum*.  
Tellicherry, (*Supp.*)  
Telma, *Irakut*.  
Telugu, *Tamil*.  
Teme, *Herfordsh. Sworn, Skrophsh., Worcester*.  
Temes (*r.*), *Benud, Danub.*  
Temini, *Arabian Lang. & Lit. 347*.  
Temminck, *Ornithology*.  
Temnodon, *Bushsh (Supp.)*.  
Temor, *Meath*.  
Temsah (*L.*), *Suez (Supp.)*.  
Tenants, removing of, *Exemption of Tenants*.  
Tendo Achilles, *Achilles Tendon*.  
Tendril, *Cirrhous*.  
Tengiz, *Balkash*.  
Tengri-Tagh (*mts.*), *Thien-Shan*.  
Tenimber (*is.*), *Timor-Island*.  
Ten Kate, *Plemish Lang. & Lit.*  
Tenne, *Abstemius, Coln (Aer.)*.  
Tennesse (*is.*), *Mexicola (L.)*.  
Tenochoitlan, *Mexico*.  
Tenos, *Tinos*.  
Tensas (*r.*), *Washita*.  
Tenthredo, *Sawfly*.  
Teos, *Anacron*.  
Tepe Suene (*mts.*), *Mexico*.  
Tepic, (*Supp.*)  
Teplitz, *Bohemia*.  
Tequendam Falls, *Bohemia*.  
Ter (*r.*), *Catalonia*.  
Terai, *Oude*.  
Terrel, *Perregin Falan.*  
Terchloride of Iodine, *Chloroform*.  
Tereb, *Caspian Sea*.  
Terequivalent elements, *Triads*.  
Tergiu, *Moat, Alps*.  
Tergoes, *Caro*.  
Terrioli, *Tyrol*.  
Terribles, *Tyrol*.  
Terro (*r.*), *Boas*.  
Tern (*r.*), *Sworn, Skrophsh.*.  
Ternate, *Loanos*.  
Terney, *Admiral De U.S. 55*.  
Terraces, river, *River Terraces*.  
Terra Firma, *Doria*.  
Terra sigillata, *Lewnia Earth*.  
Terra, *Antarctica*.  
Terricola, *Antarctica*.  
Terror (*mts.*), *Antarctic Ocean*.  
Terror, *Reign of, Reign of Terror*.  
Terry Ales, *Whiskey*.  
Tersus, *Tarsus*.  
Tertiaris, *Birds, 18*.  
Tersul, *Araga*.  
Tertu-terro, *Lepidoptera*.  
Test (*r.*), *Hemiptera*.  
Tessa, *Sand*.  
Testigon, *Antilles*.  
Testimony, *Belief, & Testoon, Nunciamento, & Testudo imbricata, Testudo shell*.  
Teta, *Sofala, Zambezi*.  
Tetrabranchata, *Cephalopoda*.  
Tetrads, *Triads*.  
Tetrapolitan Confession, *Secessionarian*.  
Tetrarhynchida, *Tafnorn, 220*.  
Tetrasore, *Sporo*.  
Tetrathionic acid, *Sulphur, 107*.  
Tetsana, *Duke of, O'Donnell*.  
Tenzarus, *Society Islands*.  
Teucheira, *Cyrrusica*.  
Teverone (*r.*), *Tiber*.  
Teviot (*r.*), *Tweed*.  
Tector, *Wentworth*.  
Teyde, *Pico de, Tenerife*.  
Tez (*r.*), *Atlas Mts. (Supp.)*.  
Thamamians, *Thamamites (Supp.)*.

Thapsus, *batte of, Casar*, 491.  
 Thara Lake, *Cassar*, 491.  
 Tharawady, *Pegu*.  
 Thatta, *Tatta*.  
 Thaumatrope, *Stereoscope*, 117.  
 Thebaid, *Egypt*, 786.  
 Theism, *Deism*.  
 Theodemir, *Theodoric*.  
 Theodices, *Optimism*.  
 Theodora, *Byzantine Emp.* 471.  
 Theodore of Abyssinia, (*Supp.*)  
 Theodorus, *St. Gregory Thaumaturgus*.  
 Theodorus Lascarus, *Byzantine Empire*, 472.  
 Theodosia, *Kaffa*.  
 Theodosians, *Monophysites*.  
 Theodosians, *Rashidit*.  
 Theodosus, *Humanitarians*.  
 Theophaia, *Otho II. of Germany*.  
 Theophilus, *Byzantine Emp.* 471.  
 Thera, *Archipelago, Greece*, 85.  
 Therain, *Cize*.  
 Theresa of Castile, *Alfonso I.*  
 Therman Helvetica, *Baden*.  
 Thermo-dynamics, (*Supp.*)  
 Thermo-electricity, (*Supp.*)  
 Thermo-magnetism, *Thermo-electricity* (*Supp.*)  
 Thetes, *Solon*.  
 Thetia's hair-stone, *Rock crystal*.  
 Thevenot, traveller, *Africa*, 66.  
 Thiaki, *Thaco*.  
 Thian-shan nan-lu, *Turkistan*, 85.  
 Thian-shan pe-lu, *Turkistan*, 85.  
 Thibet, *Tibet*.  
 Thier-epos, *Germany*, 725.  
 Thionville, *Moselle*.  
 Thirty Cities, confederacy of the, *Rome*, 314.  
 Thisebe, *Pyraonius & Thisebe*.  
 Thiva, *Thebes*.  
 Thlaspi, *Shepherd's Purse*.  
 Thodas & Thodawura, *Todars*.  
 Thomas I. *Savoy, House of*  
 Thomson Collection, *British Museum*, 359.  
 Thomastown, *Kilkenny*.  
 Thomond, *Clare, Limerick*.  
 Thompson (r.), *Fraser River*.  
 Thomson (r.), *Victoria*, 785.  
 Thomson, Professor W. *Sun, Telegraph*, 337, 339.  
 Thonlounides, dynasty of, *Egypt*, 701.  
 Thonon, *Savoy*.  
 Thoriamund, *Attila*.  
 Thorn acacia, *Locust Tree, Robinia*.  
 Thorney, *Cambridgehire*.  
 Thornhill, Sir James, *Painting*, 195.  
 'Thorough,' *Stafford*.  
 Thorpe, John, *Elizabethan Architecture*.  
 Thorshälla, *Maelar Lake*.  
 Thorshavn, *Farøe Isles*.  
 Thothmes, *Egypt*, 789.  
 Thoumart, *Polecat*.  
 Thourout, (*Supp.*)  
 Thouvenin, *Col. Rifled Arms*.  
 Thrasamund, *Vandals*.  
 Thrax, Dionysius, *Grammar*.  
 Three Chapters, *Theodore*.  
 Three Kings' Reef, *Cromarty Firth*.  
 'Three Sisters,' *Barrow*.  
 Thresher, *Fox Shark*.  
 Threshers, *Ribbonism*.  
 Thrombus, *Venesection*.  
 Throstle, *Thrush*.  
 Throwing, *Silk & Silkworm*, 726.  
 Throw-stick, *Wild-fowl*.  
 Thsin-ling Mts. *China*, 815.  
 Thunder-stones, *Belemnites, Elf Arrow-heads*.  
 Thur (r.), *Gall, St. Canton of Rhine*.  
 Thur, *Sinde*.  
 Thurbile, *Censer, Thurifer*.

Thyatura, *Ab-Hissar* (*Supp.*)  
 Thymallus, *Grayling*.  
 Thynnus, *Tunny*.  
 Tia-Huanacu, *Peru*, 438.  
 Tiber-stone, *Limestone*.  
 Tibia, *Foot*, 409.  
 Tibur, *Rome*, 308, *Tivoli*.  
 Ticinum, *Pavia*.  
 Ticusus, battle of the, *Scipio, P. C.*  
 Tick, sheep, *Sheep-louse*.  
 Tidone, *Moluccas*.  
 Tie, *Siar*.  
 Tierras Calientes, *Mexico*.  
 Tierras Frias, *Mexico*.  
 Tierras Templadas, *Mexico*.  
 Tiers-shot, *Grape-shot*.  
 Tiete (r.), *Parana River, Its* (*Supp.*)  
 Tiger-cat fur, *Serval*.  
 Tigerhach, *Ireland*, 627.  
 Tiger-wolf, *Hyana*.  
 Tigre, *Abyssinia*.  
 Tigridia, *Tiger-flower*.  
 Tiquin (r.), *Cabatuan*.  
 Tikitch (r.), *Zoenigorodka*.  
 Tilbury, *Coach*.  
 Tilstones, *Old Red Sandstone*.  
 Tilt (r.), *Wesidan Formation*.  
 Tilt (r.), *Northumberland*.  
 Tilt (r.), *Northumberland*.  
 Tillicoultry, (*Supp.*)  
 Tilon, *Cranage*.  
 Tilt (r.), *Blair Athol*.  
 Til-wool, *Oranographus*.  
 Timanthes, *Painting*, 191.  
 Timbi, *Niger*.  
 Timby, *Theo. R. Turret-ship*.  
 Time, *Space & Time*.  
 Timok (r.), *Servia*, 629.  
 Timon, *Borria*.  
 Timor, *Porphyra*.  
 Tinea, *Trench*.  
 Tincal, *Borax*.  
 Tineh, *Pelusium*.  
 Tin-foil, *Foil, Tin*, 447.  
 Ting, *Hean*.  
 Ting-hai, *Chusan*.  
 Tingis, *Bug*.  
 Tingitana, *Atlas Mountains*.  
 Tinker, *Shate*.  
 Tinnevely, (*Supp.*)  
 Tinstone, *Tin*, 448.  
 Tintock (mt.), *Lanarkshire*.  
 Tio-cen-koak, *Corra*.  
 Tioga (r.), *Susquehanna*.  
 Tirailleurs, *Chasseurs de Vincennes*.  
 Tirailleurs d'Afrique, *Algeria*, 141.  
 Tiran, *Strait of, Red Sea*.  
 Tir Enna, *Adamnan* (*Supp.*)  
 Tirowli, *Azimabad* (*Supp.*)  
 Tiring, *Quarry*.  
 Tiro de Molina, *Telles*.  
 Tirun, *Borno*.  
 Tisaphernes, *Alcibiades*.  
 Tissue, areolar, reticular, &c. *Cellular Tissue*.  
 Titeri, *Algeria*, 141.  
 Titisee, *Baden*.  
 Titulars, *Erection, Lords of*.  
 Titusville, *Oil-wells* (*Supp.*)  
 Tiza, *Hayeside*.  
 Tiziano, *Titian*.  
 Tlos, *Lycia*.  
 Tmolus, *Lydia, Pactolus*.  
 Toa, *Casnarina*.  
 Tobacco-pipe fish, (*Supp.*)  
 Tobacco-root, *Lewisia*.  
 Tobercurry, *Sligo*.  
 Toibons, *Apocrypha*.  
 Tobol (r.), *Tobolsk*.  
 Tockenburg, *Toggenburg*.  
 Toddy, *Cocca-nut, Date Palm*.  
 Todd, *Tiber*.  
 Töddberg, *Glarus*.  
 Todmorden, (*Supp.*)  
 Togrul Beg, *Seljuks*.  
 Tokhani, *Albania*.  
 Tökely, *Tekeli*.  
 Tokology, *Midwifery*.  
 Tokmehes Khan, *Timur*.  
 Tolima, *Pic de, Andes*, 239.  
 Toli Menastir, *Monastir*.

Toltees, *Mexico*.  
 Tom (r.), *Ob. Tomik*.  
 Tomantoul, *Banffshire*.  
 Tombenhorn, *Splügen*.  
 Tombigbee (r.), *Alabama*.  
 Tomi, *Oichakow*.  
 Tompion, *Organ*, 111.  
 Tone (r.), *Taunton*.  
 Tongariro, *New Zealand*.  
 Tonge (r.), *Farnworth* (*Supp.*)  
 Tongheni, *Turkistan*, 585.  
 Tonghoo, *Pegu*.  
 Tonka (r.), *N'Ghami Lake*.  
 Tons (r.), *Ganges*, 614.  
 Toongroo, *Dhoorcalor*.  
 Toowoomber, *Queensland*.  
 Topaz, gold, *Rock-crystal*.  
 Topeka, *Kansas*.  
 Topical style, *Calico Printing*, 513.  
 Topmamburi, *Jerusalem Architecture*.  
 Top-timbers, *Shipbuilding*, 683.  
 Torch thistles, *Cactae*.  
 Torden, *Thor*.  
 Tordina (r.), *Terramo*.  
 Torgoch, *Charr*.  
 Torgoch, *Kalmuck*.  
 Tor Hill, *Glastonbury*.  
 Toro (mt.), *Minnesota*.  
 Toroclen, *Transylvania*.  
 Torregiano, *Sculpture*, 577.  
 Torrens (l.), *Australian Exploration* (*Supp.*), 411.  
 Torrens (r.), *Adelaide, Australia*.  
 Torridalself, *Christiansand*.  
 Torridge, *Bristol Channel, Devonshire*.  
 Torsion, *Strength of Materials*, 163.  
 Tortillé, *Wreathd.*  
 Tortoise beetle, (*Supp.*)  
 Tortuga, *Haiti*.  
 Tourvars, *Neilgherry Mts*.  
 Tory, *Whig & Tory*.  
 Tory Isle, *Donegal*.  
 Tosa Falls, *Donno d'Ossola*.  
 Töss (r.), *Rhine, Zürich*.  
 Total abstinence societies, *Temperance*, 348.  
 Totanus, *Green-shank* (*Supp.*), *Sandpiper*.  
 Totarra, *Podocarpus*.  
 Totem, (*Supp.*)  
 Touched patent or bill, *Bill of Health*.  
 Touch-me-not, *Balsam*.  
 Touchwood, *Amadou*.  
 Touques, *Calvados*.  
 Toura (r.), *Tobolsk*.  
 Touraco, *Hoasin* (*Supp.*), *Plantain-eater*.  
 Tournil, *Menquite* (*Supp.*)  
 Touse, *Fumna*.  
 Toweym, *Wahabis*, 41.  
 Towton, battle of, *Warwick, Earl of, Yorkshire*.  
 Towy, *Bristol Channel, Caermarthen*.  
 Toxotes jaculator, *Archer-fish*.  
 Toys, chemical, *Chemical Toys* (*Supp.*)  
 Toys, steel, *Steel Toys*.  
 Trachearia, *Arachnida*.  
 Trachinus, *Weever*.  
 Traction, coefficient of, *Friction*, 519.  
 Tract Society, *Religious, Religious Tract Society*.  
 Trades' unions, (*Supp.*)  
 Traeth Mawr, *Merioneth*.  
 Tragopogon, *Salsify*.  
 Tragus, *Ear*, 730.  
 Trail-flying bridge, *Bridge, Military*.  
 Trajectum ad Mosam, *Maastricht*.  
 Trajectum ad Rhenun, *Utrecht*.  
 Tralee Bay, *Kerry*.  
 Tralles, *Aidin*.  
 Tram, *Silk & Silkworm*, 724.  
 Tramore, *Waterford*.

Transubstantiation, *Catholic, Infinitesimal*.  
 Transpiration, *Gases*, 642.  
 Trapassi, *Metastasio*.  
 Trapeza Prothesis, *Credence*.  
 Trapezus, *Tribsonid*.  
 Traquair, *Earls of, Stewart Family*, 126.  
 Trastevere, *Rome*, 323.  
 Trauensee, *Gmunden* (*Supp.*)  
 Traum (l. and r.), *Salikam-nurgut*.  
 Traveller's joy, *Clematis*.  
 Traverser table, *Sailings*.  
 Treacle mustard, *Erysimum*.  
 Trebbia, battle of the, *Swoorof*.  
 Trebisonid, date of, *Date Plum*.  
 Trebitz Heights, *Prussia*.  
 Tree lilies, *Vellonia*.  
 Trefoil, *Clover*.  
 Trefriw, *Conway*.  
 Tregaron, *Cardiganshire*.  
 Trehalose, *Sugar*, 187.  
 Trelow Vouni, *Hymettus*.  
 Tremadoc, *Caermarthonshire*.  
 Tremando, *Tremolo*.  
 Tremont, *Boston*.  
 Trente-et-quarante, *Rouge-et-Noir*.  
 Trente-un, *Rouge-et-Noir*.  
 Trenton, *Scilly Islands*, 202.  
 Treaco, *Scilly Islands*.  
 Tresham, *Gunpowder Plot*.  
 Treastle-bridge, *Bridge, Military*.  
 Treu, *Tare & Treu*.  
 Treveryn, *Dea*.  
 Treveithick, *Richard, Railway*, 85.  
 Triads, *Welsh Lang. & Lit.*, 126.  
 Triballi, *Servia*, 630.  
 Tributary, *River*.  
 Tributers, *Mining*.  
 Trichas Marylandica, *Yellowthroat*.  
 Trichiuris, *Hair-tail*.  
 Trichosis, *Ringworm*.  
 Tricophyton, *Parasitic Diseases, Tinea*.  
 Trident, *Trent*.  
 Trieux, *Côtes-du-Nord*.  
 Trifle, *Peasier*.  
 Trigone, *Bladder*.  
 Trimabor Trimah (r.), *Shelum*.  
 Trimelone, *Garda, Lago di*.  
 Tring, (*Supp.*)  
 Tringa, *Knot* (*Supp.*)  
 Trinitrophenic, *Phenyl*.  
 Trinity Term, *Terms*.  
 Trionbantes, *Essax*.  
 Triodia pugnans, *Australian Experiments* (*Supp.*), 410.  
 Triostem perfoliatum, *Tinker's Root*.  
 Triphæna, *Surface Grub*.  
 Trippinate, *Leaves*.  
 Triplet, *Rhime*.  
 Tripes, *Wrangler*.  
 Triptolomea, *Rosewood*.  
 Trismus, *Tetanus*.  
 Tristomida, *Trematoda*.  
 Triternate, *Leaves*.  
 Tritrichionacid, *Sulphur*, 199.  
 Trogen, *Appenzell*.  
 Troglodytes, *Wren*.  
 Trogosita, *Cadelle*.  
 Troitzko-Savsk, *Irkutsk*.  
 Trojans, *Troy*.  
 Trohätten, *Sweden*, 236.  
 Trombay, *Bombay I.*  
 Trombidium, *Acarus*.  
 Trommer's test, *Sugar*, 186, 187.  
 Trona, *Natron, Sodium*, 801.  
 Trophonius, *Oracle*.  
 Tropidonotus, *Snake*.  
 Trostan (mt.), *Antrim*.  
 Troisó, *Cariscrona*.  
 Trozendorf, *Friedland, V.*  
 Troop Head, *Buchan*.  
 Trout, *Salmon of North-west America* (*Supp.*)  
 Trout, salmon, *Salmon*, 445.

INDEX.

- Troutbeck (L), *Windermere*.  
 Trout of Australia and New Zealand, *Salmonida*.  
 Troy (weight), *Octroi*.  
 Truando, *Atrata*.  
 Trubsch (r.), *Saxony*, 513.  
 True Believers, *Sincere Brethren* (Supp.)  
 Trump, game of, *Whist*.  
 Trumpeter, *Agami*.  
 Trumpet-wood, *Cecropia*.  
 Trunk-fish, *Ostracion*.  
 Trush, *Thrush*.  
 Tryphiodorus, *Lipogram*.  
 Tsad (L), *Tchad Lake*.  
 Tsau-hu, *China*, 815.  
 Tschernobolzi, *Rasholmit*.  
 Tshapodshirs, *Tungst*.  
 Tahar-dagh (mts.), *Albania*.  
 Tshousovaia, *Perm*.  
 Tsiangshan, *Ningpo*.  
 Tsike, *Ningpo*.  
 Tai-tai-har, *Manchuria*.  
 Tsua (r.), *Okra*, *Tambov*.  
 Tsomo (r.), *Kai River*, *Tombu*.  
 Tsugar Strait, *Yesso*.  
 Tuatha de Danann, *Firbolge* (Supp.)  
 Tuba, *Society Islands*.  
 Tubbergen, *Oostvreesl*.  
 Tuber, *Truffle*.  
 Tuberathi, *Bevat*.  
 Tubes, *Pipes*.  
 Tubet, *Tibet*.  
 Tube-well, (Supp.)  
 'Tübingen School,' *Bible*, 74.  
 'Tübingen School,' *New Bible*, 75.  
 Tubular bridge, *Britannia Tubular Bridge*, *Strength of Materials*, 103.  
 Tuck, *Casting-net*.  
 Tucker, *Woolen & Worsted Manufactures*, 265.  
 Tucum and tucuma, *Astracarysma*.  
 Tudas, *Nellgherry Mts*, *Tamil*, *Todaro*.  
 Tudela, battle of, *Spain*, 17.  
 Tu-duk, *Cochin-China*.  
 Tufaceous limestone, *Calcareous Tufa*.  
 Tuffstein, *Andernach*.  
 Tufted duck, *Pochard*.  
 Tugela, *Natal*.  
 Tuisco, *Mammae*.  
 Tui-tui, *Honey-eater*.  
 Tulang-Bawaang (r.), *Sumatra*.  
 Tullibardine, *Marquis of Stuart*, *James C. E.*  
 Tulow, *Carleon*.  
 Tulona, *Kala*.  
 Tula or Tuluvu, *Tamil*.  
 Tulukdara, *Onda*.  
 Tumbes, *Guayquil*.  
 Tumble-dung beetle, *Dung Beetle*.  
 Tumbling-net, *Trammel-net*.  
 Tumbrel, *Duching-stool*.  
 Tumbudra, *Dharmar*.  
 Tumen-kiang, *Corna*.  
 Tummel Loch, *Perthshire*.  
 Tummel (r.), *Tay*.  
 Tumour, fibrous, *Womb Diseases*, *Sec. of the*, 251.  
 Tunbridge cakes, *Biscuits*.  
 Tunga, *Bayaca*.  
 Tunga-bhadro, *Kistna*, *Myoree*.  
 Tungani, *Turkistan*, 585.  
 Tung-ting-hu, *China*, 815, *Yang-tai-kiang*.  
 Tuguragua, *Andes*, 240.  
 Tugururt, *Cheamuk*.  
 Tungusic language, *Turanian Languages*.  
 Tunguska (r.), *Yemisi*.  
 Tunic, *Vestiment*.  
 Tunica palmata, *Triumph*.  
 Tunicated, *Bull*.  
 Tankers, (Supp.)  
 Tunstal Court, *Stoke-upon-Trent*.  
 Tunstall, (Supp.)  
 Tuolumne, *Crescent City*.  
 Tuoro, *Trasimene Lacus*.  
 Tupa fulliei, *Lobelia*.  
 Tupquerrez, *New Granada*.  
 Tura, *Perm*.  
 Turan, *Turanian Languages*, *Turkistan*, 583.  
 Turbellaria, *Worms*, 279.  
 Turbinella, *Chanb-shell* (Supp.)  
 Turf, *Peat*.  
 Türfan, *Turkistan*, 585.  
 Turia, *Guadalquivir*.  
 Turk, the, *Bark Beetle*.  
 Turkic language, *Turanian Languages*.  
 Turkish manna, *Sugar*, 187.  
 Turk's cap, *Genet*.  
 Turk's Island, *America*, 205, *Bahamas*.  
 Turma, *Legion*.  
 Turnbull, Dr G. Reid, T.  
 Turner's cerate, *Zinc*, 351.  
 Turning of wine, *Wine*, 223.  
 Turnip butterfly, *Cabbage Butterfly*.  
 Turnip-drill, *Sowing*.  
 Turnip-sawfly, *Sawfly*.  
 Turon, *Quang-Nam* (Supp.)  
 Turoukchau (r.), *Yemisi*.  
 Turpa, *Paints*.  
 Turrit, *Buchan*.  
 Turritites, *Ammonites*.  
 Turri, *Basilicata*.  
 Turtur, *Turtle-dove*.  
 Tusca (r.), *Namidia*.  
 Tuscaloosa, *Alabama*.  
 Tusk, *Tooth*.  
 Tusseh, *Silk & Silkworm*, 724.  
 Tustan, *Hypericaca*.  
 Tutela, *Tudela*.  
 Tutmen, *Mining*.  
 Tvertza (r.), *Caspian Sea*, *Toorr*.  
 Tweeg, *Memopms*.  
 Twelve Pins, the, *Gateway*.  
 Two-twe, *Akyab* (Supp.)  
 Twig-rush, *Cladium*.  
 Twist, *Tabacco*, 465.  
 Twite, *Linnet*.  
 Two hundred and ninety, No. (No. 200), *Alabama* (Supp.)  
 Ty (r.), *Sakkalin*.  
 Ty-cock-tow, *Bocca Tigris*.  
 Tydesley, (Supp.)  
 Tymy (r.), *Sakkalin*.  
 Tyndale, *Reformation*, 159.  
 Tyndall, J. (Supp.)  
 Tyne, *Haddingtonshire*.  
 Type-setting machines, (Supp.)  
 Typha, *Moluccas*.  
 Typhloids, *Serpents*, 626.  
 Typhon, *Oisir*.  
 Typographer beetle, *Bark Beetle*.  
 Tyrannus, *Petchary*, *Tyrant Shrike*.  
 Tyrocnal, *Donegal*.  
 Tyrocnal, Duke and Earl of, (Supp.)  
 Tyrs, *Phanicia*, 401.  
 Tyrian purple, *Purple Colours*.  
 Tyssmanika, *Drochobica*.  
 Tzana (L), *Africa*, 68.  
 Tzua (r.), *Okra*, *Tambov*, *Vissin-Wolitchak*.  
 Ubaye, *Durance*.  
 Ucayali, (Supp.)  
 Uddala, *Sikkim*.  
 Udine (r.), *Genoms* (Supp.)  
 Udo, *Audant*.  
 Ufa (r.), *Zlatoust*.  
 Ugni, *Bugenia*.  
 Uig, *Skye*.  
 Uj-Videl, *Neunata*.  
 Ulceration of anus, *Anus* (Supp.)  
 Ulcer of the stomach, *Stomach*.  
 Ulea (r.), *Uladborg*.  
 Uliasson, *Moluccas*.  
 Ulna, *Hand*, 222.  
 Ulna (r.), *Honduras*.  
 Ulster (r.), *Saxo-Weimar-Eisnack*.  
 Ulva, *Hydrida*.  
 Uman, (Supp.)  
 Umballa, (Supp.)  
 Umbashee (r.), *Kaffraria*, *Proper*.  
 Umbellule, *Umbellifera*.  
 Umbilicus, *Seed*.  
 Umbo, *Bivalve Shells*.  
 Umbrella tree, *Magnolia*.  
 Umbo-Sabelliana, *Rome*, 207, *Sabini*.  
 Umcomanzi (r.), *Natal*.  
 Umes (r.), *Lapland*, *Sweden*, 236.  
 Umgani, *Natal*.  
 Ummerapoora, *Amarapura*.  
 Umoodi, *Natal*.  
 Umrohah, (Supp.)  
 Um Shaumer, *Sinai*.  
 Umata, *Kaffraria*.  
 Umtegela (r.), *Zululand*.  
 Umvolusi (r.), *Zululand*.  
 Umzimulu (r.), *Natal*.  
 Umzimvoobo (r.), *Kaffraria*.  
 Umzimyati (r.), *Zululand*.  
 Unalaska, *Alutian Is.*  
 Unau, *Sloth*.  
 Uncaria, *Crapple-plant* (Supp.)  
 Undercliff, *Wight*, *Isle of*.  
 Underground railway, *U.S.* 658.  
 Undershot wheel, *Water-power*, 95.  
 Underwing moth, *Swallowtail*.  
 Undistributed middle, *Fallacy*.  
 Unguentum cetacei, *Spermoceti*.  
 Unlamesi (L), *Africa*, 68.  
 Unicorn's horn, *Melanthaca*.  
 Unequivalent elements, *Triads*.  
 Unilocular shells, *Univalves*.  
 Unimak (L), *Alutian Is.*  
 Union (r.), *Ellsworth*.  
 Union Party, *Republican*.  
 United Brethren, *Moravians*.  
 United Kingdom Alliance, *Temperance*, 351.  
 United States, (Supp.)  
 United States, education in, *National Education* (Supplement).  
 Universal rose engine, *Machinery-engraving*.  
 Unjon, *Putty-pur*.  
 Unleavened bread, feast of, *Passover*.  
 Unna (r.), *Bosnia*.  
 Unstrut (r.), *Saxo-Coburg-Gotha*.  
 'Unter den Linden,' *Berlin*, 52.  
 Unterinthal, *Tyrol*.  
 Unter See, *Rhine*.  
 Unz (r.), *Zehrisis* (L).  
 Upa (r.), *Toula*.  
 Upa Canal, *Volga*.  
 Upper Peru, *Bolivia*.  
 Upsilonite, *Candia*.  
 Uramel, *Uric Acid*.  
 Urania, *Traveller's Tree*.  
 Uranus, *Planets*.  
 Urate of ammonia, *Lithic Acid Diathesis*.  
 Urbanists, *Clare St.*  
 Urchvy, *Argyleshire*.  
 Ure (r.), *Yorkshire*.  
 Uredo rubigo vera, *Rust*.  
 Urethra, spasm of the, *Retention of Urine*.  
 Urgendji, *Turkistan*, 584.  
 Urganje, *China*.  
 Uthur, *Pigeon Pea*.  
 Uria, *Gullinnet*.  
 Uriconium, (Supp.)  
 Urine, bloody, *Red Water*.  
 Urine, incoherence of, *Retention of Urine*, (Supp.)  
 Urine, retention of, *Retention of Urine*.  
 Urine, suppression of, *Retention of Urine*.  
 Urk, *Netherlands*, *Zuider Zee*.  
 Urilingford, *Kilbenny*.  
 Urmea (L), *Urumsyah* (L).  
 Urquiza, Don J. J., *Rosas*.  
 Uršine opusum, *Dayure*.  
 Uršine seal, *Oleary*.  
 Urumsyah (L), *Urumsyah* (L).  
 Ury, *Don*.  
 Usaguadero (r.), *Nicaragua* L.  
 Usbekistan, *Bokhara*.  
 Usdum, *Dead Sea*.  
 Ushant, battle of, *Home Earl*.  
 Usk (r.), *Brackmoekshire*, *Mommonth*.  
 Uskfidar, *Scutari*.  
 Usquebaugh, *Whisky*.  
 Usel, *Corrize*.  
 Uses (r.), *Savoy*.  
 Ustica, *Lipari*.  
 Utrialov, *Russ. Lang. & Lit.*  
 Usumasinta, *Palengau*.  
 Usuri (r.), *Manchuria*, *Siberia*, 702.  
 Utgarda-Loki, *Loki*.  
 Utica, *Barbary*, 681.  
 Utira or Utilla, *Bay Islands*, *Natal*.  
 Utrecht, Union of, *William*, *Prince of Orange*.  
 Utricularia, *Bladderwort*.  
 Uvaria triloba, *Papua*.  
 Uvula, *Palate*.  
 Vaagen, *Bergen*.  
 Vaagmaer, *Deafish*.  
 Vaagoe, *Farie Isles*.  
 Vacuo, *Screw Pine*.  
 Vacovia, *Albert N'gama* (Supp.)  
 Vacti, *Lates*.  
 Vacuum pan, *Sugar*, 190.  
 Vadutz, *Lichtenstein*.  
 Vahalis (r.), *Waal*.  
 Vaigatch, *Vayguch*.  
 Vaigatz, *Vayguch*.  
 Vaisya, *Caste*, 657.  
 Vala, *Witchcraft*, 233.  
 Valaam, *Ladoga*.  
 Val d'Arán, *Pyrenees*.  
 Val del Bove, *Etna*.  
 Valdenses, *Waldenses*.  
 Valdes, *Spanish Lang. & Lit.* 20.  
 Valdivia, *Chil*.  
 Valencia, (Supp.)  
 Valentia, *Britannia*, 353.  
 Valentin, *Anatomy*, 227.  
 Valerien, *Mont*, *Sime*.  
 Valesquez, *Diego*, *Cortis*, *Hernan*.  
 Valguarnera, (Supp.)  
 Valis (r.), *Waal*.  
 Valladolid, *Morilla* (Supp.)  
 Valladolid la Nueva, *Cornaguas* (Supp.)  
 Vallejo, *California*.  
 Valls, (Supp.)  
 Valognes, *Manche*.  
 Valparaiso corn, *Maize*.  
 Valtelline, *Alps*.  
 Valvassor, *Valvassor*.  
 Vamospircs, *Haiducks* (Supp.)  
 Vancouver, *Washington* (Ser.)  
 Vancouver I. Herring, *Herring*, *Vancouver I.* (Supp.)  
 Van den Bosch, *Cape*, *Papua*, 250.  
 Vanderhelst, *Painting*, 104.  
 Vandyke (in dress), *Fashion*, 254.  
 Vanessa, *Switz*.  
 Vanishing fractions, *Fractions*, *Vanishing*.  
 Vanishing point, *Perspective*, 430.  
 Vannucci, *Pietro*, *Perugia*.  
 Vanoma, *Rosa*, *Alexander* 77, *Pope*.  
 Van Swieten, *Medicine Hist. of Vanua Levu*, *Fiji Islands*.  
 Vaqueros, *Asturias*.  
 Vax (r.), *Alpes Maritimes* (Supp.)  
 Varan, *Monditor*.  
 Vardar (r.), *Turkey*, 586.  
 Vardhamana, *Mahavara*.  
 Varenne, *Mayenne*.  
 Vargas, Don Juan de, *Alba*.  
 Variable cod, *Dorse*.  
 Variolaria, *Archel*.  
 Varied monkey, *Ceropithacus*.  
 Variegated laurel, *Azuba*.  
 Variou-Bo, *Noori-Bo* (Supp.)  
 Varsel, *Versal*.  
 Vasa lactea, *Digestion*, 566.  
 Vascular plants, *Spiral Vessels*.  
 Vascular tumescence, *Contraction of Blood*.  
 Vassili I. II. III, *Russia*, 587.  
 Vassili Shostakiv, *Russia*, 586.  
 Vassy, *Moravia*, *Haute*.  
 Vataui, *Batavia*.  
 Vataui, John, *Bysantine Empire*, 472.

Vaunks (*r.*), *Cape River*.  
 Vecht, *Oostvysel, Rhine*.  
 Vechte (*r.*), *Hanover*.  
 Veddah, *Ceylon, 728*.  
 Ved-el-Kebr (*r.*), *Amis*.  
 Ved-el-Melamah (*r.*), *Tunis*.  
 Vedius Pollio, *Slaavery*.  
 Veenhuizen, *Peupler Colonies*.  
 Veere, *Campvere*.  
 Vega, *Alonsovar del Campo (Supp.)*.  
 Vegetable brimstone, *Lycoptodiacum*.  
 Vegetable butter, *Avocado Pear*.  
 Vegetable jelly, *Gelatin*.  
 Vegetable leather, *Leather cloth (Supp.)*.  
 Vegetables for food, *Food (Supp.)*.  
 Vegetable milk, *Pulu, Silk-cotton*.  
 Vegeto-alkalies, *Alkalimeter*.  
 Veglia, *Austria*.  
 'Veiled Prophet,' *Mohammedan Sock (Supp.)*.  
 Vein, contraction of, *Hydrodynamics, 484*.  
 Veit Stoes, *Carving*.  
 Velebich (*mts.*), *Dalmatia*.  
 Veleia and Veleiatas, *Vellria*.  
 Veleikaia, *Prilpa*.  
 Veleita (*mts.*), *Sierra Nevada*.  
 Velhas, Rio das, *Sao Francisco*.  
 Velikaia, *Pskov*.  
 Velino (*mts.*), *Apenines*.  
 Vellnore, *Pondicherry*.  
 Vellore, (*Supp.*)  
 Velvet leaf, *Cissampelos*.  
 Vena contracta, *Hydrodynamics, 484*.  
 Venae cavae, &c. *Circulation*.  
 Vendidad, *Zend, 347, and Zend-Avesta*.  
 Venedi, *Sarmatians*.  
 Venefica, *Witchcraft, 233*.  
 Venephes, *Egypt, 788*.  
 Venerable, *Reverend*.  
 Veneti, *Venice, 757*.  
 Venetia, *Germany (Supp.), 536, Italy (Supp.)*.  
 Venetian-point, *Lace*.  
 Venice talc, *Steatite*.  
 Venice turpentine, *Pine*.  
 Venice white, *Baryta*.  
 Vennachar (*L.*), *Katrina (L.)*.  
 Ventadour, Bernard de, *Troubadour*.  
 Ventilator, Archimedian screw, *Blowing-machines (Supp.), 430*.  
 Ventnor, temperature of, *Great Britain, 65*.  
 Ventoux, Mont, *Vauchuse*.  
 Ventricles, *Brain, 303, Circulation, 45*.  
 Ventriculus succenturiatus, *Birds, 209*.  
 Ventuare, *Orinoco*.  
 Venus, *Planets*.  
 'Venus of Quinipily,' *Baud (Supp.)*.  
 Venus's comb, *Cherzil*.  
 Venus's comb, *Murex*.  
 Venus's hair-stone, *Rock-crystal*.  
 Venus's pencils, *Rock-crystal*.  
 Venus's slipper, *Carinaria*.  
 Veprip undulata, *Xanthoxy-lum*.  
 Ver (*r.*), *Albans, St*.  
 Veratric acid, *Sabadilla*.  
 Verbas, *Bornia*.  
 Verberna triphylla, *Aloysis*.  
 Vercingetorix, *Alesia, Caesar*.  
 Verdandi, *Norne*.  
 Verde, Cape, *Africa, 66*.  
 Verde di Corsica duro, *Dial-lage*.  
 Verden, (*Supp.*)  
 Verdon, *Durance*.  
 Vere, *Campvere*.  
 Verkholensk, *Irkutsk*.  
 Vermandois, *Valois*.  
 Vermes, *Worms, 278*.  
 Vermillion Pass, *Sasatchowan*.  
 Vermillion (*r.*), *Ohio*.  
 Verneuil, E. de, *Russia, 382*.  
 Vernon, Admiral, *Puerto Bello*.  
 Verrocchio, *Sculpture, 577*.  
 Veronica Giuliani, *Stigmatis-ation*.  
 Verplancks Point, *Stony Point*.  
 Verres, *Sicily, 706*.  
 Verrières, *Seine*.  
 Verucum, *Warts*.  
 Verte, *New Brunswick*.  
 Vertical, *Vegetable Physi-ology, 725*.  
 Verticillium, *Leaves*.  
 Verulam, *Albans, St*.  
 Vervick, (*Supp.*)  
 Vespa and Vespidum, *Wasp*.  
 Vespertilio, *Noctule (Supp.)*.  
 Vestibule, *Ear, 720*.  
 Vestini, *Civita di Penna*.  
 Veto law, *Free Church of Scotland*.  
 Vexillum, *Papilionaceae*.  
 Vexin, Counts of, *Standard*.  
 Vezere, *Dordogne*.  
 Vezzola (*r.*), *Teramo*.  
 Via Emilia, *Reggio*.  
 Via Appia, *African Way*.  
 Via Dolorosa, *Jerusalem*.  
 Viaud, *Satire*.  
 Vicary, Thos., *Anatomy, 209*.  
 Viechada, *Orinoco*.  
 Victor Harbour, *S. Australia*.  
 Victoria, *New Zealand*.  
 Victoria, *Seychelles Islands*.  
 Victoria (*r.*), *S. Australia*.  
 Victoria cross, *War Services, (Supp.)*.  
 Victoria Falls, *Zambesi*.  
 Victoria Land, *Antarctic Ocean*.  
 Victualling bill, *Bill of Vic-tualling*.  
 Vidal, Peire, *Troubadour*.  
 Vidöe, *Eider*.  
 Vidua, *Whydow Bird*.  
 Vienna Mountains, *Altoia*.  
 Vienna (treaty), *Germany (Supp.), 536*.  
 Vienna white, *Chalk*.  
 Vienne (*r.*), *Charente, Loire*.  
 Vieque, *Virgin Islands*.  
 Vierländer, *Bergedorf (Supp.)*.  
 Viersen, (*Supp.*)  
 Vierzon-Ville, (*Supp.*)  
 Vigita Magna, *Zambesi*.  
 Vigo Bay, *Spain, 13*.  
 Vignors, *Ornithology*.  
 Vile and Ve, *Odin*.  
 Villa (*r.*), *Niemen, Vilno*.  
 Villach, *Alps*.  
 Villa del Fuerte, *Fuerte (Supp.)*.  
 Village-system, *India, 539*.  
 Villalobos, *Spanish Lang. & Lit. 20*.  
 Villani, Giovanni, *Italy, 657*.  
 Villars, *Succession Wars, 178*.  
 Villa Rufini, *Columbarium*.  
 Villa Viciosa, battle of, *Ven-dome*.  
 Villenage service, *Tenure of Land*.  
 Villeroi, Marshal, *Ramillies*.  
 Villiers, Buckingham, Duke of.  
 Vilui, *Lena*.  
 Vimieira, battle of, *Wellington*.  
 Vidinal Hill, *Rome, 322*.  
 Vinaroz, (*Supp.*)  
 Vincent of Beauvais, *Encyclo-pædia, 47*.  
 Vin cotti, *Wine, 221*.  
 Vin de paille, *Wine, 221*.  
 Vinodbona, *Vienna*.  
 Vine gall, *Coccus*.  
 Vinegar, wood, *Pyroligneous Acid*.  
 Vingoria, *Concan*.  
 Vin sec, *Wine, 221*.  
 Vintschgau, *Tyrol*.  
 Violet moss, *Violet Stones*.  
 Violone, *Dye-stuffs*.  
 Violone, *Contra Bass*.  
 Viper's grass, *Scorzonera*.  
 Vique, *Vick*.  
 Virgilius, *Ireland, 606*.  
 Virgin-Gorda, *Virgin Is.*.  
 Virginia City, *Nevada*.  
 Virginian deer, *Cariacou*.  
 Virginian silk, *Aclepias*.  
 Virginian snakeroot, *Aristo-lechia*.  
 Virginian stock, *Stock*.  
 Virginius Rufus, *T. Rome, 300*.  
 Virgin's milk, *Benouin*.  
 Viroma, *Ethiopia*.  
 Virtue, *Stoics*.  
 Virtues, *Cardinal Virtues*.  
 Visa, *Passport*.  
 Viscaya, *Biscay*.  
 Vischer, *Engraving, 69*.  
 Vishni-Volotchek Canal, *Volga*.  
 Vishnugunga (*r.*), *Rhadri-nath*.  
 Vismia, *Hypericaceae, Wax-trees*.  
 Vison, *Minh (Supp.)*.  
 Visparad, *Zend, 341, and Zend-Avesta, 343*.  
 Visurgis, *Weser*.  
 Vital capacity, *Respiration, 211*.  
 Vitalian, Anastasius I. (*em-peror*).  
 Vitava, *Moldau*.  
 Vitellus, *Development of the Embryo*.  
 Viti Islands, *Fiji Islands*.  
 Viti Levu, *Fiji Islands*.  
 Vitium (*r.*), *Lena*.  
 Vitius, *Vine, 798*.  
 Vitreous humour, *Eye, 204*.  
 Vivace, *Tempo*.  
 Vivandier, *Sutler*.  
 Viviparous fish, (*Supp.*)  
 Vivis, *Vrooy*.  
 Vizezy, *Montbrison (Supp.)*.  
 Viziadroog, *Concan*.  
 Vizer, *Visor*.  
 Vladika, *Montenegro*.  
 Vladimir, Prince George of, *Russia, 384*.  
 Vlieland, *Holland, North, Netherlands*.  
 Voandzou, *Gobbe*.  
 Vogelberg (*mt.*), *Rhine*.  
 Vogelweide, Walther von der, *Walther v. d. Vogelweide*.  
 Vohlgemuth, *Engraving, 69*.  
 Voice, *Registers of Voice*.  
 Voigtland, *Germany, 737, Saxony, 514*.  
 Voirlch, Ben, *Dumbarton-shire*.  
 Vojussa (*r.*), *Albania*.  
 Volatile alkali, *Ammonia*.  
 Volcano (*z.*), *Boracic Acid*.  
 Volkenrode, *Saxe-Coburg-Gotha*.  
 Volkhof (*r.*), *Ilmen*.  
 Volkhov, *Volchov*.  
 Volme (*r.*), *Ludenscheid (Supp.)*.  
 Volsinii, *Rome, 313*.  
 Volta (*r.*), *Ashanti, Dahomey*.  
 Voltmeter, *Galvanism, 602*.  
 Volterra, *Alabaster*.  
 Volterra, Daniele da, *Paint-ing, 193*.  
 Volturnum, *Capua*.  
 Völundur and Völundur-quida, *Scandinavian Lang. & Lit. 523*.  
 Voluntary controversy, *U.P. Church, 646, Voluntaryism*.  
 Voluntary education, *National Education (Supp.)*.  
 Vomiting of blood, *Stomach, Holland, South*.  
 Voragine, James de, *Golden Legend*.  
 Vorarlberg, *Rhine, Tyrol*.  
 Vorhate Island, *Timor-laut*.  
 Vormen, *Glommen*.  
 Vörsamard, *Petofi (Supp.)*.  
 Vorsova (*r.*), *Theiss*.  
 Vostermann, *Engraving, 69*.  
 Voters, registration of, *Par-liament, 284*.  
 Vou-Chang, (*Supp.*)  
 Vouet, Simon, *Painting, 195*.  
 Vouga (*r.*), *Aveiro (Supp.)*.  
 Vyaeg, *Comora, Danube*.  
 Wackta des Indes, *Wihama*.  
 Wachita (*r.*), *Hot Springs*.  
 Wachtlieder, *Minnesinger*.  
 Wackneroder, *Romantic School*.  
 Wadt, *Faud*.  
 Wady Kawas, *Bilma*.  
 Wady Magara, *Egypt, 789*.  
 Waeu, Pays de, *St Nicholas*.  
 Waga, *Druina*.  
 Wager, *Gull*.  
 Wager-boat, *Boating*.  
 Wager of battle, *Battel*.  
 Wagon, the, *Uras Major*.  
 Wah, *Panda*.  
 Wahatch (*mts.*), *Utah*.  
 Waiau (*r.*), *New Zealand*.  
 Waigats, *Veygack*.  
 Wai-ini (*r.*), *Guiana, Brit. 139*.  
 Waikato (*r.*), *New Zealand*.  
 Wain Ganga (*r.*), *Nagpur*.  
 Waitaki, *Otago*.  
 Wakatip, *Otago*.  
 Wakefield, battle of, *York-shire*.  
 Wakefield theory of colonisa-tion, *South Australia*.  
 Wake Robin, *Arum*.  
 Walderbenkopf, *Prussia*.  
 Waldheimia, *Ternstralia*.  
 Waldo, Peter, *Waldenses*.  
 Waldseemüller, Martin, *Ame-ricu Vesputci*.  
 Waldshut, *Anabaptists, 218*.  
 Walet, *Biru*.  
 Walfish Bay, *Namagualand*.  
 Walid, *Ommiades, 71*.  
 Wallis, *Spain, 16, Turkey, 587*.  
 Walker, *Engraving, 68*.  
 Walkham, *Dartmoor*.  
 Walkill (*r.*), *Hudson*.  
 Wallaroo, *South Australia*.  
 Wallawalla, *Washington (ter.)*.  
 Wallflower cabbage, *Brassica*.  
 Wallia, *Spain, 16*.  
 Wallis, *Valais*.  
 Wall-rue, *Asplenium*.  
 Walls, retaining, *Retaining Walls*.  
 Wall's Cut, *Tybes*.  
 Wallsend, *Supp.*.  
 Walney Island, *Barrow (Supp.)*.  
 Walsh Mts, *Kilkenny*.  
 Walter, John, *Times, The*.  
 Wamba, *Spain, 16*.  
 Wambeys, *Gambeson*.  
 Wanpæe, *Aurantiaceae*.  
 Wangarua, *N. Zealand*.  
 Wan-li-chang, *China, 815*.  
 Wanlockhead, *Dumfriesshire*.  
 Wanny, *Ceylon, 737*.  
 Wantsome, *Thames*.  
 Wantung, *Ecoca Tigris*.  
 Waranger Fiord, *Scandinavia*.  
 Warble, *Bot*.  
 Warburg's fever drops, *Guiana Bark*.  
 Ward, *Guardian*.  
 Warehouses, floating, *Floating Warehouses (Supp.)*.  
 Wargöe, *Sveoborg*.  
 Warm plaster, *Rufefaciens*.  
 Warmemünde, *Rostock*.  
 Warneria, *Hydrastis (Supp.)*.  
 Warnow (*r.*), *Rostock*.  
 Warping, *Köpe & Köpe-making*.  
 Warree, *Benis*.  
 Warren, *Rhode Island*.  
 Warren, Hen. (*Supp.*)

Warrior, &c. targets, *Armour-plates* (Suppl.), 400.  
 War-services, (Suppl.)  
 Wart Hill, *Hex.*  
 Warud, *Arru Is.*  
 Wasgau, *Voges Mountains.*  
 Wash, *Distillation.*  
 Washington (mt.), *Appalachians*, 351, *White Mts.*  
 Washingtonia, *Wellingtonia.*  
 Waste-book, *Book-keeping*, 228.  
 Wastrel lands, *Stannaries.*  
 Waste Water, *Windermerv.*  
 Water, *Sanitary Science* (Suppl.), 777.  
 Water, hardness in, *Water-supply.*  
 Water, resistance of, *Hydrodynamics*, 484.  
 Water avens, *Genem.*  
 Water-beetles, *Gyrinus.*  
 Water-boatman, *Boat-fly.*  
 Water cancer or canker, *Cancer oris* (Suppl.)  
 Water-cure, *Hydropathy.*  
 Water-flannel, *Conferova.*  
 Water-fowl, *Wild-fowl.*  
 Water-hemlock, *Water Drop-wort.*  
 Water-hog, *Capybara.*  
 Water hog-house, *Asellus.*  
 Water-horse, *Capybara.*  
 Waterladders, *Anabaptists*, 519.  
 Water-mole, *Duck-bill.*  
 Water-moss, *Fossilialis.*  
 Water of crystallisation, *Salts.*  
 Water-pepper, *Polygonum.*  
 Water-plantain, *Alismaceae.*  
 Water-rat, *Vole.*  
 Water-scorpion, *Water-bug.*  
 Water-snail, *Pulmonata.*  
 Water-soldier, *Stratiotes.*  
 Waterways, *Shipbuilding*, 684.  
 Water-withe, *Vine*, 799.  
 Water-yam, *Lattice Leaf.*  
 Watling Street, (Suppl.)  
 Watson, Sheriff, *Ragged Schools.*  
 Watt, *Engraving*, 70.  
 Wattled and combed, *Barbed & Crested.*  
 Wattled turkey, *Talagalla.*  
 Wattles, *Fowl.*  
 Watts, Thomas, (Suppl.)  
 Watt's Dyke, *Off's Dyke* (Suppl.)  
 Waukesha, *Wisconsin.*  
 Waveney (r.), *Suffolk.*  
 Waverley novels, *Scott, Sir Walter.*  
 Wax-cluster, *Gaultheria.*  
 Wax-flower, *Cistia.*  
 Wax-moth, *Honeycomb Moth.*  
 Wax-shrub, *Candleberry.*  
 Way (i.), *Moluccas.*  
 Waybread, *Plantaginaceae.*  
 Wayfaring tree, *Viburnum.*  
 Wayland Smith's Cave, *Crom-leck.*  
 Waynesborough, *Virginia.*  
 Ways, *Lanark.*  
 Weak-fish, *Otolithus* (Suppl.)  
 Weak, *Saxons.*  
 Wear, *Wear* (Suppl.)  
 Wearmouth Monastery, *Benedict Biscop* (Suppl.)  
 Weary-all Hill, *Glastonbury.*  
 Weasel-mout, *Dead Nettle.*  
 Weathercote Cavern, *Yorkshire.*  
 Weaver (r.), *Cheshire.*  
 Weaver's shuttle shell, *Cowry.*  
 Weaving, (Suppl.)  
 Webbe Shebell (r.), *Somali Land.*  
 Weber, *Telegraph*, 339.  
 Weber, E. H., *Anatomy*, 227.  
 Weden, *Shamley.*  
 Wedge-shaped, *Cuneiform.*  
 Wedgwood, Th., *Photography*, 508.  
 Wed Mzi, *Sakara.*  
 Weems, *Earth-houses.*  
 Weems, *Ring Money.*  
 Weerselo, *Overysel.*  
 Weichsel (r.), *Vistula.*  
 Weights, French, *Chemistry* (Suppl.)  
 Weil (r.), *Nassau.*  
 Weir, (Suppl.)  
 Weir's Cave, *Virginia.*  
 Weisshaupt, Adam, *Illuminati.*  
 Weisshaupt, *Vesprim.*  
 Welcomb, *Cornwall.*  
 Weldon, *Ranook.*  
 Welland, *Lincolnshire, Wash.*  
 Wellaleys (is.), *Carpentaria.*  
 Wellington, (Suppl.)  
 Wellington (i.), *Patagonia.*  
 Wellington Strait, *Baffin's B.*  
 Well of the Sun, *Ammonium.*  
 Wells, *Water-supply*, 104.  
 Wemyss Family, *Elcho* (Suppl.)  
 Wen (r.), *Yang-tse-kiang.*  
 Wendover, *Chiltern Hills.*  
 Wente, *Dem.*  
 Wentlogg, *Monmouth.*  
 Werden, *Essex.*  
 Werra, *Hesse-Cassel, Weser.*  
 Werra, *Verrit.*  
 Wervick, *Vervick* (Suppl.)  
 Weseritz (r.), *Joachimsthal* (Suppl.)  
 Wessnitz (r.), *Saxony*, 513.  
 West Branch (r.), *Susquehanna.*  
 Westera, *Macler Lake.*  
 Westerland, *Berzelius.*  
 Western (r.), *Si-kiang.*  
 Western cure, *Venomous Bites & Stings*, 757.  
 Westerschelling, *Terschelling.*  
 Westerswald, *Nassau, Prussia.*  
 Rhenish Prussia.  
 West France, *Neustria.*  
 Westminster Assembly, *Assembly of Divines.*  
 Westre Bygd, *Greenland.*  
 West Road (r.), *Fraser River.*  
 West Vaagen, *Lofoden.*  
 Westwood, *Queensland.*  
 Wet-rot, *Potato.*  
 Weiter (r.), *Hesse-Darmstadt.*  
 Wetumpla, *Alabama.*  
 Wey (r.), *Survey.*  
 Weyhill, *Andover.*  
 Whale Island, *Baffin's Bay.*  
 Whalley, *Lancashire.*  
 Wharfe (r.), *Yorkshire.*  
 Wharcliffe, Lords, *Stewart Family*, 124.  
 Wharton Society, *Roxburghe Club.*  
 Whaup, *Curlew.*  
 Wheat aphid, *Corn Aphid.*  
 Wheat grass, *Couch Grass.*  
 Wheelock (r.), *Sandbach.*  
 Wheel of life, *Zoetrope* (Suppl.)  
 Whelk, anatomy of, *Gastropoda.*  
 Whelk, red, *Fusus.*  
 Whernside, *Yorkshire.*  
 Wherry, *Boating.*  
 Whettle, *Woodpecker.*  
 Whet-stones, *Homes.*  
 Where duck and whewer, *Widgown.*  
 Whey-cure, *Sugar*, 187.  
 Whidaw, *Wydaw.*  
 Whiddy (i.), *Bantry Bay, Cork.*  
 Whigs, *Republican, U.S.* 657, 658.  
 Whiskers (of cats and rodents), *Touck.*  
 Whitadder, *Bermekshire.*  
 White (r.), *Niger.*  
 White (r.), *Wabash.*  
 White alkali, *Soda*, 800.  
 White ant, *Termite.*  
 White balsam of Peru, *Liquid-amber.*  
 White Bay, *Magnolia.*  
 White-bellies, *Shan States.*  
 Whitechurch, *Waterford.*  
 White cinnamon, *Canella.*  
 White copper, *Tombac.*  
 White eyelid monkey, *Cercopithecus.*  
 White Horse Hill, *Berkshire.*  
 White Horse Peak, *Chiltern Hills.*  
 White Inlet, *Newfoundland.*  
 White iron, *Cast Iron.*  
 Whitelaw's mill, *Barber's Mill.*  
 White mangrove, *Avicennia.*  
 White rainbow, *Anthalia.*  
 White rocket, *Dam's Violet.*  
 White-rot bark, *Canella.*  
 White-rot, *Hydrocotyle.*  
 White Russia, *Lithuania, Mohilev.*  
 White salts, *Rectifying.*  
 White sassafras, *Magnolia.*  
 White Swedish moss, *Cudbear.*  
 White-thorn, *Hawthorn.*  
 White Top (mt.), *Virginia.*  
 White whale, *Beluga, Dolphin.*  
 White Woman (mt.), *Mexico.*  
 Whiting put, *Bik.*  
 Whiting, *Bull Trout, Salmon*, 449.  
 Whittington, (Suppl.)  
 Whitworth, Mr. and Whitworth rifle, *Rifled Arms.*  
 Whorled, *Leaves.*  
 Whorl grass, *Catabrosa.*  
 Whytt, *Medicine, Hist. of.*  
 Wichita, Big and Little (r.), *Red River.*  
 Wickets, *Cricket.*  
 Widow bird, *Wydow Bird.*  
 Wierps (r.), *Vistula.*  
 Wierden, *Overysel.*  
 Wieringen, *Holland, North, Zuider Zee.*  
 Wiesee (r.), *Rhine.*  
 Wiessen (r.), *Black Forest.*  
 Wiggon, *Widgown.*  
 Wijayo, *Ceylon*, 740.  
 Wijk, *Maastricht.*  
 Wilberforce, *Hawkesbury.*  
 Wilbrod, St., *Willibrod, St.*  
 Wild ananas, *Bromeliaceae.*  
 Wild apricot, *Mammes Apple.*  
 Wild-cherry bark, *Choke-cherry.*  
 Wild cinnamon, *Canella, Myrcia.*  
 Wild clove, *Myrcia.*  
 Wild dog, *Lycan.*  
 Wildenovia teres, *Restiaceae.*  
 Wilderness, battle of the, *Rapahannock, U.S.* 661.  
 Wilde-Weisseritz (r.), *Saxony*, 513.  
 Wild ipecacuanha, *Asclepias.*  
 Wild lemon, *Podophyllum.*  
 Wild liquorice, *Astragalus.*  
 Wild olive, *Elaeagnus.*  
 Wildsee, *Baden.*  
 Wild spinnage, *Chenopodium.*  
 Wilhelmstadt, battle of, *Seven Years War*, 637.  
 Willibald Alexis, *Having, W.*  
 Wilk, *Ferrissakle, Whelk.*  
 Wilkinson, Sir J. G. (Suppl.)  
 Willamette, *Oregon.*  
 Willé, *Engraving*, 69.  
 Willemsoord, *Drenth.*  
 Willey, *Shoddy, Spinning*, 46.  
 William, Mount, *Graham's Land.*  
 William, Mount, *Grampians, Australian.*  
 Williams, Edward, *Welsh Lang. & Lit.* 137.  
 Williams, Moses, *Welsh Lang. & Lit.* 137.  
 Williams, Mr., *Vitrified Forts.*  
 Williams, Rev. Isaac, *Tractarianism.*  
 Willie's Rooms, *Almack's.*  
 Will-o'-the-wisp, *Ignis Fatuus.*  
 Willow, *Spinning*, 46.  
 Willow-grouse, *Pitarigan.*  
 Willow-herb, *Epilobium.*  
 Willowing-machine, *Cotton*, 275.  
 Willow-leaves, *Sun.*  
 Wills, W. J., *Australian Explorations* (Suppl.), 410.  
 Will's Neck, *Somersetshire.*  
 Willughbeia, *Apocynaceae.*  
 Wilson, Robert, *Steam-hammer, Steam-navigation, etc.*  
 Wilson's Promontory, *Victoria*, 745.  
 Wily (r.), *Wilm, Wilkin.*  
 Wimpfen, battle of, *Tilly.*  
 Windemere, *Windermerv.*  
 Wincey, *Wissay.*  
 Winchester, *Genl.* U.S. 661.  
 Windhover, *Katrol.*  
 Windlestrae, *Hair Gru.*  
 Windpipe, *Respiration, ad.*  
 Windrush (r.), *Thames.*  
 Windsor, *Hambroey, Vermont.*  
 Windward (is.), *Antilla.*  
 Wind of iron, *Tartaria Acid*, 304.  
 Winfried, *Beiface.*  
 Wing-coverts, *Birds*, 108.  
 Winged pea, *Bird's-foot Trefoil.*  
 Wing-feathers, *Birds*, 108.  
 Winkedried, *Arnold von Senack.*  
 Winona, *Minnesota.*  
 Winosooki, Falls of the, *Vermont.*  
 Winslow, *Capt. Alabama* (Suppl.), 380.  
 Winster, *Lancashire.*  
 Winter, *Season.*  
 Wintera, *Winter's Bark.*  
 Winter acorn, *Hollow.*  
 Winter cherry, *Physalis.*  
 Wirksworth, *Derbyshire.*  
 Wural, *Cheshire.*  
 Wisdom, *Book of, Apocryph.*  
 Wisdom of Jesus, *son of Sack, Ecclesiasticum.*  
 Wisdom tooth, *Teeth*, 39.  
 Wise woman, *Witchcraft*, 133.  
 Wisla (r.), *Vistula.*  
 Witchegda (r.), *Poland.*  
 Witches' butter, *Tremula.*  
 Witches' meat, *Tremula.*  
 Witches' sabbath, *Witchcraft*, 234.  
 Witch-finders, *Witchcraft*, 133.  
 Witch-meal, *Lycopodiaceae.*  
 Witebak, *Lithuania.*  
 Witham (r.), *Lincolnshire, Wash.*  
 Withra, *Roderic.*  
 Witnessing part of deed, *To Letum.*  
 Wittstock, battle of, *Thirty Years War.*  
 Wizin, *Russian Lang. & Lit.*  
 Woaded colours, *Woolen & Worsted Manufacture.*  
 Wodlo, *Onaga.*  
 Woel, *Gabra.*  
 Woinak, battle of, *Nick* (Suppl.)  
 Wolchof, *Naggorod.*  
 Wold, *Dye-stuff*, 721.  
 Wolds, *Lincolnshire, Yorkshire.*  
 Wolf (r.), *Wisconsin.*  
 Wolf, Dr., *Babbara.*  
 Wolf-holes, *Truss-di-Int.*  
 Wolkehof (r.), *Ladoga.*  
 Wolfen (i.), *Uerdon, Oder.*  
 Wolman, *Melchior, Bea.*  
 Wolstan, *Wulstan.*  
 Women's rights, (Suppl.)  
 Wonder, *Emotion.*  
 Wongsly, *Dye-stuff.*  
 Woo (r.), *Yang-tse-kiang.*  
 Woo - Chang, *Yoo-Chang* (Suppl.)  
 Woodall, *Woodpecker.*  
 Wood coal, *Brown Coal.*  
 Woodcock shell, *Murex.*  
 Wood duck, *Summer Duck.*  
 Wood-evil, *Contagiation.*  
 Woodfall, W., *Reforming, Parliamentary.*  
 Woodford (r.), *Cocoa, Firmamagh.*  
 Wood grouse, *Capercaillie.*

**strumens.**  
 Wood oil, *Gurgina Balsam, Dipteracea.*  
 Wood pie, *Woodpecker.*  
 Wood-rush, *Lusula (Supp.)*  
 Wood sage, *Germander.*  
 Wood-shock, *Pekah.*  
 Wood-sorrel, *Oxalis.*  
 Wood-spirit, *Pyroxylic Spirit.*  
 Woodspite, *Woodpecker.*  
 Wood vinegar, *Pyrolygneous Acid.*  
 Wood wren, *Warbler.*  
 Woody nightshade, *Bittersweet.*  
 Wool, *Wool.*  
 Wool-bearing antelope, *Goat, Rocky Mountain.*  
 Wool-combing machines, *Woolen & Worsted Manufacturers, 267.*  
 Wool, *Wool.*  
 Woolhope limestone, *Silurian Rocks.*  
 Woolmer Forest, *Hampshire.*  
 Wool mosaic, *Mosaic Wool (Supp.)*  
 Woolton, *Much Woolton (Supp.)*  
 Wool-tree, *Eriodendron.*  
 Wool-pet-zee, *Galls.*  
 Woolly, *wooraa, Curari.*  
 Worcester, *Marquis of, Revozier, Steam-engine, 99.*  
 Work, *Thermo-dynamics (Supp.)*  
 Workshop Regulation Act, *(Supp.)*  
 Workshop, *(Supp.)*  
 Worm, *Still.*  
 Wormal, *Bot.*  
 Worm bark, *Andira.*  
 Wormen (r.), *Norway, 799.*  
 Wormian bones, *Skull, 759.*  
 Wormseed, *Artemisia, Chenopodium, Erysimum.*  
 Wormser Joch, *Alps.*  
 Wormitz (r.), *Bavaria, 760.*  
 Woronzoff, *Prince, Shamyk.*  
 Wort, *Distillation.*  
 Wörthsee, *Klagenfurt.*  
 Wotawa (r.), *Moldau.*  
 Wounds, dissection, *Dissection Wounds (Supp.)*  
 Woundwort, *Stachys.*  
 Wow-wow, *Gibbon.*  
 Wray, *John, Ray.*  
 Wroxeter, *Utriconium (Supp.)*  
 Wry-neck, *Stiff-neck.*  
 Wuchang, *Hupsh.*  
 Wudwan, *(Supp.)*  
 Wunsentake (mt.), *Japan, 683.*  
 Wurm (r.), *Bavaria, 760.*  
 Würtemberg, *Germany (Supp.), 535.*  
 Wutach (r.), *Rhine.*  
 Wyk, *Fohr.*  
 Wynne, *Ellis, Welsh Lang. & Lit., 137.*  
 Xarayes, *Paraguay (r.)*  
 Xativa, *Jattova.*  
 Xerophthalmia, *Lachrymal Organs.*  
 Xieng-Mai, *Shan States.*  
 Ximena, *Ximena (Supp.)*  
 Xingo (r.), *Amazon.*  
 Xiphias, *Sword-fish.*  
 Xyloidin, *Starck.*  
 Xylophilii, *Scarabaeida.*  
 Y, *the, Amsterdam.*  
 Yablounoi (mts.), *Siberia, 702.*  
 Yacaré, *Alligator.*  
 Yacca, *Timber.*  
 Yacou, *Guan.*  
 Yafa, *Joppa.*  
 Yaffle, *Woodpecker.*  
 Yagachi (r.), *Bellur (Supp.)*  
 Yaguaron (r.), *Uruguay.*  
 Yajur-veda, *Veda, 724.*  
 Yakkhos, *Ceylon, 738.*  
 Yakoutak, *Jakutsk.*  
 Yakova, *Yacova (Supp.)*  
 Yakuts, *Siberia, 703.*  
 Yallobusha (r.), *Yazoo.*  
 Ya-loong (r.), *Yang-tse-kiang.*  
 Yalu-kiang, *Corea.*  
 Yanacota, *Andes, 238.*  
 Yanukovs, *battle of, Torsten-sohn, Thirty Years War.*  
 Yanon, *India, French.*  
 Yanteles (mt.), *Andes, 239, 240.*  
 Yapura (r.), *Amazon.*  
 Yaqui (r.), *Sonora.*  
 Yarmouth, *Wight, Isle of.*  
 Yarn, *Turkish, or Camel, Angora.*  
 Yarn-roll, *Loom.*  
 Yarr, *Spurway.*  
 Yarra-Yarra (r.), *Victoria, 785.*  
 Yarriba, *Yoruba (Supp.)*  
 Yaruba, *Queensland.*  
 Yashis, *Zend, 341.*  
 Yasna or Yasna, *Zend, 341.*  
 Zend-Avesta, *343.*  
 Yava, *Ava.*  
 Yavari (r.), *Amazon.*  
 Yawry Bay, *Sierra Leona.*  
 Yé (r.), *Tennessee.*  
 Yeandon, *(Supp.)*  
 Yealm, *Dartmoor.*  
 Yelk, *Vitellus Ovi.*  
 Yellow bird's nest, *Monotropeacea.*  
 Yellow-copper, *Pyrites.*  
 Yellow fever, mild, *Relapsing Fever.*  
 Yellow rattle, *Rhinanthus.*  
 Yellow River, *Leitrim.*  
 Yellow River, *Penacola.*  
 Yellow rocket, *Cress.*  
 Yellowroot, *Hydrastis (Supp.)*  
 Yellow showers, *Pyrotechny.*  
 Yellow stars, *Pyrotechny.*  
 Yellow weed, *Weed.*  
 Yellow wood, *Fustic.*  
 Yembo, *Yambu.*  
 Yenikuing, *Pella.*  
 Yemischur, *Larissa.*  
 Yeou (r.), *Bornu.*  
 Yerba de maté, *Matl.*  
 Yerkiang, *Yarkand.*  
 Yesli-irmak, *Anatolia, 220.*  
 Yes Tor, *Dartmoor.*  
 Yeou (r.), *Birnie.*  
 Yeou, *Isle d', France, 470.*  
 Yezid, *Omniades, 71.*  
 Yguasou (r.), *Parana.*  
 Ying-Tze, *New-Chwang (Supp.)*  
 Yird-houses, *Earth-houses.*  
 Yite, *Yellow-hammer.*  
 Ymir, *Giants & Dwarfs, 741, Nifheim.*  
 Yo (r.), *Bornu.*  
 Yo-Hamite, *Yo-Semite (Supp.)*  
 Yoldrin, *Yellow-hammer.*  
 Yolk, *Blackings, 149.*  
 Yolk, *Development of the Embryo.*  
 Yoni, *Linga.*  
 York, *Archb. of, Archbishop.*  
 York Factory, *Hudson's Bay.*  
 Yorkists, *Edward IV.*  
 Yoruba, *(Supp.)*  
 Yo-Semite, *(Supp.)*  
 Young, *James, Skale.*  
 Young alligator, *Menopome.*  
 Young Breslau, *Inowracław.*  
 Young fustic, *Sumach.*  
 Youze, *Chaetah.*  
 Ypao (L.), *Paraguay, 257.*  
 Yren, *Cardigan Bay.*  
 Yrfon (r.), *Brecknockshire.*  
 Ysselmonde, *Holland, South.*  
 Ysengeaux, *Loire, Haute.*  
 Yswith, *Cardiganshire.*  
 Ythan, *Aberdeenshire.*  
 Ytterby, *Erbium.*  
 Yternaes, *Aland Islands.*  
 Ytrotantalite, *Yttrium.*  
 Yu, *Yade.*  
 Yucca, *Manioc.*  
 Yucca gloriosa, *Razor-strop.*  
 Yulan, *Magnolia.*  
 Yule-month, *December.*  
 Yungu, *Juan Fernandez.*  
 Yun-nan, *China, 817.*  
 Yunx, *Wryneck.*  
 Yussuf-ben-Taxfin, *Almoravides (Supp.)*  
 Zaatcha, *Algeria, 142.*  
 Zab (r.), *Great and Little, Tigris.*  
 Zab-Ála (r.), *Kurdistan.*  
 Zab-Asfal (r.), *Kurdistan.*  
 Zachun, *Amyridacea, Hajilij.*  
 Zacynthus, *Zante.*  
 Zadikim, *Chasidim.*  
 Zagarello, *Bitonto.*  
 Zagora, *Pelion.*  
 Zaires, *Cruives.*  
 Zamboango, *Philippine Is.*  
 Zamboni's dry pile, *Galvanism, 598.*  
 Zancudoes, *Mosquito.*  
 Zanthoxylum octandra, *Tacamahac.*  
 Zaondzi, *Mayotta (Supp.)*  
 Zapatero, *Nicaragua (L.)*  
 Zapolya, *Transylvania.*  
 Zar-afshan (r.), *Bokhara.*  
 Zarius, *Buraria.*  
 Zaro, *Dalmatia.*  
 Zarskoo-Selo, *(Supp.)*  
 Zator, *Gallia, Austrian.*  
 Zealots, *Pharisees.*  
 Zebra of the plains, *Dawo.*  
 Zebra wood, *Connaracea.*  
 Zebu, *Philippine Is.*  
 Zebub, *Zimb.*  
 Zecchino, *Sequin.*  
 Zealand streams, *Scheldt.*  
 Zegerin (r.), *Guerara.*  
 Zeldae, *Scomberida.*  
 Zeni, *Algeria, 138.*  
 Zeirides, *Roger II.*  
 Zela, *Zillah.*  
 Zell, *Celli.*  
 Zeller, *Baur.*  
 Zeminogorski, *Altai Mts. (Supp.)*  
 Zemni, *Molo-rat.*  
 Zenzem, *Haji, Mohammed-anim.*  
 Zenghi (r.), *Aras.*  
 Zenker, *Pychna.*  
 Zeno, *Byzantine Empire, 470.*  
 Zephyrinus, *Humanitarians.*  
 Zerda, *Fennec.*  
 Zerduht, *Zoroaster, 359.*  
 Zermagna (r.), *Austria, 568, Dalmatia.*  
 Zerumbet, *Ginger.*  
 Zetland, *Shetland.*  
 Zengutania, *Barbary.*  
 Zezere (r.), *Tagus.*  
 Zighit (r.), *Guerara.*  
 Zincali, *Gypties, 170.*  
 Zio or Ziu, *Tyr.*  
 Zirmie (r.), *Sokoto.*  
 Zizania, *Rice.*  
 Zizka, *Ziska.*  
 Zjeta, *Montenegro.*  
 Zmief, *Zmeiugorsk.*  
 Znaim or Znaum, *(Supp.)*  
 Zoca, *Crustaceans, Larva.*  
 Zoetrope, *(Supp.)*  
 Zohak, *Bamian.*  
 Zohak, *Diamond (Supp.)*  
 Zomba (mt.), *Shirwa.*  
 Zoom, *Bergon-of-Zoom.*  
 Zone, *Cestus.*  
 Zootids, *Tapeworm, 290.*  
 Zootomy, *Anatomy, 227.*  
 Zorn (r.), *Zabern.*  
 Zoutpansberg, *Transvaal Republic.*  
 Zschopau (r.), *Frankenberg.*  
 Zugspitz, *Bavaria.*  
 Zula, *Boynca.*  
 Zulla, *Adul.*  
 Züllichau, *battle of, Seven Years War, 677.*  
 Zurbaran, *Francisco, Painting, 104.*  
 Zurita, *Geronimo, Spanish Lang. & Lit. 20.*  
 Zusha (r.), *Mtsensk.*  
 Zwart-bast, *Ebenacea.*  
 Zwarte Water, *Zwolle.*  
 Zwollerkerspel, *Overyssel.*

THE END.



63





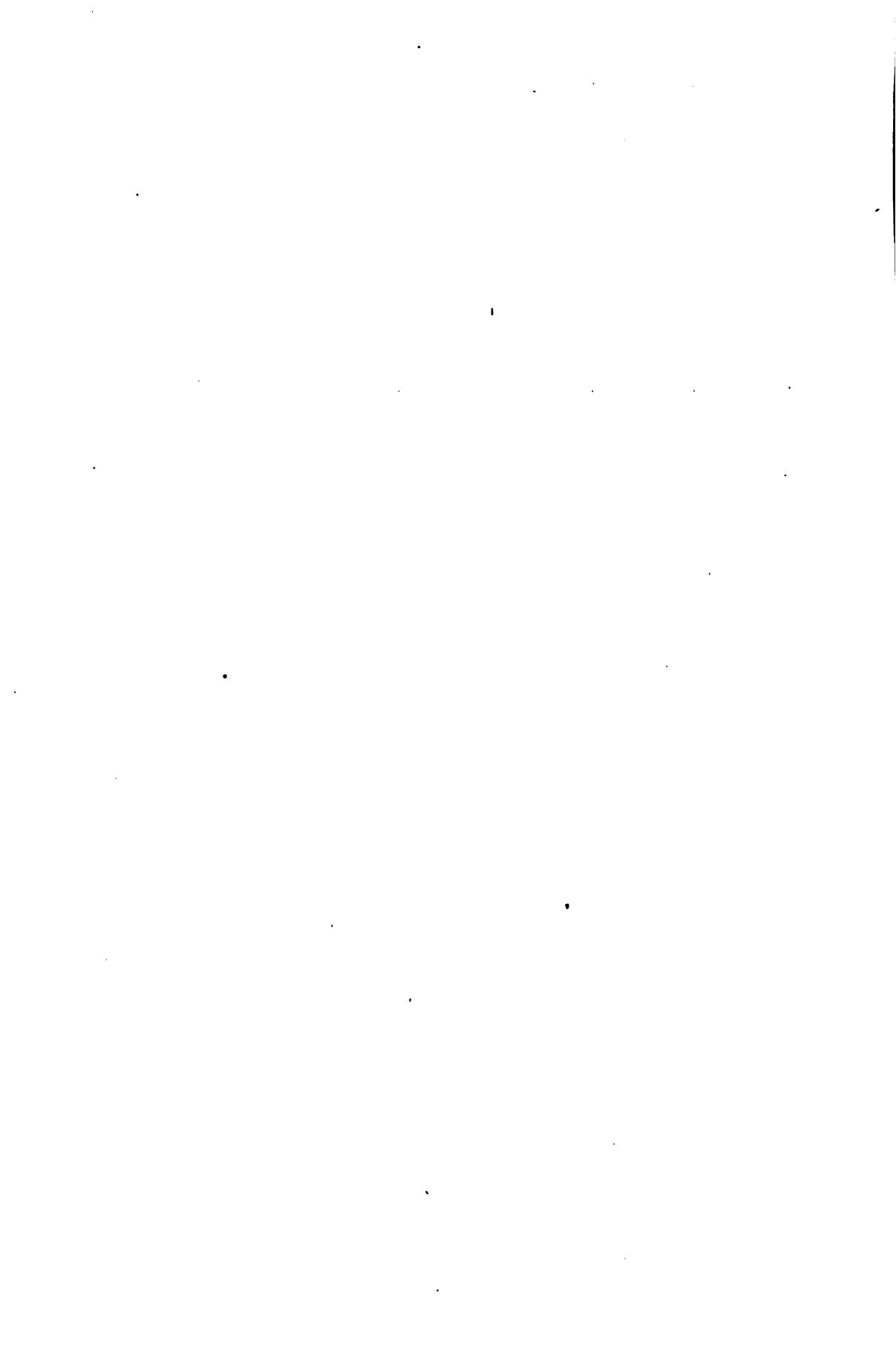

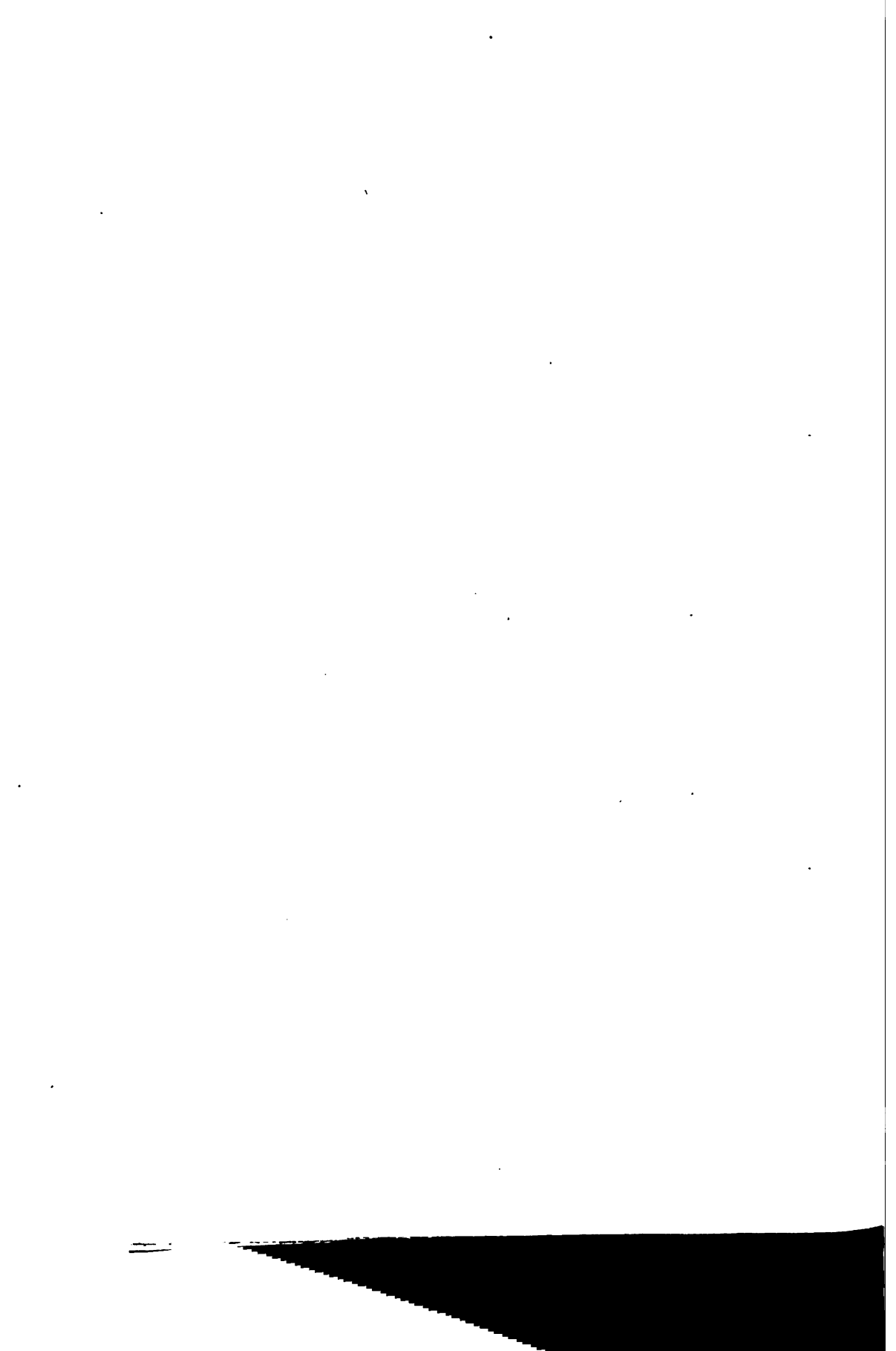

stamped below.

A fine of five cents a day is incurred by retaining it beyond the specified time.

Please return promptly.



